

FCC RADIO TEST REPORT

FCC ID: 2AMN5-83045

Product: Wireless Dimmer

Trade Name: N/A

Model Name: 83045

Serial Model: 89090, 89091, 89092, 89093

Report No.: UNIA20031006FR-01

Prepared for

MARKLYN GROUP INC

190 Bovaird Dr. West, Unit 28 Brampton, Ontario, Canada L7A 1A2

Prepared by

Shenzhen United Testing Technology Co., Ltd.

2F, Annex Bldg, Jiahuangyuan Tech Park, #365 Baotian 1 Rd, Tiegang
Community, Xixiang Str, Bao'an District, Shenzhen, China

TEST RESULT CERTIFICATION

Applicant's name..... : MARKLYN GROUP INC
Address..... : 190 Bovaird Dr. West, Unit 28 Brampton, Ontario,
Canada L7A 1A2
Manufacture's Name..... : MARKLYN GROUP INC
Address..... : 190 Bovaird Dr. West, Unit 28 Brampton, Ontario,
Canada L7A 1A2

Product description

Product name..... : Wireless Dimmer
Trade Mark..... : N/A
Model and/or type reference . : 83045, 89090, 89091, 89092, 89093

Standards..... : FCC Part 15 Subpart C 15.231
ANSI C63.10: 2013

This device described above has been tested by Shenzhen United Testing Technology Co., Ltd., and the test results show that the equipment under test (EUT) is in compliance with the FCC requirements. And it is applicable only to the tested sample identified in the report.

This report shall not be reproduced except in full, without the written approval of UNI, this document may be altered or revised by Shenzhen United Testing Technology Co., Ltd., personnel only, and shall be noted in the revision of the document.

Date of Test..... : Mar. 4, 2020
Date (s) of performance of tests..... : Mar. 04 ~ 25, 2020
Date of Issue..... : Mar. 26, 2020
Test Result..... : Pass

Prepared by:

Kahn yang/Editor

Reviewer:

Sherwin Qia / Supervisor

Approved & Authorized Signer:

Liuze/Manager

Table of Contents

1	TEST SUMMARY.....	4
2	GENERAL INFORMATION.....	5
2.1	ENVIRONMENTAL CONDITIONS.....	5
2.2	GENERAL DESCRIPTION OF EUT.....	5
2.3	CARRIER FREQUENCY OF CHANNELS.....	5
2.4	OPARATION OF EUT DURING TESTING.....	6
2.5	DESCRIPTION OF TEST SETUP.....	6
2.6	MEASUREMENT INSTRUMENTS LIST.....	7
3	TEST CONDITIONS AND RESULTS.....	8
3.1	CONDUCTED EMISSIONS TEST.....	8
3.2	RADIATED EMISSION TEST.....	9
3.3	-20db OCCUPIED BANDWIDTH.....	15
3.4	Deactivation Time.....	16
3.5	CALCULATION OF AVERAGE FACTOR.....	17
3.6	ANTENNA REQUIREMENT.....	18
4	PHOTOGRAPH OF TEST.....	19

1 TEST SUMMARY

TEST PROCEDURES AND RESULTS

FCC and IC Requirements		
FCC Part 15.207	Conducted Emission	N/A
FCC Part 15.231(a)(2)	Automatically Deactivate	PASS
FCC Part 15.231(b)	Electric Field Strength of Fundamental Emission	PASS
FCC Part 15.205 & 15.209 & 15.231(b)	Electric Field Strength of Spurious Emission	PASS
FCC Part 15.231(c)	-20dB bandwidth	PASS

TEST FACILITY

Test Firm : Shenzhen United Testing Technology Co., Ltd.
 Address : 2F, Annex Bldg, Jiahuangyuan Tech Park, #365 Baotian 1 Rd, Tiegang Community, Xixiang Str, Bao'an District, Shenzhen, China

The testing quality ability of our laboratory meet with "Quality Law of People's Republic of China" Clause 19. The testing quality system of our laboratory meets with ISO/IEC-17025 requirements, which is approved by CNAS. This approval result is accepted by MRA of APLAC.

Our test facility is recognized, certified, or accredited by the following organizations:

CNAS-LAB Code: L6494

The EMC Laboratory has been assessed and in compliance with CNAS-CL01 accreditation criteria for testing Laboratories (identical to ISO/IEC 17025:2017 General Requirements) for the Competence of testing Laboratories.

Designation Number: CN1227

Test Firm Registration Number: 674885

The EMC Laboratory has been registered and fully described in a report filed with the (FCC) Federal Communications commission. The acceptance letter from the FCC is maintained in our files.

MEASUREMENT UNCERTAINTY

Measurement Uncertainty

Conducted Emission Expanded Uncertainty	=	2.23dB, k=2
Radiated emission expanded uncertainty(9kHz-30MHz)	=	3.08dB, k=2
Radiated emission expanded uncertainty(30MHz-1000MHz)	=	4.42dB, k=2
Radiated emission expanded uncertainty(Above 1GHz)	=	4.06dB, k=2

2 GENERAL INFORMATION

2.1 ENVIRONMENTAL CONDITIONS

During the measurement the environmental conditions were within the listed ranges:

Temperature	Normal Temperature:	26°C
Voltage	Normal Voltage	1.5V
Other	Relative Humidity	55 %
	Air Pressure	101 kPa

2.2 GENERAL DESCRIPTION OF EUT

Equipment	Wireless Dimmer
Trade Mark	N/A
Model Name	83045
Serial No.	89090, 89091, 89092, 89093
Model Difference	All models have same circuits diagram, PCB Layout, construction and rated power, only different is the model name.
FCC ID	2AMN5-83045
Antenna Type	PCB Antenna
Antenna Gain	10dBi
Frequency Range	433.92MHz
Number of Channels	1
Modulation Type	ASK
Battery	DC 3V Button Battery

2.3 CARRIER FREQUENCY OF CHANNELS

Channel	Frequency (MHz)
1	434.92

2.4 OPERATION OF EUT DURING TESTING

Operating Mode

The mode is used: Transmitting mode

Transmission operation mode

When you press any Button, the EUT can achieve a transmission.

2.5 DESCRIPTION OF TEST SETUP

Operation of EUT during Conducted testing: N/A

Note : This device is pure battery powered and does not require charging

Operation of EUT during Radiation and Above1GHz Radiation testing:

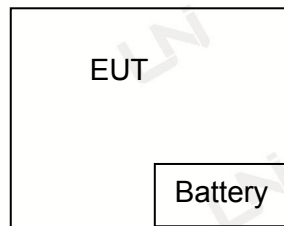

2.6 MEASUREMENT INSTRUMENTS LIST

Item	Equipment	Manufacturer	Model No.	Serial No.	Calibrated until
CONDUCTED EMISSIONS TEST					
1	AMN	Schwarzbeck	NNLK8121	8121370	2020.9.6
2	AMN	ETS	3810/2	00020199	2020.9.6
3	EMI TEST RECEIVER	Rohde&Schwarz	ESCI	101210	2020.9.6
4	AAN	TESEQ	T8-Cat6	38888	2020.9.6
RADIATED EMISSION TEST					
1	Horn Antenna	Sunol	DRH-118	A101415	2020.9.6
2	BicoNLog Antenna	Sunol	JB1 Antenna	A090215	2020.9.6
3	PREAMP	HP	8449B	3008A00160	2020.9.6
4	PREAMP	HP	8447D	2944A07999	2020.9.6
5	EMI TEST RECEIVER	Rohde&Schwarz	ESR3	101891	2020.9.6
6	VECTOR Signal Generator	Rohde&Schwarz	SMU200A	101521	2020.9.6
7	Signal Generator	Agilent	E4421B	MY4335105	2020.9.6
8	MXA Signal Analyzer	Agilent	N9020A	MY50510140	2020.9.6
9	MXA Signal Analyzer	Agilent	N9020A	MY51110104	2020.9.6
10	ANT Tower&Turn table Controller	Champro	EM 1000	60764	2020.9.6
11	Anechoic Chamber	Taihe Maorui	9m*6m*6m	966A0001	2020.9.6
12	Shielding Room	Taihe Maorui	6.4m*4m*3m	643A0001	2020.9.6
13	RF Power sensor	DARE	RPR3006W	15I00041SNO88	2020.9.6
14	RF Power sensor	DARE	RPR3006W	15I00041SNO89	2020.9.6
15	RF power divider	Anritsu	K241B	992289	2020.9.6
16	Wideband radio communication tester	Rohde&Schwarz	CMW500	154987	2020.9.6
17	Biconical antenna	Schwarzbeck	VHA 9103	91032360	2020.9.6
18	Biconical antenna	Schwarzbeck	VHA 9103	91032361	2020.9.6
19	Broadband Hybrid Antennas	Schwarzbeck	VULB9163	VULB9163#958	2020.9.6
20	Horn Antenna	Schwarzbeck	BBHA9120D	9120D-1680	2020.9.6
21	Active Receive Loop Antenna	Schwarzbeck	FMZB 1919B	00023	2020.9.6
22	Horn Antenna	Schwarzbeck	BBHA 9170	BBHA9170651	2020.9.6
23	Microwave Broadband Preamplifier	Schwarzbeck	BBV 9721	100472	2020.9.6
24	Active Loop Antenna	Com-Power	AL-130R	10160009	2020.9.6
25	Power Meter	KEYSIGHT	N1911A	MY50520168	2020.9.6
Test software					
1	E3	Audix	6.101223a	N/A	N/A

3 TEST CONDITIONS AND RESULTS

3.1 CONDUCTED EMISSIONS TEST

Limit

For unintentional device, according to § 15.107(a) Line Conducted Emission Limits is as following

Frequency range (MHz)	Limit (dBuV)	
	Quasi-peak	Average
0.15-0.5	66 to 56*	56 to 46*
0.5-5	56	46
5-30	60	50

* Decreasing linearly with the logarithm of the frequency

For intentional device, according to §15.207(a) Line Conducted Emission Limit is same as above table.

Test Setup

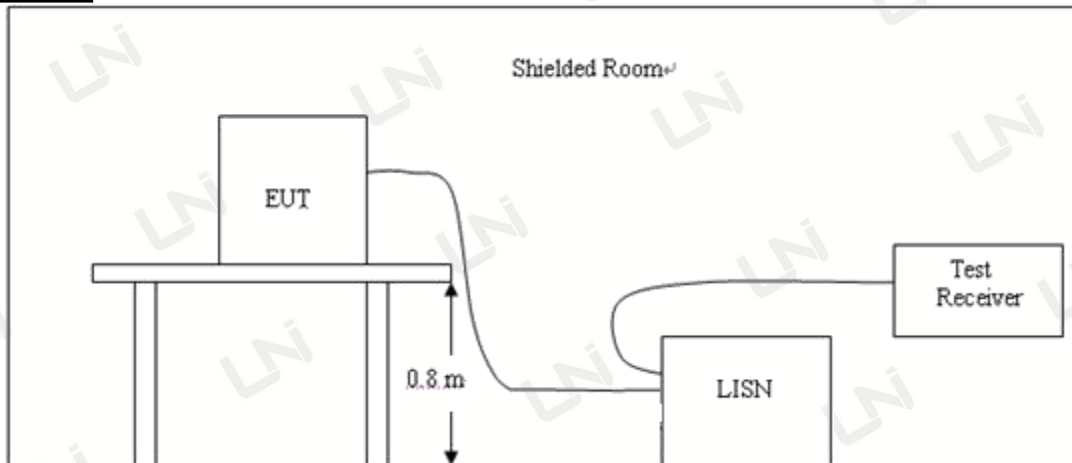

Test Procedure

- 1, The equipment was set up as per the test configuration to simulate typical actual usage per the user's manual. A wooden table with a height of 0.8 meters is used and is placed on the ground plane as per ANSI C63.10.
- 2, Support equipment, if needed, was placed as per ANSI C63.10.
- 3, All I/O cables were positioned to simulate typical actual usage as per ANSI C63.10.
- 4, If a EUT received DC power from the USB Port of Notebook PC, the PC's adapter received AC120V/60Hz power through a Line Impedance Stabilization Network (LISN) which supplied power source and was grounded to the ground plane.
- 5, All support equipments received AC power from a second LISN, if any.
- 6, The EUT test program was started. Emissions were measured on each current carrying line of the EUT using a spectrum Analyzer / Receiver connected to the LISN powering the EUT. The LISN has two monitoring points: Line 1 (Hot Side) and Line 2 (Neutral Side). Two scans were taken: one with Line 1 connected to Analyzer / Receiver and Line 2 connected to a 50 ohm load; the second scan had Line 1 connected to a 50 ohm load and Line 2 connected to the Analyzer / Receiver.
- 7, Analyzer / Receiver scanned from 150 KHz to 30MHz for emissions in each of the test modes.

Test Result

This device is pure battery powered and does not require charging.

3.2 RADIATED EMISSION TEST

Radiation Limit

For unintentional device, according to § 15.109(a), except for Class A digital devices, the field strength of radiated emissions from unintentional radiators at a distance of 3 meters shall not exceed the following values:

Frequency (MHz)	Distance (Meters)	Radiated (dBµV/m)	Radiated (µV/m)
30-88	3	40	100
88-216	3	43.5	150
216-960	3	46	200
Above 960	3	54	500

For intentional device, according to § 15.209(a), the general requirement of field strength of radiated emissions from intentional radiators at a distance of 3 meters shall not exceed the above table.

In addition to the provisions of 15.231(b) and RSS 210-A1.1.2, the field strength of emissions from intentional radiators operated under this section shall not exceed the following:

Funda-mental fre-quency (MHz)	Field strength of funda-mental (microvolts/ meter)	Field strength of spurious emissions (microvolts/meter)
40.66–40.70.	2,250	225
70–130	1,250	125
130–174	¹ 1,250 to 3,750	¹ 125 to 375
174–260	3,750	375
260–470	¹ 3,750 to 12,500	¹ 375 to 1,250
Above 470	12,500	1,250

¹ Linear interpolations.

[Where F is the frequency in MHz, the formulas for calculating the maximum permitted fundamental field strengths are as follows: for the band 260-470 MHz, µV/m at 3 meters = 41.6667(F) - 7083.3333. The maximum permitted unwanted emission level is 20 dB below the maximum permitted fundamental level.]

Test Setup

1. Radiated Emission Test-Up Frequency Below 30MHz

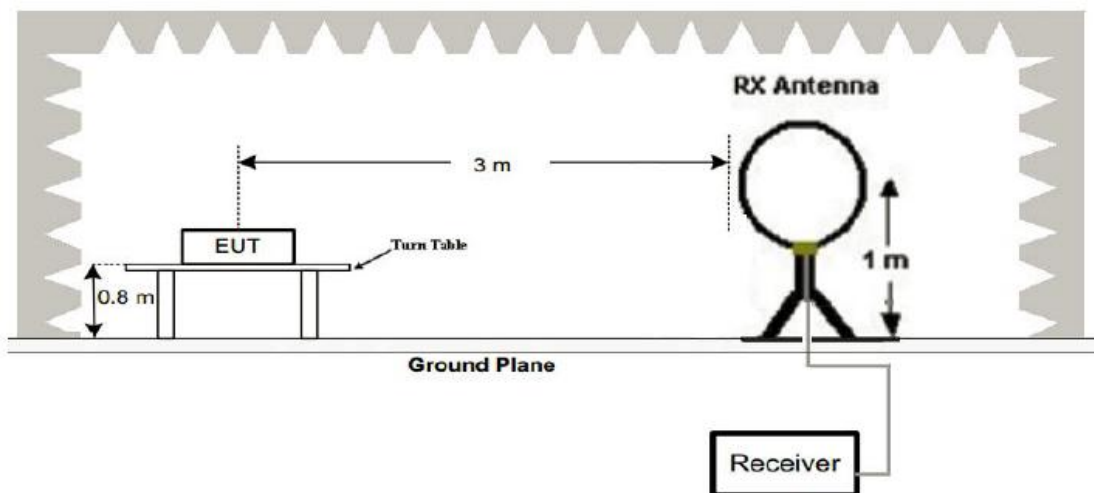

2. Radiated Emission Test-Up Frequency 30MHz~1GHz

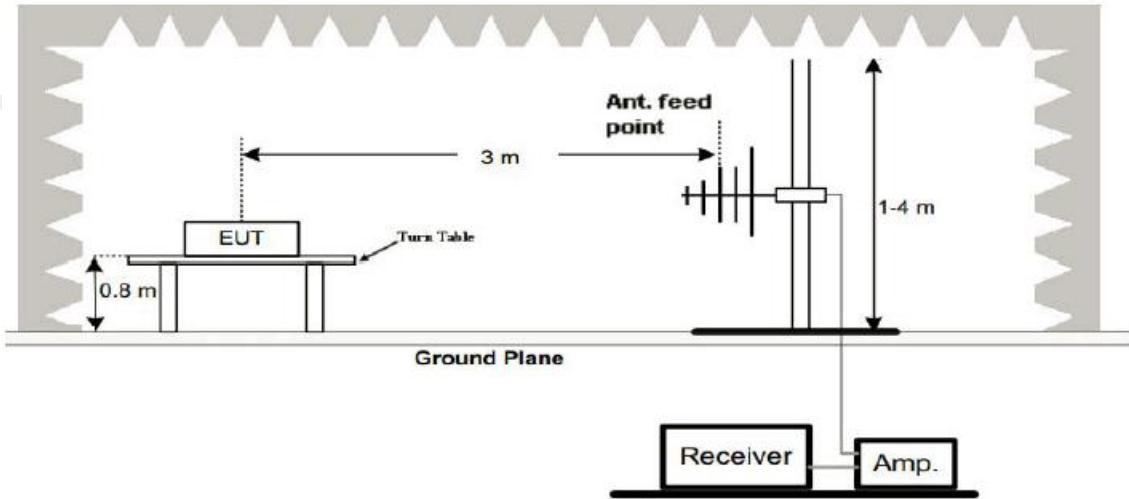

3. Radiated Emission Test-Up Frequency Above 1GHz

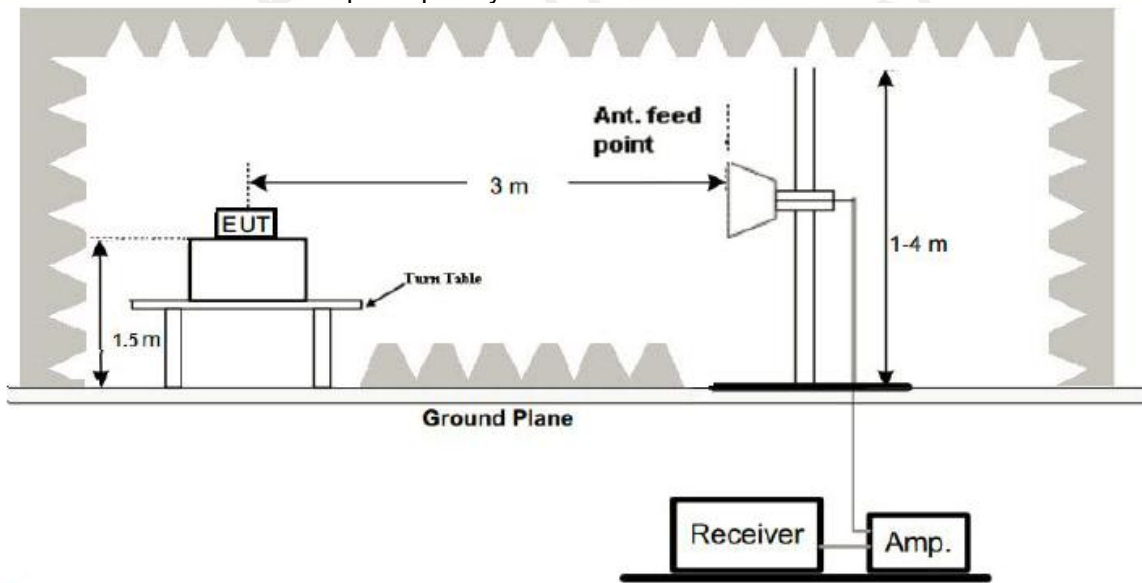

Test Procedure

1. Below 1GHz measurement the EUT is placed on turntable which is 0.8m above ground plane. And above 1GHz measurement EUT was placed on low permittivity and low tangent turn table which is 1.5m above ground plane.
2. The turntable shall be rotated for 360 degrees to determine the position of maximum emission level.
3. EUT is set 3m away from the receiving antenna, which is varied from 1m to 4m to find out the highest emissions.
4. Maximum procedure was performed on the six highest emissions to ensure EUT compliance.
5. And also, each emission was to be maximized by changing the polarization of receiving antenna both horizontal and vertical.
6. Repeat above procedures until the measurements for all frequencies are complete.
7. The test frequency range from 9kHz to 25GHz per FCC PART 15.33(a).

Note:

For battery operated equipment, the equipment tests shall be performed using a new battery.

Test Result

---PASS---

Remark:

1. All the test modes completed for test. The worst case of Radiated Emission is Middle channel, the test data of this mode was reported.
2. By preliminary testing and verifying three axis (X, Y and Z) position of EUT transmitted status, it was found that "Z axis" position was the worst, and test data recorded in this report.
3. Radiated emission test from 9KHz to 10th harmonic of fundamental was verified, and no emission found except system noise floor in 9KHz to 30MHz and not recorded in this report.

Below 1GHz Test Results:

Temperature:	24°C	Relative Humidity:	49%
Test Date:	Mar. 23, 2020	Pressure:	1010hPa
Test Voltage:	DC 3V	Polarization:	Horizontal
Test Mode:	TX Mode		

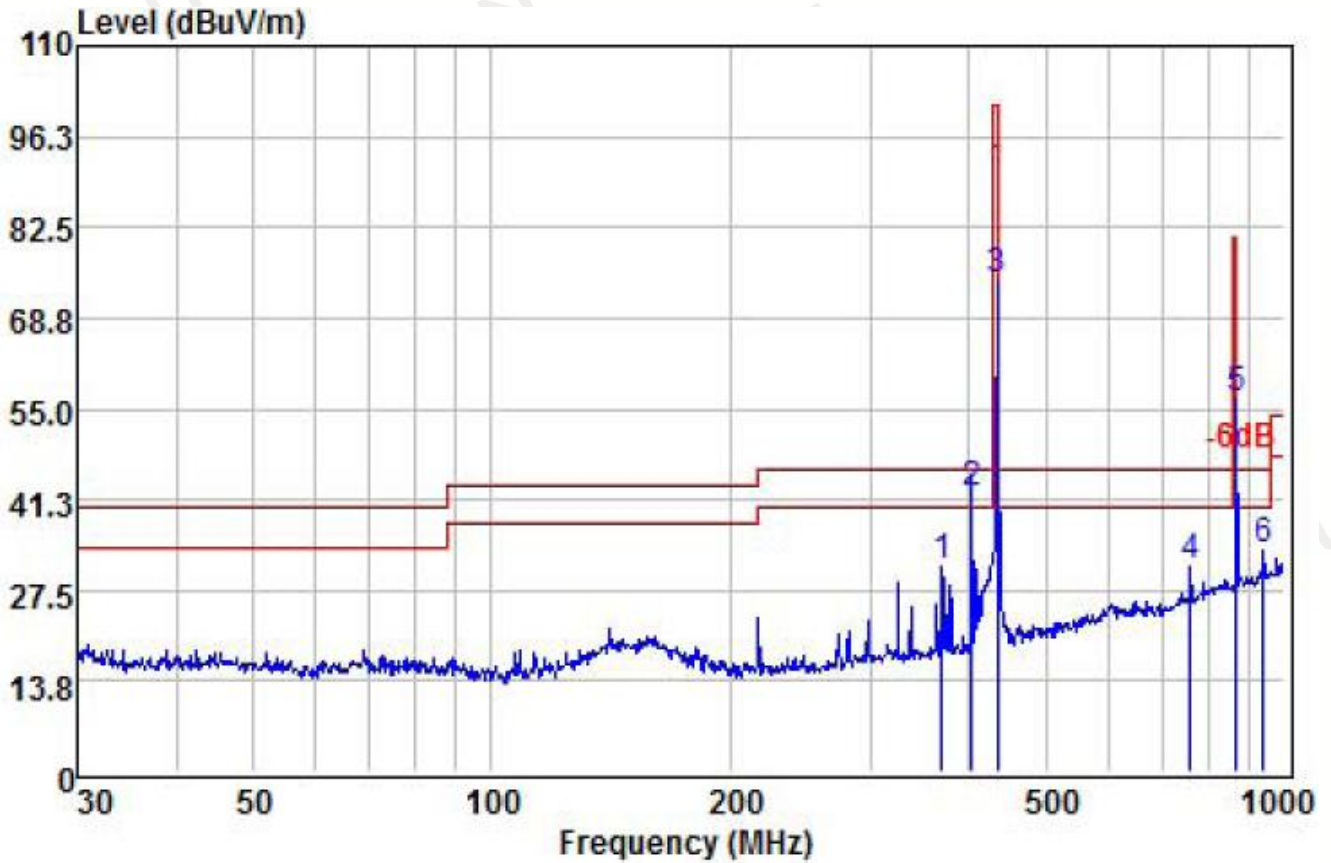

	Read	Antenna	Cable	Limit	Over			
Freq	Level	Factor	Loss	Line	Limit	Remark		
MHz	dBuV	dB/m	dB	dBuV/m	dBuV/m	dB		
1	369.40	16.20	13.91	0.83	30.94	46.00	-15.06	QP
2	403.25	26.86	14.36	0.91	42.13	46.00	-3.87	QP
3	434.07	58.51	15.03	1.00	74.54	100.80	-26.26	Peak
4	760.70	9.50	20.32	1.33	31.15	46.00	-14.85	QP
5	868.80	32.84	22.12	1.57	56.53	80.80	-24.27	Peak
6	942.13	8.58	23.19	1.65	33.42	46.00	-12.58	QP

For average:

Frequency MHz	Peak Level dBuV/m	Duty cycle factor	Average Level dBuV/m	Limit	Margin dB
434.07	74.54	-6.09	68.45	80.80	-12.35
868.80	56.53	-6.09	50.44	60.80	-10.36

- Notes: 1. Average emission Level = Peak Level + Duty cycle factor
- 2. Duty cycle level please see clause 3.5.
- 3. We pretest all two keys, only worst case is presented in the report.

Temperature:	24°C	Relative Humidity:	49%
Test Date:	Mar. 23, 2020	Pressure:	1010hPa
Test Voltage:	DC 3V	Polarization:	Vertical
Test Mode:	TX Mode		

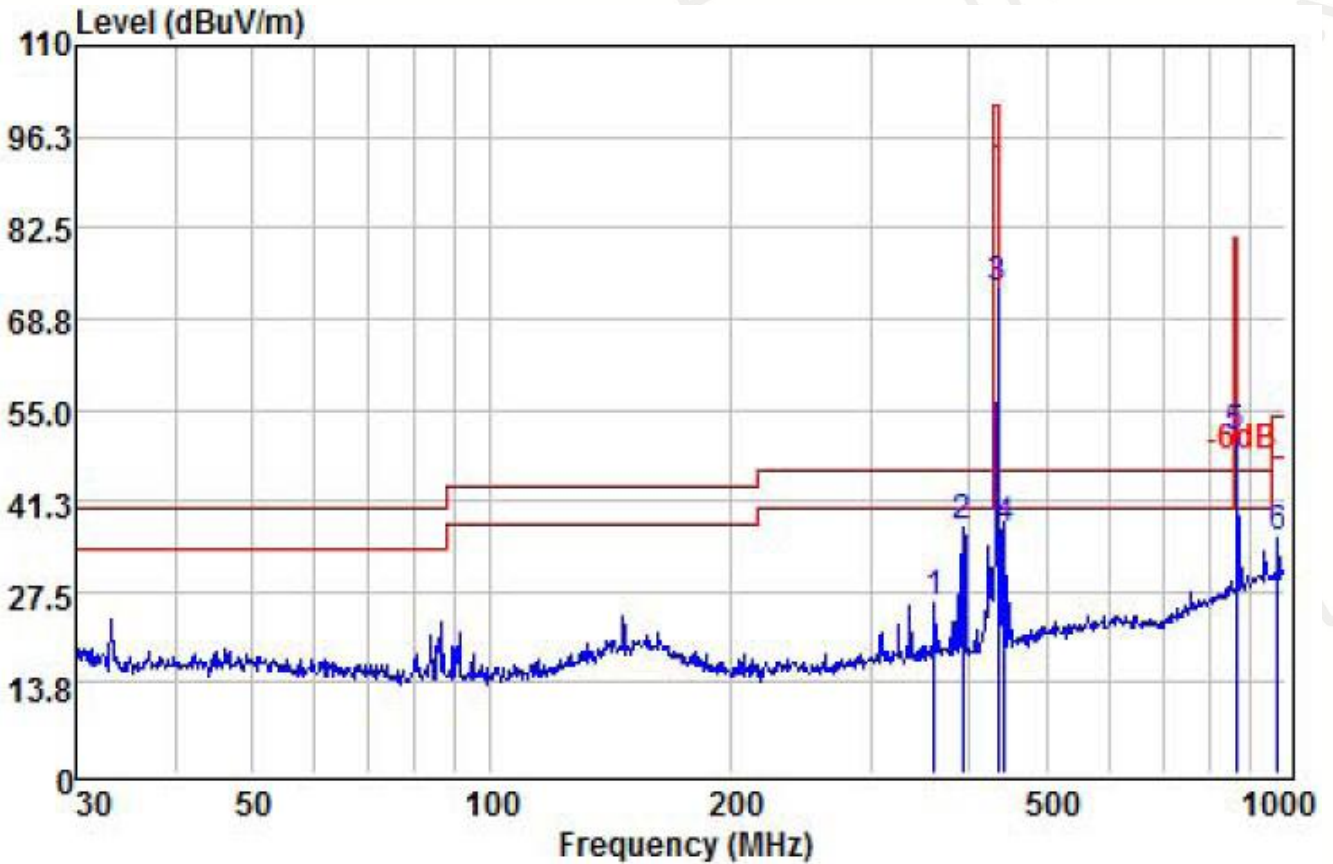

	Read	Antenna	Cable	Limit	Over			
Freq	Level	Factor	Loss	Line	Limit	Remark		
MHz	dBuV	dB/m	dB	dBuV/m	dBuV/m	dB		
1	361.71	11.20	13.80	0.81	25.81	46.00	-20.19	QP
2	392.10	22.02	14.20	0.89	37.11	46.00	-8.89	QP
3	434.07	57.34	15.03	1.00	73.37	100.80	-27.43	Peak
4	443.29	20.57	15.22	1.04	36.83	46.00	-9.17	QP
5	868.13	27.20	21.82	1.55	50.57	80.80	-30.23	Peak
6	979.18	10.28	23.78	1.67	35.73	54.00	-18.27	QP

For average:

Frequency MHz	Peak Level dBuV/m	Duty cycle factor	Average Level dBuV/m	Limit	Margin dB
434.07	73.37	-6.09	67.28	80.80	-13.52
868.13	50.57	-6.09	44.48	60.80	-16.32

- Notes: 1. Average emission Level = Peak Level + Duty cycle factor
- 2. Duty cycle level please see clause 3.5.
- 3. We pretest all two keys, only worst case is presented in the report.

Test Data for 1GHz~5GHz

Horizontal

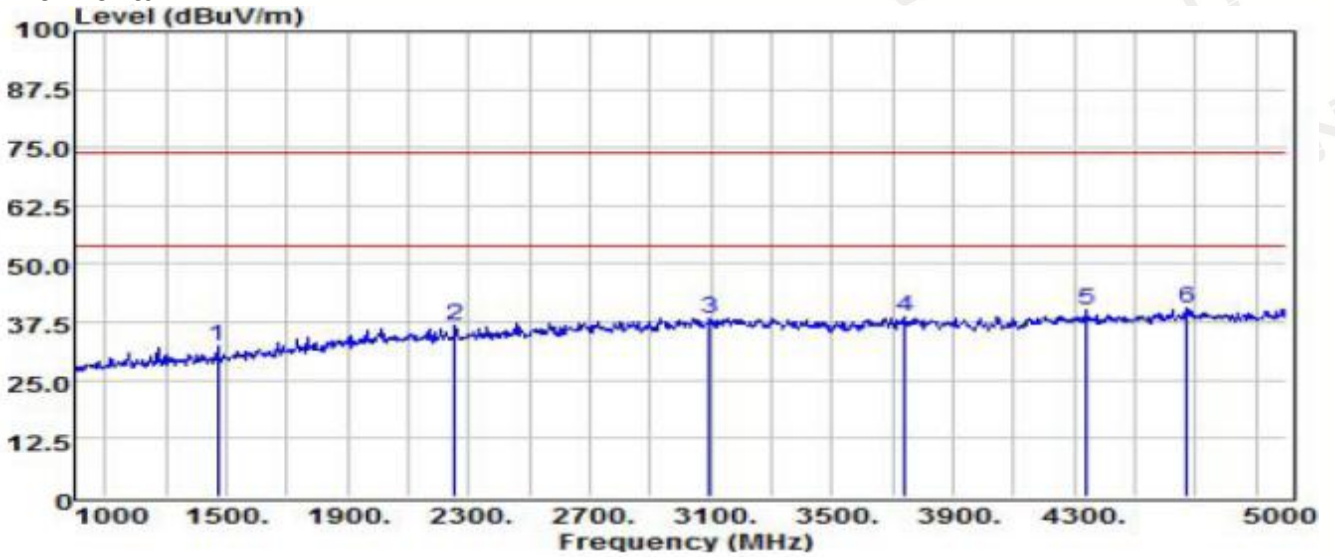

	ReadAntenna	Cable	Limit	Over			
Freq	Level	Factor	Loss	Level	Line	Limit	Remark
MHz	dBuV	dB/m	dB	dBuV/m	dBuV/m	dB	
1	1472.00	30.97	25.26	2.31	32.45	74.00	-41.55 Peak
2	2256.00	31.15	28.61	3.18	36.66	74.00	-37.34 Peak
3	3096.00	30.93	30.09	3.96	38.44	74.00	-35.56 Peak
4	3740.00	31.14	30.98	3.36	38.61	74.00	-35.39 Peak
5	4340.00	31.81	31.97	3.51	40.09	74.00	-33.91 Peak
6	4672.00	31.51	32.61	3.86	40.57	74.00	-33.43 Peak

Vertical

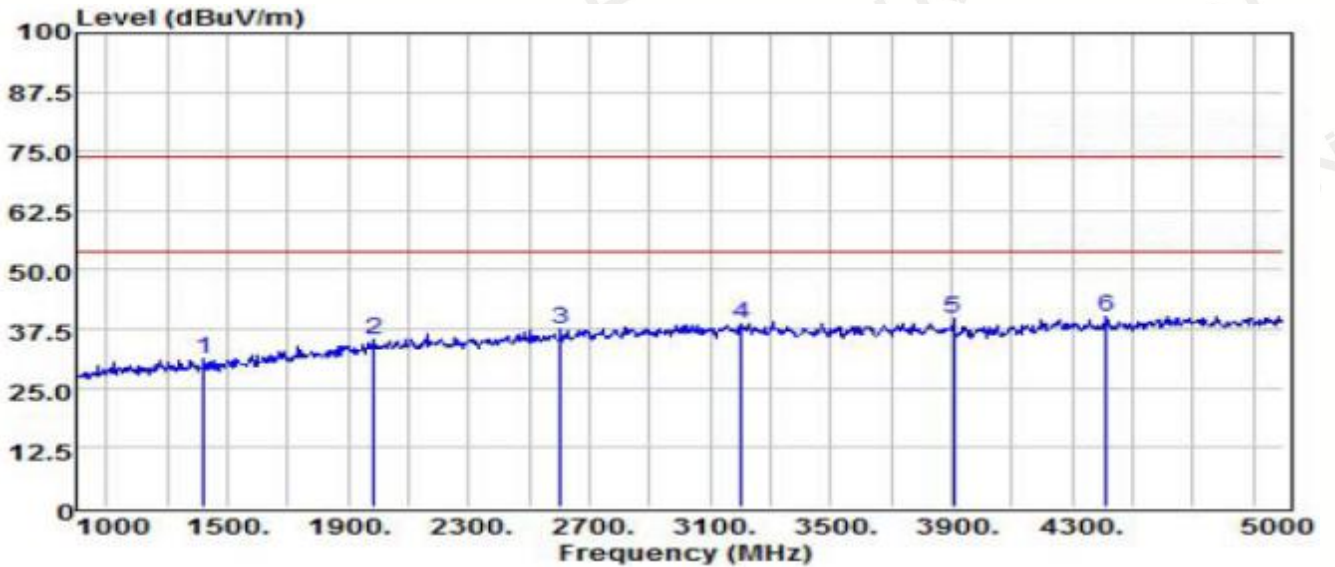

	ReadAntenna	Cable	Limit	Over			
Freq	Level	Factor	Loss	Level	Line	Limit	Remark
MHz	dBuV	dB/m	dB	dBuV/m	dBuV/m	dB	
1	1424.00	30.03	25.13	2.26	31.34	74.00	-42.66 Peak
2	1988.00	30.31	28.30	2.81	35.22	74.00	-38.78 Peak
3	2604.00	31.19	29.04	3.63	37.48	74.00	-36.52 Peak
4	3204.00	31.37	30.21	3.86	38.84	74.00	-35.16 Peak
5	3904.00	32.18	31.33	3.24	39.79	74.00	-34.21 Peak
6	4412.00	31.61	32.08	3.60	40.04	74.00	-33.96 Peak

3.3 -20db OCCUPIED BANDWIDTH

Limit

According to 47 CFR 15.231(c) The bandwidth of the emission shall be no wider than 0.25% of the centre frequency for devices operating above 70MHz and below 900MHz. Bandwidth is determined at the points 20dB down from the modulated carrier.

Test Procedure

The transmitter output was connected to the spectrum analyzer through an attenuator. The bandwidth of the fundamental frequency was measured by spectrum analyzer with 30 KHz RBW and 100 KHz VBW. The 20dB bandwidth is defined as the total spectrum the power of which is higher than peak power minus 20dB.

Test Configuration



Test Result

---PASS---

Modulation	Channel Frequency (MHz)	99% OBW (KHz)	20dB bandwidth (KHz)	Limit (KHz)	Result
ASK	433.92	321.82	151.0	$0.25\% * 433.92 = 1084.8$	Pass

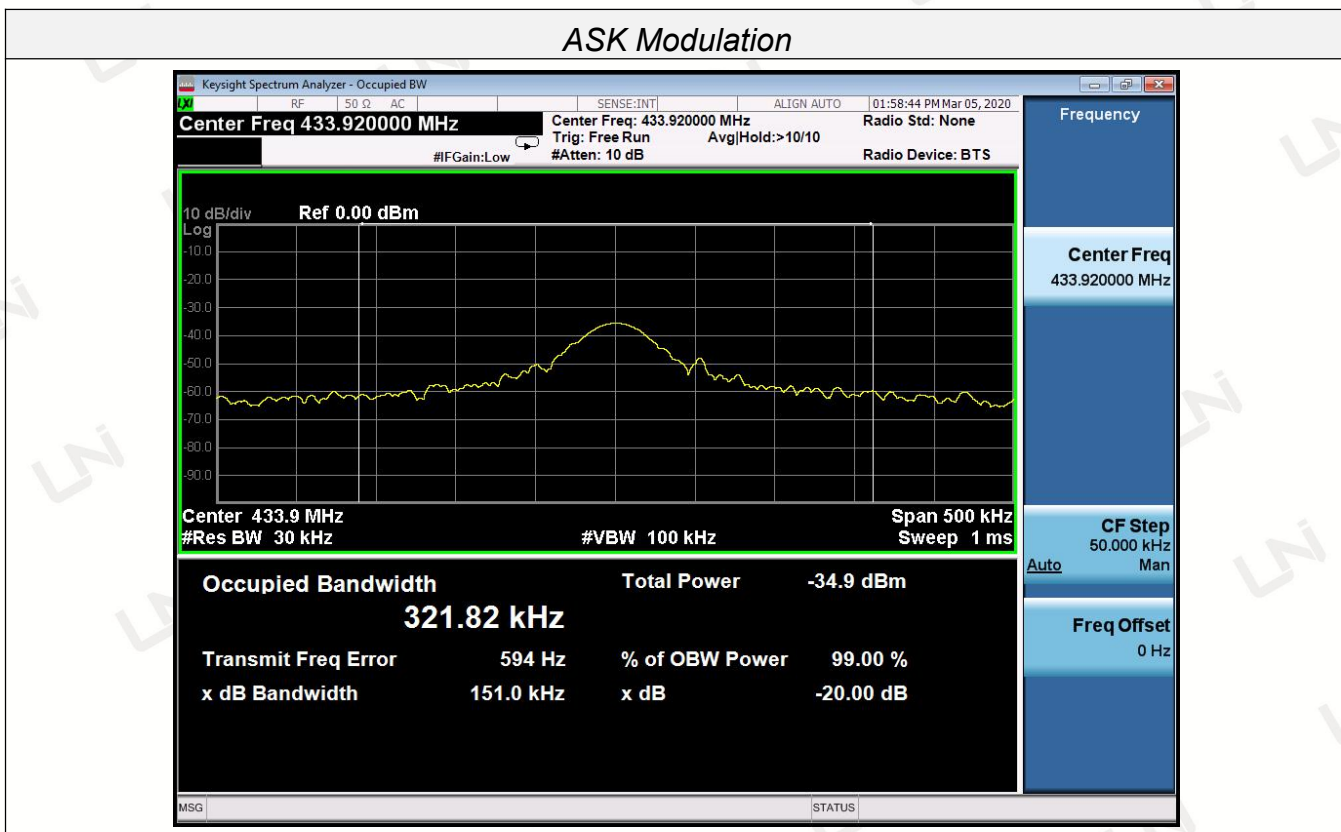

3.4 Deactivation Time

LIMIT

According to FCC §15.231(a)(2), A transmitter activated automatically shall cease transmission within 5 seconds after activation.

TEST PROCEDURE

1. The EUT was placed on a wooded table which is 0.8m height and close to receiver antenna of spectrum analyzer.
2. The spectrum analyzer resolution bandwidth was set to 1 MHz and video bandwidth was set to 1 MHz to encompass all significant spectral components during the test. The spectrum analyzer was operated in linear scale and zero span mode after tuning to the transmitter carrier frequency.

Test Configuration



TEST RESULTS

Frequency (MHz)	One transmission time (S)	Limit(S)	Result
433.92	0.31	5	Pass

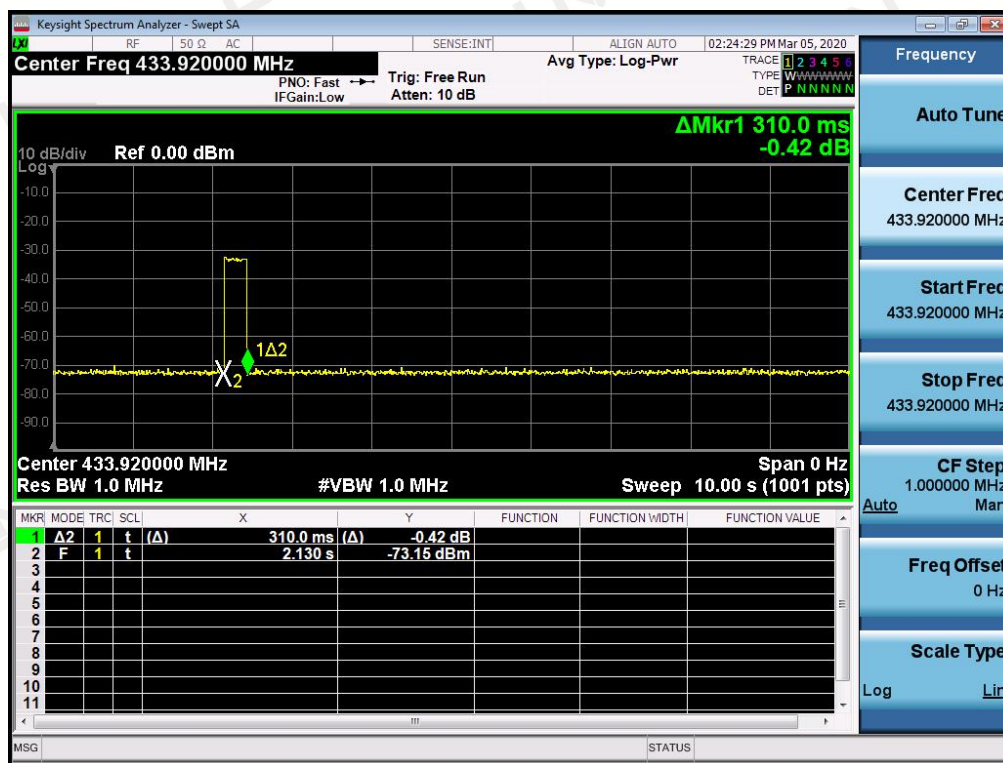

3.5 CALCULATION OF AVERAGE FACTOR

The output field strengths of specification in accordance with the FCC rules specify measurements with an average detector. During the test, a spectrum analyzer incorporating a peak detector was used. Therefore, a reduction factor can be applied to the resultant peak signal level and compared to the limit for measurement instrumentation incorporating an average detector.

The duty cycle is measured in 100 ms or the repetition cycle period, whichever is a shorter time frame. The duty cycle is measured by placing the spectrum analyzer to set zero span at 100kHz resolution bandwidth.

Averaging factor in dB = $20\log(\text{duty cycle})$

The duration of one cycle = 47.20ms

The duty cycle is simply the on-time divided the duration of one cycle

Duty Cycle = $(1.3\text{ms} \cdot 11 + 0.65\text{ms} \cdot 14) / 47.20 = 23.4\text{ms} / 47.20\text{ms} = 0.4958$

Therefore, the averaging factor is found by $20\log 0.4958 = -6.09\text{dB}$

Test plot as follows:

T period

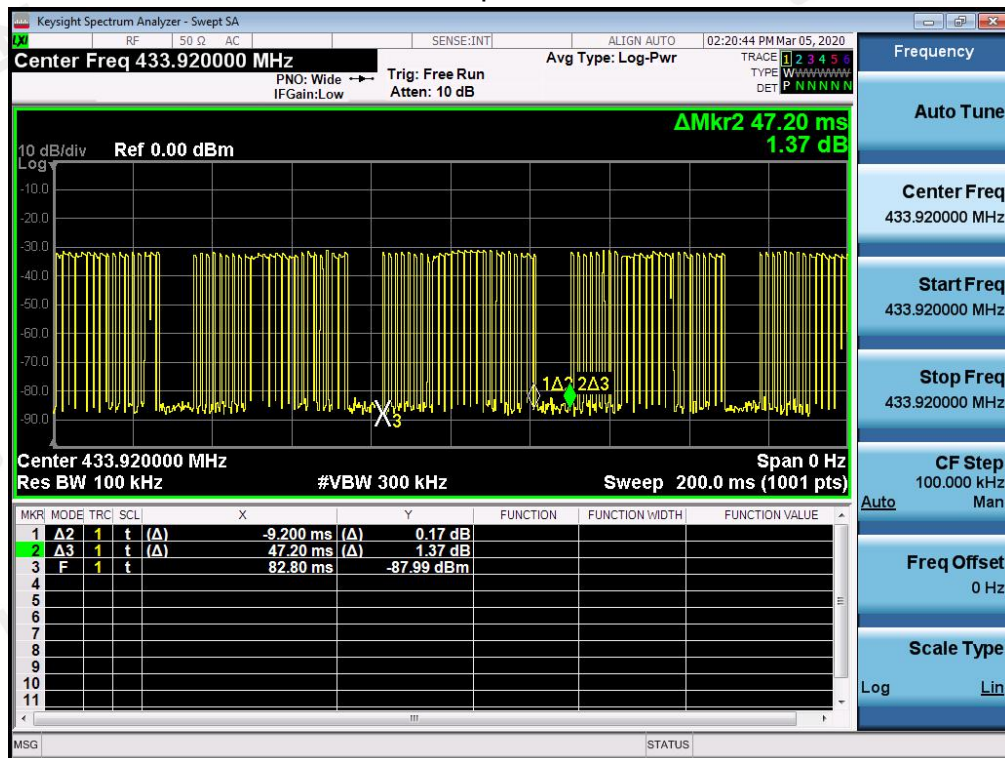

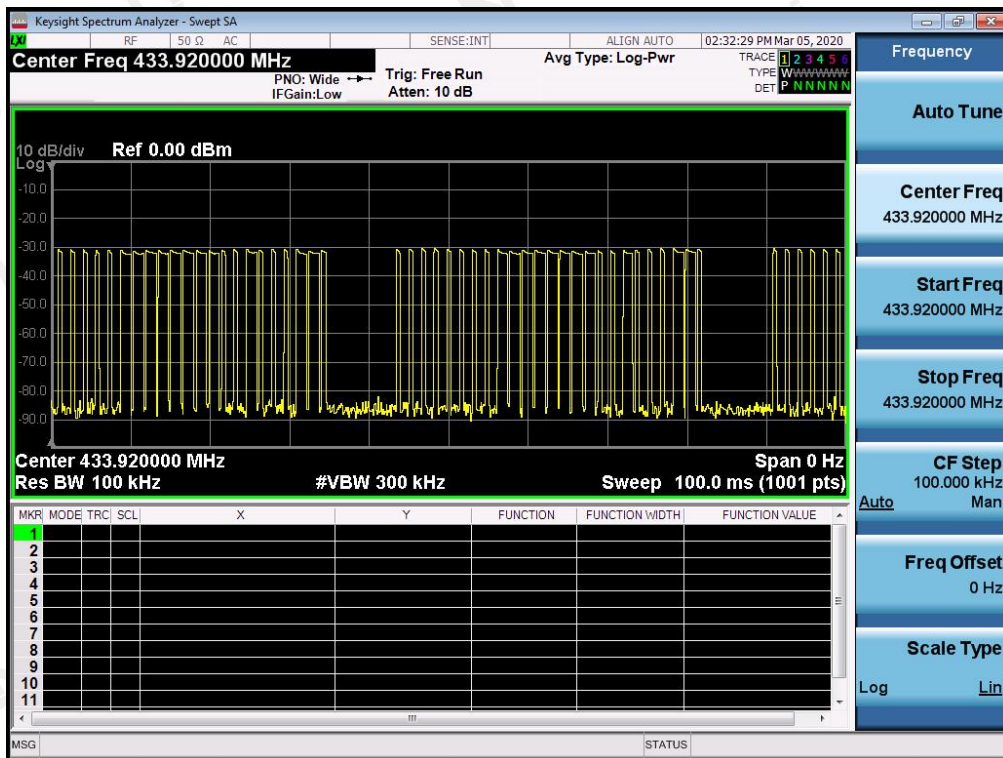
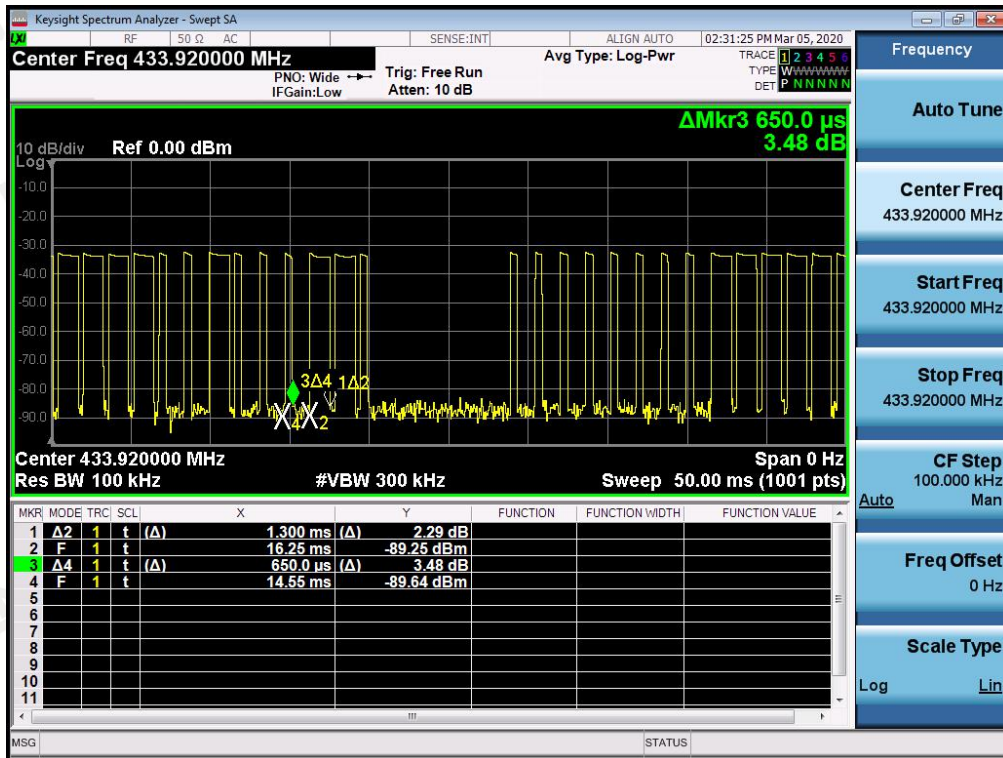

3.6 ANTENNA REQUIREMENT

Standard Applicable:

For intentional device, according to FCC 47 CFR Section 15.203, an intentional radiator shall be designed to ensure that no antenna other than that furnished by the responsible party shall be used with the device.

Antenna Connected Construction

The antenna used in this product is an Integral Antenna, the directional gains of antenna used for transmitting is 10dBi

ANTENNA

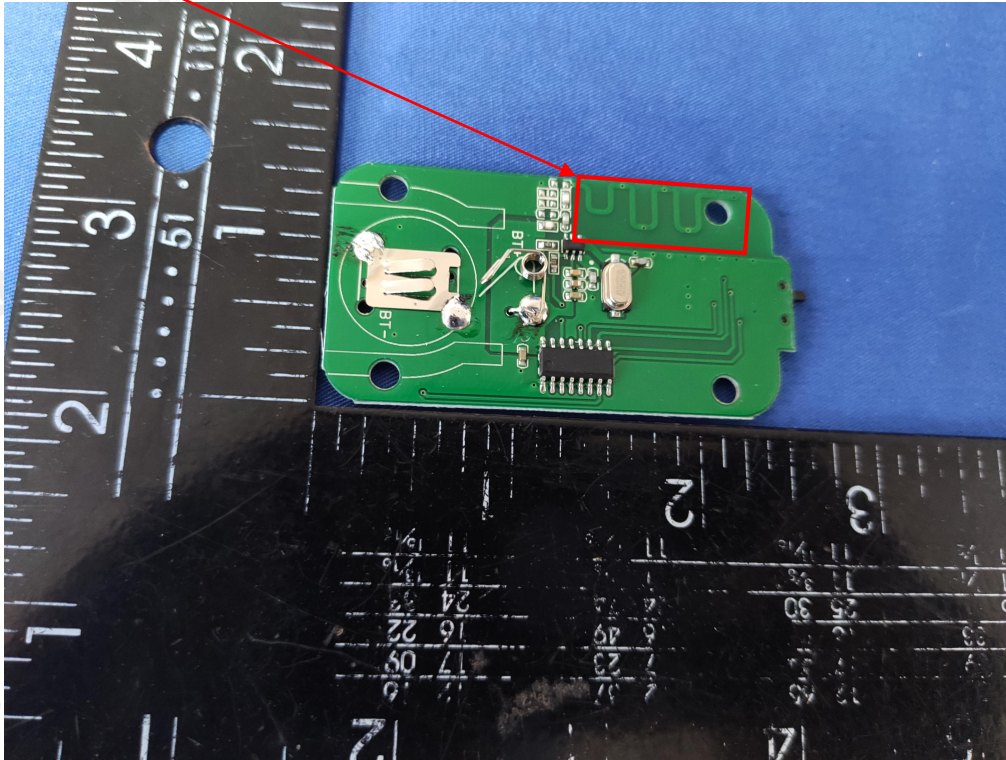

4 PHOTOGRAPH OF TEST Radiated Emission

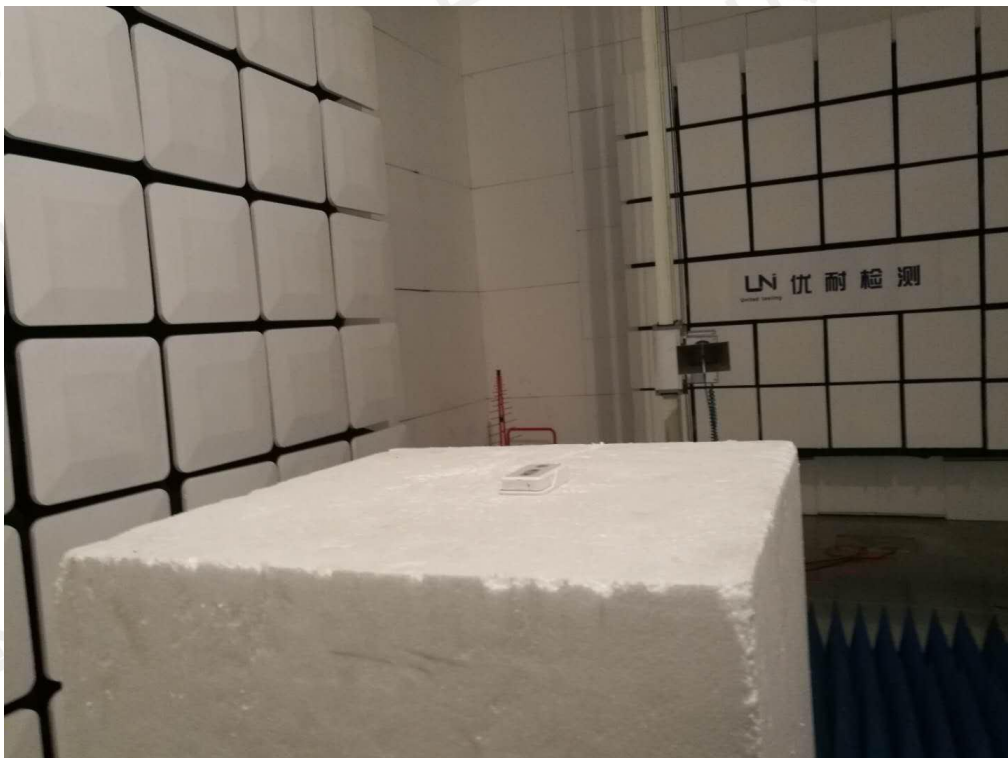

***** End of Report *****