



# MEASUREMENT REPORT

## FCC PART 15.249

---

**FCC ID:** 2AMN5-70122  
**APPLICANT:** MARKLYN CO. INC.  
**Application Type:** Certification  
**Product:** PROSTROBE QUADSTROBZ DUAL  
**Model No.:** 70122  
**Serial Model:** 70120  
**Brand Name:** PROSTROBE  
**FCC Classification:** Low Power Communication Device Transmitter (DXX)  
**FCC Rule Part(s):** Part 15.249  
**Test Procedure(s):** ANSI C63.10 – 2013  
**Test Date:** September 01 ~ 20, 2017

Reviewed By : Kevin Guo  
( Kevin Guo )

Approved By : Marlin Chen  
( Marlin Chen )



The test results relate only to the samples tested.

This equipment has been shown to be capable of compliance with the applicable technical standards as indicated in the measurement report and was tested in accordance with the measurement procedures specified in ANSI C63.10-2013. Test results reported herein relate only to the item(s) tested.

The test report shall not be reproduced except in full without the written approval of MRT Technology (Suzhou) Co., Ltd.

---

### Revision History

Report No.	Version	Description	Issue Date	Note
1709RSU01301	Rev. 01	Final report	09-20-2017	Valid

---

## CONTENTS

Description	Page
<b>1. INTRODUCTION .....</b>	<b>6</b>
1.1. Scope .....	6
1.2. MRT Test Location .....	6
<b>2. PRODUCT INFORMATION .....</b>	<b>7</b>
2.1. Equipment Description.....	7
2.2. Operation Frequency and Channel List.....	8
2.3. Test Configuration .....	8
2.4. EMI Suppression Device(s)/Modifications.....	8
2.5. Labeling Requirements.....	9
<b>3. DESCRIPTION OF TEST .....</b>	<b>10</b>
3.1. Evaluation Procedure .....	10
3.2. AC Line Conducted Emissions .....	10
3.3. Radiated Emissions.....	11
<b>4. ANTENNA REQUIREMENTS .....</b>	<b>12</b>
<b>5. TEST EQUIPMENT CALIBRATION DATE .....</b>	<b>13</b>
<b>6. MEASUREMENT UNCERTAINTY.....</b>	<b>14</b>
<b>7. TEST RESULT .....</b>	<b>15</b>
7.1. Summary .....	15
7.2. Conducted Emission.....	16
7.2.1. Test Limit .....	16
7.2.2. Test Setup.....	16
7.2.3. Test Result.....	16
7.3. Radiated Emission.....	17
7.3.1. Test Limit .....	17
7.3.2. Test Setup.....	18
7.3.3. Test Result.....	20
7.4. Radiated Restricted Band Edge Measurement .....	25
7.4.1. Test Result.....	25
7.5. 20dB Spectrum Bandwidth Measurement .....	33
7.5.1. Test Limit .....	33
7.5.2. Test Procedure used.....	33
7.5.3. Test Setting.....	33
7.5.4. Test Setup.....	33

7.5.5.	Test Result.....	34
7.6.	99% Bandwidth Measurement.....	35
7.6.1.	Test Limit .....	35
7.6.2.	Test Procedure used.....	35
7.6.3.	Test Setting.....	35
7.6.4.	Test Setup.....	35
7.6.5.	Test Result.....	36
<b>8.</b>	<b>CONCLUSION.....</b>	<b>37</b>

## §2.1033 General Information

<b>Applicant:</b>	MARKLYN CO. INC.
<b>Applicant Address:</b>	190 Bovaird Drive West, Unit 28, Brampton, Ontario, L7A 1A2, Canada
<b>Manufacturer:</b>	SHENZHEN SMILE LIGHTING CO., LTD
<b>Manufacturer Address:</b>	1 <sup>st</sup> Bu Bohua Technology Industry Area Longhua New District, Shenzhen, China
<b>Test Site:</b>	MRT Technology (Suzhou) Co., Ltd
<b>Test Site Address:</b>	D8 Building, Youxin Industrial Park, No.2 Tian'edang Rd., Wuzhong Economic Development Zone, Suzhou, China
<b>FCC Registration No.:</b>	893164
<b>IC Registration No.:</b>	11384A-1
<b>FCC Rule Part(s):</b>	Part 15.249
<b>FCC ID:</b>	2AMN5-70122
<b>Test Device Serial No.:</b>	N/A <input type="checkbox"/> Production <input checked="" type="checkbox"/> Pre-Production <input type="checkbox"/> Engineering
<b>FCC Classification:</b>	Low Power Communication Device Transmitter (DXX)

### Test Facility / Accreditations

Measurements were performed at MRT Laboratory located in Tian'edang Rd., Suzhou, China.

- MRT facility is a FCC registered (MRT Reg. No. 893164) test facility with the site description report on file and has met all the requirements specified in Section 2.948 of the FCC Rules.
- MRT facility is an IC registered (MRT Reg. No. 11384A-1) test laboratory with the site description on file at Industry Canada.
- MRT facility is a VCCI registered (R-4179, G-814, C-4664, T-2206) test laboratory with the site description on file at VCCI Council.
- MRT Lab is accredited to ISO 17025 by the American Association for Laboratory Accreditation (A2LA) under the American Association for Laboratory Accreditation Program (A2LA Cert. No. 3628.01) in EMC, Telecommunications and Radio testing for FCC, Industry Canada, EU and TELEC Rules.



## 1. INTRODUCTION

### 1.1. Scope

Measurement and determination of electromagnetic emissions (EMC) of radio frequency devices including intentional and/or unintentional radiators for compliance with the technical rules and regulations of the Federal Communications Commission and the Industry Canada Certification and Engineering Bureau.

### 1.2. MRT Test Location

The map below shows the location of the MRT LABORATORY, its proximity to the Taihu Lake. These measurement tests were conducted at the MRT Technology (Suzhou) Co., Ltd. Facility located at D8 Building, Youxin Industrial Park, No.2 Tian'edang Rd., Wuzhong Economic Development Zone, Suzhou, China. The detailed description of the measurement facility was found to be in compliance with the requirements of § 2.948 according to ANSI C63.4-2009 on September 30, 2013.



## 2. PRODUCT INFORMATION

### 2.1. Equipment Description

Product Name	PROSTROBE QUADSTROBZ DUAL
Model No.	70122
Serial Model	70120
Frequency Range	2419 ~ 2474 MHz
Data Rate	250Kbps
Channel Space	1MHz
Type of Modulation	GFSK
Data Rate	250Kbps
Antenna Type	INTEGRAL
Antenna Gain	0dBi

## 2.2. Operation Frequency and Channel List

Channel	Frequency	Channel	Frequency	Channel	Frequency
01	2419MHz	02	2420MHz	03	2421MHz
04	2422MHz	05	2423MHz	06	2424MHz
07	2425MHz	08	2426MHz	09	2427MHz
10	2428MHz	11	2429MHz	12	2430MHz
13	2431MHz	14	2432MHz	15	2433MHz
16	2434MHz	17	2435MHz	18	2436MHz
19	2437MHz	20	2438MHz	21	2439MHz
22	2440MHz	23	2441MHz	24	2442MHz
25	2443MHz	26	2444MHz	27	2445MHz
28	2446MHz	29	2447MHz	30	2448MHz
31	2449MHz	32	2450MHz	33	2451MHz
34	2452MHz	35	2453MHz	36	2454MHz
37	2455MHz	38	2456MHz	39	2457MHz
40	2458MHz	41	2459MHz	42	2460MHz
43	2461MHz	44	2462MHz	45	2463MHz
46	2464MHz	47	2465MHz	48	2466MHz
49	2467MHz	50	2468MHz	51	2469MHz
52	2470MHz	53	2471MHz	54	2472MHz
55	2473MHz	56	2474MHz		

## 2.3. Test Configuration

The EUT was tested as described in this report is in compliance with the requirements limits of FCC Rules Part 15.207,15.209, 15.215 and 15.249. ANSI C63.10-2013 was used to reference the appropriate EUT setup for radiated spurious emissions testing and AC line conducted testing.

## 2.4. EMI Suppression Device(s)/Modifications

No EMI suppression device(s) were added and/or no modifications were made during testing.



## **2.5. Labeling Requirements**

Per 2.1074 & 15.19; Docket 95-19

The label shall be permanently affixed at a conspicuous location on the device; instruction manual or pamphlet supplied to the user and be readily visible to the purchaser at the time of purchase.

However, when the device is so small wherein placement of the label with specified statement is not practical, only the FCC ID must be displayed on the device per Section 15.19(a)(5). Please see attachment for FCC ID label and label location.

### 3. DESCRIPTION OF TEST

#### 3.1. Evaluation Procedure

The measurement procedures described in the American National Standard for Testing Unlicensed Wireless Devices (ANSI C63.10-2013), and the requirements provided in FCC 15.207, 15.209, 15.215 and 15.249 were performed in the report of the EUT.

**Deviation from measurement procedure.....None**

#### 3.2. AC Line Conducted Emissions

The line-conducted facility is located inside an 8'x4'x4' shielded enclosure. A 1m x 2m wooden table 80cm high is placed 40cm away from the vertical wall and 80cm away from the sidewall of the shielded room. Two 10kHz-30MHz, 50Ω/50uH Line-Impedance Stabilization Networks (LISNs) are bonded to the shielded room floor. Power to the LISNs is filtered by external high-current high-insertion loss power line filters. These filters attenuate ambient signal noise from entering the measurement lines. These filters are also bonded to the shielded enclosure.

The EUT is powered from one LISN and the support equipment is powered from the second LISN. All interconnecting cables more than 1 meter were shortened to a 1 meter length by non-inductive bundling (serpentine fashion) and draped over the back edge of the test table. All cables were at least 40cm above the horizontal reference ground-plane. Power cables for support equipment were routed down to the second LISN while ensuring that that cables were not draped over the second LISN.

Sufficient time for the EUT, support equipment, and test equipment was allowed in order for them to warm up to their normal operating condition. The RF output of the LISN was connected to the receiver and exploratory measurements were made to determine the frequencies producing the maximum emission from the EUT. The receiver was scanned from 150kHz to 30MHz. The detector function was set to peak mode for exploratory measurements while the bandwidth of the analyzer was set to 9kHz. The EUT, support equipment, and interconnecting cables were arranged and manipulated to maximize each emission. Each emission was also maximized by varying: power lines, the mode of operation or data exchange speed, or support equipment whichever determined the worst-case emission. Once the worst case emissions have been identified, the one EUT cable configuration/arrangement and mode of operation that produced these emissions are used for final measurements on the same test site. The analyzer is set to CISPR quasi-peak and average detectors with a 9kHz resolution bandwidth for final measurements.

An extension cord was used to connect to a single LISN which powered by EUT. The extension cord was calibrated with LISN, the impedance and insertion loss are compliance with the requirements as stated in ANSI C63.10-2013.

Line conducted emissions test results are shown in Section 7.2.

### 3.3. Radiated Emissions

The radiated test facilities consisted of an indoor 3 meter semi-anechoic chamber used for final measurements and exploratory measurements, when necessary. The measurement area is contained within the semi-anechoic chamber which is shielded from any ambient interference. For measurements above 1GHz absorbers are arranged on the floor between the turn table and the antenna mast in such a way so as to maximize the reduction of reflections. For measurements below 1GHz, the absorbers are removed. A MF Model 210SS turntable is used for radiated measurement. It is a continuously rotatable, remote controlled, metallic turntable and 2 meters (6.56 ft.) in diameter. The turn table is flush with the raised floor of the chamber in order to maintain its function as a ground plane. An 80cm high PVC support structure is placed on top of the turntable.

For all measurements, the spectrum was scanned through all EUT azimuths and from 1 to 4 meter receive antenna height using a broadband antenna from 30MHz up to the upper frequency shown in 15.33(b)(1) depending on the highest frequency generated or used in the device or on which the device operates or tunes. For frequencies above 1GHz, linearly polarized double ridge horn antennas were used. For frequencies below 30MHz, a calibrated loop antenna was used. When exploratory measurements were necessary, they were performed at 1 meter test distance inside the semi-anechoic chamber using broadband antennas, broadband amplifiers, and spectrum analyzers to determine the frequencies and modes producing the maximum emissions. Sufficient time for the EUT, support equipment, and test equipment was allowed in order for them to warm up to their normal operating condition. The test set-up for frequencies below 1GHz was placed on top of the 0.8 meter high, 1 x 1.5 meter table; and test set-up for frequencies 1-25GHz was placed on top of the 1.5 meter high, 1 x 1.5 meter table. The EUT, support equipment, and interconnecting cables were arranged and manipulated to maximize each emission. Appropriate precaution was taken to ensure that all emissions from the EUT were maximized and investigated. The system configuration, clock speed, mode of operation or video resolution, if applicable, turntable azimuth, and receive antenna height was noted for each frequency found.

Final measurements were made in the semi-anechoic chamber using calibrated, linearly polarized broadband and horn antennas. The test setup was configured to the setup that produced the worst case emissions. The spectrum analyzer was set to investigate all frequencies required for testing to compare the highest radiated disturbances with respect to the specified limits. The turntable containing the EUT was rotated through 360 degrees and the height of the receive antenna was varied 1 to 4 meters and stopped at the azimuth and height producing the maximum emission. Each emission was maximized by changing the orientation of the EUT through three orthogonal planes and changing the polarity of the receive antenna, whichever produced the worst-case emissions. According to 3dB Beam-Width of horn antenna, the horn antenna should be always directed to the EUT when rising height.

## 4. ANTENNA REQUIREMENTS

### Excerpt from §15.203 of the FCC Rules/Regulations:

“An intentional radiator antenna shall be designed to ensure that no antenna other than that furnished by the responsible party can be used with the device. The use of a permanently attached antenna or of an antenna that uses a unique coupling to the intentional radiator shall be considered sufficient to comply with the provisions of this section.”

- The antenna of the EUT **is permanently attached.**
- There are no provisions for connection to an external antenna.

### **Conclusion:**

This unit complies with the requirement of §15.203.

## 5. TEST EQUIPMENT CALIBRATION DATE

### Conducted Emissions - SR2

Instrument	Manufacturer	Type No.	Asset No.	Cali. Interval	Cali. Due Date
EMI Test Receiver	R&S	ESR7	MRTSUE06001	1 year	2018/06/20
Two-Line V-Network	R&S	ENV216	MRTSUE06002	1 year	2018/06/20
Two-Line V-Network	R&S	ENV216	MRTSUE06003	1 year	2018/06/20
Temperature/Humidity Meter	Yuhuaze	HTC-2	MRTSUE06181	1 year	2017/12/20
Shielding Anechoic Chamber	Mikebang	Chamber-SR2	MRTSUE06214	1 year	2018/05/10

### Radiated Emission – AC1

Instrument	Manufacturer	Type No.	Asset No.	Cali. Interval	Cal. Due Date
MXE EMI Receiver	Agilent	N9038A	MRTSUE06125	1 year	2018/08/03
Microwave System Amplifier	Agilent	83017A	MRTSUE06076	1 year	2018/03/28
Loop Antenna	Schwarzbeck	FMZB1519	MRTSUE06025	1 year	2017/11/21
Bilog Period Antenna	Schwarzbeck	VULB 9168	MRTSUE06172	1 year	2017/11/19
Horn Antenna	Schwarzbeck	BBHA9120D	MRTSUE06023	1 year	2017/10/22
Broadband Horn Antenna	Schwarzbeck	BBHA9170	MRTSUE06024	1 year	2018/01/04
Temperature/Humidity Meter	Yuhuaze	HTC-2	MRTSUE06183	1 year	2017/12/20
Anechoic Chamber	TDK	Chamber-AC1	MRTSUE06212	1 year	2018/05/10

### Conducted Test Equipment - TR3

Instrument	Manufacturer	Type No.	Asset No.	Cali. Interval	Cali. Due Date
MXE EMI Receiver	Agilent	N9038A	MRTSUE06125	1 year	2018/08/03
Temperature/Humidity Meter	Yuhuaze	HTC-2	MRTSUE06180	1 year	2017/12/20

Software	Version	Function
e3	V8.3.5	EMI Test Software

## 6. MEASUREMENT UNCERTAINTY

Where relevant, the following test uncertainty levels have been estimated for tests performed on the EUT as specified in CISPR 16-4-2. This uncertainty represents an expanded uncertainty expressed at approximately the 95% confidence level using a coverage factor of  $k = 2$ .

<b>AC Conducted Emission Measurement - SR2</b>
Measuring Uncertainty for a Level of Confidence of 95% ( $U=2Uc(y)$ ): 150kHz~30MHz: 3.46dB
<b>Radiated Emission Measurement – AC1</b>
Measuring Uncertainty for a Level of Confidence of 95% ( $U=2Uc(y)$ ): 9kHz ~ 1GHz: 4.18dB 1GHz ~ 25GHz: 4.76dB
<b>20dB Spectrum Bandwidth - TR3</b>
Measuring Uncertainty for a Level of Confidence of 95% ( $U=2Uc(y)$ ): 0.28%

## 7. TEST RESULT

### 7.1. Summary

Company Name: MARKLYN CO. INC.

Product: PROSTROBE QUADSTROBZ DUAL

FCC Part Section(s)	Test Description	Test Limit	Test Condition	Test Result	Reference
15.207	AC Conducted Emissions 150kHz - 30MHz	< FCC 15.207 limits	Line Conducted	N/A	Section 7.2
15.209 15.249	General Field Strength Limits (Restricted Bands and Radiated Emission Limits)	Emissions in restricted bands must meet the radiated limits detailed in 15.209	Radiated	Pass	Section 7.3 & 7.4
15.215(c)	20dB Spectrum Bandwidth	20 dB bandwidth of the emission in the specific band	Conducted	Pass	Section 7.5

**Notes:**

- 1) All modes of operation and data rates were investigated. For radiated emission test, every axis (X, Y, Z) was also verified. The test results shown in the following sections represent the worst case emissions.
- 2) The analyzer plots shown in this section were all taken with a correction table loaded into the analyzer. The correction table was used to account for the losses of the cables and attenuators used as part of the system to connect the EUT to the analyzer at all frequencies of interest.

## 7.2. Conducted Emission

### 7.2.1. Test Limit

FCC Part 15 Subpart C Paragraph 15.207 Limits		
Frequency (MHz)	QP (dBuV)	AV (dBuV)
0.15 - 0.50	66 - 56	56 - 46
0.50 - 5.0	56	46
5.0 - 30	60	50

Note 1: The lower limit shall apply at the transition frequencies.

Note 2: The limit decreases linearly with the logarithm of the frequency in the range 0.15 MHz to 0.5 MHz.

### 7.2.2. Test Setup

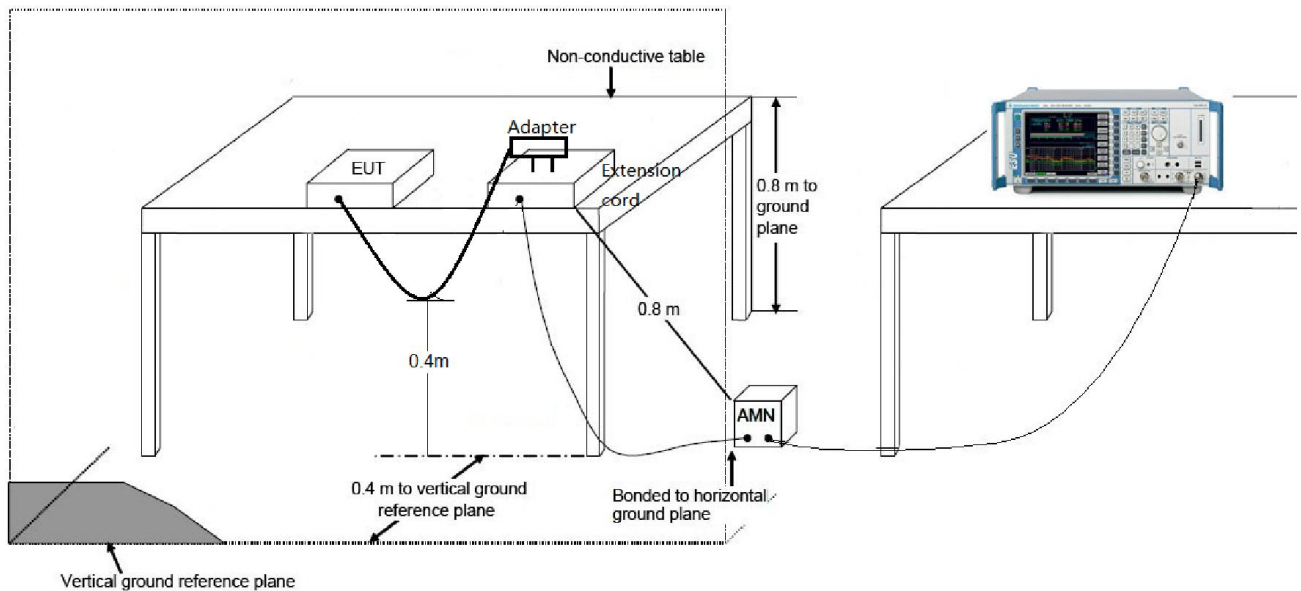

### 7.2.3. Test Result

The EUT is powered by battery, so this requirement does not apply.



### 7.3. Radiated Emission

#### 7.3.1. Test Limit

FCC Part 15 Subpart C Paragraph 15.209		
Frequency (MHz)	Field Strength (microvolts/meter)	Measurement Distance (uV/m)
0.009-0.490	2400/F(kHz)	300
0.490-1.705	24000/F(kHz)	30
1.705-30.0	30	30
30-80	100**	3
80-216	150**	3
216-960	200**	3
Above 960	500	3

Note 1: The lower limit shall apply at the transition frequency.

Note 2: Distance refers to the distance in meters between the measuring instrument antenna and the closed point of any part of the device or system.

Note 3: E field strength (dBuV/m) = 20 log E field strength (uV/m).

FCC Part 15 Subpart C Paragraph 15.249		
Fundamental Frequency	Field Strength of Fundamental (millivolts/meter)	Field Strength of Harmonics (microvolts/meter)
902-928(MHz)	50	500
2400-2483.5(MHz)	50	500
5725-5875(MHz)	50	500
24.0-24.25(GHz)	250	2500

FCC Part 15.249 (d), Emissions radiated outside of the specified frequency bands, except for harmonics, shall be attenuated by at least 50 dB below the level of the fundamental or to the general radiated emission limits in §15.209, whichever is the lesser attenuation.

### 7.3.2. Test Setup

#### 9kHz ~ 30MHz Test Setup:

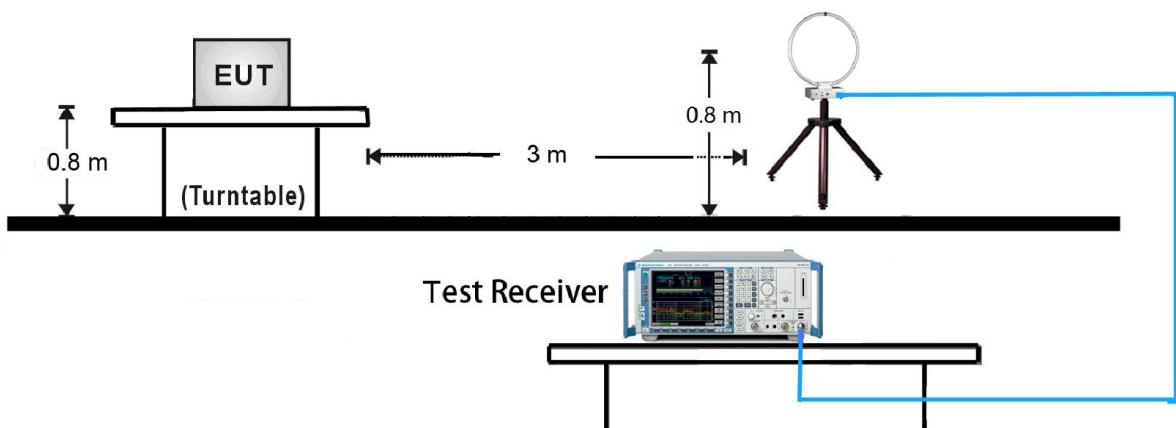

30MHz ~ 1GHz Test Setup:

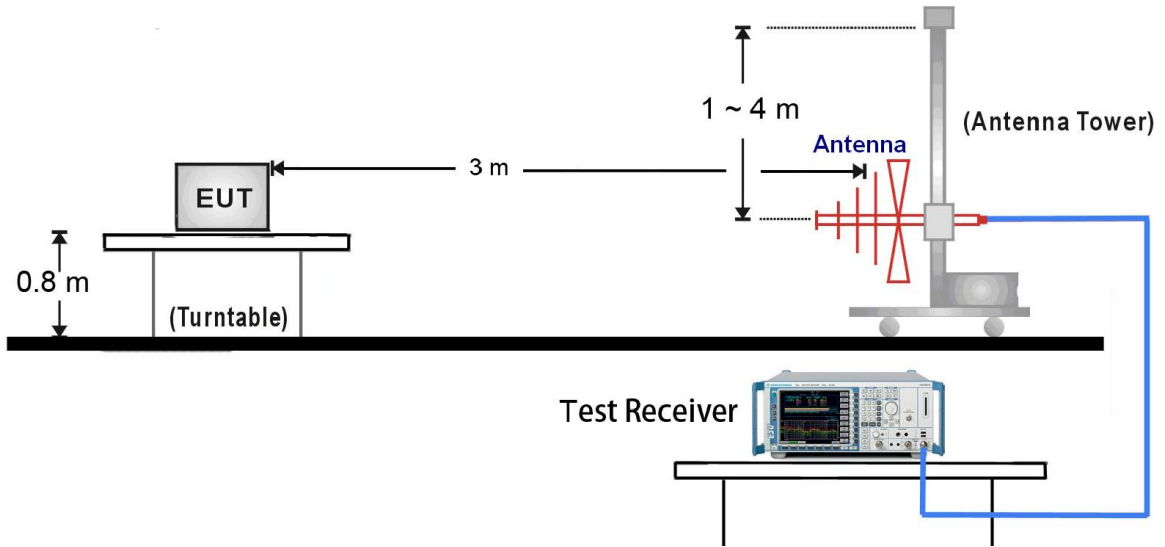

1GHz ~ 25GHz Test Setup:

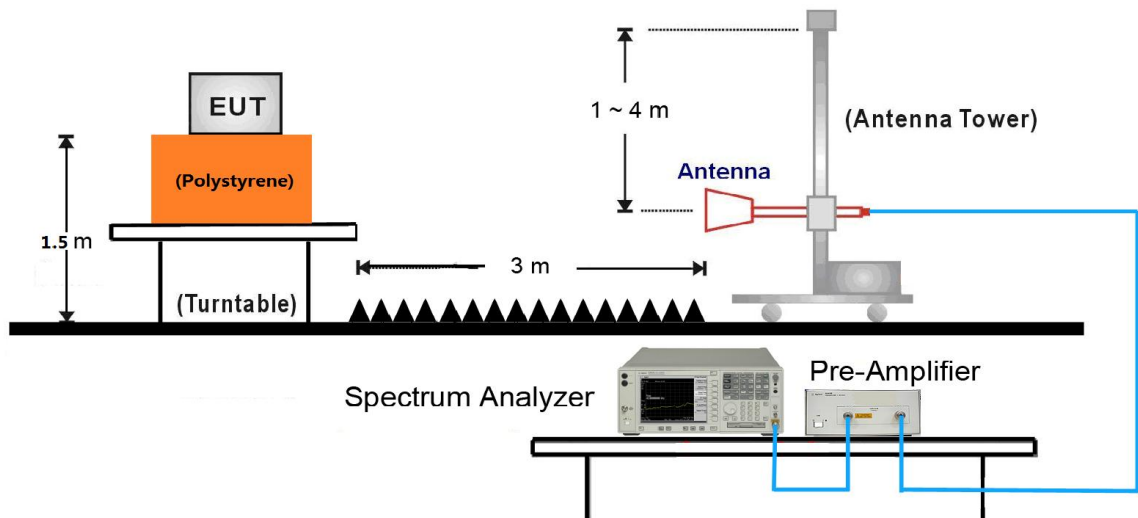

### 7.3.3. Test Result

Test Mode:	Transmission	Test Site:	AC1
Remark:	<b>Fundamental</b> Radiated Emission	Test Engineer:	Bruce Wang

Frequency (MHz)	Reading Level (dB $\mu$ V)	Factor (dB)	Measure Level (dB $\mu$ V/m)	Limit (dB $\mu$ V/m)	Margin (dB)	Detector	Polarization
2419	50.0	31.2	81.2	114.0	-32.8	PK	Horizontal
	44.8	31.2	76.0	114.0	-38.0	PK	Vertical
2450	49.8	31.1	80.9	114.0	-33.1	PK	Horizontal
	39.7	31.1	70.8	114.0	-43.2	PK	Vertical
2474	49.7	31.2	80.9	114.0	-33.1	PK	Horizontal
	41.1	31.2	72.3	114.0	-41.7	PK	Vertical

Note 1: Peak Measure Level (dB $\mu$ V/m) = Reading Level (dB $\mu$ V) + Factor (dB)

Factor (dB) = Cable Loss (dB) + Antenna Factor (dB/m)

Note 2: All readings below 1GHz are peak, above 1GHz are performed with peak and/or average measurements as necessary.

Note 3: Average measurement was not performed when the peak level lower than average limit.

Test Mode:	Transmission	Test Site:	AC1
Remark:	<b>Harmonic Radiated Emission</b>	Test Engineer:	Bruce Wang

Frequency (MHz)	Reading Level (dB $\mu$ V)	Factor (dB)	Measure Level (dB $\mu$ V/m)	Limit (dB $\mu$ V/m)	Margin (dB)	Detector	Polarization
<b>2419MHz</b>							
4842.0	50.1	2.7	52.8	74.0	-21.2	PK	Horizontal
7256.0	41.6	7.9	49.5	74.0	-24.5	PK	Horizontal
4833.5	44.4	2.7	47.1	74.0	-26.9	PK	Vertical
7256.0	34.8	7.9	42.7	74.0	-31.3	PK	Vertical
<b>2450MHz</b>							
4901.5	48.9	2.7	51.6	74.0	-22.4	PK	Horizontal
7349.5	41.9	8.0	49.9	74.0	-24.1	PK	Horizontal
4901.5	43.5	2.7	46.2	74.0	-27.8	PK	Vertical
7349.5	35.5	8.0	43.5	74.0	-30.5	PK	Vertical
<b>2474MHz</b>							
4944.0	48.9	2.8	51.7	74.0	-22.3	PK	Horizontal
7426.0	40.7	8.0	48.7	74.0	-25.3	PK	Horizontal
4952.5	40.2	2.9	43.1	74.0	-30.9	PK	Vertical
7426.0	33.6	8.0	41.6	74.0	-32.4	PK	Vertical

Note 1: Measure Level (dB $\mu$ V/m) = Reading Level (dB $\mu$ V) + Factor (dB)

Factor (dB) = Cable Loss (dB) + Antenna Factor (dB/m) – Pre Amplifier Gain (dB)

Note 2: Average measurement was not performed when the peak level lower than average limit.

Test Mode:	Transmission	Test Site:	AC1
Frequency	2419MHz	Test Engineer:	Bruce Wang
Remark:	<b>General Radiated Emission</b>		

Frequency (MHz)	Reading Level (dB $\mu$ V)	Factor (dB)	Measure Level (dB $\mu$ V/m)	Limit (dB $\mu$ V/m)	Margin (dB)	Detector	Polarization
44.6	-1.8	14.2	12.4	40.0	-27.6	QP	Horizontal
730.4	0.6	22.5	23.1	46.0	-22.9	QP	Horizontal
66.4	7.2	12.2	19.4	40.0	-20.6	QP	Vertical
730.3	1.2	22.5	23.7	46.0	-22.3	QP	Vertical
9857.0	34.2	11.6	45.8	74.0	-28.2	PK	Horizontal
12976.5	34.6	12.1	46.7	74.0	-27.3	PK	Horizontal
10911.0	34.5	13.0	47.5	74.0	-26.5	PK	Vertical
13622.5	35.5	13.9	49.4	74.0	-24.6	PK	Vertical

Note 1: Measure Level (dB $\mu$ V/m) = Reading Level (dB $\mu$ V) + Factor (dB)

Factor (dB) = Cable Loss (dB) + Antenna Factor (dB/m) – Pre Amplifier Gain (dB)

Note 2: Average measurement was not performed when the peak level lower than average limit.

Note 3: The test trace is same as the ambient noise (the test frequency range: 9 kHz ~ 30 MHz and 18 GHz ~ 25 GHz), therefore no data appear in the report.

Note 4: Emissions radiated outside of the specified frequency bands, except for harmonics, shall be attenuated by at least 50 dB below the level of the fundamental or to the general radiated emission limits in §15.209, whichever is the lesser attenuation.

Test Mode:	Transmission	Test Site:	AC1
Frequency	2450MHz	Test Engineer:	Bruce Wang
Remark:	<b>General Radiated Emission</b>		

Frequency (MHz)	Reading Level (dB $\mu$ V)	Factor (dB)	Measure Level (dB $\mu$ V/m)	Limit (dB $\mu$ V/m)	Margin (dB)	Detector	Polarization
46.0	-0.6	14.1	13.5	40.0	-26.5	QP	Horizontal
750.0	1.4	22.7	24.1	46.0	-21.9	QP	Horizontal
66.9	7.6	12.1	19.7	40.0	-20.3	QP	Vertical
713.9	2.3	22.2	24.5	46.0	-21.5	QP	Vertical
10528.5	34.3	12.5	46.8	74.0	-27.2	PK	Horizontal
13444.0	35.7	13.7	49.4	74.0	-24.6	PK	Horizontal
10044.0	34.4	11.6	46.0	74.0	-28.0	PK	Vertical
14022.0	36.3	14.9	51.2	74.0	-22.8	PK	Vertical

Note 1: Measure Level (dB $\mu$ V/m) = Reading Level (dB $\mu$ V) + Factor (dB)

Factor (dB) = Cable Loss (dB) + Antenna Factor (dB/m) – Pre Amplifier Gain (dB)

Note 2: Average measurement was not performed when the peak level lower than average limit.

Note 3: The test trace is same as the ambient noise (the test frequency range: 9 kHz ~ 30 MHz and 18 GHz ~ 25 GHz), therefore no data appear in the report.

Note 4: Emissions radiated outside of the specified frequency bands, except for harmonics, shall be attenuated by at least 50 dB below the level of the fundamental or to the general radiated emission limits in §15.209, whichever is the lesser attenuation.

Test Mode:	Transmission	Test Site:	AC1
Frequency	2474MHz	Test Engineer:	Bruce Wang
Remark:	<b>General Radiated Emission</b>		

Frequency (MHz)	Reading Level (dB $\mu$ V)	Factor (dB)	Measure Level (dB $\mu$ V/m)	Limit (dB $\mu$ V/m)	Margin (dB)	Detector	Polarization
577.7	1.4	20.0	21.4	46.0	-24.6	QP	Horizontal
768.6	1.6	22.9	24.5	46.0	-21.5	QP	Horizontal
70.3	2.8	11.5	14.3	40.0	-25.7	QP	Vertical
695.6	1.2	21.9	23.1	46.0	-22.9	QP	Vertical
10494.5	33.6	12.4	46.0	74.0	-28.0	PK	Horizontal
14710.5	37.0	15.6	52.6	74.0	-21.4	PK	Horizontal
10384.0	33.5	12.3	45.8	74.0	-28.2	PK	Vertical
13750.0	35.2	14.2	49.4	74.0	-24.6	PK	Vertical

Note 1: Measure Level (dB $\mu$ V/m) = Reading Level (dB $\mu$ V) + Factor (dB)

Factor (dB) = Cable Loss (dB) + Antenna Factor (dB/m) – Pre Amplifier Gain (dB)

Note 2: Average measurement was not performed when the peak level lower than average limit.

Note 3: The test trace is same as the ambient noise (the test frequency range: 9 kHz ~ 30 MHz and 18 GHz ~ 25 GHz), therefore no data appear in the report.

Note 4: Emissions radiated outside of the specified frequency bands, except for harmonics, shall be attenuated by at least 50 dB below the level of the fundamental or to the general radiated emission limits in §15.209, whichever is the lesser attenuation.



## 7.4. Radiated Restricted Band Edge Measurement

### 7.4.1. Test Result

Site: AC1	Time: 2017/09/16 - 14:04
Limit: FCC_Part15.209_RE(3m)	Engineer: Bruce Wang
Probe: BBHA9120D_1-18GHz	Polarity: Horizontal
EUT: 70122	Power: DC 3V
Test Mode: Transmit at low channel 2419MHz	

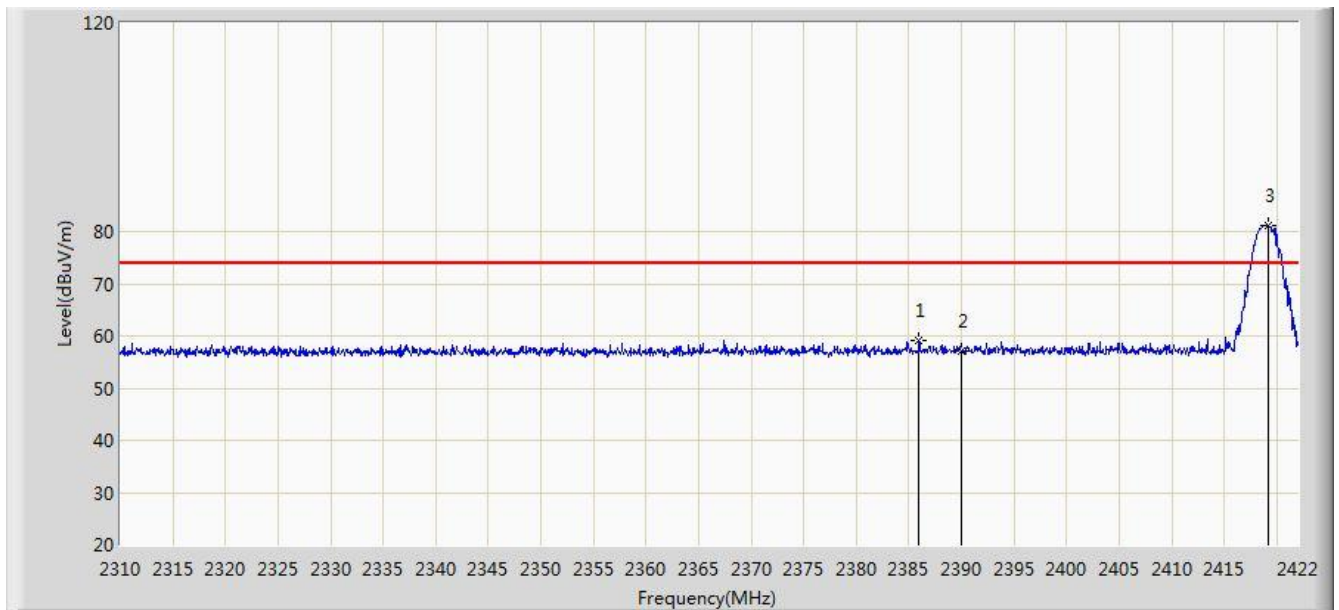

No	Flag	Mark	Frequency (MHz)	Measure Level (dBuV/m)	Reading Level (dBuV)	Over Limit (dB)	Limit (dBuV/m)	Factor (dB)	Type
1			2385.992	59.145	27.935	-14.855	74.000	31.210	PK
2			2390.000	57.097	25.894	-16.903	74.000	31.203	PK
3		*	2419.144	81.204	50.047	7.204	74.000	31.157	PK

Note: Peak Measure Level (dBuV/m) = Reading Level (dBuV) + Factor (dB)

Factor (dB) = Cable Loss (dB) + Antenna Factor (dB/m)

Site: AC1	Time: 2017/09/16 - 14:27
Limit: FCC_Part15.209_RE(3m)	Engineer: Bruce Wang
Probe: BBHA9120D_1-18GHz	Polarity: Horizontal
EUT: 70122	Power: DC 3V
Test Mode: Transmit at low channel 2419MHz	

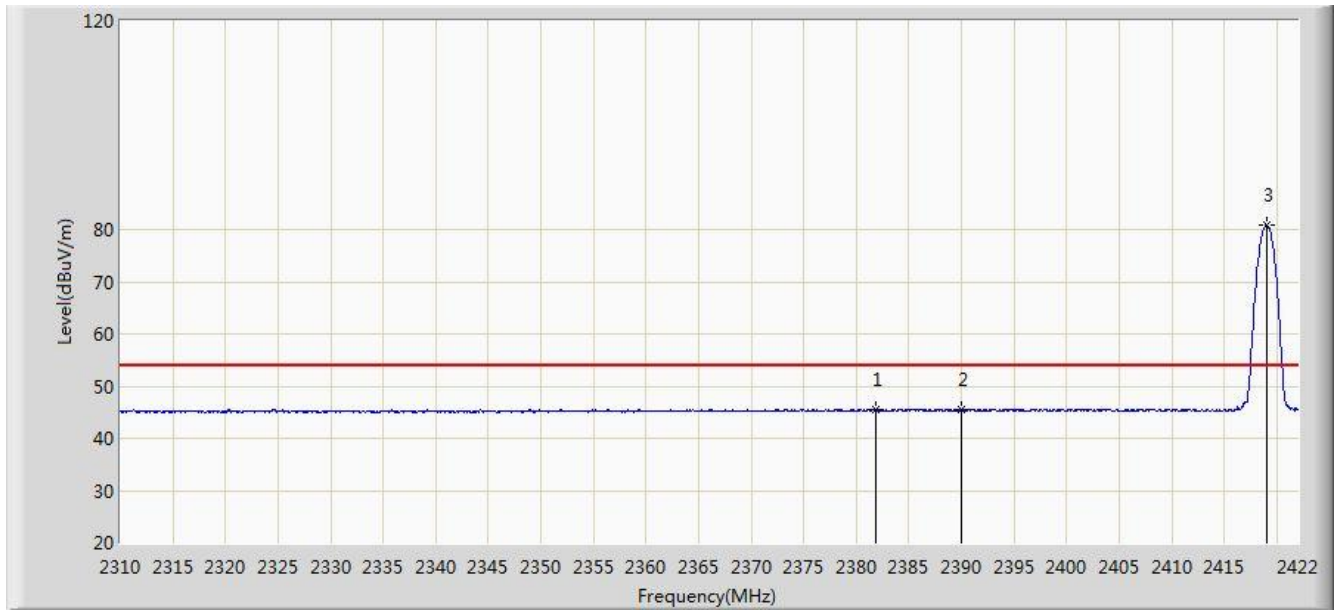

No	Flag	Mark	Frequency (MHz)	Measure Level (dBuV/m)	Reading Level (dBuV)	Over Limit (dB)	Limit (dBuV/m)	Factor (dB)	Type
1			2381.904	45.582	14.364	-8.418	54.000	31.218	AV
2			2390.000	45.487	14.284	-8.513	54.000	31.203	AV
3		*	2419.088	80.803	49.646	26.803	54.000	31.157	AV

Note: Peak Measure Level (dBuV/m) = Reading Level (dBuV) + Factor (dB)

Factor (dB) = Cable Loss (dB) + Antenna Factor (dB/m)

Site: AC1	Time: 2017/09/16 - 14:28
Limit: FCC_Part15.209_RE(3m)	Engineer: Bruce Wang
Probe: BBHA9120D_1-18GHz	Polarity: Vertical
EUT: 70122	Power: DC 3V
Test Mode: Transmit at low channel 2419MHz	

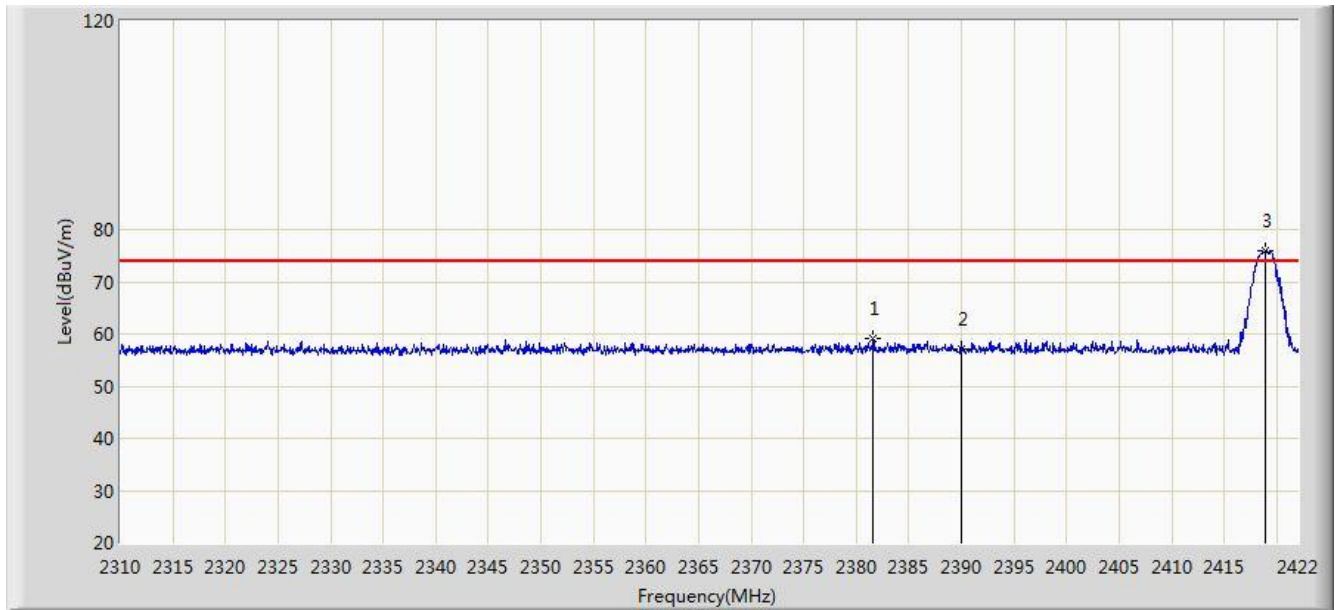

No	Flag	Mark	Frequency (MHz)	Measure Level (dBuV/m)	Reading Level (dBuV)	Over Limit (dB)	Limit (dBuV/m)	Factor (dB)	Type
1			2381.624	59.121	27.903	-14.879	74.000	31.219	PK
2			2390.000	57.040	25.837	-16.960	74.000	31.203	PK
3		*	2418.920	75.976	44.818	1.976	74.000	31.157	PK

Note: Peak Measure Level (dB $\mu$ V/m) = Reading Level (dB $\mu$ V) + Factor (dB)

Factor (dB) = Cable Loss (dB) + Antenna Factor (dB/m)

Site: AC1	Time: 2017/09/16 - 14:31
Limit: FCC_Part15.209_RE(3m)	Engineer: Bruce Wang
Probe: BBHA9120D_1-18GHz	Polarity: Vertical
EUT: 70122	Power: DC 3V
Test Mode: Transmit at low channel 2419MHz	

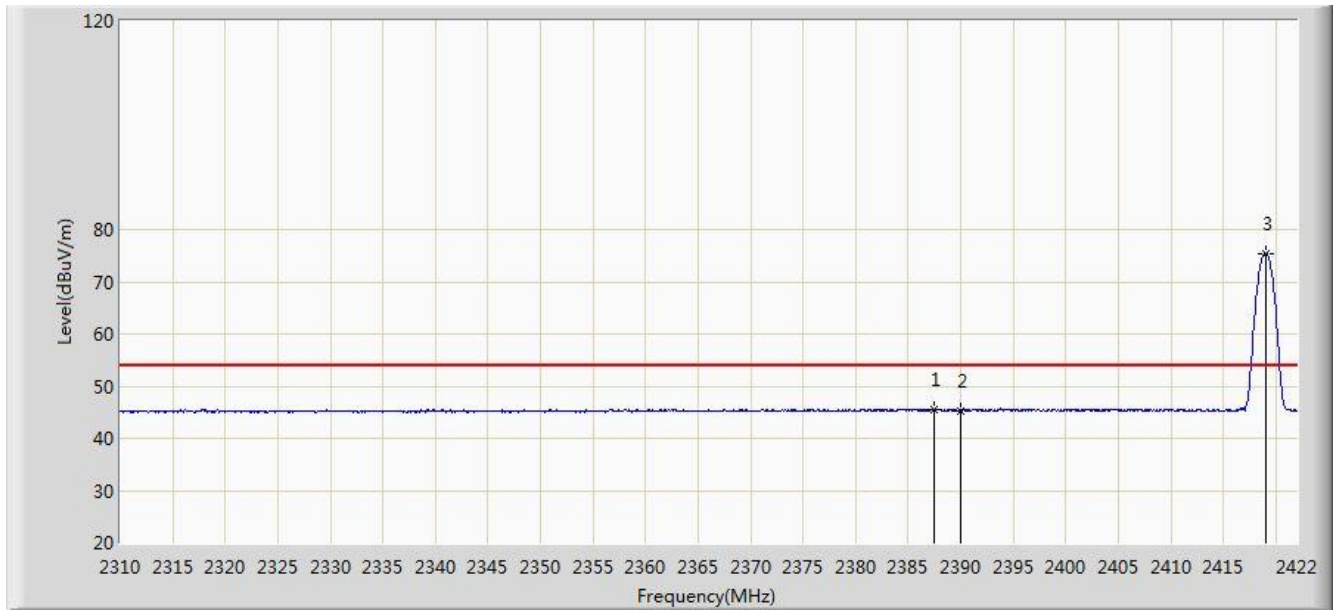

No	Flag	Mark	Frequency (MHz)	Measure Level (dBuV/m)	Reading Level (dBuV)	Over Limit (dB)	Limit (dBuV/m)	Factor (dB)	Type
1			2387.448	45.613	14.406	-8.387	54.000	31.207	AV
2			2390.000	45.346	14.143	-8.654	54.000	31.203	AV
3		*	2419.088	75.502	44.345	21.502	54.000	31.157	AV

Note: Peak Measure Level (dB $\mu$ V/m) = Reading Level (dB $\mu$ V) + Factor (dB)

Factor (dB) = Cable Loss (dB) + Antenna Factor (dB/m)

Site: AC1	Time: 2017/09/16 - 14:32
Limit: FCC_Part15.209_RE(3m)	Engineer: Bruce Wang
Probe: BBHA9120D_1-18GHz	Polarity: Horizontal
EUT: 70122	Power: DC 3V
Test Mode: Transmit at high channel 2474MHz	

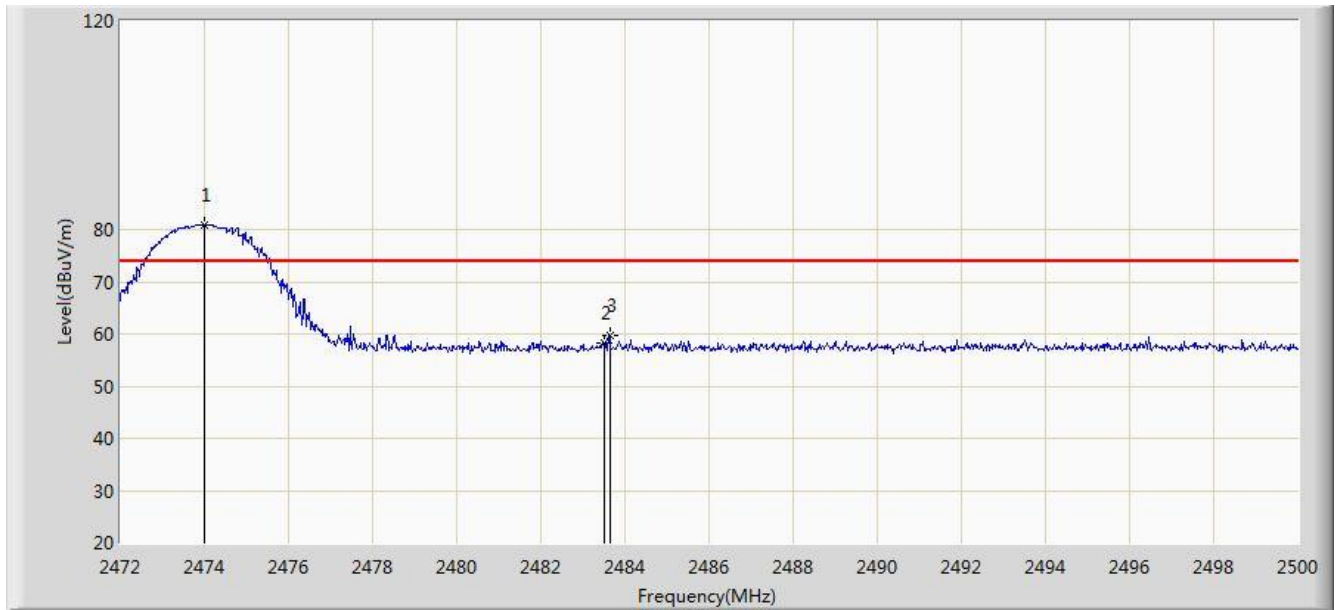

No	Flag	Mark	Frequency (MHz)	Measure Level (dBuV/m)	Reading Level (dBuV)	Over Limit (dB)	Limit (dBuV/m)	Factor (dB)	Type
1		*	2474.008	80.852	49.685	6.852	74.000	31.167	PK
2			2483.500	58.394	27.201	-15.606	74.000	31.194	PK
3			2483.632	59.756	28.562	-14.244	74.000	31.194	PK

Note: Peak Measure Level (dBuV/m) = Reading Level (dBuV) + Factor (dB)

Factor (dB) = Cable Loss (dB) + Antenna Factor (dB/m)

Site: AC1	Time: 2017/09/16 - 14:45
Limit: FCC_Part15.209_RE(3m)	Engineer: Bruce Wang
Probe: BBHA9120D_1-18GHz	Polarity: Horizontal
EUT: 70122	Power: DC 3V
Test Mode: Transmit at high channel 2474MHz	

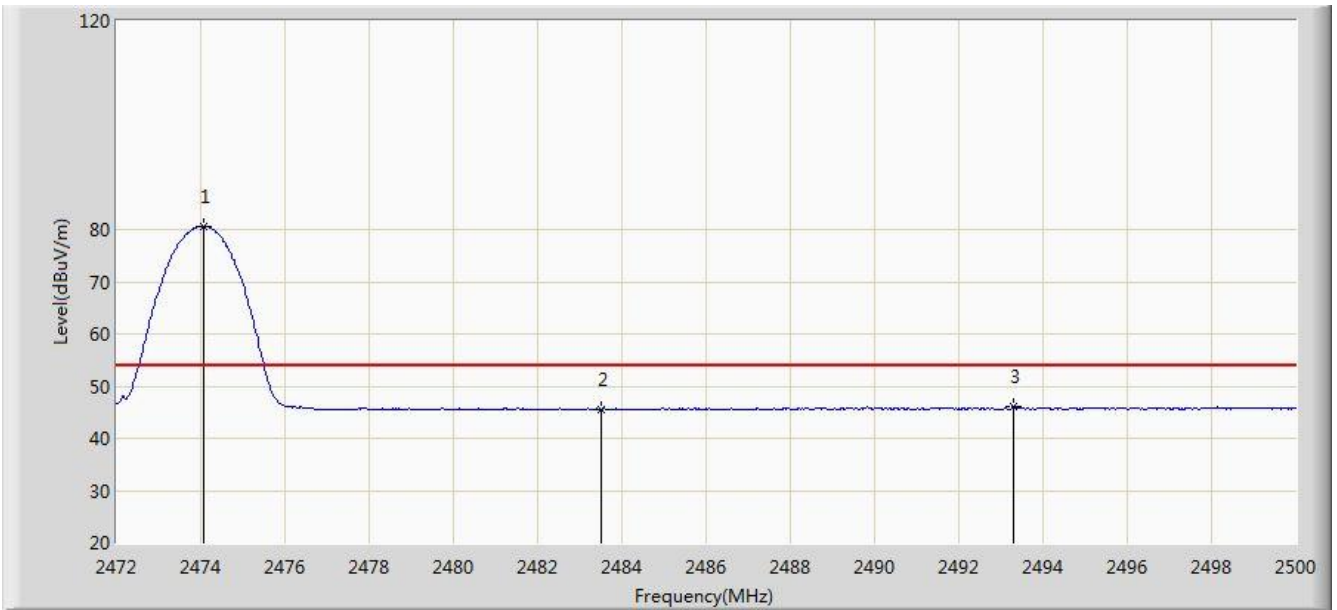

No	Flag	Mark	Frequency (MHz)	Measure Level (dBuV/m)	Reading Level (dBuV)	Over Limit (dB)	Limit (dBuV/m)	Factor (dB)	Type
1		*	2474.080	80.603	49.435	26.603	54.000	31.168	AV
2			2483.500	45.611	14.418	-8.389	54.000	31.194	AV
3			2493.304	46.027	14.808	-7.973	54.000	31.219	AV

Note: Peak Measure Level (dB $\mu$ V/m) = Reading Level (dB $\mu$ V) + Factor (dB)

Factor (dB) = Cable Loss (dB) + Antenna Factor (dB/m)

Site: AC1	Time: 2017/09/16 - 14:46
Limit: FCC_Part15.209_RE(3m)	Engineer: Bruce Wang
Probe: BBHA9120D_1-18GHz	Polarity: Vertical
EUT: 70122	Power: DC 3V
Test Mode: Transmit at high channel 2474MHz	

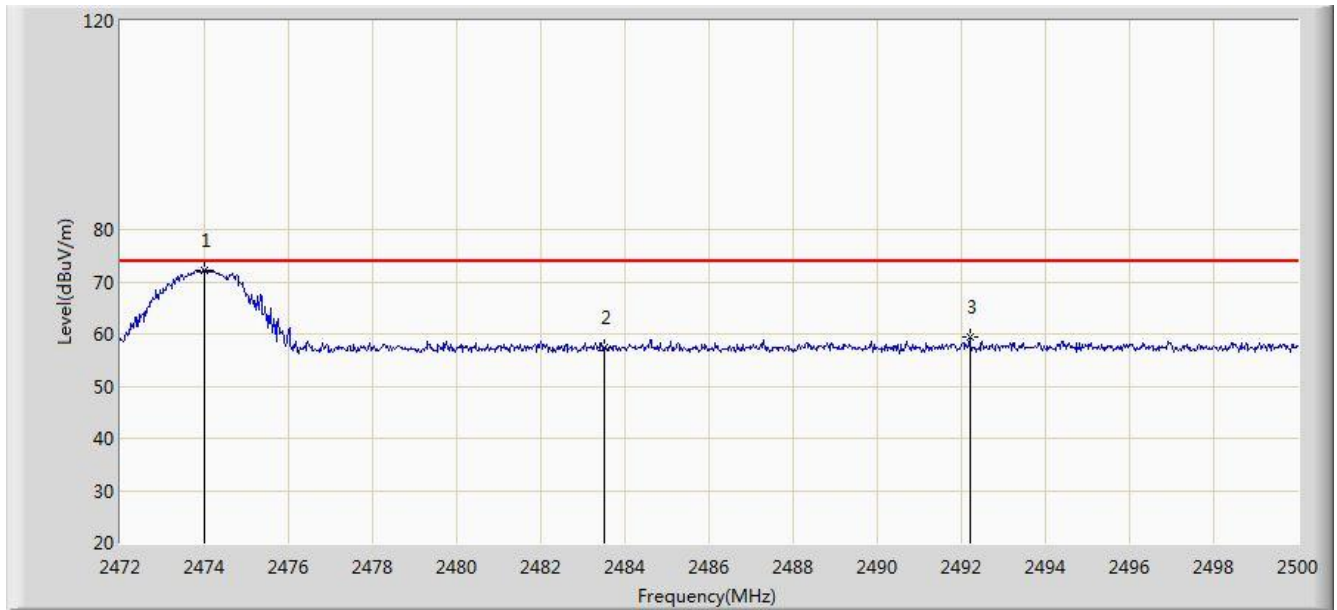

No	Flag	Mark	Frequency (MHz)	Measure Level (dBuV/m)	Reading Level (dBuV)	Over Limit (dB)	Limit (dBuV/m)	Factor (dB)	Type
1		*	2473.984	72.262	41.095	-1.738	74.000	31.167	PK
2			2483.500	57.431	26.238	-16.569	74.000	31.194	PK
3			2492.200	59.432	28.216	-14.568	74.000	31.216	PK

Note: Peak Measure Level (dB $\mu$ V/m) = Reading Level (dB $\mu$ V) + Factor (dB)

Factor (dB) = Cable Loss (dB) + Antenna Factor (dB/m)

Site: AC1	Time: 2017/09/16 - 14:52
Limit: FCC_Part15.209_RE(3m)	Engineer: Bruce Wang
Probe: BBHA9120D_1-18GHz	Polarity: Vertical
EUT: 70122	Power: DC 3V
Test Mode: Transmit at high channel 2474MHz	

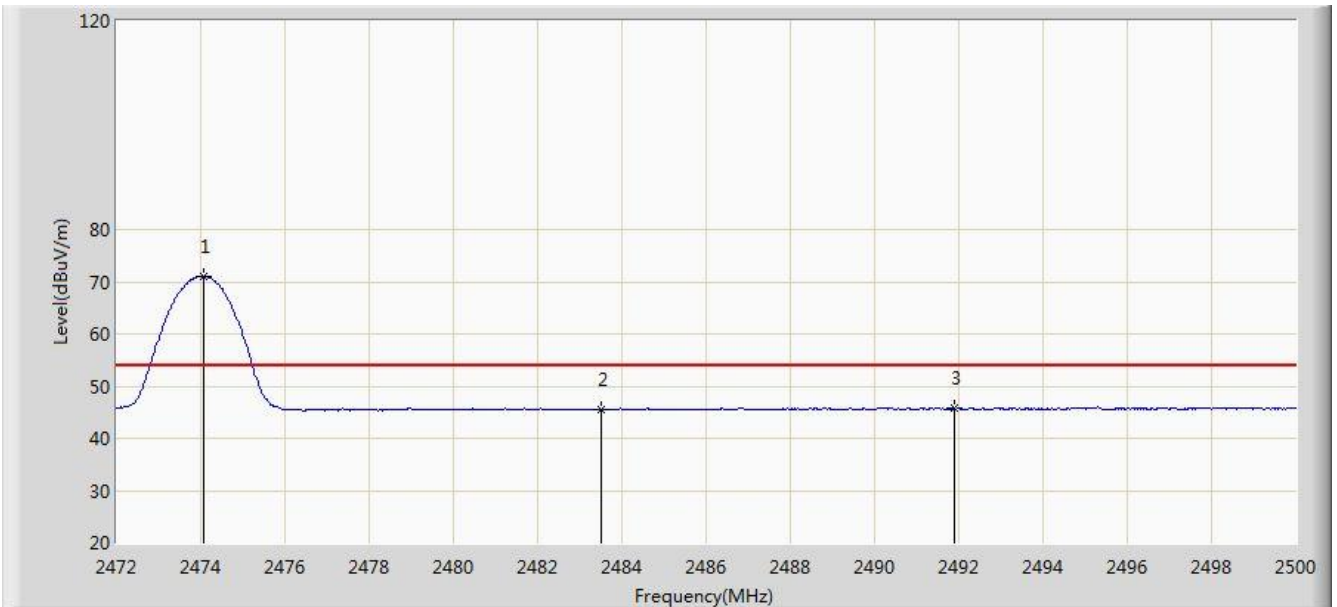

No	Flag	Mark	Frequency (MHz)	Measure Level (dBuV/m)	Reading Level (dBuV)	Over Limit (dB)	Limit (dBuV/m)	Factor (dB)	Type
1		*	2474.056	71.117	39.949	17.117	54.000	31.168	AV
2			2483.500	45.486	14.293	-8.514	54.000	31.194	AV
3			2491.912	45.846	14.631	-8.154	54.000	31.216	AV

Note: Peak Measure Level (dB $\mu$ V/m) = Reading Level (dB $\mu$ V) + Factor (dB)

Factor (dB) = Cable Loss (dB) + Antenna Factor (dB/m)



## 7.5. 20dB Spectrum Bandwidth Measurement

### 7.5.1. Test Limit

Intentional radiators must be designed to ensure that the 20 dB bandwidth of the emission in the specific band (2419 ~ 2474).

### 7.5.2. Test Procedure used

ANSI C63.10 Clause 6.9.2

### 7.5.3. Test Setting

1. Set the spectrum span range to overlap the nominal center frequency
2. Set RBW = 100 kHz
3. VBW  $\geq 3 \times$  RBW
4. Detector = Peak
5. Trace mode = max hold
6. Sweep = auto couple
7. Allow the trace was allowed to stabilize and marker the highest level.
8. Determine the display level (the highest level - 20dB) and place two markers, one at the lowest frequency and the other at the highest frequency.

### 7.5.4. Test Setup

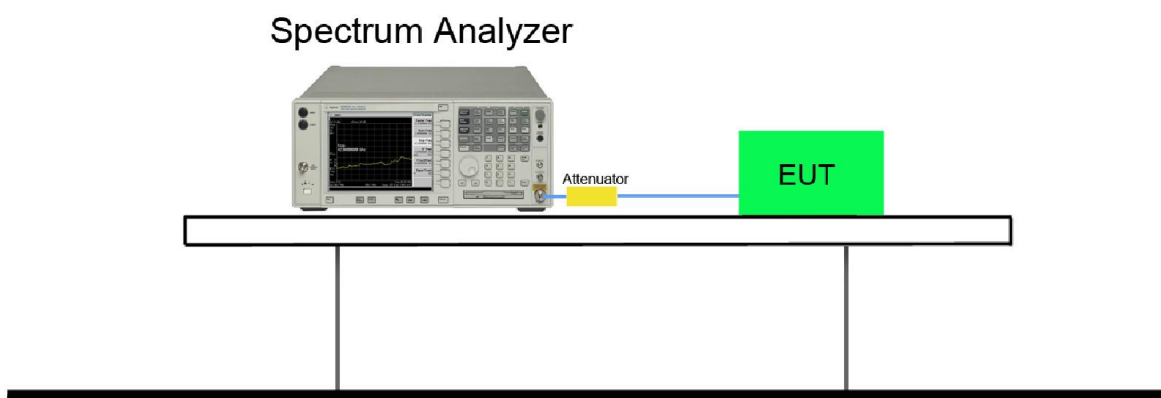

### 7.5.5. Test Result

Frequency (MHz)	Frequency Range (MHz)	Frequency Range (MHz)	Result
2419	2416.405	---	Pass
2474	---	2476.130	Pass

#### 20dB Spectrum Bandwidth

##### 2419 MHz



##### 2474 MHz



## 7.6. 99% Bandwidth Measurement

### 7.6.1. Test Limit

N/A

### 7.6.2. Test Procedure used

ANSI C63.10 Section 6.9

### 7.6.3. Test Setting

1. The analyzers' automatic bandwidth measurement capability was used to perform the 99% bandwidth measurement. The bandwidth measurement was not influenced by any intermediated power nulls in the fundamental emission.
2. RBW = approximately 1% to 5% of the OBW.
3. VBW  $\geq 3 \times$  RBW.
4. Detector = Peak.
5. Trace mode = max hold.

### 7.6.4. Test Setup

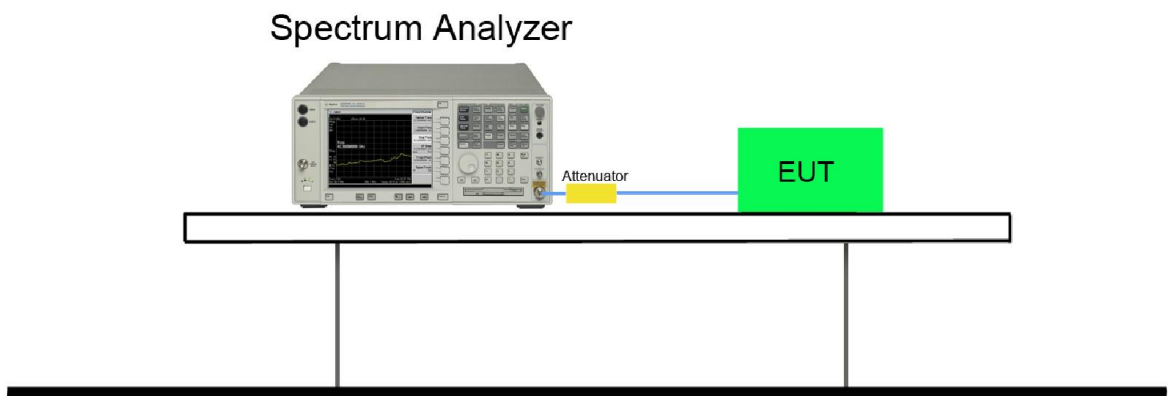

### 7.6.5. Test Result

Frequency (MHz)	99% Bandwidth (MHz)
2419	4.809
2450	4.277
2474	3.639

### 99% Occupied Bandwidth

#### 2419 MHz



#### 2450 MHz



#### 2474 MHz

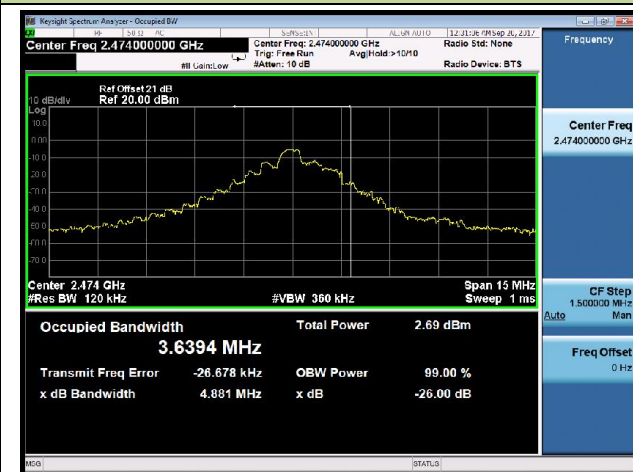

## 8. CONCLUSION

The data collected relate only the item(s) tested and show that the **PROSTROBE QUADSTROBZ DUAL FCC ID: 2AMN5-70122** is in compliance with Part 15C of the FCC Rules.

\_\_\_\_\_ The End \_\_\_\_\_