



# SGS-CSTC Standards Technical Services (Shanghai) Co., Ltd.

588 West Jindu Road, Xinqiao, Songjiang, 201612 Shanghai, China  
Telephone: +86 (0) 21 6191 5666  
Fax: +86 (0) 21 6191 5678  
ee.shanghai@sgs.com

Report No.: SHEM170400212703  
Page: 1 of 74

## 1 Cover Page

# FCC Part 15E TEST REPORT

|                                                                                                                               |                             |
|-------------------------------------------------------------------------------------------------------------------------------|-----------------------------|
| <b>Application No.:</b>                                                                                                       | SHEM1704002127CR            |
| <b>Applicant:</b>                                                                                                             | Apollo Tech USA Inc.        |
| <b>FCC ID:</b>                                                                                                                | 2AML4-MOCAM720              |
| <b>Equipment Under Test (EUT):</b><br><b>NOTE:</b> The following sample(s) was/were submitted and identified by the client as |                             |
| <b>Product Name:</b>                                                                                                          | Dual Band Wifi Video Camera |
| <b>Model No.(EUT):</b>                                                                                                        | MOCAM-720-01                |
| <b>Add Model No.:</b>                                                                                                         | MOGA-001                    |
| <b>Standards:</b>                                                                                                             | FCC PART 15 Subpart E: 2016 |
| <b>Date of Receipt:</b>                                                                                                       | 2017-04-17                  |
| <b>Date of Test:</b>                                                                                                          | 2017-06-13 to 2017-06-16    |
| <b>Date of Issue:</b>                                                                                                         | 2017-06-16                  |
| <b>Test Result:</b>                                                                                                           | <b>Pass*</b>                |

\*In the configuration tested, the EUT detailed in this report complied with the standards specified above.



**Parlam Zhan**  
**E&E Section Manager**  
**SGS-CSTC (Shanghai) Co., Ltd.**

The manufacturer should ensure that all products in series production are in conformity with the product sample detailed in this report. If the product in this report is used in any configuration other than that detailed in the report, the manufacturer must ensure the new system complies with all relevant standards. Any mention of SGS International Electrical Approvals or testing done by SGS International Electrical Approvals in connection with, distribution or use of the product described in this report must be approved by SGS International Electrical Approvals in writing.

This document is issued by the Company subject to its General Conditions of Service printed overleaf, available on request or accessible at [www.sgs.com/terms\\_and\\_conditions.htm](http://www.sgs.com/terms_and_conditions.htm) and, for electronic format documents, subject to Terms and Conditions for Electronic Documents at [www.sgs.com/terms\\_e-document.htm](http://www.sgs.com/terms_e-document.htm). Attention is drawn to the limitation of liability, indemnification and jurisdiction issues defined therein. Any holder of this document is advised that information contained hereon reflects the Company's findings at the time of its intervention only and within the limits of Client's instructions, if any. The Company's sole responsibility is to its Client and this document does not exonerate parties to a transaction from exercising all their rights and obligations under the transaction. documents. This document cannot be reproduced except in full, without prior written approval of the Company. Any unauthorized alteration, forgery or falsification of the content or appearance of this document is unlawful and offenders may be prosecuted to the fullest extent of the law. Unless otherwise stated the results shown in this test report refer only to the sample(s) tested and such sample(s) are retained for 90 days only

| <b>Revision Record</b> |                |             |                 |               |
|------------------------|----------------|-------------|-----------------|---------------|
| <b>Version</b>         | <b>Chapter</b> | <b>Date</b> | <b>Modifier</b> | <b>Remark</b> |
| 00                     |                | 2017-06-16  |                 | Original      |
|                        |                |             |                 |               |
|                        |                |             |                 |               |

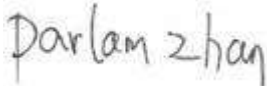
|                                 |                                                                                    |             |  |
|---------------------------------|------------------------------------------------------------------------------------|-------------|--|
| <b>Authorized for issue by:</b> |                                                                                    |             |  |
| <b>Tested By</b>                |   | 2017-06-16  |  |
|                                 | <b>Vincent Zhu /Project Engineer</b>                                               | <b>Date</b> |  |
| <b>Checked By</b>               |  | 2017-06-16  |  |
|                                 | <b>Parlam Zhan /Reviewer</b>                                                       | <b>Date</b> |  |

## 2 Test Summary

| Test Item                                     | FCC Requirement          | Test method                                   | Result                           |
|-----------------------------------------------|--------------------------|-----------------------------------------------|----------------------------------|
| Antenna Requirement                           | 15.203 & 15.407 a(1)&(3) | -                                             | PASS                             |
| AC Power Line Conducted Emission              | 15.407 b(6)              | ANSI C63.10 (2013)<br>Clause 6.2              | PASS                             |
| 26 dB Emission bandwidth                      | 15.403 i                 | KDB 789033 D02<br>KDB 644545<br>KDB662911 D01 | PASS                             |
| Minimum 6 dB bandwidth (5.725-5.85 GHz band ) | 15.407 (e)               |                                               | PASS                             |
| Maximum Conducted output power                | 15.407 a(1)&(3)          |                                               | PASS                             |
| Transmitter Power Control                     | 15.407 (h)(1)            |                                               | N/A                              |
| Peak Power spectrum density                   | 15.407 a(1)&(3)          |                                               | PASS                             |
| Radiated Spurious emissions and Band-edge     | 15.209 & 15.407          |                                               | PASS                             |
| Transmission in the Absence of Data           | 15.407 (c)               |                                               | PASS                             |
| Frequency Stability                           | 15.407 (g)               |                                               | PASS                             |
| Dynamic Frequency Selection                   | 15.407 (h)(2)            |                                               | KDB 905462 D02<br>KDB 905462 D03 |

Notes: N/A: The device no DFS Band.

### 3 Contents

|                                                     | Page      |
|-----------------------------------------------------|-----------|
| <b>1 COVER PAGE.....</b>                            | <b>1</b>  |
| <b>2 TEST SUMMARY .....</b>                         | <b>3</b>  |
| <b>3 CONTENTS .....</b>                             | <b>4</b>  |
| <b>4 GENERAL INFORMATION.....</b>                   | <b>5</b>  |
| 4.1 CLIENT INFORMATION .....                        | 5         |
| 4.2 GENERAL DESCRIPTION OF E.U.T.....               | 5         |
| 4.3 TECHNICAL SPECIFICATIONS.....                   | 5         |
| 4.4 TEST MODE.....                                  | 5         |
| 4.5 TEST CHANNEL .....                              | 6         |
| 4.6 DESCRIPTION OF SUPPORT UNITS.....               | 6         |
| 4.7 TEST LOCATION .....                             | 7         |
| 4.8 TEST FACILITY .....                             | 7         |
| 4.9 MEASUREMENT UNCERTAINTY.....                    | 7         |
| <b>5 EQUIPMENTS USED DURING TEST .....</b>          | <b>8</b>  |
| <b>6 TEST RESULTS .....</b>                         | <b>9</b>  |
| 6.1 E.U.T. TEST CONDITIONS .....                    | 9         |
| 6.2 ANTENNA REQUIREMENT.....                        | 10        |
| 6.3 CONDUCTED EMISSIONS ON MAINS TERMINALS.....     | 11        |
| 6.4 DUTY CYCLE .....                                | 15        |
| 6.5 EMISSION BANDWIDTH .....                        | 16        |
| 6.6 MAXIMUM CONDUCTED OUTPUT POWER .....            | 17        |
| 6.7 PEAK POWER SPECTRAL DENSITY .....               | 18        |
| 6.8 RADIATED SPURIOUS EMISSIONS AND BAND-EDGE ..... | 19        |
| 6.9 TRANSMISSION IN THE ABSENCE OF DATA.....        | 72        |
| 6.10 FREQUENCY STABILITY .....                      | 73        |
| <b>7 TEST SETUP PHOTOGRAPHS.....</b>                | <b>74</b> |
| <b>8 EUT CONSTRUCTIONAL DETAILS.....</b>            | <b>74</b> |

## 4 General Information

### 4.1 Client Information

|                          |                                                                                                                                                                                             |
|--------------------------|---------------------------------------------------------------------------------------------------------------------------------------------------------------------------------------------|
| Applicant:               | Apollo Tech USA Inc.                                                                                                                                                                        |
| Address of Applicant:    | Tech USA Inc. 8608 Utica Ave #220 Rancho Cucamonga, CA 91730                                                                                                                                |
| Manufacturer:            | Apollo Tech USA Inc.                                                                                                                                                                        |
| Address of Manufacturer: | Tech USA Inc. 8608 Utica Ave #220 Rancho Cucamonga, CA 91730                                                                                                                                |
| Factory:                 | 1. Hangzhou Hikvision Technology Co., Ltd.<br>2. Hangzhou Hikvision Electronics Co., Ltd.                                                                                                   |
| Address of Factory:      | 1. No.700, Dongliu Road, Binjiang District, Hangzhou Ctiy,Zhejiang, 310052, China<br>2. No.299, Qiushi Road,Tonglu Economic Development Zone,Tonglu County, Hangzhou,Zhejiang,310052,China. |

### 4.2 General Description of E.U.T.

|                      |                                       |
|----------------------|---------------------------------------|
| Product Description: | Fixed product with 5GHz WiFi function |
| Rated Input:         | DC 5V via adapter                     |
| Test Voltage:        | AC 120V 60Hz for adapter              |

Parameter of adapter:

|          |               |                               |         |
|----------|---------------|-------------------------------|---------|
| Adapter: | Manufacturer: | Mass Power Electronic Limited |         |
|          | Model No.:    | ED1-050100UA                  |         |
|          | Rated Input:  | AC 100~240V, 50/60Hz 0.2A     |         |
|          | Rated Output: | DC 5V 1.0A                    |         |
|          | Cable length: | AC port:                      | 2 wires |
| DC port: |               | 250 cm                        |         |

### 4.3 Technical Specifications

|                       |                                                                                                                                                                           |
|-----------------------|---------------------------------------------------------------------------------------------------------------------------------------------------------------------------|
| Operation Frequency:  | 802.11a/n(HT20)/ac(HT20): 5180-5240MHz, 5745MHz-5825MHz<br>802.11n(HT40)/ac(HT40): 5190-5230MHz, 5755MHz-5795MHz<br>802.11ac(HT80): 5210MHz, 5775MHz                      |
| Modulation Technique: | OFDM(256QAM, 64QAM, 16QAM, QPSK, BPSK)<br>Remark: 256QAM for 802.11 ac only                                                                                               |
| Data Rate:            | 802.11a: 6/9/12/18/24/36/48/54Mbps<br>802.11n: MCS0-7<br>802.11ac: MCS0-9                                                                                                 |
| Number of Channel:    | 802.11 a/n(HT20)/ac(HT20): 9 Channel 36, 40, 44, 48, 149, 153, 157, 161, 165<br>802.11 n(HT40)/ac(HT40): 4 Channel 38, 46, 151, 159<br>802.11 ac(HT80): 2 Channel 42, 155 |
| Antenna Type          | PIFA                                                                                                                                                                      |
| Antenna Gain          | 0.4 dBi                                                                                                                                                                   |

### 4.4 Test Mode

| Test Mode        | Description of Test Mode                                                                                       |
|------------------|----------------------------------------------------------------------------------------------------------------|
| Engineering mode | Using test software to control EUT working in continuous transmitting, and select channel and modulation type. |

#### 4.5 Test Channel

Preliminary tests were performed in all tests in different data rate and antenna configurations at lowest channel, the data rates of worse case as below were chosen for final test.

| Band    | 802.11a        |      |        | 802.11 n(HT20)  |      |      | 802.11n(HT40)  |      |      |
|---------|----------------|------|--------|-----------------|------|------|----------------|------|------|
|         | Channel        | Freq | Rate   | Chan            | Freq | Rate | Channel        | Freq | Rate |
| U-NII 1 | 36             | 5180 | 6 Mbps | 36              | 5180 | MSC0 | 38             | 5190 | MSC0 |
|         | 44             | 5220 | 6 Mbps | 44              | 5220 | MSC0 | -              | -    | -    |
|         | 48             | 5240 | 6 Mbps | 48              | 5240 | MSC0 | 46             | 5230 | MSC0 |
| U-NII 3 | 149            | 5745 | 6 Mbps | 149             | 5745 | MSC0 | 151            | 5755 | MSC0 |
|         | 157            | 5785 | 6 Mbps | 157             | 5785 | MSC0 | -              | -    | -    |
|         | 165            | 5825 | 6Mbps  | 165             | 5825 | MSC0 | 159            | 5795 | MSC0 |
| Band    | 802.11ac(HT20) |      |        | 802.11 ac(HT40) |      |      | 802.11ac(HT80) |      |      |
|         | Channel        | Freq | Rate   | Chan            | Freq | Rate | Channel        | Freq | Rate |
| U-NII 1 | 36             | 5180 | MSC0   | 38              | 5190 | MSC0 | 42             | 5210 | MSC0 |
|         | 44             | 5220 | MSC0   | -               | -    | -    | -              | -    | -    |
|         | 48             | 5240 | MSC0   | 46              | 5230 | MSC0 |                |      |      |
| U-NII 3 | 149            | 5745 | MSC0   | 151             | 5755 |      | 155            | 5775 | MSC0 |
|         | 157            | 5785 | MSC0   | -               | -    | -    | -              | -    | -    |
|         | 165            | 5825 | MSC0   | 159             | 5795 | MSC0 | -              | -    | -    |

#### 4.6 Description of Support Units

The EUT has been tested with support equipments as below.

| Description               | Manufacturer | Model No.      | Supplied By |
|---------------------------|--------------|----------------|-------------|
| Laptop                    | Lenovo       | ThinkPad X100e | SGS         |
| Serial port adapter plate | /            | Test Plate 3   | SGS         |

| Software name | Manufacturer | Version | Supplied By |
|---------------|--------------|---------|-------------|
| SecureCRT     | VanDyke      | V 6.2.0 | SGS         |

#### 4.7 Test Location

All tests were performed at:

SGS-CSTC Standards Technical Services (Shanghai) Co., Ltd.

No.588 West Jindu Road, Songjiang District, Shanghai, China.201612.

Tel: +86 21 6191 5666

Fax: +86 21 6191 5678

#### 4.8 Test Facility

The test facility is recognized, certified, or accredited by the following organizations:

- **CNAS (No. CNAS L0599)**

CNAS has accredited SGS-CSTC Standards Technical Services (Shanghai) Co., Ltd. to ISO/IEC 17025:2005 General Requirements for the Competence of Testing and Calibration Laboratories (CNAS-CL01 Accreditation Criteria for the Competence of Testing and Calibration Laboratories) for the competence in the field of testing.

- **FCC – Registration No.: 402683**

SGS-CSTC Standards Technical Services (Shanghai) Co., Ltd. has been registered and fully described in a report filed with the Federal Communications Commission (FCC). The acceptance letter from the FCC is maintained in our files. Registration No.: 402683.

- **Industry Canada (IC) – IC Assigned Code: 8617A**

The 3m Semi-anechoic chamber of SGS-CSTC Standards Technical Services (Shanghai) Co., Ltd. has been registered by Certification and Engineering Bureau of Industry Canada for radio equipment testing with Registration No.: 8617A-1.

- **VCCI (Member No.: 3061)**

The 3m Semi-anechoic chamber and Shielded Room of SGS-CSTC Standards Technical Services (Shanghai) Co., Ltd. has been registered in accordance with the Regulations for Voluntary Control Measures with Registration No.: R-3868 and C-4336 respectively.

#### 4.9 Measurement Uncertainty

| No. | Parameter                     | Measurement Uncertainty                                  |
|-----|-------------------------------|----------------------------------------------------------|
| 1   | Radio Frequency               | $< \pm 1 \times 10^{-5}$                                 |
| 2   | Total RF power, conducted     | $< \pm 1.5$ dB                                           |
| 3   | RF power density, conducted   | $< \pm 3$ dB                                             |
| 4   | Spurious emissions, conducted | $< \pm 3$ dB                                             |
| 5   | All emissions, radiated       | $< \pm 6$ dB (30MHz – 1GHz)<br>$< \pm 6$ dB (above 1GHz) |
| 6   | Temperature                   | $< \pm 1^{\circ}\text{C}$                                |
| 7   | Humidity                      | $< \pm 5$ %                                              |
| 8   | DC and low frequency voltages | $< \pm 3$ %                                              |

## 5 Equipments Used during Test

| Item | Test Equipment                               | Manufacturer                   | Model No.                        | Serial No.                           | Cal. Date  | Cal. Due date |
|------|----------------------------------------------|--------------------------------|----------------------------------|--------------------------------------|------------|---------------|
| 1    | Power meter                                  | Rohde & Schwarz                | NRP                              | 101641                               | 2017-01-14 | 2018-01-13    |
| 2    | Power Sensor                                 | Rohde & Schwarz                | NRP-Z22                          | 101096                               | 2016-08-06 | 2017-08-05    |
| 3    | Spectrum Analyzer                            | Rohde & Schwarz                | FSP-30                           | 2705121009                           | 2017-01-14 | 2018-01-13    |
| 4    | EMI test receiver                            | Rohde & Schwarz                | ESU40                            | 100109                               | 2017-02-13 | 2018-01-15    |
| 5    | Active Loop Antenna<br>(9kHz to 30MHz)       | Rohde & Schwarz                | FMZB1519                         | 1519-034                             | 2017-02-13 | 2018-01-15    |
| 6    | Broadband UHF-VHF<br>ANTENNA (25MHz to 2GHz) | SCHWARZBECK                    | VULB9168                         | 9168-313                             | 2017-02-13 | 2018-01-15    |
| 7    | Ultra broadband antenna<br>(25MHz to 3GHz)   | Rohde & Schwarz                | HL562                            | 100227                               | 2016-08-30 | 2017-08-29    |
| 8    | Horn Antenna (1GHz to 18GHz)                 | Rohde & Schwarz                | HF906                            | 100284                               | 2017-02-13 | 2018-01-15    |
| 9    | Horn Antenna (1GHz to 18GHz)                 | SCHWARZBECK                    | BBHA9120D                        | 9120D-679                            | 2017-02-13 | 2018-01-15    |
| 10   | Horn Antenna(14GHz to 40GHz)                 | SCHWARZBECK                    | BBHA 9170                        | BBHA917-0373                         | 2017-02-13 | 2018-01-15    |
| 11   | Pre-amplifier (9KHz – 2GHz)                  | LNA6900                        | TESEQ                            | 71033                                | /          | /             |
| 12   | Pre-amplifier (1GHz – 26.5GHz)               | SCHWARZBECK                    | SCU-F0118-<br>G40-BZ4-<br>CSS(F) | 10001                                | 2017-01-14 | 2018-01-13    |
| 13   | Pre-amplifie (14GHz – 40GHz)                 | SCHWARZBECK                    | SCU-F1840-<br>G35-BZ3-<br>CSS(F) | 10001                                | 2017-01-14 | 2018-01-13    |
| 14   | Tunable Notch Filter                         | Wainwright<br>instruments Gmbh | WRCT800.0/880<br>.0-0.2/40-5SSK  | 170397<br>169777<br>169780<br>192507 | /          | /             |
| 15   | High pass Filter                             | FSCW                           | HP 12/2800-<br>5AA2              | 19A45-02                             | /          | /             |
| 16   | High-low temperature cabinet                 | Suzhou Zhihe                   | TL-40                            | 50110050                             | 2016-09-11 | 2017-09-10    |
| 17   | AC power stabilizer                          | WOCEN                          | 6100                             | 51122                                | 2017-01-14 | 2018-01-13    |
| 18   | DC power                                     | QJE                            | QJ30003SII                       | 3573/4/3                             | 2017-01-14 | 2018-01-13    |
| 19   | Signal Generator (Interferer)                | Rohde & Schwarz                | SMR40                            | 100555                               | 2016-08-13 | 2017-08-12    |
| 20   | Signal Generator (Blocker)                   | Rohde & Schwarz                | SMJ100A                          | 101394                               | 2017-01-14 | 2018-01-13    |
| 21   | Splitter                                     | Anritsu                        | MA1612A                          | M12265                               | /          | /             |
| 22   | Coupler                                      | e-meca                         | 803-S-1                          | 900-M01                              | /          | /             |



## 6 Test Results

### 6.1 E.U.T. Test Conditions

**Requirements:** 15.31(e) For intentional radiators, measurements of the variation of the input power or the radiated signal level of the fundamental frequency component of the emission, as appropriate, shall be performed with the supply voltage varied between 85% and 115% of the nominal rated supply voltage. For battery operated equipment, the equipment tests shall be performed using a new battery.

|                               |                       |                 |
|-------------------------------|-----------------------|-----------------|
| <b>Operating Environment:</b> | Temperature:          | 20.0 -25.0 °C   |
|                               | Humidity:             | 35-75 % RH      |
|                               | Atmospheric Pressure: | 99.2 -102.0 kPa |

**Test frequencies:** According to the 15.31(m) Measurements on intentional radiators or receivers, other than TV broadcast receivers, shall be performed and, if required, reported for each band in which the device can be operated with the device operating at the number of frequencies in each band specified in the following table:

| Frequency range over which device operates | Number of frequencies | Location in the range of operation          |
|--------------------------------------------|-----------------------|---------------------------------------------|
| 1 MHz or less                              | 1                     | Middle                                      |
| 1 to 10 MHz                                | 2                     | 1 near top and 1 near bottom                |
| More than 10 MHz                           | 3                     | 1 near top, 1 near middle and 1 near bottom |

Pursuant to Part 15.31(c) For swept frequency equipment, measurements shall be made with the frequency sweep stopped at those frequencies chosen for the measurements to be reported

## 6.2 Antenna Requirement

### Standard requirement:

#### 15.203 requirement:

An intentional radiator shall be designed to ensure that no antenna other than that furnished by the responsible party shall be used with the device. The use of a permanently attached antenna or of an antenna that uses a unique coupling to the intentional radiator, the manufacturer may design the unit so that a broken antenna can be replaced by the user, but the use of a standard antenna jack or electrical connector is prohibited.

This requirement does not apply to carrier current devices. Further, this requirement does not apply to intentional radiators that must be professionally installed, such as perimeter protection systems and some field disturbance sensors, or to other intentional radiators which, in accordance with §15.31(d), must be measured at the installation site. However, the installer shall be responsible for ensuring that the proper antenna is employed so that the limits in this part are not exceeded.

### EUT Antenna:

The antenna is PIFA Antenna. The gain is less than 0.4 dBi.



### 6.3 Conducted Emissions on Mains Terminals

**Frequency Range:** 150 KHz to 30 MHz

**Class/Severity:** Class B

**Limit:**

| Frequency range<br>MHz | Class B Limits: dB (µV) |          |
|------------------------|-------------------------|----------|
|                        | Quasi-peak              | Average  |
| 0.15 to 0.50           | 66 to 56                | 56 to 46 |
| 0.50 to 5              | 56                      | 46       |
| 5 to 30                | 60                      | 50       |

Note1: The limit decreases linearly with the logarithm of the frequency in the range 0.15 MHz to 0.50MHz.  
Note2: The lower limit is applicable at the transition frequency.

**Test site/setup:** Test instrumentation set-up:

| Frequency Range | Detector   | RBW   | VBW   |
|-----------------|------------|-------|-------|
| 9KHz to 150Hz   | Quasi-peak | 200Hz | 500Hz |
| 150KHz to 30MHz | Quasi-peak | 9kHz  | 30kHz |

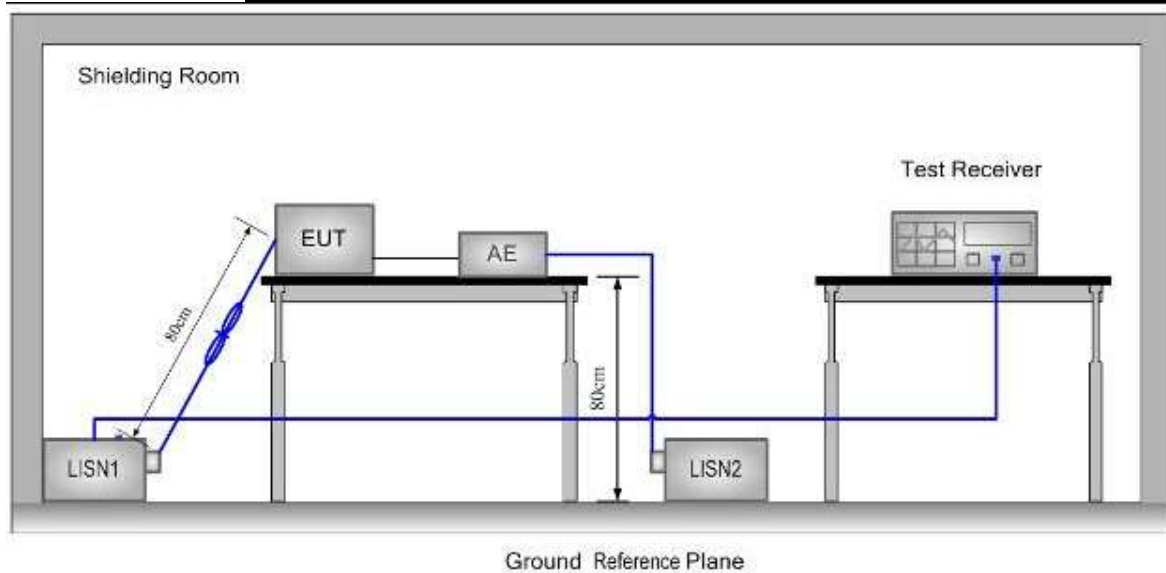

#### Test Procedure:

- The mains terminal disturbance voltage was measured with the EUT in a shielded room.
- The EUT was connected to AC power source through a LISN 1 (Line Impedance Stabilization Network) which provides  $50\Omega/50\mu\text{H} + 5\Omega$  linear impedance. The power cables of all other units of the EUT were connected to a second LISN, which was bonded to the ground reference plane in the same way as the LISN for the unit being measured. A multiple socket outlet strip was used to connect multiple power cables to a single LISN provided the rating of the LISN was not exceeded
- The tabletop EUT was placed upon a non-metallic table 0.8m above the ground reference plane. And for floor-standing arrangement, the EUT was placed on the horizontal ground reference plane, but separated from metallic contact with the ground reference plane by 0.1m of insulation.
- The test was performed with a vertical ground reference plane. The rear of the EUT shall be 0.4 m from the vertical ground reference plane. The vertical ground reference plane was bonded to

the horizontal ground reference plane. The LISN was placed 0.8 m from the boundary of the unit under test and bonded to a ground reference plane for LISN mounted on top of the ground reference plane. This distance was between the closest points of the LISN and the EUT. The mains lead of EUT excess 0.8m was folded back and forth parallel to the lead so as to form a horizontal bundle with a length between 0.3m and 0.4m. All other units of the EUT and associated equipment were at least 0.8 m from the LISN.

Remark: Pre-scan was performed with peak detected on all ports, Quasi-peak & average measurements were performed at the frequencies at which maximum peak emission level were detected. Pretest under all modes; choose the worst case mode (802.11a in Middle channel) record on the report. Please see the attached Quasi-peak and Average test results.

**Test Result:** Pass

**Test Data:**

|                   |              |                      |             |
|-------------------|--------------|----------------------|-------------|
| <b>Test Mode:</b> | 802.11a      | <b>Test Channel:</b> | Channel 157 |
| <b>Test Port:</b> | AC Live Line |                      |             |

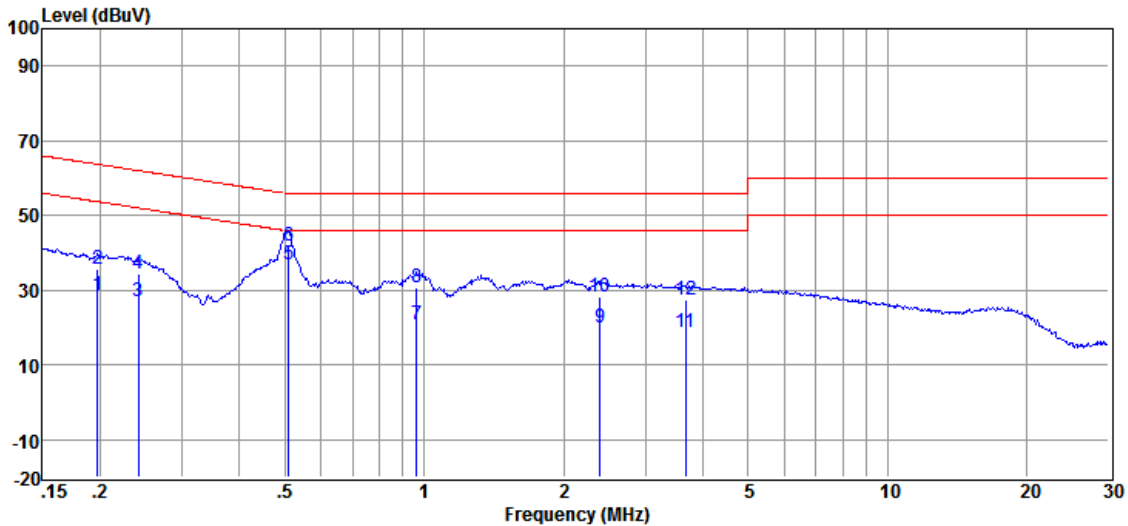

| Item   | Freq. | Read Level | LISN Factor | Cable Loss | Level  | Limit Line | Over Limit | Detector |
|--------|-------|------------|-------------|------------|--------|------------|------------|----------|
| (Mark) | (MHz) | (dBμV)     | (dB)        | (dB)       | (dBμV) | (dBμV)     | (dB)       |          |
| 1      | 0.198 | 18.86      | 0.09        | 9.81       | 28.76  | 53.71      | -24.95     | Average  |
| 2      | 0.198 | 25.95      | 0.09        | 9.81       | 35.85  | 63.71      | -27.86     | QP       |
| 3      | 0.242 | 16.92      | 0.09        | 9.81       | 26.82  | 52.04      | -25.22     | Average  |
| 4      | 0.242 | 24.58      | 0.09        | 9.81       | 34.48  | 62.04      | -27.56     | QP       |
| 5      | 0.510 | 26.84      | 0.10        | 9.82       | 36.76  | 46.00      | -9.24      | Average  |
| 6      | 0.510 | 31.93      | 0.10        | 9.82       | 41.85  | 56.00      | -14.15     | QP       |
| 7      | 0.963 | 10.85      | 0.08        | 9.84       | 20.77  | 46.00      | -25.23     | Average  |
| 8      | 0.963 | 20.72      | 0.08        | 9.84       | 30.64  | 56.00      | -25.36     | QP       |
| 9      | 2.396 | 9.85       | 0.09        | 9.85       | 19.79  | 46.00      | -26.21     | Average  |
| 10     | 2.396 | 18.42      | 0.09        | 9.85       | 28.36  | 56.00      | -27.64     | QP       |
| 11     | 3.661 | 8.63       | 0.13        | 9.85       | 18.61  | 46.00      | -27.39     | Average  |
| 12     | 3.661 | 17.26      | 0.13        | 9.85       | 27.24  | 56.00      | -28.76     | QP       |

**Test Port:** AC Neutral Line

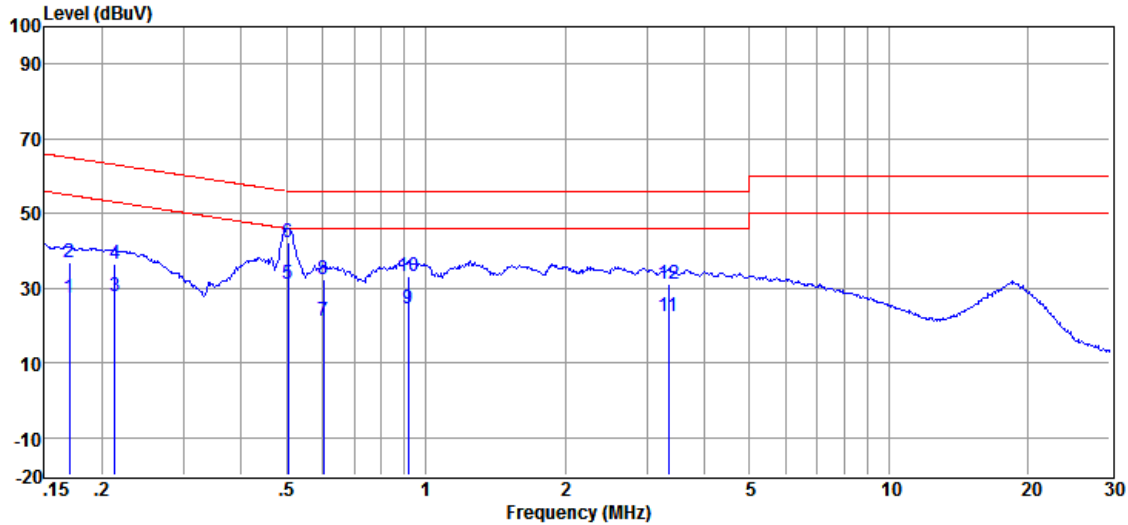

| Item   | Freq. | Read Level | LISN Factor | Cable Loss | Level  | Limit Line | Over Limit | Detector |
|--------|-------|------------|-------------|------------|--------|------------|------------|----------|
| (Mark) | (MHz) | (dBμV)     | (dB)        | (dB)       | (dBμV) | (dBμV)     | (dB)       |          |
| 1      | 0.170 | 17.58      | 0.05        | 9.81       | 27.44  | 54.94      | -27.50     | Average  |
| 2      | 0.170 | 27.19      | 0.05        | 9.81       | 37.05  | 64.94      | -27.89     | QP       |
| 3      | 0.213 | 17.99      | 0.05        | 9.81       | 27.85  | 53.10      | -25.25     | Average  |
| 4      | 0.213 | 26.53      | 0.05        | 9.81       | 36.39  | 63.10      | -26.71     | QP       |
| 5      | 0.505 | 21.41      | 0.04        | 9.82       | 31.27  | 46.00      | -14.73     | Average  |
| 6      | 0.505 | 32.22      | 0.04        | 9.82       | 42.08  | 56.00      | -13.92     | QP       |
| 7      | 0.601 | 11.33      | 0.05        | 9.82       | 21.20  | 46.00      | -24.80     | Average  |
| 8      | 0.601 | 22.31      | 0.05        | 9.82       | 32.18  | 56.00      | -23.82     | QP       |
| 9      | 0.918 | 14.46      | 0.05        | 9.83       | 24.34  | 46.00      | -21.66     | Average  |
| 10     | 0.918 | 23.50      | 0.05        | 9.83       | 33.38  | 56.00      | -22.62     | QP       |
| 11     | 3.346 | 12.68      | 0.13        | 9.85       | 22.66  | 46.00      | -23.34     | Average  |
| 12     | 3.346 | 21.14      | 0.13        | 9.85       | 31.12  | 56.00      | -24.88     | QP       |

Remark: Level = Read Level + LISN/ISN Factor + Cable Loss.

## 6.4 Duty Cycle

In order to assist with the determination of the average level of fundamental and spurious emissions field strength, measurements were made of duty cycle to determine the transmission duration and the silent period time of the transmitter. The transmitter duty cycle was measured using a spectrum analyser in the time domain and calculated by using the following calculation:

Duty cycle = T on time / Period

Duty factor =  $10 * \log (1/\text{Duty cycle})$

If duty cycle of test signal is > 98%, duty factor is not required.

If duty cycle of test signal is < 98%, duty factor shall be considered.

### **Test Data:**

The detailed test data see: Appendix B for SHEM170400212703

## 6.5 Emission Bandwidth

**Test Configuration:**

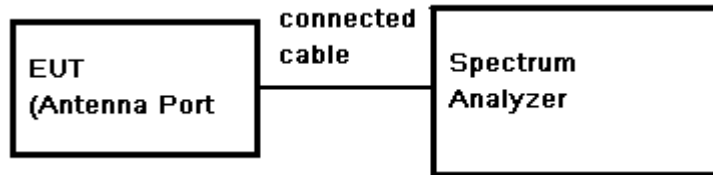

**Test Procedure:**

- a) Place the EUT on the table and set it in transmitting mode.
- b) Remove the antenna from the EUT and then connect a low loss RF cable from the antenna port to the spectrum analyzer.
- c) Set the spectrum analyzer as RBW= approximately 1% of the emission bandwidth or 100KHz(for 5.725-5.85 GHz band), VBW $\geq$ 3\* RBW, Span=40/80/160MHz, Sweep=auto couple
- d) Mark the peak frequency and -6dB (upper and lower) frequency.
- e) Repeat above procedures until all frequency measured was complete.

**Limit:**  $\geq$  500 kHz (For 5.725-5.85 GHz band)

**Test Result:** Pass

**Test Data:**

The detailed test data see: Appendix B for SHEM170400212703



## 6.6 Maximum Conducted output power

Test Setup:

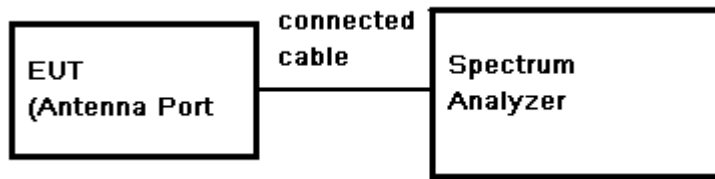

Test Procedure:

- a) Place the EUT on the table and set it in transmitting mode.
- b) Remove the antenna from the EUT and then connect a low loss RF cable from the antenna port to the spectrum.
- c) Set the spectrum analyzer as RBW=1MHz, VBW≥3\* RBW, Span=40/80MHz, Sweep=auto, Detector = RMS
- d) Set the occur band to the entire emission 26dB bandwidth of the signal.
- e) Trace average at least 100 traces in power averaging (i.e., RMS) mode.
- f) Compute power by integrating the spectrum across the EBW (or, alternatively, the entire 26dB occupied bandwidth) of the signal using the instrument' s band power measurement function with band limits set equal to the EBW (or occupied bandwidth) band edges.
- g) Record the max. Power channel reading.
- h) Repeat above procedures until all the frequency measured were complete.

Test Limit:

| Frequency Band                                                | EUT Category                                               | Limit                                                                                                                 |
|---------------------------------------------------------------|------------------------------------------------------------|-----------------------------------------------------------------------------------------------------------------------|
| U-NII-1                                                       | <input type="checkbox"/> Outdoor Access Point              | 1W(30dBm)<br>The maximum e.i.r.p≤125 mW(21 dBm) at any elevation angle above 30 degrees as measured from the horizon. |
|                                                               | <input type="checkbox"/> Fixed Point-to-point Access Point | 1W(30dBm)                                                                                                             |
|                                                               | <input checked="" type="checkbox"/> Indoor Access Point    |                                                                                                                       |
|                                                               | <input type="checkbox"/> Mobile and Portable client device | 250mW (24dBm)                                                                                                         |
| U-NII-2a                                                      | -                                                          | Lesser of 250mW (24dBm) or 11dBm + 10log B*                                                                           |
| U-NII-2c                                                      |                                                            |                                                                                                                       |
| U-NII-3                                                       |                                                            | 1W (30dBm)                                                                                                            |
| <b>Note1:</b> *Where B is the 26dB emission bandwidth in MHz. |                                                            |                                                                                                                       |

Test Result:

Pass

Test Data:

The detailed test data see: Appendix B for SHEM170400212703

## 6.7 Peak Power Spectral Density

**Test Setup:**

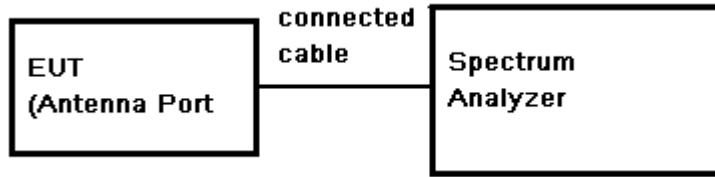

**Test Procedure:**

- a) Remove the antenna from the EUT and then connect a low RF cable from the antenna port to the spectrum.
- b) 5.15GHz-5.25GHz set span  $\geq 1.5 \cdot \text{OBW}$ ; RBW = 1 MHz; VBW  $\geq 3$  MHz, 5.725GHz-5.85GHz, set span  $\geq 1.5 \cdot \text{OBW}$ ; RBW = 0.51 MHz; VBW  $\geq 1.5$  MHz
- c) Number of points in sweep  $\geq 2 \text{ Span} / \text{RBW}$ ; Sweep time = auto.
- d) Detector = RMS, Trigger = Free run Record the marker level for the particular mode.
- e) Use the peak search function on the instrument to find the peak of the spectrum and record its value.
- f) Repeat these steps for other channel and device modes.

**Test Limit:**

| Frequency Band | EUT Category                                               | Limit         |
|----------------|------------------------------------------------------------|---------------|
| U-NII-1        | <input type="checkbox"/> Outdoor Access Point              | 17dBm/MHz     |
|                | <input type="checkbox"/> Fixed Point-to-point Access Point | 11 dBm/MHz    |
|                | <input checked="" type="checkbox"/> Indoor Access Point    |               |
|                | <input type="checkbox"/> Mobile and Portable client device | 11 dBm/MHz    |
| U-NII-2a       | -                                                          | 11 dBm/MHz    |
| U-NII-2c       |                                                            |               |
| U-NII-3        |                                                            | 30 dBm/500KHz |

**Test Result:**

Pass

**Test Data:**

The detailed test data see: Appendix B for SHEM170400212703

### 6.8 Radiated Spurious Emissions and Band-edge

**Test site/setup:** Measurement Distance: 3m

Test instrumentation set-up:

| Frequency Range(MHz) | Detector   | RBW      | VBW      |
|----------------------|------------|----------|----------|
| 0.009-0.090          | Peak       | 10kHz    | 30kHz    |
| 0.009-0.090          | Average    | 10kHz    | 30kHz    |
| 0.090-0.110          | Quasi-peak | 10kHz    | 30kHz    |
| 0.110-0.490MHz       | Peak       | 10kHz    | 30kHz    |
| 0.110-0.490          | Average    | 10kHz    | 30kHz    |
| 0.490 -30            | Quasi-peak | 10kHz    | 30kHz    |
| 30-1000              | Quasi-peak | 100kHz   | 300kHz   |
| Above 1000           | Peak       | RBW=1MHz | VBW≥RBW  |
|                      | Average    |          | VBW=10Hz |

Sweep=Auto

**15.209 Limit:**

| Frequency(MHz) | Field strength (microvolt/meter) | Limit (dBuV/m) |
|----------------|----------------------------------|----------------|
| 0.009-0.490    | 2400/F(KHz)                      | 128.5 ~ 93.8   |
| 0.490-1.705    | 24000/F(KHz)                     | 73.8 ~63.0     |
| 1.705-30       | 30                               | 69.5           |
| 30-88          | 100                              | 40.0           |
| 88-216         | 150                              | 43.5           |
| 216-960        | 200                              | 46.0           |
| 960-1000       | 500                              | 54.0           |
| Above 1000     | 500                              | 54.0           |

Note: 15.35(b), Unless otherwise specified, the limit on peak radio frequency emissions is 20dB above the maximum permitted average emission limit applicable to the equipment under test. This peak limit applies to the total peak emission level radiated by the device.

**15.407 Limit:**

| Operation Frequency (MHz) | EIRP Limit (dBm/MHz) | Equivalent Field Strength (dBµV/m) |
|---------------------------|----------------------|------------------------------------|
| 5150-5250                 | -27                  | 68.3                               |
| 5250-5350                 |                      |                                    |
| 5470-5725                 |                      |                                    |
| 5725-5850                 | -27* <sup>1</sup>    | 68.3* <sup>1</sup>                 |
|                           | -17* <sup>2</sup>    | 78.3* <sup>2</sup>                 |

Note: The following formula is used to convert the EIRP to field strength

$$E = \frac{1000000 \cdot \sqrt{30P}}{3} \text{ uV/m, where P is the EIRP (Watts).}$$

Remark: \*<sup>1</sup> Without 10MHz of band edge; \*<sup>2</sup> Within 10MHz of band edge

**Test Setup:**

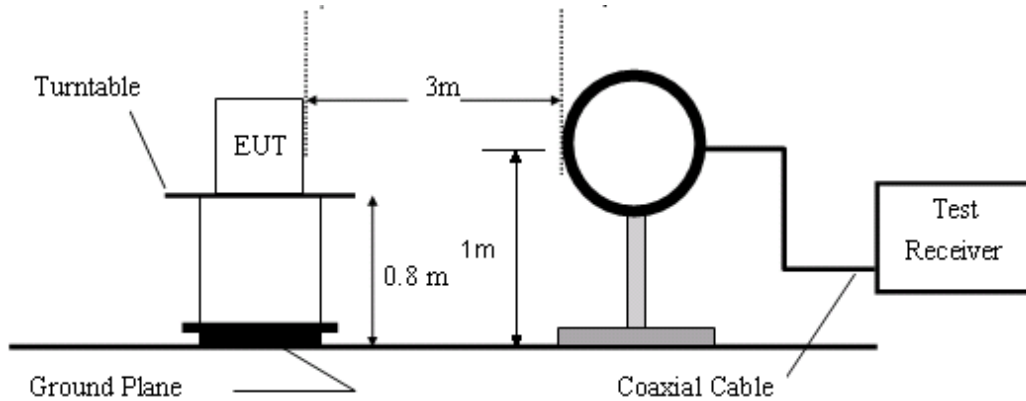

Figure1. Below 30MHz radiated emissions test configuration

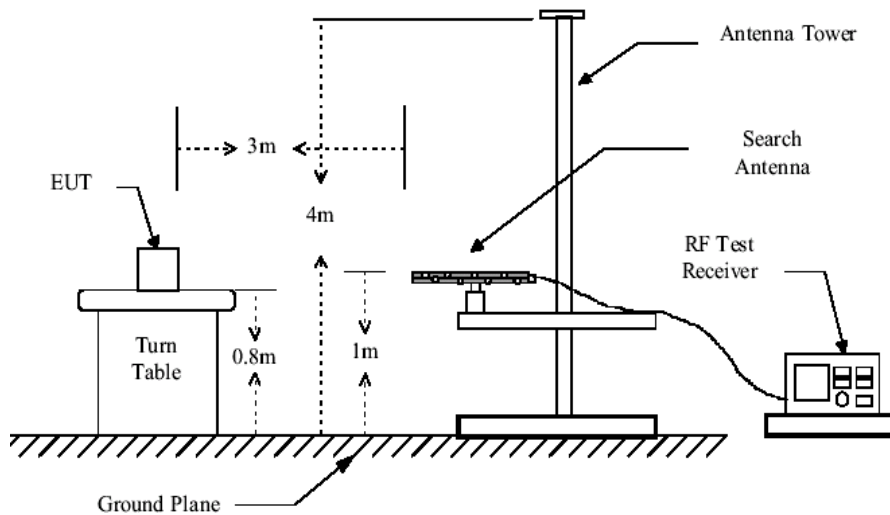

Figure2. 30MHz to 1GHz radiated emissions test configuration

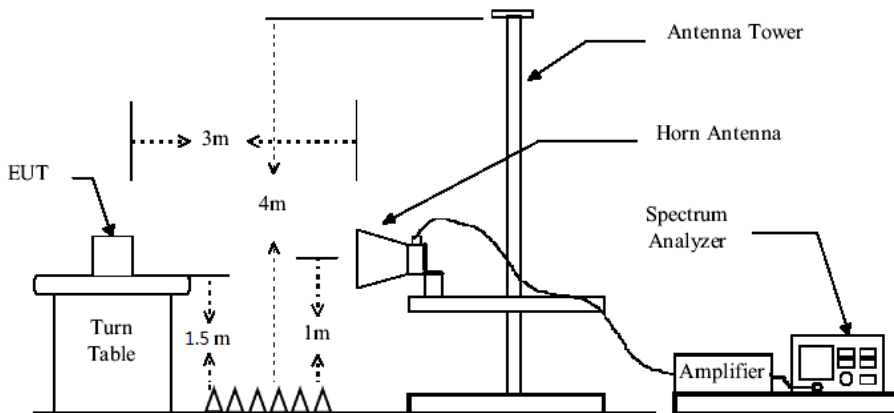

Figure3. Above 1GHz radiated emissions test configuration

- Test Procedure:**
- 1) The procedure used was ANSI Standard C63.10. When an emission was found, the table was rotated to produce the maximum signal strength. An initial pre-scan was performed for in peak detection mode using the receiver. The EUT was measured for both the Horizontal and Vertical polarities and performed a pre-test three orthogonal planes. For intentional radiators, measurements of the variation of the input power or the radiated signal level of the fundamental frequency component of the emission, as appropriate, shall be performed with the supply voltage varied between 85% and 115% of the nominal rated supply voltage. The worst case emissions were reported.
  - 2) Low noise amplifier was used below 1GHz, High pass Filter and amplifier was used above 3GHz. We did not use any amplifier or filter between 1G and 3GHz.
  - 3) Test were performed for their spatial orthogonal(X, Y, Z), the worst test data (X orthogonal) was submitted.
    - a) For this intentional radiator operates below 25 GHz. the spectrum shall be investigated to the tenth harmonic of the highest fundamental frequency. And above the third harmonic of this intentional radiator, the disturbance is very low. So the test result only displays to 5rd harmonic.
    - b) As shown in Section, for frequencies above 1000MHz. the above field strength limits are based on average limits. However, the peak field strength of any emission shall not exceed the maximum permitted average limits specified above by more than 20 dB under any condition of modulation.
  - 4) Pretest under all modes during 30MHz to 1GHz; choose the worst case mode (Middle channel of 802.11a on band 1) record on the report.
  - 5) No spurious emissions were detected within 20dB of limit below 30MHz.

**Test Result:** Pass

### 6.8.1 Radiated Spurious Emissions

30MHz-1GHz:

802.11 a

Channel: 149 of Antenna 1

| Item   | Freq.  | Read Level | Antenna Factor | Preamp Factor | Cable Loss | Result Level | Limit Line | Over Limit | Detector | Polarization |
|--------|--------|------------|----------------|---------------|------------|--------------|------------|------------|----------|--------------|
| (Mark) | (MHz)  | (dBμV)     | (dB/m)         | (dB)          | (dB)       | (dBμV/m)     | (dBμV/m)   | (dB)       |          |              |
| 1      | 160.91 | 57.66      | 12.93          | 42.56         | 0.64       | 28.67        | 43.50      | -14.83     | QP       | Horizontal   |
| 2      | 193.09 | 56.25      | 10.00          | 42.50         | 0.68       | 24.43        | 43.50      | -19.07     | QP       | Horizontal   |
| 3      | 258.33 | 61.93      | 11.79          | 42.41         | 0.78       | 32.09        | 46.00      | -13.91     | QP       | Horizontal   |
| 4      | 290.02 | 54.57      | 12.87          | 42.35         | 0.83       | 25.92        | 46.00      | -20.08     | QP       | Horizontal   |
| 5      | 355.43 | 54.20      | 14.31          | 42.19         | 0.92       | 27.24        | 46.00      | -18.76     | QP       | Horizontal   |
| 6      | 386.63 | 56.83      | 14.87          | 42.12         | 0.97       | 30.55        | 46.00      | -15.45     | QP       | Horizontal   |
| 1      | 35.25  | 50.66      | 15.86          | 42.68         | 0.20       | 24.04        | 40.00      | -15.96     | QP       | Vertical     |
| 2      | 128.56 | 50.07      | 12.43          | 42.63         | 0.57       | 20.44        | 43.50      | -23.06     | QP       | Vertical     |
| 3      | 160.91 | 55.90      | 12.93          | 42.56         | 0.64       | 26.91        | 43.50      | -16.59     | QP       | Vertical     |
| 4      | 193.09 | 59.11      | 10.00          | 42.50         | 0.68       | 27.29        | 43.50      | -16.21     | QP       | Vertical     |
| 5      | 225.31 | 52.23      | 10.51          | 42.46         | 0.73       | 21.01        | 46.00      | -24.99     | QP       | Vertical     |
| 6      | 257.42 | 60.58      | 11.76          | 42.42         | 0.78       | 30.70        | 46.00      | -15.30     | QP       | Vertical     |

Remark: 1. Result Level = Read Level + Antenna Factor + Cable loss - Preamp Factor

Below is the plot of worst case:  
Vertical:

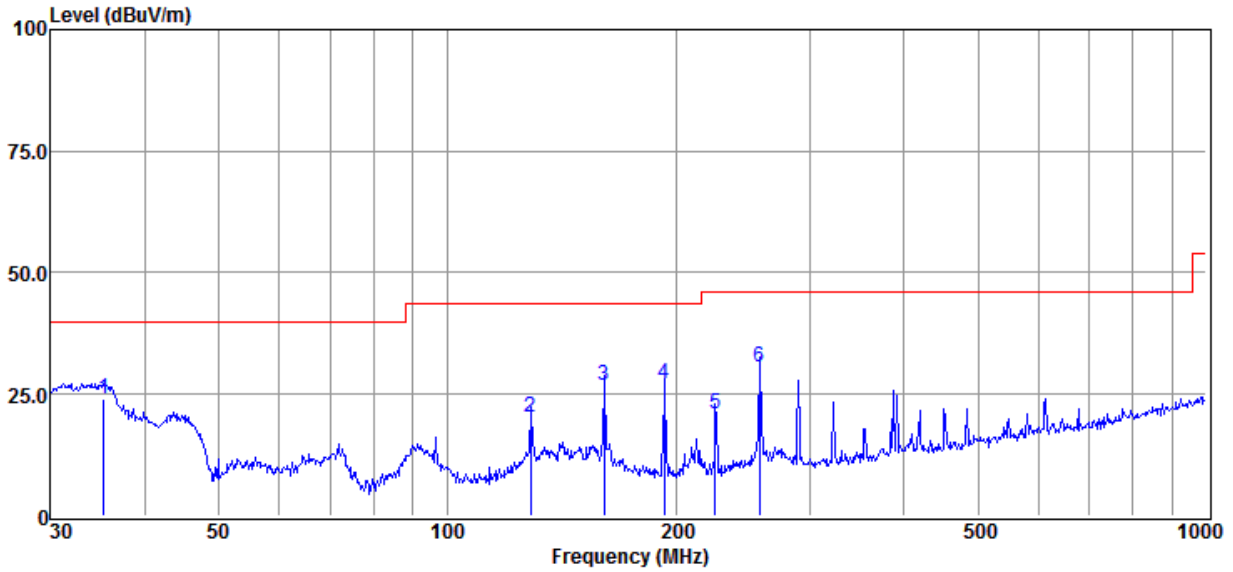

Horizontal:

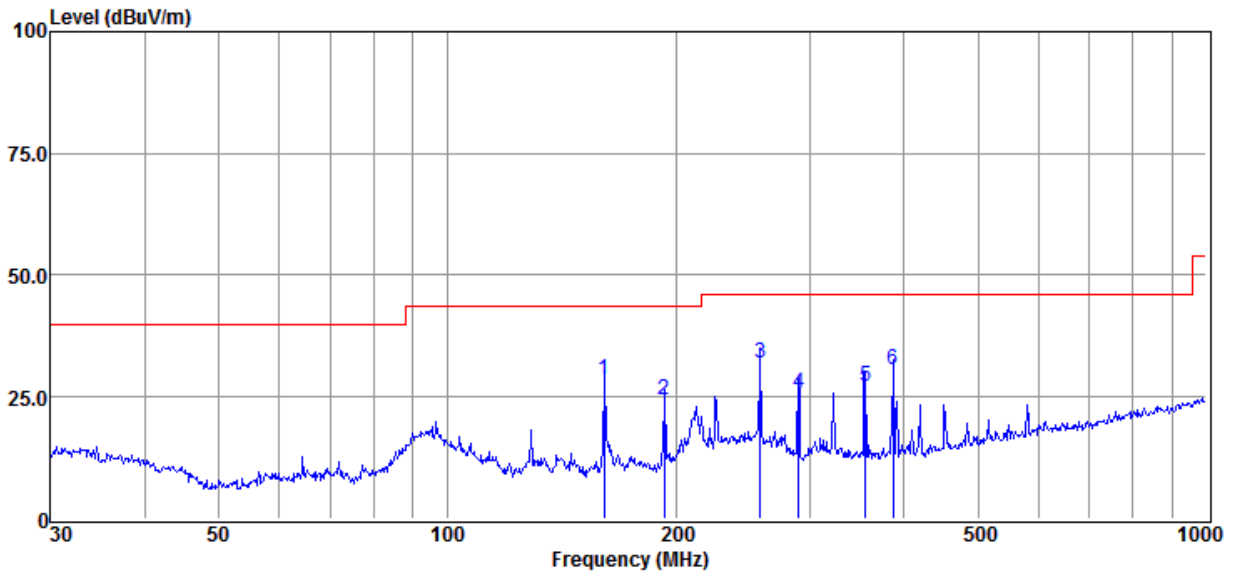

Above 1GHz

**802.11a**

**Channel: 36**

| Mark | Frequency (MHz) | Reading (dBuV) | Factor (dB) | Emission (dBuV/m) | Limit (dBuV/m) | Over Limit (dB) | Detector | Polarization |
|------|-----------------|----------------|-------------|-------------------|----------------|-----------------|----------|--------------|
| 1    | 6418            | 40.28          | 8.14        | 48.42             | 54             | -5.58           | peak     | Horizontal   |
| 2    | 9505            | 36.49          | 14.42       | 50.91             | 54             | -3.09           | peak     | Horizontal   |
| 3    | 10360           | 32.93          | 14.28       | 47.21             | 54             | -6.79           | peak     | Horizontal   |
| 4    | 7627.6          | 37.96          | 12.02       | 49.98             | 54             | -4.02           | peak     | Vertical     |
| 5    | 10360           | 30.59          | 14.28       | 44.87             | 54             | -9.13           | peak     | Vertical     |
| 6    | 13096           | 34.86          | 15.33       | 50.19             | 54             | -3.81           | peak     | Vertical     |

**802.11a**

**Channel: 44**

| Mark | Frequency (MHz) | Reading (dBuV) | Factor (dB) | Emission (dBuV/m) | Limit (dBuV/m) | Over Limit (dB) | Detector | Polarization |
|------|-----------------|----------------|-------------|-------------------|----------------|-----------------|----------|--------------|
| 1    | 7753.6          | 36.52          | 12.21       | 48.73             | 54             | -5.27           | peak     | Horizontal   |
| 2    | 9517.6          | 34.35          | 14.41       | 48.76             | 54             | -5.24           | peak     | Horizontal   |
| 3    | 10400           | 29.84          | 14.22       | 44.06             | 54             | -9.94           | peak     | Horizontal   |
| 4    | 6342.4          | 42.37          | 7.84        | 50.21             | 54             | -3.79           | peak     | Vertical     |
| 5    | 9555.4          | 37.04          | 14.39       | 51.43             | 54             | -2.57           | peak     | Vertical     |
| 6    | 10400           | 30.46          | 14.22       | 44.68             | 54             | -9.32           | peak     | Vertical     |

**802.11a**

**Channel: 48**

| Mark | Frequency (MHz) | Reading (dBuV) | Factor (dB) | Emission (dBuV/m) | Limit (dBuV/m) | Over Limit (dB) | Detector | Polarization |
|------|-----------------|----------------|-------------|-------------------|----------------|-----------------|----------|--------------|
| 1    | 9542.8          | 34.5           | 14.41       | 48.91             | 54             | -5.09           | peak     | Horizontal   |
| 2    | 10480           | 35.06          | 14.08       | 49.14             | 54             | -4.86           | peak     | Horizontal   |
| 3    | 13058.2         | 33.85          | 15.25       | 49.1              | 54             | -4.9            | peak     | Horizontal   |
| 4    | 6405.4          | 41.48          | 8.09        | 49.57             | 54             | -4.43           | peak     | Vertical     |
| 5    | 9605.8          | 36.49          | 14.38       | 50.87             | 54             | -3.13           | peak     | Vertical     |
| 6    | 10480           | 34.93          | 14.08       | 49.01             | 54             | -4.99           | peak     | Vertical     |

**802.11a**

**Channel: 149**

| Mark | Frequency (MHz) | Reading (dBuV) | Factor (dB) | Emission (dBuV/m) | Limit (dBuV/m) | Over Limit (dB) | Detector | Polarization |
|------|-----------------|----------------|-------------|-------------------|----------------|-----------------|----------|--------------|
| 1    | 9505            | 34.13          | 14.42       | 48.55             | 54             | -5.45           | peak     | Horizontal   |
| 2    | 11490           | 34.55          | 14.41       | 48.96             | 54             | -5.04           | peak     | Horizontal   |
| 3    | 13096           | 35.3           | 15.33       | 50.63             | 54             | -3.37           | peak     | Horizontal   |
| 4    | 6418            | 42.31          | 8.14        | 50.45             | 54             | -3.55           | peak     | Vertical     |
| 5    | 7867            | 37.44          | 12.37       | 49.81             | 54             | -4.19           | peak     | Vertical     |
| 6    | 11490           | 35.28          | 14.41       | 49.69             | 54             | -4.31           | peak     | Vertical     |



**802.11a**

**Channel: 157**

| Mark | Frequency (MHz) | Reading (dBuV) | Factor (dB) | Emission (dBuV/m) | Limit (dBuV/m) | Over Limit (dB) | Detector | Polarization |
|------|-----------------|----------------|-------------|-------------------|----------------|-----------------|----------|--------------|
| 1    | 6418            | 42.78          | 8.14        | 50.92             | 54             | -3.08           | peak     | Horizontal   |
| 2    | 11570           | 32.17          | 14.25       | 46.42             | 54             | -7.58           | peak     | Horizontal   |
| 3    | 13234.6         | 36.26          | 15.61       | 51.87             | 54             | -2.13           | peak     | Horizontal   |
| 4    | 6518.8          | 41.16          | 8.45        | 49.61             | 54             | -4.39           | peak     | Vertical     |
| 5    | 9580.6          | 36.36          | 14.39       | 50.75             | 54             | -3.25           | peak     | Vertical     |
| 6    | 11570           | 32.04          | 14.25       | 46.29             | 54             | -7.71           | peak     | Vertical     |

**802.11a**

**Channel: 165**

| Mark | Frequency (MHz) | Reading (dBuV) | Factor (dB) | Emission (dBuV/m) | Limit (dBuV/m) | Over Limit (dB) | Detector | Polarization |
|------|-----------------|----------------|-------------|-------------------|----------------|-----------------|----------|--------------|
| 1    | 7816.6          | 37.22          | 12.29       | 49.51             | 54             | -4.49           | peak     | Horizontal   |
| 2    | 11650           | 34.17          | 14.06       | 48.23             | 54             | -5.77           | peak     | Horizontal   |
| 3    | 13259.8         | 36.03          | 15.66       | 51.69             | 54             | -2.31           | peak     | Horizontal   |
| 4    | 6418            | 39.98          | 8.14        | 48.12             | 54             | -5.88           | peak     | Vertical     |
| 5    | 9605.8          | 36.71          | 14.38       | 51.09             | 54             | -2.91           | peak     | Vertical     |
| 6    | 11650           | 35.36          | 14.06       | 49.42             | 54             | -4.58           | peak     | Vertical     |

**802.11 n(HT20)**

**Channel: 36**

| Mark | Frequency (MHz) | Reading (dBuV) | Factor (dB) | Emission (dBuV/m) | Limit (dBuV/m) | Over Limit (dB) | Detector | Polarization |
|------|-----------------|----------------|-------------|-------------------|----------------|-----------------|----------|--------------|
| 1    | 6405.4          | 42.61          | 8.09        | 50.7              | 54             | -3.3            | peak     | Horizontal   |
| 2    | 9505            | 35.74          | 14.42       | 50.16             | 54             | -3.84           | peak     | Horizontal   |
| 3    | 10360           | 32.18          | 14.28       | 46.46             | 54             | -7.54           | peak     | Horizontal   |
| 4    | 6468.4          | 43.21          | 8.31        | 51.52             | 54             | -2.48           | peak     | Vertical     |
| 5    | 10360           | 35.27          | 14.28       | 49.55             | 54             | -4.45           | peak     | Vertical     |
| 6    | 11836           | 36.21          | 13.74       | 49.95             | 54             | -4.05           | peak     | Vertical     |

**802.11 n(HT20)**

**Channel: 44**

| Mark | Frequency (MHz) | Reading (dBuV) | Factor (dB) | Emission (dBuV/m) | Limit (dBuV/m) | Over Limit (dB) | Detector | Polarization |
|------|-----------------|----------------|-------------|-------------------|----------------|-----------------|----------|--------------|
| 1    | 7665.4          | 36.72          | 12.07       | 48.79             | 54             | -5.21           | peak     | Horizontal   |
| 2    | 9631            | 36.74          | 14.36       | 51.1              | 54             | -2.9            | peak     | Horizontal   |
| 3    | 10400           | 32.74          | 14.22       | 46.96             | 54             | -7.04           | peak     | Horizontal   |
| 4    | 7375.6          | 37.54          | 11.37       | 48.91             | 54             | -5.09           | peak     | Vertical     |
| 5    | 10400           | 31.06          | 14.22       | 45.28             | 54             | -8.72           | peak     | Vertical     |
| 6    | 12970           | 36.15          | 15.07       | 51.22             | 54             | -2.78           | peak     | Vertical     |

**802.11 n(HT20)**

**Channel: 48**

| Mark | Frequency (MHz) | Reading (dBuV) | Factor (dB) | Emission (dBuV/m) | Limit (dBuV/m) | Over Limit (dB) | Detector | Polarization |
|------|-----------------|----------------|-------------|-------------------|----------------|-----------------|----------|--------------|
| 1    | 6329.8          | 42.14          | 7.79        | 49.93             | 54             | -4.07           | peak     | Horizontal   |
| 2    | 7287.4          | 37.62          | 10.98       | 48.6              | 54             | -5.4            | peak     | Horizontal   |
| 3    | 10480           | 34.25          | 14.08       | 48.33             | 54             | -5.67           | peak     | Horizontal   |
| 4    | 7879.6          | 39.07          | 12.39       | 51.46             | 54             | -2.54           | peak     | Vertical     |
| 5    | 10480           | 33.24          | 14.08       | 47.32             | 54             | -6.68           | peak     | Vertical     |
| 6    | 12730.6         | 35.69          | 14.42       | 50.11             | 54             | -3.89           | peak     | Vertical     |

**802.11 n(HT20)**

**Channel: 149**

| Mark | Frequency (MHz) | Reading (dBuV) | Factor (dB) | Emission (dBuV/m) | Limit (dBuV/m) | Over Limit (dB) | Detector | Polarization |
|------|-----------------|----------------|-------------|-------------------|----------------|-----------------|----------|--------------|
| 1    | 6342.4          | 42.07          | 7.84        | 49.91             | 54             | -4.09           | peak     | Horizontal   |
| 2    | 9353.8          | 37.03          | 14.34       | 51.37             | 54             | -2.63           | peak     | Horizontal   |
| 3    | 11490           | 33.75          | 14.41       | 48.16             | 54             | -5.84           | peak     | Horizontal   |
| 4    | 8383.6          | 38.43          | 11.93       | 50.36             | 54             | -3.64           | peak     | Vertical     |
| 5    | 11490           | 31.3           | 14.41       | 45.71             | 54             | -8.29           | peak     | Vertical     |
| 6    | 11722.6         | 37.7           | 13.89       | 51.59             | 54             | -2.41           | peak     | Vertical     |

**802.11 n(HT20)**

**Channel: 157**

| Mark | Frequency (MHz) | Reading (dBuV) | Factor (dB) | Emission (dBuV/m) | Limit (dBuV/m) | Over Limit (dB) | Detector | Polarization |
|------|-----------------|----------------|-------------|-------------------|----------------|-----------------|----------|--------------|
| 1    | 7287.4          | 37.87          | 10.98       | 48.85             | 54             | -5.15           | peak     | Horizontal   |
| 2    | 9668.8          | 36.02          | 14.36       | 50.38             | 54             | -3.62           | peak     | Horizontal   |
| 3    | 11570           | 37.71          | 14.25       | 51.96             | 54             | -2.04           | peak     | Horizontal   |
| 4    | 8484.4          | 38.87          | 12.12       | 50.99             | 54             | -3.01           | peak     | Vertical     |
| 5    | 11570           | 31.71          | 14.25       | 45.96             | 54             | -8.04           | peak     | Vertical     |
| 6    | 11735.2         | 37.32          | 13.87       | 51.19             | 54             | -2.81           | peak     | Vertical     |

**802.11 n(HT20)**

**Channel: 165**

| Mark | Frequency (MHz) | Reading (dBuV) | Factor (dB) | Emission (dBuV/m) | Limit (dBuV/m) | Over Limit (dB) | Detector | Polarization |
|------|-----------------|----------------|-------------|-------------------|----------------|-----------------|----------|--------------|
| 1    | 7438.6          | 39.07          | 11.64       | 50.71             | 54             | -3.29           | peak     | Horizontal   |
| 2    | 9568            | 36.34          | 14.4        | 50.74             | 54             | -3.26           | peak     | Horizontal   |
| 3    | 11650           | 33.36          | 14.06       | 47.42             | 54             | -6.58           | peak     | Horizontal   |
| 4    | 6468.4          | 42.59          | 8.31        | 50.9              | 54             | -3.1            | peak     | Vertical     |
| 5    | 7312.6          | 39.49          | 11.09       | 50.58             | 54             | -3.42           | peak     | Vertical     |
| 6    | 11650           | 34.62          | 14.06       | 48.68             | 54             | -5.32           | peak     | Vertical     |

**802.11 n(HT40)**

**Channel: 38**

| Mark | Frequency (MHz) | Reading (dBuV) | Factor (dB) | Emission (dBuV/m) | Limit (dBuV/m) | Over Limit (dB) | Detector | Polarization |
|------|-----------------|----------------|-------------|-------------------|----------------|-----------------|----------|--------------|
| 1    | 6468.4          | 39.86          | 8.31        | 48.17             | 54             | -5.83           | peak     | Horizontal   |
| 2    | 9618.4          | 35.47          | 14.37       | 49.84             | 54             | -4.16           | peak     | Horizontal   |
| 3    | 10380           | 32.74          | 14.25       | 46.99             | 54             | -7.01           | peak     | Horizontal   |
| 4    | 6405.4          | 41.99          | 8.09        | 50.08             | 54             | -3.92           | peak     | Vertical     |
| 5    | 9517.6          | 35.24          | 14.41       | 49.65             | 54             | -4.35           | peak     | Vertical     |
| 6    | 10380           | 34.51          | 14.25       | 48.76             | 54             | -5.24           | peak     | Vertical     |

**802.11 n(HT40)**

**Channel: 46**

| Mark | Frequency (MHz) | Reading (dBuV) | Factor (dB) | Emission (dBuV/m) | Limit (dBuV/m) | Over Limit (dB) | Detector | Polarization |
|------|-----------------|----------------|-------------|-------------------|----------------|-----------------|----------|--------------|
| 1    | 7426            | 40.23          | 11.58       | 51.81             | 54             | -2.19           | peak     | Horizontal   |
| 2    | 10460           | 33.15          | 14.11       | 47.26             | 54             | -6.74           | peak     | Horizontal   |
| 3    | 11710           | 36.58          | 13.92       | 50.5              | 54             | -3.5            | peak     | Horizontal   |
| 4    | 7665.4          | 36.22          | 12.07       | 48.29             | 54             | -5.71           | peak     | Vertical     |
| 5    | 9605.8          | 35.61          | 14.38       | 49.99             | 54             | -4.01           | peak     | Vertical     |
| 6    | 10460           | 31.67          | 14.11       | 45.78             | 54             | -8.22           | peak     | Vertical     |

**802.11 n(HT40)**

**Channel: 151**

| Mark | Frequency (MHz) | Reading (dBuV) | Factor (dB) | Emission (dBuV/m) | Limit (dBuV/m) | Over Limit (dB) | Detector | Polarization |
|------|-----------------|----------------|-------------|-------------------|----------------|-----------------|----------|--------------|
| 1    | 9593.2          | 36.8           | 14.38       | 51.18             | 54             | -2.82           | peak     | Horizontal   |
| 2    | 11510           | 33.28          | 14.4        | 47.68             | 54             | -6.32           | peak     | Horizontal   |
| 3    | 11760.4         | 34.79          | 13.8        | 48.59             | 54             | -5.41           | peak     | Horizontal   |
| 4    | 6342.4          | 43.54          | 7.84        | 51.38             | 54             | -2.62           | peak     | Vertical     |
| 5    | 7879.6          | 36.98          | 12.39       | 49.37             | 54             | -4.63           | peak     | Vertical     |
| 6    | 11510           | 31.64          | 14.4        | 46.04             | 54             | -7.96           | peak     | Vertical     |

**802.11 n(HT40)**

**Channel: 159**

| Mark | Frequency (MHz) | Reading (dBuV) | Factor (dB) | Emission (dBuV/m) | Limit (dBuV/m) | Over Limit (dB) | Detector | Polarization |
|------|-----------------|----------------|-------------|-------------------|----------------|-----------------|----------|--------------|
| 1    | 6405.4          | 41.79          | 8.09        | 49.88             | 54             | -4.12           | peak     | Horizontal   |
| 2    | 7665.4          | 37.18          | 12.07       | 49.25             | 54             | -4.75           | peak     | Horizontal   |
| 3    | 11590           | 32.35          | 14.2        | 46.55             | 54             | -7.45           | peak     | Horizontal   |
| 4    | 5422.6          | 40.51          | 7.25        | 47.76             | 54             | -6.24           | peak     | Vertical     |
| 5    | 7867            | 37.72          | 12.37       | 50.09             | 54             | -3.91           | peak     | Vertical     |
| 6    | 11590           | 32.1           | 14.2        | 46.3              | 54             | -7.7            | peak     | Vertical     |

**802.11 ac(VHT20)**

**Channel: 36**

| Mark | Frequency (MHz) | Reading (dBuV) | Factor (dB) | Emission (dBuV/m) | Limit (dBuV/m) | Over Limit (dB) | Detector | Polarization |
|------|-----------------|----------------|-------------|-------------------|----------------|-----------------|----------|--------------|
| 1    | 7627.6          | 38.19          | 12.02       | 50.21             | 54             | -3.79           | peak     | Horizontal   |
| 2    | 9593.2          | 36.52          | 14.38       | 50.9              | 54             | -3.1            | peak     | Horizontal   |
| 3    | 10360           | 31.74          | 14.28       | 46.02             | 54             | -7.98           | peak     | Horizontal   |
| 4    | 6418            | 41.8           | 8.14        | 49.94             | 54             | -4.06           | peak     | Vertical     |
| 5    | 7665.4          | 35.76          | 12.07       | 47.83             | 54             | -6.17           | peak     | Vertical     |
| 6    | 10360           | 31.47          | 14.28       | 45.75             | 54             | -8.25           | peak     | Vertical     |

**802.11 ac(VHT20)**

**Channel: 40**

| Mark | Frequency (MHz) | Reading (dBuV) | Factor (dB) | Emission (dBuV/m) | Limit (dBuV/m) | Over Limit (dB) | Detector | Polarization |
|------|-----------------|----------------|-------------|-------------------|----------------|-----------------|----------|--------------|
| 1    | 7438.6          | 37.07          | 11.64       | 48.71             | 54             | -5.29           | peak     | Horizontal   |
| 2    | 9694            | 35.27          | 14.34       | 49.61             | 54             | -4.39           | peak     | Horizontal   |
| 3    | 10400           | 31.54          | 14.22       | 45.76             | 54             | -8.24           | peak     | Horizontal   |
| 4    | 6594.4          | 40.06          | 8.55        | 48.61             | 54             | -5.39           | peak     | Vertical     |
| 5    | 7879.6          | 36.33          | 12.39       | 48.72             | 54             | -5.28           | peak     | Vertical     |
| 6    | 10400           | 34.01          | 14.22       | 48.23             | 54             | -5.77           | peak     | Vertical     |

**802.11 ac(VHT20)**

**Channel: 48**

| Mark | Frequency (MHz) | Reading (dBuV) | Factor (dB) | Emission (dBuV/m) | Limit (dBuV/m) | Over Limit (dB) | Detector | Polarization |
|------|-----------------|----------------|-------------|-------------------|----------------|-----------------|----------|--------------|
| 1    | 7892.2          | 36.15          | 12.42       | 48.57             | 54             | -5.43           | peak     | Horizontal   |
| 2    | 9517.6          | 35.1           | 14.41       | 49.51             | 54             | -4.49           | peak     | Horizontal   |
| 3    | 10480           | 30.73          | 14.08       | 44.81             | 54             | -9.19           | peak     | Horizontal   |
| 4    | 6493.6          | 42.22          | 8.4         | 50.62             | 54             | -3.38           | peak     | Vertical     |
| 5    | 9530.2          | 36.33          | 14.4        | 50.73             | 54             | -3.27           | peak     | Vertical     |
| 6    | 10480           | 31.05          | 14.08       | 45.13             | 54             | -8.87           | peak     | Vertical     |

**802.11 ac(VHT20)**

**Channel: 149**

| Mark | Frequency (MHz) | Reading (dBuV) | Factor (dB) | Emission (dBuV/m) | Limit (dBuV/m) | Over Limit (dB) | Detector | Polarization |
|------|-----------------|----------------|-------------|-------------------|----------------|-----------------|----------|--------------|
| 1    | 7930            | 37.58          | 12.3        | 49.88             | 54             | -4.12           | peak     | Horizontal   |
| 2    | 11490           | 30.83          | 14.41       | 45.24             | 54             | -8.76           | peak     | Horizontal   |
| 3    | 13121.2         | 35.32          | 15.38       | 50.7              | 54             | -3.3            | peak     | Horizontal   |
| 4    | 7526.8          | 37.46          | 11.92       | 49.38             | 54             | -4.62           | peak     | Vertical     |
| 5    | 9492.4          | 36.5           | 14.42       | 50.92             | 54             | -3.08           | peak     | Vertical     |
| 6    | 11490           | 33.93          | 14.41       | 48.34             | 54             | -5.66           | peak     | Vertical     |

**802.11 ac(VHT20)**

**Channel: 157**

| Mark | Frequency (MHz) | Reading (dBuV) | Factor (dB) | Emission (dBuV/m) | Limit (dBuV/m) | Over Limit (dB) | Detector | Polarization |
|------|-----------------|----------------|-------------|-------------------|----------------|-----------------|----------|--------------|
| 1    | 7892.2          | 36.99          | 12.42       | 49.41             | 54             | -4.59           | peak     | Horizontal   |
| 2    | 9530.2          | 34.55          | 14.4        | 48.95             | 54             | -5.05           | peak     | Horizontal   |
| 3    | 11570           | 35.1           | 14.25       | 49.35             | 54             | -4.65           | peak     | Horizontal   |
| 4    | 9542.8          | 36.41          | 14.41       | 50.82             | 54             | -3.18           | peak     | Vertical     |
| 5    | 11570           | 32.42          | 14.25       | 46.67             | 54             | -7.33           | peak     | Vertical     |
| 6    | 13133.8         | 35.01          | 15.4        | 50.41             | 54             | -3.59           | peak     | Vertical     |

**802.11 ac(VHT20)**

**Channel: 165**

| Mark | Frequency (MHz) | Reading (dBuV) | Factor (dB) | Emission (dBuV/m) | Limit (dBuV/m) | Over Limit (dB) | Detector | Polarization |
|------|-----------------|----------------|-------------|-------------------|----------------|-----------------|----------|--------------|
| 1    | 6468.4          | 40.07          | 8.31        | 48.38             | 54             | -5.62           | peak     | Horizontal   |
| 2    | 9366.4          | 35.43          | 14.36       | 49.79             | 54             | -4.21           | peak     | Horizontal   |
| 3    | 11650           | 33.84          | 14.06       | 47.9              | 54             | -6.1            | peak     | Horizontal   |
| 4    | 9605.8          | 36.84          | 14.38       | 51.22             | 54             | -2.78           | peak     | Vertical     |
| 5    | 11650           | 33.01          | 14.06       | 47.07             | 54             | -6.93           | peak     | Vertical     |
| 6    | 13133.8         | 33.83          | 15.4        | 49.23             | 54             | -4.77           | peak     | Vertical     |

**802.11 ac(VHT40)**

**Channel: 38**

| Mark | Frequency (MHz) | Reading (dBuV) | Factor (dB) | Emission (dBuV/m) | Limit (dBuV/m) | Over Limit (dB) | Detector | Polarization |
|------|-----------------|----------------|-------------|-------------------|----------------|-----------------|----------|--------------|
| 1    | 6418            | 41.53          | 8.14        | 49.67             | 54             | -4.33           | peak     | Horizontal   |
| 2    | 7816.6          | 39.68          | 12.29       | 51.97             | 54             | -2.03           | peak     | Horizontal   |
| 3    | 10380           | 32.92          | 14.25       | 47.17             | 54             | -6.83           | peak     | Horizontal   |
| 4    | 6418            | 40.38          | 8.14        | 48.52             | 54             | -5.48           | peak     | Vertical     |
| 5    | 9542.8          | 36.55          | 14.41       | 50.96             | 54             | -3.04           | peak     | Vertical     |
| 6    | 10380           | 35.01          | 14.25       | 49.26             | 54             | -4.74           | peak     | Vertical     |

**802.11 ac(VHT40)**

**Channel: 46**

| Mark | Frequency (MHz) | Reading (dBuV) | Factor (dB) | Emission (dBuV/m) | Limit (dBuV/m) | Over Limit (dB) | Detector | Polarization |
|------|-----------------|----------------|-------------|-------------------|----------------|-----------------|----------|--------------|
| 1    | 9618.4          | 34.33          | 14.37       | 48.7              | 54             | -5.3            | peak     | Horizontal   |
| 2    | 10460           | 33.16          | 14.11       | 47.27             | 54             | -6.73           | peak     | Horizontal   |
| 3    | 13310.2         | 35.13          | 15.87       | 51                | 54             | -3              | peak     | Horizontal   |
| 4    | 6401            | 53.93          | 8.08        | 62.01             | 74             | -11.99          | peak     | Vertical     |
| 5    | 8645            | 47.48          | 12.6        | 60.08             | 74             | -13.92          | peak     | Vertical     |
| 6    | 10460           | 47.13          | 14.11       | 61.24             | 74             | -12.76          | peak     | Vertical     |

**802.11 ac(VHT40)**

**Channel: 151**

| Mark | Frequency (MHz) | Reading (dBuV) | Factor (dB) | Emission (dBuV/m) | Limit (dBuV/m) | Over Limit (dB) | Detector | Polarization |
|------|-----------------|----------------|-------------|-------------------|----------------|-----------------|----------|--------------|
| 1    | 7791.4          | 38.46          | 12.26       | 50.72             | 54             | -3.28           | peak     | Horizontal   |
| 2    | 9580.6          | 34.88          | 14.39       | 49.27             | 54             | -4.73           | peak     | Horizontal   |
| 3    | 11510           | 35.62          | 14.4        | 50.02             | 54             | -3.98           | peak     | Horizontal   |
| 4    | 6418            | 41.8           | 8.14        | 49.94             | 54             | -4.06           | peak     | Vertical     |
| 5    | 7375.6          | 38.29          | 11.37       | 49.66             | 54             | -4.34           | peak     | Vertical     |
| 6    | 11510           | 37.05          | 14.4        | 51.45             | 54             | -2.55           | peak     | Vertical     |

**802.11 ac(VHT40)**

**Channel: 159**

| Mark | Frequency (MHz) | Reading (dBuV) | Factor (dB) | Emission (dBuV/m) | Limit (dBuV/m) | Over Limit (dB) | Detector | Polarization |
|------|-----------------|----------------|-------------|-------------------|----------------|-----------------|----------|--------------|
| 1    | 6392.8          | 43.73          | 8.05        | 51.78             | 54             | -2.22           | peak     | Horizontal   |
| 2    | 7892.2          | 35.95          | 12.42       | 48.37             | 54             | -5.63           | peak     | Horizontal   |
| 3    | 11590           | 34.43          | 14.2        | 48.63             | 54             | -5.37           | peak     | Horizontal   |
| 4    | 9505            | 35.87          | 14.42       | 50.29             | 54             | -3.71           | peak     | Vertical     |
| 5    | 10563.4         | 37.37          | 14.05       | 51.42             | 54             | -2.58           | peak     | Vertical     |
| 6    | 11590           | 31.53          | 14.2        | 45.73             | 54             | -8.27           | peak     | Vertical     |

**802.11 ac(VHT80)**

**Channel:42**

| Mark | Frequency (MHz) | Reading (dBuV) | Factor (dB) | Emission (dBuV/m) | Limit (dBuV/m) | Over Limit (dB) | Detector | Polarization |
|------|-----------------|----------------|-------------|-------------------|----------------|-----------------|----------|--------------|
| 1    | 6405.4          | 43.45          | 8.09        | 51.54             | 54             | -2.46           | peak     | Horizontal   |
| 2    | 8308            | 37.36          | 11.78       | 49.14             | 54             | -4.86           | peak     | Horizontal   |
| 3    | 10420           | 34.91          | 14.17       | 49.08             | 54             | -4.92           | peak     | Horizontal   |
| 4    | 7879.6          | 37.72          | 12.39       | 50.11             | 54             | -3.89           | peak     | Vertical     |
| 5    | 9593.2          | 34.76          | 14.38       | 49.14             | 54             | -4.86           | peak     | Vertical     |
| 6    | 10420           | 36.87          | 14.17       | 51.04             | 54             | -2.96           | peak     | Vertical     |

**802.11 ac(VHT80)**

**Channel: 155**

| Mark | Frequency (MHz) | Reading (dBuV) | Factor (dB) | Emission (dBuV/m) | Limit (dBuV/m) | Over Limit (dB) | Detector | Polarization |
|------|-----------------|----------------|-------------|-------------------|----------------|-----------------|----------|--------------|
| 1    | 7753.6          | 38.64          | 12.21       | 50.85             | 54             | -3.15           | peak     | Horizontal   |
| 2    | 9505            | 34.55          | 14.42       | 48.97             | 54             | -5.03           | peak     | Horizontal   |
| 3    | 11550           | 33.37          | 14.3        | 47.67             | 54             | -6.33           | peak     | Horizontal   |
| 4    | 7879.6          | 36.79          | 12.39       | 49.18             | 54             | -4.82           | peak     | Vertical     |
| 5    | 9542.8          | 36.02          | 14.41       | 50.43             | 54             | -3.57           | peak     | Vertical     |
| 6    | 11550           | 34.83          | 14.3        | 49.13             | 54             | -4.87           | peak     | Vertical     |

**6.8.2 Radiated Band-edge**

802.11 a

Channel: 5180

| MK. | Frequency (MHz) | Reading (dBuV/m) | Corrected factor(dB) | Result (dBuV/m) | Limit (dBuV/m) | Over Limit (dB) | Detector | Polarization |
|-----|-----------------|------------------|----------------------|-----------------|----------------|-----------------|----------|--------------|
| 1   | 5137.58         | 49.46            | 6.99                 | 56.45           | 74             | -17.55          | Peak     | Horizontal   |
| 2   | 5150            | 55.66            | 6.92                 | 62.58           | 74             | -11.42          | Peak     | Horizontal   |
| 3   | 5182.31         | 96.12            | 6.75                 | 102.87          | 74             | 28.87           | Peak     | Horizontal   |
| 1   | 5136.87         | 35.46            | 7                    | 42.46           | 54             | -11.54          | Average  | Horizontal   |
| 2   | 5150            | 36.73            | 6.92                 | 43.65           | 54             | -10.35          | Average  | Horizontal   |
| 3   | 5181.6          | 85.51            | 6.75                 | 92.26           | 54             | 38.26           | Average  | Horizontal   |

Peak

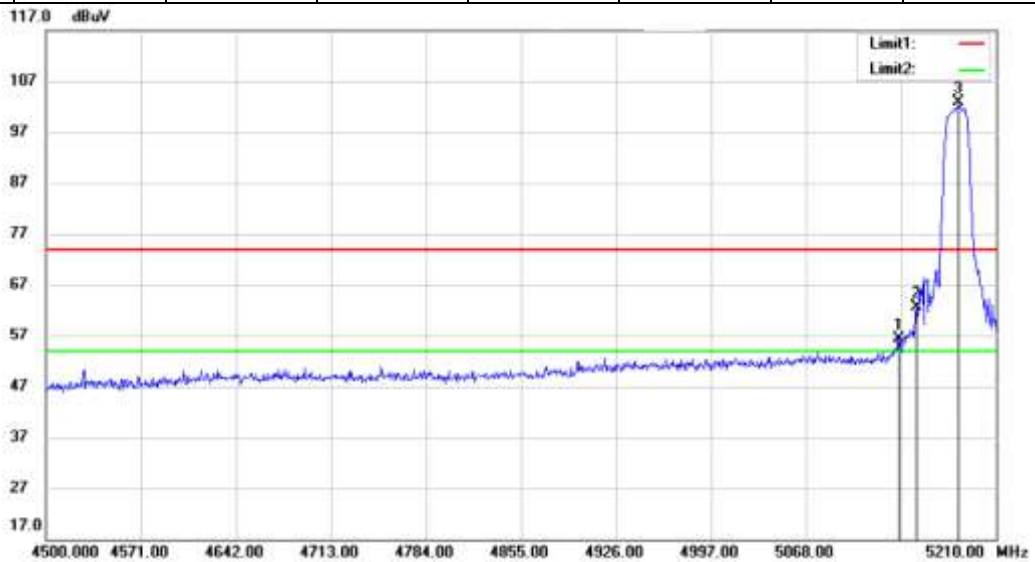

Average

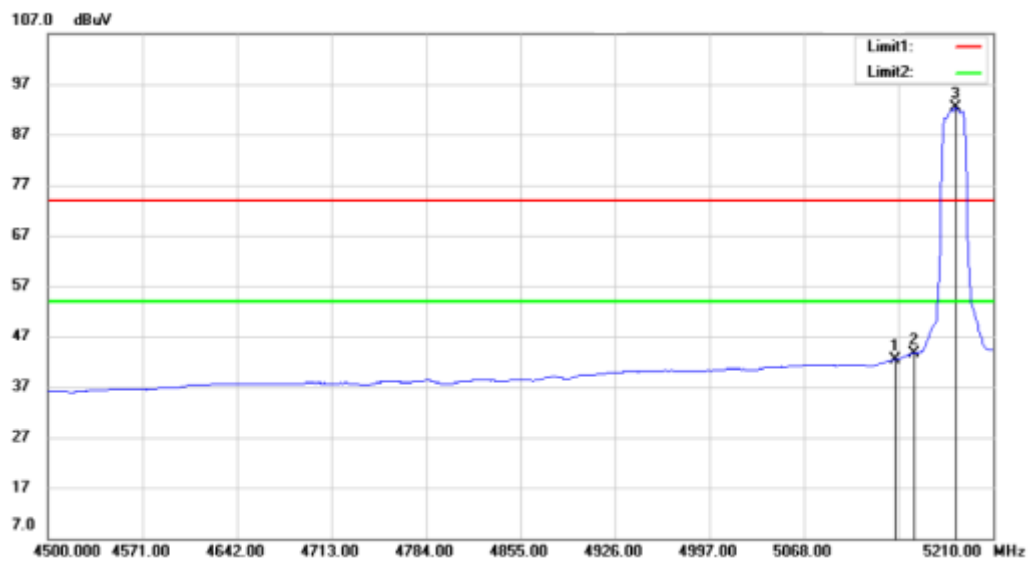



**802.11 a**

**Channel: 5180**

| MK. | Frequency (MHz) | Reading (dBuV/m) | Corrected factor(dB) | Result (dBuV/m) | Limit (dBuV/m) | Over Limit (dB) | Detector | Polarization |
|-----|-----------------|------------------|----------------------|-----------------|----------------|-----------------|----------|--------------|
| 1   | 5145.39         | 58.85            | 6.95                 | 65.8            | 74             | -8.2            | Peak     | Vertical     |
| 2   | 5150            | 57.67            | 6.92                 | 64.59           | 74             | -9.41           | Peak     | Vertical     |
| 3   | 5181.6          | 94.91            | 6.75                 | 101.66          | 74             | 27.66           | Peak     | Vertical     |
| 1   | 5143.26         | 40.53            | 6.96                 | 47.49           | 54             | -6.51           | Average  | Vertical     |
| 2   | 5150            | 43.47            | 6.92                 | 50.39           | 54             | -3.61           | Average  | Vertical     |
| 3   | 5181.6          | 84.71            | 6.75                 | 91.46           | 54             | 37.46           | Average  | Vertical     |

Peak

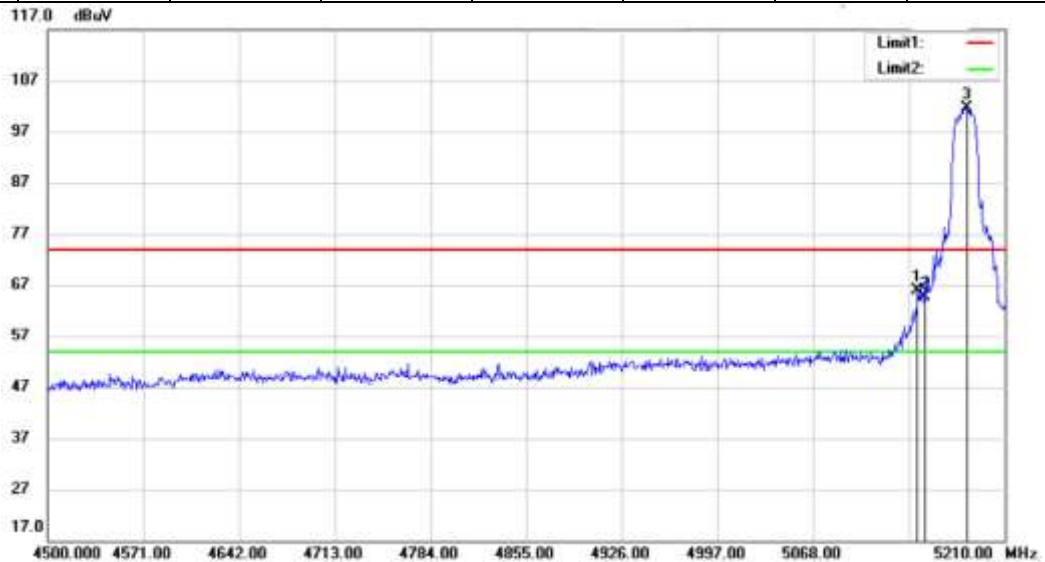

Average



**802.11 a**

**Channel: 5240**

| MK. | Frequency (MHz) | Reading (dBUV/m) | Corrected factor(dB) | Result (dBUV/m) | Limit (dBUV/m) | Over Limit (dB) | Detector | Polarization |
|-----|-----------------|------------------|----------------------|-----------------|----------------|-----------------|----------|--------------|
| 1   | 5241.85         | 97.65            | 6.65                 | 104.3           | 54             | 50.3            | Peak     | Horizontal   |
| 2   | 5350            | 42.84            | 6.98                 | 49.82           | 54             | -4.18           | Peak     | Horizontal   |
| 3   | 5403.04         | 45.86            | 7.31                 | 53.17           | 54             | -0.83           | Peak     | Horizontal   |
| 1   | 5241.31         | 96.49            | 6.65                 | 103.14          | 54             | 49.14           | Peak     | Vertical     |
| 2   | 5350            | 43.92            | 6.98                 | 50.9            | 54             | -3.1            | Peak     | Vertical     |
| 3   | 5409.79         | 46.14            | 7.29                 | 53.43           | 54             | -0.57           | Peak     | Vertical     |

Horizontal

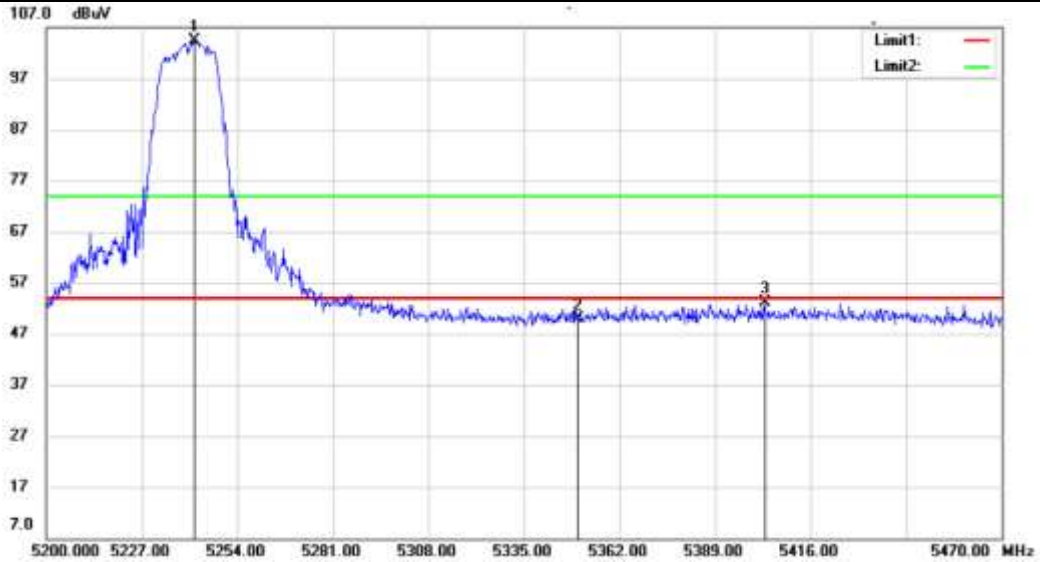

Vertical

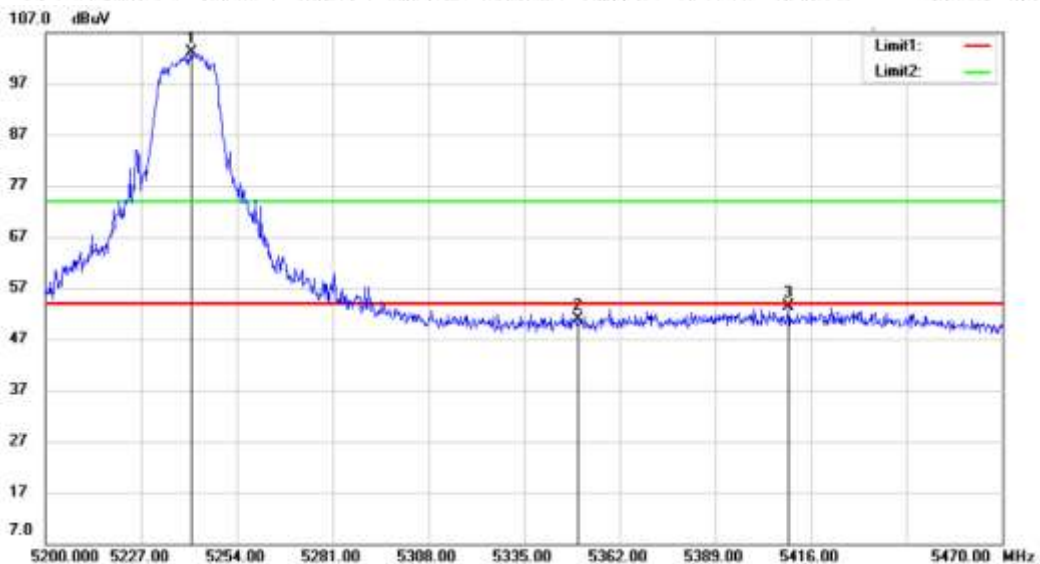

**802.11 a**

**Channel: 5745**

| MK. | Frequency (MHz) | Reading (dBuV/m) | Corrected factor(dB) | Result (dBuV/m) | Limit (dBuV/m) | Over Limit (dB) | Detector | Polarization |
|-----|-----------------|------------------|----------------------|-----------------|----------------|-----------------|----------|--------------|
| 1   | 5720.42         | 62.55            | 6.82                 | 69.37           | 74             | -4.63           | Peak     | Horizontal   |
| 2   | 5725            | 60.91            | 6.82                 | 67.73           | 74             | -6.27           | Peak     | Horizontal   |
| 3   | 5746.69         | 97.37            | 6.77                 | 104.14          | 74             | 30.14           | Peak     | Horizontal   |
| 1   | 5714.87         | 37.43            | 6.84                 | 44.27           | 54             | -9.73           | Average  | Horizontal   |
| 2   | 5725            | 44.96            | 6.82                 | 51.78           | 54             | -2.22           | Average  | Horizontal   |
| 3   | 5744.47         | 87.64            | 6.78                 | 94.42           | 54             | 40.42           | Average  | Horizontal   |

Peak

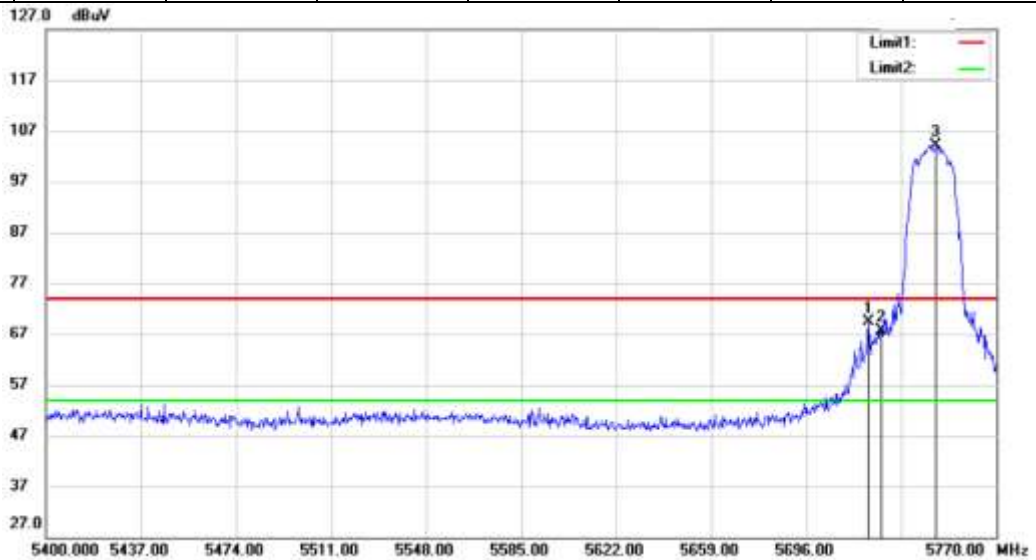

Average

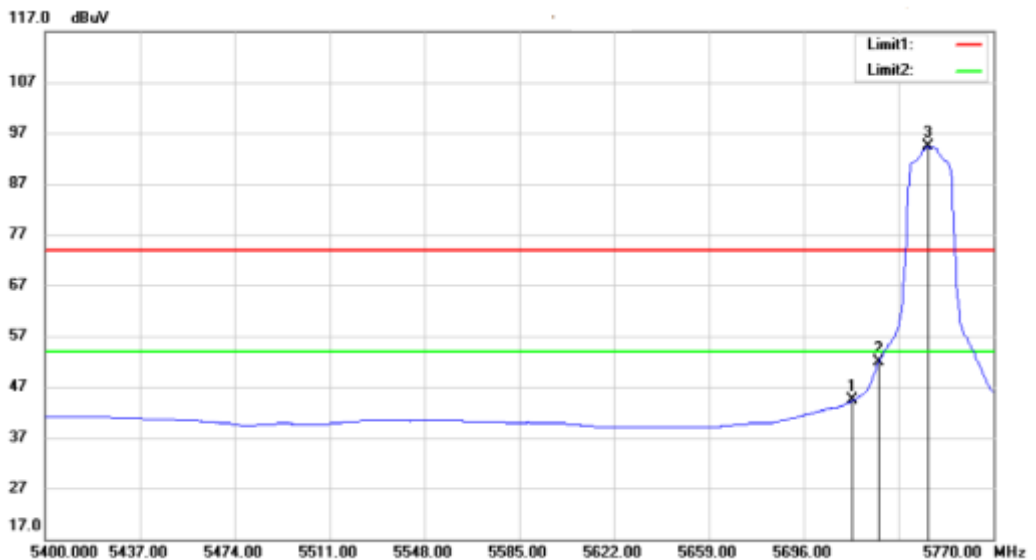

**802.11 a**

**Channel: 5745**

| MK. | Frequency (MHz) | Reading (dBuV/m) | Corrected factor(dB) | Result (dBuV/m) | Limit (dBuV/m) | Over Limit (dB) | Detector | Polarization |
|-----|-----------------|------------------|----------------------|-----------------|----------------|-----------------|----------|--------------|
| 1   | 5720.79         | 55.38            | 6.82                 | 62.2            | 74             | -11.8           | Peak     | Vertical     |
| 2   | 5725            | 53.37            | 6.82                 | 60.19           | 74             | -13.81          | Peak     | Vertical     |
| 3   | 5744.47         | 89.37            | 6.78                 | 96.15           | 74             | 22.15           | Peak     | Vertical     |
| 1   | 5717.09         | 34.31            | 6.84                 | 41.15           | 54             | -12.85          | Average  | Vertical     |
| 2   | 5725            | 38.66            | 6.82                 | 45.48           | 54             | -8.52           | Average  | Vertical     |
| 3   | 5744.47         | 79.48            | 6.78                 | 86.26           | 54             | 32.26           | Average  | Vertical     |

Vertical

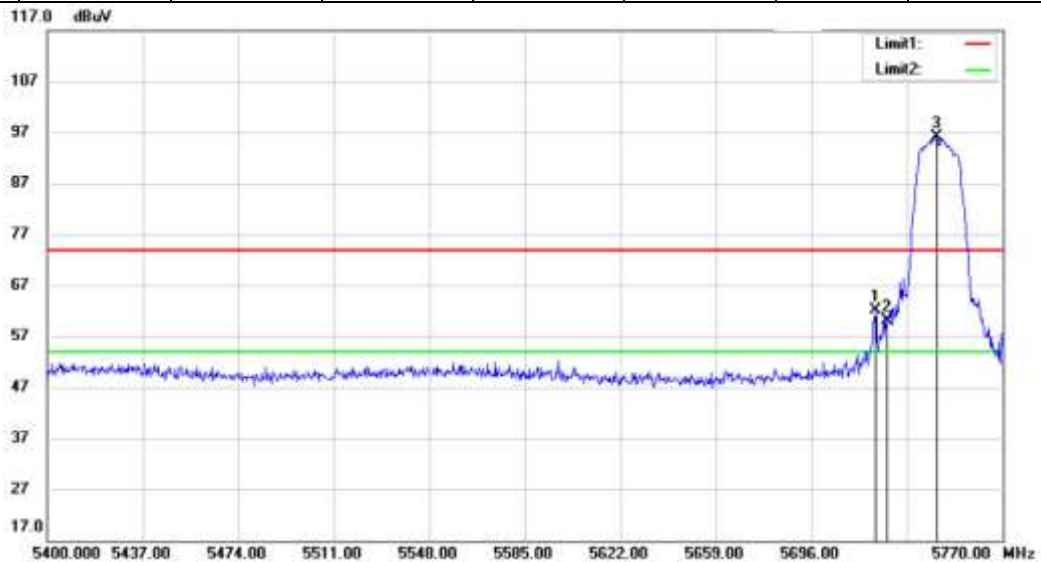

Average

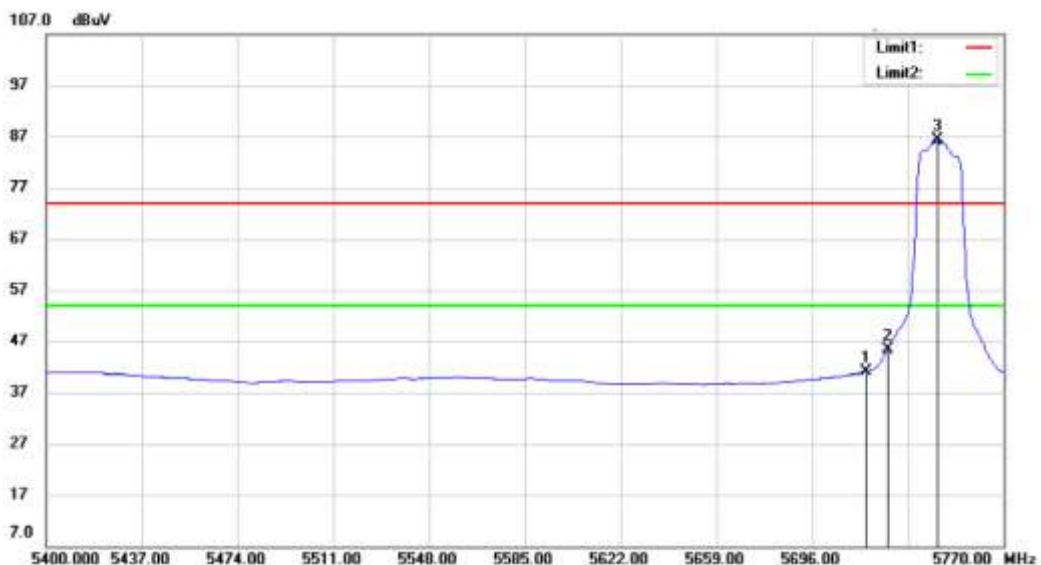

**802.11 a**

**Channel: 5825**

| MK. | Frequency (MHz) | Reading (dBuV/m) | Corrected factor(dB) | Result (dBuV/m) | Limit (dBuV/m) | Over Limit (dB) | Detector | Polarization |
|-----|-----------------|------------------|----------------------|-----------------|----------------|-----------------|----------|--------------|
| 1   | 5826.4          | 97.06            | 6.66                 | 103.72          | 74             | 29.72           | Peak     | Horizontal   |
| 2   | 5850            | 58.08            | 6.64                 | 64.72           | 74             | -9.28           | Peak     | Horizontal   |
| 3   | 5860.4          | 53.59            | 6.63                 | 60.22           | 74             | -13.78          | Peak     | Horizontal   |
| 1   | 5824.2          | 87.22            | 6.65                 | 93.87           | 54             | 39.87           | Average  | Horizontal   |
| 2   | 5850            | 38.52            | 6.64                 | 45.16           | 54             | -8.84           | Average  | Horizontal   |
| 3   | 5860.2          | 37.09            | 6.63                 | 43.72           | 54             | -10.28          | Average  | Horizontal   |

Peak

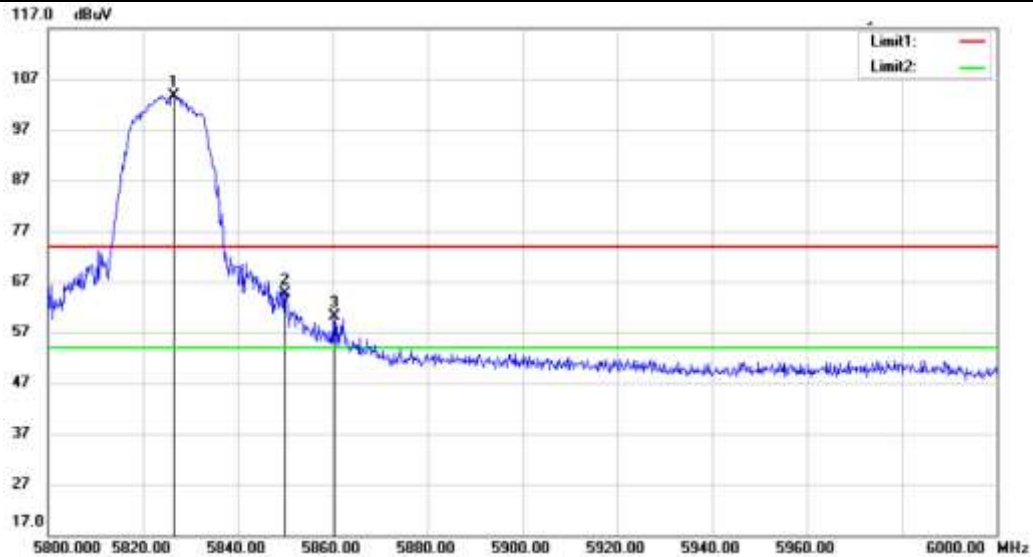

Average

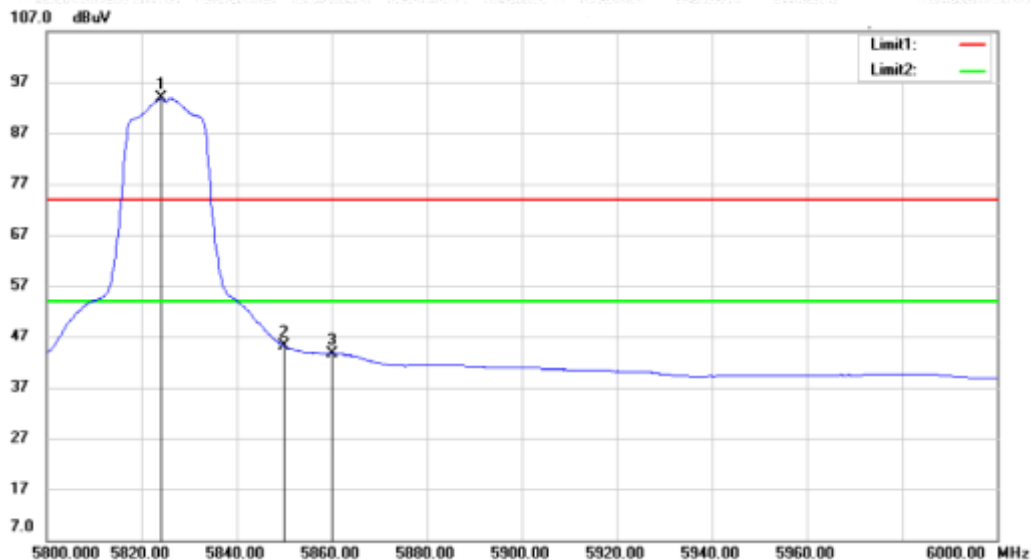

**802.11 a**

**Channel: 5825**

This document is issued by the Company subject to its General Conditions of Service printed overleaf, available on request or accessible at [www.sgs.com/terms\\_and\\_conditions.htm](http://www.sgs.com/terms_and_conditions.htm) and, for electronic format documents, subject to Terms and Conditions for Electronic Documents at [www.sgs.com/terms\\_e-document.htm](http://www.sgs.com/terms_e-document.htm). Attention is drawn to the limitation of liability, indemnification and jurisdiction issues defined therein. Any holder of this document is advised that information contained hereon reflects the Company's findings at the time of its intervention only and within the limits of Client's instructions, if any. The Company's sole responsibility is to its Client and this document does not exonerate parties to a transaction from exercising all their rights and obligations under the transaction documents. This document cannot be reproduced except in full, without prior written approval of the Company. Any unauthorized alteration, forgery or falsification of the content or appearance of this document is unlawful and offenders may be prosecuted to the fullest extent of the law. Unless otherwise stated the results shown in this test report refer only to the sample(s) tested and such sample(s) are retained for 90 days only

| MK. | Frequency (MHz) | Reading (dBuV/m) | Corrected factor(dB) | Result (dBuV/m) | Limit (dBuV/m) | Over Limit (dB) | Detector | Polarization |
|-----|-----------------|------------------|----------------------|-----------------|----------------|-----------------|----------|--------------|
| 1   | 5826.6          | 88.19            | 6.66                 | 94.85           | 74             | 20.85           | Peak     | Vertical     |
| 2   | 5850            | 47.4             | 6.64                 | 54.04           | 74             | -19.96          | Peak     | Vertical     |
| 3   | 5851.8          | 49.56            | 6.64                 | 56.2            | 74             | -17.8           | Peak     | Vertical     |
| 1   | 5824.2          | 76.44            | 6.65                 | 83.09           | 54             | 29.09           | Average  | Vertical     |
| 2   | 5850            | 34.57            | 6.64                 | 41.21           | 54             | -12.79          | Average  | Vertical     |
| 3   | 5856.4          | 33.98            | 6.63                 | 40.61           | 54             | -13.39          | Average  | Vertical     |

Peak

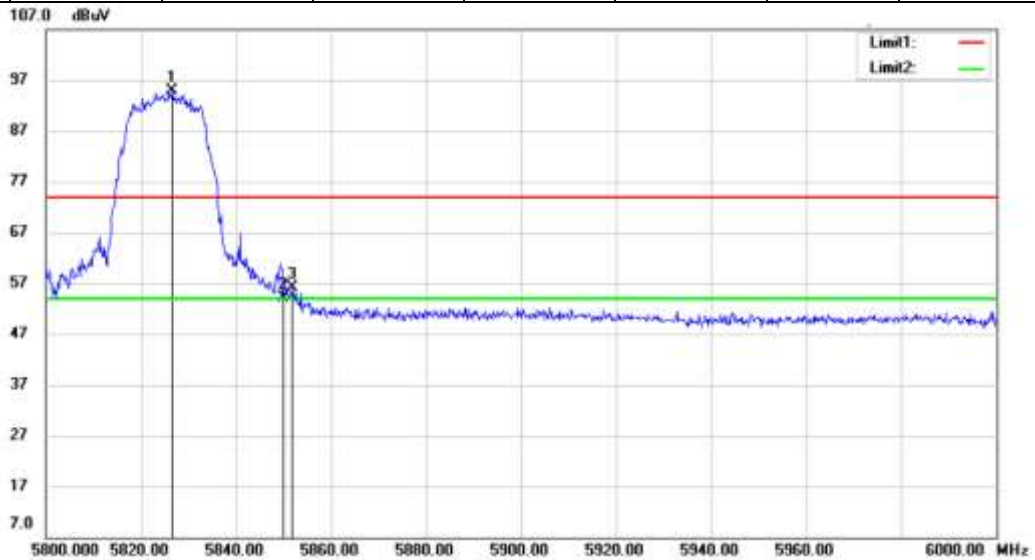

Average

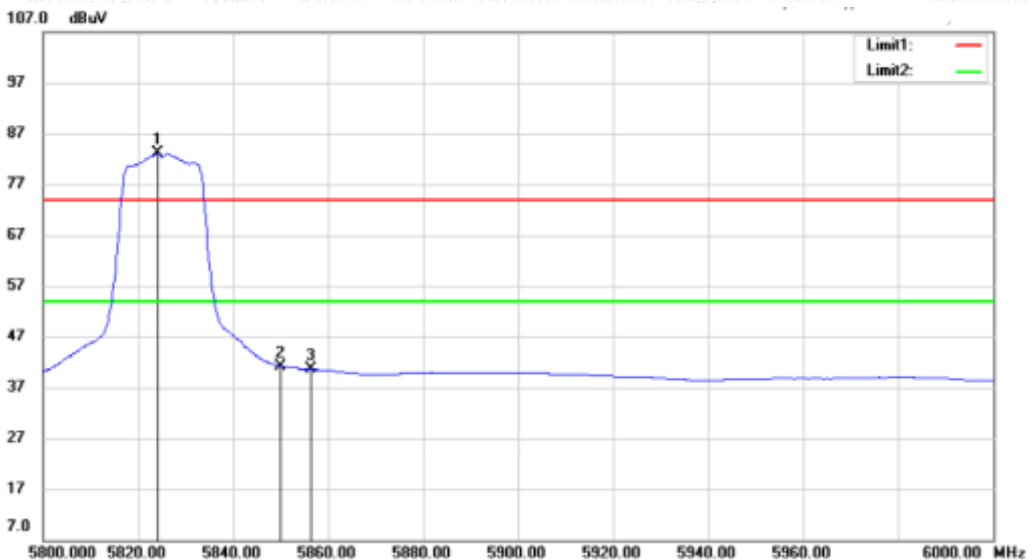

**802.11 n(HT20)**

**Channel: 5180**

| MK. | Frequency (MHz) | Reading (dBuV/m) | Corrected factor(dB) | Result (dBuV/m) | Limit (dBuV/m) | Over Limit (dB) | Detector | Polarization |
|-----|-----------------|------------------|----------------------|-----------------|----------------|-----------------|----------|--------------|
| 1   | 5139.71         | 49.35            | 6.98                 | 56.33           | 74             | -17.67          | Peak     | Horizontal   |
| 2   | 5150            | 47.1             | 6.92                 | 54.02           | 74             | -19.98          | Peak     | Horizontal   |
| 3   | 5183.73         | 94.71            | 6.74                 | 101.45          | 74             | 27.45           | Peak     | Horizontal   |
| 1   | 5143.97         | 35.15            | 6.96                 | 42.11           | 54             | -11.89          | Average  | Horizontal   |
| 2   | 5150            | 35.63            | 6.92                 | 42.55           | 54             | -11.45          | Average  | Horizontal   |
| 3   | 5181.6          | 81.48            | 6.75                 | 88.23           | 54             | 34.23           | Average  | Horizontal   |

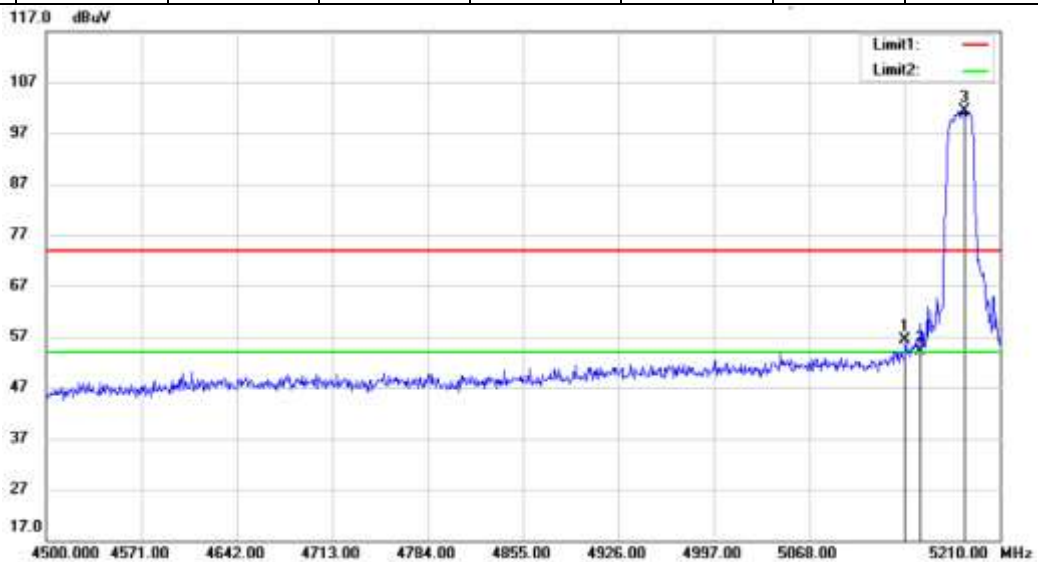

Peak

Average

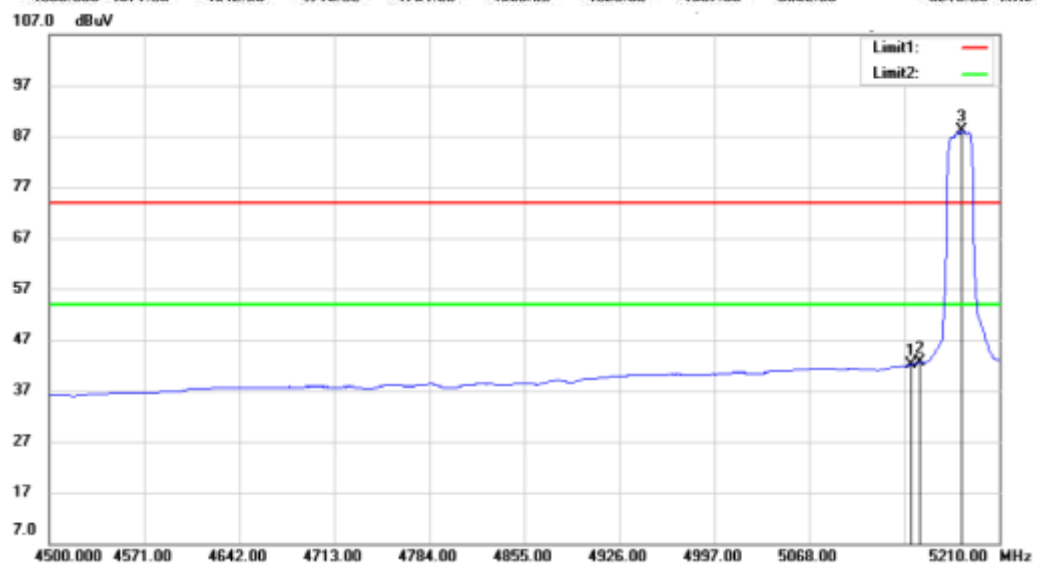

**802.11 n(HT20)**

**Channel: 5180**

| MK. | Frequency (MHz) | Reading (dBuV/m) | Corrected factor(dB) | Result (dBuV/m) | Limit (dBuV/m) | Over Limit (dB) | Detector | Polarization |
|-----|-----------------|------------------|----------------------|-----------------|----------------|-----------------|----------|--------------|
| 1   | 5146.1          | 51.42            | 6.94                 | 58.36           | 74             | -15.64          | Peak     | Vertical     |
| 2   | 5150            | 52.39            | 6.92                 | 59.31           | 74             | -14.69          | Peak     | Vertical     |
| 3   | 5184.44         | 91.04            | 6.74                 | 97.78           | 74             | 23.78           | Peak     | Vertical     |
|     | 5081.49         | 34.62            | 7.29                 | 41.91           | 54             | -12.09          | Average  | Vertical     |
|     | 5150            | 35.03            | 6.92                 | 41.95           | 54             | -12.05          | Average  | Vertical     |
|     | 5179.47         | 76.22            | 6.76                 | 82.98           | 54             | 28.98           | Average  | Vertical     |

Peak

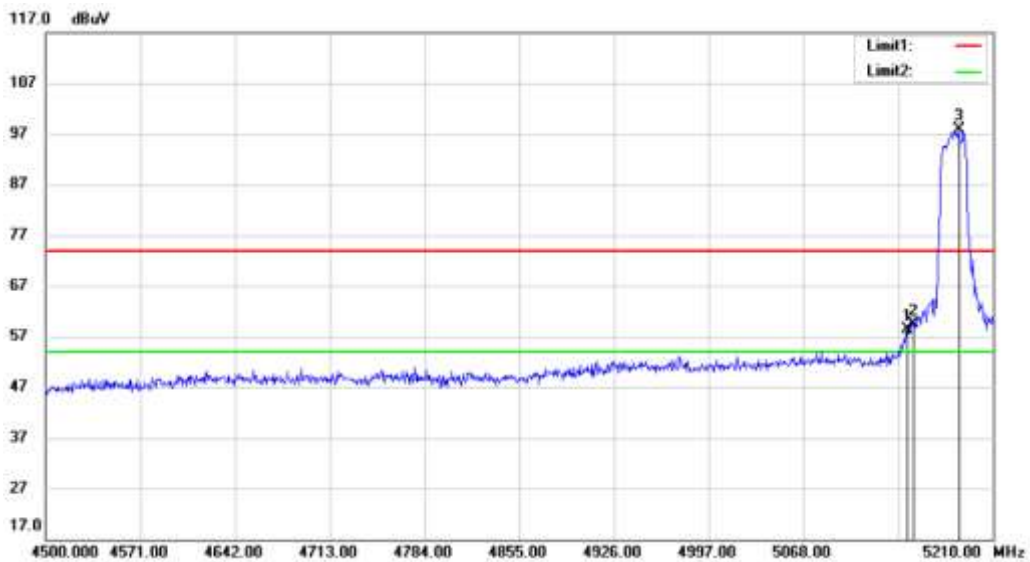

Average

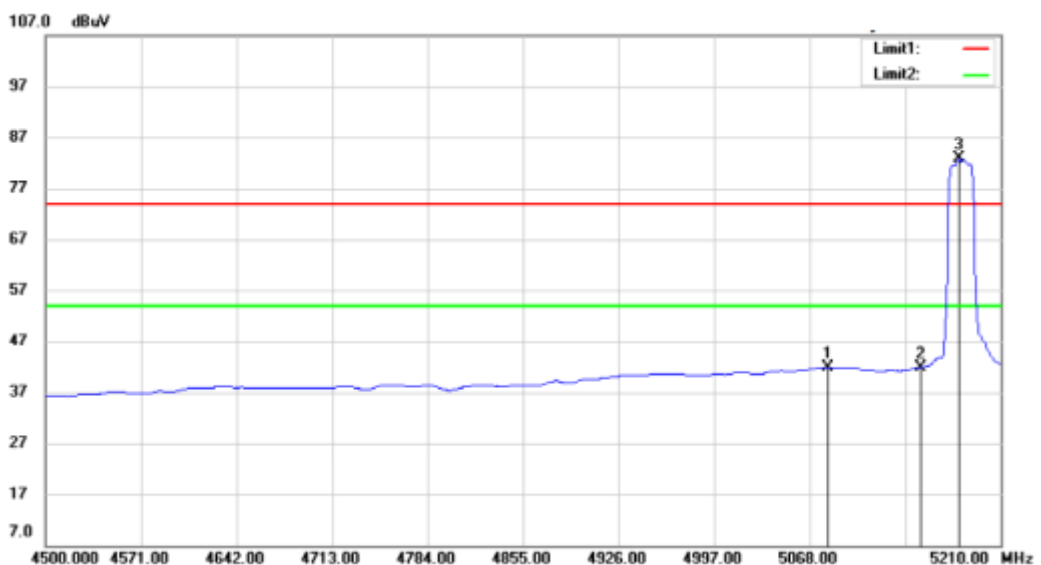



**802.11 n(HT20)**

**Channel: 5240**

| MK. | Frequency (MHz) | Reading (dBUV/m) | Corrected factor(dB) | Result (dBUV/m) | Limit (dBUV/m) | Over Limit (dB) | Detector | Polarization |
|-----|-----------------|------------------|----------------------|-----------------|----------------|-----------------|----------|--------------|
| 1   | 5241.58         | 97.05            | 6.65                 | 103.7           | 54             | 49.7            | Peak     | Horizontal   |
| 2   | 5350            | 43.73            | 6.98                 | 50.71           | 54             | -3.29           | Peak     | Horizontal   |
| 3   | 5398.18         | 45.86            | 7.32                 | 53.18           | 54             | -0.82           | Peak     | Horizontal   |
| 1   | 5241.58         | 92.84            | 6.65                 | 99.49           | 54             | 45.49           | Peak     | Vertical     |
| 2   | 5350            | 42.71            | 6.98                 | 49.69           | 54             | -4.31           | Peak     | Vertical     |
| 3   | 5401.69         | 45.94            | 7.31                 | 53.25           | 54             | -0.75           | Peak     | Vertical     |

Vertical

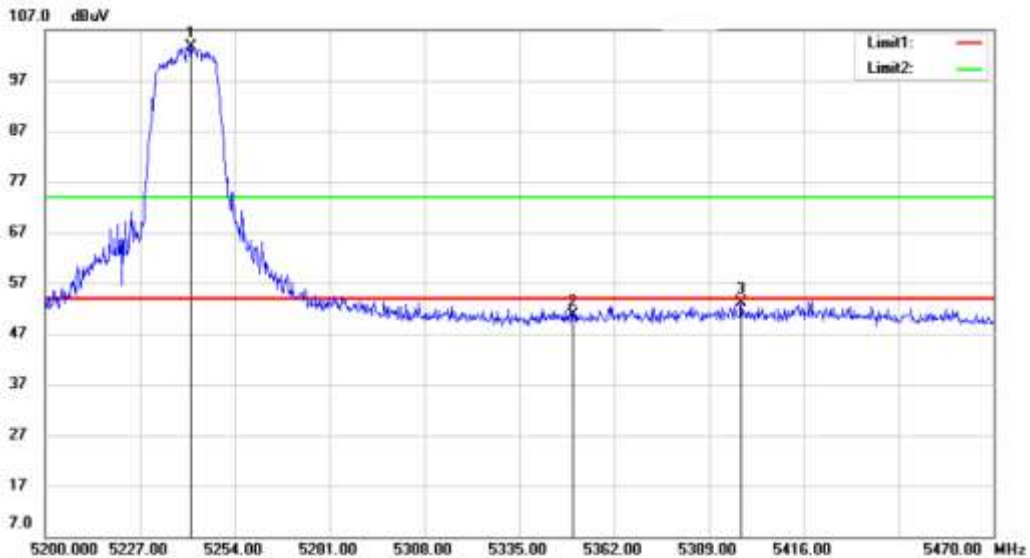

Horizontal

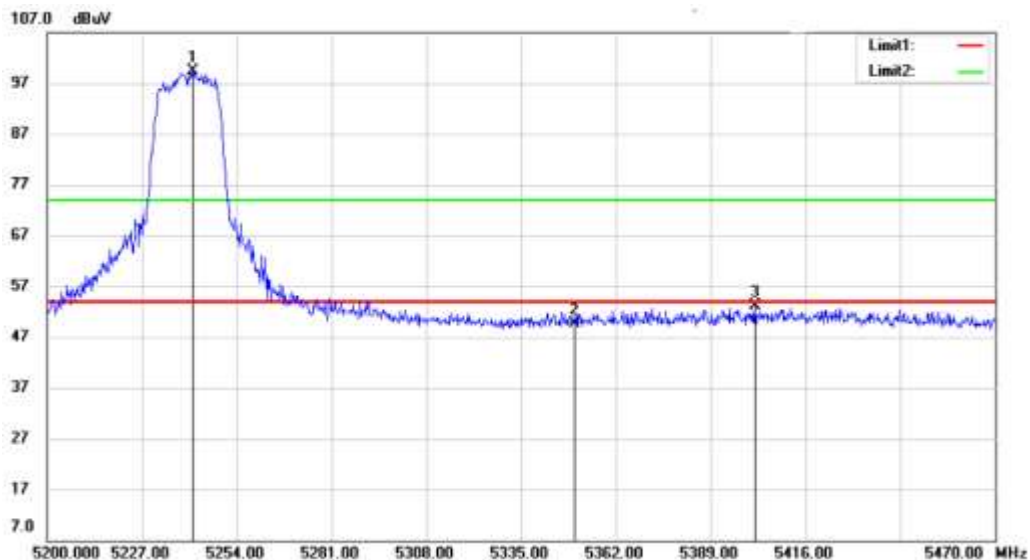

**802.11 n(HT20)**

**Channel: 5745**

| MK. | Frequency (MHz) | Reading (dBuV/m) | Corrected factor(dB) | Result (dBuV/m) | Limit (dBuV/m) | Over Limit (dB) | Detector | Polarization |
|-----|-----------------|------------------|----------------------|-----------------|----------------|-----------------|----------|--------------|
| 1   | 5717.09         | 52.57            | 6.84                 | 59.41           | 74             | -14.59          | Peak     | Horizontal   |
| 2   | 5725            | 57.43            | 6.82                 | 64.25           | 74             | -9.75           | Peak     | Horizontal   |
| 3   | 5744.47         | 95.5             | 6.78                 | 102.28          | 74             | 28.28           | Peak     | Horizontal   |
| 1   | 5709.69         | 34.1             | 6.85                 | 40.95           | 54             | -13.05          | Average  | Horizontal   |
| 2   | 5725            | 40.43            | 6.82                 | 47.25           | 54             | -6.75           | Average  | Horizontal   |
| 3   | 5744.1          | 81.42            | 6.78                 | 88.2            | 54             | 34.2            | Average  | Horizontal   |

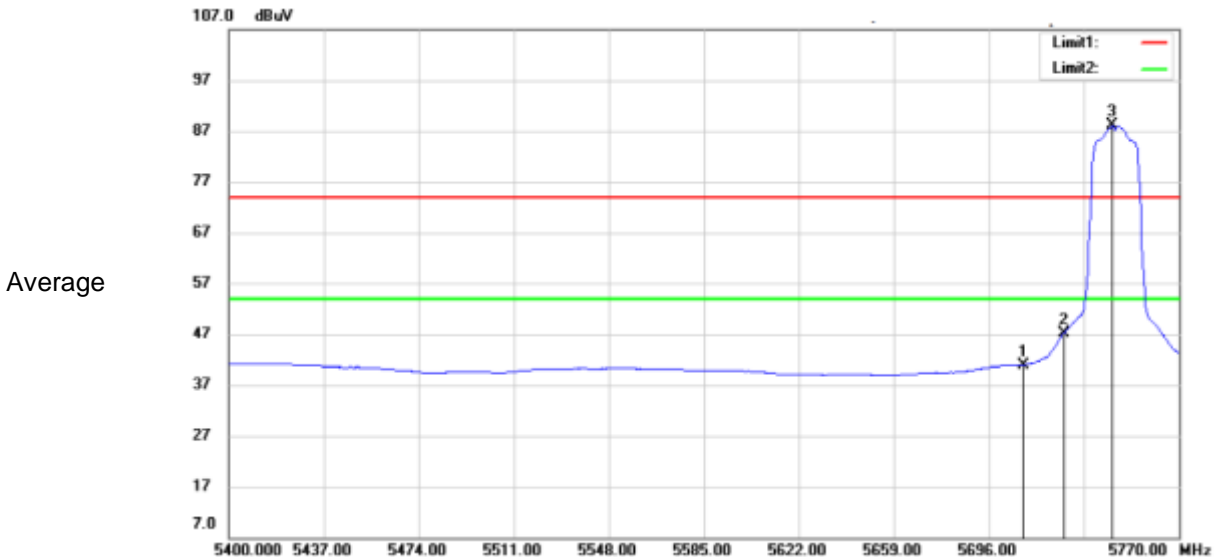
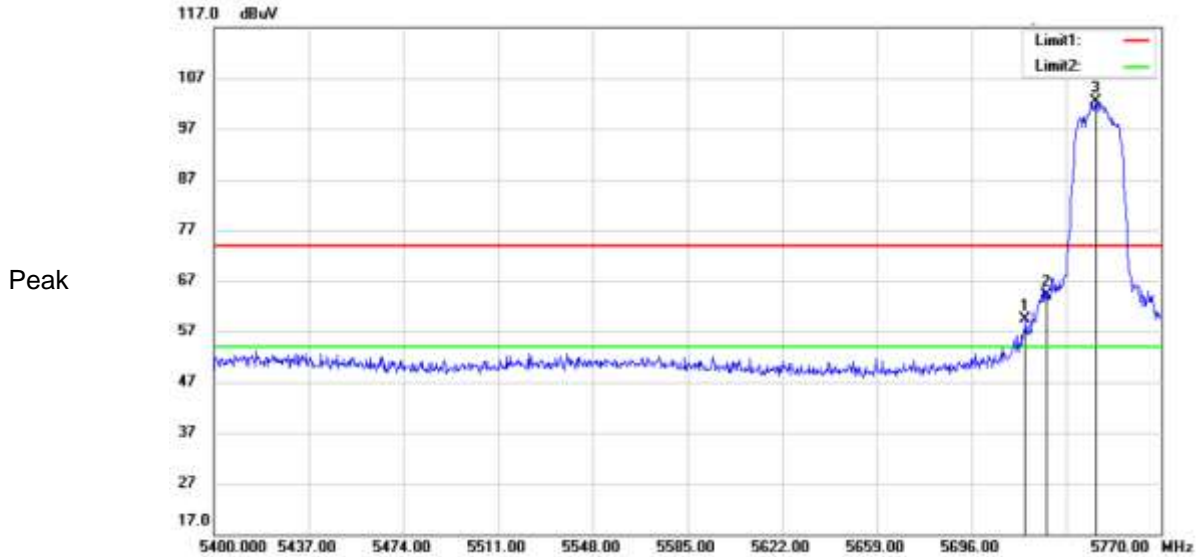

**802.11 n(HT20)**

**Channel: 5745**

| MK. | Frequency (MHz) | Reading (dBuV/m) | Corrected factor(dB) | Result (dBuV/m) | Limit (dBuV/m) | Over Limit (dB) | Detector | Polarization |
|-----|-----------------|------------------|----------------------|-----------------|----------------|-----------------|----------|--------------|
| 1   | 5719.68         | 51.05            | 6.82                 | 57.87           | 74             | -16.13          | Peak     | Vertical     |
| 2   | 5725            | 51.13            | 6.82                 | 57.95           | 74             | -16.05          | Peak     | Vertical     |
| 3   | 5746.32         | 90.08            | 6.77                 | 96.85           | 74             | 22.85           | Peak     | Vertical     |
| 1   | 5715.98         | 34.11            | 6.84                 | 40.95           | 54             | -13.05          | Average  | Vertical     |
| 2   | 5725            | 37.36            | 6.82                 | 44.18           | 54             | -9.82           | Average  | Vertical     |
| 3   | 5746.69         | 76.69            | 6.77                 | 83.46           | 54             | 29.46           | Average  | Vertical     |

Peak

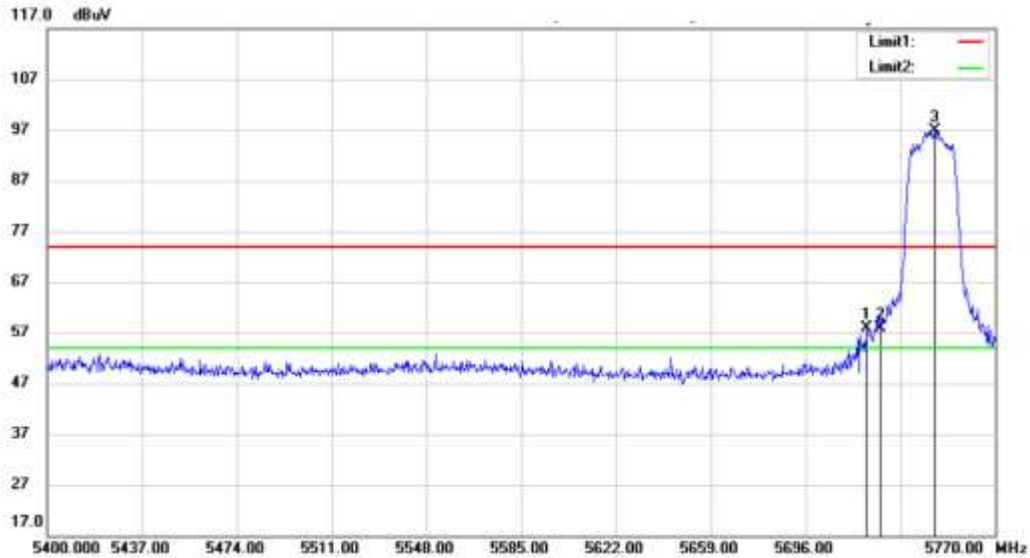

Average

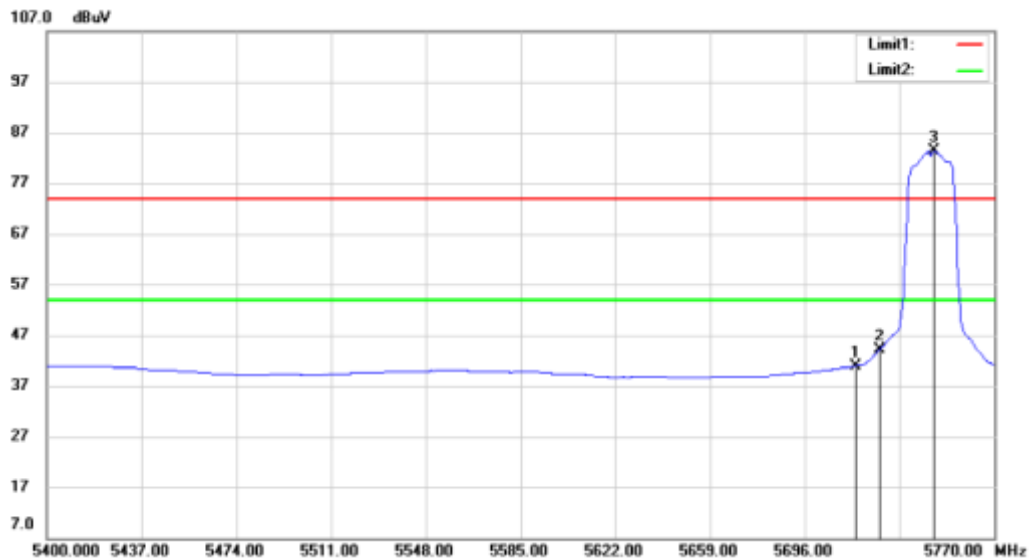

**802.11 n(HT20)**

**Channel: 5825**

| MK. | Frequency (MHz) | Reading (dBUV/m) | Corrected factor(dB) | Result (dBUV/m) | Limit (dBUV/m) | Over Limit (dB) | Detector | Polarization |
|-----|-----------------|------------------|----------------------|-----------------|----------------|-----------------|----------|--------------|
| 1   | 5826.4          | 96.21            | 6.66                 | 102.87          | 74             | 28.87           | Peak     | Horizontal   |
| 2   | 5850            | 51.38            | 6.64                 | 58.02           | 74             | -15.98          | Peak     | Horizontal   |
| 3   | 5852            | 53.81            | 6.64                 | 60.45           | 74             | -13.55          | Peak     | Horizontal   |
| 1   | 5824            | 81.97            | 6.65                 | 88.62           | 54             | 34.62           | Average  | Horizontal   |
| 2   | 5850            | 36.36            | 6.64                 | 43              | 54             | -11             | Average  | Horizontal   |
| 3   | 5857            | 35.72            | 6.63                 | 42.35           | 54             | -11.65          | Average  | Horizontal   |

Peak

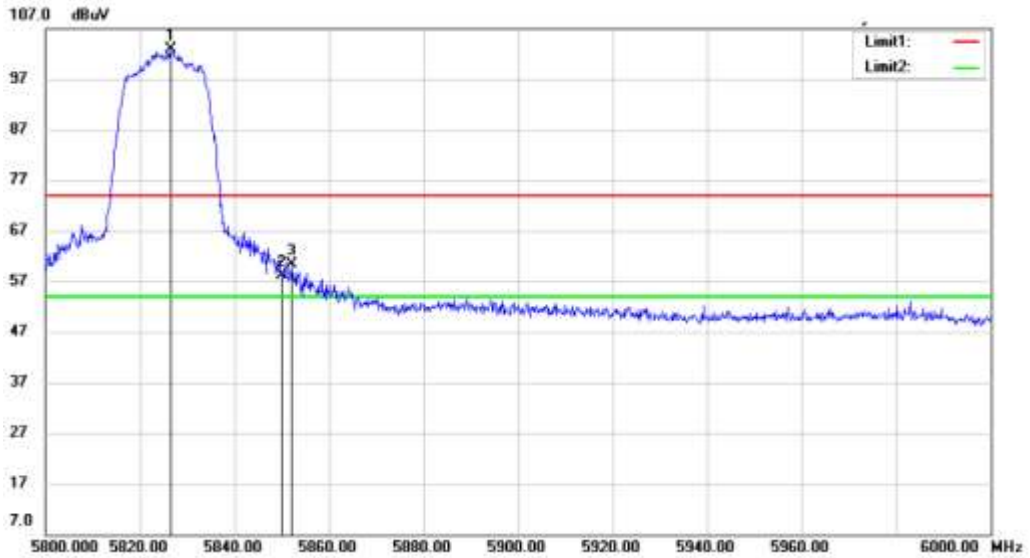

Average

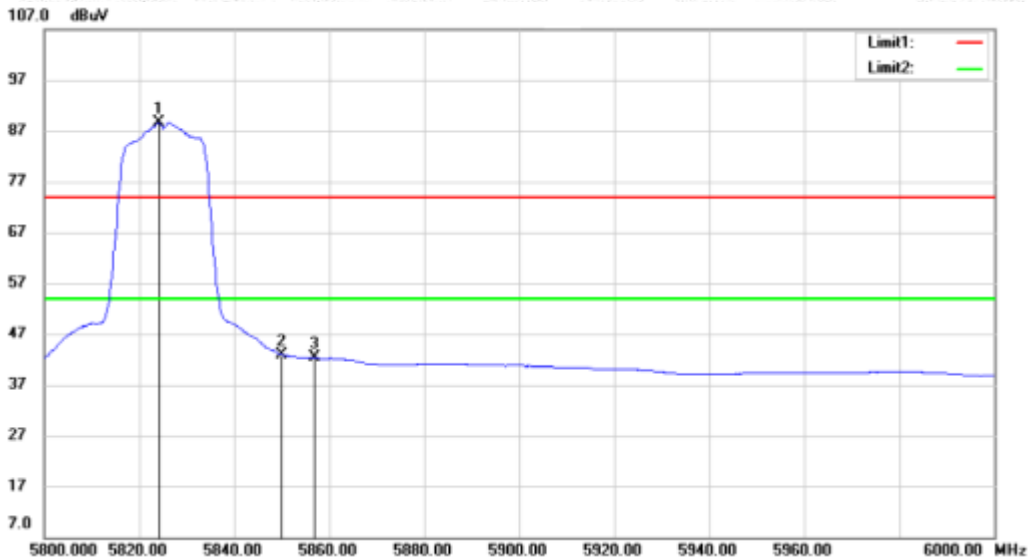

**802.11 n(HT20)**

**Channel: 5825**

| MK. | Frequency (MHz) | Reading (dBuV/m) | Corrected factor(dB) | Result (dBuV/m) | Limit (dBuV/m) | Over Limit (dB) | Detector | Polarization |
|-----|-----------------|------------------|----------------------|-----------------|----------------|-----------------|----------|--------------|
| 1   | 5824.6          | 87.79            | 6.65                 | 94.44           | 74             | 20.44           | Peak     | Vertical     |
| 2   | 5850            | 47.38            | 6.64                 | 54.02           | 74             | -19.98          | Peak     | Vertical     |
| 3   | 5853.4          | 46.88            | 6.64                 | 53.52           | 74             | -20.48          | Peak     | Vertical     |
| 1   | 5823.8          | 72.3             | 6.65                 | 78.95           | 54             | 24.95           | Average  | Vertical     |
| 2   | 5850            | 33.51            | 6.64                 | 40.15           | 54             | -13.85          | Average  | Vertical     |
| 3   | 5857.6          | 33.62            | 6.63                 | 40.25           | 54             | -13.75          | Average  | Vertical     |

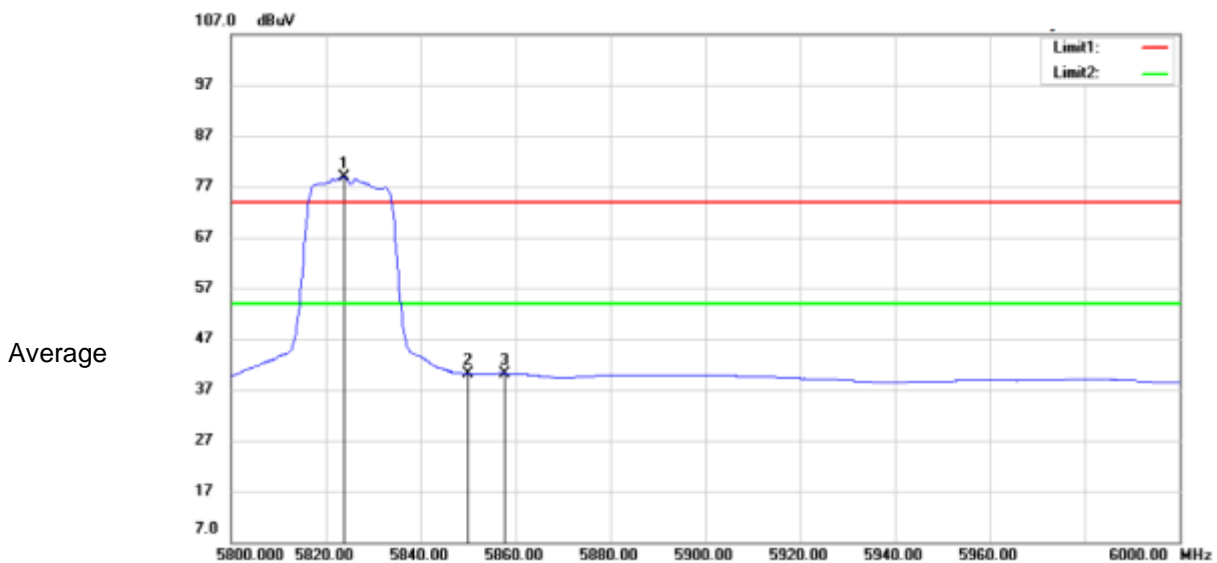
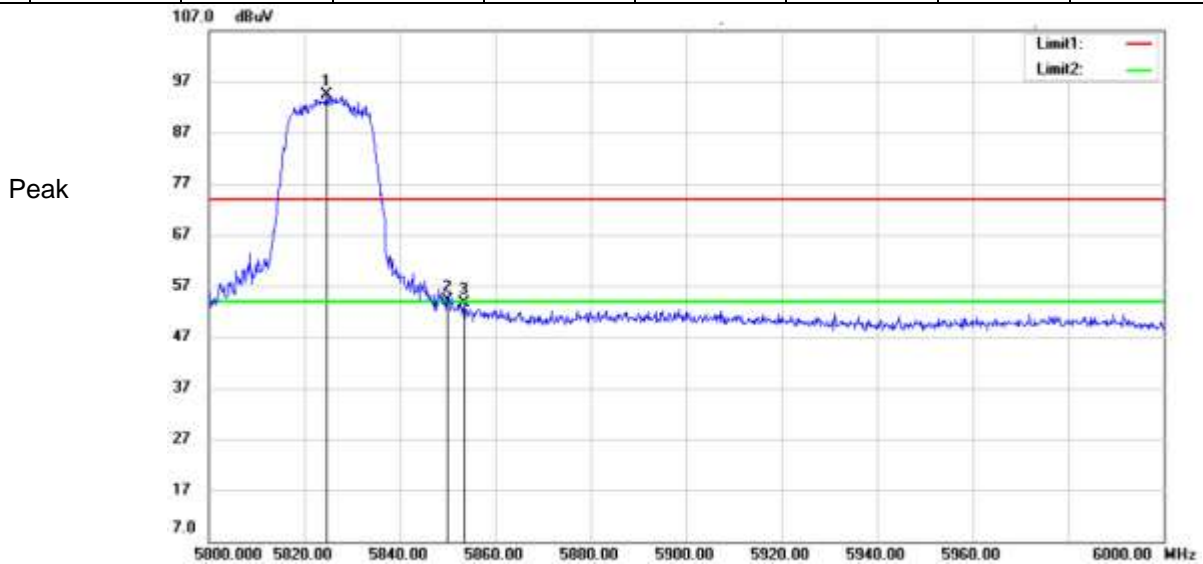

**802.11 n(HT40)**

**Channel: 5190**

| MK. | Frequency (MHz) | Reading (dBuV/m) | Corrected factor(dB) | Result (dBuV/m) | Limit (dBuV/m) | Over Limit (dB) | Detector | Polarization |
|-----|-----------------|------------------|----------------------|-----------------|----------------|-----------------|----------|--------------|
| 1   | 5146.78         | 56.32            | 6.94                 | 63.26           | 74             | -10.74          | Peak     | Horizontal   |
| 2   | 5150            | 51.76            | 6.92                 | 58.68           | 74             | -15.32          | Peak     | Horizontal   |
| 3   | 5192.04         | 95.99            | 6.7                  | 102.69          | 74             | 28.69           | Peak     | Horizontal   |
| 1   | 5132.91         | 34.69            | 7.01                 | 41.7            | 54             | -12.3           | Average  | Horizontal   |
| 2   | 5150            | 36.16            | 6.92                 | 43.08           | 54             | -10.92          | Average  | Horizontal   |
| 3   | 5194.23         | 79.65            | 6.68                 | 86.33           | 54             | 32.33           | Average  | Horizontal   |

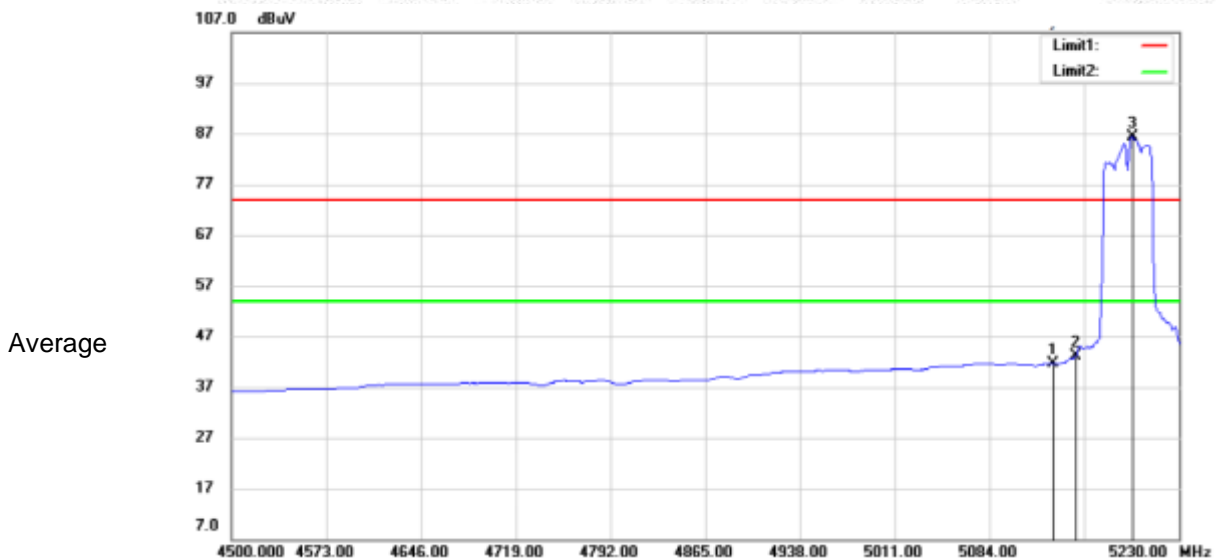
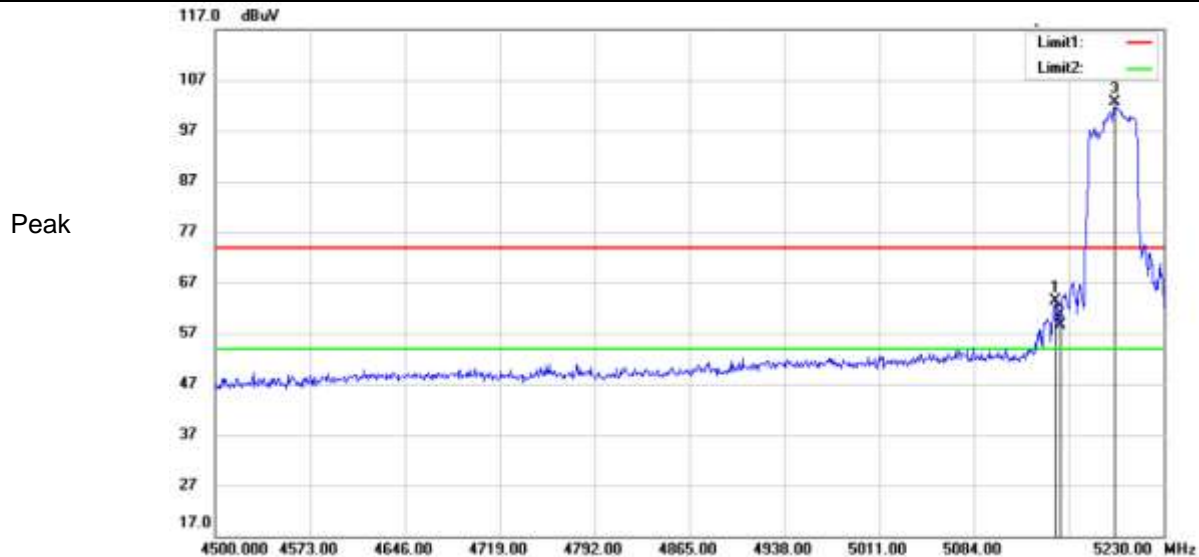

**802.11 n(HT40)**

**Channel: 5190**

| MK. | Frequency (MHz) | Reading (dBuV/m) | Corrected factor(dB) | Result (dBuV/m) | Limit (dBuV/m) | Over Limit (dB) | Detector | Polarization |
|-----|-----------------|------------------|----------------------|-----------------|----------------|-----------------|----------|--------------|
| 1   | 5140.21         | 55.91            | 6.98                 | 62.89           | 74             | -11.11          | Peak     | Vertical     |
| 2   | 5150            | 55.42            | 6.92                 | 62.34           | 74             | -11.66          | Peak     | Vertical     |
| 3   | 5205.91         | 90.43            | 6.65                 | 97.08           | 74             | 23.08           | Peak     | Vertical     |
| 1   | 5084            | 34.67            | 7.28                 | 41.95           | 54             | -12.05          | Average  | Vertical     |
| 2   | 5150            | 36.47            | 6.92                 | 43.39           | 54             | -10.61          | Average  | Vertical     |
| 3   | 5194.23         | 74.6             | 6.68                 | 81.28           | 54             | 27.28           | Average  | Vertical     |

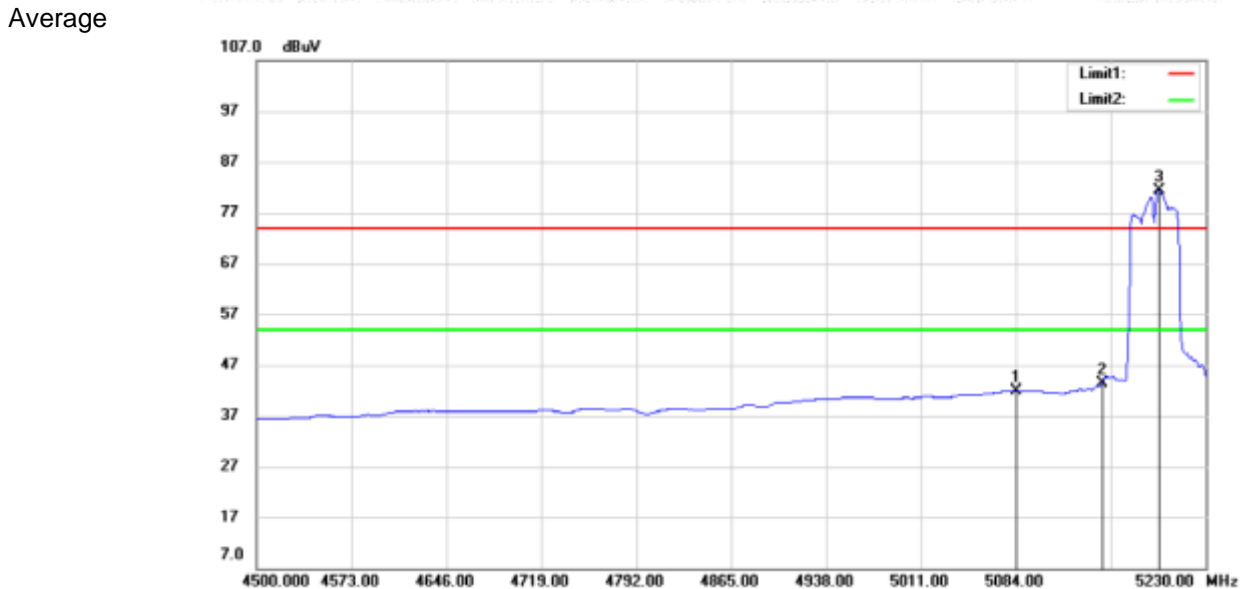
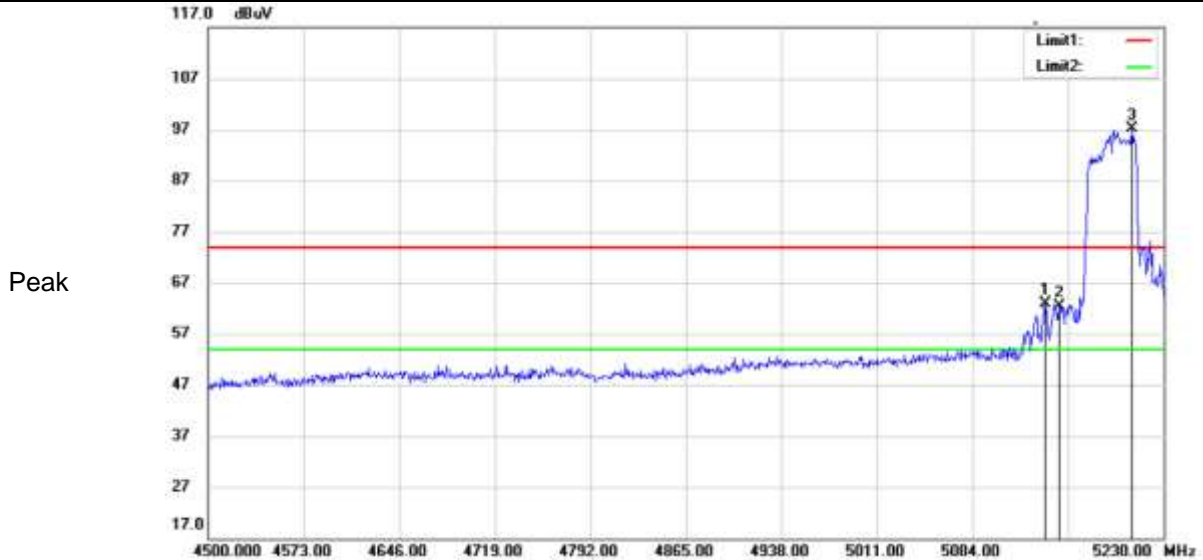

**802.11 n(HT40)**

**Channel: 5230**

| MK. | Frequency (MHz) | Reading (dBuV/m) | Corrected factor(dB) | Result (dBuV/m) | Limit (dBuV/m) | Over Limit (dB) | Detector | Polarization |
|-----|-----------------|------------------|----------------------|-----------------|----------------|-----------------|----------|--------------|
| 1   | 5231.32         | 93.82            | 6.65                 | 100.47          | 54             | 46.47           | Peak     | Horizontal   |
| 2   | 5350            | 43.36            | 6.98                 | 50.34           | 54             | -3.66           | Peak     | Horizontal   |
| 3   | 5395.21         | 46.12            | 7.29                 | 53.41           | 54             | -0.59           | Peak     | Horizontal   |
| 1   | 5227.81         | 91.04            | 6.64                 | 97.68           | 54             | 43.68           | Peak     | Vertical     |
| 2   | 5350            | 43.96            | 6.98                 | 50.94           | 54             | -3.06           | Peak     | Vertical     |
| 3   | 5396.29         | 46.13            | 7.29                 | 53.42           | 54             | -0.58           | Peak     | Vertical     |

Vertical



Horizontal





**802.11 n(HT40)**

**Channel: 5755**

| MK. | Frequency (MHz) | Reading (dBuV/m) | Corrected factor(dB) | Result (dBuV/m) | Limit (dBuV/m) | Over Limit (dB) | Detector | Polarization |
|-----|-----------------|------------------|----------------------|-----------------|----------------|-----------------|----------|--------------|
| 1   | 5719.41         | 61.29            | 6.82                 | 68.11           | 74             | -5.89           | Peak     | Horizontal   |
| 2   | 5725            | 62.86            | 6.82                 | 69.68           | 74             | -4.32           | Peak     | Horizontal   |
| 3   | 5758.8          | 92.76            | 6.75                 | 99.51           | 74             | 25.51           | Peak     | Horizontal   |
| 1   | 5721.75         | 43.88            | 6.83                 | 50.71           | 54             | -3.29           | Average  | Horizontal   |
| 2   | 5725            | 43.78            | 6.82                 | 50.6            | 54             | -3.4            | Average  | Horizontal   |
| 3   | 5761.53         | 77.9             | 6.74                 | 84.64           | 54             | 30.64           | Average  | Horizontal   |

Peak

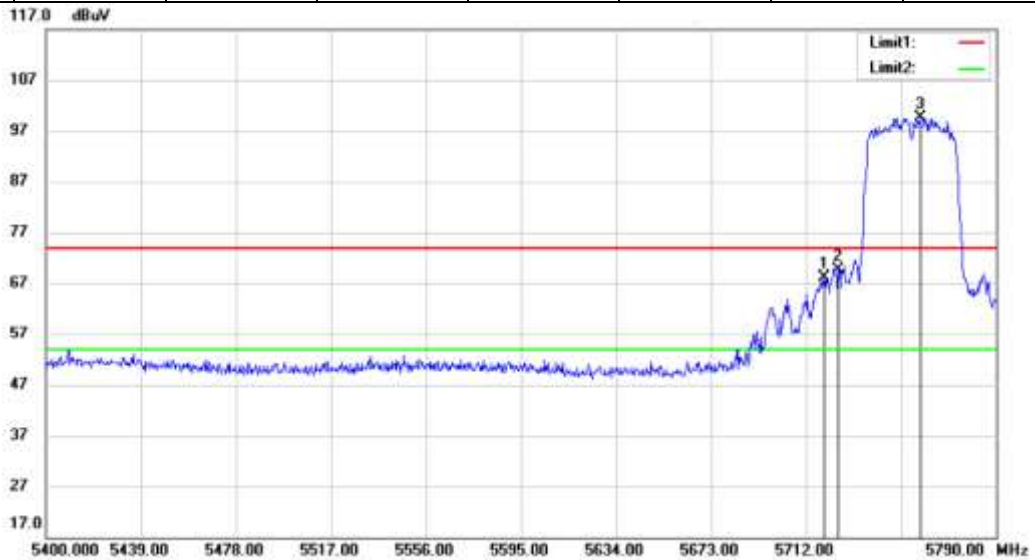

Average

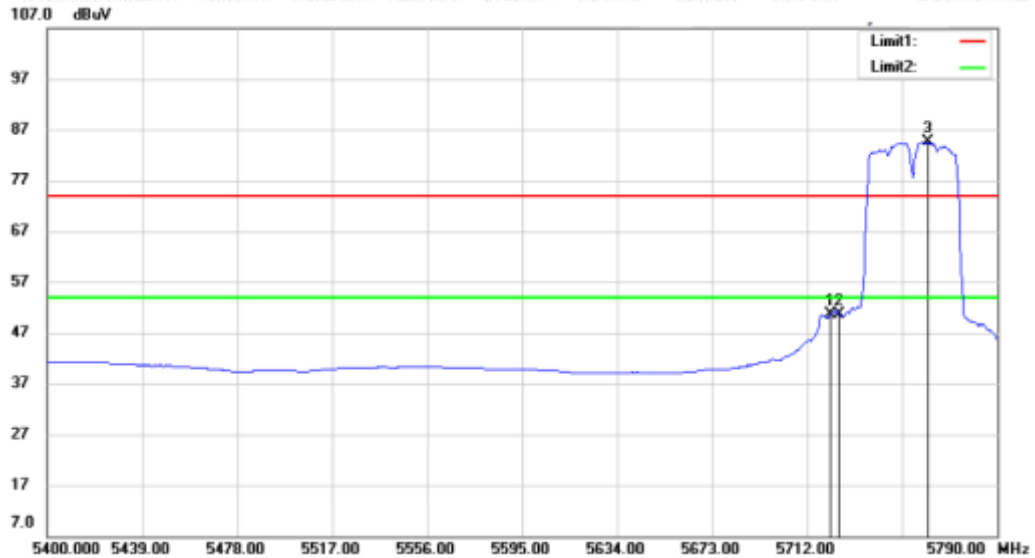

**802.11 n(HT40)**

**Channel: 5755**

| MK. | Frequency (MHz) | Reading (dBuV/m) | Corrected factor(dB) | Result (dBuV/m) | Limit (dBuV/m) | Over Limit (dB) | Detector | Polarization |
|-----|-----------------|------------------|----------------------|-----------------|----------------|-----------------|----------|--------------|
| 1   | 5719.8          | 54.7             | 6.82                 | 61.52           | 74             | -12.48          | Peak     | Vertical     |
| 2   | 5725            | 53.69            | 6.82                 | 60.51           | 74             | -13.49          | Peak     | Vertical     |
| 3   | 5759.97         | 87.44            | 6.75                 | 94.19           | 74             | 20.19           | Peak     | Vertical     |
| 1   | 5717.85         | 37.6             | 6.84                 | 44.44           | 54             | -9.56           | Average  | Vertical     |
| 2   | 5725            | 37.27            | 6.82                 | 44.09           | 54             | -9.91           | Average  | Vertical     |
| 3   | 5750.22         | 69.16            | 6.77                 | 75.93           | 54             | 21.93           | Average  | Vertical     |

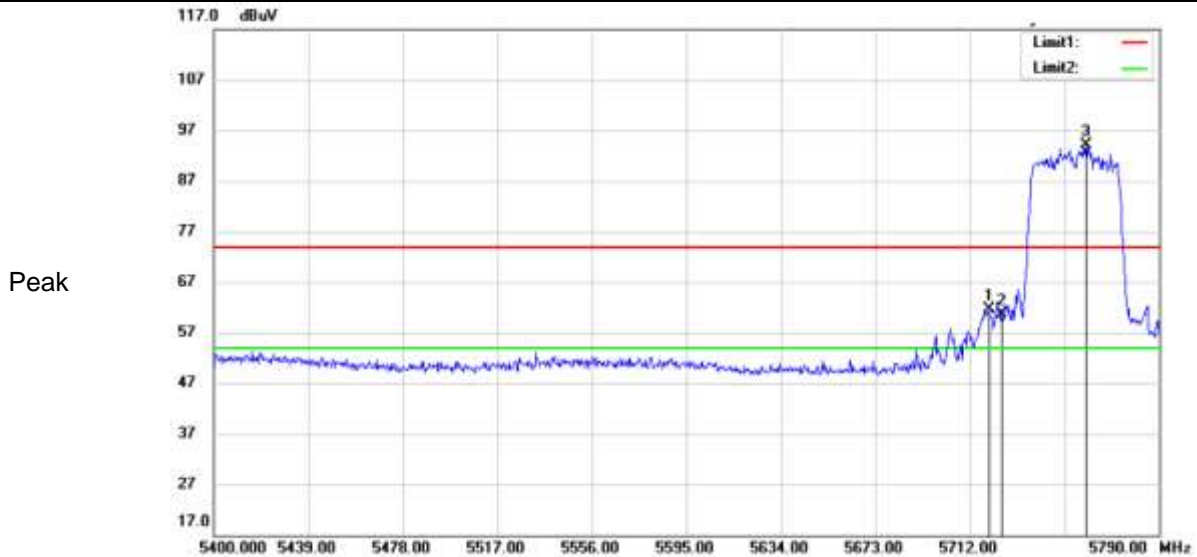

Average

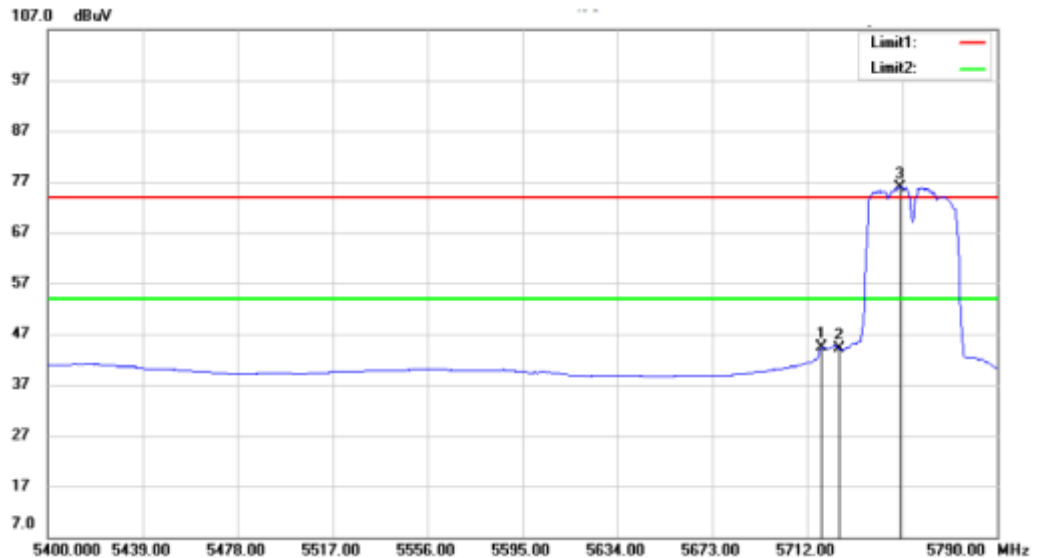

**802.11 n(HT40)**

**Channel: 5795**

| MK. | Frequency (MHz) | Reading (dBUV/m) | Corrected factor(dB) | Result (dBUV/m) | Limit (dBUV/m) | Over Limit (dB) | Detector | Polarization |
|-----|-----------------|------------------|----------------------|-----------------|----------------|-----------------|----------|--------------|
| 1   | 5799.6          | 92.61            | 6.67                 | 99.28           | 74             | 25.28           | Peak     | Horizontal   |
| 2   | 5850            | 54.71            | 6.64                 | 61.35           | 74             | -12.65          | Peak     | Horizontal   |
| 3   | 5851.2          | 55.64            | 6.64                 | 62.28           | 74             | -11.72          | Peak     | Horizontal   |
| 1   | 5801.28         | 76.89            | 6.67                 | 83.56           | 54             | 29.56           | Average  | Horizontal   |
| 2   | 5850            | 36.12            | 6.64                 | 42.76           | 54             | -11.24          | Average  | Horizontal   |
| 3   | 5860.32         | 35.97            | 6.63                 | 42.6            | 54             | -11.4           | Average  | Horizontal   |

Peak

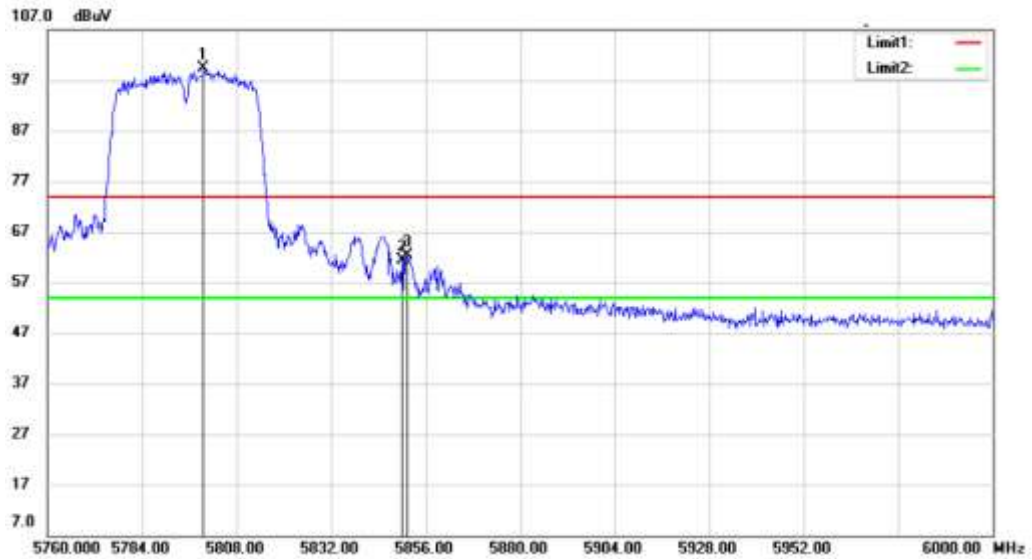

Average

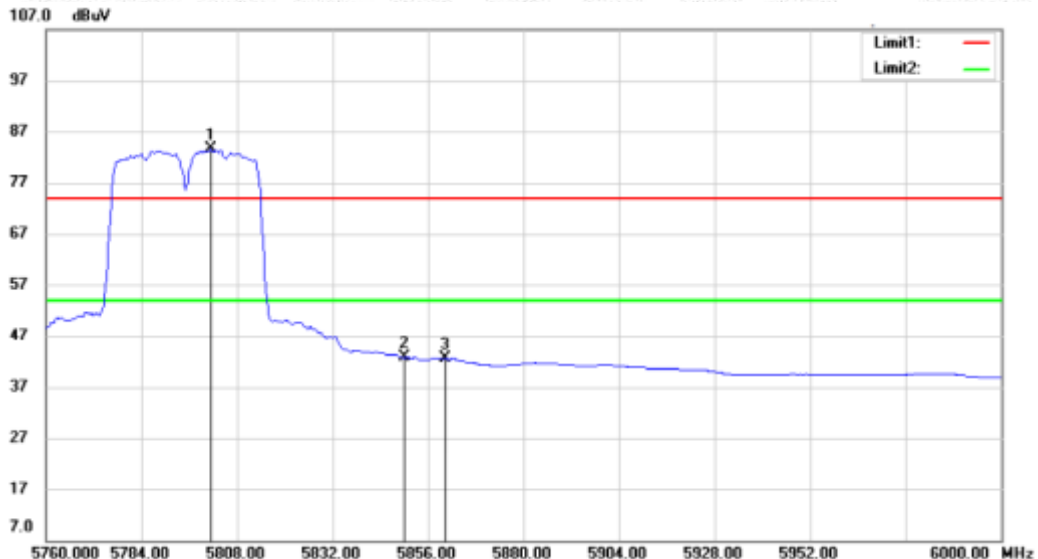

**802.11 n(HT40)**

**Channel: 5795**

| MK. | Frequency (MHz) | Reading (dBuV/m) | Corrected factor(dB) | Result (dBuV/m) | Limit (dBuV/m) | Over Limit (dB) | Detector | Polarization |
|-----|-----------------|------------------|----------------------|-----------------|----------------|-----------------|----------|--------------|
| 1   | 5790.24         | 86.89            | 6.69                 | 93.58           | 74             | 19.58           | Peak     | Vertical     |
| 2   | 5850            | 46.8             | 6.64                 | 53.44           | 74             | -20.56          | Peak     | Vertical     |
| 3   | 5851.68         | 48.84            | 6.64                 | 55.48           | 74             | -18.52          | Peak     | Vertical     |
| 1   | 5788.56         | 71.66            | 6.69                 | 78.35           | 54             | 24.35           | Average  | Vertical     |
| 2   | 5850            | 33.68            | 6.64                 | 40.32           | 54             | -13.68          | Average  | Vertical     |
| 3   | 5857.44         | 33.84            | 6.63                 | 40.47           | 54             | -13.53          | Average  | Vertical     |

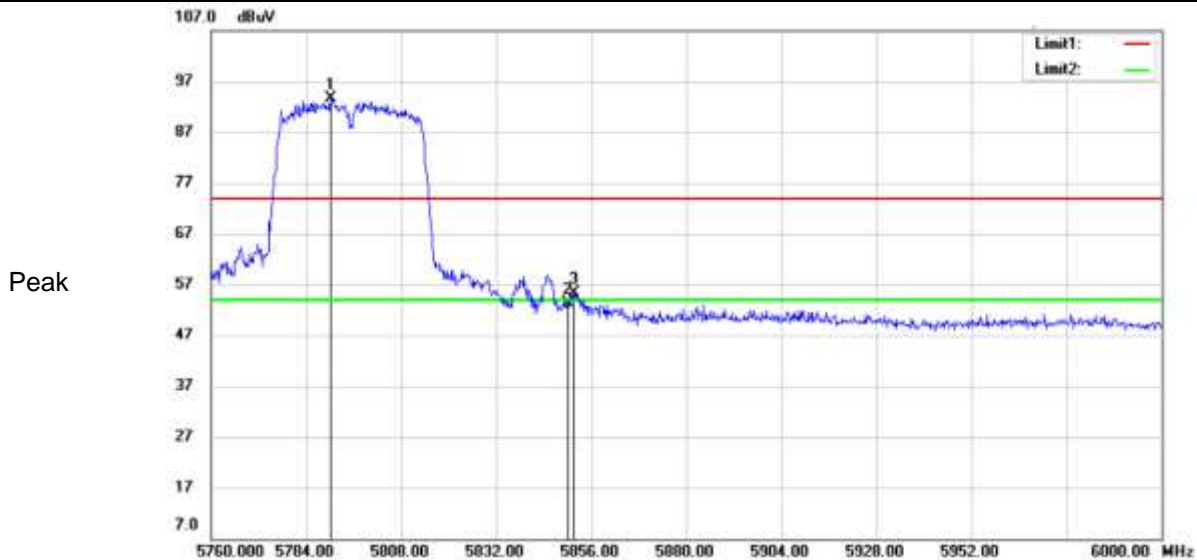

Average

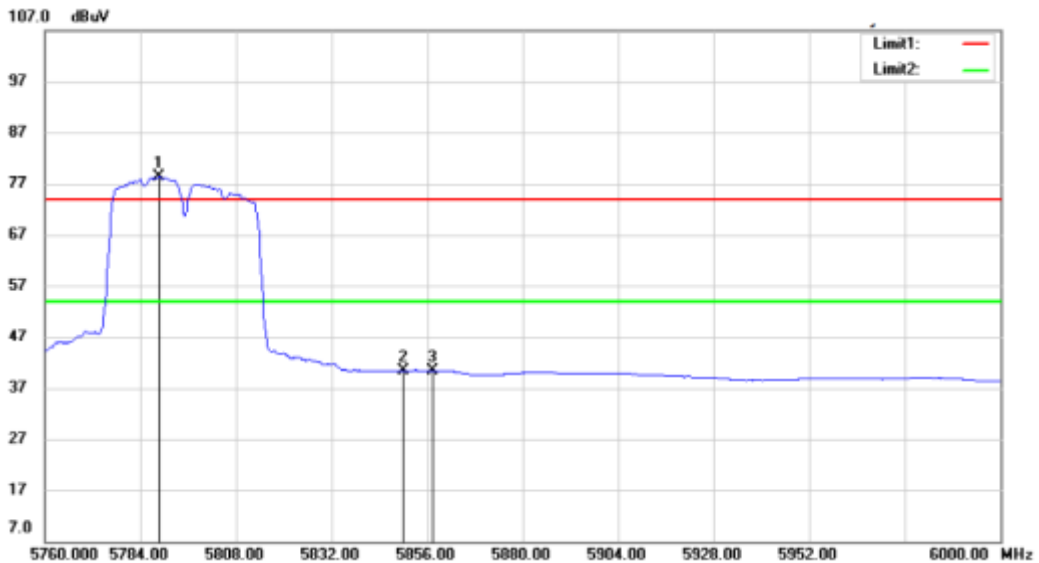

**802.11 ac(VHT20)**

**Channel: 5180**

| MK. | Frequency (MHz) | Reading (dBuV/m) | Corrected factor(dB) | Result (dBuV/m) | Limit (dBuV/m) | Over Limit (dB) | Detector | Polarization |
|-----|-----------------|------------------|----------------------|-----------------|----------------|-----------------|----------|--------------|
| 1   | 5143.97         | 49.69            | 6.96                 | 56.65           | 74             | -17.35          | Peak     | Horizontal   |
| 2   | 5150            | 47.8             | 6.92                 | 54.72           | 74             | -19.28          | Peak     | Horizontal   |
| 3   | 5183.73         | 95.39            | 6.74                 | 102.13          | 74             | 28.13           | Peak     | Horizontal   |
| 1   | 5076.52         | 34.14            | 7.32                 | 41.46           | 54             | -12.54          | Average  | Horizontal   |
| 2   | 5150            | 35.57            | 6.92                 | 42.49           | 54             | -11.51          | Average  | Horizontal   |
| 3   | 5181.6          | 81.23            | 6.75                 | 87.98           | 54             | 33.98           | Average  | Horizontal   |

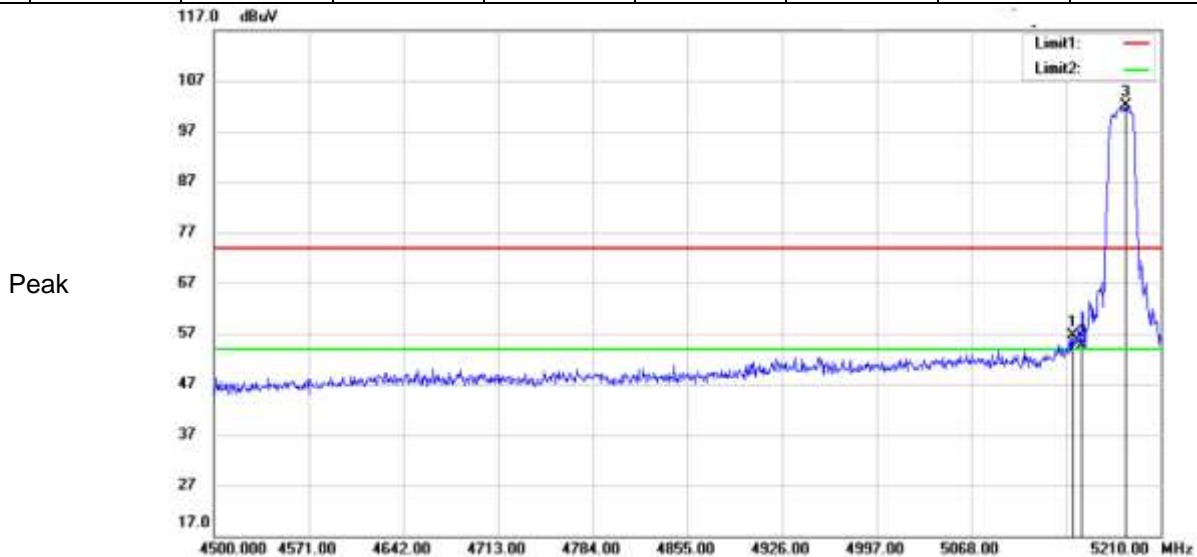

Average

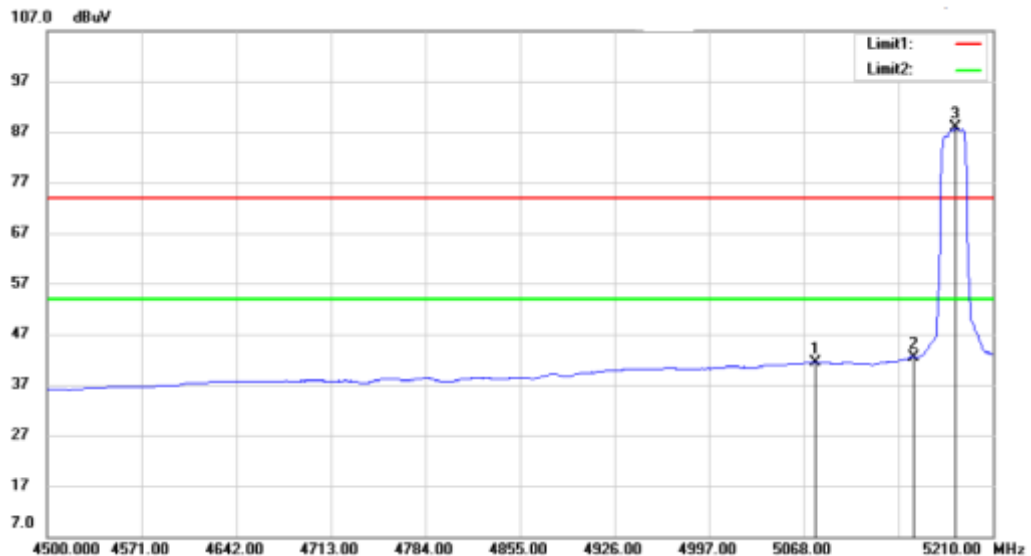

**802.11 ac(VHT20)**

**Channel: 5180**

| MK. | Frequency (MHz) | Reading (dBuV/m) | Corrected factor(dB) | Result (dBuV/m) | Limit (dBuV/m) | Over Limit (dB) | Detector | Polarization |
|-----|-----------------|------------------|----------------------|-----------------|----------------|-----------------|----------|--------------|
| 1   | 5145.39         | 50.24            | 6.95                 | 57.19           | 74             | -16.81          | Peak     | Vertical     |
| 2   | 5150            | 50.83            | 6.92                 | 57.75           | 74             | -16.25          | Peak     | Vertical     |
| 3   | 5183.02         | 88.57            | 6.74                 | 95.31           | 74             | 21.31           | Peak     | Vertical     |
| 1   | 5085.04         | 34.63            | 7.28                 | 41.91           | 54             | -12.09          | Average  | Vertical     |
| 2   | 5150            | 34.44            | 6.92                 | 41.36           | 54             | -12.64          | Average  | Vertical     |
| 3   | 5181.6          | 74.36            | 6.75                 | 81.11           | 54             | 27.11           | Average  | Vertical     |

Peak

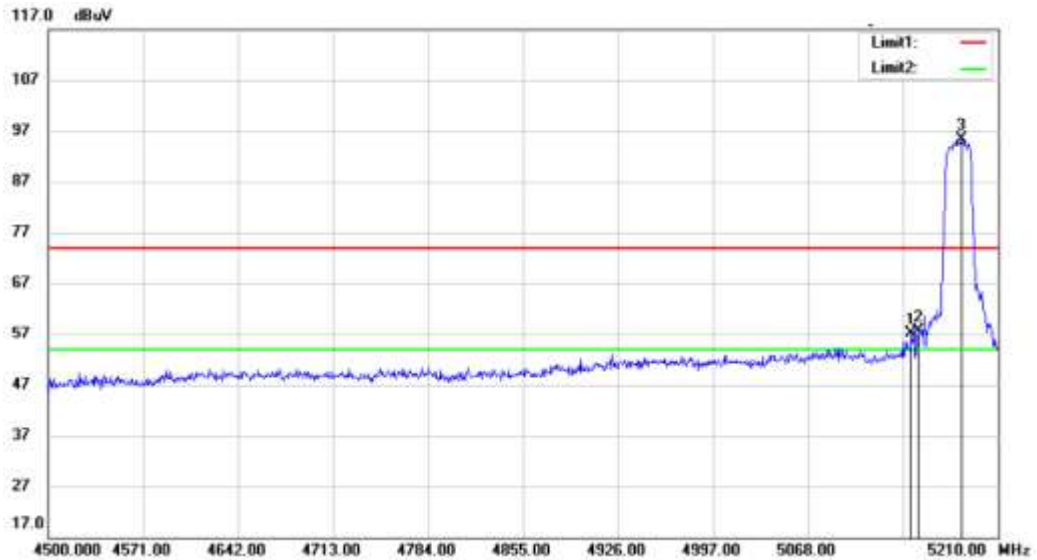

Average

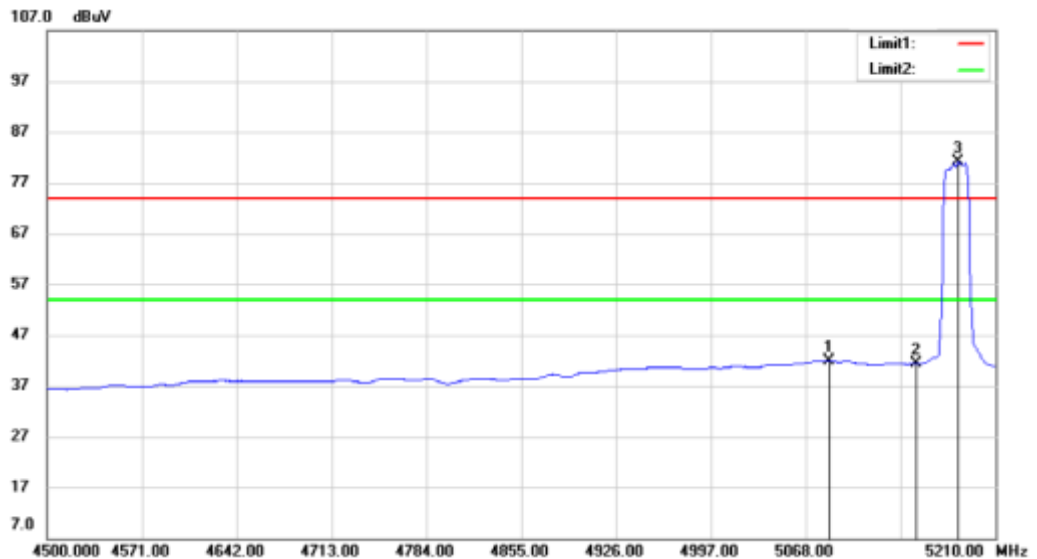

**802.11 ac(VHT20)**

**Channel: 5240**

| MK. | Frequency (MHz) | Reading (dBuV/m) | Corrected factor(dB) | Result (dBuV/m) | Limit (dBuV/m) | Over Limit (dB) | Detector | Polarization |
|-----|-----------------|------------------|----------------------|-----------------|----------------|-----------------|----------|--------------|
| 1   | 5242.93         | 97.66            | 6.65                 | 104.31          | 54             | 50.31           | Peak     | Horizontal   |
| 2   | 5350            | 42.99            | 6.98                 | 49.97           | 54             | -4.03           | Peak     | Horizontal   |
| 3   | 5411.95         | 45.7             | 7.28                 | 52.98           | 54             | -1.02           | Peak     | Horizontal   |
| 1   | 5241.85         | 92.26            | 6.65                 | 98.91           | 54             | 44.91           | Peak     | Vertical     |
| 2   | 5350            | 42.41            | 6.98                 | 49.39           | 54             | -4.61           | Peak     | Vertical     |
| 3   | 5386.57         | 46.1             | 7.23                 | 53.33           | 54             | -0.67           | Peak     | Vertical     |

Vertical

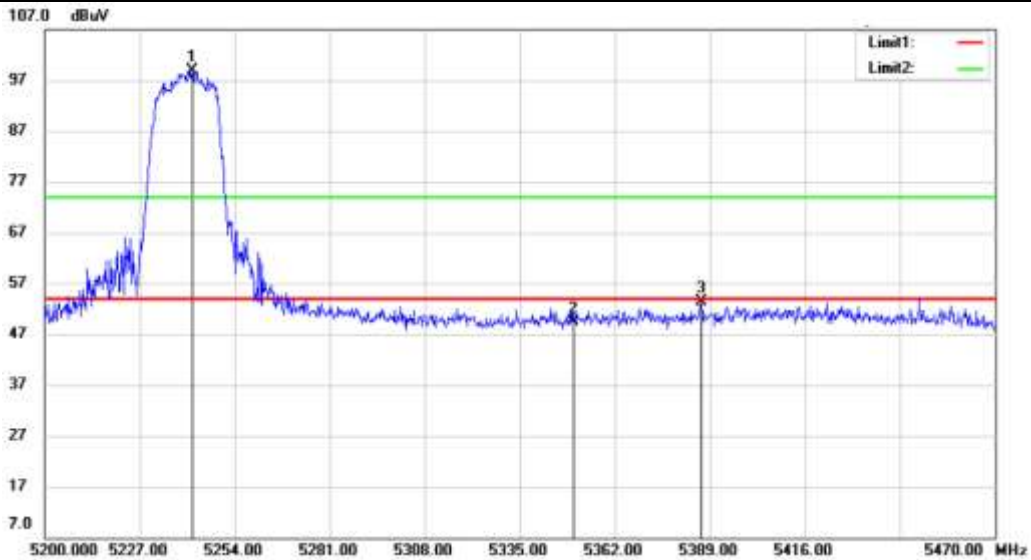

Horizontal

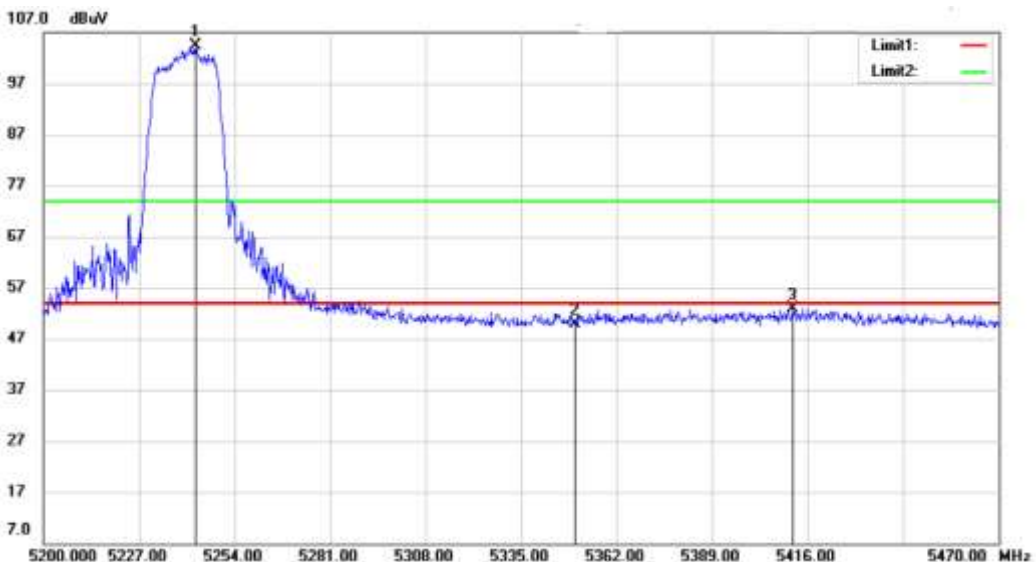

**802.11 ac(VHT20)**

**Channel: 5745**

| MK. | Frequency (MHz) | Reading (dBUV/m) | Corrected factor(dB) | Result (dBUV/m) | Limit (dBUV/m) | Over Limit (dB) | Detector | Polarization |
|-----|-----------------|------------------|----------------------|-----------------|----------------|-----------------|----------|--------------|
| 1   | 5719.68         | 54.91            | 6.82                 | 61.73           | 74             | -12.27          | Peak     | Horizontal   |
| 2   | 5725            | 58.51            | 6.82                 | 65.33           | 74             | -8.67           | Peak     | Horizontal   |
| 3   | 5746.32         | 95.18            | 6.77                 | 101.95          | 74             | 27.95           | Peak     | Horizontal   |
| 1   | 5709.69         | 34.11            | 6.85                 | 40.96           | 54             | -13.04          | Average  | Horizontal   |
| 2   | 5725            | 40.28            | 6.82                 | 47.1            | 54             | -6.9            | Average  | Horizontal   |
| 3   | 5746.32         | 81.2             | 6.77                 | 87.97           | 54             | 33.97           | Average  | Horizontal   |

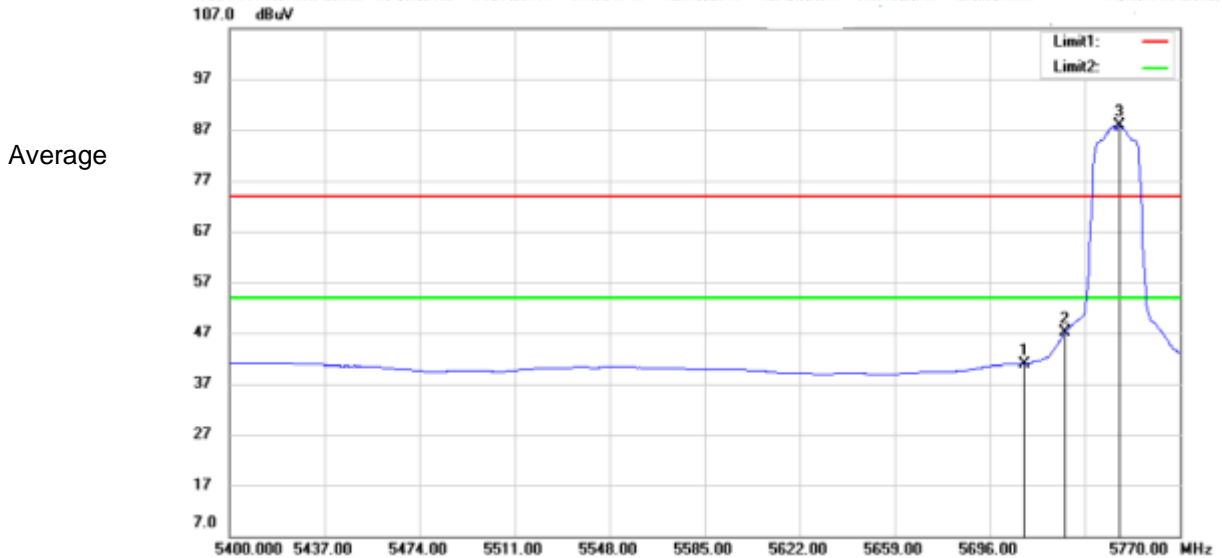
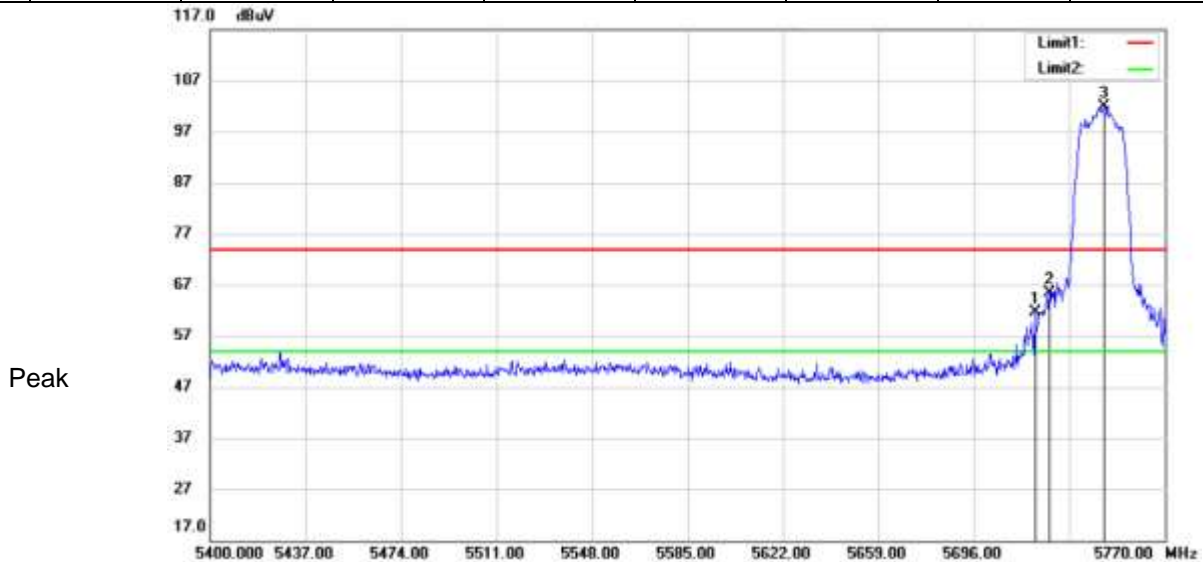



**802.11 ac(VHT20)**

**Channel: 5745**

| MK. | Frequency (MHz) | Reading (dBuV/m) | Corrected factor(dB) | Result (dBuV/m) | Limit (dBuV/m) | Over Limit (dB) | Detector | Polarization |
|-----|-----------------|------------------|----------------------|-----------------|----------------|-----------------|----------|--------------|
| 1   | 5721.9          | 51.88            | 6.83                 | 58.71           | 74             | -15.29          | Peak     | Vertical     |
| 2   | 5725            | 53.61            | 6.82                 | 60.43           | 74             | -13.57          | Peak     | Vertical     |
| 3   | 5746.69         | 90.5             | 6.77                 | 97.27           | 74             | 23.27           | Peak     | Vertical     |
| 1   | 5716.35         | 34.07            | 6.84                 | 40.91           | 54             | -13.09          | Average  | Vertical     |
| 2   | 5725            | 37.06            | 6.82                 | 43.88           | 54             | -10.12          | Average  | Vertical     |
| 3   | 5746.69         | 76.51            | 6.77                 | 83.28           | 54             | 29.28           | Average  | Vertical     |

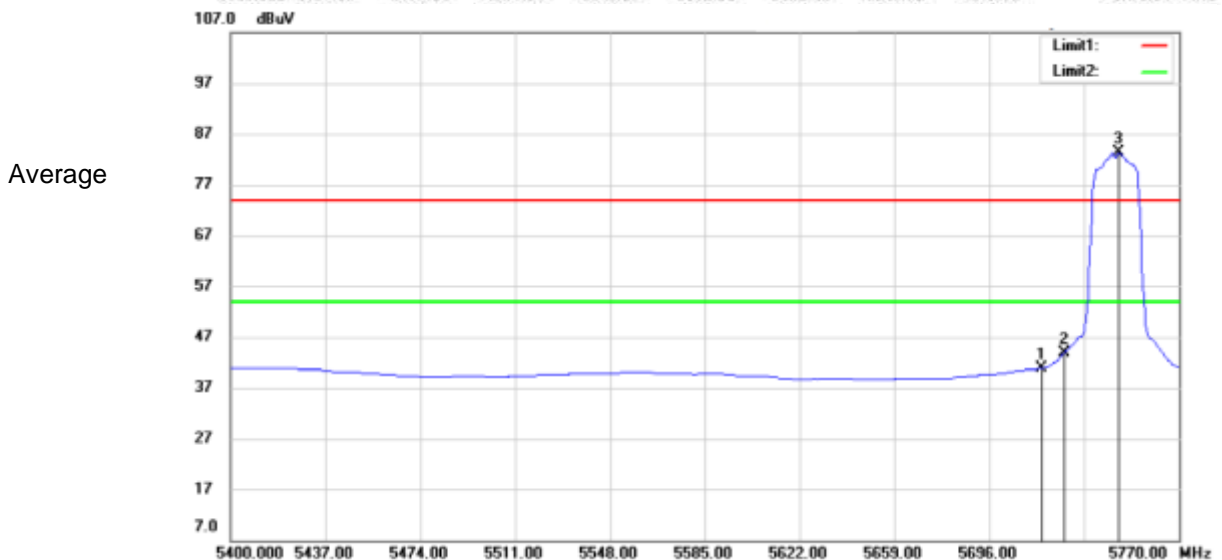
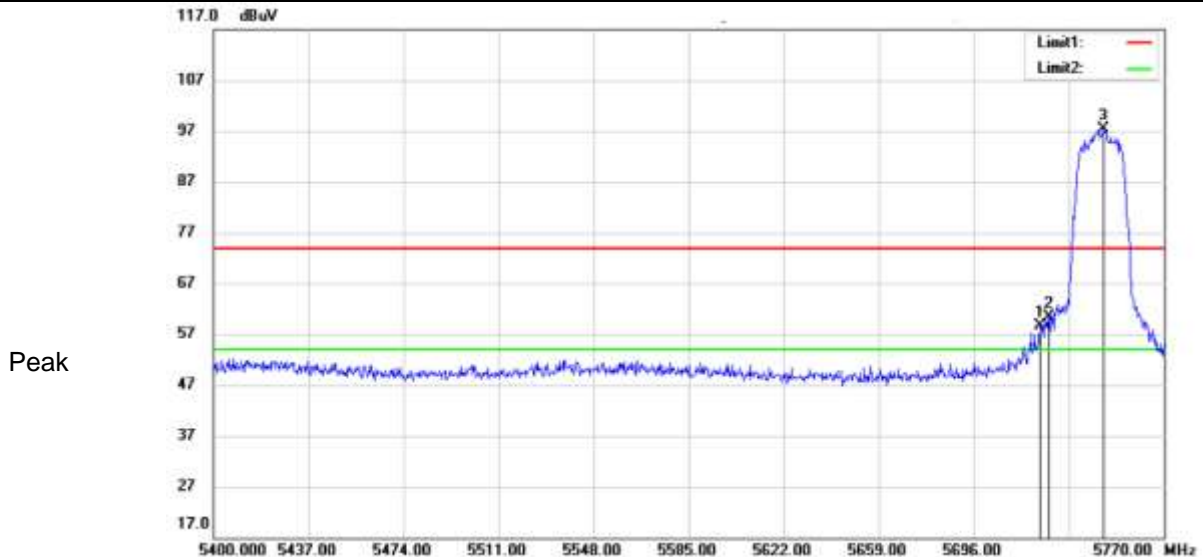

**802.11 ac(VHT20)**

**Channel: 5825**

| MK. | Frequency (MHz) | Reading (dBUV/m) | Corrected factor(dB) | Result (dBUV/m) | Limit (dBUV/m) | Over Limit (dB) | Detector | Polarization |
|-----|-----------------|------------------|----------------------|-----------------|----------------|-----------------|----------|--------------|
| 1   | 5826.8          | 96.39            | 6.66                 | 103.05          | 74             | 29.05           | Peak     | Horizontal   |
| 2   | 5850            | 52.88            | 6.64                 | 59.52           | 74             | -14.48          | Peak     | Horizontal   |
| 3   | 5851.6          | 55.66            | 6.64                 | 62.3            | 74             | -11.7           | Peak     | Horizontal   |
| 1   | 5826.2          | 81.61            | 6.66                 | 88.27           | 54             | 34.27           | Average  | Horizontal   |
| 2   | 5850            | 35.83            | 6.64                 | 42.47           | 54             | -11.53          | Average  | Horizontal   |
| 3   | 5860.4          | 35.48            | 6.63                 | 42.11           | 54             | -11.89          | Average  | Horizontal   |

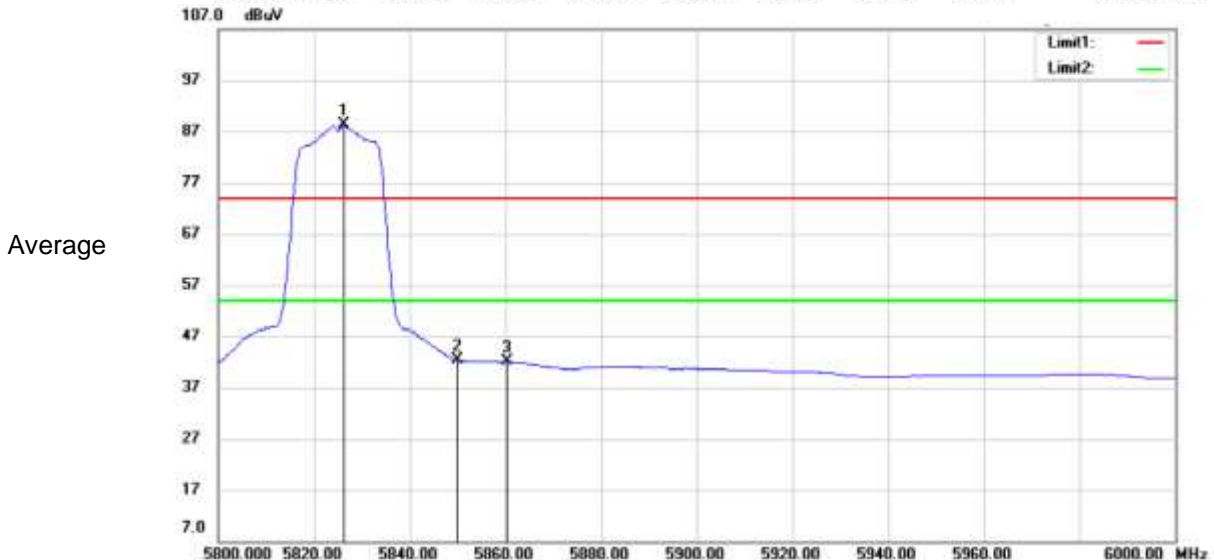
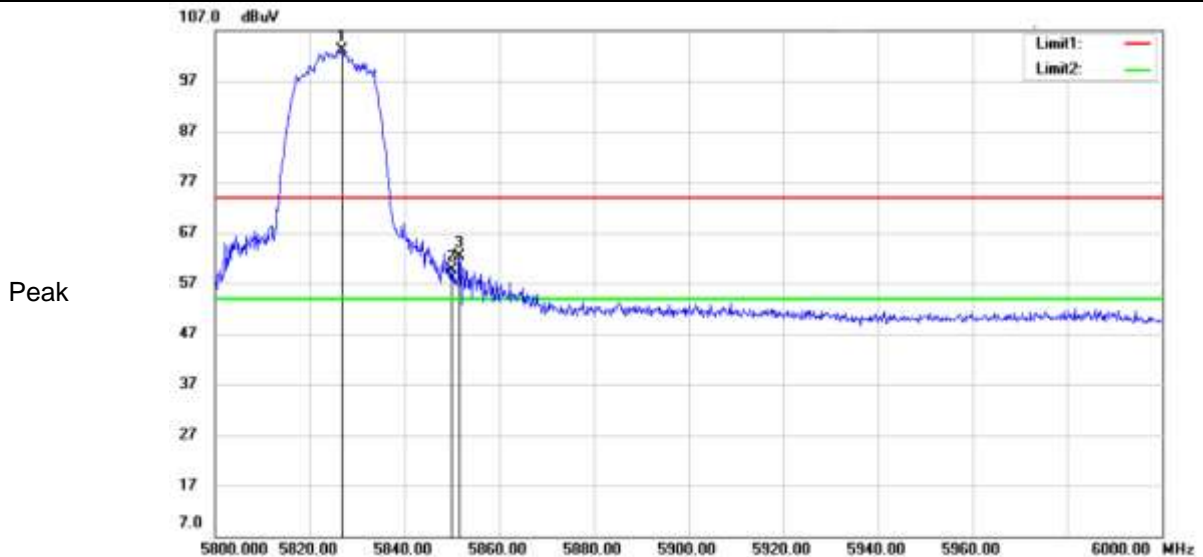

**802.11 ac(VHT20)**

**Channel: 5825**

| MK. | Frequency (MHz) | Reading (dBuV/m) | Corrected factor(dB) | Result (dBuV/m) | Limit (dBuV/m) | Over Limit (dB) | Detector | Polarization |
|-----|-----------------|------------------|----------------------|-----------------|----------------|-----------------|----------|--------------|
| 1   | 5823.4          | 86.72            | 6.65                 | 93.37           | 74             | 19.37           | Peak     | Vertical     |
| 2   | 5850            | 47.15            | 6.64                 | 53.79           | 74             | -20.21          | Peak     | Vertical     |
| 3   | 5852.4          | 48.64            | 6.64                 | 55.28           | 74             | -18.72          | Peak     | Vertical     |
| 1   | 5823.8          | 72.13            | 6.65                 | 78.78           | 54             | 24.78           | Average  | Vertical     |
| 2   | 5850            | 33.66            | 6.64                 | 40.3            | 54             | -13.7           | Average  | Vertical     |
| 3   | 5856.6          | 33.57            | 6.63                 | 40.2            | 54             | -13.8           | Average  | Vertical     |

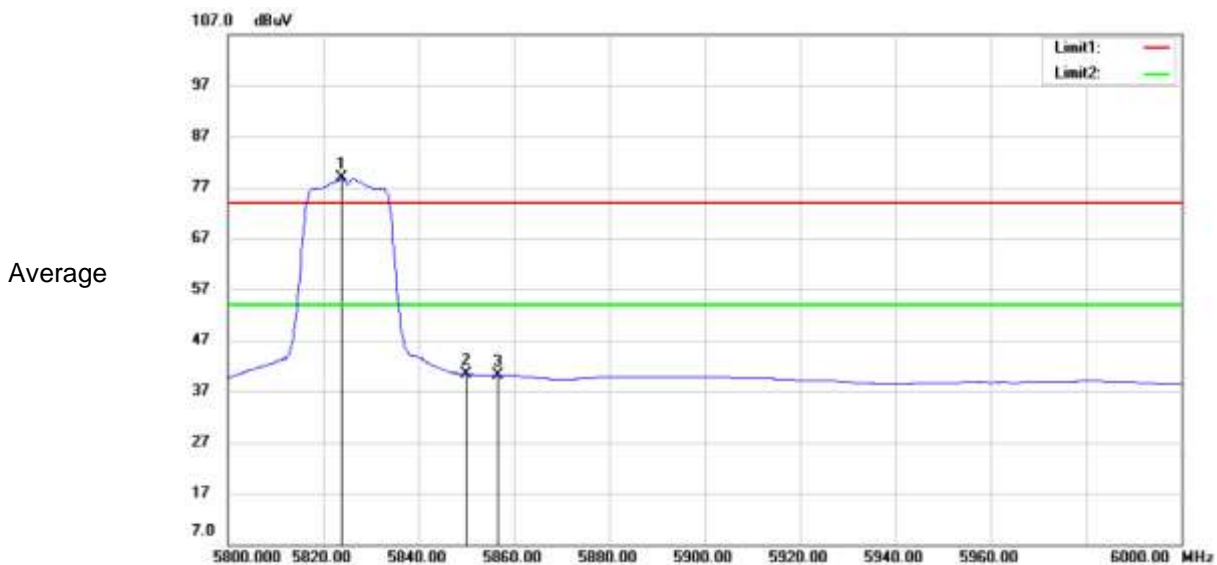
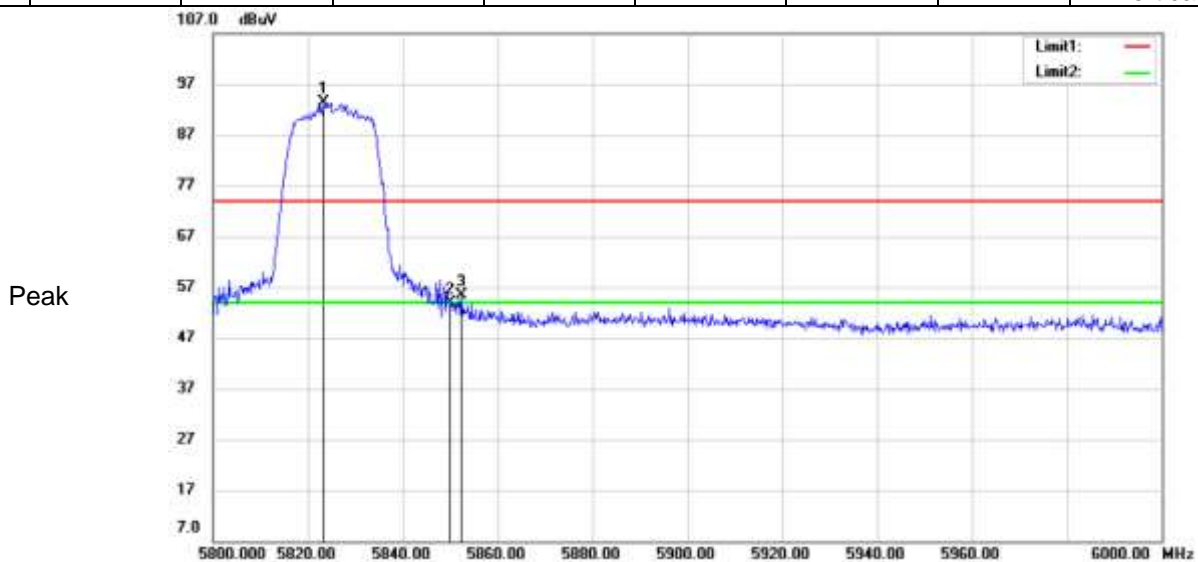

**802.11 ac(VHT40)**

**Channel: 5190**

| MK. | Frequency (MHz) | Reading (dBuV/m) | Corrected factor(dB) | Result (dBuV/m) | Limit (dBuV/m) | Over Limit (dB) | Detector | Polarization |
|-----|-----------------|------------------|----------------------|-----------------|----------------|-----------------|----------|--------------|
| 1   | 5133.64         | 53.03            | 7.01                 | 60.04           | 74             | -13.96          | Peak     | Horizontal   |
| 2   | 5150            | 53.06            | 6.92                 | 59.98           | 74             | -14.02          | Peak     | Horizontal   |
| 3   | 5192.04         | 94.96            | 6.7                  | 101.66          | 74             | 27.66           | Peak     | Horizontal   |
| 1   | 5100.79         | 34.4             | 7.2                  | 41.6            | 54             | -12.4           | Average  | Horizontal   |
| 2   | 5150            | 36.06            | 6.92                 | 42.98           | 54             | -11.02          | Average  | Horizontal   |
| 3   | 5193.5          | 79.32            | 6.69                 | 86.01           | 54             | 32.01           | Average  | Horizontal   |

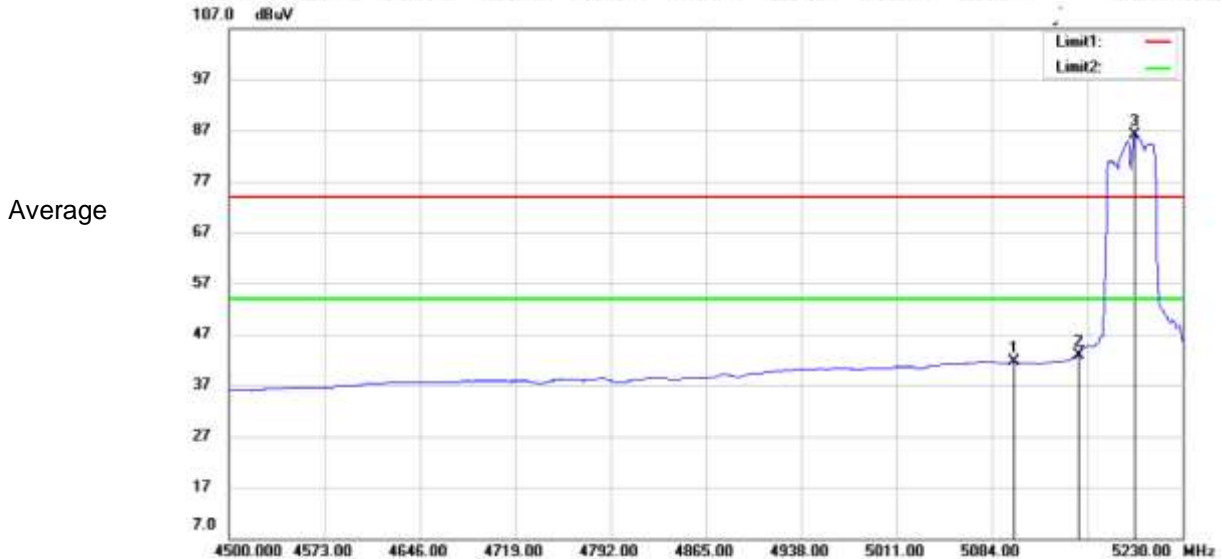
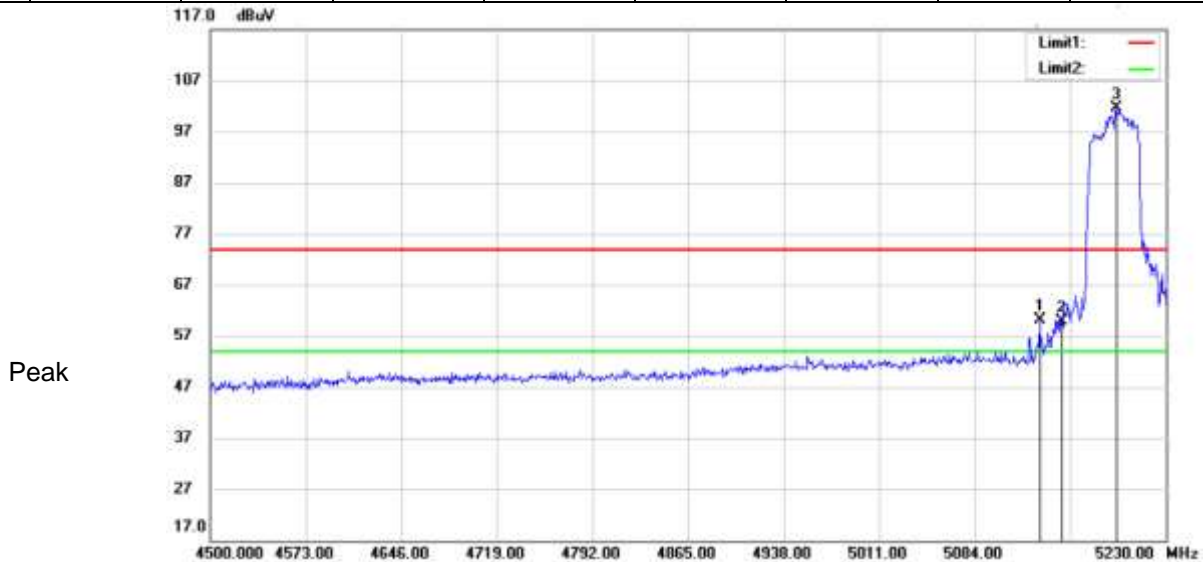

**802.11 ac(VHT40)**

**Channel: 5190**

| MK. | Frequency (MHz) | Reading (dBUV/m) | Corrected factor(dB) | Result (dBUV/m) | Limit (dBUV/m) | Over Limit (dB) | Detector | Polarization |
|-----|-----------------|------------------|----------------------|-----------------|----------------|-----------------|----------|--------------|
| 1   | 5132.91         | 51.53            | 7.01                 | 58.54           | 74             | -15.46          | Peak     | Vertical     |
| 2   | 5150            | 52.15            | 6.92                 | 59.07           | 74             | -14.93          | Peak     | Vertical     |
| 3   | 5193.5          | 89.35            | 6.69                 | 96.04           | 74             | 22.04           | Peak     | Vertical     |
| 1   | 5081.08         | 34.64            | 7.29                 | 41.93           | 54             | -12.07          | Average  | Vertical     |
| 2   | 5150            | 35.08            | 6.92                 | 42              | 54             | -12             | Average  | Vertical     |
| 3   | 5193.5          | 72.21            | 6.69                 | 78.9            | 54             | 24.9            | Average  | Vertical     |

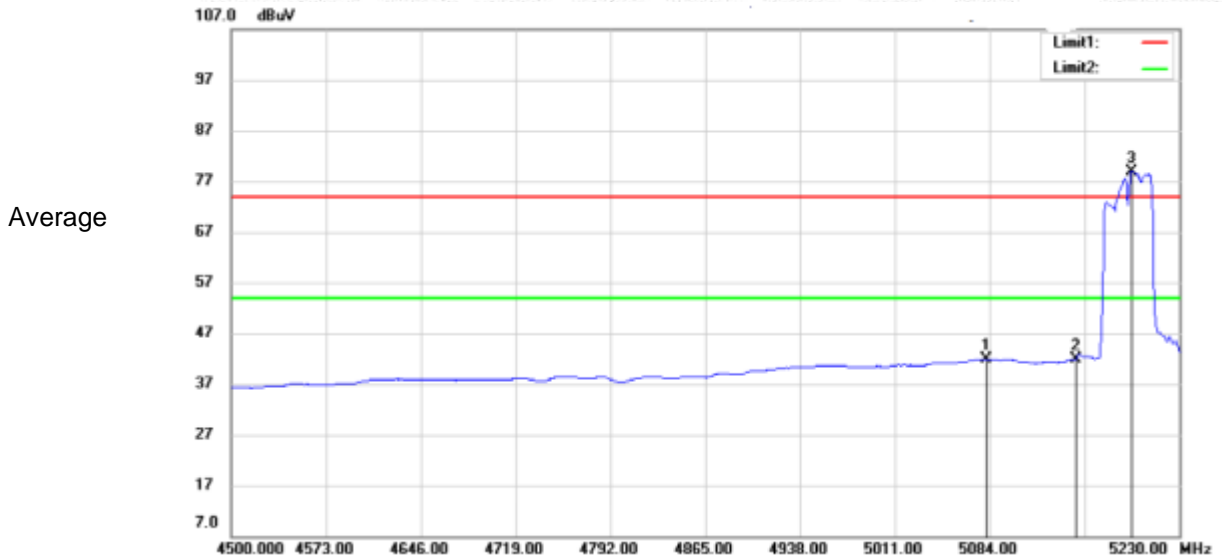
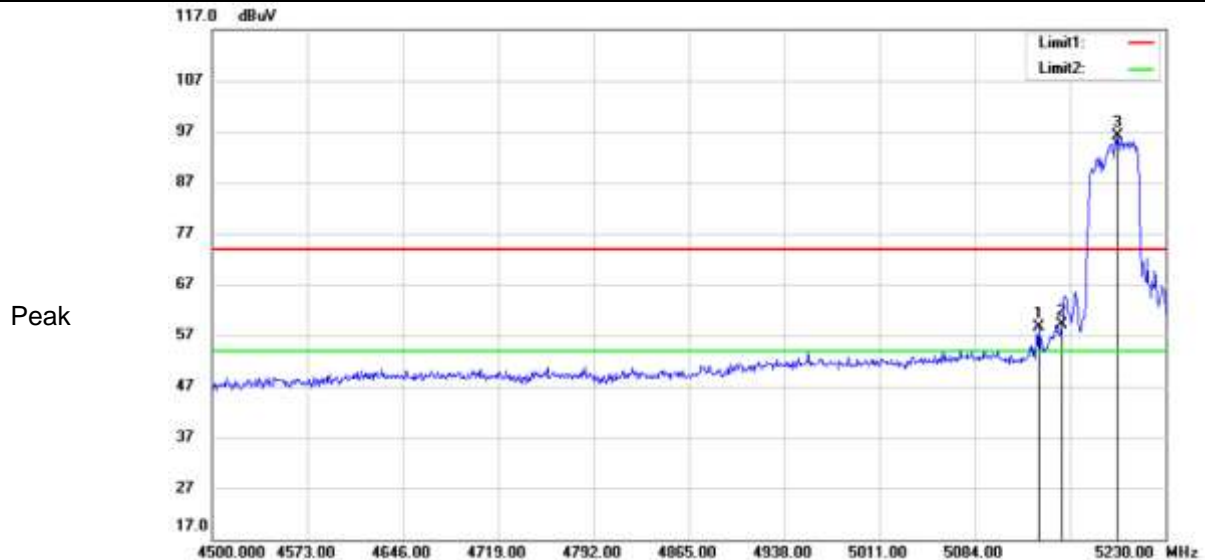

**802.11 ac(VHT40)**

**Channel: 5230**

| MK. | Frequency (MHz) | Reading (dBuV/m) | Corrected factor(dB) | Result (dBuV/m) | Limit (dBuV/m) | Over Limit (dB) | Detector | Polarization |
|-----|-----------------|------------------|----------------------|-----------------|----------------|-----------------|----------|--------------|
| 1   | 5227.81         | 93.58            | 6.64                 | 100.22          | 54             | 46.22           | Peak     | Horizontal   |
| 2   | 5350            | 43.58            | 6.98                 | 50.56           | 54             | -3.44           | Peak     | Horizontal   |
| 3   | 5387.11         | 46.19            | 7.24                 | 53.43           | 54             | -0.57           | Peak     | Horizontal   |
| 1   | 5233.21         | 87.57            | 6.65                 | 94.22           | 54             | 40.22           | Peak     | Vertical     |
| 2   | 5350            | 41.91            | 6.98                 | 48.89           | 54             | -5.11           | Peak     | Vertical     |
| 3   | 5417.62         | 46.14            | 7.27                 | 53.41           | 54             | -0.59           | Peak     | Vertical     |

Vertical



Horizontal



**802.11 ac(VHT40)**

**Channel: 5755**

| MK. | Frequency (MHz) | Reading (dBuV/m) | Corrected factor(dB) | Result (dBuV/m) | Limit (dBuV/m) | Over Limit (dB) | Detector | Polarization |
|-----|-----------------|------------------|----------------------|-----------------|----------------|-----------------|----------|--------------|
| 1   | 5717.85         | 63.06            | 6.84                 | 69.9            | 74             | -4.1            | Peak     | Horizontal   |
| 2   | 5725            | 60.87            | 6.82                 | 67.69           | 74             | -6.31           | Peak     | Horizontal   |
| 3   | 5756.85         | 93.58            | 6.75                 | 100.33          | 74             | 26.33           | Peak     | Horizontal   |
| 1   | 5717.85         | 43.8             | 6.84                 | 50.64           | 54             | -3.36           | Average  | Horizontal   |
| 2   | 5725            | 43.34            | 6.82                 | 50.16           | 54             | -3.84           | Average  | Horizontal   |
| 3   | 5761.53         | 77.4             | 6.74                 | 84.14           | 54             | 30.14           | Average  | Horizontal   |

Peak



Average

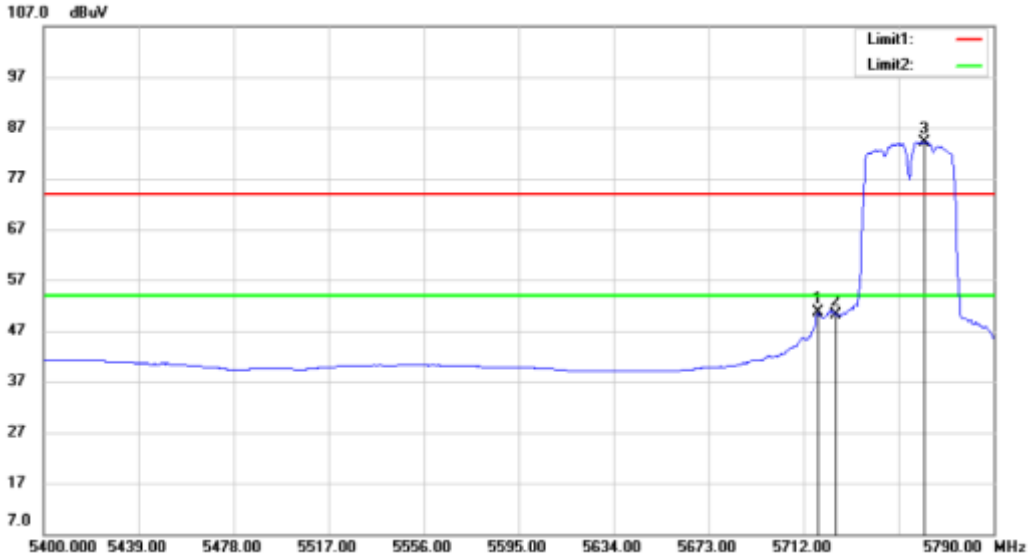

**802.11 ac(VHT40)**

**Channel: 5755**

| MK. | Frequency (MHz) | Reading (dBuV/m) | Corrected factor(dB) | Result (dBuV/m) | Limit (dBuV/m) | Over Limit (dB) | Detector | Polarization |
|-----|-----------------|------------------|----------------------|-----------------|----------------|-----------------|----------|--------------|
| 1   | 5718.24         | 55.81            | 6.84                 | 62.65           | 74             | -11.35          | Peak     | Vertical     |
| 2   | 5725            | 54.02            | 6.82                 | 60.84           | 74             | -13.16          | Peak     | Vertical     |
| 3   | 5754.12         | 86.85            | 6.77                 | 93.62           | 74             | 19.62           | Peak     | Vertical     |
| 1   | 5717.85         | 38.74            | 6.84                 | 45.58           | 54             | -8.42           | Average  | Vertical     |
| 2   | 5725            | 38.66            | 6.82                 | 45.48           | 54             | -8.52           | Average  | Vertical     |
| 3   | 5758.02         | 69.97            | 6.75                 | 76.72           | 54             | 22.72           | Average  | Vertical     |

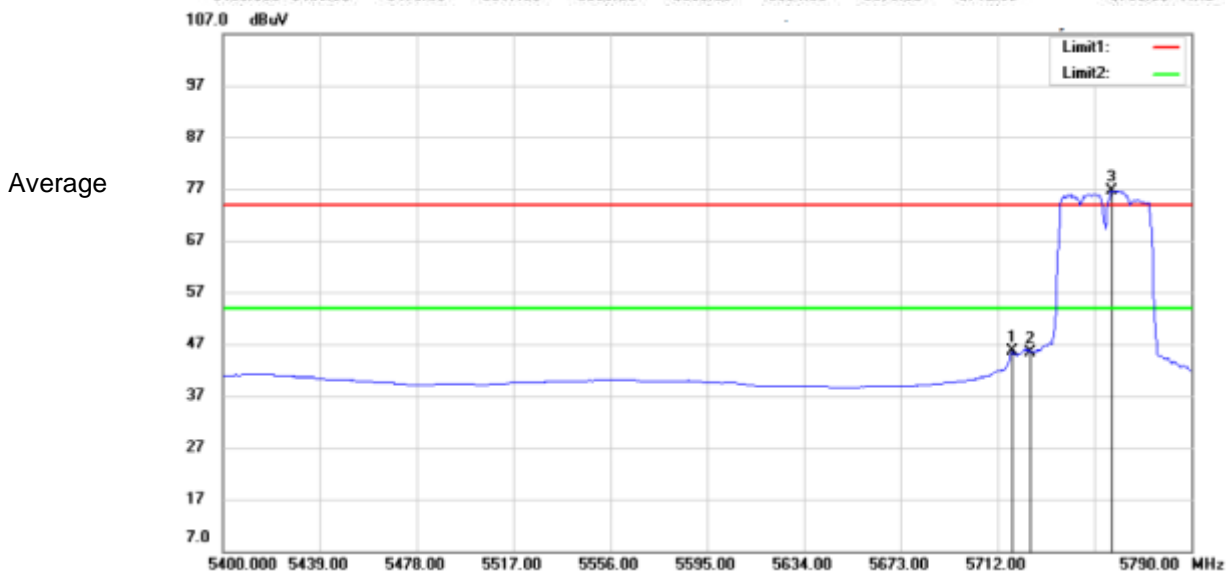
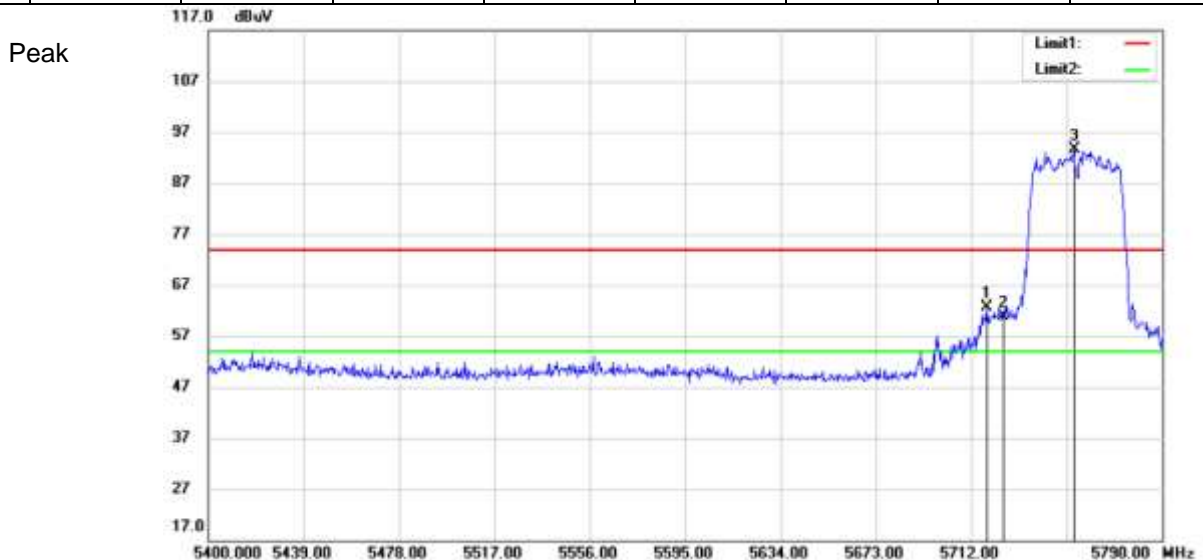



**802.11 ac(VHT40)**

**Channel: 5795**

| MK. | Frequency (MHz) | Reading (dBuV/m) | Corrected factor(dB) | Result (dBuV/m) | Limit (dBuV/m) | Over Limit (dB) | Detector | Polarization |
|-----|-----------------|------------------|----------------------|-----------------|----------------|-----------------|----------|--------------|
| 1   | 5803.92         | 92.38            | 6.67                 | 99.05           | 74             | 25.05           | Peak     | Horizontal   |
| 2   | 5850            | 51.31            | 6.64                 | 57.95           | 74             | -16.05          | Peak     | Horizontal   |
| 3   | 5853.36         | 57.09            | 6.64                 | 63.73           | 74             | -10.27          | Peak     | Horizontal   |
| 1   | 5802.72         | 76.98            | 6.67                 | 83.65           | 54             | 29.65           | Average  | Horizontal   |
| 2   | 5850            | 36.69            | 6.64                 | 43.33           | 54             | -10.67          | Average  | Horizontal   |
| 3   | 5852.88         | 37.1             | 6.64                 | 43.74           | 54             | -10.26          | Average  | Horizontal   |

**Peak**



**Average**

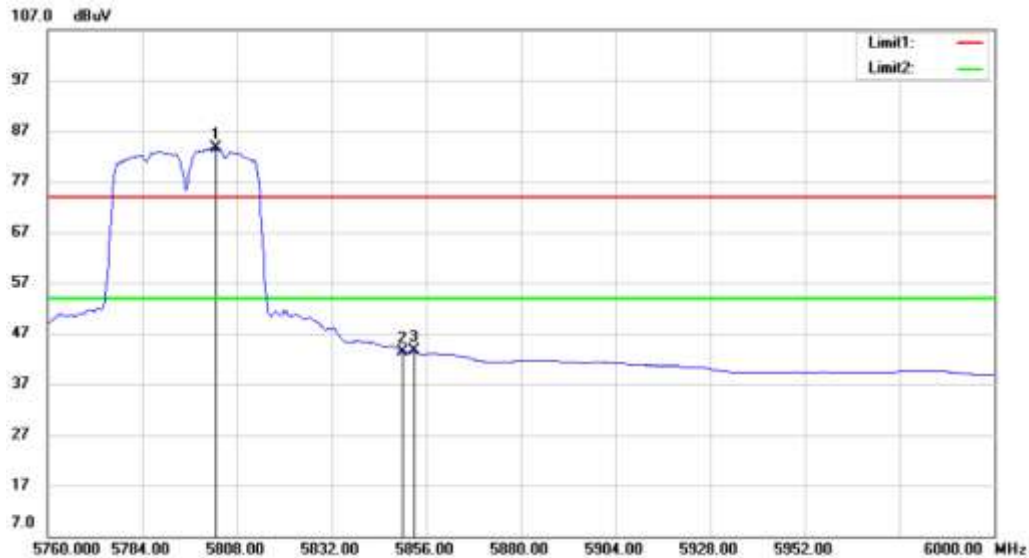

**802.11 ac(VHT40)**

**Channel: 5795**

| MK. | Frequency (MHz) | Reading (dBuV/m) | Corrected factor(dB) | Result (dBuV/m) | Limit (dBuV/m) | Over Limit (dB) | Detector | Polarization |
|-----|-----------------|------------------|----------------------|-----------------|----------------|-----------------|----------|--------------|
| 1   | 5790.96         | 87.09            | 6.69                 | 93.78           | 74             | 19.78           | Peak     | Vertical     |
| 2   | 5850            | 46.48            | 6.64                 | 53.12           | 74             | -20.88          | Peak     | Vertical     |
| 3   | 5853.36         | 50.06            | 6.64                 | 56.7            | 74             | -17.3           | Peak     | Vertical     |
| 1   | 5802.72         | 70.15            | 6.67                 | 76.82           | 54             | 22.82           | Average  | Vertical     |
| 2   | 5850            | 33.41            | 6.64                 | 40.05           | 54             | -13.95          | Average  | Vertical     |
| 3   | 5857.68         | 33.66            | 6.63                 | 40.29           | 54             | -13.71          | Average  | Vertical     |

**Peak**

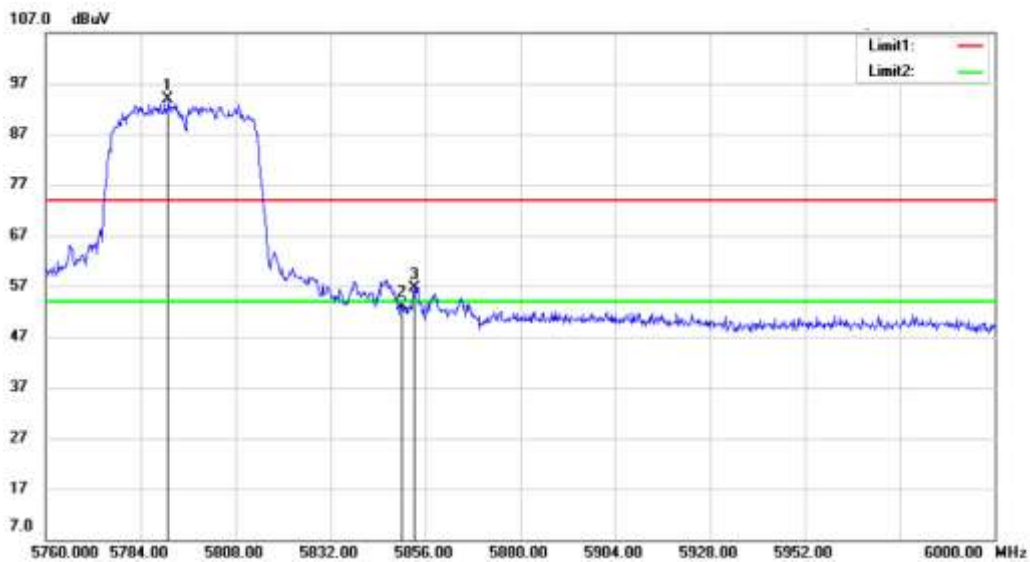

**Average**

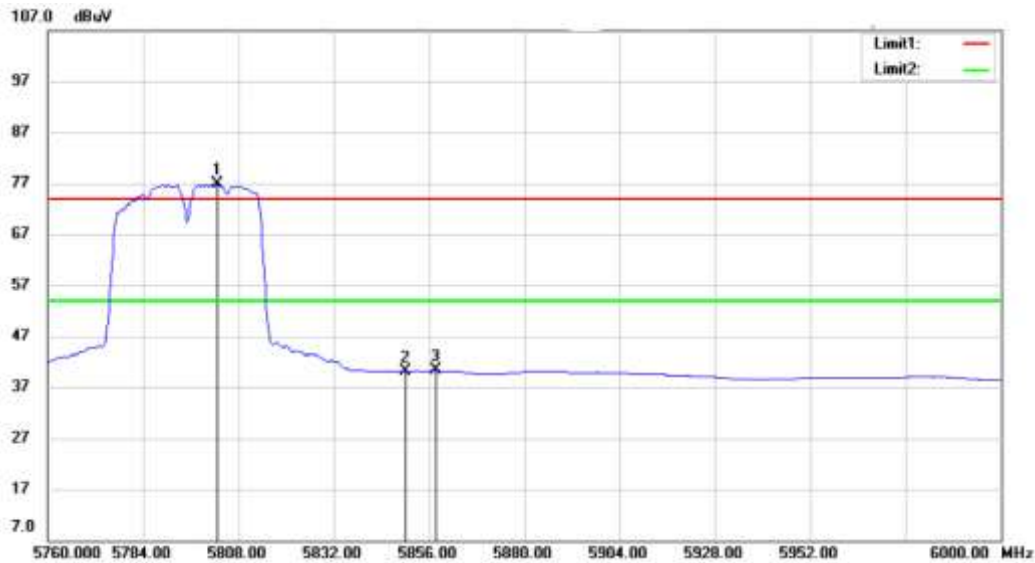

**802.11 ac(VHT80)**

**Channel: 5210**

| MK. | Frequency (MHz) | Reading (dBUV/m) | Corrected factor(dB) | Result (dBUV/m) | Limit (dBUV/m) | Over Limit (dB) | Detector | Polarization |
|-----|-----------------|------------------|----------------------|-----------------|----------------|-----------------|----------|--------------|
| 1   | 5062.6          | 46.2             | 7.39                 | 53.59           | 74             | -20.41          | Peak     | Horizontal   |
| 2   | 5150            | 45.6             | 6.92                 | 52.52           | 74             | -21.48          | Peak     | Horizontal   |
| 3   | 5208.1          | 90.24            | 6.64                 | 96.88           | 74             | 22.88           | Peak     | Horizontal   |
| 4   | 5350            | 44.67            | 6.98                 | 51.65           | 74             | -22.35          | Peak     | Horizontal   |
| 5   | 5394.34         | 45.43            | 7.29                 | 52.72           | 74             | -21.28          | Peak     | Horizontal   |
| 1   | 5079.09         | 34.23            | 7.31                 | 41.54           | 54             | -12.46          | Average  | Horizontal   |
| 2   | 5150            | 34.7             | 6.92                 | 41.62           | 54             | -12.38          | Average  | Horizontal   |
| 3   | 5212.95         | 72.65            | 6.65                 | 79.3            | 54             | 25.3            | Average  | Horizontal   |
| 4   | 5350            | 33.78            | 6.98                 | 40.76           | 54             | -13.24          | Average  | Horizontal   |
| 5   | 5410.83         | 33.65            | 7.29                 | 40.94           | 54             | -13.06          | Average  | Horizontal   |

**Peak**

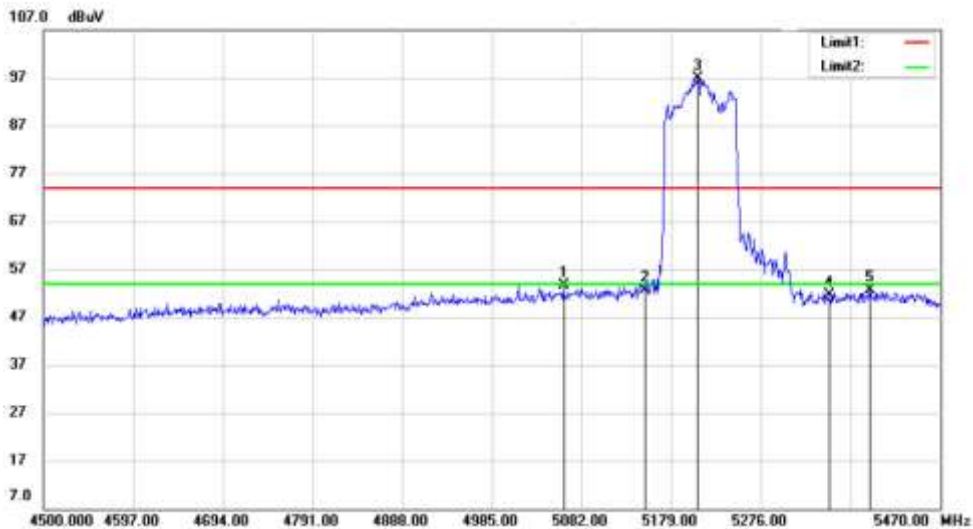

**Average**

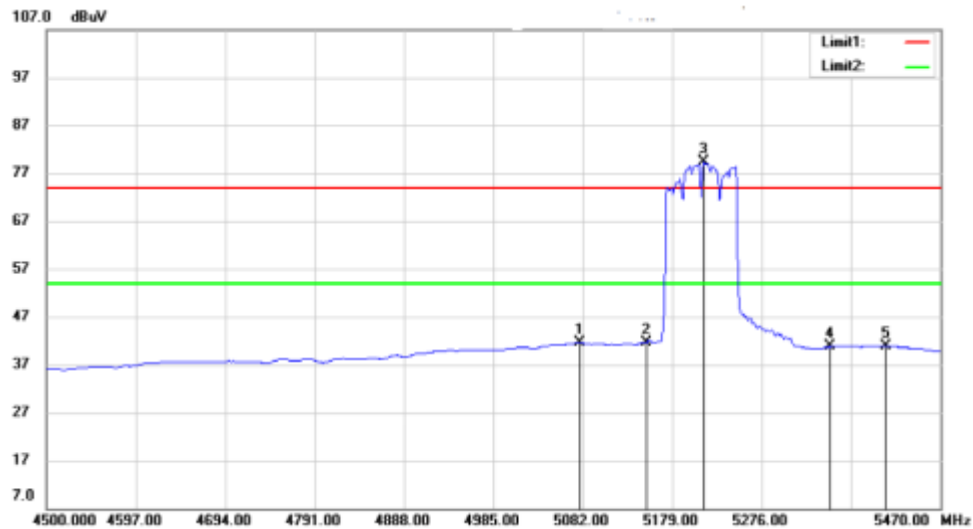

**802.11 ac(VHT80)**

**Channel: 5210**

| MK. | Frequency (MHz) | Reading (dBuV/m) | Corrected factor(dB) | Result (dBuV/m) | Limit (dBuV/m) | Over Limit (dB) | Detector | Polarization |
|-----|-----------------|------------------|----------------------|-----------------|----------------|-----------------|----------|--------------|
| 1   | 5063.57         | 46.66            | 7.38                 | 54.04           | 74             | -19.96          | Peak     | Vertical     |
| 2   | 5150            | 44.19            | 6.92                 | 51.11           | 74             | -22.89          | Peak     | Vertical     |
| 3   | 5209.07         | 83.55            | 6.64                 | 90.19           | 74             | 16.19           | Peak     | Vertical     |
| 4   | 5350            | 43.5             | 6.98                 | 50.48           | 74             | -23.52          | Peak     | Vertical     |
| 5   | 5407.92         | 45.53            | 7.3                  | 52.83           | 74             | -21.17          | Peak     | Vertical     |
| 1   | 5085.88         | 34.61            | 7.28                 | 41.89           | 54             | -12.11          | Average  | Vertical     |
| 2   | 5150            | 33.8             | 6.92                 | 40.72           | 54             | -13.28          | Average  | Vertical     |
| 3   | 5217.8          | 65.24            | 6.65                 | 71.89           | 54             | 17.89           | Average  | Vertical     |
| 4   | 5350            | 33.3             | 6.98                 | 40.28           | 54             | -13.72          | Average  | Vertical     |
| 5   | 5410.83         | 33.98            | 7.29                 | 41.27           | 54             | -12.73          | Average  | Vertical     |

Peak

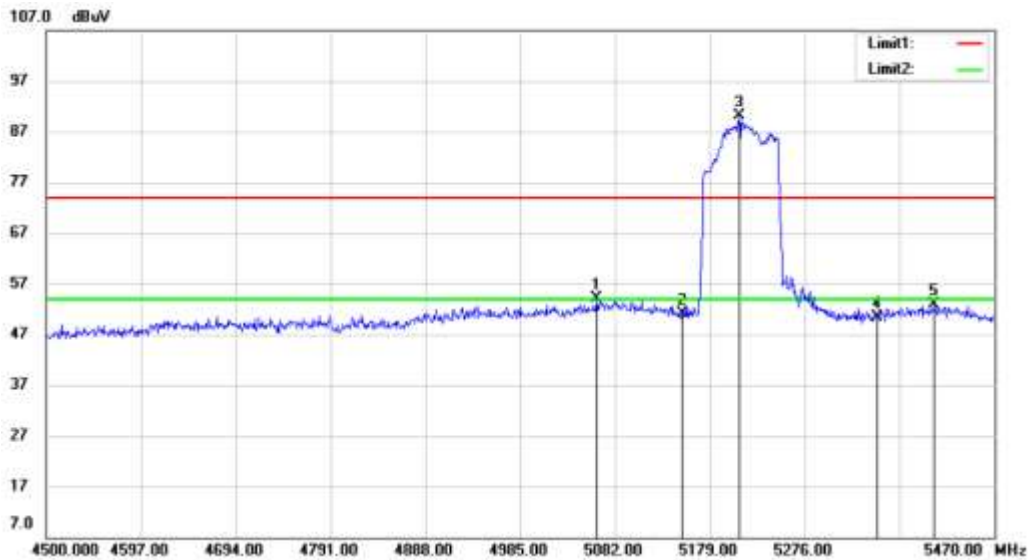

Average

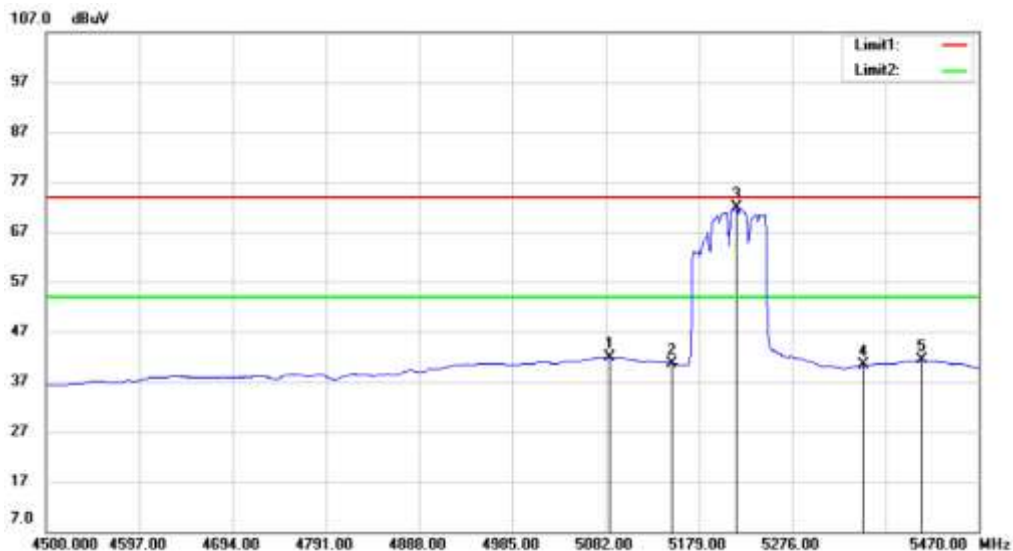

**802.11 ac(VHT80)**

**Channel: 5775**

| MK. | Frequency (MHz) | Reading (dBuV/m) | Corrected factor(dB) | Result (dBuV/m) | Limit (dBuV/m) | Over Limit (dB) | Detector | Polarization |
|-----|-----------------|------------------|----------------------|-----------------|----------------|-----------------|----------|--------------|
| 1   | 5717.2          | 58.68            | 6.84                 | 65.52           | 74             | -8.48           | Peak     | Horizontal   |
| 2   | 5725            | 56.54            | 6.82                 | 63.36           | 74             | -10.64          | Peak     | Horizontal   |
| 3   | 5765.6          | 90.69            | 6.75                 | 97.44           | 74             | 23.44           | Peak     | Horizontal   |
| 4   | 5850            | 50.26            | 6.64                 | 56.9            | 74             | -17.1           | Peak     | Horizontal   |
| 5   | 5857.6          | 50.96            | 6.63                 | 57.59           | 74             | -16.41          | Peak     | Horizontal   |
| 1   | 5718.8          | 40.34            | 6.82                 | 47.16           | 54             | -6.84           | Average  | Horizontal   |
| 2   | 5725            | 39.04            | 6.82                 | 45.86           | 54             | -8.14           | Average  | Horizontal   |
| 3   | 5784            | 73.18            | 6.7                  | 79.88           | 54             | 25.88           | Average  | Horizontal   |
| 4   | 5850            | 36.25            | 6.64                 | 42.89           | 54             | -11.11          | Average  | Horizontal   |
| 5   | 5860.4          | 36.28            | 6.63                 | 42.91           | 54             | -11.09          | Average  | Horizontal   |

Peak

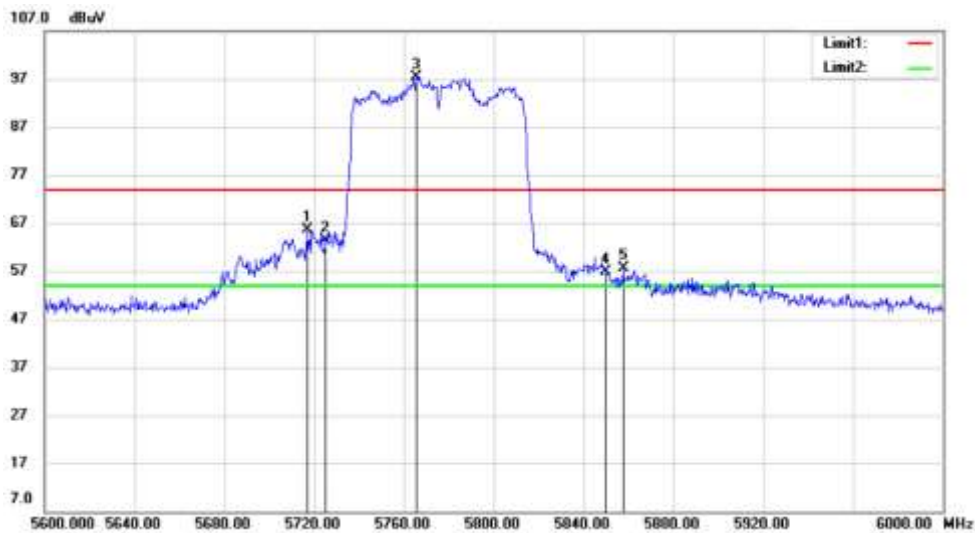

Average

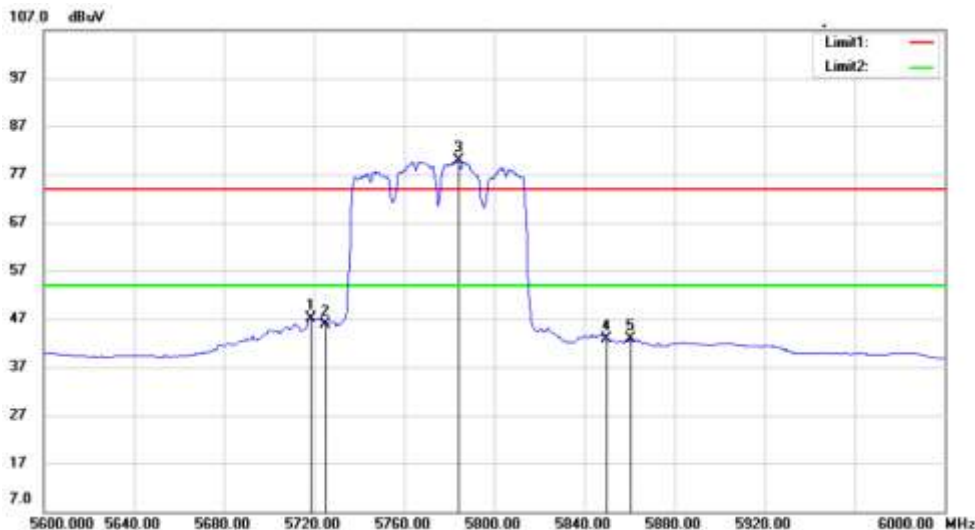

**802.11 ac(VHT80)**

**Channel: 5775**

| MK. | Frequency (MHz) | Reading (dBuV/m) | Corrected factor(dB) | Result (dBuV/m) | Limit (dBuV/m) | Over Limit (dB) | Detector | Polarization |
|-----|-----------------|------------------|----------------------|-----------------|----------------|-----------------|----------|--------------|
| 1   | 5719.6          | 49.58            | 6.82                 | 56.4            | 74             | -17.6           | Peak     | Vertical     |
| 2   | 5725            | 48.71            | 6.82                 | 55.53           | 74             | -18.47          | Peak     | Vertical     |
| 3   | 5772.8          | 82.68            | 6.72                 | 89.4            | 74             | 15.4            | Peak     | Vertical     |
| 4   | 5850            | 46.23            | 6.64                 | 52.87           | 74             | -21.13          | Peak     | Vertical     |
| 5   | 5879.2          | 44.69            | 6.63                 | 51.32           | 74             | -22.68          | Peak     | Vertical     |
| 1   | 5718.8          | 35.38            | 6.82                 | 42.2            | 54             | -11.8           | Average  | Vertical     |
| 2   | 5725            | 34.93            | 6.82                 | 41.75           | 54             | -12.25          | Average  | Vertical     |
| 3   | 5772.4          | 63.98            | 6.72                 | 70.7            | 54             | 16.7            | Average  | Vertical     |
| 4   | 5850            | 33.52            | 6.64                 | 40.16           | 54             | -13.84          | Average  | Vertical     |
| 5   | 5899.2          | 33.35            | 6.61                 | 39.96           | 54             | -14.04          | Average  | Vertical     |

Peak

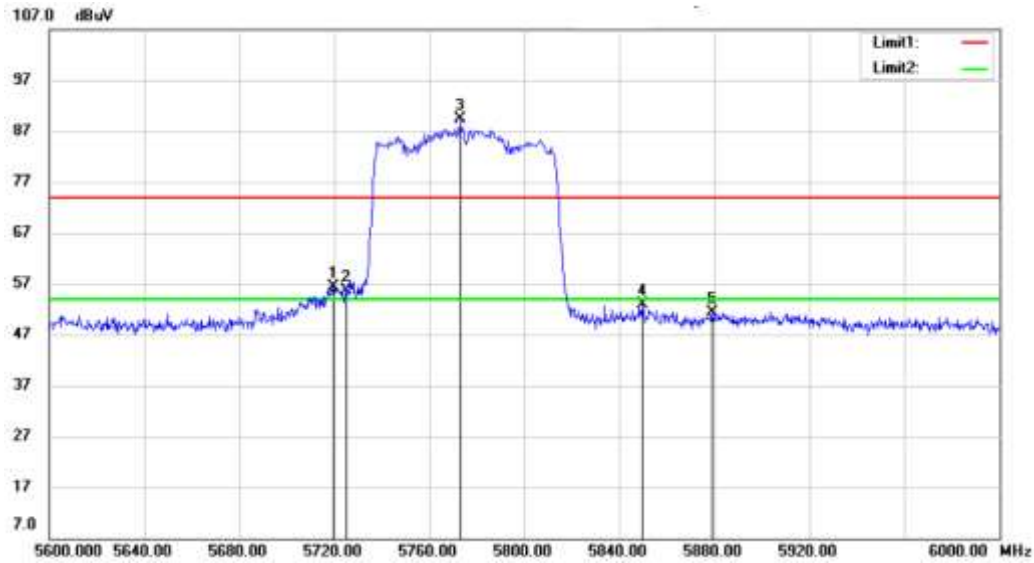

Average

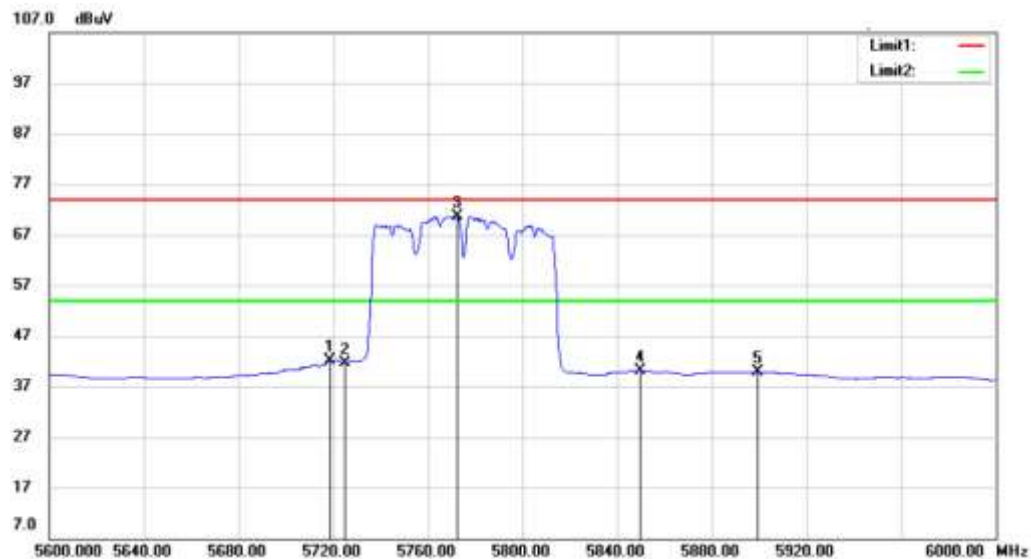

This document is issued by the Company subject to its General Conditions of Service printed overleaf, available on request or accessible at [www.sgs.com/terms\\_and\\_conditions.htm](http://www.sgs.com/terms_and_conditions.htm) and, for electronic format documents, subject to Terms and Conditions for Electronic Documents at [www.sgs.com/terms\\_e-document.htm](http://www.sgs.com/terms_e-document.htm). Attention is drawn to the limitation of liability, indemnification and jurisdiction issues defined therein. Any holder of this document is advised that information contained hereon reflects the Company's findings at the time of its intervention only and within the limits of Client's instructions, if any. The Company's sole responsibility is to its Client and this document does not exonerate parties to a transaction from exercising all their rights and obligations under the transaction documents. This document cannot be reproduced except in full, without prior written approval of the Company. Any unauthorized alteration, forgery or falsification of the content or appearance of this document is unlawful and offenders may be prosecuted to the fullest extent of the law. Unless otherwise stated the results shown in this test report refer only to the sample(s) tested and such sample(s) are retained for 90 days only.

- Remark: 1. Test Level = Receiver Reading + Antenna Factor + Cable Loss- Preamplifier Factor  
 2. No any other emission which falls in restricted bands can be detected and be reported.  
 3. If the Peak value below the AV Limit, the AV test doesn't perform for this submission.

All frequencies within the "Restricted bands" have been evaluated to compliance. Section 15.205  
 Restricted bands of operation.

Only spurious emissions are permitted in any of the frequency bands listed below:

| MHz                        | MHz                   | MHz             | GHz           |
|----------------------------|-----------------------|-----------------|---------------|
| 0.090 - 0.110              | 16.42 - 16.423        | 399.9 - 410     | 4.5 - 5.15    |
| <sup>1</sup> 0.495 - 0.505 | 16.69475 - 16.69525   | 608 - 614       | 5.35 - 5.46   |
| 2.1735 - 2.1905            | 16.80425 - 16.80475   | 960 - 1240      | 7.25 - 7.75   |
| 4.125 - 4.128              | 25.5 - 25.67          | 1300 - 1427     | 8.025 - 8.5   |
| 4.17725 - 4.17775          | 37.5 - 38.25          | 1435 - 1626.5   | 9.0 - 9.2     |
| 4.20725 - 4.20775          | 73 - 74.6             | 1645.5 - 1646.5 | 9.3 - 9.5     |
| 6.215 - 6.218              | 74.8 - 75.2           | 1660 - 1710     | 10.5 - 12.7   |
| 6.26775 - 6.26825          | 108 - 121.94          | 1718.8 - 1722.2 | 13.25 - 13.4  |
| 6.31175 - 6.31225          | 123 - 138             | 2200 - 2300     | 14.47 - 14.5  |
| 8.291 - 8.294              | 149.9 - 150.05        | 2310 - 2390     | 15.35 - 16.2  |
| 8.362 - 8.366              | 156.52475 - 156.52525 | 2483.5 - 2500   | 17.7 - 21.4   |
| 8.37625 - 8.38675          | 156.7 - 156.9         | 2655 - 2900     | 22.01 - 23.12 |
| 8.41425 - 8.41475          | 162.0125 - 167.17     | 3260 - 3267     | 23.6 - 24.0   |
| 12.29 - 12.293             | 167.72 - 173.2        | 3332 - 3339     | 31.2 - 31.8   |
| 12.51975 - 12.52025        | 240 - 285             | 3345.8 - 3358   | 36.43 - 36.5  |
| 12.57675 - 12.57725        | 322 - 335.4           | 3600 - 4400     |               |
| 13.36 - 13.41              |                       |                 |               |

## **6.9 Transmission in the Absence of Data**

### **6.9.1 Standard Applicable**

The device shall automatically discontinue transmission in case of either absence of information to transmit or operational failure. These provisions are not intended to preclude the transmission of control or signalling information or the use of repetitive codes used by certain digital technologies to complete frame or burst intervals. Applicants shall include in their application for equipment authorization a description of how this requirement is met.

### **6.9.2 Test Result**

While the EUT is not transmitting any information, the EUT can automatically discontinue transmission and become standby mode for power saving. The EUT can detect the controlling signal of ACK message transmitting from remote device and verify whether it shall resend or discontinue transmission.



### 6.10 Frequency stability

**Test setup:**

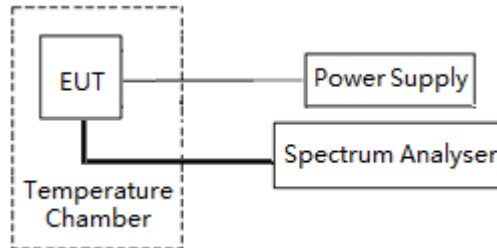

**Test Procedure:**

- The EUT was placed in the temperature chamber, the DC leads and RF output cable exited the chamber through an opening made for that purpose.
- After operating the equipment in standby conditions for 15 minutes before proceeding. The temperature was varied from -20°C to +55°C at intervals of not more than 10°C. The frequency stability was read from the spectrum analyzer and the frequency stability and input voltage was recorded.

**Test Limit:**

The frequency of carrier signal shall be maintained within the band of operation

**Test Data:**

| Band         | Test Conditions |              | Operation Frequency(MHz) | Test Frequency (MHz) | Freq. Dev. (MHz) | Limit (GHz) | Result |
|--------------|-----------------|--------------|--------------------------|----------------------|------------------|-------------|--------|
|              | Volt (V AC)     | Temp (°C)    |                          |                      |                  |             |        |
| Band U-NII 1 | Normal(120)     | Extreme(-20) | 5180                     | 5179.9854            | 0.0146           | 5.15-5.25   | Pass   |
|              |                 | Extreme(-10) |                          | 5179.9867            | 0.0133           |             | Pass   |
|              |                 | Extreme(0)   |                          | 5179.9862            | 0.0138           |             | Pass   |
|              |                 | Extreme(+10) |                          | 5179.9853            | 0.0147           |             | Pass   |
|              |                 | Extreme(+20) |                          | 5179.9873            | 0.0127           |             | Pass   |
|              |                 | Extreme(+30) |                          | 5179.9869            | 0.0131           |             | Pass   |
|              |                 | Extreme(+40) |                          | 5179.9859            | 0.0141           |             | Pass   |
|              |                 | Extreme(+55) |                          | 5179.9862            | 0.0138           |             | Pass   |
|              | Extreme(102)    | Norma(+20)   | 5179.9877                | 0.0123               | Pass             |             |        |
|              | Extreme(138)    |              | 5179.9841                | 0.0159               | Pass             |             |        |
| Band U-NII 3 | Normal(120)     | Extreme(-20) | 5825                     | 5824.9799            | 0.0201           | 5.725-5.85  | Pass   |
|              |                 | Extreme(-10) |                          | 5824.9792            | 0.0208           |             | Pass   |
|              |                 | Extreme(0)   |                          | 5824.9794            | 0.0206           |             | Pass   |
|              |                 | Extreme(+10) |                          | 5824.9802            | 0.0198           |             | Pass   |
|              |                 | Extreme(+20) |                          | 5824.9794            | 0.0206           |             | Pass   |
|              |                 | Extreme(+30) |                          | 5824.9785            | 0.0215           |             | Pass   |
|              |                 | Extreme(+40) |                          | 5824.9779            | 0.0221           |             | Pass   |
|              |                 | Extreme(+55) |                          | 5824.9772            | 0.0228           |             | Pass   |
|              | Extreme(102)    | Norma(20)    | 5824.9782                | 0.0218               | Pass             |             |        |
|              | Extreme(138)    |              | 5824.9782                | 0.0218               | Pass             |             |        |

Remark: Based on the results of the frequency stability test shown above the frequency deviation results measured are very small. As such it is determined that the channels at the band edge would remain in-band when the maximum measured frequency deviation noted during the frequency stability tests is applied. Therefore the device is determined to remain operating in band over the temperature and voltage range as tested.

## **7 Test Setup Photographs**

Refer to the < Test Setup photos-FCC>.

## **8 EUT Constructional Details**

Refer to the <External Photos > & < Internal Photos >.

**--End of the Report--**