

FCC RADIO TEST REPORT

FCC ID: 2AML4-CAMIND2K

Product : 2K HD WiFi Camera

Trade Name : N/A

Model Name : MOCAMIND2K-01

Serial Model : N/A

Report No. : UNIA20042213FR-02

Prepared for

Apollo Tech USA Inc.

Tech USA Inc. 8608 Utica Ave #220, Rancho Cucamonga, California,
United States

Prepared by

Shenzhen United Testing Technology Co., Ltd.

2F, Annex Bldg, Jiahuangyuan Tech Park, #365 Baotian 1 Rd, Tiegang
Community, Xixiang Str, Bao'an District, Shenzhen, China

TEST RESULT CERTIFICATION

Applicant's name..... : Apollo Tech USA Inc.
Address..... : Tech USA Inc. 8608 Utica Ave #220, Rancho Cucamonga, California, United States
Manufacturer's Name..... : Apollo Tech USA Inc.
Address..... : Tech USA Inc. 8608 Utica Ave #220, Rancho Cucamonga, California, United States

Product description

Product name..... : 2K HD WiFi Camera
Trade Mark..... : N/A
Model and/or type reference . : MOCAMIND2K-01

Standards..... : FCC Rules and Regulations Part 15 Subpart C Section 15.247, ANSI C63.10: 2013

This device described above has been tested by Shenzhen United Testing Technology Co., Ltd., and the test results show that the equipment under test (EUT) is in compliance with the FCC requirements. And it is applicable only to the tested sample identified in the report.

This report shall not be reproduced except in full, without the written approval of UNI, this document may be altered or revised by Shenzhen United Testing Technology Co., Ltd., personnel only, and shall be noted in the revision of the document.

Date of Test..... :
Date (s) of performance of tests..... : Apr. 10 ~ 22, 2020
Date of Issue..... : Apr. 23, 2020
Test Result..... : Pass

Tested by:

Kahn yang/Engineer

Reviewer:

Sherwin Qian/Supervisor

Approved & Authorized Signer:

Liuze/Manager

Table of Contents

Page

1. TEST SUMMARY.....	5
1.1 TEST PROCEDURES AND RESULTS.....	5
1.2 TEST FACILITY.....	5
1.3 MEASUREMENT UNCERTAINTY.....	5
2. GENERAL INFORMATION.....	6
2.1 GENERAL DESCRIPTION OF EUT.....	6
2.2 Carrier Frequency of Channels.....	7
2.3 Operation of EUT during testing.....	7
2.4 DESCRIPTION OF TEST SETUP.....	7
2.5 MEASUREMENT INSTRUMENTS LIST.....	8
3. CONDUCTED EMISSIONS TEST.....	9
3.1 Conducted Power Line Emission Limit.....	9
3.2 Test Setup.....	9
3.3 Test Procedure.....	9
3.4 Test Result.....	9
4. RADIATED EMISSION TEST.....	10
4.1 Radiation Limit.....	12
4.2 Test Setup.....	12
4.3 Test Procedure.....	13
4.4 Test Result.....	13
5. BAND EDGE.....	19
5.1 Limits.....	19
5.2 Test Procedure.....	19
5.3 Test Result.....	19
6. OCCUPIED BANDWIDTH MEASUREMENT.....	21
6.1 Test Limit.....	21
6.2 Test Procedure.....	21
6.3 Measurement Equipment Used.....	21
6.4 Test Result.....	21
7. POWER SPECTRAL DENSITY TEST.....	23
7.1 Test Limit.....	23
7.2 Test Procedure.....	23
7.3 Measurement Equipment Used.....	23
7.4 Test Result.....	23
8. PEAK OUTPUT POWER TEST.....	25

Table of Contents

Page

8.1 Test Limit.....	25
8.2 Test Procedure.....	25
8.3 Measurement Equipment Used.....	25
8.4 Test Result.....	25
9. CONDUCTED BANDEGE MEASUREMENT.....	26
9.1 Test Setup.....	26
9.2 Test Procedure.....	26
9.3 Limit.....	26
9.4 Test Result.....	26
10. SPURIOUS RF CONDUCTED EMISSION.....	28
10.1 Test Limit.....	28
10.2 Test Procedure.....	28
10.3 Test Setup.....	28
10.4 Test Result.....	28
11. ANTENNA REQUIREMENT.....	34
12. PHOTOGRAPH OF TEST.....	35

1. TEST SUMMARY

1.1 TEST PROCEDURES AND RESULTS

DESCRIPTION OF TEST	RESULT
CONDUCTED EMISSIONS TEST	COMPLIANT
RADIATED EMISSION TEST	COMPLIANT
BAND EDGE	COMPLIANT
OCCUPIED BANDWIDTH MEASUREMENT	COMPLIANT
PEAK OUTPUT POWER	COMPLIANT
CONDUCTED BANDEGE MEASUREMENT	COMPLIANT
SPURIOUS RF CONDUCTED EMISSION	COMPLIANT
ANTENNA REQUIREMENT	COMPLIANT

1.2 TEST FACILITY

Test Firm : Shenzhen United Testing Technology Co., Ltd.
 Address : 2F, Annex Bldg, Jiahuangyuan Tech Park, #365 Baotian 1 Rd, Tiegang Community, Xixiang Str, Bao'an District, Shenzhen, China

The testing quality ability of our laboratory meet with "Quality Law of People's Republic of China" Clause 19. The testing quality system of our laboratory meets with ISO/IEC-17025 requirements, which is approved by CNAS. This approval result is accepted by MRA of APLAC.

Our test facility is recognized, certified, or accredited by the following organizations:

CNAS-LAB Code: L6494

The EMC Laboratory has been assessed and in compliance with CNAS-CL01 accreditation criteria for testing Laboratories (identical to ISO/IEC 17025:2017 General Requirements) for the Competence of testing Laboratories.

Designation Number: CN1227

Test Firm Registration Number: 674885

The EMC Laboratory has been registered and fully described in a report filed with the (FCC) Federal Communications commission. The acceptance letter from the FCC is maintained in our files.

1.3 MEASUREMENT UNCERTAINTY

Measurement Uncertainty	
Conducted Emission Expanded Uncertainty	= 2.23dB, k=2
Radiated emission expanded uncertainty(9kHz-30MHz)	= 3.08dB, k=2
Radiated emission expanded uncertainty(30MHz-1000MHz)	= 4.42dB, k=2
Radiated emission expanded uncertainty(Above 1GHz)	= 4.06dB, k=2

2. GENERAL INFORMATION

2.1 GENERAL DESCRIPTION OF EUT

Equipment	2K HD WiFi Camera
Trade Mark	N/A
Model Name	MOCAMIND2K-01
Sample ID	UNIA20012213FR-1#
Serial No.	N/A
Model Difference	N/A
FCC ID	2AML4-CAMIND2K
Antenna Type	Internal Antenna
Antenna Gain	2.08dBi
Frequency Range	2402-2480MHz
Number of Channels	40 channels for BLE
Modulation Type	GFSK for BLE
Power Source	DC 5V/1A from Adapter
Adapter	
Manufacturer	SHENZHEN TIANYIN ELECTRONICS CO LTD
M/N	TPA-46B050100UU
Input	100-240V~ 50/60Hz 0.2A
Output	DC 5V/1000mA

Table for auxiliary equipment:

Equipment Description	Manufacturer	Model	Calibration Due Date
Notebook	Lenovo	Lenovo G475	GB14477457

2.2 Carrier Frequency of Channels

Channel List							
Channel	Frequency (MHz)	Channel	Frequency (MHz)	Channel	Frequency (MHz)	Channel	Frequency (MHz)
00	2402	10	2422	20	2442	30	2462
01	2404	11	2424	21	2444	31	2464
02	2406	12	2426	22	2446	32	2466
03	2408	13	2428	23	2448	33	2468
04	2410	14	2430	24	2450	34	2470
05	2412	15	2432	25	2452	35	2472
06	2414	16	2434	26	2454	36	2474
07	2416	17	2436	27	2456	37	2476
08	2418	18	2438	28	2458	38	2478
09	2420	19	2440	29	2460	39	2480

2.3 Operation of EUT during testing

Operating Mode

The mode is used: Transmitting mode

Low Channel: 2402MHz

Middle Channel: 2440MHz

High Channel: 2480MHz

Test SW Version: Realtek MPtool

2.4 DESCRIPTION OF TEST SETUP

Operation of EUT during Conducted testing:

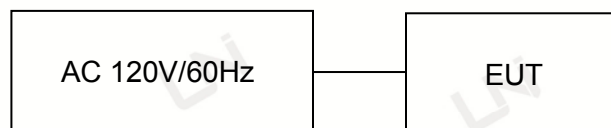

Operation of EUT during Radiation testing:

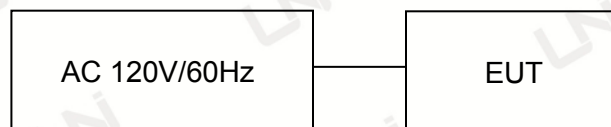

2.5 MEASUREMENT INSTRUMENTS LIST

Item	Equipment	Manufacturer	Model No.	Serial No.	Calibrated until
CONDUCTED EMISSIONS TEST					
1	AMN	Schwarzbeck	NNLK8121	8121370	2020.9.6
2	AMN	ETS	3810/2	00020199	2020.9.6
3	EMI TEST RECEIVER	Rohde&Schwarz	ESCI	101210	2020.9.6
4	AAN	TESEQ	T8-Cat6	38888	2020.9.6
RADIATED EMISSION TEST					
1	Horn Antenna	Sunol	DRH-118	A101415	2020.9.6
2	BicoNILog Antenna	Sunol	JB1 Antenna	A090215	2020.9.6
3	PREAMP	HP	8449B	3008A00160	2020.9.6
4	PREAMP	HP	8447D	2944A07999	2020.9.6
5	EMI TEST RECEIVER	Rohde&Schwarz	ESR3	101891	2020.9.6
6	VECTOR Signal Generator	Rohde&Schwarz	SMU200A	101521	2020.9.6
7	Signal Generator	Agilent	E4421B	MY4335105	2020.9.6
8	MXA Signal Analyzer	Agilent	N9020A	MY50510140	2020.9.6
9	MXA Signal Analyzer	Agilent	N9020A	MY51110104	2020.9.6
10	ANT Tower&Turn table Controller	Champro	EM 1000	60764	2020.9.6
11	Anechoic Chamber	Taihe Maorui	9m*6m*6m	966A0001	2020.9.6
12	Shielding Room	Taihe Maorui	6.4m*4m*3m	643A0001	2020.9.6
13	RF Power sensor	DARE	RPR3006W	15I00041SNO88	2020.9.6
14	RF Power sensor	DARE	RPR3006W	15I00041SNO89	2020.9.6
15	RF power divider	Anritsu	K241B	992289	2020.9.6
16	Wideband radio communication tester	Rohde&Schwarz	CMW500	154987	2020.9.6
17	Biconical antenna	Schwarzbeck	VHA 9103	91032360	2020.9.6
18	Biconical antenna	Schwarzbeck	VHA 9103	91032361	2020.9.6
19	Broadband Hybrid Antennas	Schwarzbeck	VULB9163	VULB9163#958	2020.9.6
20	Horn Antenna	Schwarzbeck	BBHA9120D	9120D-1680	2020.9.6
21	Active Receive Loop Antenna	Schwarzbeck	FMZB 1919B	00023	2020.9.6
22	Horn Antenna	Schwarzbeck	BBHA 9170	BBHA9170651	2020.9.6
23	Microwave Broadband Pre-amplifier	Schwarzbeck	BBV 9721	100472	2020.9.6
24	Active Loop Antenna	Com-Power	AL-130R	10160009	2020.9.6
25	Power Meter	KEYSIGHT	N1911A	MY50520168	2020.9.6
26	Frequency Meter	VICTOR	VC2000	997406086	2020.9.6
27	DC Power Source	HYELEC	HY5020E	055161818	2020.9.6
Test software					
1	E3	Audix	6.101223a	N/A	N/A

3. CONDUCTED EMISSIONS TEST

3.1 Conducted Power Line Emission Limit

For unintentional device, according to § 15.107(a) Line Conducted Emission Limits is as following

Frequency (MHz)	Maximum RF Line Voltage(dB μ V)			
	CLASS A		CLASS B	
	Q.P.	Ave.	Q.P.	Ave.
0.15~0.50	79	66	66~56*	56~46*
0.50~5.00	73	60	56	46
5.00~30.0	73	60	60	50

* Decreasing linearly with the logarithm of the frequency

For intentional device, according to §15.207(a) Line Conducted Emission Limit is same as above table.

3.2 Test Setup

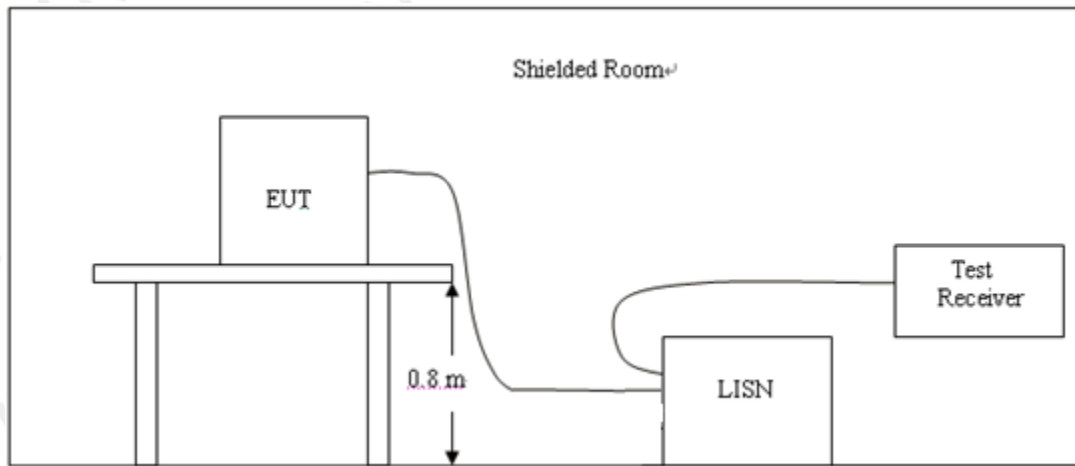

3.3 Test Procedure

- 1, The equipment was set up as per the test configuration to simulate typical actual usage per the user's manual. The EUT is a tabletop system, a wooden table with a height of 0.8 meters is used and is placed on the ground plane as per ANSI C63.10.
- 2, Support equipment, if needed, was placed as per ANSI C63.10.
- 3, All I/O cables were positioned to simulate typical actual usage as per ANSI C63.10.
- 4, If a EUT received DC power from the USB Port of Notebook PC, the PC's adapter received AC120V/60Hz power through a Line Impedance Stabilization Network (LISN) which supplied power source and was grounded to the ground plane.
- 5, All support equipments received AC power from a second LISN, if any.
- 6, The EUT test program was started. Emissions were measured on each current carrying line of the EUT using a spectrum Analyzer / Receiver connected to the LISN powering the EUT. The LISN has two monitoring points: Line 1 (Hot Side) and Line 2 (Neutral Side). Two scans were taken: one with Line 1 connected to Analyzer / Receiver and Line 2 connected to a 50 ohm load; the second scan had Line 1 connected to a 50 ohm load and Line 2 connected to the Analyzer / Receiver.
- 7, Analyzer / Receiver scanned from 150 KHz to 30MHz for emissions in each of the test modes.

3.4 Test Result

Pass

Remark:

1. All modes were tested at AC 120V and 240V, only the worst result of AC 120V was reported.
2. All modes were tested at Low, Middle, and High channel, only the worst result of 802.11b Low Channel was reported as below:

Temperature:	24°C	Relative Humidity:	48%
Test Date:	Apr. 15, 2020	Pressure:	1010hPa
Test Voltage:	120V/60Hz	Phase:	Line
Test Mode:	Transmitting mode of GFSK 2402MHz		

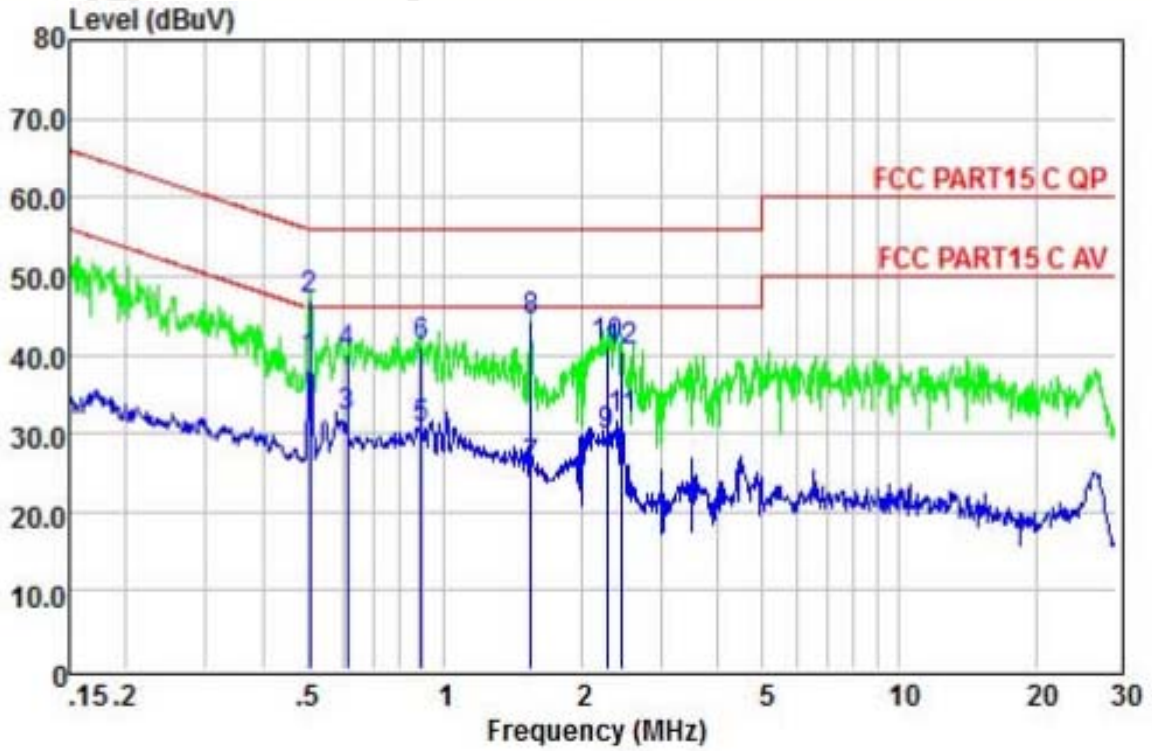

	Read Freq	Read Level	LISN Factor	Result Level	Limit Line	Over Limit	Remark
	MHz	dBuV	dB	dBuV	dBuV	dB	
1	0.51	29.55	9.69	39.24	46.00	-6.76	Average
2	0.51	37.21	9.69	46.90	56.00	-9.10	QP
3	0.61	22.56	9.66	32.22	46.00	-13.78	Average
4	0.61	30.53	9.66	40.19	56.00	-15.81	QP
5	0.89	21.00	9.62	30.62	46.00	-15.38	Average
6	0.89	31.39	9.62	41.01	56.00	-14.99	QP
7	1.55	15.89	9.60	25.49	46.00	-20.51	Average
8	1.55	34.76	9.60	44.36	56.00	-11.64	QP
9	2.28	20.05	9.59	29.64	46.00	-16.36	Average
10	2.28	31.59	9.59	41.18	56.00	-14.82	QP
11	2.46	22.27	9.58	31.85	46.00	-14.15	Average
12	2.46	30.92	9.58	40.50	56.00	-15.50	QP

Remark: Factor = Insertion Loss + Cable Loss, Result = Reading + Factor, Margin = Result – Limit.

Temperature:	24°C	Relative Humidity:	48%
Test Date:	Apr. 15, 2020	Pressure:	1010hPa
Test Voltage:	120V/60Hz	Phase:	Neutral
Test Mode:	Transmitting mode of GFSK 2402MHz		

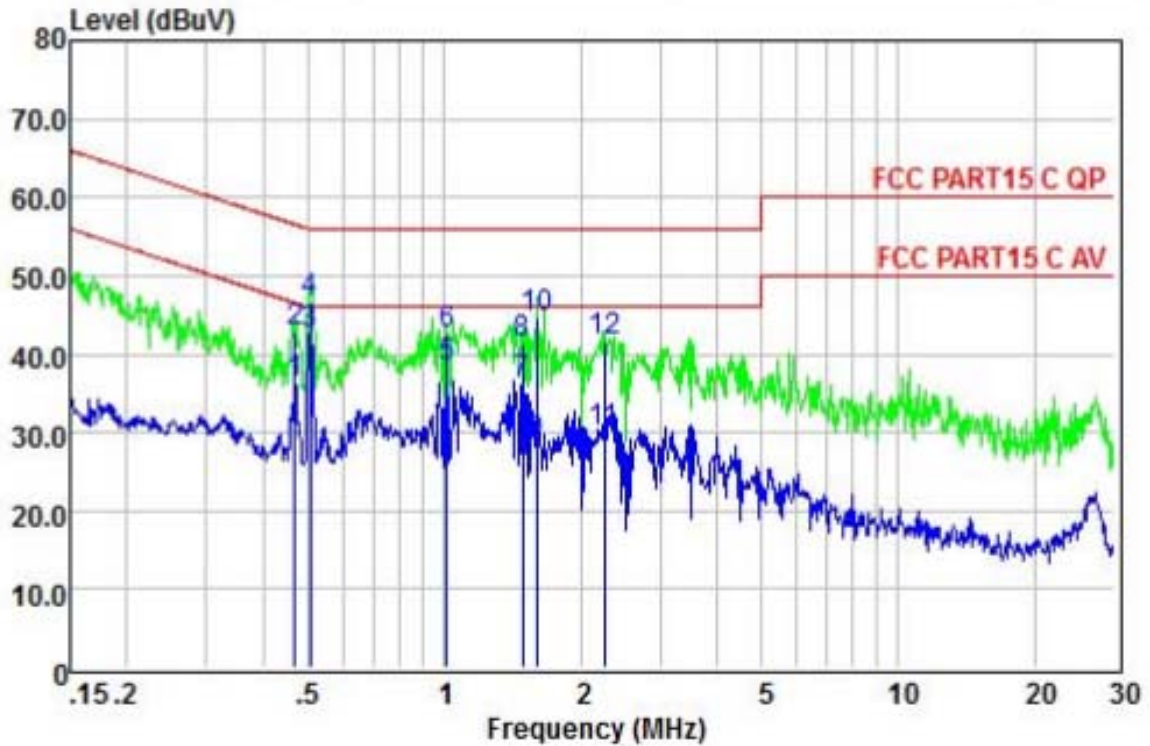

	Read Freq	Read Level	LISN Factor	Level	Limit Line	Over Limit	Remark
	MHz	dBuV	dB	dBuV	dBuV	dB	
1	0.47	26.69	9.63	36.32	46.54	-10.22	Average
2	0.47	33.26	9.63	42.89	56.54	-13.65	QP
3	0.51	32.80	9.63	42.43	46.00	-3.57	Average
4	0.51	37.17	9.63	46.80	56.00	-9.20	QP
5	1.02	28.74	9.63	38.37	46.00	-7.63	Average
6	1.02	32.87	9.63	42.50	56.00	-13.50	QP
7	1.49	26.82	9.60	36.42	46.00	-9.58	Average
8	1.49	31.69	9.60	41.29	56.00	-14.71	QP
9	1.60	18.98	9.59	28.57	46.00	-17.43	Average
10	1.60	35.03	9.59	44.62	56.00	-11.38	QP
11	2.26	20.41	9.59	30.00	46.00	-16.00	Average
12	2.26	31.94	9.59	41.53	56.00	-14.47	QP

Remark: Factor = Insertion Loss + Cable Loss, Result = Reading + Factor, Margin = Result – Limit.

4. RADIATED EMISSION TEST

4.1 Radiation Limit

For unintentional device, according to § 15.109(a), except for Class A digital devices, the field strength of radiated emissions from unintentional radiators at a distance of 3 meters shall not exceed the following values:

Frequency (MHz)	Distance (Meters)	Radiated (dB μ V/m)	Radiated (μ V/m)
30-88	3	40	100
88-216	3	43.5	150
216-960	3	46	200
Above 960	3	54	500

For intentional device, according to § 15.209(a), the general requirement of field strength of radiated emissions from intentional radiators at a distance of 3 meters shall not exceed the above table.

4.2 Test Setup

1. Radiated Emission Test-Up Frequency Below 30MHz

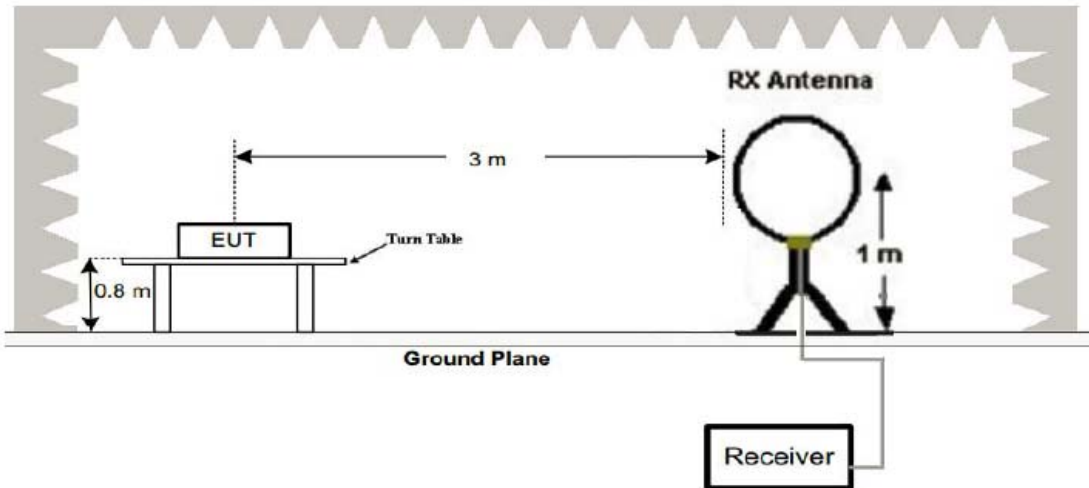

2. Radiated Emission Test-Up Frequency 30MHz~1GHz

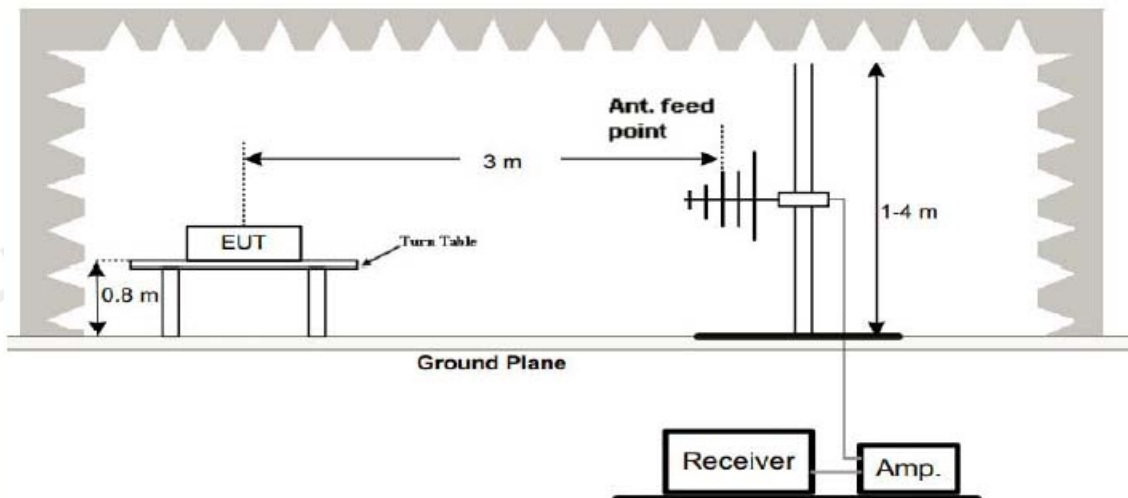

3. Radiated Emission Test-Up Frequency Above 1GHz

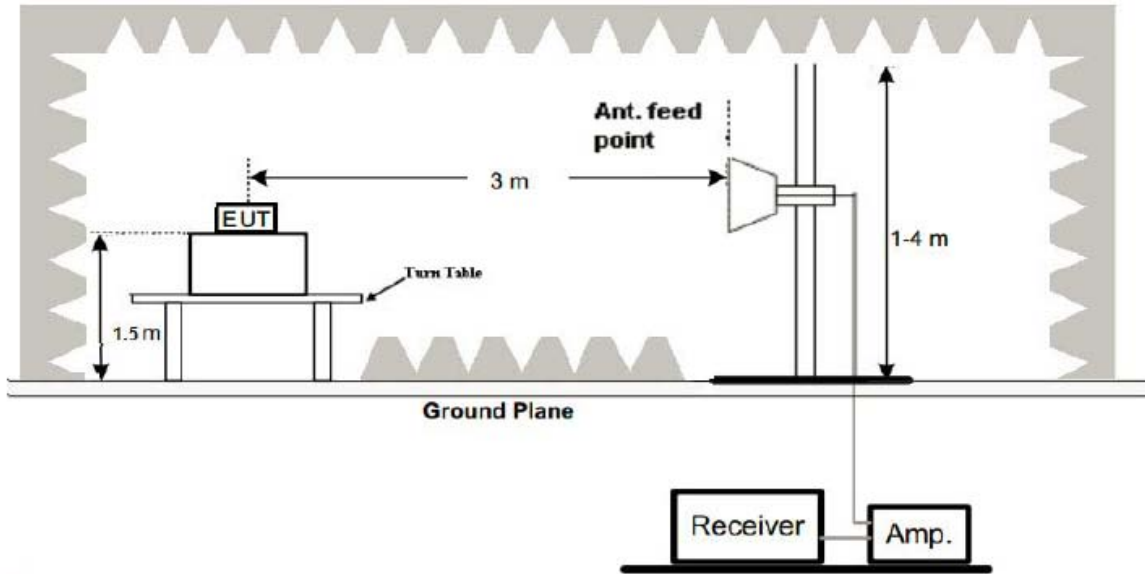

4.3 Test Procedure

1. Below 1GHz measurement the EUT is placed on turntable which is 0.8m above ground plane. And above 1GHz measurement EUT was placed on low permittivity and low tangent turn table which is 1.5m above ground plane.
2. The turntable shall be rotated for 360 degrees to determine the position of maximum emission level.
3. EUT is set 3m away from the receiving antenna, which is varied from 1m to 4m to find out the highest emissions.
4. Maximum procedure was performed on the six highest emissions to ensure EUT compliance.
5. And also, each emission was to be maximized by changing the polarization of receiving antenna both horizontal and vertical.
6. Repeat above procedures until the measurements for all frequencies are complete.
7. The test frequency range from 9KHz to 25GHz per FCC PART 15.33(a).
8. The distance between test antenna and EUT as following table states:

Test Frequency range	Test Antenna Type	Test Distance
9KHz-30MHz	Active Loop Antenna	3
30MHz-1GHz	Bilog Antenna	3
1GHz-18GHz	Horn Antenna	3
18GHz-25GHz	Horn Antenna	1

Note:

For battery operated equipment, the equipment tests shall be performed using a new battery.

4.4 Test Result

PASS

Remark:

1. All the test modes completed for test. The worst case of Radiated Emission is High channel, the test data of this mode was reported.
2. By preliminary testing and verifying three axis (X, Y and Z) position of EUT transmitted status, it was found that "Z axis" position was the worst, and test data recorded in this report.
3. Radiated emission test from 9KHz to 10th harmonic of fundamental was verified, and no emission found except system noise floor in 9KHz to 30MHz and not recorded in this report.

Below 1GHz Test Results:

Temperature:	22°C	Relative Humidity:	48%
Test Date:	Nov. 25, 2019	Pressure:	1010hPa
Test Voltage:	DC 12V from battery	Polarization:	Horizontal
Test Mode:	Transmitting mode of GFSK 2402MHz		

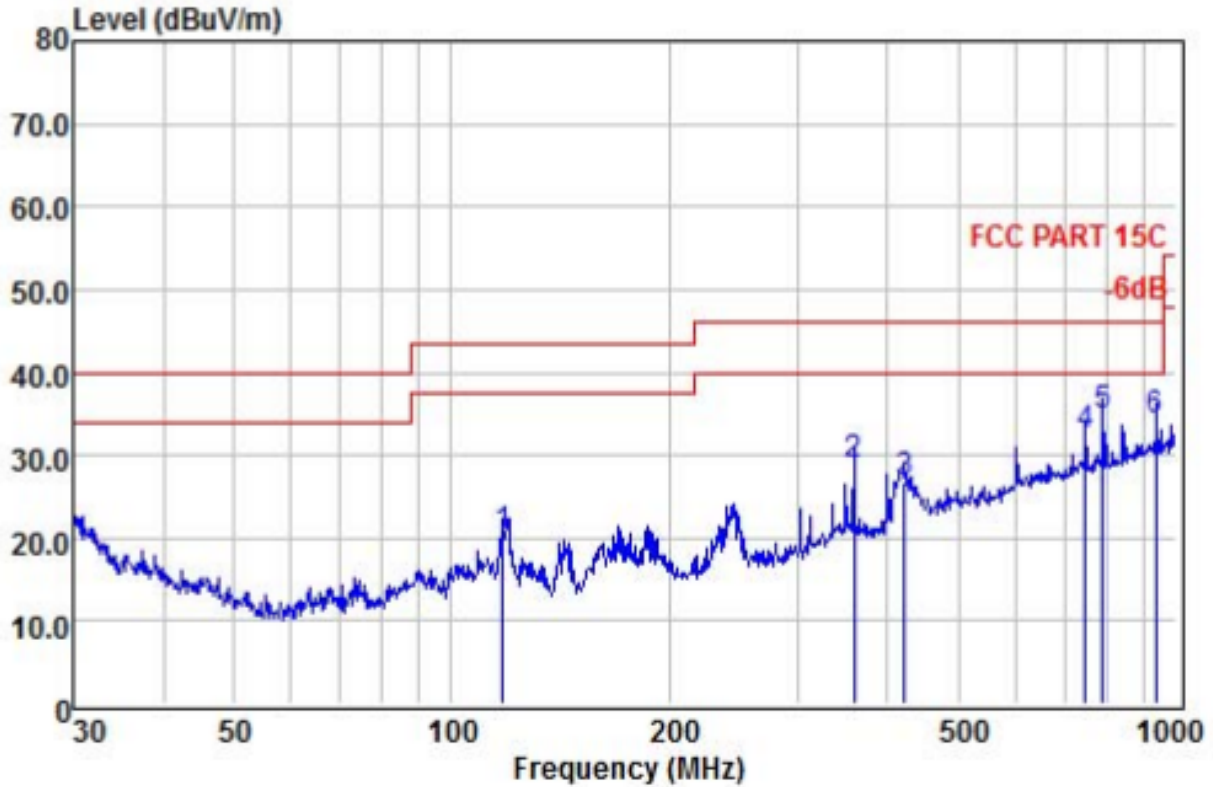

	ReadAntenna	Cable	Limit	Over			
Freq	Level	Factor	Loss	Level	Line	Limit	Remark
MHz	dBuV	dB/m	dB	dBuV/m	dBuV/m	dB	
1	117.77	11.18	8.90	0.20	20.28	43.50	-23.22 QP
2	360.45	11.97	16.12	0.81	28.90	46.00	-17.10 QP
3	423.54	8.84	16.90	0.98	26.72	46.00	-19.28 QP
4	750.11	8.17	22.80	1.31	32.28	46.00	-13.72 QP
5	793.40	10.48	22.92	1.39	34.79	46.00	-11.21 QP
6	938.83	7.89	24.64	1.65	34.18	46.00	-11.82 QP

Remark: Absolute Level = Reading Level + Factor, Margin = Absolute Level – Limit
 Factor = Ant. Factor + Cable Loss – Pre-amplifier

Temperature:	22°C	Relative Humidity:	48%
Test Date:	Nov. 25, 2019	Pressure:	1010hPa
Test Voltage:	DC 12V from battery	Polarization:	Vertical
Test Mode:	Transmitting mode of GFSK 2402MHz		

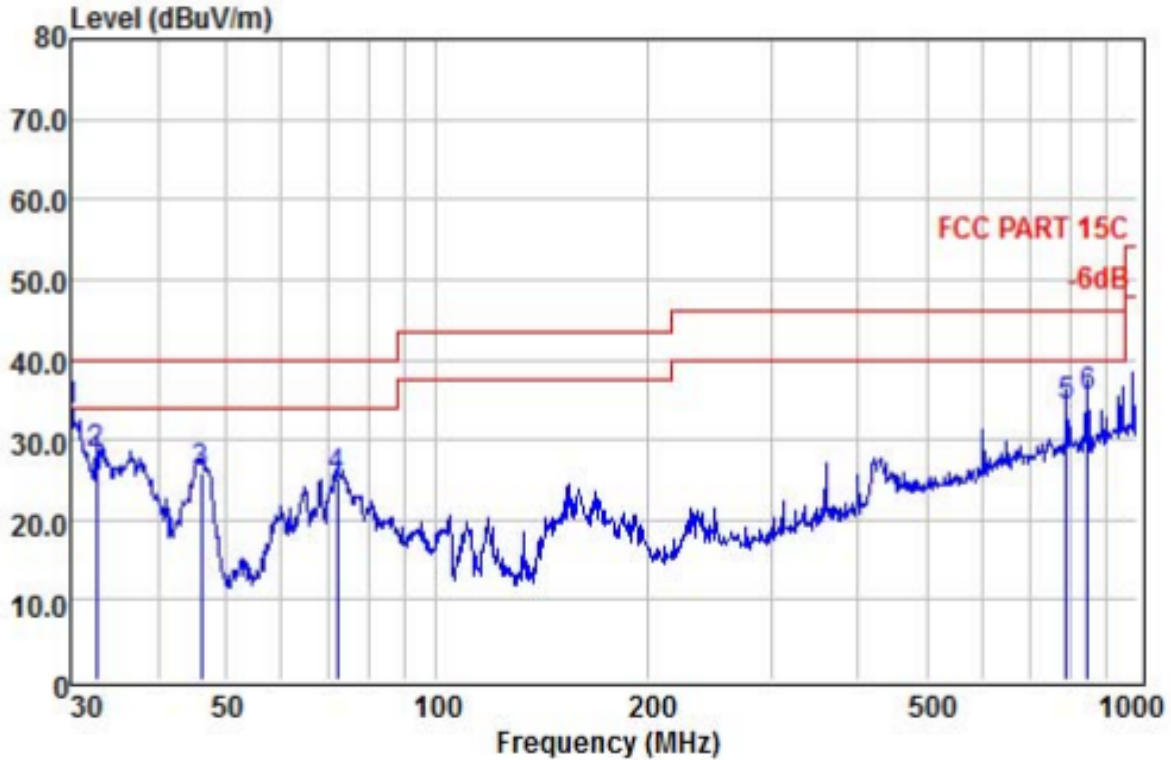

	ReadAntenna	Cable	Limit	Over			
Freq	Level	Factor	Line	Limit	Remark		
MHz	dBuV	dB/m	dB	dBuV/m	dBuV/m	dB	
1	30.00	14.56	18.80	0.34	33.70	40.00	-6.30 QP
2	32.63	10.85	17.25	0.28	28.38	40.00	-11.62 QP
3	46.18	15.31	10.37	0.12	25.80	40.00	-14.20 QP
4	72.08	17.50	7.60	0.14	25.24	40.00	-14.76 QP
5	793.40	9.97	22.92	1.39	34.28	46.00	-11.72 QP
6	851.04	10.74	23.12	1.52	35.38	46.00	-10.62 QP

Remark: Absolute Level = Reading Level + Factor, Margin = Absolute Level – Limit
 Factor = Ant. Factor + Cable Loss – Pre-amplifier

Remark:

- (1) Measuring frequencies from 9 KHz to the 1 GHz, Radiated emission test from 9KHz to 30MHz was verified, and no any emission was found except system noise floor.
- (2) * denotes emission frequency which appearing within the Restricted Bands specified in provision of 15.205, then the general radiated emission limits in 15.209 apply.
- (3) The IF bandwidth of EMI Test Receiver between 30MHz to 1GHz was 120KHz, 1 MHz for measuring above 1 GHz, below 30MHz was 10KHz.

Above 1 GHz Test Results:
CH Low (2402MHz)

Horizontal:

Frequency (MHz)	Reading Result (dBμV)	Factor (dB)	Emission Level (dBμV/m)	Limits (dBμV/m)	Margin (dB)	Detector Type
2402	105.69	-5.84	99.85	114.00	-14.15	PK
2402	83.59	-5.84	77.75	94.00	-16.25	AV
4804	62.53	-3.64	58.89	74.00	-15.11	PK
4804	52.41	-3.64	48.77	54.00	-5.23	AV
7206	64.29	-0.95	63.34	74.00	-10.66	PK
7206	49.33	-0.95	48.38	54.00	-5.62	AV

Remark: Factor = Antenna Factor + Cable Loss – Pre-amplifier. Margin = Absolute Level – Limit

Vertical:

Frequency (MHz)	Reading Result (dBμV)	Factor (dB)	Emission Level (dBμV/m)	Limits (dBμV/m)	Margin (dB)	Detector Type
2402	104.29	-5.84	98.45	114.00	-15.55	PK
2402	82.36	-5.84	76.52	94.00	-17.48	AV
4804	61.28	-3.64	57.64	74.00	-16.36	PK
4804	50.22	-3.64	46.58	54.00	-7.42	AV
7206	62.57	-0.95	61.62	74.00	-12.38	PK
7206	50.27	-0.95	49.32	54.00	-4.68	AV

Remark: Factor = Antenna Factor + Cable Loss – Pre-amplifier. Margin = Absolute Level – Limit

CH Middle (2440MHz)

Horizontal:

Frequency (MHz)	Reading Result (dBμV)	Factor (dB)	Emission Level (dBμV/m)	Limits (dBμV/m)	Margin (dB)	Detector Type
2440	104.89	-5.71	99.18	114.00	-14.82	PK
2440	83.62	-5.71	77.91	94.00	-16.09	AV
4880	62.54	-3.51	59.03	74.00	-14.97	PK
4880	51.26	-3.51	47.75	54.00	-6.25	AV
7320	62.57	-0.82	61.75	74.00	-12.25	PK
7320	48.27	-0.82	47.45	54.00	-6.55	AV

Remark: Factor = Antenna Factor + Cable Loss – Pre-amplifier. Margin = Absolute Level – Limit

Vertical:

Frequency (MHz)	Reading Result (dBμV)	Factor (dB)	Emission Level (dBμV/m)	Limits (dBμV/m)	Margin (dB)	Detector Type
2440	105.36	-5.71	99.65	114.00	-14.35	PK
2440	81.22	-5.71	75.51	94.00	-18.49	AV
4880	61.75	-3.51	58.24	74.00	-15.76	PK
4880	50.28	-3.51	46.77	54.00	-7.23	AV
7320	63.54	-0.82	62.72	74.00	-11.28	PK
7320	47.19	-0.82	46.37	54.00	-7.63	AV

Remark: Factor = Antenna Factor + Cable Loss – Pre-amplifier. Margin = Absolute Level – Limit

CH High (2480MHz)
Horizontal:

Frequency	Reading Result	Factor	Emission Level	Limits	Margin	Detector
(MHz)	(dBμV)	(dB)	(dBμV/m)	(dBμV/m)	(dB)	Type
2480	105.38	-5.65	99.73	114.00	-14.27	PK
2480	92.54	-5.65	86.89	94.00	-7.11	AV
4960	60.28	-3.43	56.85	74.00	-17.15	PK
4960	51.39	-3.43	47.96	54.00	-6.04	AV
7440	63.59	-0.75	62.84	74.00	-11.16	PK
7440	47.89	-0.75	47.14	54.00	-6.86	AV

Remark: Factor = Antenna Factor + Cable Loss – Pre-amplifier. Margin = Absolute Level – Limit

Vertical:

Frequency	Reading Result	Factor	Emission Level	Limits	Margin	Detector
(MHz)	(dBμV)	(dB)	(dBμV/m)	(dBμV/m)	(dB)	Type
2480	105.39	-5.65	99.74	114.00	-14.26	PK
2480	82.46	-5.65	76.81	94.00	-17.19	AV
4960	62.33	-3.43	58.9	74.00	-15.1	PK
4960	52.47	-3.43	49.04	54.00	-4.96	AV
7440	62.49	-0.75	61.74	74.00	-12.26	PK
7440	47.29	-0.75	46.54	54.00	-7.46	AV

Remark: Factor = Antenna Factor + Cable Loss – Pre-amplifier. Margin = Absolute Level – Limit

Remark :

- (1) Measuring frequencies from 1 GHz to the 25 GHz.
- (2) "F" denotes fundamental frequency; "H" denotes spurious frequency. "E" denotes band edge frequency.
- (3) * denotes emission frequency which appearing within the Restricted Bands specified in provision of 15.205, then the general radiated emission limits in 15.209 apply.
- (4) Data of measurement within this frequency range shown "----" in the table above means the reading of emissions are attenuated more than 20dB below the permissible limits or the field strength is too small to be measured.
- (5) The IF bandwidth of EMI Test Receiver between 30MHz to 1GHz was 120KHz, 1 MHz for measuring above 1 GHz, below 30MHz was 10KHz. The resolution bandwidth of test receiver/spectrum analyzer is 1MHz and video bandwidth is 3MHz for peak measurement with peak detector at frequency above 1GHz. The resolution bandwidth of test receiver/spectrum analyzer is 1MHz and video bandwidth is 10Hz for Average measurement with peak detection at frequency above 1GHz.
- (6) When the test results of Peak Detected below the limits of Average Detected, the Average Detected is not need completed. For example: Top Channel at Fundamental 73.16dBuV/m(PK Value) <93.98(AV Limit), at harmonic 53.20 dBuV/m(PK Value) <54 dBuV/m(AV Limit), the Average Detected not need to completed.
- (7) All modes of operation were investigated and the worst-case emissions are reported.

5. BAND EDGE

5.1 Limits

FCC PART 15.249(d) Emissions radiated outside of the specified frequency bands, except for harmonics, shall be attenuated by at least 50 dB below the level of the fundamental or to the general radiated emission limits in §15.209, whichever is the lesser attenuation.

5.2 Test Procedure

The band edge compliance of RF radiated emission should be measured by following the guidance in ANSI C63.10 with respect to maximizing the emission by rotating the EUT, measuring the emission while the EUT is situated in three orthogonal planes (if appropriate), adjusting the measurement antenna height and polarization etc. Set RBW to 100KHz and VBM to 300KHz to measure the peak field strength and set RBW to 1MHz and VBW to 10Hz to measure the average radiated field strength. The conducted RF band edge was measured by using a spectrum analyzer. Set span wide enough to capture the highest in-band emission and the emission at the band edge. Set RBW to 100 KHz and VBW to 300 KHz, to measure the conducted peak band edge.

5.3 Test Result

PASS

Radiated Band Edge Test:

Operation Mode: TX CH Low (2402MHz)

Horizontal:

Frequency (MHz)	Reading Result (dBμV)	Factor (dB)	Emission Level (dBμV/m)	Limits (dBμV/m)	Margin (dB)	Detector Type
2310	53.26	-5.81	47.45	74.00	-26.55	PK
2310	/	-5.81	/	54.00	/	AV
2390	52.47	-5.84	46.63	74.00	-27.37	PK
2390	/	-5.84	/	54.00	/	AV
2400	52.69	-5.84	46.85	74.00	-27.15	PK
2400	/	-5.84	/	54.00	/	AV

Remark: Factor = Antenna Factor + Cable Loss – Pre-amplifier.

Vertical:

Frequency (MHz)	Reading Result (dBμV)	Factor (dB)	Emission Level (dBμV/m)	Limits (dBμV/m)	Margin (dB)	Detector Type
2310	53.68	-5.81	47.87	74.00	-26.13	PK
2310	/	-5.81	/	54.00	/	AV
2390	52.47	-5.84	46.63	74.00	-27.37	PK
2390	/	-5.84	/	54.00	/	AV
2400	52.16	-5.84	46.32	74.00	-27.68	PK
2400	/	-5.84	/	54.00	/	AV

Remark: Factor = Antenna Factor + Cable Loss – Pre-amplifier.

Operation Mode: TX CH High (2480MHz)

Horizontal:

Frequency (MHz)	Reading Result (dB μ V)	Factor (dB)	Emission Level (dB μ V/m)	Limits (dB μ V/m)	Margin (dB)	Detector Type
2483.5	53.26	-5.65	47.61	74.00	-26.39	PK
2483.5	/	-5.65	/	54.00	/	AV
2500	52.47	-5.72	46.75	74.00	-27.25	PK
2500	/	-5.72	/	54.00	/	AV

Remark: Factor = Antenna Factor + Cable Loss – Pre-amplifier.

Vertical:

Frequency (MHz)	Reading Result (dB μ V)	Factor (dB)	Emission Level (dB μ V/m)	Limits (dB μ V/m)	Margin (dB)	Detector Type
2483.5	52.99	-5.65	47.34	74.00	-26.66	PK
2483.5	/	-5.65	/	54.00	/	AV
2500	52.65	-5.72	46.93	74.00	-27.07	PK
2500	/	-5.72	/	54.00	/	AV

Remark: Factor = Antenna Factor + Cable Loss – Pre-amplifier.

6. OCCUPIED BANDWIDTH MEASUREMENT

6.1 Test Limit

FCC Part15(15.247), Subpart C				
Section	Test Item	Limit	Frequency Range (MHz)	Result
15.247(a)(2)	Bandwidth	>= 500KHz (6dB bandwidth)	2400-2483.5	PASS

6.2 Test Procedure

1. The EUT was placed on a turn table which is 0.8m above ground plane.
2. Set EUT as normal operation.
3. Based on FCC Part15 C Section 15.247: RBW=100KHz, VBW=300KHz.
4. The useful radiated emission from the EUT was detected by the spectrum analyzer with peak detector.

6.3 Measurement Equipment Used

Same as Radiated Emission Measurement

6.4 Test Result

PASS

Frequency (MHz)	6dB Bandwidth (MHz)	Result
2402	0.707	PASS
2440	0.698	PASS
2480	0.700	PASS

CH: 2402MHz



CH: 2440MHz

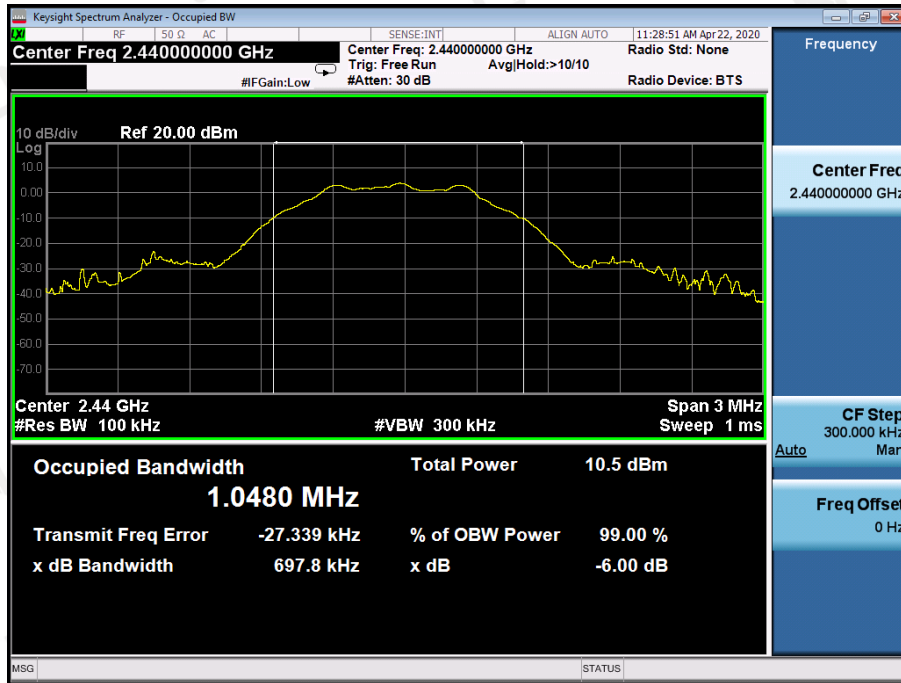

CH: 2480MHz



7. POWER SPECTRAL DENSITY TEST

7.1 Test Limit

FCC Part15(15.247), Subpart C				
Section	Test Item	Limit	Frequency Range (MHz)	Result
15.247	Power Spectral Density	8 dBm (in any 3KHz)	2400-2483.5	PASS

7.2 Test Procedure

1. The EUT was placed on a turn table which is 0.8m above ground plane.
2. Set EUT as normal operation.
3. Based on FCC Part15 C Section 15.247: RBW=3KHz, VBW=10KHz.
4. The useful radiated emission from the EUT was detected by the spectrum analyzer with peak detector.

7.3 Measurement Equipment Used

Same as Radiated Emission Measurement

7.4 Test Result

PASS

Type	Channel	Power Spectral Density	Limit (dBm/3KHz)	Result
GFSK	0	-13.115	8.00	Pass
	19	-12.581		
	39	-12.301		

CH: 2402MHz

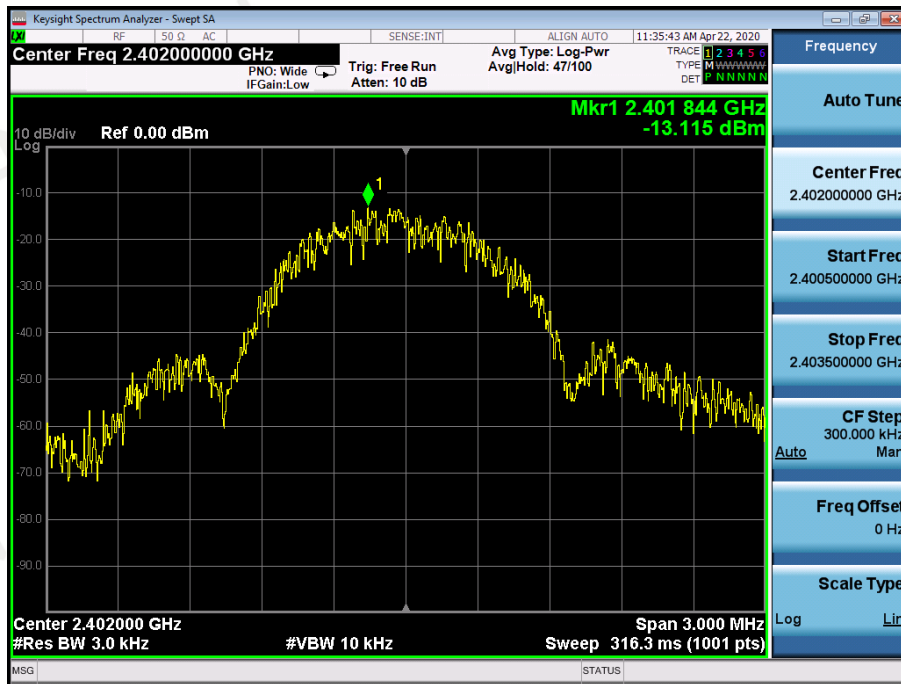

CH: 2440MHz

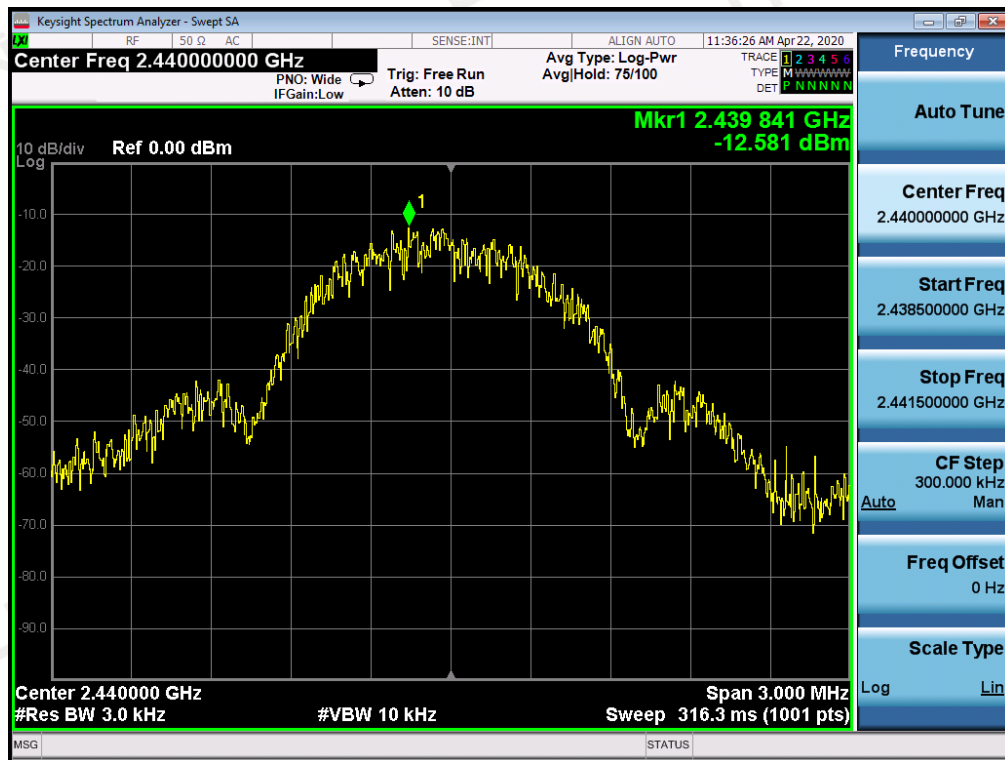

CH: 2480MHz

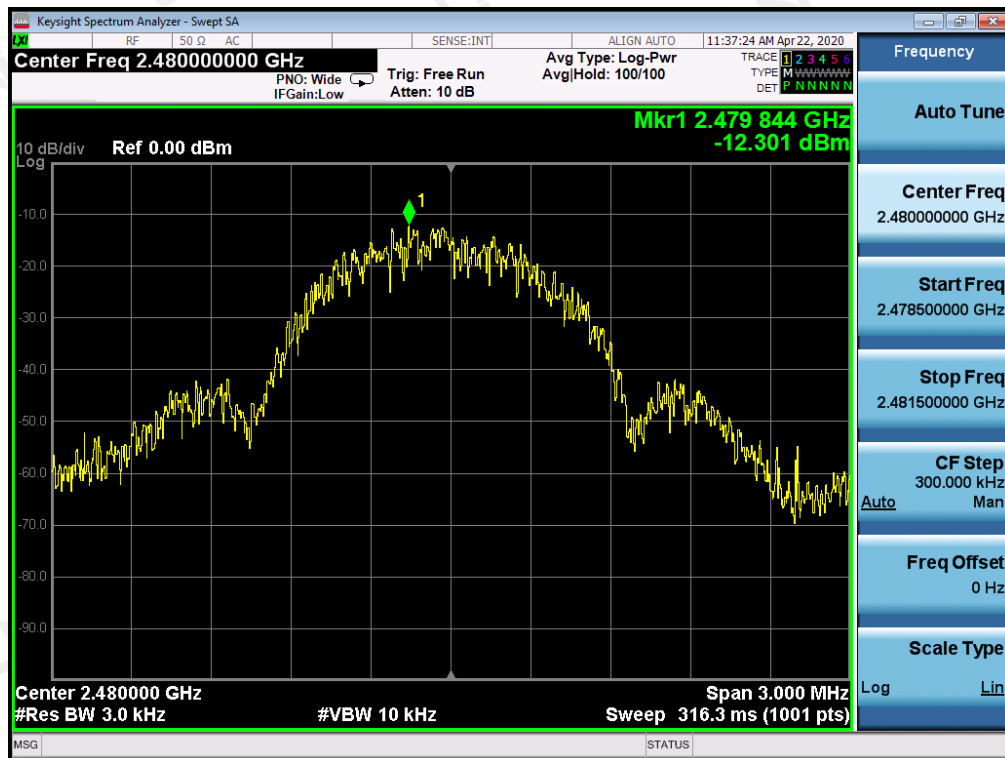

8. PEAK OUTPUT POWER TEST

8.1 Test Limit

FCC Part15(15.247), Subpart C & RSS-247 [5.3(4)]				
Section	Test Item	Limit	Frequency Range (MHz)	Result
15.247(b)(3)	Peak Output Power	1 watt or 30dBm	2400-2483.5	PASS

8.2 Test Procedure

1. The EUT was placed on a turn table which is 0.8m above ground plane.
2. The EUT was directly connected to the Power meter.

8.3 Measurement Equipment Used

Same as Radiated Emission Measurement.

8.4 Test Result

PASS

Type	Channel	Peak Output power (dBm)	Limit (dBm)	Result
GFSK	0	3.462	30	Pass
	19	2.986		
	39	2.886		

9. CONDUCTED BANDEGE MEASUREMENT

9.1 Test Setup



9.2 Test Procedure

1. The EUT was placed on a turn table which is 0.8m above ground plane.
2. Set EUT as TX operation and connect directly to the spectrum analyzer.
3. Based on FCC Part15 C Section 15.247: RBW=100KHz, VBW=300KHz.
4. Set detected by the spectrum analyzer with peak detector.

9.3 Limit

In any 100 kHz bandwidth outside the frequency band in which the spread spectrum or digitally modulated intentional radiator is operating, the radio frequency power that is produced by the intentional radiator shall be at least 20 dB below that in the 100 kHz bandwidth within the band that contains the highest level of the desired power, based on either an RF conducted or a radiated measurement, provided the transmitter demonstrates compliance with the peak conducted power limits. If the transmitter complies with the conducted power limits based on the use of RMS averaging over a time interval, as permitted under paragraph (b)(3) of this section, the attenuation required under this paragraph shall be 30 dB instead of 20dB.

9.4 Test Result

PASS

Frequency Band	Delta Peak to band emission(dBc)	>Limit (dBc)	Result
Left-band	46.28	20	Pass
Right-band	57.50	20	Pass

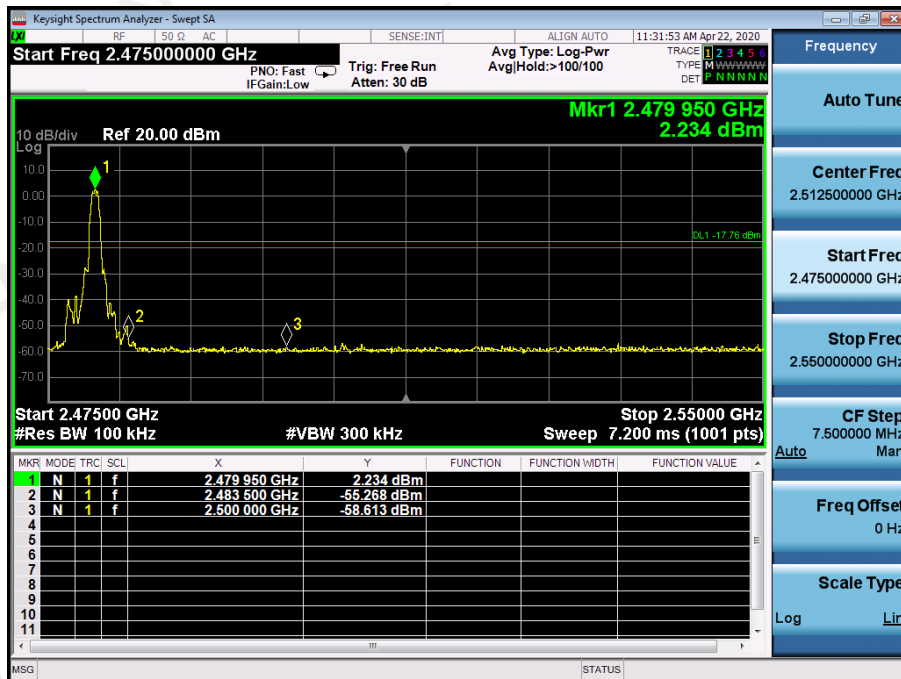
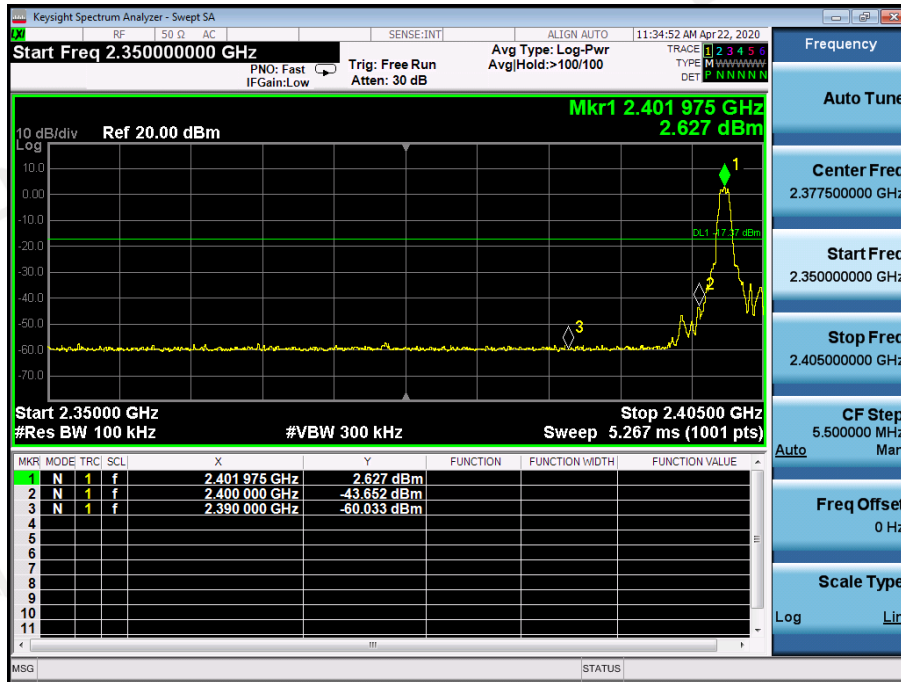

10. SPURIOUS RF CONDUCTED EMISSION

10.1 Test Limit

1. Below -20dB of the highest emission level in operating band.
2. Fall in the restricted bands listed in section 15.205. The maximum permitted average field strength is listed in section 15.209.
3. For below 30MHz, For 9KHz-150kHz, 150K-10MHz, We use the RBW 1KHz, 10KHz, So the limit need to be calculated by " $10\lg(BW1/BW2)$ ". for example For 9KHz-150kHz, RBW 1KHz, The Limit= the highest emission level-20-10log(100/1)= the highest emission level-40.

10.2 Test Procedure

The Spurious RF conducted emissions compliance of RF radiated emission should be measured by following the guidance in ANSI C63.10-2013, For 9KHz-150kHz, Set RBW=1kHz and VBW= 3KHz; For 150KHz-10MHz, Set RBW=10kHz and VBW= 30KHz; For 10MHz-25GHz, Set RBW=100kHz and VBW= 300KHz in order to measure the peak field strength, and measure frequency range from 9KHz to 25GHz.

10.3 Test Setup

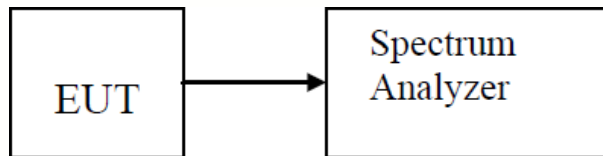

10.4 Test Result

PASS

CH: 2402MHz

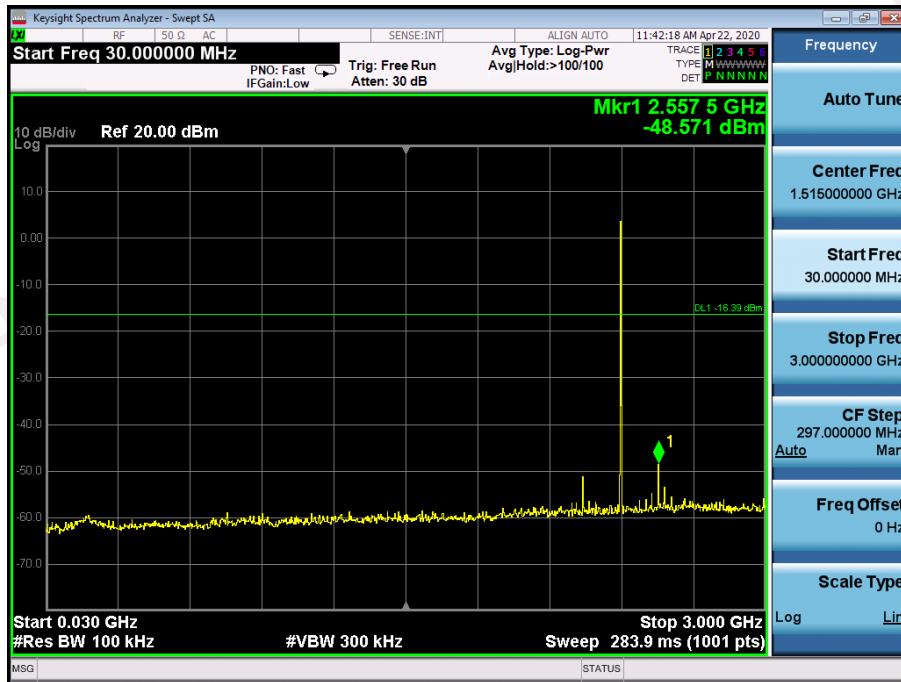

30MHz~3GHz

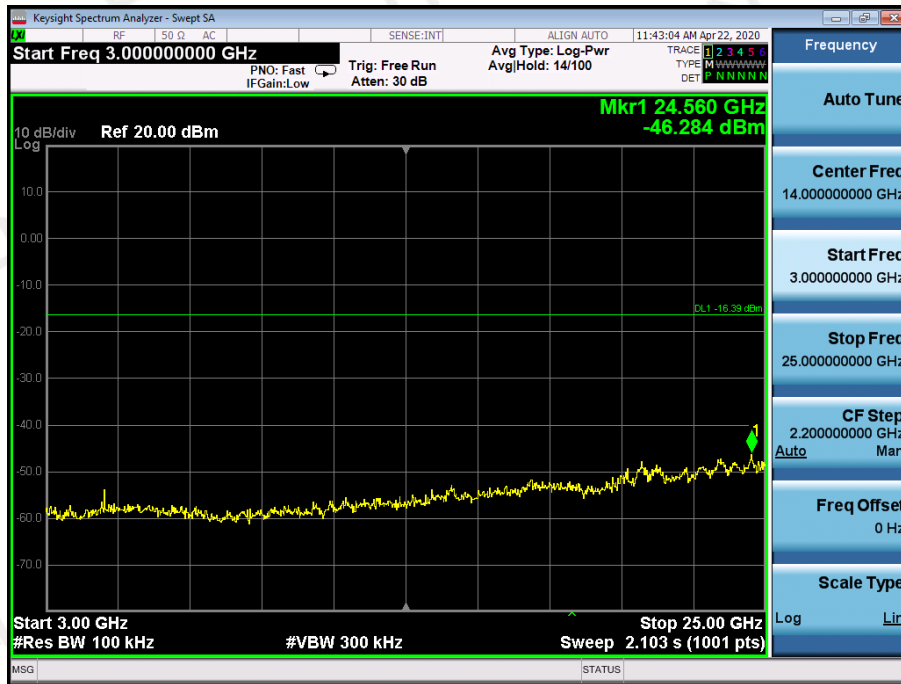

3GHz~25GHz

CH: 2440MHz

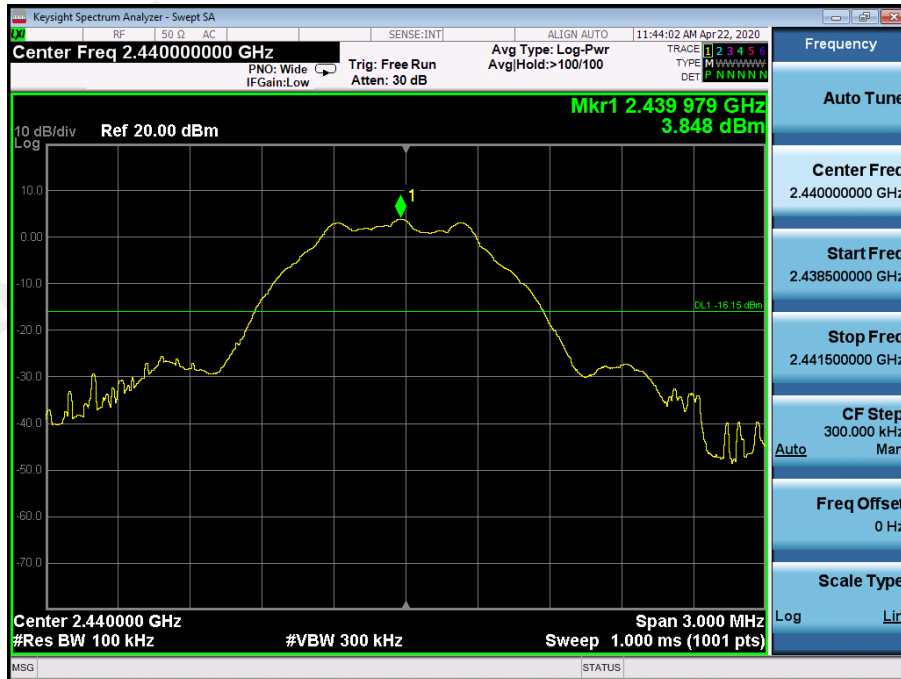

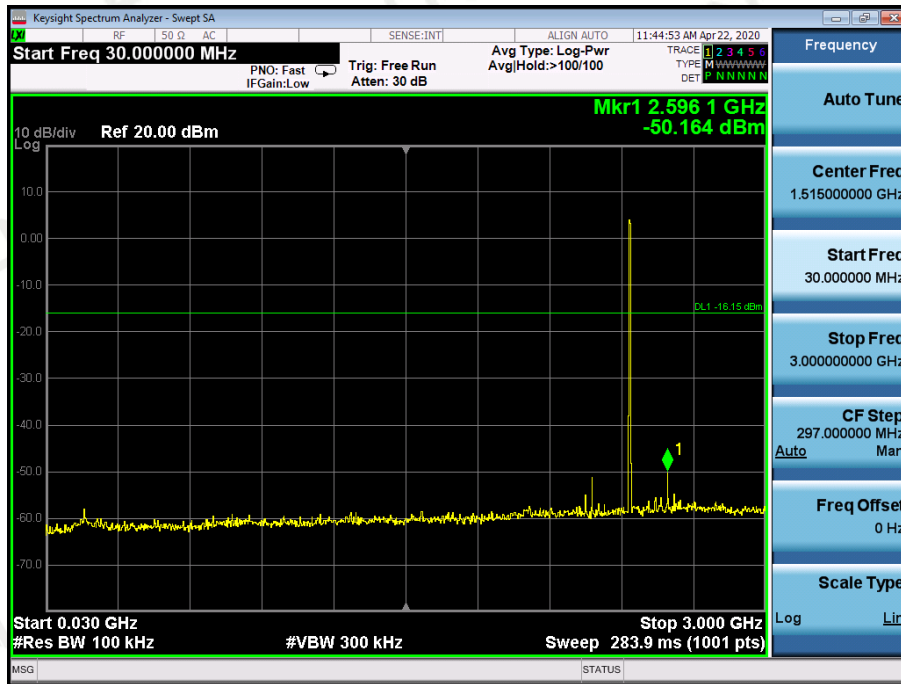

30MHz~3GHz



3GHz~25GHz

CH: 2480MHz

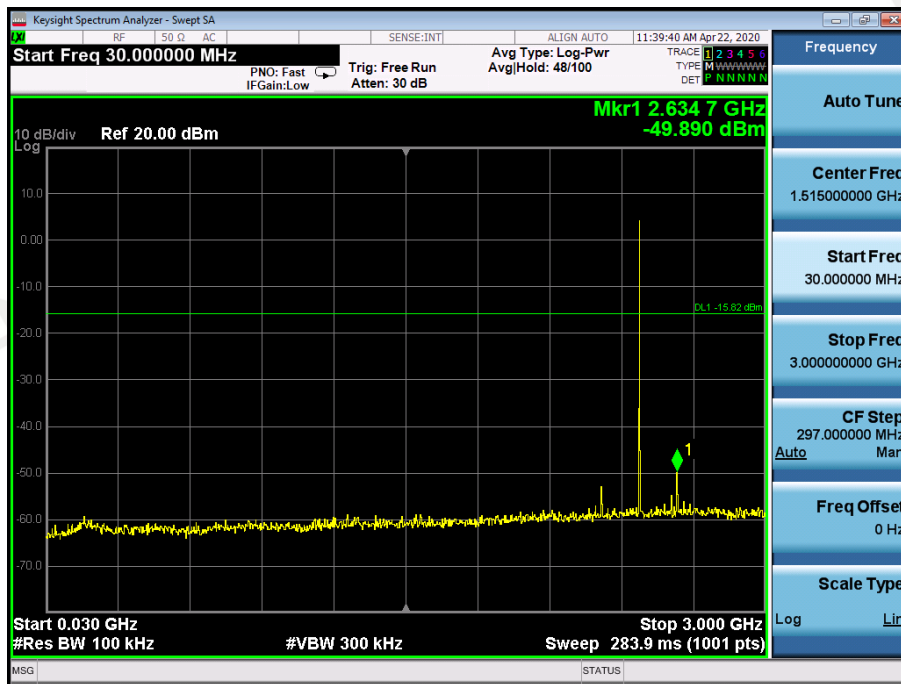

30MHz~3GHz



3GHz~25GHz

11. ANTENNA REQUIREMENT

Standard Applicable:

For intentional device, according to FCC 47 CFR Section 15.203, an intentional radiator shall be designed to ensure that no antenna other than that furnished by the responsible party shall be used with the device.

Antenna Connected Construction

The antenna used in this product is an Internal Antenna, The directional gains of antenna used for transmitting is 2.08dBi.

ANTENNA:

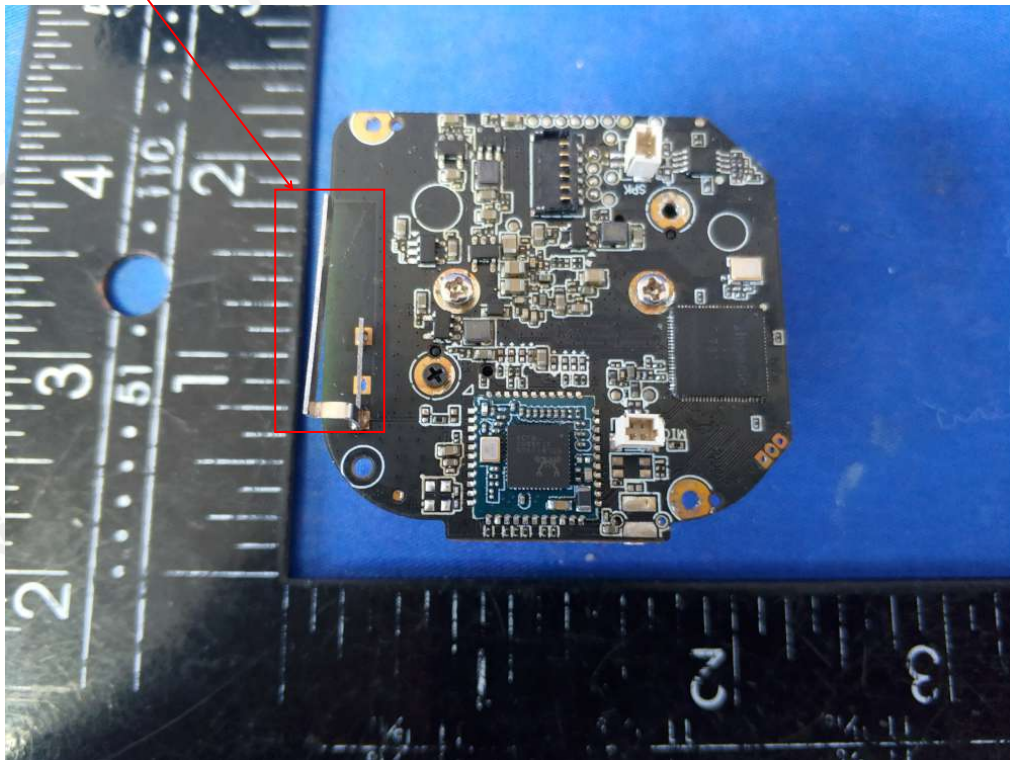

12. PHOTOGRAPH OF TEST

**Radiated Emission
(Below 1G)**



**Radiated Emission
(Above 1G)**

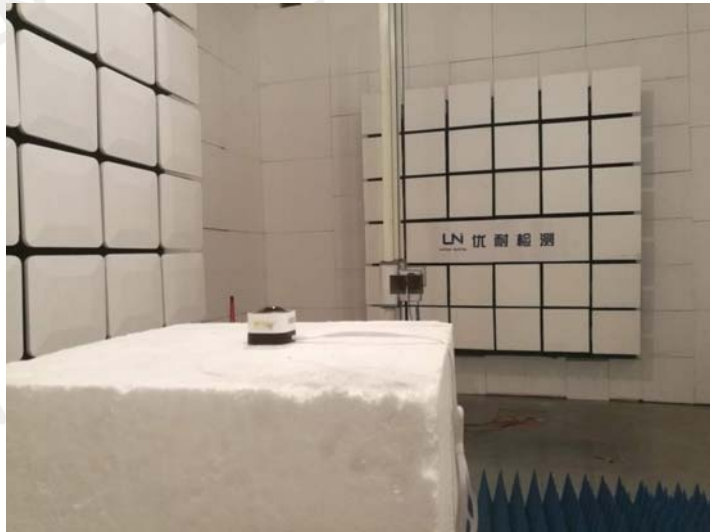

Conducted Emission



End of Report