



 momentum®



Teri™  
Wire-Free Outdoor Battery Camera

INSTALLATION GUIDE





# TABLE OF CONTENTS

## Content

- 1 WHAT'S IN THE BOX?
- 4 MOMENTUM SECURE APP
- 6 PAIRING
- 6 INSTRUCTIONS
- 9 CAMERA INSTALLATION
- 14 FEATURES
- 18 TROUBLESHOOTING
- 26 WARRANTY





1

# WHAT'S IN THE BOX

Accessories





# WHAT'S INCLUDED

## Before you Begin

Check to make sure you have all the pieces and accessories that should be included in the box.

## For Smart Hub Installation

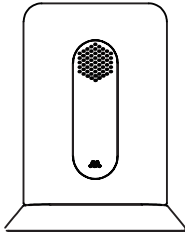

Smart Hub

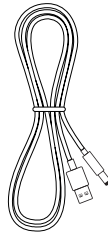

Hub Power Cord



Hub Power Adapter

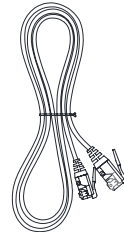

Ethernet Cable





# WHAT'S INCLUDED

## For Camera Installation

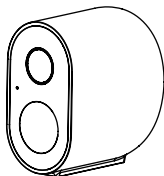

Teri Camera (2)

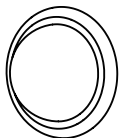

Ball Mount (2)

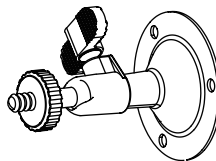

Screw Mount (2)

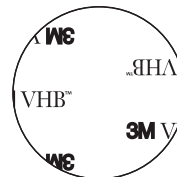

Mounting Sticker (2)



Charging Adapter

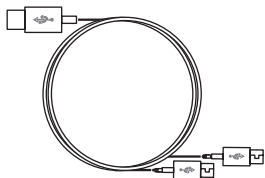

Charging Cable

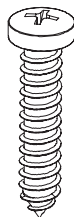

Mounting Screw (6)



Wall Anchors (6)





2

# MOMENTUM SECURE APP

Downloading the App



# MOMENTUM SECURE APP



- Download the **Momentum Secure App** from the Apple App Store or Google Play Store.
- **Create a new account** with your email address or login to your existing account.



3

# PAIRING INSTRUCTIONS

Connecting the Smart Hub  
Pairing





# PAIRING INSTRUCTIONS

## STEP 1 - Connect the Smart Hub

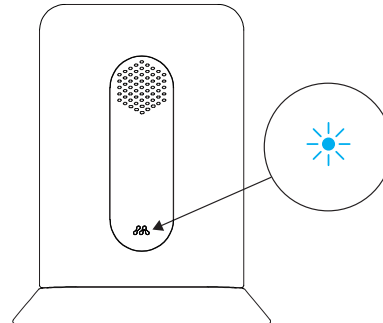
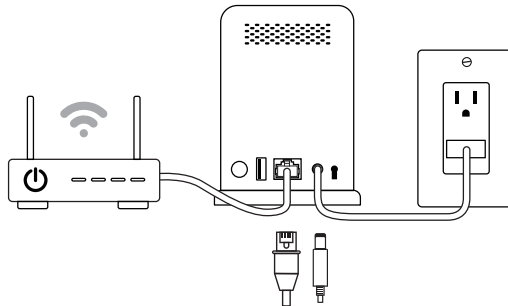

1. **Connect the ethernet cable** to the Smart Hub and WiFi router.
2. **Power the Smart Hub** by connecting the Hub power adapter to a nearby outlet.
3. Wait for the indicator light to **turn solid blue.**

# PAIRING INSTRUCTIONS

## STEP 2 - Pair the Smart Hub and Camera



1. Tap the + icon to **add a new device**.
2. Select the **Teri camera option**.

3. Follow the **on-screen app instructions** to complete the pairing process.

8



4

# CAMERA INSTALLATION

Installation Height  
Mounting





# CAMERA INSTALLATION

## Camera Placement

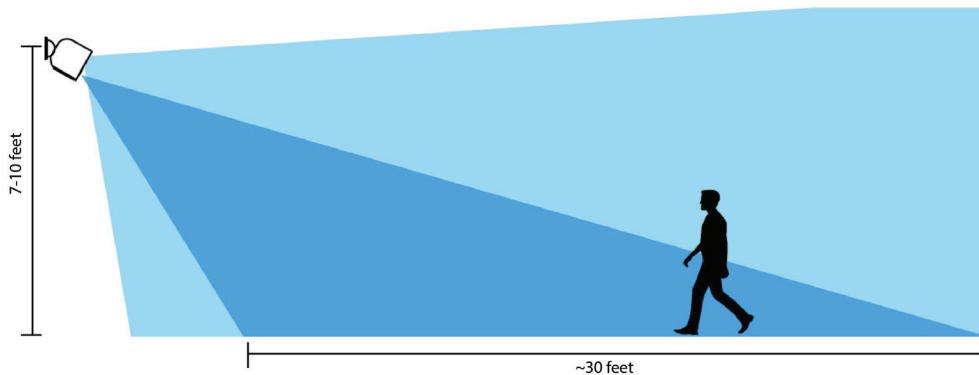

- It is recommended to install the camera between 7-10 ft off the ground for the best performance.
- Avoid installing in places where the camera will be directly exposed to sunlight.
- Make sure you pick a spot where the camera will still get good wireless signal strength.





# CAMERA INSTALLATION

## Choosing your Mount

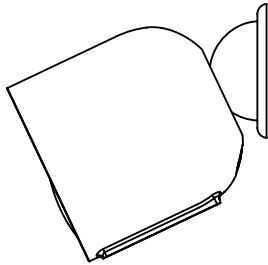

Ball Mount

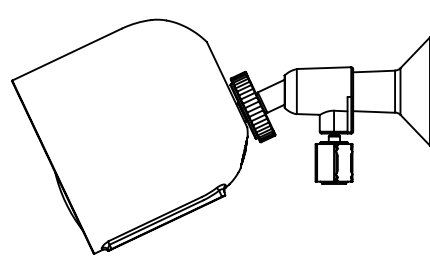

Screw Mount

- You will find two types of mounting bases in the box. Choose one that you're more comfortable with using.
- **Ball Mount:** Magnetically attaches to the back of the camera.
- **Screw Mount:** Screws into the back of the camera's screw-hole.





# CAMERA INSTALLATION

## Ball Mount Installation

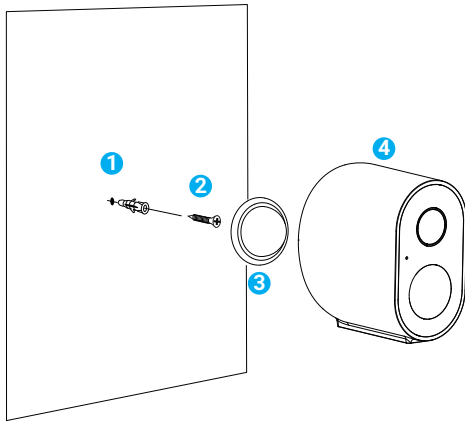

1. For hard surfaces like stone, brick, or stucco, drill a hole using a 9/64 inch (3.55mm) drill bit, then insert the wall anchor.  
*\* Note: if you have a softer surface like wood, you can skip this step.*
2. Drill the screw into the surface or wall anchor. Make sure you leave a bit of the screw exposed.
3. Hang the ball mount onto the exposed screw.
4. Attach the camera to the ball mount. Make sure to adjust the camera angle as necessary.





# CAMERA INSTALLATION

## Screw Mount Installation

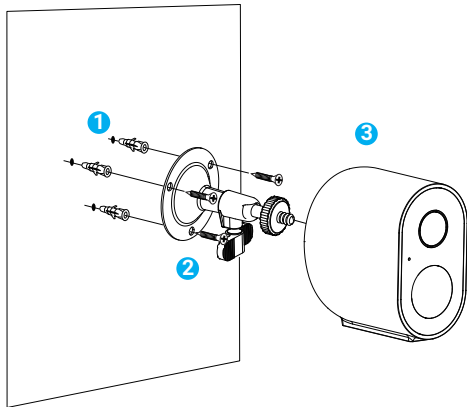

1. For hard surfaces like stone, brick, or stucco, drill holes using a 9/64 inch (3.55mm) drill bit, then insert the 3 wall anchors.

*\* Note: if you have a softer surface like wood, you can skip this step.*

2. Place the screw mount over the marked holes on the surface, then drill the screws through the holes of the screw mount and into the surface or wall anchors.
3. Screw the camera onto the screw mount and make sure it's securely locked by twisting the silver knob.





5

# FEATURES

Dashboard  
Key Features





# FEATURES

## Dashboard

Your dashboard is your app's home screen where you can view your devices, menu, settings, history, and more.

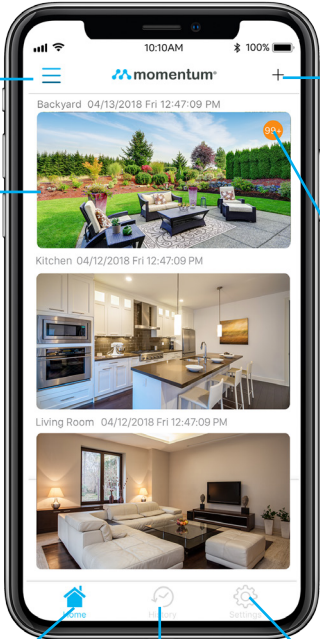

Menu

Add Device

Camera Preview

Add Counter

Home

History

Setting



# FEATURES

## Motion Zones

Create and customize up to 3 motion zones so you can focus on the most important areas of your home. When motion is detected, you'll get an alert instantly to your mobile device.

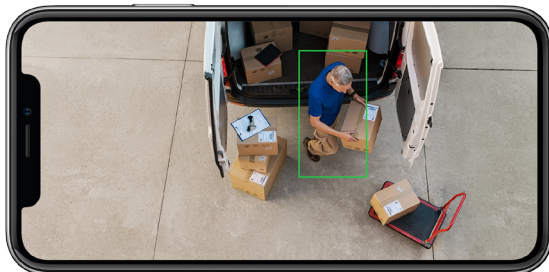

## Human Detection

Have the camera only alert you based on human-shaped objects to help avoid false alerts due to shadows, lighting, plants, and others.





# FEATURES

## Night Vision

The Teri camera will make sure you stay protected day and night. The built-in infrared LEDs turn on automatically in low light condition and allows you see up to 32 feet in the dark.



## Free Cloud Storage

Every camera comes with FREE 24-hr video history that can be played back from the app. You can even download the recordings directly to your mobile device for permanent safe-keeping.





# 6

# TROUBLESHOOTING

Indicator Light  
Common Issues  
FAQs



# TROUBLESHOOTING

## Indicator Light



LED Color	Description
Solid Red	Booting
Blinking Red	Offline
Blinking Red and Blue	Pairing Mode
Solid Green	Camera Synced
Solid Blue	Live stream/recording in Progress

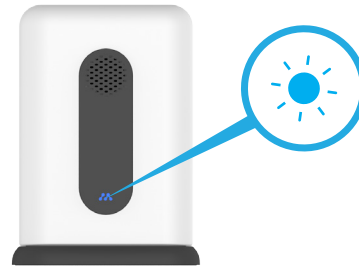

LED Color	Description
Solid Red	Booting
Blinking Red	Offline
Blinking Red and Blue	Pairing Mode
Solid Green	Synced with Camera
Solid Blue	Online



# TROUBLESHOOTING

## Common Issues

If your camera is having app or streaming connection issues, try these steps to correct the issue.

### **Force close the app**

If you're experiencing issues with the app, many times it can be resolved by restarting the app. Completely close the app on your mobile device then open the app again.

### **Power cycle the Hub**

Unplug the hub, wait 10 seconds, then plug it back in.

### **Reset the Smart Hub**

1. To reset the hub, hold the Reset button on the back of the hub for about 10 seconds. During the reset sequence, the LED indicator light on the front of the hub will first display solid red, then solid blue.
2. Once the hub is blinking red and blue, you will need to pair the camera again.





# TROUBLESHOOTING

## Frequently Asked Questions

### **Why can't I find this device on the pairing list?**

Make sure that you've downloaded the correct Momentum Secure app from the app store.

### **Do I need a microSD card to record videos?**

A microSD card is not necessary as every camera comes with free cloud storage that allows you to save recorded activity for 24 hours.

### **Why can't the Smart Hub read the microSD card?**

The hub can only support up to 128GB cards and must be in FAT32 format. You can also try formatting the SD card from the hub's General settings page.

### **Why does my camera keep disconnecting?**

The camera may have a poor signal with the hub. Try moving the hub closer to your camera or vice-versa and make sure the network is stable.

### **Why does the stream keep failing to load?**

There could be several reasons, but most commonly it may be due to poor internet connection from the mobile device you're using to stream the camera. Make sure you have a strong internet connection while attempting to stream.





# TROUBLESHOOTING

## **Why is the video stream so slow?**

This may be caused by a slow connection from the camera. You can also try improving the video speed by lowering the video resolution from the camera settings.

## **Why is the battery on the cameras running out so fast?**

It could be due to several reasons:

- Excessive streaming, especially in highest resolution.
- Excessive recordings.
- Exposure to cold environments.
- Continuously in night vision.
- Poor connection to the Smart Hub..

## **Do I need to connect the Smart Hub to my router with an ethernet cable?**

Although it is recommended to use an ethernet cable for direct internet connection, you can also wirelessly connect to your network with a WiFi connection. See the app's pairing flow option labeled "Connect with WiFi Instead". If you go with this option, make sure the hub stays as close to the router as possible to maintain a strong connection.







# TROUBLESHOOTING

## **Will the cameras survive outside, even in extreme hot/cold climates?**

The cameras are IP65 rated and can withstand constant temperatures between 14°F – 122°F. If you're in an area with extreme hot or cold weather, it's best to make sure the camera isn't directly exposed to the harsh environment.





For further assistance, please see our help page at <https://support.momentumcam.com>.

### **Disclaimers**

- Mobile device OS compatibility is subject to change as new versions are released. It is recommended to stay up-to-date with the latest OS versions to ensure the app will stay compatible.
- App screens and functions may change overtime as we continue to improve our software. Please refer to our website for the latest guides available.

### **FCC Compliance**

This device complies with part 15 of the FCC Rules.

Operation is subject to the following two conditions: (1) this device may not cause harmful interference, and (2) this device must accept any interference received, including interference that may cause undesired operation.

Note: This equipment has been tested and found to comply with the limits for a Class B digital device, pursuant to part 15 of the FCC Rules. These limits are designed to provide reasonable protection against harmful interference in a residential installation. This equipment generates, uses and can radiate radio frequency energy and, if not installed and used in accordance with the instructions, may cause harmful interference to radio communications. However, there is no guarantee that interference will not occur in a particular installation





If this equipment does cause harmful interference to radio or television reception, which can be determined by turning the equipment off and on, the user is encouraged to try to correct the interference by one or more of the following measures:

- Reorient or relocate the receiving antenna.
- Increase the separation between the equipment and receiver.
- Connect the equipment to an outlet on a circuit different from that to which the receiver is connected.
- Consult the dealer or an experienced radio/TV technician for help.

To ensure continued compliance, any changes or modifications not expressly approved by any party. Responsible for compliance could void the user's authority to operate the equipment. (Example - use only shielded interface cables when connecting to computer or peripheral devices.)

This equipment complies with Part 15 of FCC Rules. Operation is subject to the following 2 conditions:

1. This device may not cause harmful interference, and
2. This device must accept any interference received, including interference that may cause undesired operation.

FCC Radiation Exposure Statement:

The equipment complies with FCC Radiation exposure limits set forth for uncontrolled environment. This equipment should be installed and operated with minimum distances of 20cm between the radiator and your body.





## ONE YEAR LIMITED WARRANTY

The Company hereby warrants to the original retail purchaser of this product that should this product or any part thereof, under normal use and conditions, be proven defective in material or workmanship within one year parts and 90 days labor from the date of original purchase, such defect(s) will be repaired or replaced with reconditioned product (at the Company's option) for parts and repair labor. This limited Warranty is the purchaser's exclusive remedy for any such defect(s).

To obtain repairs or replacement within the terms of this warranty, please visit [www.momentumcam.com](http://www.momentumcam.com) or contact us at

1-888-818-0436,  
Open Mon-Fri 8am-5pm.

**Apollo Tech USA Inc.**

8608 Utica Ave #220

Rancho Cucamonga, CA 91730

Proof of warranty coverage (i.e. - dated bill of sale) is required.

This Warranty does not apply to any product or part thereof which, in the opinion of the Company, has suffered or been damaged through alteration, improper installation, mishandling, misuse, neglect, accident, or by removal or defacement of the factory bar code label(s). The opinion of the Company with respect to this matter shall be final. THE EXTENT OF THE COMPANY'S LIABILITY UNDER THIS WARRANTY IS LIMITED TO THE REPAIR OR REPLACEMENT PROVIDED ABOVE AND, IN NO EVENT, SHALL THE COMPANY'S LIABILITY EXCEED THE PURCHASE PRICE PAID BY PURCHASER FOR THE PRODUCT.





THIS WARRANTY IS IN LIEU OF ALL OTHER EXPRESS WARRANTIES OR LIABILITIES. ANY IMPLIED WARRANTIES, INCLUDING ANY IMPLIED WARRANTY OF MERCHANTABILITY, SHALL BE LIMITED TO THE DURATION OF THIS WRITTEN WARRANTY. ANY ACTION FOR BREACH OF ANY WARRANTY HEREUNDER, INCLUDING ANY IMPLIED WARRANTY OF MERCHANTABILITY, MUST BE BROUGHT WITHIN A PERIOD OF 30 MONTHS FROM THE DATE OF ORIGINAL PURCHASE. IN NO CASE SHALL THE COMPANY BE LIABLE FOR ANY CONSEQUENTIAL OR INCIDENTAL DAMAGES FOR BREACH OF THIS OR ANY OTHER WARRANTY EXPRESS OR IMPLIED WHATSOEVER.

No person or representative is authorized to assume for the Company any liability other than expressed herein in connection with the sale of this product. Some jurisdictions do not allow limitations on how long an implied warranty lasts or the exclusion or limitation of incidental or consequential damages so the above limitations or exclusions may not apply to you. This Warranty gives you specific legal rights and you may also have other rights, which vary from jurisdiction to jurisdiction. Please make sure to consult a doctor before starting a new diet or fitness program.



**Visit us:**

[www.momentumcam.com](http://www.momentumcam.com)

**Call us:**

1.888.818.0436

**Email us:**

[help@momentumcam.com](mailto:help@momentumcam.com)

**Momentum Secure app features:**

To help guide you through the features of the Momentum Secure app, please refer to the user manual linked in the app or visit: [support.momentumcam.com](http://support.momentumcam.com)

