

FCC TEST REPORT

FCC ID:2AMK8TT-930E-BT-BTT

Report Number..... : ZKT-220728L5271E

Date of Test..... July 21 to Aug. 11, 2022

Date of issue : Aug. 11, 2022

Total number of pages 38

Test Result : PASS

Testing Laboratory..... : Shenzhen ZKT Technology Co., Ltd.

Address : 1/F, No. 101, Building B, No. 6, Tangwei Community Industrial Avenue, Fuhai Street, Bao'an District, Shenzhen, China

Applicant's name : **DongGuan Honwell Electronic Industrial Co., Ltd.**

Address : No.4, Xiaolong Road,Yuanshanbei Village,Changping Town,Dongguan,China

Manufacturer's name : **DongGuan Honwell Electronic Industrial Co., Ltd.**

Address : No.4, Xiaolong Road,Yuanshanbei Village,Changping Town,Dongguan,China

Test specification:

Standard..... : FCC CFR Title 47 Part 15 Subpart C Section 15.249
ANSI C63.10:2013

Test procedure..... : /

Non-standard test method : N/A

Test Report Form No. : TRF-EL-111_V0**Test Report Form(s) Originator** : ZKT Testing**Master TRF** : Dated: 2022-08-11

This device described above has been tested by ZKT, and the test results show that the equipment under test (EUT) is in compliance with the FCC requirements. And it is applicable only to the tested sample identified in the report.

This report shall not be reproduced except in full, without the written approval of ZKT, this document may be altered or revised by ZKT, personal only, and shall be noted in the revision of the document.

Product name..... : Record player

Trademark : N/A

Model/Type reference : TT-930E-BT-BTT

Battery..... : N/A

Ratings..... : AC100-240V,50/60Hz

Testing procedure and testing location:

Testing Laboratory: Shenzhen ZKT Technology Co., Ltd.
Address.....: 1/F, No. 101, Building B, No. 6, Tangwei Community
Industrial Avenue, Fuhai Street, Bao'an District,
Shenzhen, China

Tested by (name + signature): Alen He



Reviewer (name + signature).....: Joe Liu



Approved (name + signature): Lake Xie



Table of Contents

Page

1.VERSION	5
2.1SUMMARY OF TEST RESULTS	6
2.1.1 TEST FACILITY	7
2.1.2 MEASUREMENT UNCERTAINTY	7
3. GENERAL INFORMATION	8
3.1 GENERAL DESCRIPTION OF EUT	8
3.2 DESCRIPTION OF TEST MODES	9
3.3 BLOCK DIGRAM SHOWING THE CONFIGURATION OF SYSTEM TESTED	9
3.4 DESCRIPTION OF SUPPORT UNITS(CONDUCTED MODE)	10
3.5 EQUIPMENTS LIST FOR ALL TEST ITEMS	11
4. EMC EMISSION TEST	12
4.1 CONDUCTED EMISSION MEASUREMENT	12
4.1.1 POWER LINE CONDUCTED EMISSION LIMITS	12
4.1.2 TEST PROCEDURE	12
4.1.3 DEVIATION FROM TEST STANDARD	12
4.1.4 1.3TEST SETUP	12
4.1.5 EUT OPERATING CONDITIONS	13
4.1.6 TEST RESULTS	14
4.2 RADIATED EMISSION MEASUREMENT	16
4.2.1 RADIATED EMISSION LIMITS	16
4.2.2 TEST PROCEDURE	17
4.2.3 1.4DEVIATION FROM TEST STANDARD	17
4.2.4 TEST SETUP	17
4.2.5 EUT OPERATING CONDITIONS	18
5. BANDWIDTH OF FREQUENCY BAND EDGE	29
5.1 TEST REQUIREMENT:	29
5.2 TEST PROCEDURE	29
5.3 DEVIATION FROM TEST STANDARD	29
5.4 TEST SETUP	29
5.5 EUT OPERATING CONDITIONS	30
5.6 TEST RESULT	31
6. CHANNEL BANDWIDTH	33
6.1 APPLIED PROCEDURES / LIMIT	33
6.2 TEST PROCEDURE	33
6.3 DEVIATION FROM STANDARD	33
6.4 TEST SETUP	33

Table of Contents

	Page
6.5 EUT OPERATION CONDITIONS	33
6.6 TSET RESULTS	34
8.ANTENNA REQUIREMENT	37
9. TEST SETUP PHOTO	38
10. EUT CONSTRUCTIONAL DETAILS	38

1.VERSION

Report No.	Version	Description	Approved
ZKT-220728L5271E	Rev.01	Initial issue of report	Aug. 11, 2022

2.1 SUMMARY OF TEST RESULTS

Test procedures according to the technical standards:

FCC Part15 (15.249) , Subpart C			
Standard Section	Test Item	Judgment	Remark
FCC part 15.203	Antenna requirement	PASS	
FCC part 15.207	AC Power Line Conducted Emission	PASS	
FCC part 15.249	Fundamental & Radiated Spurious Emission Measurement	PASS	
FCC part 15.215 (c)	20dB Channel Bandwidth	PASS	
FCC part 15.205	Band Edge	PASS	

NOTE:

(1) "N/A" denotes test is not applicable in this Test Report

2.1.1 TEST FACILITY

Shenzhen ZKT Technology Co., Ltd.

Add. : 1/F, No. 101, Building B, No. 6, Tangwei Community Industrial Avenue, Fuhai Street, Bao'an District, Shenzhen, China

FCC Test Firm Registration Number: 692225

Designation Number: CN1299

IC Registered No.: 27033

2.1.2 MEASUREMENT UNCERTAINTY

The reported uncertainty of measurement $y \pm U$ · where expanded uncertainty U is based on a standard uncertainty multiplied by a coverage factor of $k=2$ · providing a level of confidence of approximately 95 % ·

No.	Item	Uncertainty
1	Conducted Emission Test	$\pm 1.38\text{dB}$
2	RF power conducted	$\pm 0.16\text{dB}$
3	Spurious emissions conducted	$\pm 0.21\text{dB}$
4	All emissions radiated(<1G)	$\pm 4.68\text{dB}$
5	All emissions radiated(>1G)	$\pm 4.89\text{dB}$
6	Temperature	$\pm 0.5^\circ\text{C}$
7	Humidity	$\pm 2\%$

3. GENERAL INFORMATION

3.1 GENERAL DESCRIPTION OF EUT

Product Name:	Record player
Model No.:	TT-930E-BT-BTT
Model Different.:	N/A
Serial No.:	N/A
Hardware Version:	HV1.0
Software Version:	SV1.0
Sample(s) Status:	Engineer sample
Operation Frequency:	2402MHz~2480MHz
Channel Numbers:	79
Channel Separation:	1MHz
Modulation Type:	GFSK, $\pi/4$ -DQPSK, 8-DPSK
Antenna Type:	PCB Antenna
Antenna gain:	0dBi
Power supply:	AC 100-240V 50/60Hz
SWITCHING POWER ADAPTER:	N/A

Operation Frequency each of channel							
Channel	Frequency	Channel	Frequency	Channel	Frequency	Channel	Frequency
1	2402MHz	21	2422MHz	41	2442MHz	61	2462MHz
2	2403MHz	22	2423MHz	42	2443MHz	62	2463MHz
3	2404MHz	23	2424MHz	43	2444MHz	63	2464MHz
4	2405MHz	24	2425MHz	44	2445MHz	64	2465MHz
5	2406MHz	25	2426MHz	45	2446MHz	65	2466MHz
6	2407MHz	26	2427MHz	46	2447MHz	66	2467MHz
7	2408MHz	27	2428MHz	47	2448MHz	67	2468MHz
8	2409MHz	28	2429MHz	48	2449MHz	68	2469MHz
9	2410MHz	29	2430MHz	49	2450MHz	69	2470MHz
10	2411MHz	30	2431MHz	50	2451MHz	70	2471MHz
11	2412MHz	31	2432MHz	51	2452MHz	71	2472MHz
12	2413MHz	32	2433MHz	52	2453MHz	72	2473MHz
13	2414MHz	33	2434MHz	53	2454MHz	73	2474MHz
14	2415MHz	34	2435MHz	54	2455MHz	74	2475MHz
15	2416MHz	35	2436MHz	55	2456MHz	75	2476MHz

16	2417MHz	36	2437MHz	56	2457MHz	76	2477MHz
17	2418MHz	37	2438MHz	57	2458MHz	77	2478MHz
18	2419MHz	38	2439MHz	58	2459MHz	78	2479MHz
19	2420MHz	39	2440MHz	59	2460MHz	79	2480MHz
20	2421MHz	40	2441MHz	60	2461MHz		

Note:

In section 15.31(m), regards to the operating frequency range over 10 MHz, the Lowest frequency, the middle frequency, and the highest frequency of channel were selected to perform the test, and the selected channel see below:

Channel	Frequency
The lowest channel	2402MHz
The middle channel	2441MHz
The Highest channel	2480MHz

3.2 DESCRIPTION OF TEST MODES

Transmitting mode	Keep the EUT in continuously transmitting mode
Remark: During the test, the test voltage was tuned from 85% to 115% of the nominal rated supply voltage, and found that the worst case was under the nominal rated supply condition. So the report just shows that condition's data.	
Enter test mode for the product, keep EUT in continuously transmitting status with hoping on mode with different packages; find the worst case is GFSK mode.	

Test Software	BT Test Tool
Power level setup	<0dBm

3.3 BLOCK DIGRAM SHOWING THE CONFIGURATION OF SYSTEM TESTED

Conducted Emission

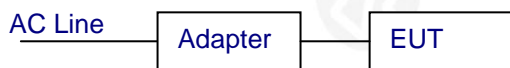

Radiated Emission



Conducted Spurious

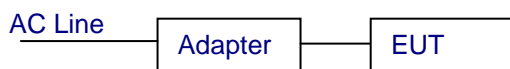

3.4 DESCRIPTION OF SUPPORT UNITS(CONDUCTED MODE)

The EUT has been tested as an independent unit together with other necessary accessories or support units. The following support units or accessories were used to form a representative test configuration during the tests.

Item	Equipment	Mfr/Brand	Model/Type No.	Series No.	Note
E-1	Record player	N/A	TT-930E-BT-BTT	N/A	EUT
E-2	Adapter	GJTL	QJ27WE-1400150U		

Item	Shielded Type	Ferrite Core	Length	Note
C-1	NO	NO	0.8M	DC Line

Note:

- (1) The support equipment was authorized by Declaration of Confirmation.
- (2) For detachable type I/O cable should be specified the length in cm in 『Length』 column.

3.5 EQUIPMENTS LIST FOR ALL TEST ITEMS
Radiation Test equipment

Item	Equipment	Manufacturer	Type No.	Serial No.	Last calibration	Calibrated until
1	Spectrum Analyzer (9kHz-26.5GHz)	KEYSIGHT	9020A	MY45109572	Sep. 22, 2021	Sep. 21, 2022
2	Spectrum Analyzer (1GHz-40GHz)	Agilent	E4446A	100363	Sep. 22, 2021	Sep. 21, 2022
3	Test Receiver (9kHz-7GHz)	R&S	ESC17	101169	Sep. 22, 2021	Sep. 21, 2022
4	Bilog Antenna (30MHz-1400MHz)	Schwarzbeck	VULB9168	00877	Sep. 22, 2021	Sep. 21, 2022
5	Horn Antenna (1GHz-18GHz)	SCHWARZBEC K	BBHA9120D	1541	Sep. 22, 2021	Sep. 21, 2022
6	Horn Antenna (18GHz-40GHz)	A.H. System	SAS-574	588	Sep. 22, 2021	Sep. 21, 2022
7	Amplifier (30-1000MHz)	EM Electronics	EM330 Amplifier	N/A	Sep. 22, 2021	Sep. 21, 2022
8	Amplifier (1GHz-40GHz)	全聚达	DLE-161	097	Sep. 22, 2021	Sep. 21, 2022
9	Loop Antenna (9KHz-30MHz)	SCHWARZBEC K	FMZB1519B	014	Sep. 22, 2021	Sep. 21, 2022
10	RF cables1 (9kHz-30MHz)	N/A	9kHz-30MHz	N/A	Sep. 22, 2021	Sep. 21, 2022
11	RF cables2 (30MHz-1GHz)	N/A	30MHz-1GHz	N/A	Sep. 22, 2021	Sep. 21, 2022
12	RF cables3 (1GHz-40GHz)	N/A	1GHz-40GHz	N/A	Sep. 22, 2021	Sep. 21, 2022
13	CMW500 Test	R&S	CMW500	106504	Sep. 22, 2021	Sep. 21, 2022
14	ESG Signal Generator	Agilent	E4421B	GB40051203	Sep. 22, 2021	Sep. 21, 2022
15	Signal Generator	Agilent	N5182A	MY47420215	Sep. 22, 2021	Sep. 21, 2022
16	D.C. Power Supply	LongWei	TPR-6405D	\	\	\
17	Software	Frad	EZ-EMC	FA-03A2 RE	\	\

Conduction Test equipment

Item	Kind of Equipment	Manufacturer	Type No.	Serial No.	Last calibration	Calibrated until
1	LISN	R&S	ENV216	101471	Sep. 22, 2021	Sep. 21, 2022
2	LISN	CYBERTEK	EM5040A	E185040014 9	Sep. 22, 2021	Sep. 21, 2022
3	Test Cable	N/A	C01	N/A	Sep. 22, 2021	Sep. 21, 2022
4	Test Cable	N/A	C02	N/A	Sep. 22, 2021	Sep. 21, 2022
5	EMI Test Receiver	R&S	ESRP3	101946	Sep. 22, 2021	Sep. 21, 2022
6	Absorbing Clamp	DZ	ZN23201	N/A	Sep. 22, 2021	Sep. 21, 2022

4. EMC EMISSION TEST

4.1 CONDUCTED EMISSION MEASUREMENT

Test Requirement:	FCC Part15 C Section 15.207
Test Method:	ANSI C63.10:2013
Test Frequency Range:	150KHz to 30MHz
Receiver setup:	RBW=9KHz, VBW=30KHz, Sweep time=auto

4.1.1 POWER LINE CONDUCTED EMISSION Limits

FREQUENCY (MHz)	Limit (dBuV)		Standard
	Quas -peak	Average	
0.15 -0.5	66 - 56 *	56 - 46 *	FCC
0.50 -5.0	56.00	46.00	FCC
5.0 -30.0	60.00	50.00	FCC

Note:

(1) *Decreases with the logarithm of the frequency.

4.1.2 TEST PROCEDURE

- The EUT was placed 0.8 meters from the horizontal ground plane with EUT being connected to the power mains through a line impedance stabilization network (LISN). All other support equipments powered from additional LISN(s). The LISN provide 50 Ohm/ 50uH of coupling impedance for the measuring instrument.
- Interconnecting cables that hang closer than 40 cm to the ground plane shall be folded back and forth in the center forming a bundle 30 to 40 cm long.
- I/O cables that are not connected to a peripheral shall be bundled in the center. The end of the cable may be terminated, if required, using the correct terminating impedance. The overall length shall not exceed 1 m.
- LISN at least 80 cm from nearest part of EUT chassis.
- For the actual test configuration, please refer to the related Item –EUT Test Photos.

4.1.3 DEVIATION FROM TEST STANDARD

No deviation

4.1.4 TEST SETUP

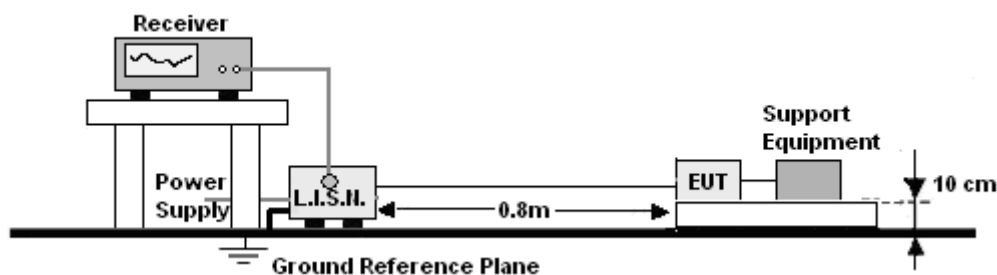

4.1.5 EUT OPERATING CONDITIONS

The EUT was configured for testing in a typical fashion (as a customer would normally use it). The EUT has been programmed to continuously transmit during test. This operating condition was tested and used to collect the included data.

We pretest AC 120V and AC 230V, the worst voltage was AC 120V and the data recording in the report.

4.1.6 TEST RESULTS

Temperature :	26°C	Relative Humidity:	54%
Pressure :	101kPa	Phase :	L
Test Voltage :	AC 120V/60Hz		

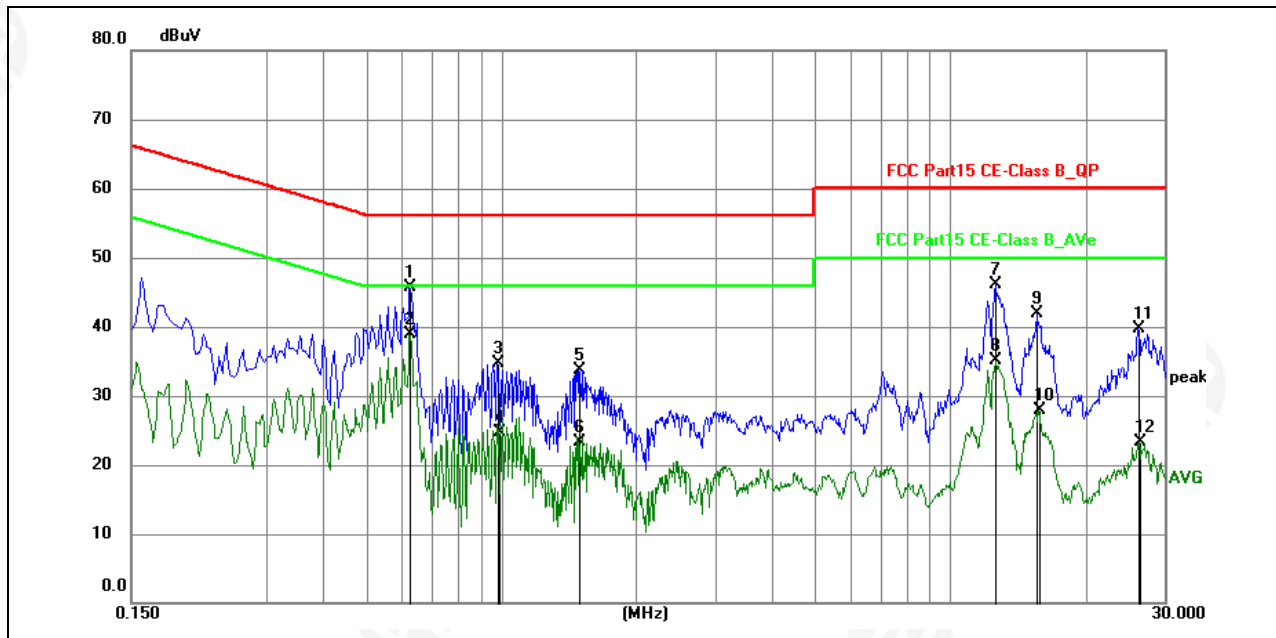

No.	Frequency (MHz)	Reading (dBuV)	Factor (dB)	Level (dBuV)	Limit (dBuV)	Margin (dB)	Detector	P/F
1	0.6269	35.20	10.51	45.71	56.00	-10.29	QP	P
2	0.6269	28.34	10.51	38.85	46.00	-7.15	AVG	P
3	0.9824	24.17	10.44	34.61	56.00	-21.39	QP	P
4	0.9869	14.18	10.44	24.62	46.00	-21.38	AVG	P
5	1.4909	23.43	10.32	33.75	56.00	-22.25	QP	P
6	1.4909	12.91	10.32	23.23	46.00	-22.77	AVG	P
7	12.6195	37.23	8.83	46.06	60.00	-13.94	QP	P
8	12.6195	26.36	8.83	35.19	50.00	-14.81	AVG	P
9	15.6300	32.71	9.25	41.96	60.00	-18.04	QP	P
10	15.7380	18.65	9.26	27.91	50.00	-22.09	AVG	P
11	26.2725	29.83	9.92	39.75	60.00	-20.25	QP	P
12	26.3400	13.30	9.92	23.22	50.00	-26.78	AVG	P

Notes:

- 1.An initial pre-scan was performed on the line and neutral lines with peak detector.
- 2.Quasi-Peak and Average measurement were performed at the frequencies with maximized peak emission.
- 3.Measurement Level = Reading level + Correct Factor

Temperature :	26°C	Relative Humidity:	54%
Pressure :	101kPa	Phase :	N
Test Voltage :	AC 120V/60Hz		

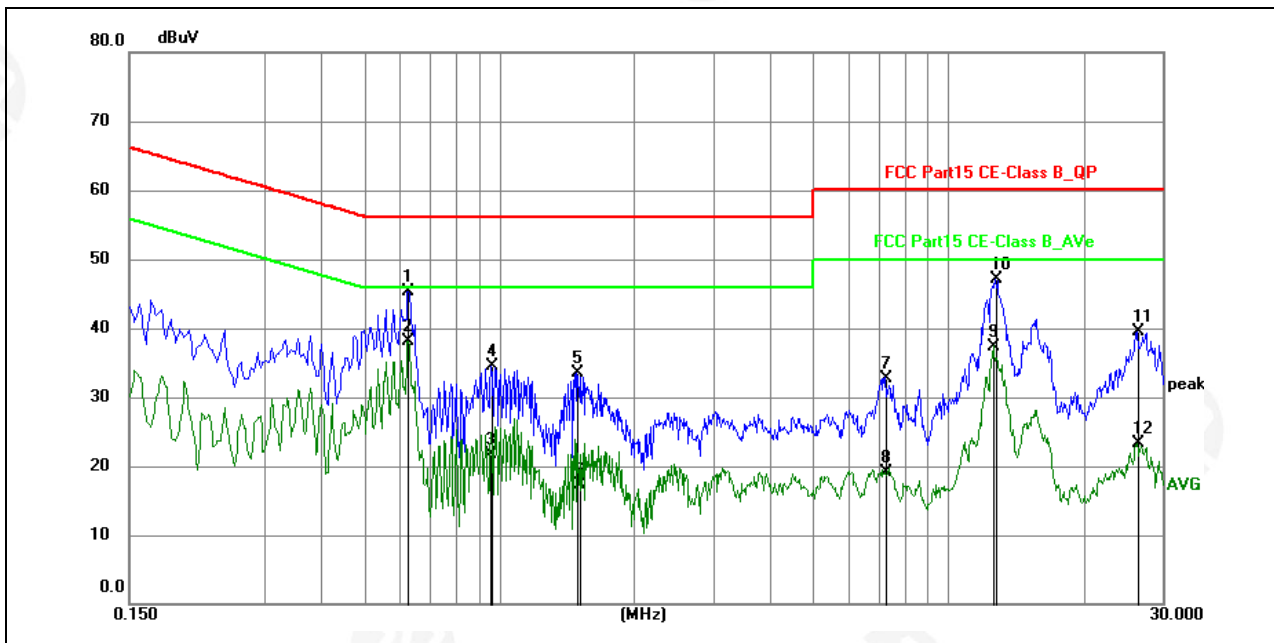

No.	Frequency (MHz)	Reading (dBuV)	Factor (dB)	Level (dBuV)	Limit (dBuV)	Margin (dB)	Detector	P/F
1	0.6269	34.87	10.51	45.38	56.00	-10.62	QP	P
2	0.6269	27.55	10.51	38.06	46.00	-7.94	AVG	P
3	0.9554	11.19	10.45	21.64	46.00	-24.36	AVG	P
4	0.9600	24.06	10.45	34.51	56.00	-21.49	QP	P
5	1.4909	23.13	10.32	33.45	56.00	-22.55	QP	P
6	1.5089	6.93	10.31	17.24	46.00	-28.76	AVG	P
7	7.2195	24.24	8.56	32.80	60.00	-27.20	QP	P
8	7.2195	10.54	8.56	19.10	50.00	-30.90	AVG	P
9	12.6059	28.58	8.82	37.40	50.00	-12.60	AVG	P
10	12.7500	38.32	8.84	47.16	60.00	-12.84	QP	P
11	26.2905	29.65	9.92	39.57	60.00	-20.43	QP	P
12	26.2905	13.38	9.92	23.30	50.00	-26.70	AVG	P

Notes:

- 1.An initial pre-scan was performed on the line and neutral lines with peak detector.
- 2.Quasi-Peak and Average measurement were performed at the frequencies with maximized peak emission.
- 3.Measurement Level = Reading level + Correct Factor

4.2 RADIATED EMISSION MEASUREMENT

Test Requirement:	FCC Part15 C Section 15.209				
Test Method:	ANSI C63.10:2013				
Test Frequency Range:	9kHz to 25GHz				
Test site:	Measurement Distance: 3m				
Receiver setup:	Frequency	Detector	RBW	VBW	Value
	9KHz-150KHz	Quasi-peak	200Hz	600Hz	Quasi-peak
	150KHz-30MHz	Quasi-peak	9KHz	30KHz	Quasi-peak
	30MHz-1GHz	Quasi-peak	100KHz	300KHz	Quasi-peak
	Above 1GHz	Peak	1MHz	3MHz	Peak
Peak		1MHz	10Hz	Average	

4.2.1 RADIATED EMISSION LIMITS

Frequencies (MHz)	Field Strength (micorvolts/meter)	Measurement Distance (meters)
0.009~0.490	2400/F(KHz)	300
0.490~1.705	24000/F(KHz)	30
1.705~30.0	30	30
30~88	100	3
88~216	150	3
216~960	200	3
Above 960	500	3

The field strength of emissions from intentional radiators operated within these frequency bands shall comply with the following:

Fundamental frequency	Field strength of fundamental (millivolts/meter)	Field strength of harmonics (microvolts/meter)
902-928 MHz	50	500
2400-2483.5 MHz	50	500
5725-5875 MHz	50	500
24.0-24.25 GHz	250	2500

LIMITS OF RADIATED EMISSION MEASUREMENT

FREQUENCY (MHz)	Limit (dBuV/m) (at 3M)	
	PEAK	AVERAGE
Above 1000	74	54

Notes:

- (1) The limit for radiated test was performed according to FCC PART 15C.

- (2) The tighter limit applies at the band edges.
- (3) Emission level (dBuV/m)=20log Emission level (uV/m).

4.2.2 TEST PROCEDURE

- a. The measuring distance of at 3 m shall be used for measurements at frequency up to 25GHz. For frequencies above 1GHz, any suitable measuring distance may be used.
- b. The EUT was placed on the top of a rotating table 0.8 meters above the ground at a 3 meter semi-chamber test. The table was rotated 360 degrees to determine the position of the highest radiation.
- c. The height of the equipment or of the substitution antenna shall be 0.8m; above 1GHz, the height was 1.5m, the height of the test antenna shall vary between 1 m to 4 m. Both horizontal and vertical polarizations of the antenna are set to make the measurement.
- d. The initial step in collecting conducted emission data is a spectrum analyzer peak detector mode pre-scanning the measurement frequency range. Significant peaks are then marked and then Quasi Peak detector mode re-measured.
- e. If the Peak Mode measured value compliance with and lower than Quasi Peak Mode Limit, the EUT shall be deemed to meet QP Limits and then no additional QP Mode measurement performed.
- f. For the actual test configuration, please refer to the related Item –EUT Test Photos.
- g. For the radiated emission test above 1GHz:
Place the measurement antenna away from each area of the EUT determined to be a source of emissions at the specified measurement distance, while keeping the measurement antenna aimed at the source of emissions at each frequency of significant emissions, with polarization oriented for maximum response.
The measurement antenna may have to be higher or lower than the EUT, depending on the radiation pattern of the emission and staying aimed at the emission source for receiving the maximum signal. The final measurement antenna elevation shall be that which maximizes the emissions. The measurement antenna elevation for maximum emissions shall be restricted to a range of heights of from 1 m to 4 m above the ground or reference ground plane.

Note:

Both horizontal and vertical antenna polarities were tested and performed pretest to three orthogonal axis. The worst case emissions were reported

4.2.3 DEVIATION FROM TEST STANDARD

No deviation

4.2.4 TEST SETUP

(A) Radiated Emission Test-Up Frequency Below 30MHz

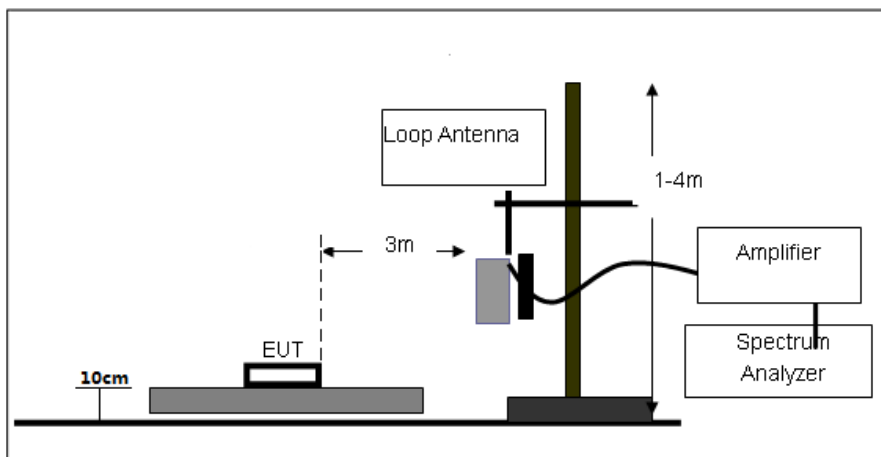

(B) Radiated Emission Test-Up Frequency 30MHz~1GHz

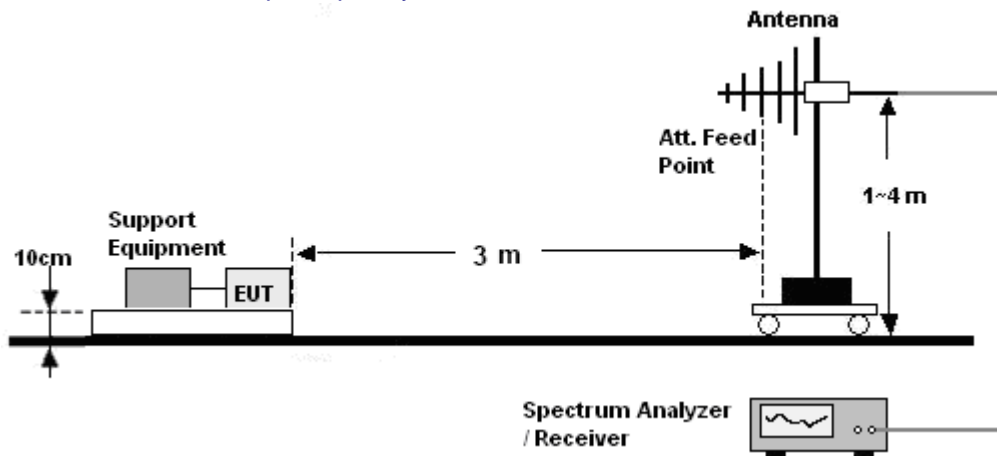

(C) Radiated Emission Test-Up Frequency Above 1GHz

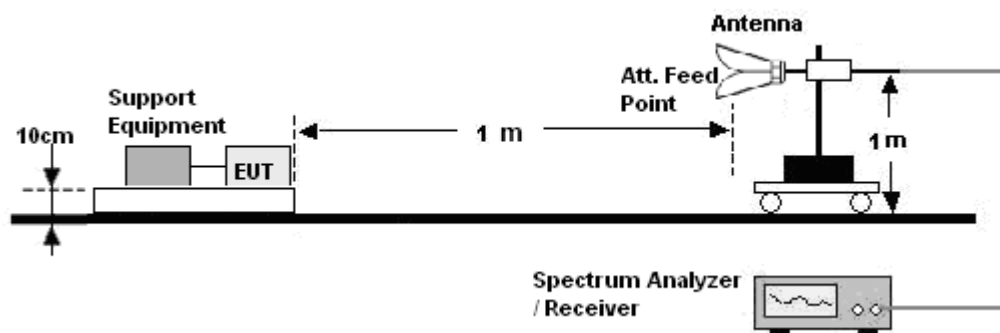

4.2.5 EUT OPERATING CONDITIONS

The EUT tested system was configured as the statements of 2.4 Unless otherwise a special operating condition is specified in the follows during the testing.

4.2.6 TEST RESULTS (Between 9KHz – 30 MHz)

The emission from 9 kHz to 30MHz was pre-tested and found the result was 20dB lower than the limit, and according to 15.31(o) & RSS-Gen 6.13, the test result no need to reported.

Between 30MHz – 1GHz

Temperature:	26°C	Relative Humidity:	54%
Pressure:	101 kPa	Polarization:	Horizontal
Test Voltage:	AC 120V/60Hz		

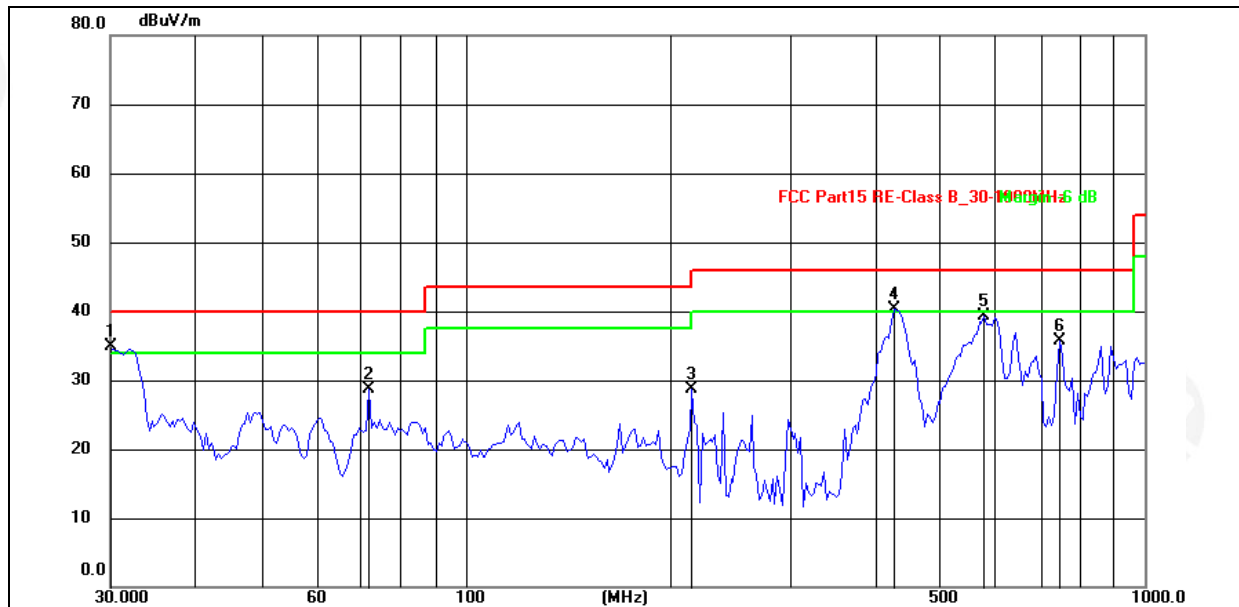

No.	Frequency (MHz)	Reading (dBuV)	Factor (dB/m)	Level (dBuV/m)	Limit (dBuV/m)	Margin (dB)	Detector
1	30.0000	53.33	-18.44	34.89	40.00	-5.11	QP
2	72.0841	48.64	-19.87	28.77	40.00	-11.23	QP
3	215.6451	49.20	-20.45	28.75	43.50	-14.75	QP
4	427.2694	54.36	-14.09	40.27	46.00	-5.73	QP
5	580.7024	47.78	-8.51	39.27	46.00	-6.73	QP
6	748.7942	41.33	-5.65	35.68	46.00	-10.32	QP

Temperature:	26°C	Relative Humidity:	54%
Pressure:	101kPa	Polarization:	Vertical
Test Voltage:	AC 120V/60Hz		

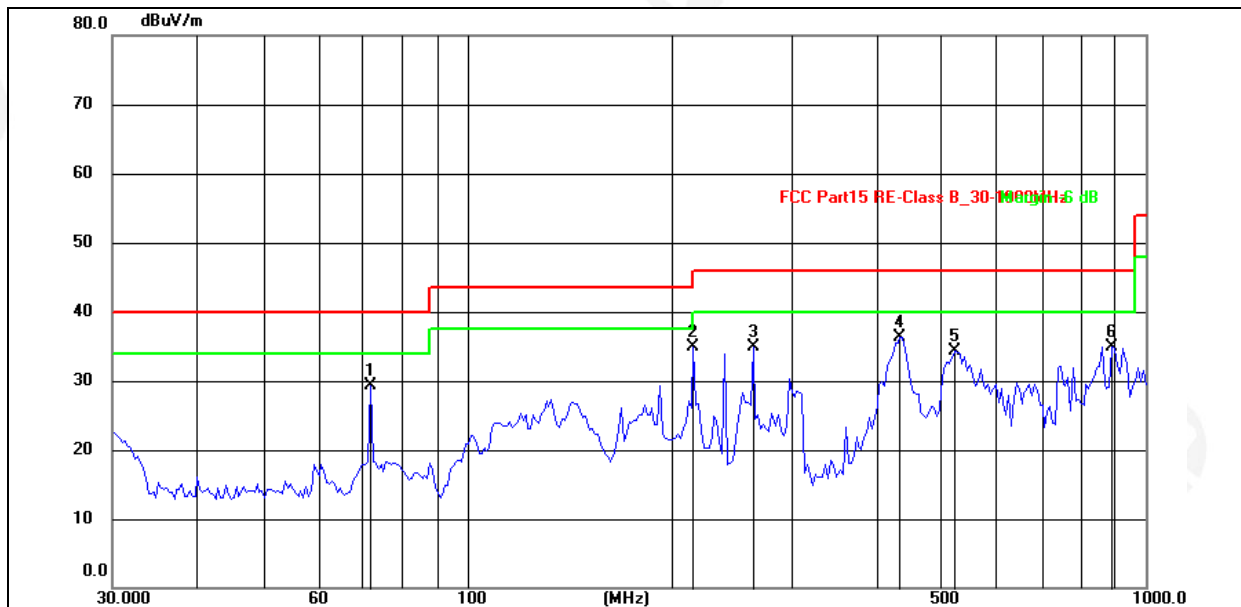

No.	Frequency (MHz)	Reading (dBuV)	Factor (dB/m)	Level (dBuV/m)	Limit (dBuV/m)	Margin (dB)	Detector
1	72.0841	46.68	-17.43	29.25	40.00	-10.75	QP
2	215.6452	52.85	-18.00	34.85	43.50	-8.65	QP
3	263.8190	50.27	-15.33	34.94	46.00	-11.06	QP
4	434.8267	51.23	-14.85	36.38	46.00	-9.62	QP
5	522.7178	45.38	-10.99	34.39	46.00	-11.61	QP
6	892.2907	41.93	-6.99	34.94	46.00	-11.06	QP

Remarks:

- 1.Final Level =Receiver Read level + Antenna Factor + Cable Loss – Preamplifier Factor
- 2.The emission levels of other frequencies are very lower than the limit and not show in test report.

Field Strength of The Fundamental Signal
GFSK
Peak value:

Frequency (MHz)	Read Level (dBuV)	Antenna Factor (dB/m)	Cable Loss (dB)	Preamp Factor (dB)	Level (dBuV/m)	Limit Line (dBuV/m)	Over Limit (dB)	polarization
2402.00	93.36	27.26	5.39	30.18	95.83	114.00	-18.17	Vertical
2402.00	92.69	27.26	5.39	30.18	95.16	114.00	-18.84	Horizontal
2441.00	91.48	27.33	5.43	30.06	94.18	114.00	-19.82	Vertical
2441.00	85.60	27.33	5.43	30.06	88.30	114.00	-25.70	Horizontal
2480.00	92.61	27.40	5.47	29.93	95.55	114.00	-18.45	Vertical
2480.00	89.43	27.40	5.47	29.93	92.37	114.00	-21.63	Horizontal

Average value:

Frequency (MHz)	Read Level (dBuV)	Antenna Factor (dB/m)	Cable Loss (dB)	Preamp Factor (dB)	Level (dBuV/m)	Limit Line (dBuV/m)	Over Limit (dB)	polarization
2402.00	80.69	27.26	5.39	30.18	83.16	94.00	-10.84	Vertical
2402.00	78.92	27.26	5.39	30.18	81.39	94.00	-12.61	Horizontal
2441.00	77.78	27.33	5.43	30.06	80.48	94.00	-13.52	Vertical
2441.00	73.92	27.33	5.43	30.06	76.62	94.00	-17.38	Horizontal
2480.00	81.35	27.40	5.47	29.93	84.29	94.00	-9.71	Vertical
2480.00	78.24	27.40	5.47	29.93	81.18	94.00	-12.82	Horizontal

 $\pi/4$ -DQPSK
Peak value:

Frequency (MHz)	Read Level (dBuV)	Antenna Factor (dB/m)	Cable Loss (dB)	Preamp Factor (dB)	Level (dBuV/m)	Limit Line (dBuV/m)	Over Limit (dB)	polarization
2402.00	93.19	27.26	5.39	30.18	95.66	114.00	-18.34	Vertical
2402.00	92.11	27.26	5.39	30.18	94.58	114.00	-19.42	Horizontal
2441.00	91.27	27.33	5.43	30.06	93.97	114.00	-20.03	Vertical
2441.00	85.92	27.33	5.43	30.06	88.62	114.00	-25.38	Horizontal
2480.00	92.58	27.40	5.47	29.93	95.52	114.00	-18.48	Vertical
2480.00	89.31	27.40	5.47	29.93	92.25	114.00	-21.75	Horizontal

Average value:

Frequency (MHz)	Read Level (dBuV)	Antenna Factor (dB/m)	Cable Loss (dB)	Preamp Factor (dB)	Level (dBuV/m)	Limit Line (dBuV/m)	Over Limit (dB)	polarization
2402.00	81.20	27.26	5.39	30.18	83.67	94.00	-10.33	Vertical
2402.00	79.17	27.26	5.39	30.18	81.64	94.00	-12.36	Horizontal
2441.00	77.55	27.33	5.43	30.06	80.25	94.00	-13.75	Vertical
2441.00	74.07	27.33	5.43	30.06	76.77	94.00	-17.23	Horizontal
2480.00	82.12	27.40	5.47	29.93	85.06	94.00	-8.94	Vertical
2480.00	78.26	27.40	5.47	29.93	81.20	94.00	-12.80	Horizontal

8-DPSK

Peak value:

Frequency (MHz)	Read Level (dBuV)	Antenna Factor (dB/m)	Cable Loss (dB)	Preamp Factor (dB)	Level (dBuV/m)	Limit Line (dBuV/m)	Over Limit (dB)	polarization
2402.00	92.87	27.26	5.39	30.18	95.34	114.00	-18.66	Vertical
2402.00	91.66	27.26	5.39	30.18	94.13	114.00	-19.87	Horizontal
2441.00	90.89	27.33	5.43	30.06	93.59	114.00	-20.41	Vertical
2441.00	85.85	27.33	5.43	30.06	88.55	114.00	-25.45	Horizontal
2480.00	93.15	27.40	5.47	29.93	96.09	114.00	-17.91	Vertical
2480.00	89.37	27.40	5.47	29.93	92.31	114.00	-21.69	Horizontal

Average value:

Frequency (MHz)	Read Level (dBuV)	Antenna Factor (dB/m)	Cable Loss (dB)	Preamp Factor (dB)	Level (dBuV/m)	Limit Line (dBuV/m)	Over Limit (dB)	polarization
2402.00	81.25	27.26	5.39	30.18	83.72	94.00	-10.28	Vertical
2402.00	78.86	27.26	5.39	30.18	81.33	94.00	-12.67	Horizontal
2441.00	77.94	27.33	5.43	30.06	80.64	94.00	-13.36	Vertical
2441.00	74.56	27.33	5.43	30.06	77.26	94.00	-16.74	Horizontal
2480.00	82.33	27.40	5.47	29.93	85.27	94.00	-8.73	Vertical
2480.00	78.62	27.40	5.47	29.93	81.56	94.00	-12.44	Horizontal

GFSK

Polar (H/V)	Frequency	Meter Reading	Pre-ampli fier	Cable Loss	Antenna Factor	Emission Level	Limits	Margin	Detector Type
	(MHz)	(dBuV)	(dB)	(dB)	(dB)	(dBuV/m)	(dBuV/m)	(dB)	
Low Channel:2402MHz									
V	4804.00	52.43	30.55	5.77	31.12	58.77	74.00	-15.23	Pk
V	4804.00	32.29	30.55	5.77	31.12	38.63	54.00	-15.37	AV
V	7206.00	50.52	30.33	6.32	36.04	62.55	74.00	-11.45	Pk
V	7206.00	33.00	30.33	6.32	36.04	45.03	54.00	-8.97	AV
V	9608.00	51.02	30.85	7.45	37.58	65.20	74.00	-8.80	Pk
V	9608.00	32.90	30.85	7.45	37.58	47.08	54.00	-6.92	AV
V	12010.00	51.12	31.02	8.99	39.10	68.19	74.00	-5.81	Pk
V	12010.00	32.90	31.02	8.99	39.10	49.97	54.00	-4.03	AV
H	4804.00	52.77	30.55	5.77	31.12	59.11	74.00	-14.89	Pk
H	4804.00	32.62	30.55	5.77	31.12	38.96	54.00	-15.04	AV
H	7206.00	51.41	30.33	6.32	36.04	63.44	74.00	-10.56	Pk
H	7206.00	32.57	30.33	6.32	36.04	44.60	54.00	-9.40	AV
H	9608.00	51.41	30.85	7.45	37.58	65.59	74.00	-8.41	Pk
H	9608.00	32.27	30.85	7.45	37.58	46.45	54.00	-7.55	AV
H	12010.00	50.81	31.02	8.99	39.10	67.88	74.00	-6.12	Pk
H	12010.00	31.67	31.02	8.99	39.10	48.74	54.00	-5.26	AV

Polar (H/V)	Frequency	Meter Reading	Pre-ampli fier	Cable Loss	Antenna Factor	Emission Level	Limits	Margin	Detector Type
	(MHz)	(dBuV)	(dB)	(dB)	(dB)	(dBuV/m)	(dBuV/m)	(dB)	
Middle Channel:2441MHz									
V	4882.00	51.23	30.55	5.77	31.46	57.91	74.00	-16.09	Pk
V	4882.00	32.12	30.55	5.77	31.46	38.80	54.00	-15.20	AV
V	7323.00	49.76	30.33	6.32	36.15	61.90	74.00	-12.10	Pk
V	7323.00	31.90	30.33	6.32	36.15	44.04	54.00	-9.96	AV
V	9764.00	49.83	30.85	7.45	37.76	64.19	74.00	-9.81	Pk
V	9764.00	31.80	30.85	7.45	37.76	46.16	54.00	-7.84	AV
V	12205.00	49.73	31.02	8.99	39.10	66.80	74.00	-7.20	Pk
V	12205.00	31.80	31.02	8.99	39.10	48.87	54.00	-5.13	AV
H	4882.00	52.59	30.55	5.77	31.46	59.27	74.00	-14.73	Pk
H	4882.00	32.15	30.55	5.77	31.46	38.83	54.00	-15.17	AV
H	7323.00	53.30	30.33	6.32	36.15	65.44	74.00	-8.56	Pk
H	7323.00	31.93	30.33	6.32	36.15	44.07	54.00	-9.93	AV
H	9764.00	53.20	30.85	7.45	37.76	67.56	74.00	-6.44	Pk
H	9764.00	31.93	30.85	7.45	37.76	46.29	54.00	-7.71	AV
H	12205.00	49.80	31.02	8.99	39.10	66.87	74.00	-7.13	Pk
H	12205.00	31.13	31.02	8.99	39.10	48.20	54.00	-5.80	AV

Polar (H/V)	Frequency	Meter Reading	Pre-amplifier	Cable Loss	Antenna Factor	Emission Level	Limits	Margin	Detector Type
	(MHz)	(dBuV)	(dB)	(dB)	(dB)	(dBuV/m)	(dBuV/m)	(dB)	
High Channel:2480MHz									
V	4960.00	51.08	30.55	5.77	31.79	58.09	74.00	-15.91	Pk
V	4960.00	32.62	30.55	5.77	31.79	39.63	54.00	-14.37	AV
V	7440.00	53.59	30.33	6.32	36.38	65.96	74.00	-8.04	Pk
V	7440.00	32.94	30.33	6.32	36.38	45.31	54.00	-8.69	AV
V	9920.00	53.59	30.85	7.45	36.50	66.69	74.00	-7.31	Pk
V	9920.00	33.43	30.85	7.45	36.50	46.53	54.00	-7.47	AV
V	12400.00	53.59	31.02	8.99	39.11	70.67	74.00	-3.33	Pk
V	12400.00	32.83	31.02	8.99	39.11	49.91	54.00	-4.09	AV
H	4960.00	51.17	30.55	5.77	31.79	58.18	74.00	-15.82	Pk
H	4960.00	32.84	30.55	5.77	31.79	39.85	54.00	-14.15	AV
H	7440.00	52.76	30.33	6.32	36.38	65.13	74.00	-8.87	Pk
H	7440.00	33.10	30.33	6.32	36.38	45.47	54.00	-8.53	AV
H	9920.00	53.33	30.85	7.45	36.50	66.43	74.00	-7.57	Pk
H	9920.00	33.20	30.85	7.45	36.50	46.30	54.00	-7.70	AV
H	12400.00	53.26	31.02	8.99	39.11	70.34	74.00	-3.66	Pk
H	12400.00	33.20	31.02	8.99	39.11	50.28	54.00	-3.72	AV

Remark:

1. Emission Level = Meter Reading + Antenna Factor + Cable Loss – Pre-amplifier,
Margin= Emission Level - Limit
2. If peak below the average limit, the average emission was no test.
3. The amplitude of spurious emissions which are attenuated by more than 20dB below the permissible value has no need to be reported.

π/4-DQPSK

Polar (H/V)	Frequency	Meter Reading	Pre-amplifier	Cable Loss	Antenna Factor	Emission Level	Limits	Margin	Detector Type
	(MHz)	(dBuV)	(dB)	(dB)	(dB)	(dBuV/m)	(dBuV/m)	(dB)	
Low Channel:2402MHz									
V	4804.00	50.81	30.55	5.77	31.12	57.15	74.00	-16.85	Pk
V	4804.00	30.57	30.55	5.77	31.12	36.91	54.00	-17.09	AV
V	7206.00	48.60	30.33	6.32	36.04	60.63	74.00	-13.37	Pk
V	7206.00	31.52	30.33	6.32	36.04	43.55	54.00	-10.45	AV
V	9608.00	48.60	30.85	7.45	37.58	62.78	74.00	-11.22	Pk
V	9608.00	31.08	30.85	7.45	37.58	45.26	54.00	-8.74	AV
V	12010.00	48.70	31.02	8.99	39.10	65.77	74.00	-8.23	Pk
V	12010.00	30.98	31.02	8.99	39.10	48.05	54.00	-5.95	AV
H	4804.00	51.15	30.55	5.77	31.12	57.49	74.00	-16.51	Pk
H	4804.00	31.00	30.55	5.77	31.12	37.34	54.00	-16.66	AV
H	7206.00	49.90	30.33	6.32	36.04	61.93	74.00	-12.07	Pk
H	7206.00	31.21	30.33	6.32	36.04	43.24	54.00	-10.76	AV
H	9608.00	49.92	30.85	7.45	37.58	64.10	74.00	-9.90	Pk
H	9608.00	31.23	30.85	7.45	37.58	45.41	54.00	-8.59	AV
H	12010.00	49.95	31.02	8.99	39.10	67.02	74.00	-6.98	Pk
H	12010.00	30.24	31.02	8.99	39.10	47.31	54.00	-6.69	AV

Polar (H/V)	Frequency	Meter Reading	Pre-amplifier	Cable Loss	Antenna Factor	Emission Level	Limits	Margin	Detector Type
	(MHz)	(dBuV)	(dB)	(dB)	(dB)	(dBuV/m)	(dBuV/m)	(dB)	
Middle Channel:2441MHz									
V	4882.00	50.18	30.55	5.77	31.46	56.86	74.00	-17.14	Pk
V	4882.00	31.07	30.55	5.77	31.46	37.75	54.00	-16.25	AV
V	7323.00	48.88	30.33	6.32	36.15	61.02	74.00	-12.98	Pk
V	7323.00	30.90	30.33	6.32	36.15	43.04	54.00	-10.96	AV
V	9764.00	48.96	30.85	7.45	37.76	63.32	74.00	-10.68	Pk
V	9764.00	30.92	30.85	7.45	37.76	45.28	54.00	-8.72	AV
V	12205.00	48.94	31.02	8.99	39.10	66.01	74.00	-7.99	Pk
V	12205.00	30.93	31.02	8.99	39.10	48.00	54.00	-6.00	AV
H	4882.00	51.44	30.55	5.77	31.46	58.12	74.00	-15.88	Pk
H	4882.00	31.20	30.55	5.77	31.46	37.88	54.00	-16.12	AV
H	7323.00	52.15	30.33	6.32	36.15	64.29	74.00	-9.71	Pk
H	7323.00	31.00	30.33	6.32	36.15	43.14	54.00	-10.86	AV
H	9764.00	52.35	30.85	7.45	37.76	66.71	74.00	-7.29	Pk
H	9764.00	31.05	30.85	7.45	37.76	45.41	54.00	-8.59	AV
H	12205.00	52.90	31.02	8.99	39.10	69.97	74.00	-4.03	Pk
H	12205.00	30.98	31.02	8.99	39.10	48.05	54.00	-5.95	AV

Polar (H/V)	Frequency	Meter Reading	Pre-ampli fier	Cable Loss	Antenna Factor	Emission Level	Limits	Margin	Detector Type
	(MHz)	(dBuV)	(dB)	(dB)	(dB)	(dBuV/m)	(dBuV/m)	(dB)	
High Channel:2480MHz									
V	4960.00	50.31	30.55	5.77	31.79	57.32	74.00	-16.68	Pk
V	4960.00	31.81	30.55	5.77	31.79	38.82	54.00	-15.18	AV
V	7440.00	52.65	30.33	6.32	36.38	65.02	74.00	-8.98	Pk
V	7440.00	32.10	30.33	6.32	36.38	44.47	54.00	-9.53	AV
V	9920.00	52.65	30.85	7.45	36.50	65.75	74.00	-8.25	Pk
V	9920.00	32.59	30.85	7.45	36.50	45.69	54.00	-8.31	AV
V	12400.00	52.75	31.02	8.99	39.11	69.83	74.00	-4.17	Pk
V	12400.00	31.79	31.02	8.99	39.11	48.87	54.00	-5.13	AV
H	4960.00	50.33	30.55	5.77	31.79	57.34	74.00	-16.66	Pk
H	4960.00	32.00	30.55	5.77	31.79	39.01	54.00	-14.99	AV
H	7440.00	51.82	30.33	6.32	36.38	64.19	74.00	-9.81	Pk
H	7440.00	32.28	30.33	6.32	36.38	44.65	54.00	-9.35	AV
H	9920.00	52.51	30.85	7.45	36.50	65.61	74.00	-8.39	Pk
H	9920.00	32.36	30.85	7.45	36.50	45.46	54.00	-8.54	AV
H	12400.00	52.42	31.02	8.99	39.11	69.50	74.00	-4.50	Pk
H	12400.00	31.34	31.02	8.99	39.11	48.42	54.00	-5.58	AV

Remark:

1. Emission Level = Meter Reading + Antenna Factor + Cable Loss – Pre-amplifier,
Margin= Emission Level - Limit
2. If peak below the average limit, the average emission was no test.
3. The amplitude of spurious emissions which are attenuated by more than 20dB below the permissible value has no need to be reported.

8-DPSK

Polar (H/V)	Frequency	Meter Reading	Pre-amplifier	Cable Loss	Antenna Factor	Emission Level	Limits	Margin	Detector Type
	(MHz)	(dBuV)	(dB)	(dB)	(dB)	(dBuV/m)	(dBuV/m)	(dB)	
Low Channel:2402MHz									
V	4804.00	51.17	30.55	5.77	31.12	57.51	74.00	-16.49	Pk
V	4804.00	30.97	30.55	5.77	31.12	37.31	54.00	-16.69	AV
V	7206.00	48.06	30.33	6.32	36.04	60.09	74.00	-13.91	Pk
V	7206.00	31.97	30.33	6.32	36.04	44.00	54.00	-10.00	AV
V	9608.00	49.26	30.85	7.45	37.58	63.44	74.00	-10.56	Pk
V	9608.00	31.34	30.85	7.45	37.58	45.52	54.00	-8.48	AV
V	12010.00	49.06	31.02	8.99	39.10	66.13	74.00	-7.87	Pk
V	12010.00	31.41	31.02	8.99	39.10	48.48	54.00	-5.52	AV
H	4804.00	51.32	30.55	5.77	31.12	57.66	74.00	-16.34	Pk
H	4804.00	31.16	30.55	5.77	31.12	37.50	54.00	-16.50	AV
H	7206.00	50.26	30.33	6.32	36.04	62.29	74.00	-11.71	Pk
H	7206.00	31.47	30.33	6.32	36.04	43.50	54.00	-10.50	AV
H	9608.00	50.18	30.85	7.45	37.58	64.36	74.00	-9.64	Pk
H	9608.00	31.39	30.85	7.45	37.58	45.57	54.00	-8.43	AV
H	12010.00	50.11	31.02	8.99	39.10	67.18	74.00	-6.82	Pk
H	12010.00	30.50	31.02	8.99	39.10	47.57	54.00	-6.43	AV

Polar (H/V)	Frequency	Meter Reading	Pre-amplifier	Cable Loss	Antenna Factor	Emission Level	Limits	Margin	Detector Type
	(MHz)	(dBuV)	(dB)	(dB)	(dB)	(dBuV/m)	(dBuV/m)	(dB)	
Middle Channel:2441MHz									
V	4882.00	49.90	30.55	5.77	31.46	56.58	74.00	-17.42	Pk
V	4882.00	30.79	30.55	5.77	31.46	37.47	54.00	-16.53	AV
V	7323.00	47.76	30.33	6.32	36.15	59.90	74.00	-14.10	Pk
V	7323.00	30.62	30.33	6.32	36.15	42.76	54.00	-11.24	AV
V	9764.00	48.81	30.85	7.45	37.76	63.17	74.00	-10.83	Pk
V	9764.00	30.89	30.85	7.45	37.76	45.25	54.00	-8.75	AV
V	12205.00	48.71	31.02	8.99	39.10	65.78	74.00	-8.22	Pk
V	12205.00	30.72	31.02	8.99	39.10	47.79	54.00	-6.21	AV
H	4882.00	51.19	30.55	5.77	31.46	57.87	74.00	-16.13	Pk
H	4882.00	30.92	30.55	5.77	31.46	37.60	54.00	-16.40	AV
H	7323.00	52.52	30.33	6.32	36.15	64.66	74.00	-9.34	Pk
H	7323.00	30.70	30.33	6.32	36.15	42.84	54.00	-11.16	AV
H	9764.00	52.07	30.85	7.45	37.76	66.43	74.00	-7.57	Pk
H	9764.00	31.40	30.85	7.45	37.76	45.76	54.00	-8.24	AV
H	12205.00	52.74	31.02	8.99	39.10	69.81	74.00	-4.19	Pk
H	12205.00	30.78	31.02	8.99	39.10	47.85	54.00	-6.15	AV

Polar (H/V)	Frequency	Meter Reading	Pre-amplifier	Cable Loss	Antenna Factor	Emission Level	Limits	Margin	Detector Type
	(MHz)	(dBuV)	(dB)	(dB)	(dB)	(dBuV/m)	(dBuV/m)	(dB)	
High Channel:2480MHz									
V	4960.00	50.85	30.55	5.77	31.79	57.86	74.00	-16.14	Pk
V	4960.00	32.05	30.55	5.77	31.79	39.06	54.00	-14.94	AV
V	7440.00	53.09	30.33	6.32	36.38	65.46	74.00	-8.54	Pk
V	7440.00	32.77	30.33	6.32	36.38	45.14	54.00	-8.86	AV
V	9920.00	53.19	30.85	7.45	36.50	66.29	74.00	-7.71	Pk
V	9920.00	32.99	30.85	7.45	36.50	46.09	54.00	-7.91	AV
V	12400.00	53.09	31.02	8.99	39.11	70.17	74.00	-3.83	Pk
V	12400.00	32.33	31.02	8.99	39.11	49.41	54.00	-4.59	AV
H	4960.00	50.87	30.55	5.77	31.79	57.88	74.00	-16.12	Pk
H	4960.00	32.54	30.55	5.77	31.79	39.55	54.00	-14.45	AV
H	7440.00	52.36	30.33	6.32	36.38	64.73	74.00	-9.27	Pk
H	7440.00	33.00	30.33	6.32	36.38	45.37	54.00	-8.63	AV
H	9920.00	53.06	30.85	7.45	36.50	66.16	74.00	-7.84	Pk
H	9920.00	33.39	30.85	7.45	36.50	46.49	54.00	-7.51	AV
H	12400.00	52.96	31.02	8.99	39.11	70.04	74.00	-3.96	Pk
H	12400.00	32.90	31.02	8.99	39.11	49.98	54.00	-4.02	AV

Remark:

1. Emission Level = Meter Reading + Antenna Factor + Cable Loss – Pre-amplifier,
Margin= Emission Level - Limit
2. If peak below the average limit, the average emission was no test.
3. The amplitude of spurious emissions which are attenuated by more than 20dB below the permissible value has no need to be reported.

5. BANDWIDTH OF FREQUENCY BAND EDGE

5.1 TEST REQUIREMENT:

Test Requirement:	FCC Part15 C Section 15.209 and 15.205				
Test Method:	ANSI C63.10: 2013				
Test Frequency Range:	All of the restrict bands were tested, only the worst band's (2310MHz to 2500MHz) data was showed.				
Test site:	Measurement Distance: 3m				
Receiver setup:	Frequency	Detector	RBW	VBW	Value
	Above 1GHz	Peak	1MHz	3MHz	Peak
		Average	1MHz	3MHz	Average

Emissions radiated outside of the specified frequency bands, except for harmonics, shall be attenuated by at least 50 dB below the level of the fundamental or to the general radiated emission limits in § 15.209, whichever is the lesser attenuation

5.2 TEST PROCEDURE

Above 1GHz test procedure as below:

- a. 1. The EUT was placed on the top of a rotating table 1.5 meters above the ground at a 3 meter camber. The table was rotated 360 degrees to determine the position of the highest radiation.
- b. The EUT was set 3 meters away from the interference-receiving antenna, which was mounted on the top of a variable-height antenna tower.
- c. The antenna height is varied from one meter to four meters above the ground to determine the maximum value of the field strength. Both horizontal and vertical polarizations of the antenna are set to make the measurement.
- d. For each suspected emission, the EUT was arranged to its worst case and then the antenna was tuned to heights from 1 meter to 4 meters and the rota table was turned from 0 degrees to 360 degrees to find the maximum reading.
- e. The test-receiver system was set to Peak Detect Function and Specified Bandwidth with Maximum Hold Mode.
- f. If the emission level of the EUT in peak mode was 10dB lower than the limit specified, then testing could be stopped and the peak values of the EUT would be reported. Otherwise the emissions that did not have 10dB margin would be re-tested one by one using peak, quasi-peak or average method as specified and then reported in a data sheet.
- g. Test the EUT in the lowest channel, the Highest channel

Note:

Both horizontal and vertical antenna polarities were tested and performed pretest to three orthogonal axis. The worst case emissions were reported

5.3 DEVIATION FROM TEST STANDARD

No deviation

5.4 TEST SETUP

Radiated Emission Test-Up Frequency Above 1GHz

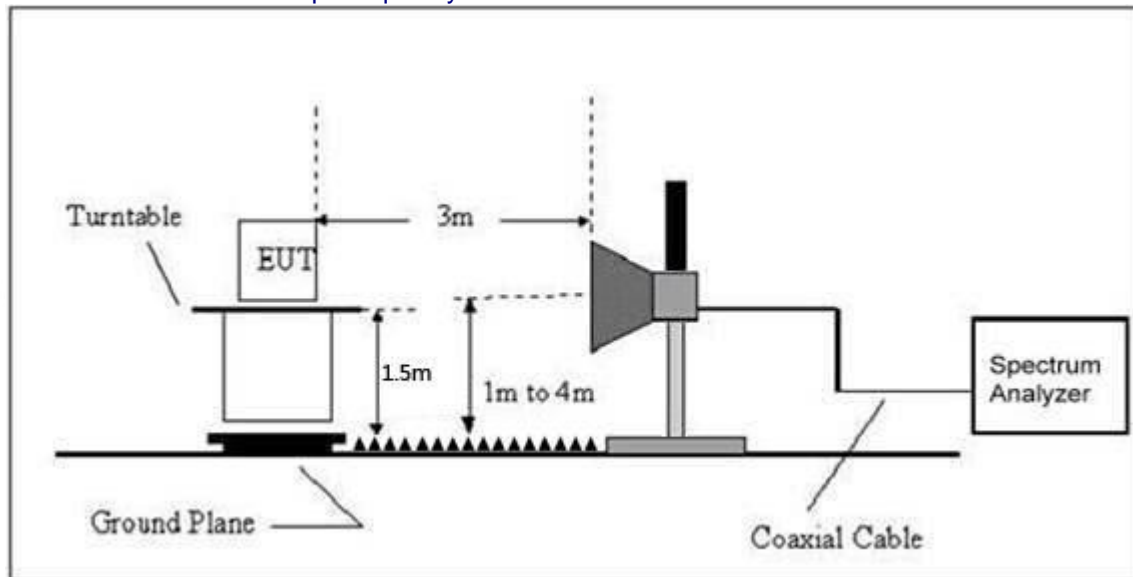

5.5 EUT OPERATING CONDITIONS

The EUT tested system was configured as the statements of 2.3 Unless otherwise a special operating condition is specified in the follows during the testing.

5.6 TEST RESULT

Temperature :	26 °C	Relative Humidity :	54%
Pressure :	101 kPa	Test Voltage :	AC 120V/60Hz
Test Mode :	TX Mode-GFSK-Worst Case		

Peak value:

Frequency (MHz)	Read Level (dBuV)	Antenna Factor (dB/m)	Cable Loss (dB)	Preamp Factor (dB)	Level (dBuV/m)	Limit Line (dBuV/m)	Over Limit (dB)	Polarization
2390.00	45.23	27.25	5.38	30.18	47.68	74.00	-26.32	Horizontal
2400.00	47.90	27.26	5.39	30.18	50.37	74.00	-23.63	Horizontal
2390.00	45.16	27.25	5.38	30.18	47.61	74.00	-26.39	Vertical
2400.00	44.82	27.26	5.39	30.18	47.29	74.00	-26.71	Vertical

2402MHz Horizontal

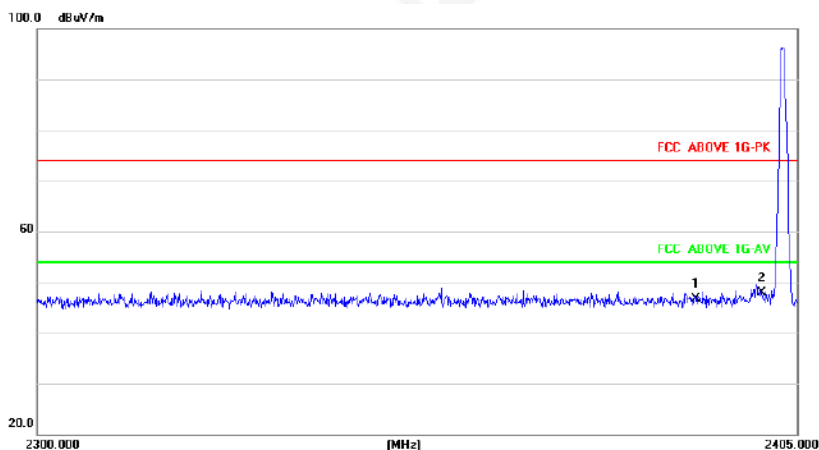

2402MHz Vertical

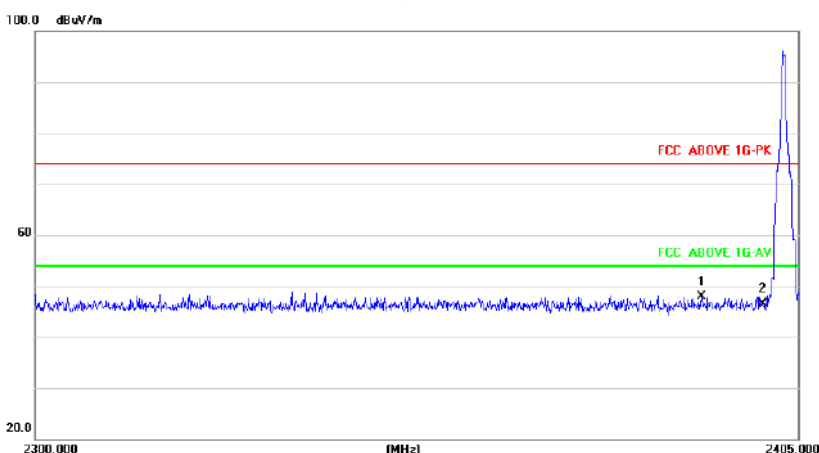

Temperature :	26 °C	Relative Humidity :	54%
Pressure :	101 kPa	Test Voltage :	AC 120V/60Hz
Test Mode :	TX Mode-GFSK-Worst Case		

Peak value:

Frequency (MHz)	Read Level (dBuV)	Antenna Factor (dB/m)	Cable Loss (dB)	Preamp Factor (dB)	Level (dBuV/m)	Limit Line (dBuV/m)	Over Limit (dB)	Polarization
2483.50	46.19	27.25	5.47	29.93	48.98	74.00	-25.02	Horizontal
2500.00	46.72	27.26	5.49	29.93	49.54	74.00	-24.46	Horizontal
2483.50	46.99	27.25	5.47	29.93	49.78	74.00	-24.22	Vertical
2500.00	48.24	27.26	5.49	29.93	51.06	74.00	-22.94	Vertical

2480MHz Horizontal

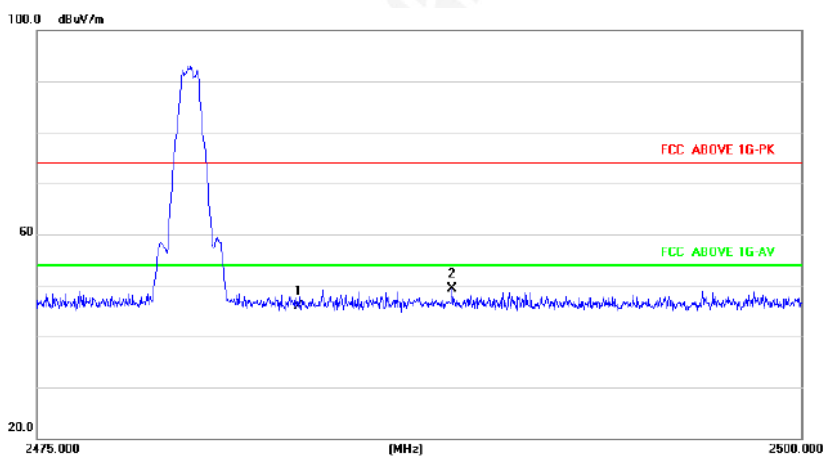

2480MHz Vertical

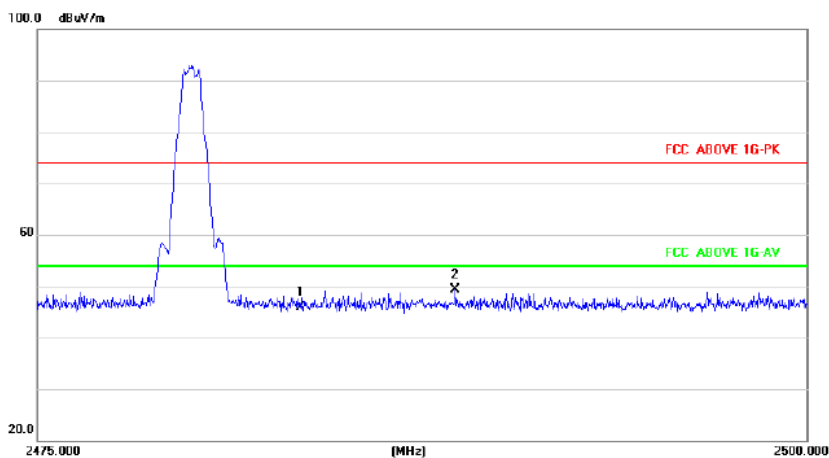

6. CHANNEL BANDWIDTH

Test Requirement:	FCC Part15 C Section 15.249/15.215
Test Method:	ANSI C63.10: 2013

6.1 APPLIED PROCEDURES / LIMIT

FCC Part15 (15.249) , Subpart C			
Section	Test Item	Frequency Range (MHz)	Result
15.249(c)	Bandwidth	2400-2483.5	PASS

6.2 TEST PROCEDURE

1. Set resolution bandwidth (RBW) = 1-5% or DTS BW, not to exceed 100 kHz.
2. Set the video bandwidth (VBW) $\geq 3 \times$ RBW.
3. Detector = Peak.
4. Trace mode = max hold.
5. Sweep = auto couple.
6. Allow the trace to stabilize.
7. Measure the maximum width of the emission that is constrained by the frequencies associated with the two outermost amplitude points (upper and lower) that are attenuated by 6 dB relative to the maximum level measured in the fundamental emission.

6.3 DEVIATION FROM STANDARD

No deviation.

6.4 TEST SETUP

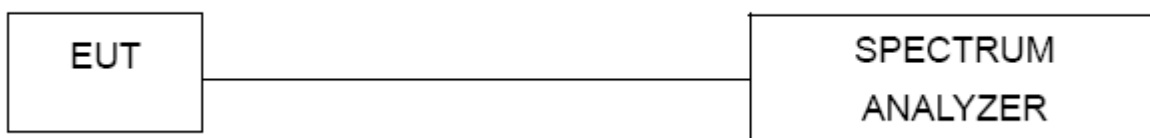

6.5 EUT OPERATION CONDITIONS

The EUT tested system was configured as the statements of 2.4 Unless otherwise a special operating condition is specified in the follows during the testing.

6.6 TSET RESULTS

Temperature :	26°C	Relative Humidity :	54%
Test Mode :	GFSK	Test Voltage :	AC 120V/60Hz

Mode	Test channel	20dB Emission Bandwidth (MHz)	Result
GFSK	Lowest	0.953	Pass
	Middle	0.943	
	Highest	0.945	
$\pi/4$ -DQPSK	Lowest	1.352	Pass
	Middle	1.357	
	Highest	1.352	
8-DPSK	Lowest	1.334	Pass
	Middle	1.336	
	Highest	1.333	

Test plots

GFSK

$\pi/4$ -DQPSK

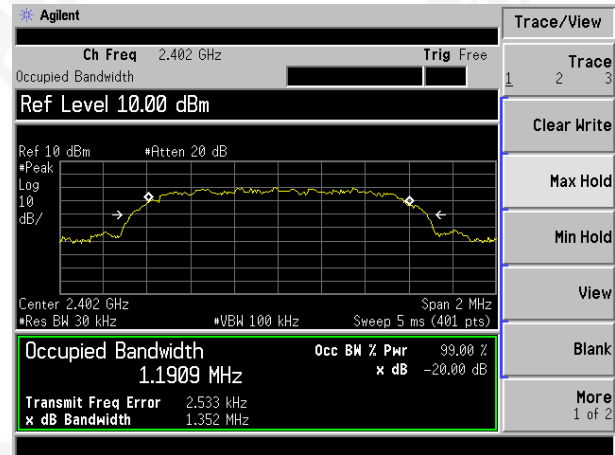
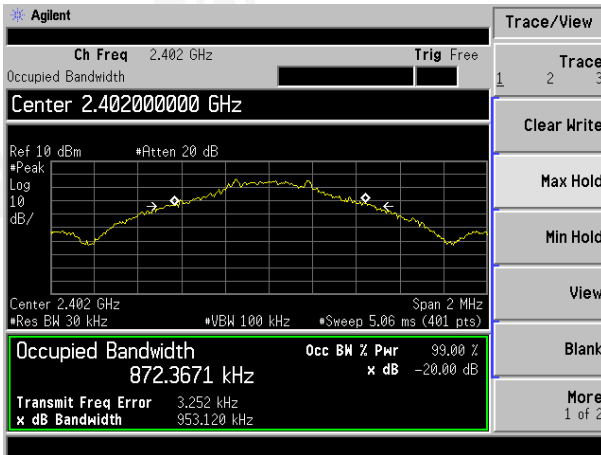

Lowest channel

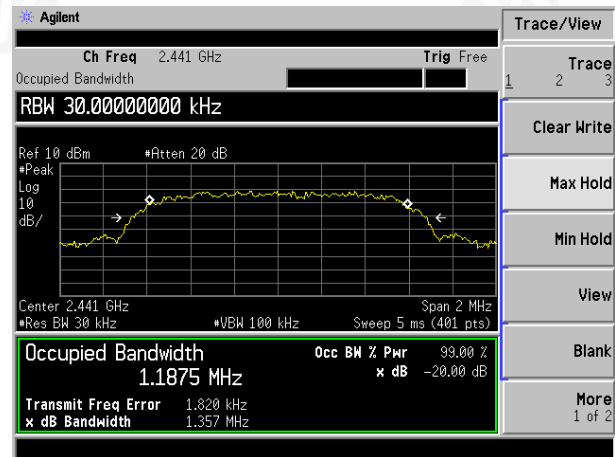
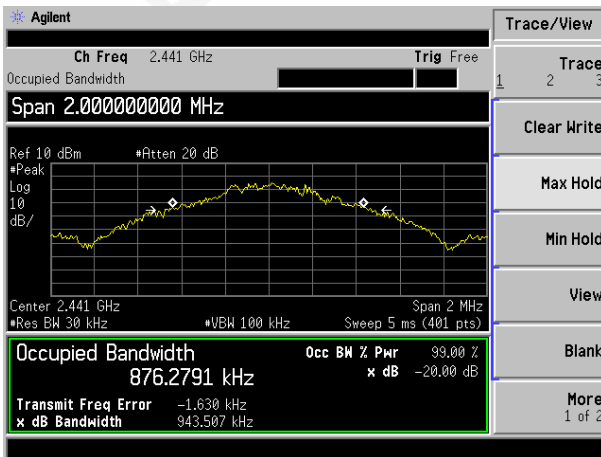

Middle channel

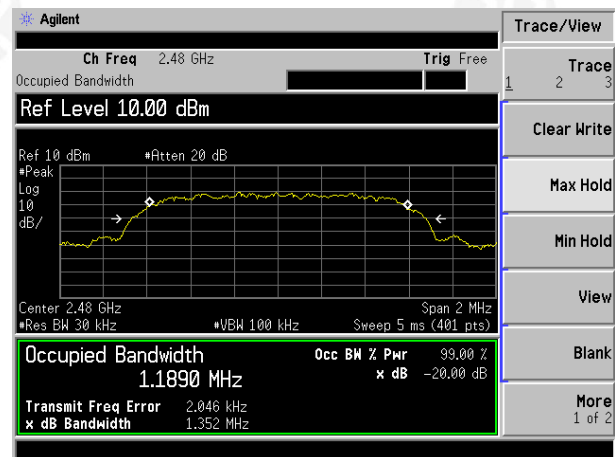
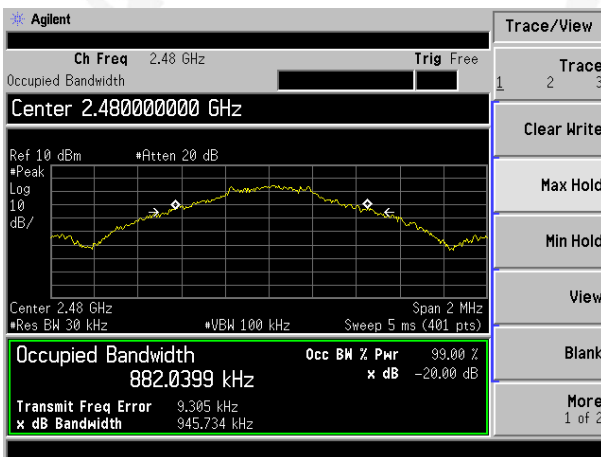

Highest channel

8-DPSK

Lowest channel

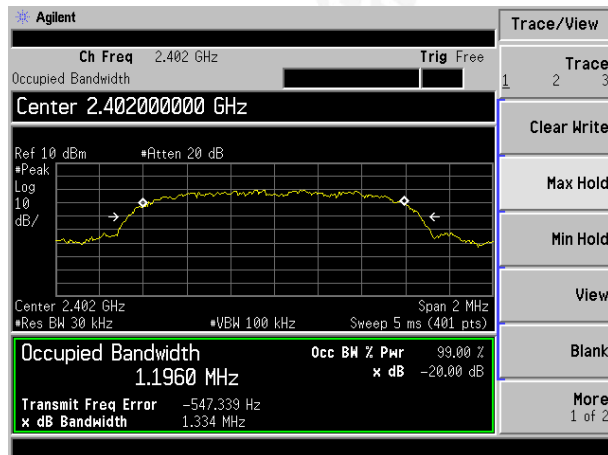

Middle channel

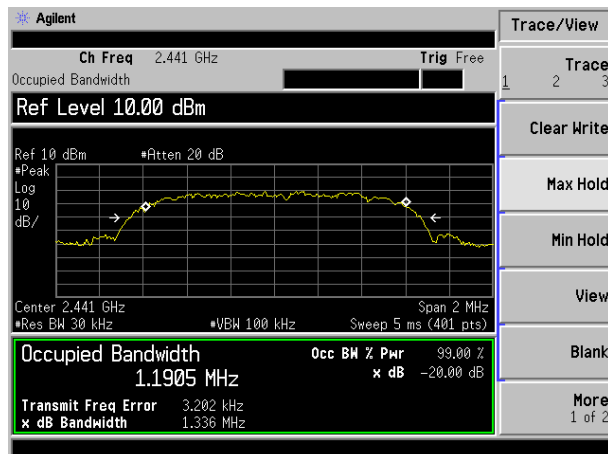

Highest channel

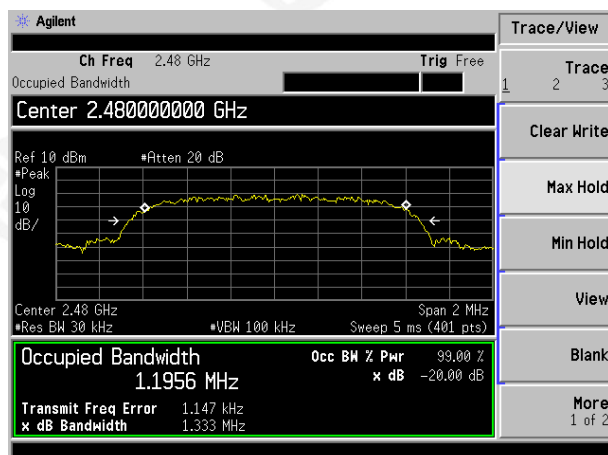

8.ANTENNA REQUIREMENT

Standard requirement:	FCC Part15 C Section 15.203
15.203 requirement: An intentional radiator shall be designed to ensure that no antenna other than that furnished by the responsible party shall be used with the device. The use of a permanently attached antenna or of an antenna that uses a unique coupling to the intentional radiator, the manufacturer may design the unit so that a broken antenna can be replaced by the user, but the use of a standard antenna jack or electrical connector is prohibited.	
EUT Antenna:	
The antennas are PCB antenna, the best case gain of the antennas are 0dBi, reference to the appendix II for details	

9. TEST SETUP PHOTO

Reference to the appendix I for details.

10. EUT CONSTRUCTIONAL DETAILS

Reference to the appendix II for details.

***** END OF REPORT *****