

SEEYING

TURNTABLE SYSTEM



TT-185BT

Owner Manual

WARNING

TO PREVENT FIRE OR SHOCK HAZARD, DO NOT USE THIS PLUG WITH AN EXTENSION CORD, RECEPTACLE OR OTHER OUTLET UNLESS THE BLADES CAN BE FULLY INSERTED TO PREVENT BLADE EXPOSURE. TO PREVENT FIRE OR SHOCK HAZARD, DO NOT EXPOSE THIS APPLIANCE TO RAIN OR MOISTURE.



THE CAUTION MARKING AND RATING LABEL ARE LOCATED AT THE BOTTOM OF THE UNIT

IMPORTANT SAFETY INSTRUCTIONS

1. Read these instructions.
2. Keep these instructions.
3. Heed all warnings.
4. Follow all instructions.
5. Do not use this apparatus near water.
6. Clean only with dry cloth.
7. Do not block any ventilation openings. Install in accordance with the manufacturer's instructions.
8. Do not install near any heat sources such as radiators, heat registers, stoves, or other apparatus (including amplifiers) that produce heat.
9. Do not defeat the safety purpose of the polarized or grounding-type plug. A polarized plug has two blades with one wider than the other. A grounding type plug has two blades and a third grounding prong. The wide blade or the third prong is provided for your safety. If the provided plug does not fit into your outlet, consult an electrician for replacement of the obsolete outlet.
10. Protect the power cord from being walked on or pinched particularly at plugs, convenience receptacles, and the point where they exit from the apparatus.
11. Only use attachments/accessories specified by the manufacturer.
12. Use only with a cart, stand, tripod, bracket, or table recommended by the manufacturer, or sold with the product. When a cart is used, use caution when moving the cart/apparatus combination to avoid injury from tip-over.
13. Unplug this apparatus during lightning storms or when unused for a long periods of time.
14. Refer all servicing to qualified service personnel. Servicing is required when the apparatus has been damaged in any way, such as power-supply cord or plug is damaged, liquid has been spilled or objects have fallen into the apparatus, the apparatus has been exposed to rain or moisture, does not operate normally, or has been dropped.
15. This appliance shall not be exposed to dripping or splashing water and that no object filled with liquids such as vases shall be placed on the apparatus.
16. Do not overload wall outlet. Use only power source as indicated.
17. Use replacement part as specified by the manufacturer.
18. Upon completion of any service or repairs to this product, ask the service technician to



- perform safety checks.
19. Power Sources - This product should be operated only from the type of power source indicated on the marking label. If you are not sure of the type of power supply to your home, consult your product dealer or local power company. For products intended to operate from battery power, or other sources, refer to the operating instruction.
 20. Object and Liquid Entry - Never push objects of any kind into this product through openings as they may touch dangerous voltage points or short-out parts that could result in a fire or electric shock. Never spill liquid of any kind on the product.
 21. Damage Requiring Service - Unplug this product from the wall outlet and refer servicing to qualified service personnel under the following conditions:
 - a) When the power-supply cord or plug is damaged,
 - b) If liquid has been spilled, or objects have fallen into the product,
 - c) If the product has been exposed to rain or water,
 - d) If the product does not operate normally by following the operating instructions. Adjust only those controls that are covered by the operating instructions as an improper adjustment of other controls may result in damage and will often require extensive work by a qualified technician to restore the product to its normal operation.
 - e) If the product has been dropped or damaged in any way, and
 - f) When the product exhibits a distinct change in performance - this indicates a need for service.
 22. Mains plug is used as disconnect device and it should remain readily operable during intended use. In order to disconnect the apparatus from the mains completely, the mains plug should be disconnected from the mains socket outlet completely.
 23. Excessive sound pressure from earphones and headphone can cause hearing loss.
 24. Minimum distances of 10 cm around the apparatus for sufficient ventilation
 25. The ventilation should not be impeded by covering the ventilation openings with items, such as newspapers, table-cloths, curtains, etc.
 26. No naked flame sources, such as lighted candles, should be placed on the apparatus.
 27. The use of apparatus in moderate climates.

This symbol indicates that this product incorporates double insulation between hazardous mains voltage and user accessible parts.

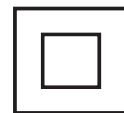

CAUTION

TO PREVENT ELECTRIC SHOCK, MATCH WIDE BLADE OF PLUG TO WIDE SLOT. FULLY INSERT THE PLUG TO MAIN POWER SOCKET.

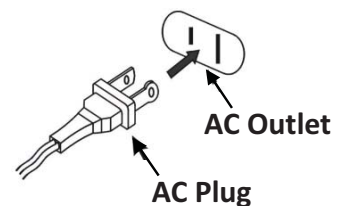

SAVE THESE INSTRUCTIONS

IMPORTANT NOTES

Avoid installing the unit in locations described below:

- Places exposed to direct sunlight or close to heat radiating appliances such as electric heaters.
- Places subject to constant vibration.
- Dusty, humid or moist places.
- Unplug the unit from the electrical power outlet immediately in case of malfunction.

This device complies with Part 15 of the FCC Rules. Operation is subject to the following two conditions:

- (1) This device may not cause harmful interference.
- (2) This device must accept any interference received, including interference that may cause undesired operation.

LOCATION OF CONTROLS

- 1) Dust Cover
- 2) Dial Pointer with LED Indicator
- 3) Speaker
- 4) Function Switch
- 5) FM / FM Stereo switch
- 6) 3.5mm Headphone Jack
- 7) Bluetooth LED indicator
- 8) Power indicator
- 9) FM Stereo indicator
- 10) Power ON-OFF/ Volume Control Knob
- 11) Tuning Knob
- 12) 45 RPM Record Adaptor
- 13) Turntable Speed Selector
- 14) Auto Stop Switch
- 15) Tone Arm Rest/Holder
- 16) Line Out Socket (L/R)
- 17) FM Wire Antenna
- 18) AC Power Cord

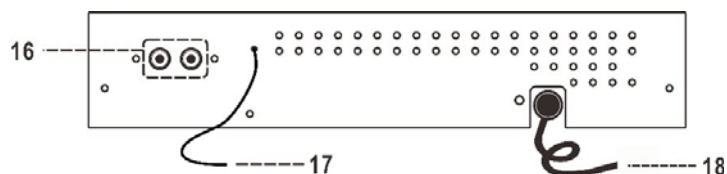
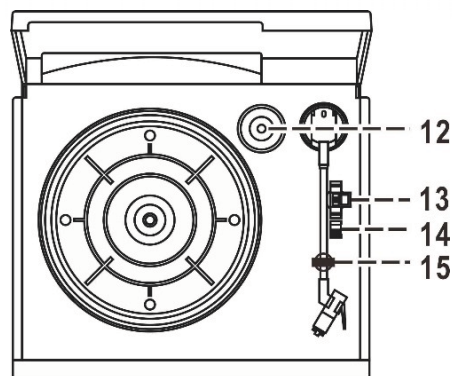
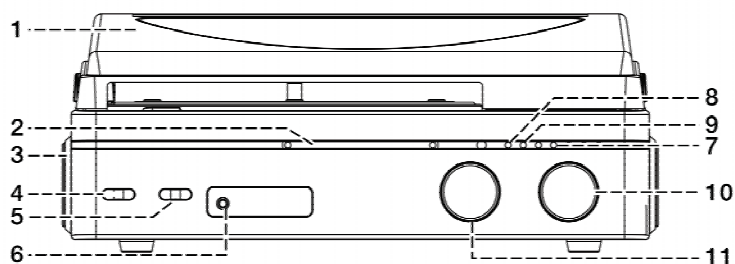

CONNECTION

1. Connect the power cord to an AC outlet.
2. Turn on the power by Power On/Off-Volume control knob (10) and the power LED indicator (8) will light up, your system is now ready to play your music. Please refer to the Operations section of this Manual for details.

Operation

LISTENING TO RADIO

MANUAL TUNING

1. Turn on the unit by Power On/Off (10) and slide the Function switch (4) to Tuner position.
2. Tune to requested radio station by Tuning knob (11), and select FM or FM-Stereo by the FM / FM Stereo switch (5).
3. Adjust the Power ON-OFF/ Volume Control Knob (10) to desired volume level.

FM & FM-STEREO RECEPTION

- Set the FM / FM Stereo switch (5) at " FM " position. Program are received in FM mono mode. In particular when stereo signals are weak. It is preferable to receive the program in mono mode.

- Set the FM / FM Stereo switch (5) at “ FM-ST ” position for receiving stereo program. The FM Stereo LED indicator (9) will light up to show FM stereo program is receiving

HINTS FOR BEST RECEPTION:-

- **FM : THE RECEIVER HAS A BUILT-IN FM WIRE ANTENNA HANGING AT THE REAR CABINET. THIS WIRE SHOULD BE TOTALLY UNRAVELED AND EXTENDED FOR BEST RECEPTION.**

STEREO PHONOGRAPH OPERATION

Please Note - Before Use

- Remove the stylus protector.
- Make sure that the tone arm is unlocked and free to move from the tone arm rest prior to operating. Lock the tone arm again when not in use.

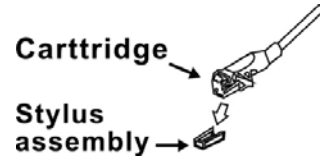

1. Turn on the unit by Power On/Off (10) and slide the Function switch (4) to PHONO position
2. Raise the turntable dust cover.
3. Place the record on the platter (use the 45 RPM record adaptor (12) if you are playing 45 RPM records).
4. Set the speed selector (13) to the proper position for the record you are playing.
5. Lift the tone arm from the rest (15) and slowly move it over the record. The platter will begin spinning.
6. Place the tone arm down onto the record in the location that you want to play.
7. Adjust the volume (10) to the desired level.
8. At the end of record, the platter will automatically stop spinning. Lift the tone arm from the record and return it to the rest.
9. To stop playing manually, lift the tone arm from the record and return it to the rest.

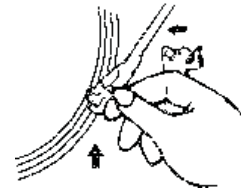

NOTE: Some types of records may have an auto-stop area outside the preset limit, so the turntable may stop before the last track finishes. In this case, set the AUTO-STOP switch to the “OFF” position. This allows the record to play to the end, but please note that it will not stop automatically. You must manually raise the tone arm and place it back in the rest and then turn off the power to stop the turntable from spinning.

BLUETOOTH CONNECTION AND PLAYBACK

1. Turn on the unit by Power On/Off (10)
2. Slide the Function switch (4) to BT position.
3. The Bluetooth LED indicator (7) will be flashing, it means the Bluetooth in non connection / searching mode.
4. Switch on the Bluetooth feature of your Bluetooth device (such as mobile phone) and select “ TT-185BT ” Bluetooth equipment to connecting.
5. Once the connection was finished and connected successfully, the Bluetooth LED indicator (7) will light up.
6. Adjust the volume (10) to the desired level.
7. Start to playback your Bluetooth device and enjoy the music by the main unit.

Remark:-

- To disconnect the Bluetooth connection, slide the Function switch (4) to PHONO position, or turn off the Bluetooth feature of your Bluetooth device.

LINE OUT CONNECTION

You can connect this unit to your external Hi-Fi / AMPLIFIER system by connecting the LINE OUT socket (16) to the auxiliary input socket of your Hi-Fi / AMPLIFIER system. with a RCA cable (not included).

Note: The Volume control will not function when using the LINE OUT.

USING HEADPHONES (NOT INCLUDED)

Inserting the plug of your headphones into the Headphone jack will enable you to listen in private.

READ THIS IMPORTANT INFORMATION BEFORE USING YOUR HEADPHONES

1. Avoid extended play at very high volume as it may impair your hearing.
2. If you experience ringing in your ears, reduce the volume or shut off your unit.
3. Keep the volume at a reasonable level even if your headset is an open-air type designed to allow you to hear outside sounds. Please note that excessively high volume may still block outside sounds.

CARE AND MAINTENANCE

1. Avoid operating your unit under direct sunlight or in hot, humid or dusty places.
2. Keep your unit away from heating appliances and sources of electrical noise such as fluorescent lamps or motors.
3. Unplug the unit from the electrical power outlet immediately in case of malfunction.

CLEANING THE UNIT

- To prevent fire or shock hazard, disconnect your unit from the AC power source when cleaning.
- The finish on the unit may be cleaned with a dust cloth and cared for as other furniture, Use caution when cleaning and wiping the plastic parts.
- If the cabinet becomes dusty wipe it with a soft dry dust cloth. Do not use any wax or polish sprays on the cabinet.
- If the front panel becomes dirty or smudged with fingerprints it may be cleaned with a soft cloth slightly dampened with a mild soap and water solution. Never use abrasive cloths or polishes as these will damage the finish of your unit.

CAUTION: Never allow any water or other liquids to get inside the unit while cleaning.

SPECIFICATIONS

AC Power: AC 120V ~ 60Hz

Bluetooth

Maximum communication range: Line of sight approx. 10m (30 feet)

WARRANTY CARD

Dear Customer, thank you for choosing SeeYing.
Wish our product will give you a nice classic music experience.
Please keep this card for product warranty!
Any questions feel free to contact:
seeyinguserservice@outlook.com

SEEYING		
Warranty Card		
Model Number	Date of Purchase	QA PASSED
Customer	Dealer	
Name	Name and Address	
Address		

Benefits for contacting us:

- ① You'll get a reply in 12 working hours.
- ② You'll get professional technical support.
- ③ If you are satisfied with our product, please leave your honest review for us and we will give you a surprise!



Contact us directly for any further information or any question.
We are able to solve all your problems and it's our pleasure
to provide best customer service for you!

Feel free to contact us at:
seeyinguserservice@outlook.com

Warning Statement

This device complies with part 15 of the FCC Rules. Operation is subject to the following two conditions: (1) This device may not cause harmful interference, and (2) this device must accept any interference received, including interference that may cause undesired operation.

Any Changes or modifications not expressly approved by the party responsible for compliance could void the user's authority to operate the equipment.

Note: This equipment has been tested and found to comply with the limits for a Class B digital device, pursuant to part 15 of the FCC Rules. These limits are designed to provide reasonable protection against harmful interference in a residential installation. This equipment generates uses and can radiate radio frequency energy and, if not installed and used in accordance with the instructions, may cause harmful interference to radio communications. However, there is no guarantee that interference will not occur in a particular installation. If this equipment does cause harmful interference to radio or television reception, which can be determined by turning the equipment off and on, the user is encouraged to try to correct the interference by one or more of the following measures:

- Reorient or relocate the receiving antenna.
- Increase the separation between the equipment and receiver.
- Connect the equipment into an outlet on a circuit different from that to which the receiver is connected.
- Consult the dealer or an experienced radio/TV technician for help.