

FCC Measurement/Technical Report on

BRP VIP Cluster

VIPHI2BT

FCC ID: 2AMJS-VDIBRHS01
IC: 22868-VDIBRHS01

Test Report Reference: MDE_BOSCH_1710_FCCa

Test Laboratory:

7layers GmbH
Borsigstrasse 11
40880 Ratingen
Germany



Note:

The following test results relate only to the devices specified in this document. This report shall not be reproduced in parts without the written approval of the test laboratory.

7layers GmbH
Borsigstraße 11
40880 Ratingen, Germany
T +49 (0) 2102 749 0
F +49 (0) 2102 749 350

Geschäftsführer/
Managing Directors:
Frank Spiller
Bernhard Retka
Alexandre Norré-Oudard

Registergericht/registered:
Düsseldorf HRB 75554
USt-Id.-Nr./VAT-No. DE203159652
Steuer-Nr./TAX-No. 147/5869/0385

*a Bureau Veritas
Group Company*

www.7layers.com

Table of Contents

1	Applied Standards and Test Summary	4
1.1	Applied Standards	4
1.2	FCC-IC Correlation Table	5
1.3	Measurement Summary / Signatures	6
2	Administrative Data	12
2.1	Testing Laboratory	12
2.2	Project Data	12
2.3	Applicant Data	12
2.4	Manufacturer Data	12
3	Test object Data	13
3.1	General EUT Description	13
3.2	EUT Main components	14
3.3	Ancillary Equipment	14
3.4	Auxiliary Equipment	14
3.5	EUT Setups	15
3.6	Operating Modes	15
3.7	Product labelling	15
4	Test Results	16
4.1	Occupied Bandwidth (20 dB)	16
4.2	Peak Power Output	28
4.3	Spurious RF Conducted Emissions	40
4.4	Transmitter Spurious Radiated Emissions	52
4.5	Band Edge Compliance Conducted	66
4.6	Band Edge Compliance Radiated	81
4.7	Channel Separation	86
4.8	Dwell Time	89
4.9	Number of Hopping Frequencies	92
5	Test Equipment	95
6	Antenna Factors, Cable Loss and Sample Calculations	97
6.1	LISN R&S ESH3-Z5 (150 kHz – 30 MHz)	97
6.2	Antenna R&S HFH2-Z2 (9 kHz – 30 MHz)	98
6.3	Antenna R&S HL562 (30 MHz – 1 GHz)	99
6.4	Antenna R&S HF907 (1 GHz – 18 GHz)	100
6.5	Antenna EMCO 3160-09 (18 GHz – 26.5 GHz)	101
6.6	Antenna EMCO 3160-10 (26.5 GHz – 40 GHz)	102
7	Setup Drawings	103
8	Measurement Uncertainties	104

1 APPLIED STANDARDS AND TEST SUMMARY

1.1 APPLIED STANDARDS

Type of Authorization

Certification for an Intentional Radiator.

Applicable FCC Rules

Prepared in accordance with the requirements of FCC Rules and Regulations as listed in 47 CFR Ch.1 Parts 2 and 15 (10-1-15 Edition). The following subparts are applicable to the results in this test report.

Part 2, Subpart J - Equipment Authorization Procedures, Certification

Part 15, Subpart C – Intentional Radiators

§ 15.201 Equipment authorization requirement

§ 15.207 Conducted limits

§ 15.209 Radiated emission limits; general requirements

§ 15.247 Operation within the bands 902-928 MHz, 2400-2483.5 MHz

Note: (FHSS Equipment)

The tests were selected and performed with reference to the FCC Public Notice DA 00-705, released March 30, 2000. Instead of applying ANSI C63.4-1992 which is referenced in the FCC Public Note, the newer ANSI C63.10-2013 is applied.

Summary Test Results:

The EUT complied with all performed tests as listed in chapter 1.3 Measurement Summary / Signatures.

1.2 FCC-IC CORRELATION TABLE

Correlation of measurement requirements for FHSS (e.g. Bluetooth®) equipment from FCC and IC

FHSS equipment

Measurement	FCC reference	IC reference
Conducted emissions on AC Mains	§ 15.207	RSS-Gen Issue 4: 8.8
Occupied bandwidth	§ 15.247 (a) (1)	RSS-247 Issue 2: 5.1 (b)
Peak conducted output power	§ 15.247 (b) (1), (4)	RSS-247 Issue 2: 5.4 (b)
Transmitter spurious RF conducted emissions	§ 15.247 (d)	RSS-Gen Issue 4: 6.13/8.9/8.10; RSS-247 Issue 2: 5.5
Transmitter spurious radiated emissions	§ 15.247 (d); § 15.209 (a)	RSS-Gen Issue 4: 6.13 / 8.9/8.10; RSS-247 Issue 2: 5.5
Band edge compliance	§ 15.247 (d)	RSS-247 Issue 2: 5.5
Dwell time	§ 15.247 (a) (1) (iii)	RSS-247 Issue 2: 5.1 (d)
Channel separation	§ 15.247 (a) (1)	RSS-247 Issue 2: 5.1 (b)
No. of hopping frequencies	§ 15.247 (a) (1) (iii)	RSS-247 Issue 2: 5.1 (d)
Hybrid systems (only)	§ 15.247 (f); § 15.247 (e)	RSS-247 Issue 2: 5.3
Antenna requirement	§ 15.203 / 15.204	RSS-Gen Issue 4: 8.3
Receiver spurious emissions	–	-

1.3 MEASUREMENT SUMMARY / SIGNATURES

Module: UGXZEX304A

47 CFR CHAPTER I FCC PART 15 Subpart C §15.247

§ 15.247 (a) (1)

Occupied Bandwidth (20 dB)

The measurement was performed according to ANSI C63.10

Final Result

OP-Mode	Setup	FCC	IC
Radio Technology, Operating Frequency			
Bluetooth BDR, high	S01_AB01	Passed	Passed
Bluetooth BDR, low	S01_AB01	Passed	Passed
Bluetooth BDR, mid	S01_AB01	Passed	Passed
Bluetooth EDR 2, high	S01_AB01	Passed	Passed
Bluetooth EDR 2, low	S01_AB01	Passed	Passed
Bluetooth EDR 2, mid	S01_AB01	Passed	Passed
Bluetooth EDR 3, high	S01_AB01	Passed	Passed
Bluetooth EDR 3, low	S01_AB01	Passed	Passed
Bluetooth EDR 3, mid	S01_AB01	Passed	Passed

47 CFR CHAPTER I FCC PART 15 Subpart C §15.247

§ 15.247 (b) (1)

Peak Power Output

The measurement was performed according to ANSI C63.10

Final Result

OP-Mode	Setup	FCC	IC
Radio Technology, Operating Frequency, Measurement method			
Bluetooth BDR, high, conducted	S01_AB01	Passed	Passed
Bluetooth BDR, low, conducted	S01_AB01	Passed	Passed
Bluetooth BDR, mid, conducted	S01_AB01	Passed	Passed
Bluetooth EDR 2, high, conducted	S01_AB01	Passed	Passed
Bluetooth EDR 2, low, conducted	S01_AB01	Passed	Passed
Bluetooth EDR 2, mid, conducted	S01_AB01	Passed	Passed
Bluetooth EDR 3, high, conducted	S01_AB01	Passed	Passed
Bluetooth EDR 3, low, conducted	S01_AB01	Passed	Passed
Bluetooth EDR 3, mid, conducted	S01_AB01	Passed	Passed

47 CFR CHAPTER I FCC PART 15 Subpart C §15.247

§ 15.247 (d)

Spurious RF Conducted Emissions

The measurement was performed according to ANSI C63.10

Final Result

OP-Mode	Setup	FCC	IC
Radio Technology, Operating Frequency			
Bluetooth BDR, high	S01_AB01	Passed	Passed
Bluetooth BDR, low	S01_AB01	Passed	Passed
Bluetooth BDR, mid	S01_AB01	Passed	Passed
Bluetooth EDR 2, high	S01_AB01	Passed	Passed
Bluetooth EDR 2, low	S01_AB01	Passed	Passed
Bluetooth EDR 2, mid	S01_AB01	Passed	Passed

47 CFR CHAPTER I FCC PART 15 Subpart C
§15.247

§ 15.247 (d)

Spurious RF Conducted Emissions

The measurement was performed according to ANSI C63.10

Final Result

OP-Mode	Setup	FCC	IC
Radio Technology, Operating Frequency			
Bluetooth EDR 3, high	S01_AB01	Passed	Passed
Bluetooth EDR 3, low	S01_AB01	Passed	Passed
Bluetooth EDR 3, mid	S01_AB01	Passed	Passed

47 CFR CHAPTER I FCC PART 15 Subpart C
§15.247

§ 15.247 (d)

Transmitter Spurious Radiated Emissions

The measurement was performed according to ANSI C63.10

Final Result

OP-Mode	Setup	FCC	IC
Radio Technology, Operating Frequency, Measurement range			
Bluetooth BDR, high, 1 GHz - 26 GHz	S01_AA01	Passed	Passed
Bluetooth BDR, high, 30 MHz - 1 GHz	S01_AA01	Passed	Passed
Bluetooth BDR, low, 1 GHz - 26 GHz	S01_AA01	Passed	Passed
Bluetooth BDR, low, 30 MHz - 1 GHz	S01_AA01	Passed	Passed
Bluetooth BDR, mid, 1 GHz - 26 GHz	S01_AA01	Passed	Passed
Bluetooth BDR, mid, 30 MHz - 1 GHz	S01_AA01	Passed	Passed
Bluetooth BDR, mid, 9 kHz - 30 MHz	S01_AA01	Passed	Passed
Bluetooth EDR 2, high, 1 GHz - 26 GHz Remark: tested 1GHz-8GHz	S01_AA01	Passed	Passed
Bluetooth EDR 2, low, 1 GHz - 26 GHz Remark: tested 1GHz-8GHz	S01_AA01	Passed	Passed
Bluetooth EDR 2, mid, 1 GHz - 26 GHz Remark: tested 1GHz-8GHz	S01_AA01	Passed	Passed

47 CFR CHAPTER I FCC PART 15 Subpart C
§15.247

§ 15.247 (d)

Band Edge Compliance Conducted

The measurement was performed according to ANSI C63.10

Final Result

OP-Mode	Setup	FCC	IC
Radio Technology, Operating Frequency, Band Edge			
Bluetooth BDR, high, high	S01_AB01	Passed	Passed
Bluetooth BDR, hopping, high	S01_AB01	Passed	Passed
Bluetooth BDR, hopping, low	S01_AB01	Passed	Passed
Bluetooth BDR, low, low	S01_AB01	Passed	Passed
Bluetooth EDR 2, high, high	S01_AB01	Passed	Passed
Bluetooth EDR 2, hopping, high	S01_AB01	Passed	Passed
Bluetooth EDR 2, hopping, low	S01_AB01	Passed	Passed
Bluetooth EDR 2, low, low	S01_AB01	Passed	Passed
Bluetooth EDR 3, high, high	S01_AB01	Passed	Passed
Bluetooth EDR 3, hopping, high	S01_AB01	Passed	Passed
Bluetooth EDR 3, hopping, low	S01_AB01	Passed	Passed
Bluetooth EDR 3, low, low	S01_AB01	Passed	Passed

47 CFR CHAPTER I FCC PART 15 Subpart C
§15.247

§ 15.247 (d)

Band Edge Compliance Radiated

The measurement was performed according to ANSI C63.10

Final Result

OP-Mode

Radio Technology, Operating Frequency, Band Edge

Setup

FCC

IC

Bluetooth BDR, high, high

S01_AA01

Passed

Passed

Bluetooth EDR 2, high, high

S01_AA01

Passed

Passed

Bluetooth EDR 3, high, high

S01_AA01

Passed

Passed

47 CFR CHAPTER I FCC PART 15 Subpart C
§15.247

§ 15.247 (a) (1)

Channel Separation

The measurement was performed according to ANSI C63.10

Final Result

OP-Mode

Radio Technology

Setup

FCC

IC

Bluetooth BDR

S01_AB01

Passed

Passed

47 CFR CHAPTER I FCC PART 15 Subpart C
§15.247

§ 15.247 (a) (1) (iii)

Dwell Time

The measurement was performed according to ANSI C63.10

Final Result

OP-Mode

Radio Technology

Setup

FCC

IC

Bluetooth BDR

S01_AB01

Passed

Passed

47 CFR CHAPTER I FCC PART 15 Subpart C
§15.247

§ 15.247 (a) (1) (iii)

Number of Hopping Frequencies

The measurement was performed according to ANSI C63.10

Final Result

OP-Mode

Radio Technology

Setup

FCC

IC

Bluetooth BDR

S01_AB01

Passed

Passed

N/A: Not applicable

N/P: Not performed

Module: UGKZ7A1001A

**47 CFR CHAPTER I FCC PART 15 Subpart C
§15.247**

§ 15.247 (a) (1)

Occupied Bandwidth (20 dB)

The measurement was performed according to ANSI C63.10

Final Result

OP-Mode	Setup	FCC	IC
Radio Technology, Operating Frequency			
Bluetooth BDR, high	S01_AB01	Passed	Passed
Bluetooth BDR, low	S01_AB01	Passed	Passed
Bluetooth BDR, mid	S01_AB01	Passed	Passed
Bluetooth EDR 2, high	S01_AB01	Passed	Passed
Bluetooth EDR 2, low	S01_AB01	Passed	Passed
Bluetooth EDR 2, mid	S01_AB01	Passed	Passed
Bluetooth EDR 3, high	S01_AB01	Passed	Passed
Bluetooth EDR 3, low	S01_AB01	Passed	Passed
Bluetooth EDR 3, mid	S01_AB01	Passed	Passed

**47 CFR CHAPTER I FCC PART 15 Subpart C
§15.247**

§ 15.247 (b) (1)

Peak Power Output

The measurement was performed according to ANSI C63.10

Final Result

OP-Mode	Setup	FCC	IC
Radio Technology, Operating Frequency, Measurement method			
Bluetooth BDR, high, conducted	S01_AB01	Passed	Passed
Bluetooth BDR, low, conducted	S01_AB01	Passed	Passed
Bluetooth BDR, mid, conducted	S01_AB01	Passed	Passed
Bluetooth EDR 2, high, conducted	S01_AB01	Passed	Passed
Bluetooth EDR 2, low, conducted	S01_AB01	Passed	Passed
Bluetooth EDR 2, mid, conducted	S01_AB01	Passed	Passed
Bluetooth EDR 3, high, conducted	S01_AB01	Passed	Passed
Bluetooth EDR 3, low, conducted	S01_AB01	Passed	Passed
Bluetooth EDR 3, mid, conducted	S01_AB01	Passed	Passed

**47 CFR CHAPTER I FCC PART 15 Subpart C
§15.247**

§ 15.247 (d)

Spurious RF Conducted Emissions

The measurement was performed according to ANSI C63.10

Final Result

OP-Mode	Setup	FCC	IC
Radio Technology, Operating Frequency			
Bluetooth BDR, high	S01_AB01	Passed	Passed
Bluetooth BDR, low	S01_AB01	Passed	Passed
Bluetooth BDR, mid	S01_AB01	Passed	Passed
Bluetooth EDR 2, high	S01_AB01	Passed	Passed
Bluetooth EDR 2, low	S01_AB01	Passed	Passed
Bluetooth EDR 2, mid	S01_AB01	Passed	Passed
Bluetooth EDR 3, high	S01_AB01	Passed	Passed
Bluetooth EDR 3, low	S01_AB01	Passed	Passed

47 CFR CHAPTER I FCC PART 15 Subpart C
§15.247

§ 15.247 (d)

Spurious RF Conducted Emissions

The measurement was performed according to ANSI C63.10

Final Result

OP-Mode

Radio Technology, Operating Frequency
Bluetooth EDR 3, mid

Setup

S01_AB01

FCC

Passed

IC

Passed

47 CFR CHAPTER I FCC PART 15 Subpart C
§15.247

§ 15.247 (d)

Transmitter Spurious Radiated Emissions

The measurement was performed according to ANSI C63.10

Final Result

OP-Mode

Radio Technology, Operating Frequency, Measurement range

Bluetooth BDR, high, 1 GHz - 26 GHz

Setup

S01_AA01

FCC

Passed

IC

Passed

Bluetooth BDR, high, 30 MHz - 1 GHz

S01_AA01

Passed

Passed

Bluetooth BDR, low, 1 GHz - 26 GHz

S01_AA01

Passed

Passed

Bluetooth BDR, low, 30 MHz - 1 GHz

S01_AA01

Passed

Passed

Bluetooth BDR, mid, 1 GHz - 26 GHz

S01_AA01

Passed

Passed

Bluetooth BDR, mid, 30 MHz - 1 GHz

S01_AA01

Passed

Passed

Bluetooth BDR, mid, 9 kHz - 30 MHz

S01_AA01

Passed

Passed

Bluetooth EDR 2, high, 1 GHz - 26 GHz

S01_AA01

Passed

Passed

Remark: 1-8GHz

Bluetooth EDR 2, low, 1 GHz - 26 GHz

S01_AA01

Passed

Passed

Remark: 1-8GHz

Bluetooth EDR 2, mid, 1 GHz - 26 GHz

S01_AA01

Passed

Passed

Remark: 1-8GHz

47 CFR CHAPTER I FCC PART 15 Subpart C
§15.247

§ 15.247 (d)

Band Edge Compliance Conducted

The measurement was performed according to ANSI C63.10

Final Result

OP-Mode

Radio Technology, Operating Frequency, Band Edge

Bluetooth BDR, high, high

Setup

S01_AB01

FCC

Passed

IC

Passed

Bluetooth BDR, hopping, high

S01_AB01

Passed

Passed

Bluetooth BDR, hopping, low

S01_AB01

Passed

Passed

Bluetooth BDR, low, low

S01_AB01

Passed

Passed

Bluetooth EDR 2, high, high

S01_AB01

Passed

Passed

Bluetooth EDR 2, hopping, high

S01_AB01

Passed

Passed

Bluetooth EDR 2, hopping, low

S01_AB01

Passed

Passed

Bluetooth EDR 2, low, low

S01_AB01

Passed

Passed

Bluetooth EDR 3, high, high

S01_AB01

Passed

Passed

Bluetooth EDR 3, hopping, high

S01_AB01

Passed

Passed

Bluetooth EDR 3, hopping, low

S01_AB01

Passed

Passed

Bluetooth EDR 3, low, low

S01_AB01

Passed

Passed

**47 CFR CHAPTER I FCC PART 15 Subpart C
§15.247**

§ 15.247 (d)

Band Edge Compliance Radiated
The measurement was performed according to ANSI C63.10

OP-Mode	Setup	FCC	IC
Radio Technology, Operating Frequency, Band Edge			
Bluetooth BDR, high, high	S01_AA01	Passed	Passed
Bluetooth EDR 2, high, high	S01_AA01	Passed	Passed
Bluetooth EDR 3, high, high	S01_AA01	Passed	Passed

**47 CFR CHAPTER I FCC PART 15 Subpart C
§15.247**

§ 15.247 (a) (1)

Channel Separation
The measurement was performed according to ANSI C63.10

OP-Mode	Setup	FCC	IC
Radio Technology			
Bluetooth BDR	S01_AB01	Passed	Passed

**47 CFR CHAPTER I FCC PART 15 Subpart C
§15.247**

§ 15.247 (a) (1) (iii)

Dwell Time
The measurement was performed according to ANSI C63.10

OP-Mode	Setup	FCC	IC
Radio Technology			
Bluetooth BDR	S01_AB01	Passed	Passed

**47 CFR CHAPTER I FCC PART 15 Subpart C
§15.247**

§ 15.247 (a) (1) (iii)

Number of Hopping Frequencies
The measurement was performed according to ANSI C63.10

OP-Mode	Setup	FCC	IC
Radio Technology			
Bluetooth BDR	S01_AB01	Passed	Passed

N/A: Not applicable
N/P: Not performed



7 layers GmbH, Borsigstr. 11
40880 Ratingen, Germany
Phone +49 (0)2102 749 0

M. Kullik

(responsible for accreditation scope)
Dipl.-Ing. Marco Kullik

D. Gall

(responsible for testing and report)
Dipl.-Ing. Daniel Gall

2 ADMINISTRATIVE DATA

2.1 TESTING LABORATORY

Company Name: 7layers GmbH
Address: Borsigstr. 11
40880 Ratingen
Germany

This facility has been fully described in a report submitted to the ISED and accepted under the registration number: Site# 3699A-1.

The test facility is also accredited by the following accreditation organisation:

Laboratory accreditation no: DAKKS D-PL-12140-01-00
FCC Designation Number: DE0015
FCC Test Firm Registration #: 929146
Responsible for accreditation scope: Dipl.-Ing. Marco Kullik
Report Template Version: 2017-12-19

2.2 PROJECT DATA

Responsible for testing and report: Dipl.-Ing. Daniel Gall
Employees who performed the tests: documented internally at 7Layers
Date of Report: 2018-01-04
Testing Period: 2017-12-11 to 2017-12-14

2.3 APPLICANT DATA

Company Name: Robert Bosch LLC
Address: 38000 Hills Tech Drive
Farmington Hills
USA
Contact Person: Nicolai Muellendorff

2.4 MANUFACTURER DATA

Company Name: Please see applicant data

3 TEST OBJECT DATA

3.1 GENERAL EUT DESCRIPTION

Kind of Device product description	Instrument Cluster
Product name	VIPHI2BT
Type	BRP VIP Cluster
Declared EUT data by the supplier	
Voltage Type	DC (vehicular battery)
Voltage Level	7.0V – 16.0V, tested with 14.0V
Tested Modulation Type	GFSK Modulation, 1-DHx packets π/4 DQPSK Modulation, 2-DHx packets 8-DPSK Modulation, 3-DHx packets
General product description	The EUT is an instrument cluster for vehicles. It is supplied by the vehicle power supply. It contains two wireless modules: <ul style="list-style-type: none"> • ALPS module UGKZ7A1001A [BT & WIFI]. The WLAN functionality of this module is deactivated • ALPS module UGXZEX304A
Antenna	Integral Gain: for module UGXZEX304A [BT]: -0.5 dBi for module UGKZ7A1001A [BT & WIFI]: 4.5 dBi
The EUT provides the following ports:	DC Power supply CAN bus
Tested data rates	1 Mbps, 2 Mbps, 3 Mbps
Special software used for testing	DiagTool III [Robert Bosch, Car Multimedia]

The main components of the EUT are listed and described in chapter 3.2 EUT Main components.

3.2 EUT MAIN COMPONENTS

Sample Name	Sample Code	Description
DE1050013aa01	aa01	Radiated Sample
Sample Parameter	Value	
Serial No.	48F07B6831A1	
HW Version	7953g06	
SW Version	SW 9.2	
Integral Antenna(s)	[UGKZ7A1001A]4.5 dBi / [UGXZEX304A]-0.5 dBi	
Comment		

Sample Name	Sample Code	Description
DE1050013ab01	ab01	Conducted Sample
Sample Parameter	Value	
Serial No.	48F07B58319D	
HW Version	7953g06	
SW Version	SW 9.2	
Integral Antenna(s)	deactivated	
Comment		

NOTE: The short description is used to simplify the identification of the EUT in this test report.

3.3 ANCILLARY EQUIPMENT

For the purposes of this test report, ancillary equipment is defined as equipment which is used in conjunction with the EUT to provide operational and control features to the EUT. It is necessary to configure the system in a typical fashion, as a customer would normally use it. But nevertheless Ancillary Equipment can influence the test results.

Device	Details (Manufacturer, Type Model, OUT Code)	Description
-	-	-

3.4 AUXILIARY EQUIPMENT

For the purposes of this test report, auxiliary equipment is defined as equipment which is used temporarily to enable operational and control features especially used for the tests of the EUT which is not used during normal operation or equipment that is used during the tests in combination with the EUT but is not subject of this test report. It is necessary to configure the system in a typical fashion, as a customer would normally use it. But nevertheless Auxiliary Equipment can influence the test results.

Device	Details (Manufacturer, HW, SW, S/N)	Description
-	-	-

3.5 EUT SETUPS

This chapter describes the combination of EUTs and equipment used for testing. The rationale for selecting the EUTs, ancillary and auxiliary equipment and interconnecting cables, is to test a representative configuration meeting the requirements of the referenced standards.

Setup	Combination of EUTs	Description and Rationale
S01_AB01	DE1050013ab01	Conducted Setup
S01_AA01	DE1050013aa01	Radiated Setup

3.6 OPERATING MODES

This chapter describes the operating modes of the EUTs used for testing.

3.6.1 TEST CHANNELS

BT Test Channels:
Channel:
Frequency [MHz]

2.4 GHz ISM 2400 - 2483.5 MHz		
low	mid	high
0	39	78
2402	2441	2480

3.7 PRODUCT LABELLING

3.7.1 FCC ID LABEL

Please refer to the documentation of the applicant.

3.7.2 LOCATION OF THE LABEL ON THE EUT

Please refer to the documentation of the applicant.

4 TEST RESULTS

4.1 OCCUPIED BANDWIDTH (20 DB)

Standard **FCC Part 15 Subpart C**

The test was performed according to:
ANSI C63.10

4.1.1 TEST DESCRIPTION

The Equipment Under Test (EUT) was set up to perform the occupied bandwidth measurements.

The reference level is the level of the highest amplitude signal observed from the transmitter at either the fundamental frequency or first-order modulation products in all typical modes of operation, including the unmodulated carrier, even if atypical.

The results recorded were measured with the modulation which produce the worst-case (widest) emission bandwidth.

The EUT was connected to spectrum analyzer via a short coax cable with a known loss.

Analyzer settings:

- Resolution Bandwidth (RBW): 1% to 5 % of the OBW
- Video Bandwidth (VBW): $\geq 3 \times$ RBW
- Span: 2 to 5 times the OBW
- Trace: Maxhold
- Sweeps: 2000
- Sweeptime: 8.5 ms
- Detector: Peak

The technology depending measurement parameters can be found in the measurement plot.

4.1.2 TEST REQUIREMENTS / LIMITS

FCC Part 15, Subpart C, §15.247 (a) (2)

For the band: 902 – 928 MHz

FCC Part 15, Subpart C, §15.247 (a) (1) (i)

The maximum allowed 20 dB bandwidth of the hopping channel is 500 kHz

For the band: 5725 – 5850 MHz

FCC Part 15, Subpart C, §15.247 (a) (1) (ii)

The maximum allowed 20 dB bandwidth of the hopping channel is 1 MHz

For the frequency band 2400 – 2483.5 MHz:

FCC Part 15, Subpart C, §15.247 (a) (1) (iii)

Frequency hopping systems shall have hopping channel carrier frequencies separated by a minimum of 25 kHz or the 20 dB bandwidth of the hopping channel, whichever is greater. Alternatively, frequency hopping systems operating in the 2400–2483.5 MHz band may have hopping channel carrier frequencies that are separated by 25 kHz or two-thirds of the 20 dB bandwidth of the hopping channel, whichever is greater, provided the systems operate with an output power no greater than 125 mW. The system shall hop to channel frequencies that are selected at the system hopping rate from a pseudo randomly ordered list of hopping frequencies. Each frequency must be used equally on the average by each transmitter. The system receivers shall have input bandwidths that match the hopping channel bandwidths of their corresponding transmitters and shall shift frequencies in synchronization with the transmitted signals.

Implication by the test laboratory:

Since the Bluetooth technology defines a fixed channel separation of 1 MHz this design parameter defines the maximum allowed occupied bandwidth depending on the EUT's output power:

1. Under the provision that the system operates with an output power not greater than 125 mW (21.0 dBm):

Implicit Limit: Max. 20 dB BW = 1.0 MHz / 2/3 = 1.5 MHz

2. If the system output power exceeds 125 mW (21.0 dBm):

Implicit Limit: Max. 20 dB BW = 1.0 MHz

Used conversion factor: Output power (dBm) = 10 log (Output power (W) / 1mW)

The measured output power of the system is below 125 mW (21.0 dBm). For the results, please refer to the related chapter of this report.

Therefore the limit is determined as 1.5 MHz.

4.1.3 TEST PROTOCOL

Module: UGXZEX304A

Ambient temperature: 22°C
 Air Pressure: 1010hPa
 Humidity: 38%
 BT GFSK (1-DH1)

Band	Channel No.	Frequency [MHz]	20 dB Bandwidth [MHz]	Limit [MHz]	Margin to Limit [MHz]
2.4 GHz ISM	0	2402	0.896	1.000	0.104
	39	2441	0.896	1.000	0.104
	78	2480	0.890	1.000	0.110

BT n/4 DQPSK (2-DH1)

Band	Channel No.	Frequency [MHz]	20 dB Bandwidth [MHz]	Limit [MHz]	Margin to Limit [MHz]
2.4 GHz ISM	0	2402	1.221	1.500	0.279
	39	2441	1.221	1.500	0.279
	78	2480	1.221	1.500	0.279

BT 8-DPSK (3-DH1)

Band	Channel No.	Frequency [MHz]	20 dB Bandwidth [MHz]	Limit [MHz]	Margin to Limit [MHz]
2.4 GHz ISM	0	2402	1.269	1.500	0.231
	39	2441	1.257	1.500	0.243
	78	2480	1.251	1.500	0.249

Module:
UGKZ7A1001A

Ambient temperature: 22 °C
 Air Pressure: 1010 hPa
 Humidity: 34 %
 BT GFSK (1-DH1)

Band	Channel No.	Frequency [MHz]	20 dB Bandwidth [MHz]	Limit [MHz]	Margin to Limit [MHz]
2.4 GHz ISM	0	2402	0.896	1.000	0.104
	39	2441	0.896	1.000	0.104
	78	2480	0.890	1.000	0.110

BT π/4 DQPSK (2-DH1)

Band	Channel No.	Frequency [MHz]	20 dB Bandwidth [MHz]	Limit [MHz]	Margin to Limit [MHz]
2.4 GHz ISM	0	2402	1.257	1.500	0.243
	39	2441	1.257	1.500	0.243
	78	2480	1.257	1.500	0.243

BT 8-DPSK (3-DH1)

Band	Channel No.	Frequency [MHz]	20 dB Bandwidth [MHz]	Limit [MHz]	Margin to Limit [MHz]
2.4 GHz ISM	0	2402	1.269	1.500	0.231
	39	2441	1.269	1.500	0.231
	78	2480	1.269	1.500	0.231

Remark: Please see next sub-clause for the measurement plot.

4.1.4 MEASUREMENT PLOT (SHOWING THE HIGHEST VALUE, "WORST CASE")
 Module: UGXZEX304A

Radio Technology = Bluetooth BDR, Operating Frequency = low
 (S01_AB01)

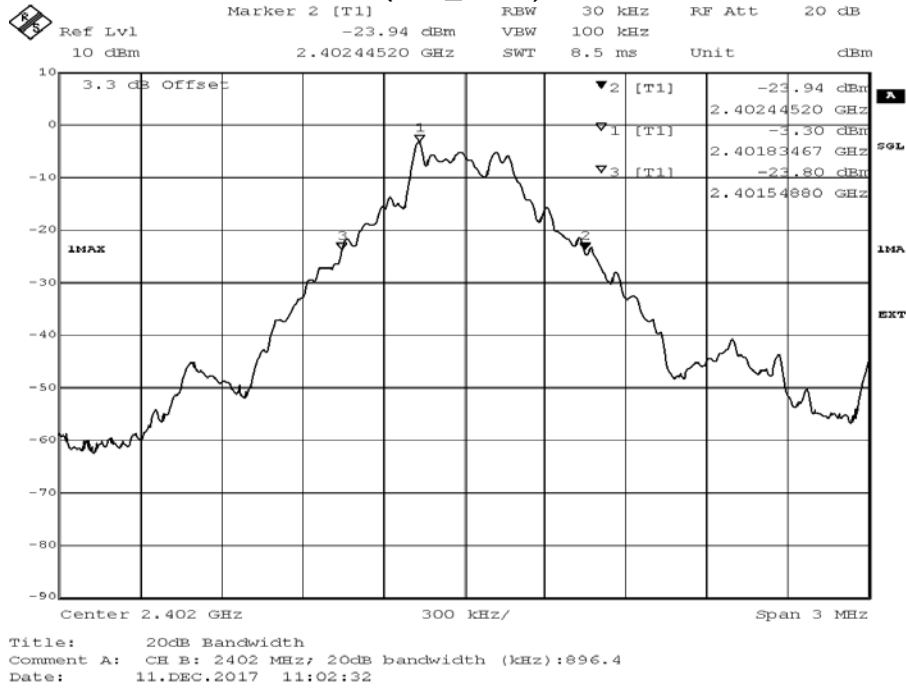

Radio Technology = Bluetooth BDR, Operating Frequency = mid
 (S01_AB01)

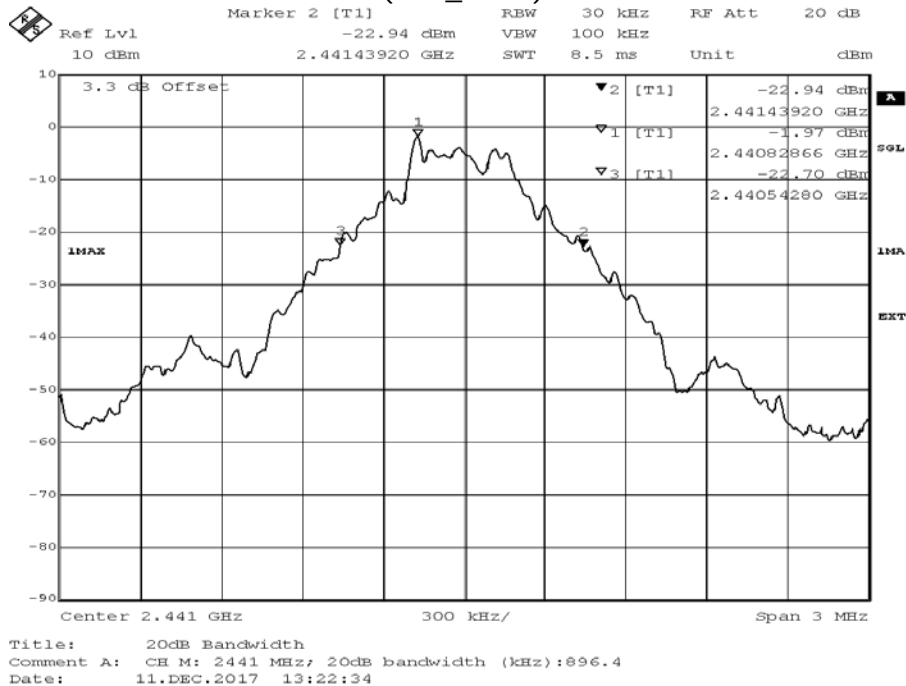

Radio Technology = Bluetooth BDR, Operating Frequency = high
(S01_AB01)

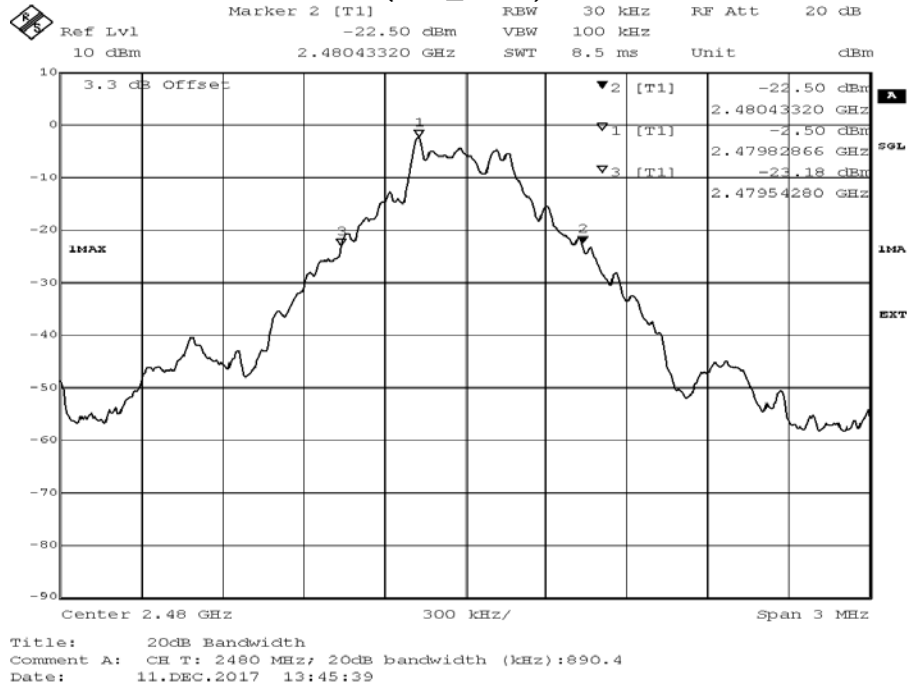

Radio Technology = Bluetooth EDR 2, Operating Frequency = low
(S01_AB01)

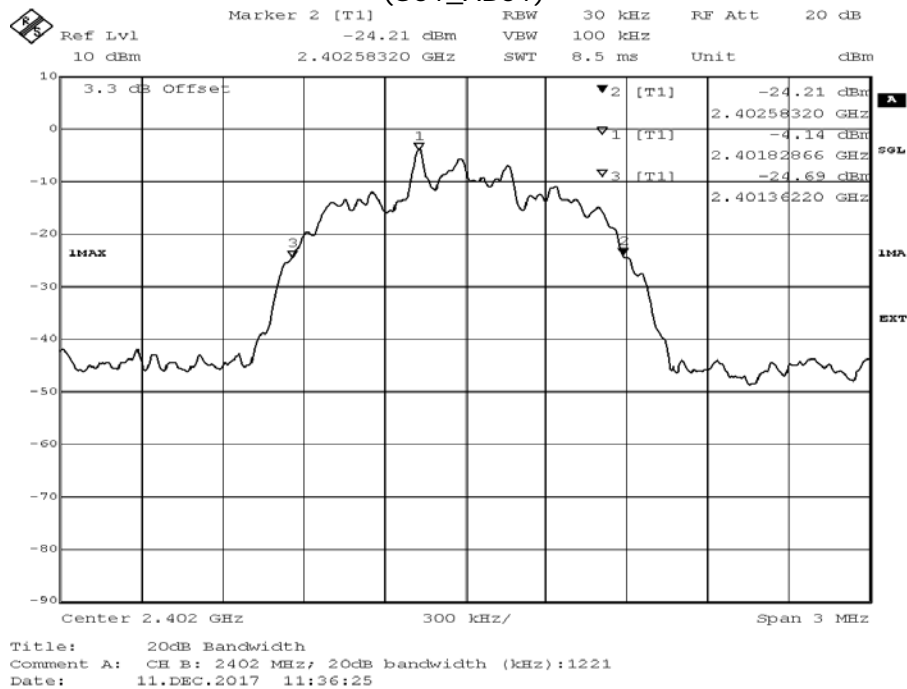

Radio Technology = Bluetooth EDR 2, Operating Frequency = mid (S01_AB01)

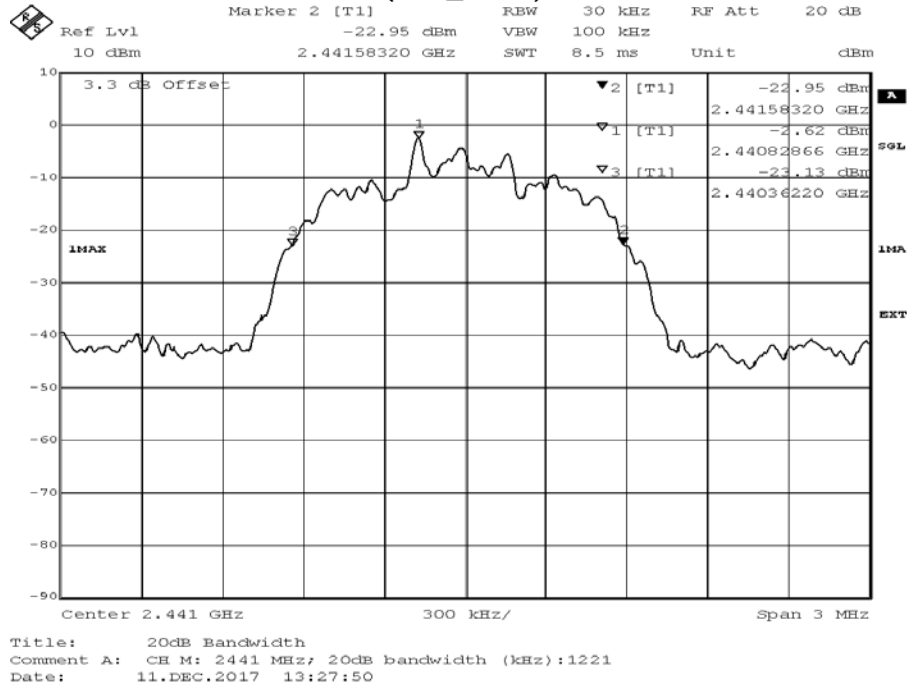

Radio Technology = Bluetooth EDR 2, Operating Frequency = high (S01_AB01)

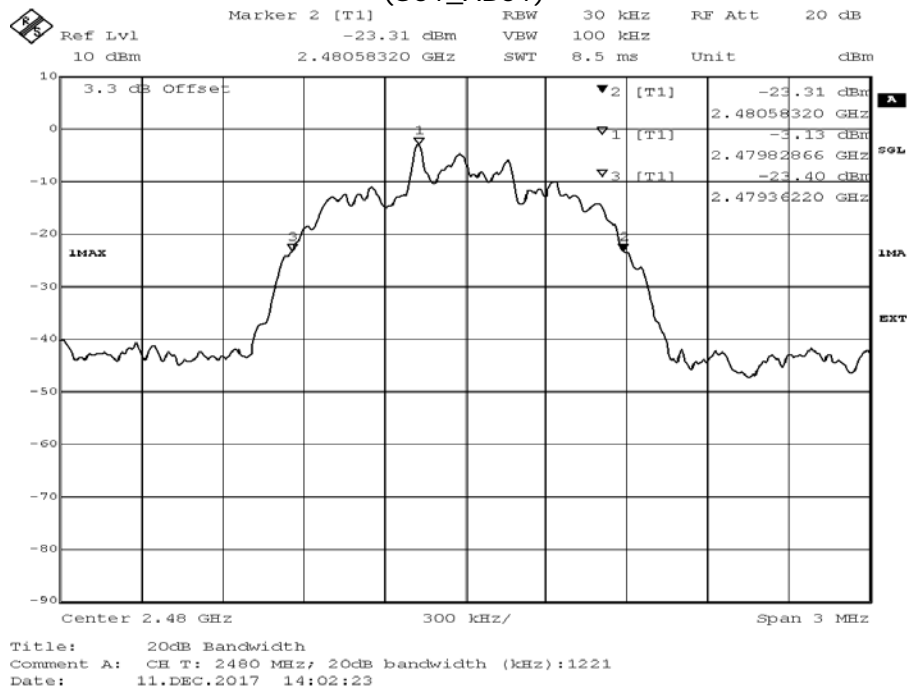

Radio Technology = Bluetooth EDR 3, Operating Frequency = low
(S01_AB01)

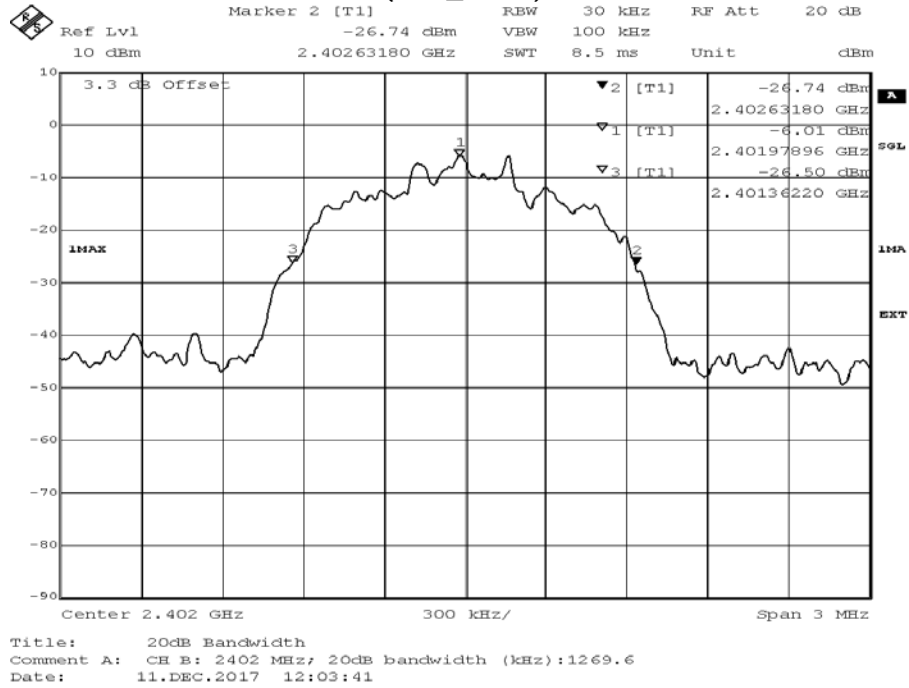

Radio Technology = Bluetooth EDR 3, Operating Frequency = mid
(S01_AB01)

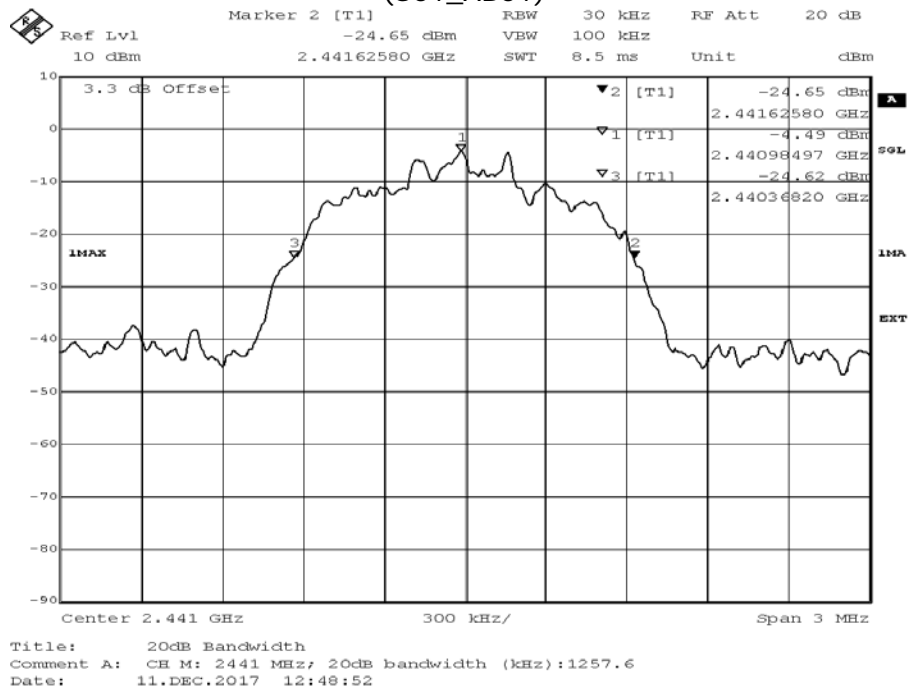

Radio Technology = Bluetooth EDR 3, Operating Frequency = high
(S01_AB01)

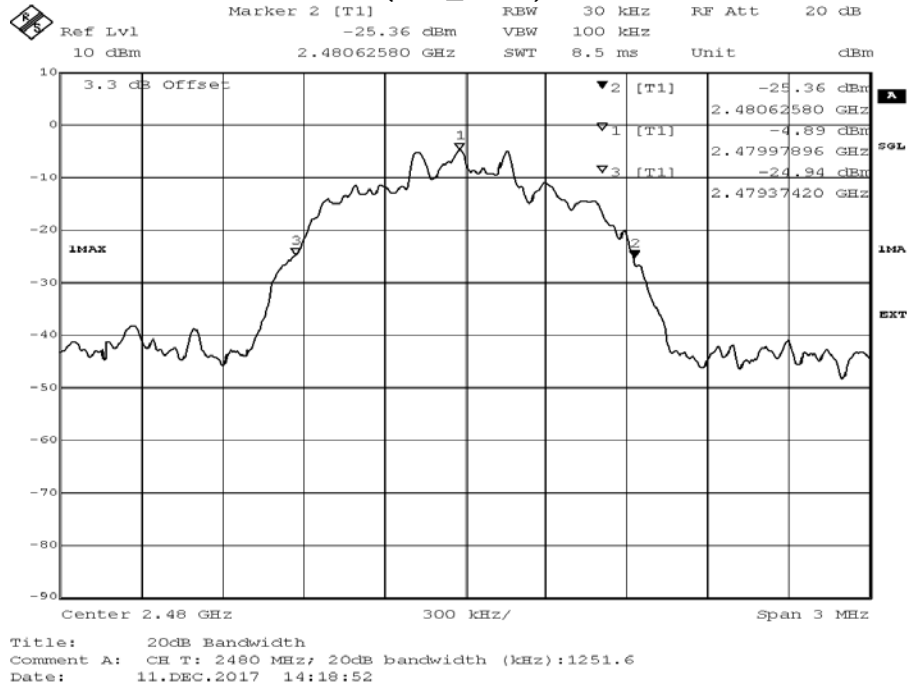

Module: UGKZ7A1001A

Radio Technology = Bluetooth BDR, Operating Frequency = low
(S01_AB01)

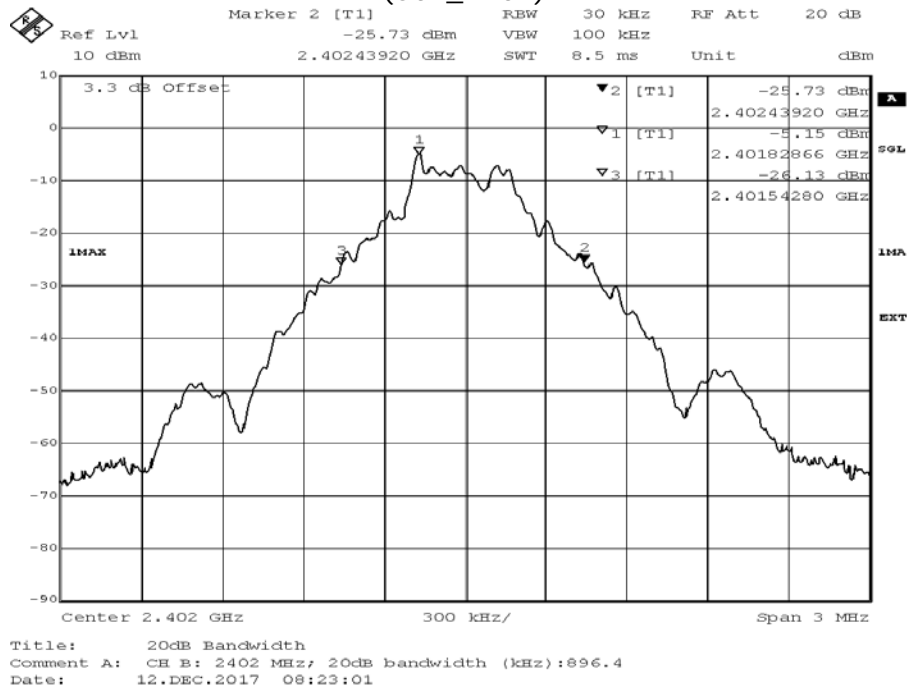

Radio Technology = Bluetooth BDR, Operating Frequency = mid
(S01_AB01)

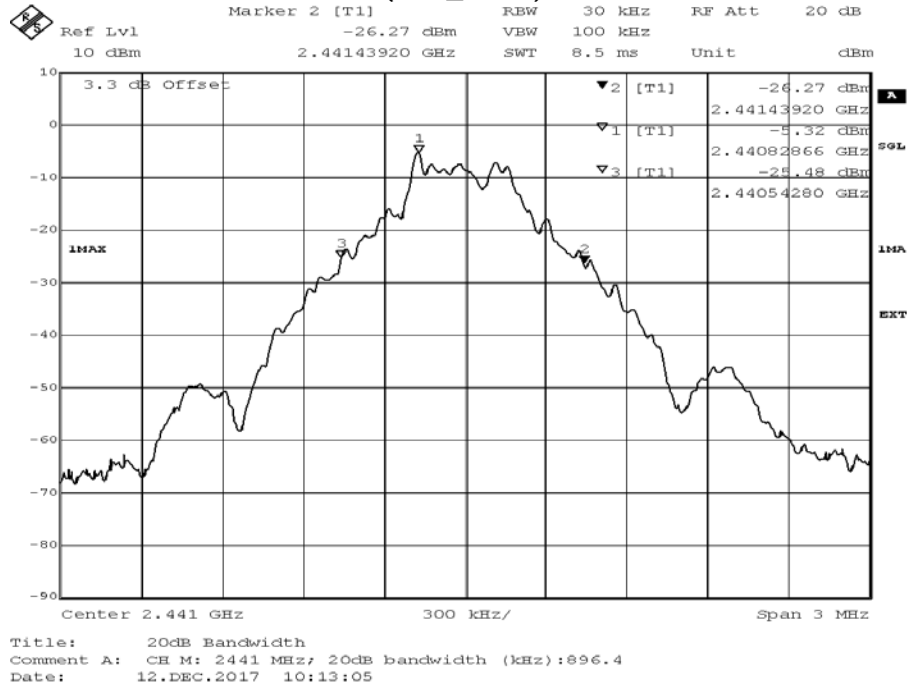

Radio Technology = Bluetooth BDR, Operating Frequency = high
(S01_AB01)

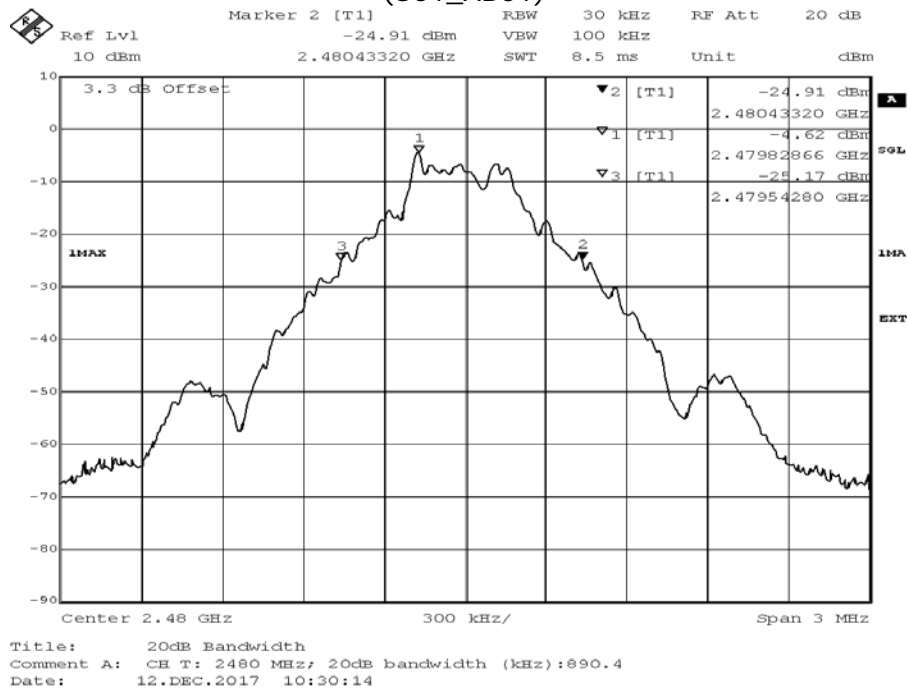

Radio Technology = Bluetooth EDR 2, Operating Frequency = low
(S01_AB01)

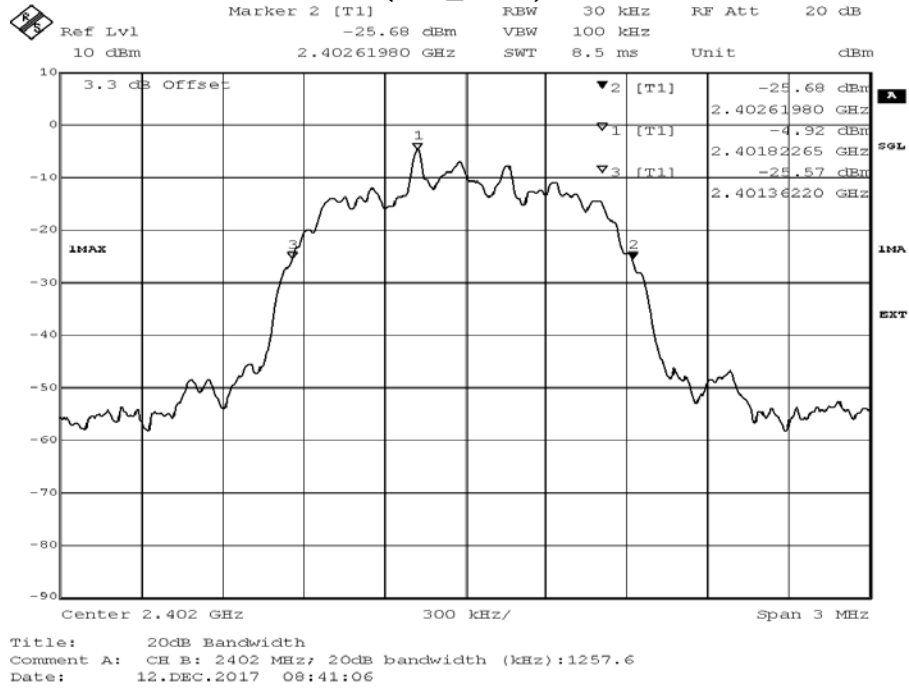

Radio Technology = Bluetooth EDR 2, Operating Frequency = mid
(S01_AB01)

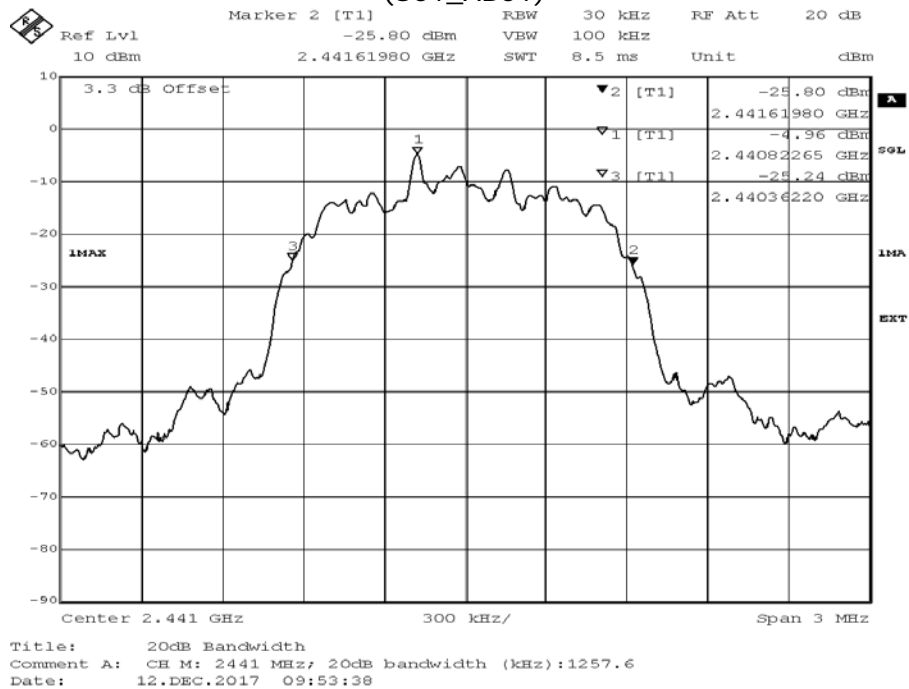

Radio Technology = Bluetooth EDR 2, Operating Frequency = high
(S01_AB01)

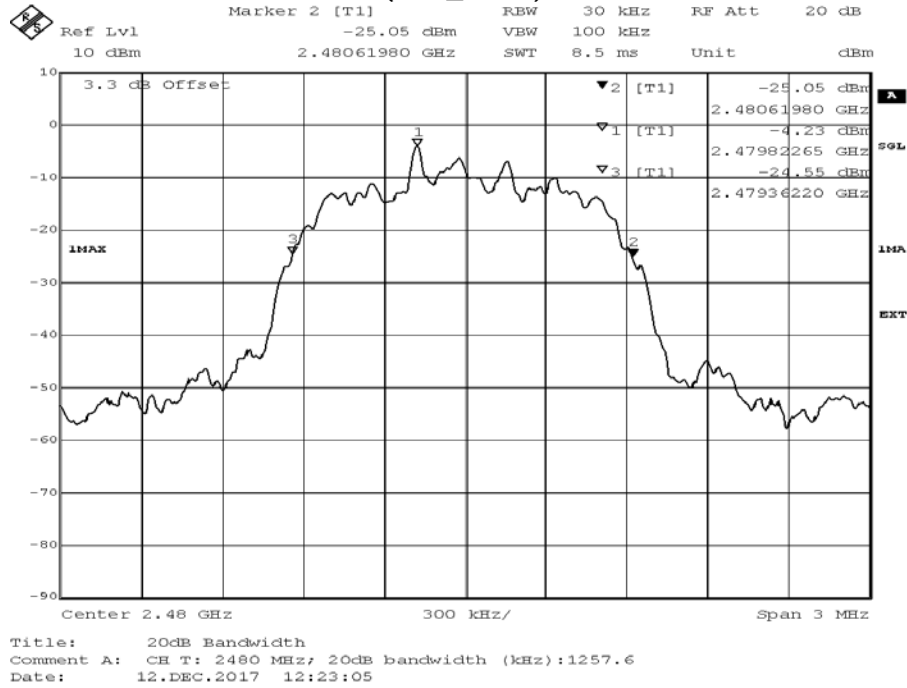

Radio Technology = Bluetooth EDR 3, Operating Frequency = low
(S01_AB01)

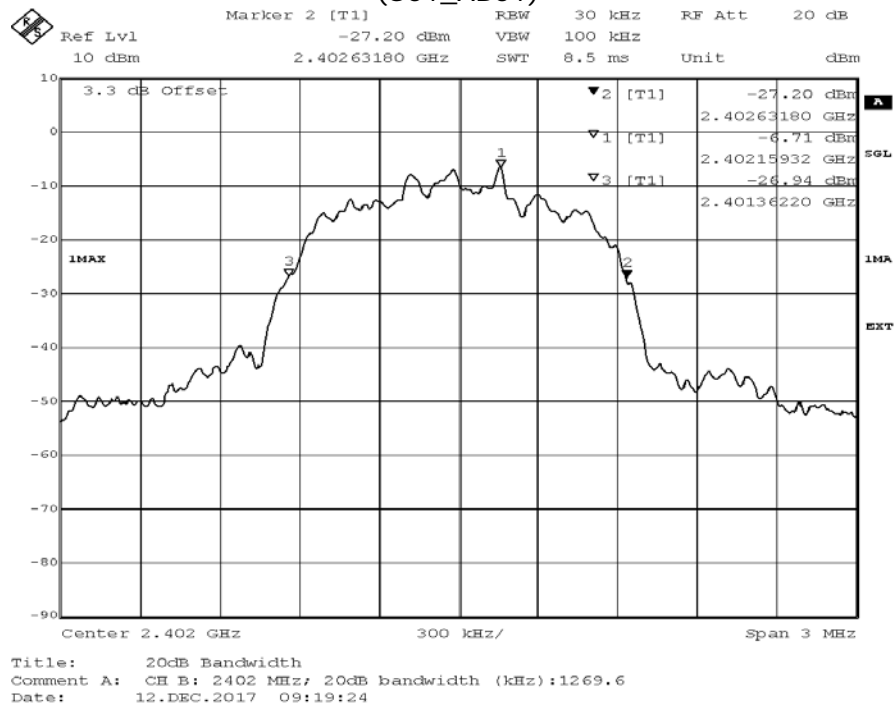

Radio Technology = Bluetooth EDR 3, Operating Frequency = mid (S01_AB01)

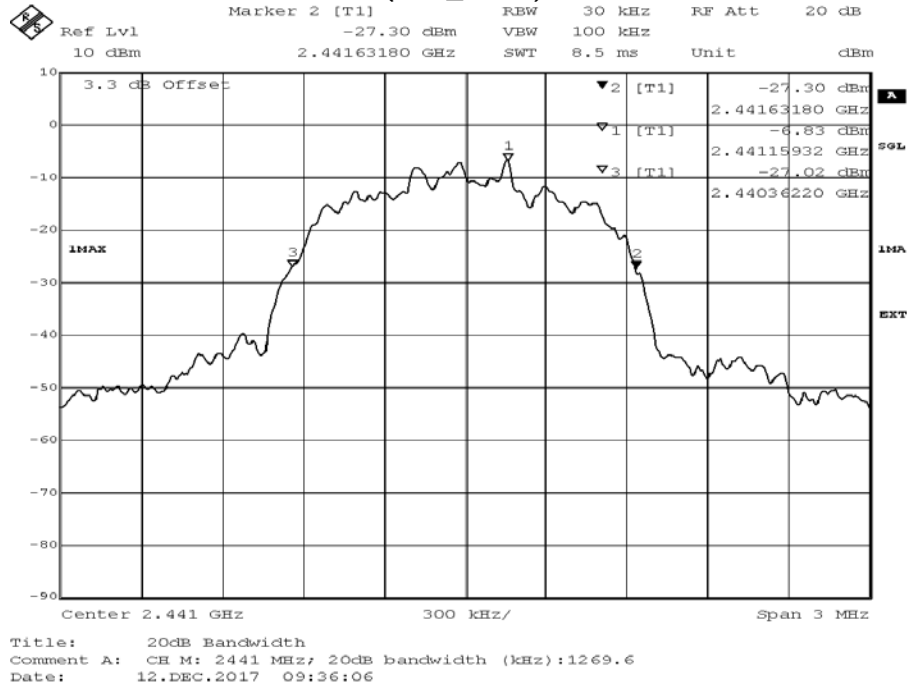

Radio Technology = Bluetooth EDR 3, Operating Frequency = high (S01_AB01)

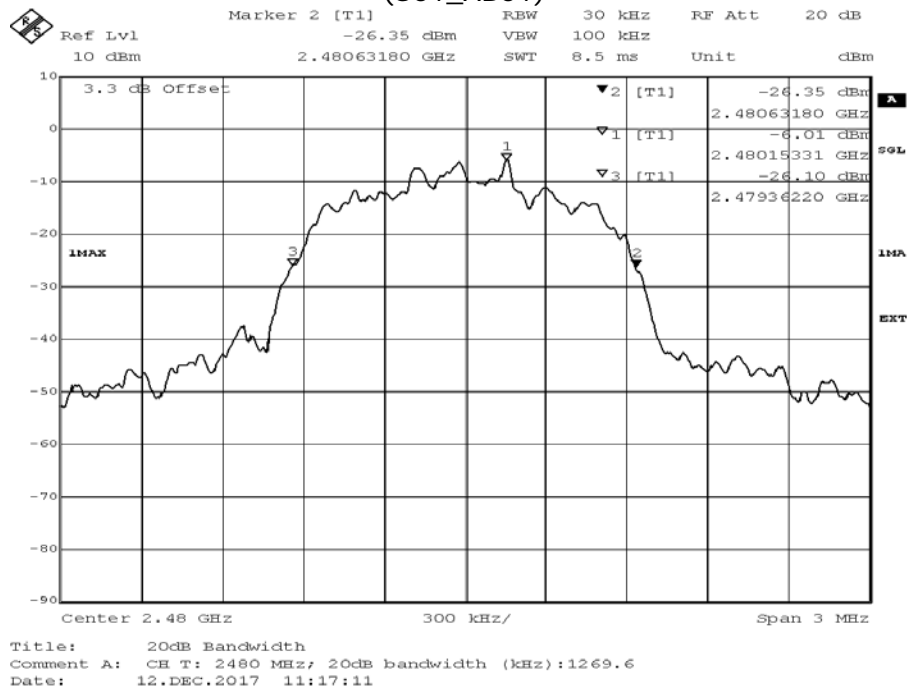

4.1.5 TEST EQUIPMENT USED

- Regulatory Bluetooth RF Test Solution

4.2 PEAK POWER OUTPUT

Standard **FCC Part 15 Subpart C**

The test was performed according to:
ANSI C63.10

4.2.1 TEST DESCRIPTION

DTS EQUIPMENT:

The Equipment Under Test (EUT) was set up to perform the output power measurements. The results recorded were measured with the modulation which produces the worst-case (highest) output power. The reference level of the spectrum analyzer was set higher than the output power of the EUT.

The EUT was connected to the spectrum analyzer via a short coax cable with a known loss.

Analyzer settings:

- Resolution Bandwidth (RBW): 3 MHz
- Video Bandwidth (VBW): 3 MHz
- Trace: Maxhold
- Sweeps: 2000
- Sweeptime: 5 ms
- Detector: Peak

The channel power function of the spectrum analyser was used (Used channel bandwidth = DTS bandwidth)

FHSS EQUIPMENT:

The Equipment Under Test (EUT) was set up to perform the output power measurements. The results recorded were measured with the modulation which produces the worst-case (highest) output power. The reference level of the spectrum analyzer was set higher than the output power of the EUT.

The EUT was connected to the spectrum analyzer via a short coax cable with a known loss.

Analyzer settings:

- Resolution Bandwidth (RBW): 3 MHz
- Video Bandwidth (VBW): 3 MHz
- Trace: Maxhold
- Sweeps: 2000
- Sweeptime: 5 ms
- Detector: Peak

4.2.2 TEST REQUIREMENTS / LIMITS

DTS devices:

FCC Part 15, Subpart C, §15.247 (b) (3)

For systems using digital modulation techniques in the 902-928 MHz, 2400-2483.5 MHz and 5725-5850 MHz bands: 1 watt.

==> Maximum conducted peak output power: 30 dBm (excluding antenna gain, if antennas with directional gains that do not exceed 6 dBi are used).

Frequency Hopping Systems:

FCC Part 15, Subpart C, §15.247 (b) (1)

For frequency hopping systems operating in the 2400-2483.5 MHz band employing at least 75 non-overlapping hopping channels, and all frequency hopping systems in the 5725-5850 MHz band: 1 watt. For all other frequency hopping systems in the 2400-2483.5 MHz band: 0.125 watts.

FCC Part 15, Subpart C, §15.247 (b) (2)

For frequency hopping systems operating in the 902-928 MHz band: 1 watt for systems employing at least 50 hopping channels; and, 0.25 watts for systems employing less than 50 hopping channels, but at least 25 hopping channels, as permitted under paragraph (a)(1)(i) of this section.

Used conversion factor: Limit (dBm) = 10 log (Limit (W)/1mW)

4.2.3 TEST PROTOCOL

Module: UGXZEX304A

Ambient temperature: 22°C
 Air Pressure: 1010hPa
 Humidity: 38%
 BT GFSK (1-DH1)

Band	Channel No.	Frequency [MHz]	Peak Power [dBm]	Limit [dBm]	Margin to Limit [dB]
2.4 GHz ISM	0	2402	-2.3	30.0	32.3
	39	2441	-1.2	30.0	31.2
	78	2480	-1.7	30.0	31.7

BT π/4 DQPSK (2-DH1)

Band	Channel No.	Frequency [MHz]	Peak Power [dBm]	Limit [dBm]	Margin to Limit [dB]
2.4 GHz ISM	0	2402	-2.5	21.0	23.5
	39	2441	-1.1	21.0	22.1
	78	2480	-1.6	21.0	22.6

BT 8-DPSK (3-DH1)

Band	Channel No.	Frequency [MHz]	Peak Power [dBm]	Limit [dBm]	Margin to Limit [dB]
2.4 GHz ISM	0	2402	-2.2	21.0	23.2
	39	2441	-0.8	21.0	21.8
	78	2480	-1.2	21.0	22.2

Module: UGKZ7A1001A

Ambient temperature: 22 °C
 Air Pressure: 1010 hPa
 Humidity: 34 %
 BT GFSK (1-DH1)

Band	Channel No.	Frequency [MHz]	Peak Power [dBm]	Limit [dBm]	Margin to Limit [dB]
2.4 GHz ISM	0	2402	-4.4	30.0	34.4
	39	2441	-4.6	30.0	34.6
	78	2480	-3.9	30.0	33.9

BT π/4 DQPSK (2-DH1)

Band	Channel No.	Frequency [MHz]	Peak Power [dBm]	Limit [dBm]	Margin to Limit [dB]
2.4 GHz ISM	0	2402	-1.8	21.0	22.8
	39	2441	-2.0	21.0	23.0
	78	2480	-1.2	21.0	22.2

BT 8-DPSK (3-DH1)

Band	Channel No.	Frequency [MHz]	Peak Power [dBm]	Limit [dBm]	Margin to Limit [dB]
2.4 GHz ISM	0	2402	-1.5	21.0	22.5
	39	2441	-1.7	21.0	22.7
	78	2480	-0.8	21.0	21.8

Remark: Please see next sub-clause for the measurement plot.

4.2.4 MEASUREMENT PLOT (SHOWING THE HIGHEST VALUE, "WORST CASE")

Module: UGXZEX304A

Radio Technology = Bluetooth BDR, Operating Frequency = low, Measurement method = conducted

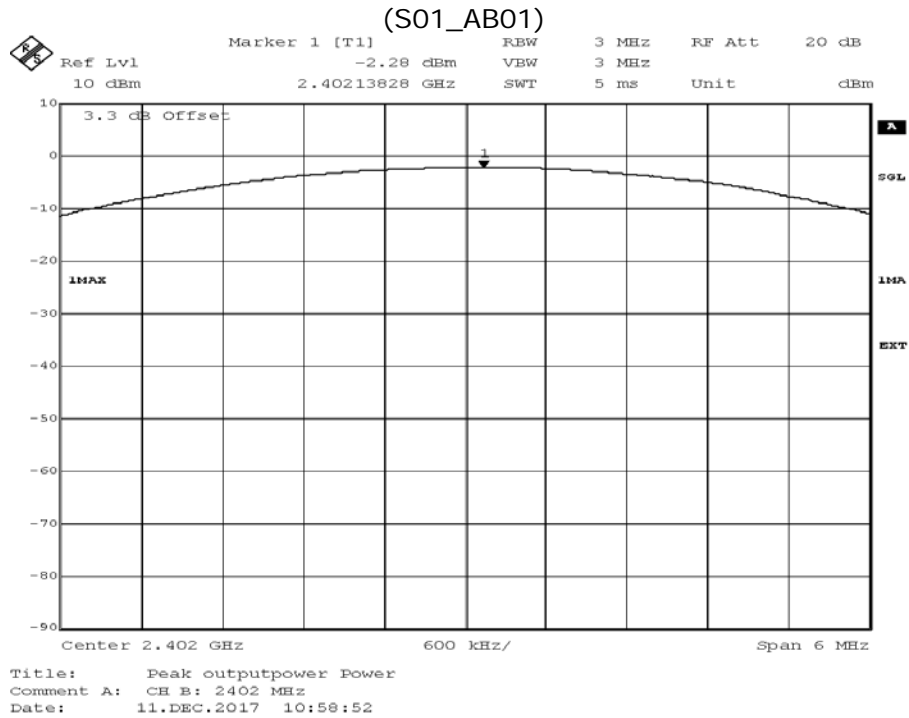

Radio Technology = Bluetooth BDR, Operating Frequency = mid, Measurement method = conducted

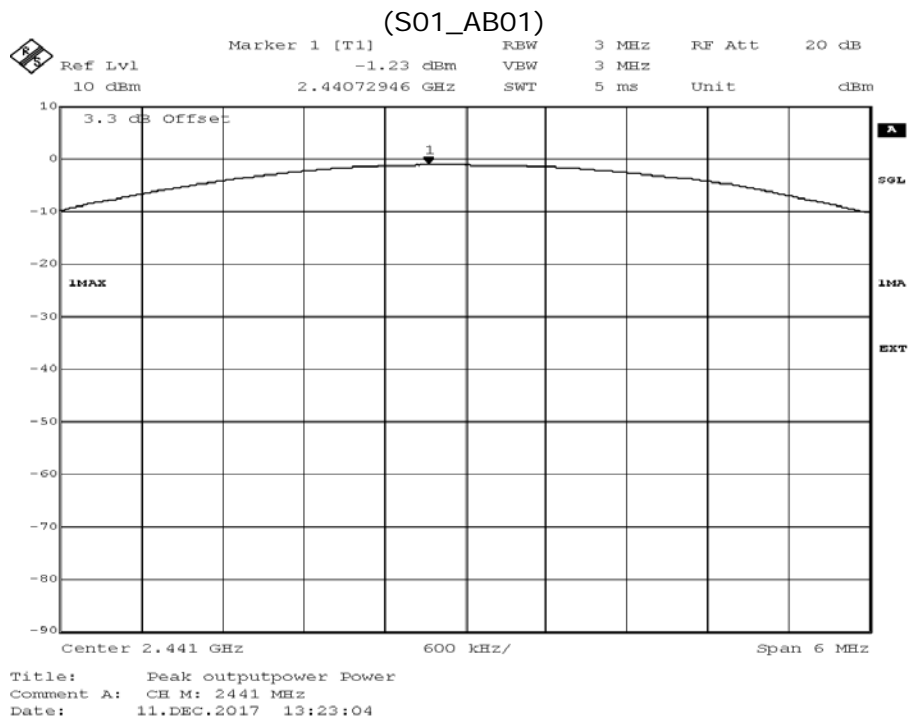

Radio Technology = Bluetooth BDR, Operating Frequency = high, Measurement method = conducted (S01_AB01)

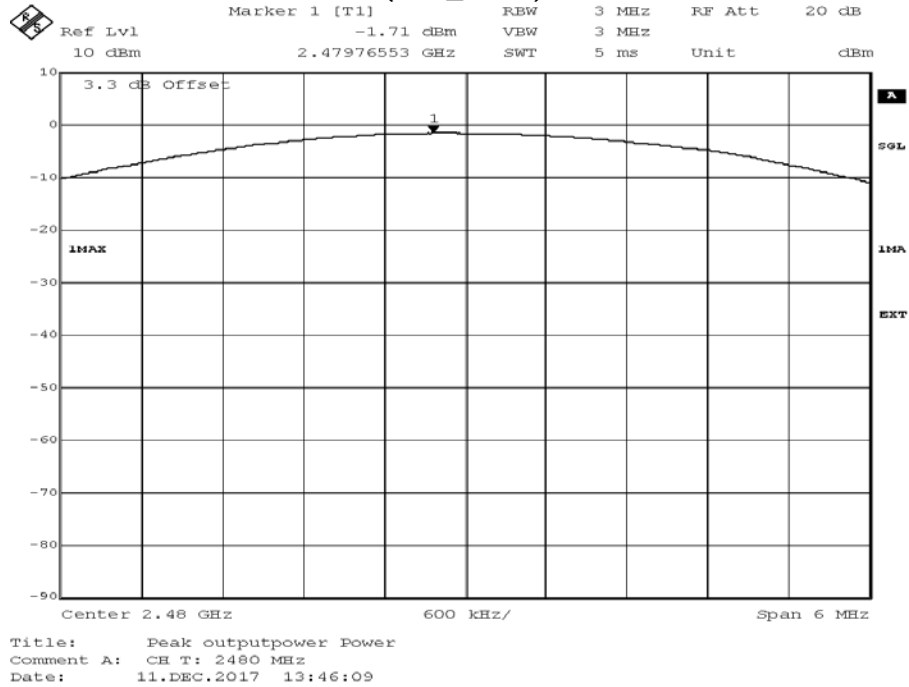

Radio Technology = Bluetooth EDR 2, Operating Frequency = low, Measurement method = conducted (S01_AB01)

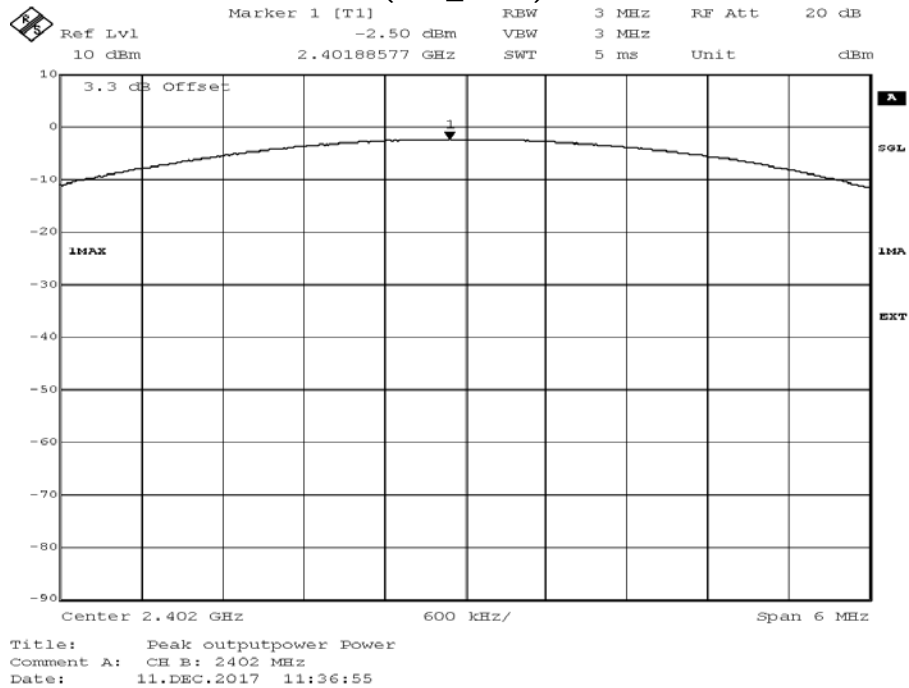

Radio Technology = Bluetooth EDR 2, Operating Frequency = mid, Measurement method = conducted (S01_AB01)

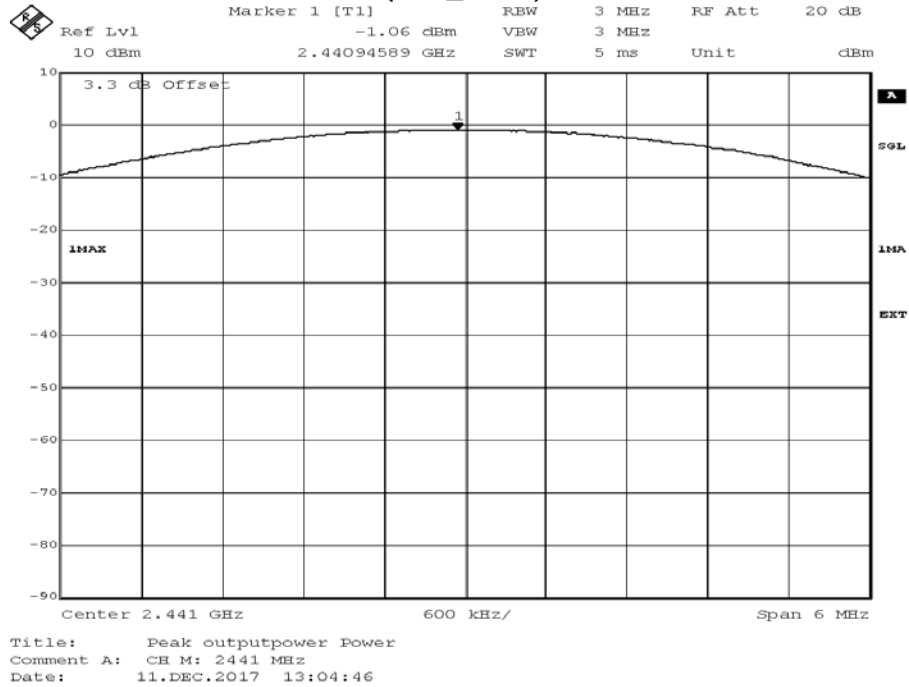

Radio Technology = Bluetooth EDR 2, Operating Frequency = high, Measurement method = conducted (S01_AB01)

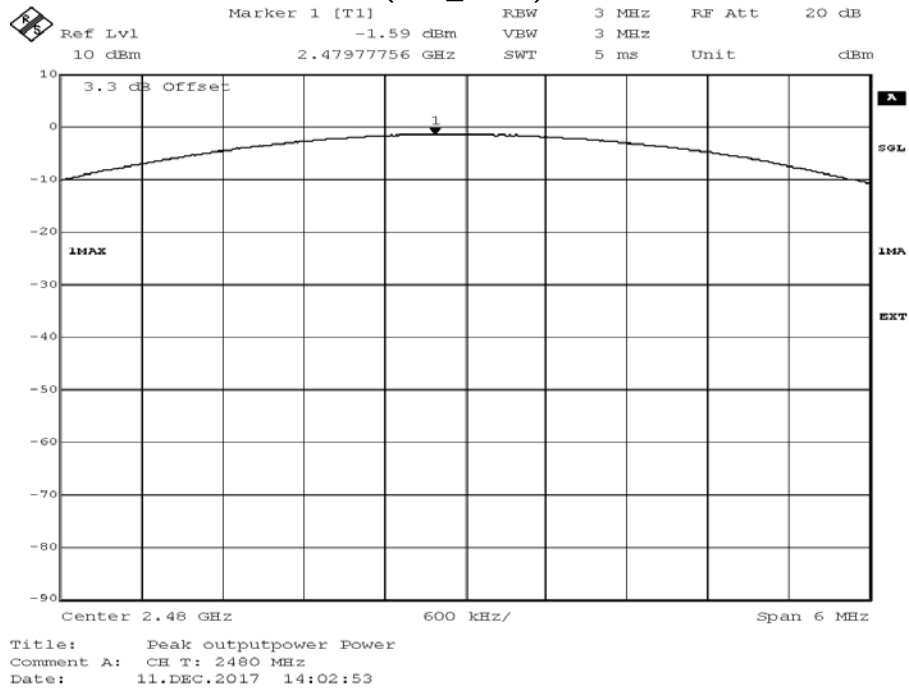

Radio Technology = Bluetooth EDR 3, Operating Frequency = low, Measurement method = conducted (S01_AB01)

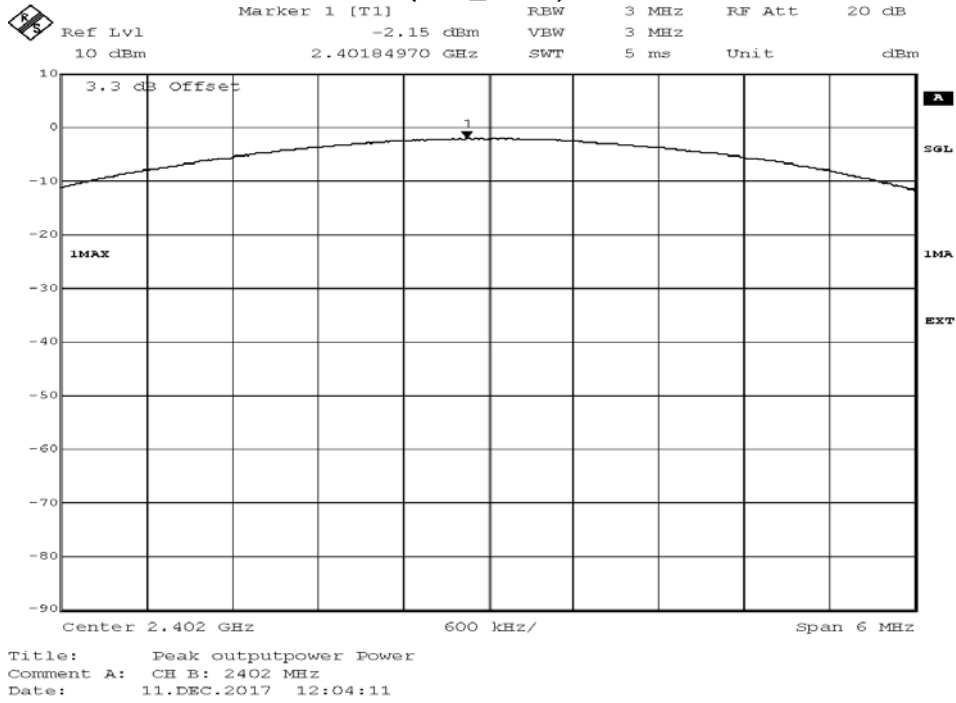

Radio Technology = Bluetooth EDR 3, Operating Frequency = mid, Measurement method = conducted (S01_AB01)

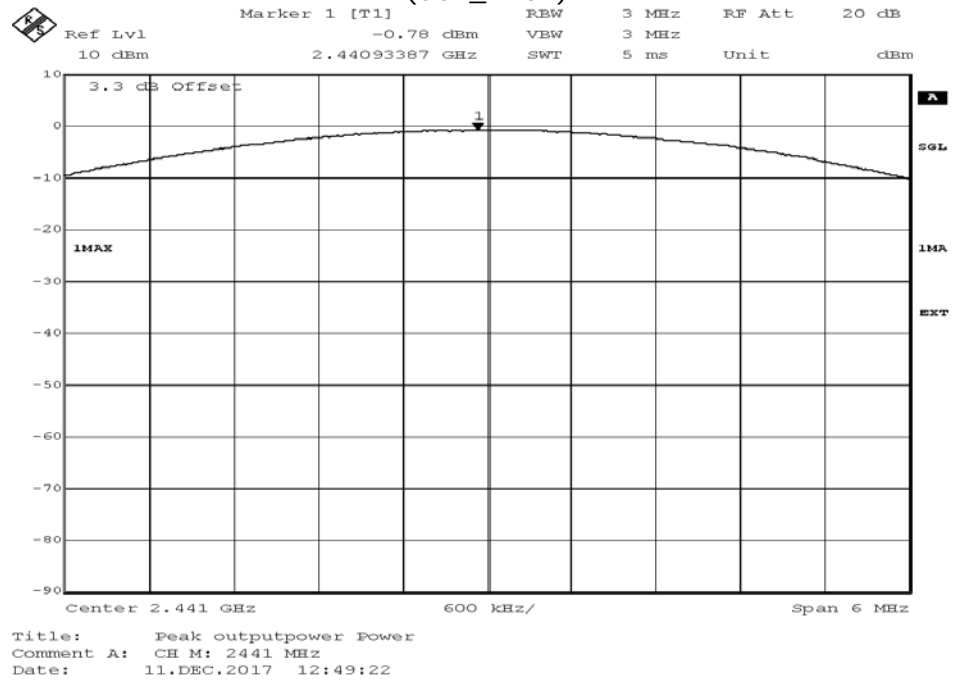

Radio Technology = Bluetooth EDR 3, Operating Frequency = high, Measurement method = conducted
(S01_AB01)

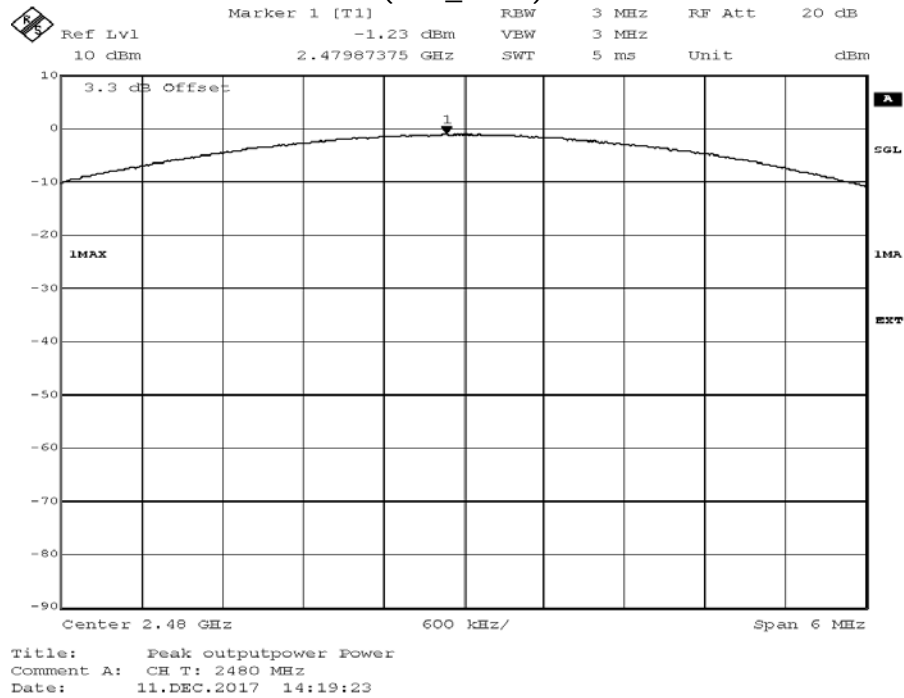

Module: UGKZ7A1001A

Radio Technology = Bluetooth BDR, Operating Frequency = low, Measurement method = conducted
(S01_AB01)

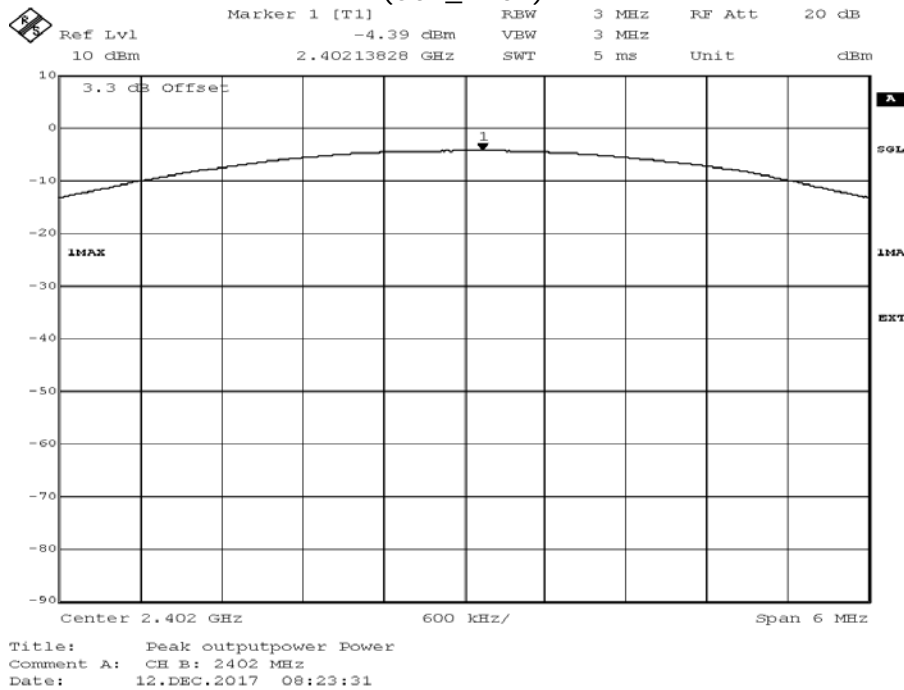

Radio Technology = Bluetooth BDR, Operating Frequency = mid, Measurement method = conducted (S01_AB01)

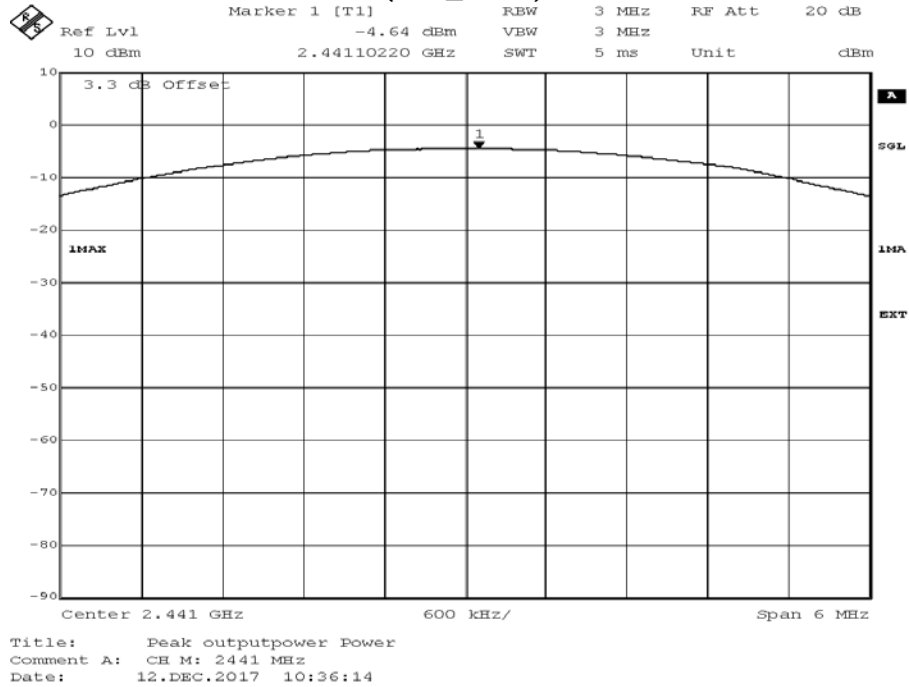

Radio Technology = Bluetooth BDR, Operating Frequency = high, Measurement method = conducted (S01_AB01)

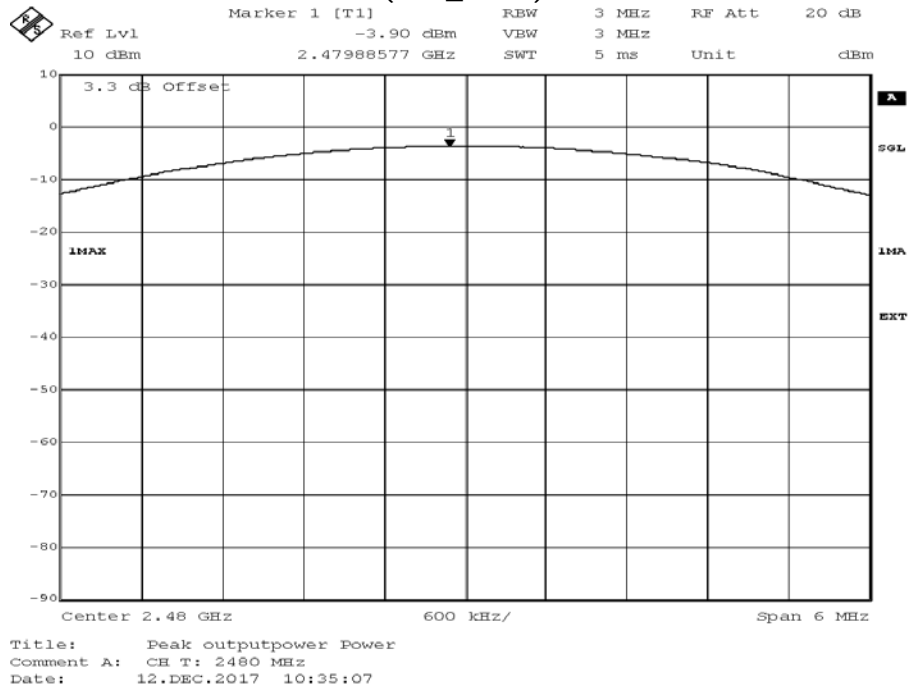

Radio Technology = Bluetooth EDR 2, Operating Frequency = low, Measurement method = conducted (S01_AB01)

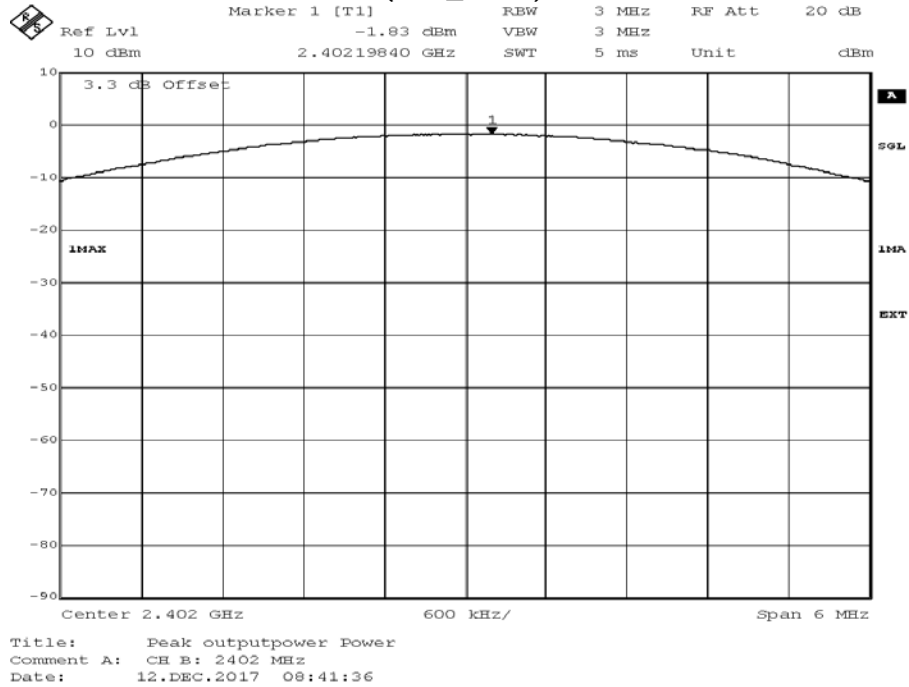

Radio Technology = Bluetooth EDR 2, Operating Frequency = mid, Measurement method = conducted (S01_AB01)

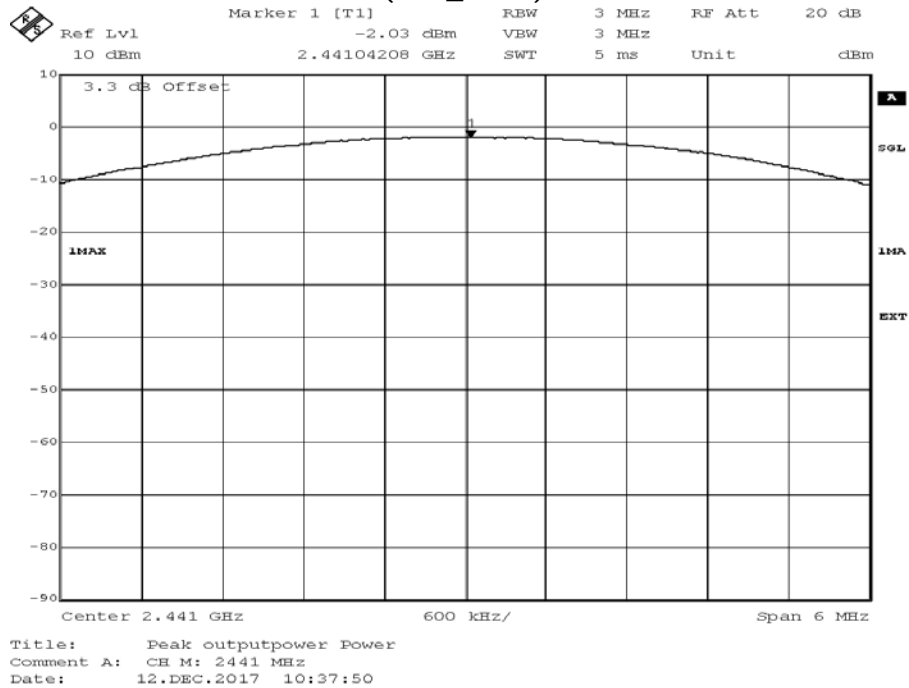

Radio Technology = Bluetooth EDR 2, Operating Frequency = high, Measurement method = conducted (S01_AB01)

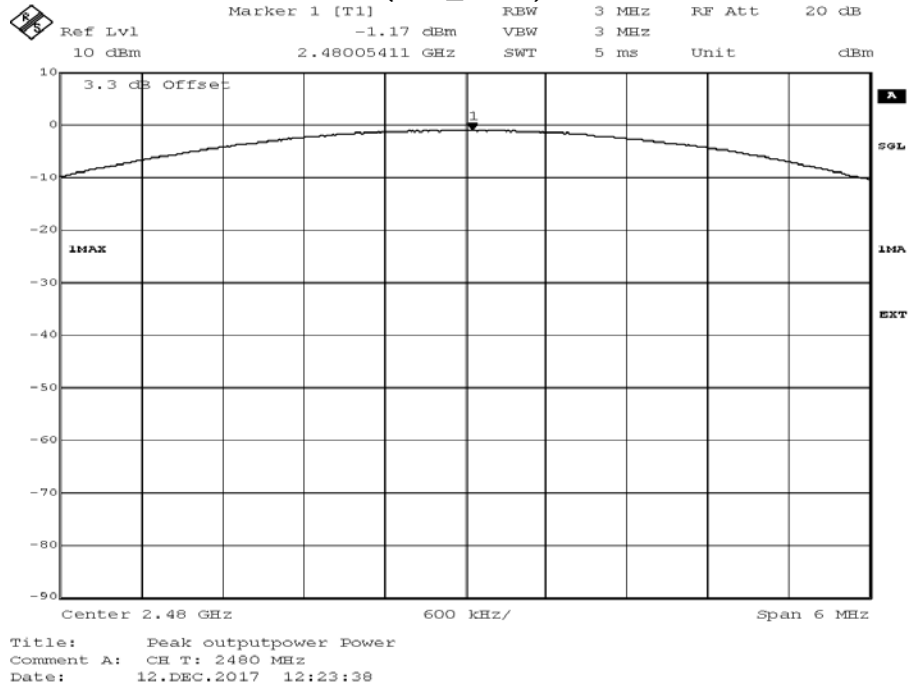

Radio Technology = Bluetooth EDR 3, Operating Frequency = low, Measurement method = conducted (S01_AB01)

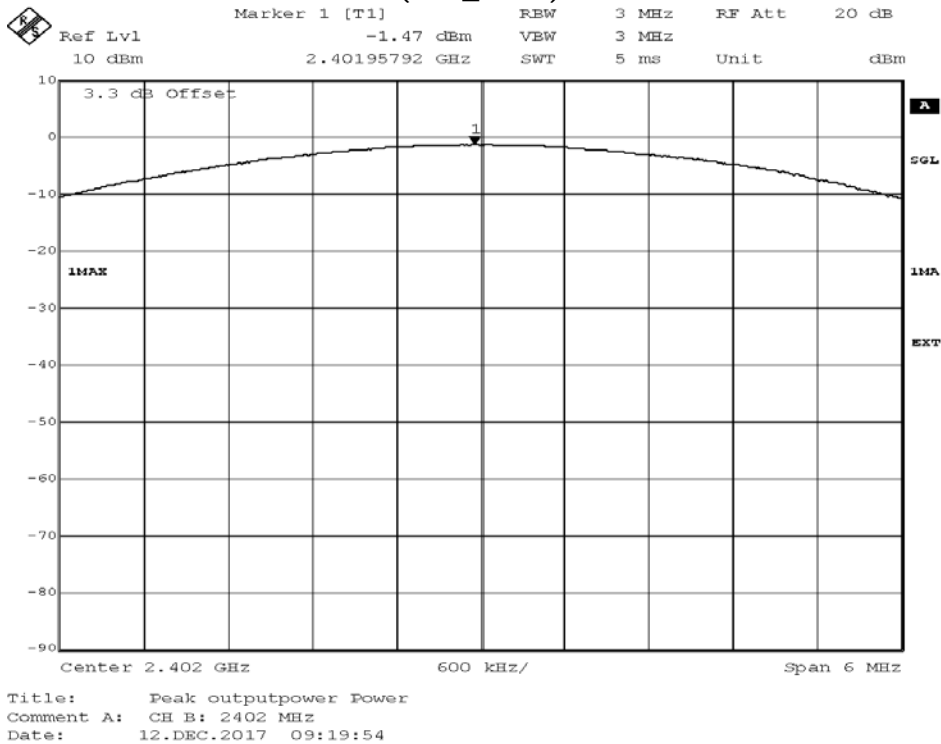

Radio Technology = Bluetooth EDR 3, Operating Frequency = mid, Measurement method = conducted (S01_AB01)

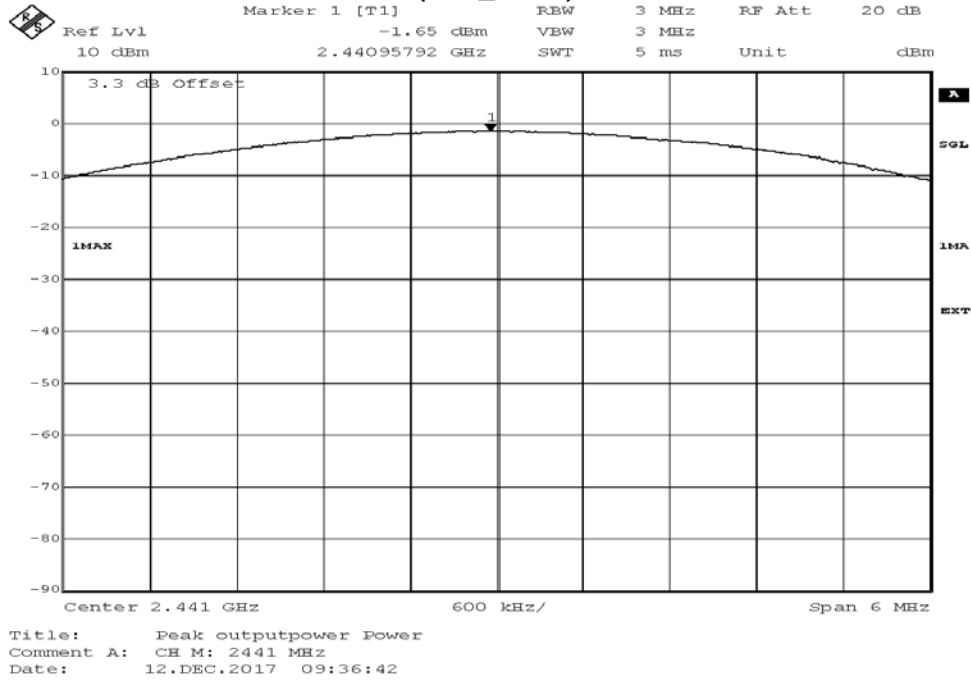

Radio Technology = Bluetooth EDR 3, Operating Frequency = high, Measurement method = conducted (S01_AB01)

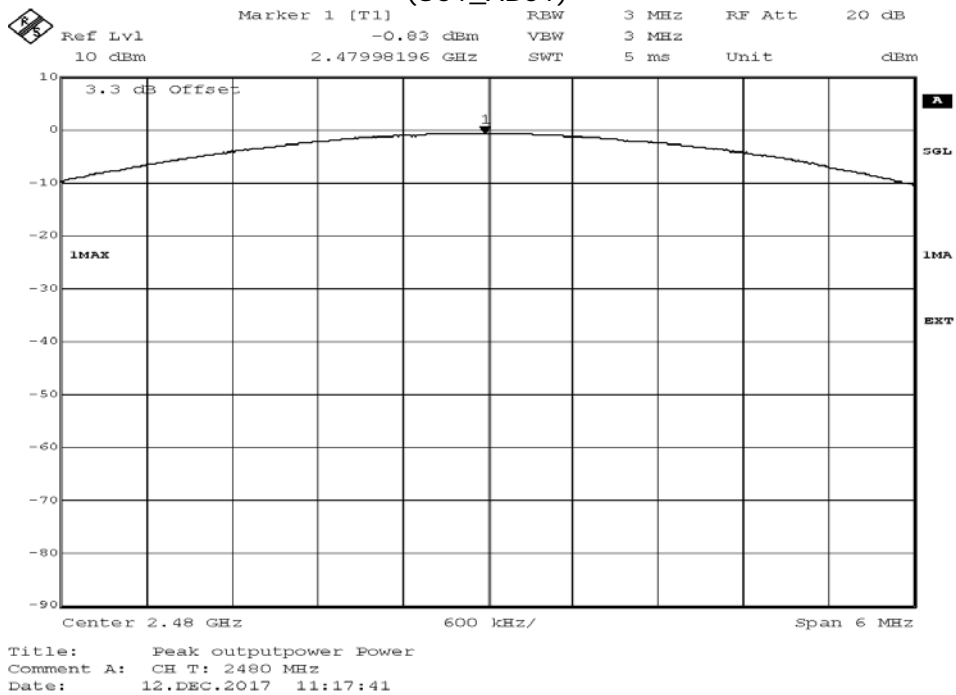

4.2.5 TEST EQUIPMENT USED

- Regulatory Bluetooth RF Test Solution

4.3 SPURIOUS RF CONDUCTED EMISSIONS

Standard **FCC Part 15 Subpart C**

The test was performed according to:
ANSI C63.10

4.3.1 TEST DESCRIPTION

The Equipment Under Test (EUT) was set up to perform the spurious emissions measurements. The EUT was connected to spectrum analyzer via a short coax cable with a known loss.

Analyzer settings:

- Frequency range: 30 – 25000 MHz
- Resolution Bandwidth (RBW): 100 kHz
- Video Bandwidth (VBW): 300 kHz
- Trace: Maxhold
- Sweeps: 2
- Sweep Time: 330 s
- Detector: Peak

The reference value for the measurement of the spurious RF conducted emissions is determined during the test “band edge compliance conducted”. This value is used to calculate the 20 dBc limit.

4.3.2 TEST REQUIREMENTS / LIMITS

FCC Part 15, Subpart C, §15.247 (c)

In any 100 kHz bandwidth outside the frequency band in which the spread spectrum intentional radiator is operating, the radio frequency power that is produced by the intentional radiator shall be at least 20 dB below that in the 100 kHz bandwidth within the band that contains the highest level of the desired power, based on either an RF conducted or a radiated measurement, provided the transmitter demonstrates compliance with the peak conducted power limits. If the transmitter complies with the conducted power limits based on the use of RMS averaging over a time interval, as permitted under paragraph (b)(3) of this section, the attenuation required under this paragraph shall be 30 dB instead of 20 dB.

4.3.3 TEST PROTOCOL

Module: UGXZEX304A

Ambient temperature: 22 °C
 Air Pressure: 1010 hPa
 Humidity: 38 %

BT GFSK (1-DH1)

Channel No	Channel Center Freq. [MHz]	Spurious Freq. [MHz]	Spurious Level [dBm]	Detector	RBW [kHz]	Ref. Level [dBm]	Limit [dBm]	Margin to Limit [dB]
0	2402	-	-	-	-	-2.8	-22.8	-
39	2441	-	-	-	-	-1.6	-21.6	-
78	2480	-	-	-	-	-2.1	-22.1	-

BT π/4 DQPSK (2-DH1)

Channel No	Channel Center Freq. [MHz]	Spurious Freq. [MHz]	Spurious Level [dBm]	Detector	RBW [kHz]	Ref. Level [dBm]	Limit [dBm]	Margin to Limit [dB]
0	2402	-	-	-	-	-3.7	-23.7	-
39	2441	-	-	-	-	-2.3	-22.3	-
78	2480	-	-	-	-	-2.7	-22.7	-

BT 8-DPSK (3-DH1)

Channel No	Channel Center Freq. [MHz]	Spurious Freq. [MHz]	Spurious Level [dBm]	Detector	RBW [kHz]	Ref. Level [dBm]	Limit [dBm]	Margin to Limit [dB]
0	2402	-	-	-	-	-3.8	-23.8	-
39	2441	-	-	-	-	-2.6	-22.6	-
78	2480	-	-	-	-	-2.7	-22.7	-

Remark: Please see next sub-clause for the measurement plot.

Module: UGKZ7A1001A

Ambient temperature: 22 °C
 Air Pressure: 1010 hPa
 Humidity: 34 %
 BT GFSK (1-DH1)

Channel No	Channel Center Freq. [MHz]	Spurious Freq. [MHz]	Spurious Level [dBm]	Detector	RBW [kHz]	Ref. Level [dBm]	Limit [dBm]	Margin to Limit [dB]
0	2402	---	---	PEAK	100	-5.2	-25.2	---
39	2441	---	---	PEAK	100	-5.0	-25.0	---
78	2480	---	---	PEAK	100	-4.2	-24.2	---

BT π/4 DQPSK (2-DH1)

Channel No	Channel Center Freq. [MHz]	Spurious Freq. [MHz]	Spurious Level [dBm]	Detector	RBW [kHz]	Ref. Level [dBm]	Limit [dBm]	Margin to Limit [dB]
0	2402	---	---	PEAK	100	-4.6	-24.6	---
39	2441	---	---	PEAK	100	-4.8	-24.8	---
78	2480	---	---	PEAK	100	-3.8	-23.8	---

BT 8-DPSK (3-DH1)

Channel No	Channel Center Freq. [MHz]	Spurious Freq. [MHz]	Spurious Level [dBm]	Detector	RBW [kHz]	Ref. Level [dBm]	Limit [dBm]	Margin to Limit [dB]
0	2402	---	---	PEAK	100	-4.6	-24.6	---
39	2441	---	---	PEAK	100	-4.8	-24.8	---
78	2480	---	---	PEAK	100	-3.8	-23.8	---

COMMENT:

No (further) spurious emissions in the range 20dB below the limit were found, therefore no measurement values are reported in the tables.

Remark: Please see next sub-clause for the measurement plot.

4.3.4 MEASUREMENT PLOT (SHOWING THE HIGHEST VALUE, "WORST CASE")

Module: UGXZEX304A

Radio Technology = Bluetooth EDR 3, Operating Frequency = low
(S01_AB01)

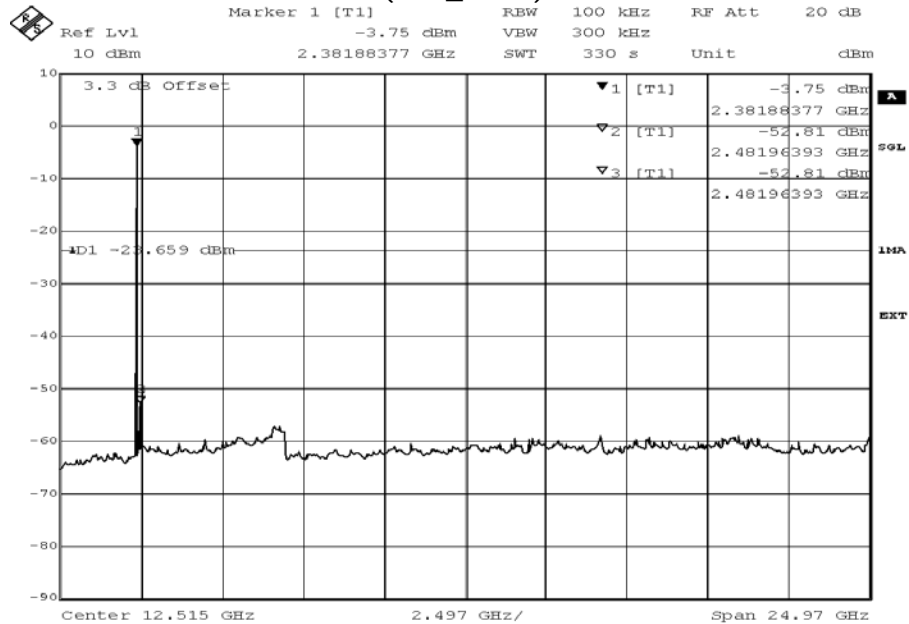

Title: spurious emissions
 Comment A: CH B: 2402 MHz
 Date: 11.DEC.2017 12:00:34

Radio Technology = Bluetooth EDR 2, Operating Frequency = mid
(S01_AB01)

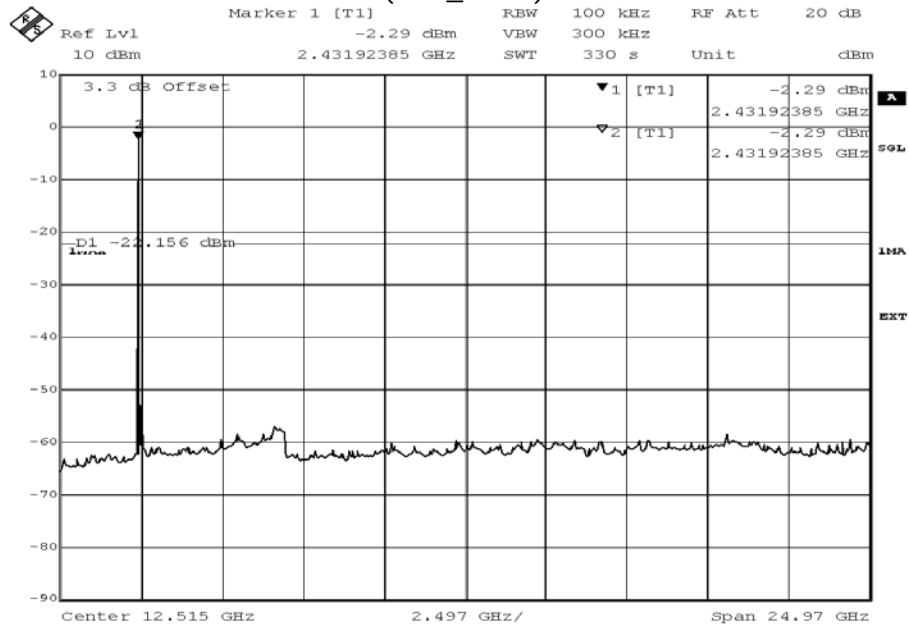

Title: spurious emissions
 Comment A: CH M: 2441 MHz
 Date: 11.DEC.2017 13:01:14

Radio Technology = Bluetooth EDR 3, Operating Frequency = mid (S01_AB01)

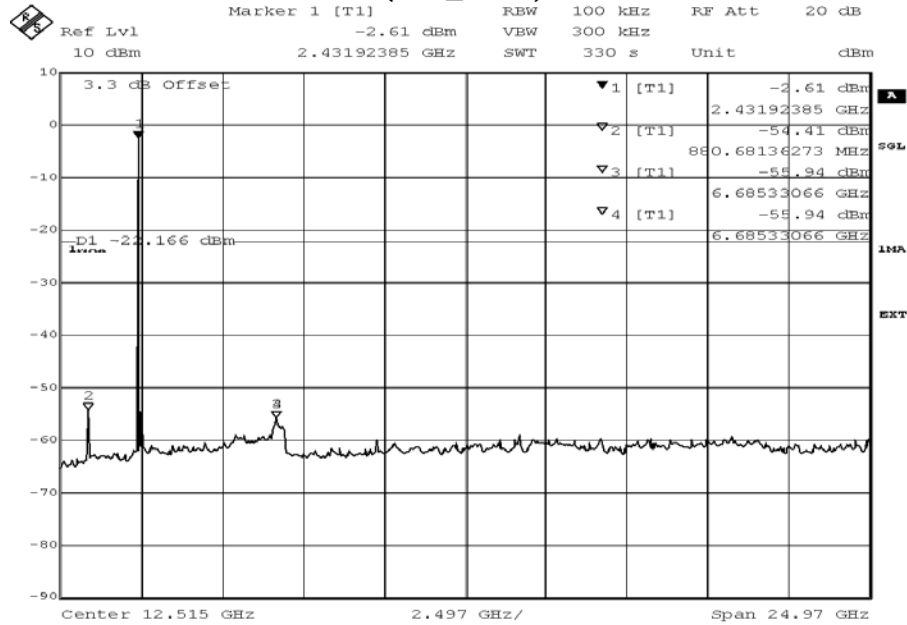

Title: spurious emissions
 Comment A: CH M: 2441 MHz
 Date: 11.DEC.2017 12:45:53

Radio Technology = Bluetooth EDR 2, Operating Frequency = high (S01_AB01)

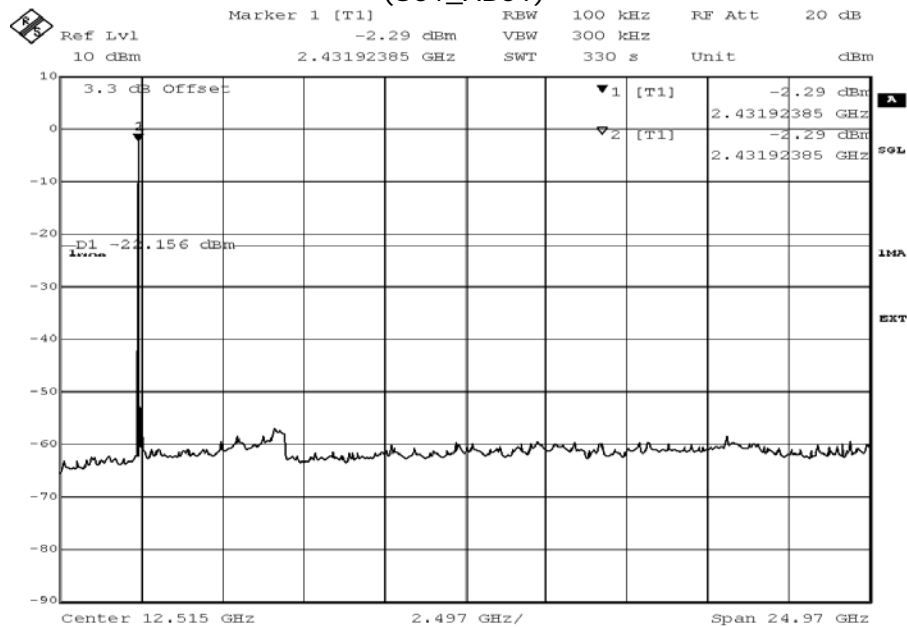

Title: spurious emissions
 Comment A: CH M: 2441 MHz
 Date: 11.DEC.2017 13:01:14

Radio Technology = Bluetooth EDR 2, Operating Frequency = low
(S01_AB01)

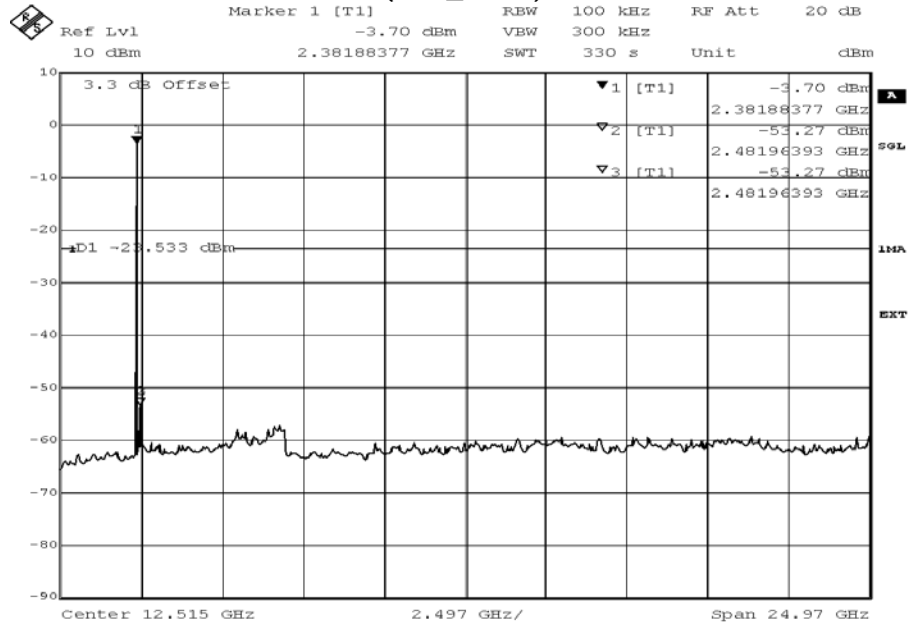

Title: spurious emissions
 Comment A: CH B: 2402 MHz
 Date: 11.DEC.2017 11:33:16

Radio Technology = Bluetooth BDR, Operating Frequency = mid
(S01_AB01)

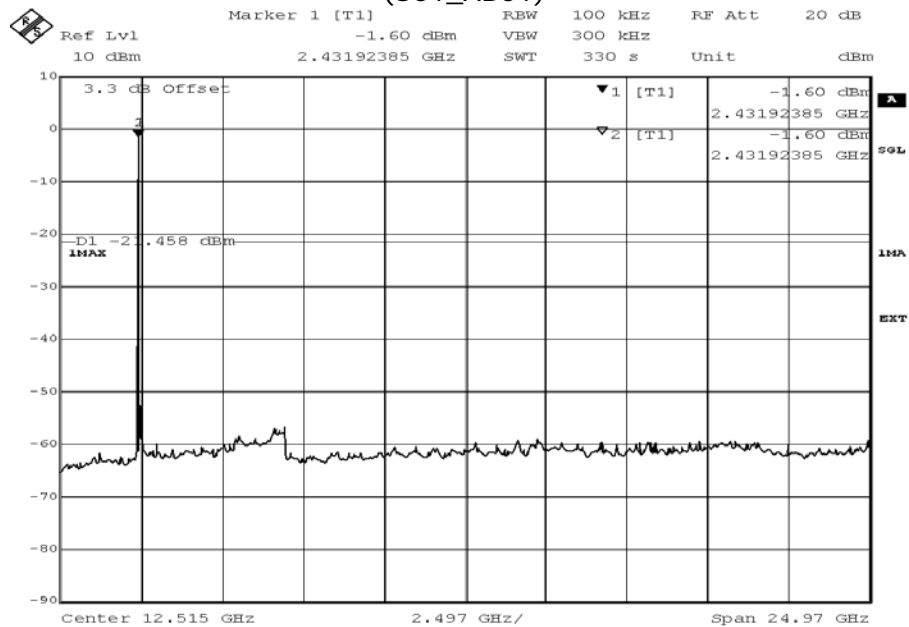

Title: spurious emissions
 Comment A: CH M: 2441 MHz
 Date: 11.DEC.2017 13:19:15

Radio Technology = Bluetooth EDR 3, Operating Frequency = high (S01_AB01)

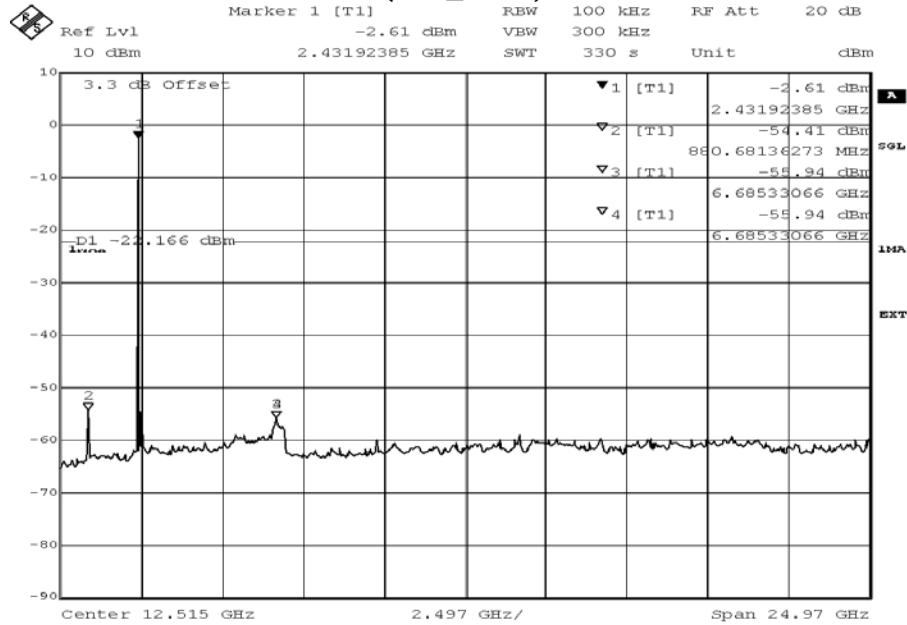

Title: spurious emissions
 Comment A: CH M: 2441 MHz
 Date: 11.DEC.2017 12:45:53

Radio Technology = Bluetooth BDR, Operating Frequency = high (S01_AB01)

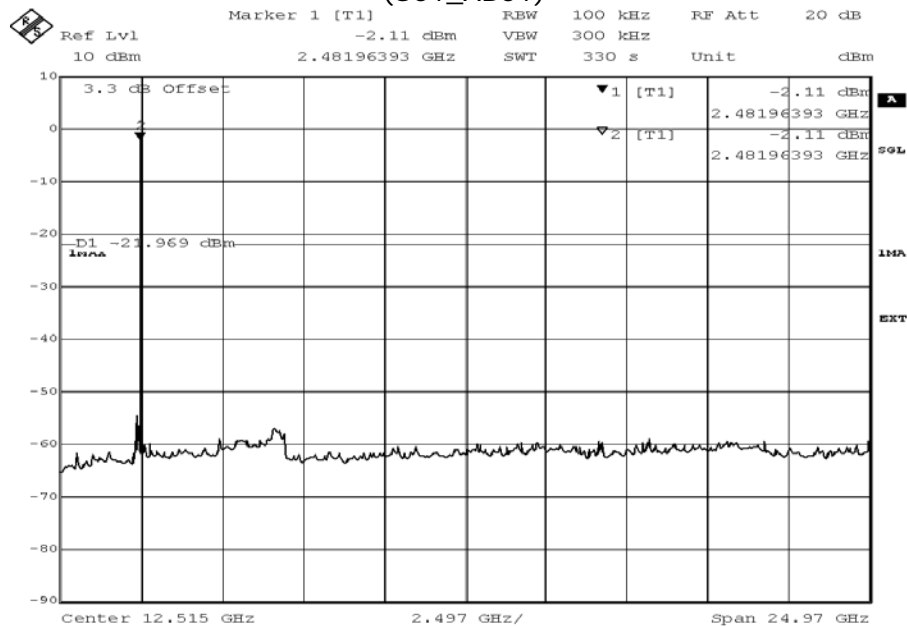

Title: spurious emissions
 Comment A: CH T: 2480 MHz
 Date: 11.DEC.2017 13:42:16

Radio Technology = Bluetooth BDR, Operating Frequency = low
(S01_AB01)

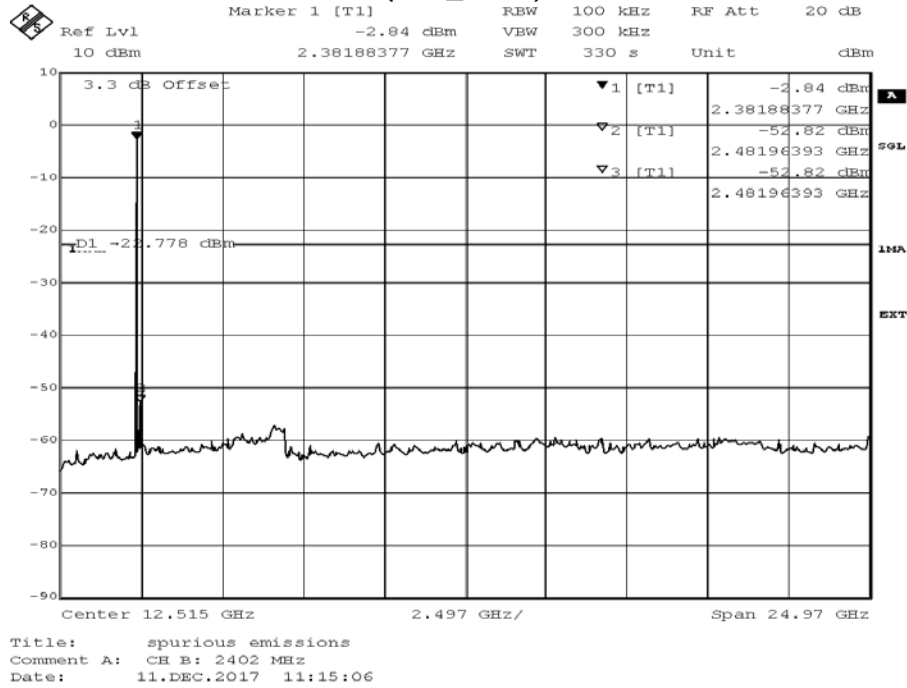

Module: UGKZ7A1001A

Radio Technology = Bluetooth BDR, Operating Frequency = low
(S01_AB01)

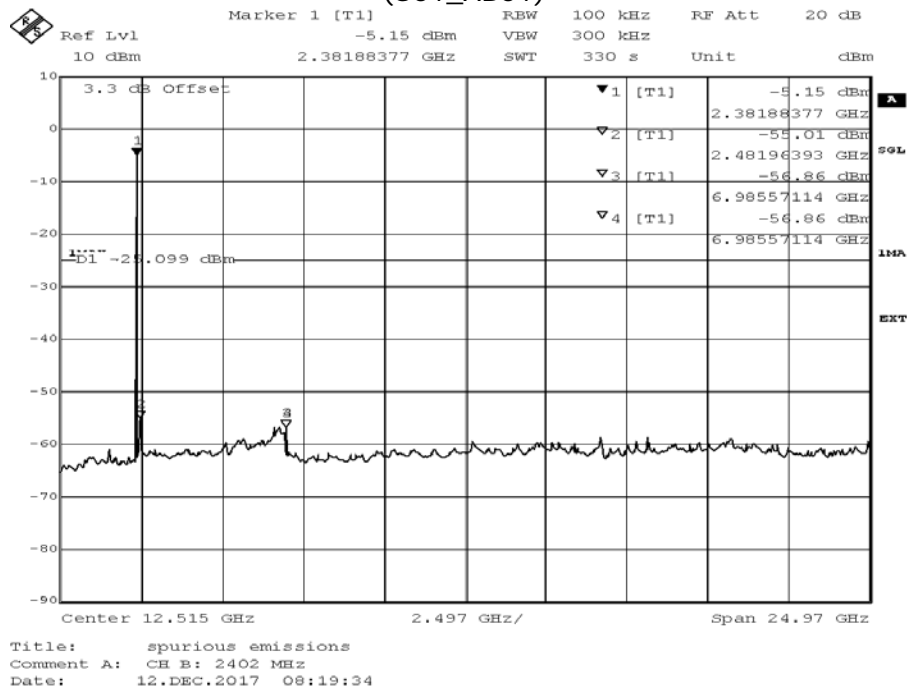

Radio Technology = Bluetooth BDR, Operating Frequency = mid
(S01_AB01)

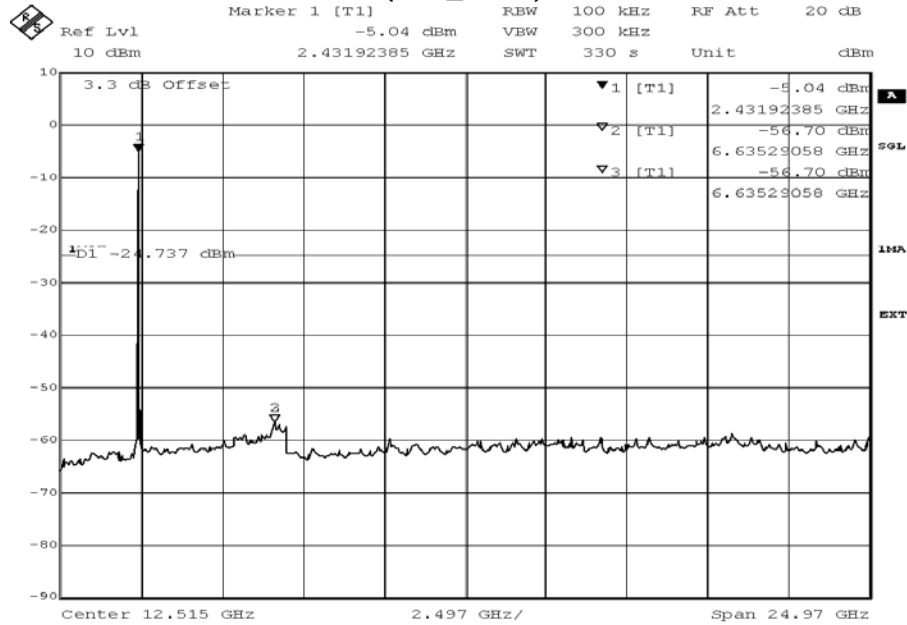

Title: spurious emissions
Comment A: CH M: 2441 MHz
Date: 12.DEC.2017 10:09:46

Radio Technology = Bluetooth BDR, Operating Frequency = high
(S01_AB01)

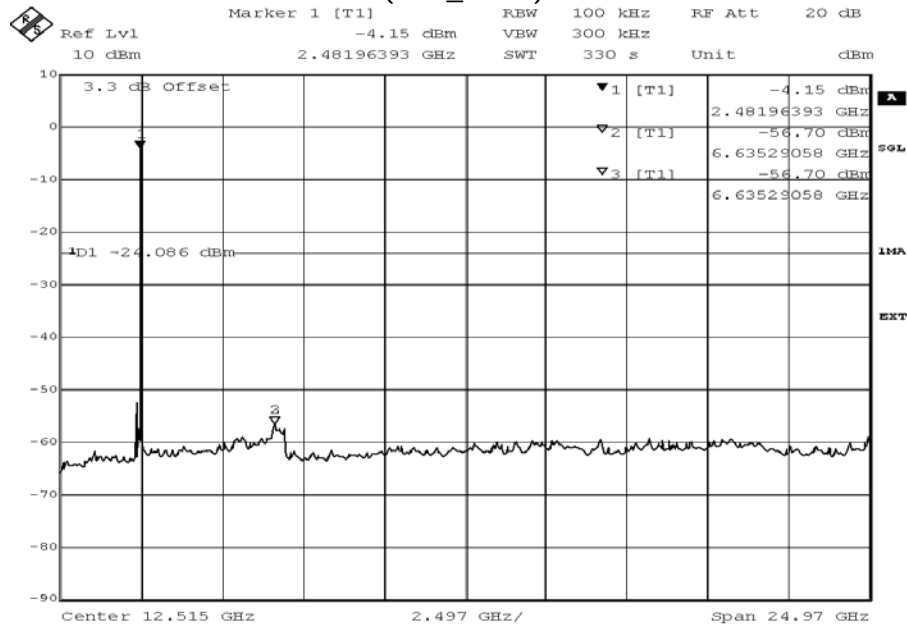

Title: spurious emissions
Comment A: CH T: 2480 MHz
Date: 12.DEC.2017 10:26:50

Radio Technology = Bluetooth EDR 2, Operating Frequency = low
(S01_AB01)

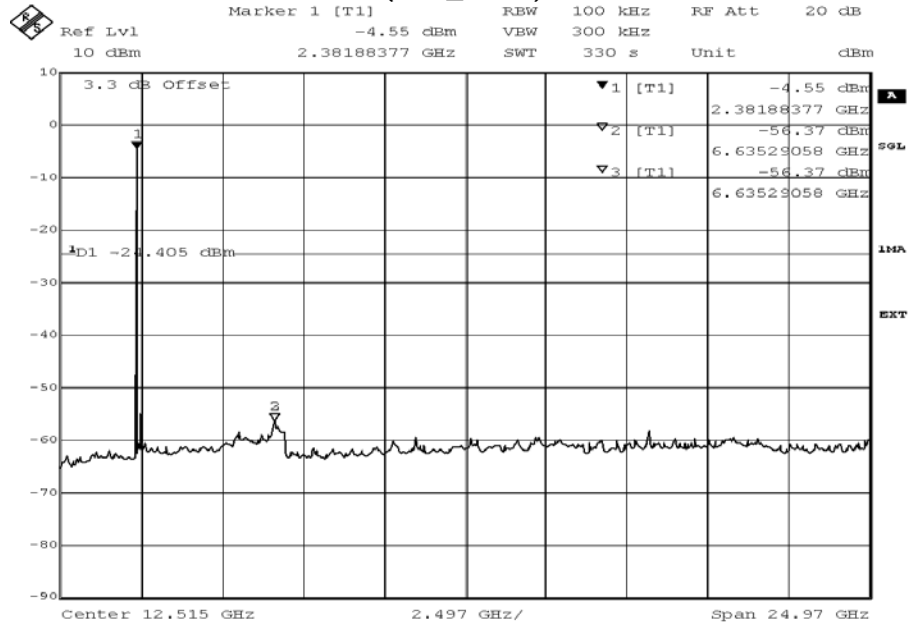

Title: spurious emissions
Comment A: CH B: 2402 MHz
Date: 12.DEC.2017 08:37:58

Radio Technology = Bluetooth EDR 2, Operating Frequency = mid
(S01_AB01)

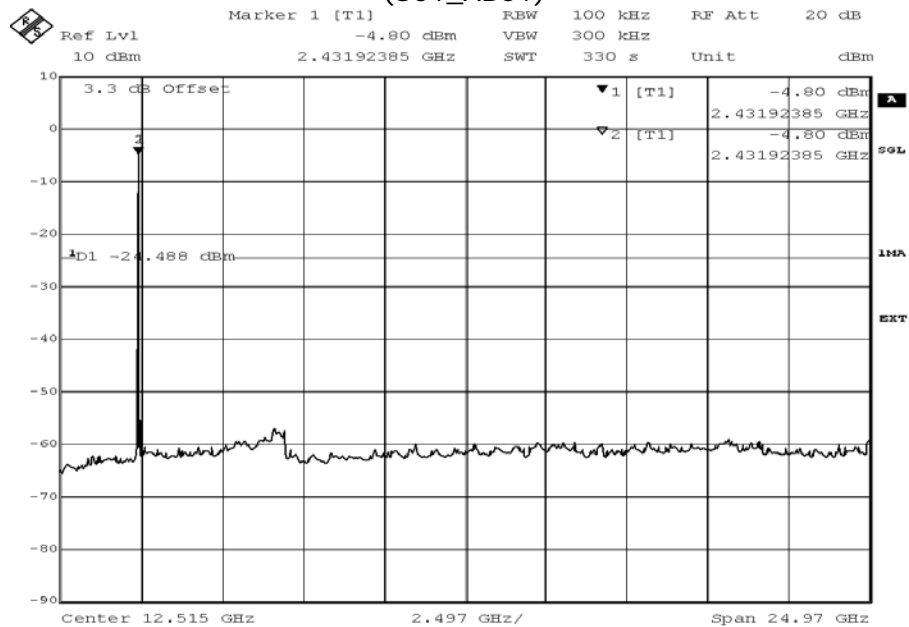

Title: spurious emissions
Comment A: CH M: 2441 MHz
Date: 12.DEC.2017 09:50:38

Radio Technology = Bluetooth EDR 2, Operating Frequency = high
(S01_AB01)

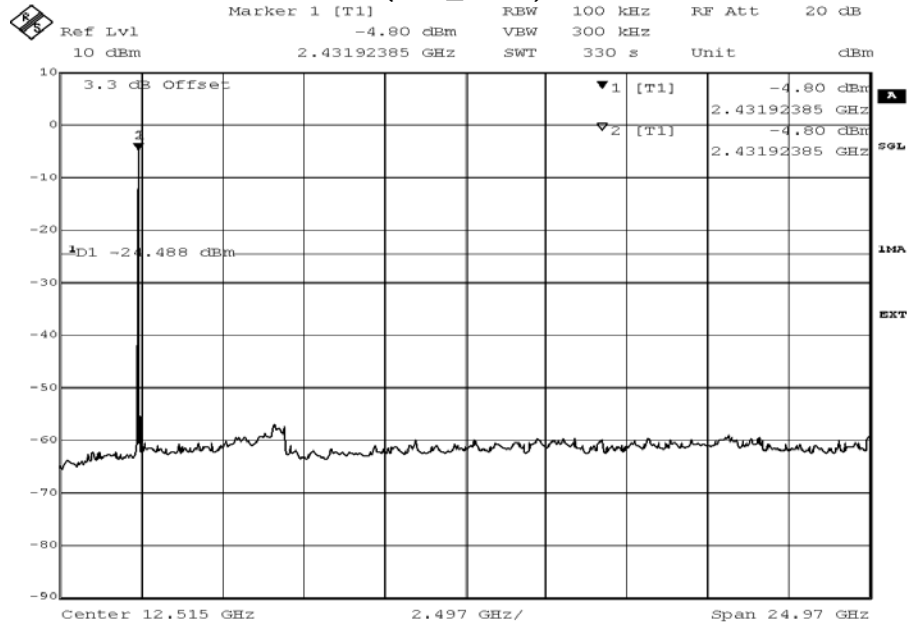

Title: spurious emissions
Comment A: CH M: 2441 MHz
Date: 12.DEC.2017 09:50:38

Radio Technology = Bluetooth EDR 3, Operating Frequency = low
(S01_AB01)

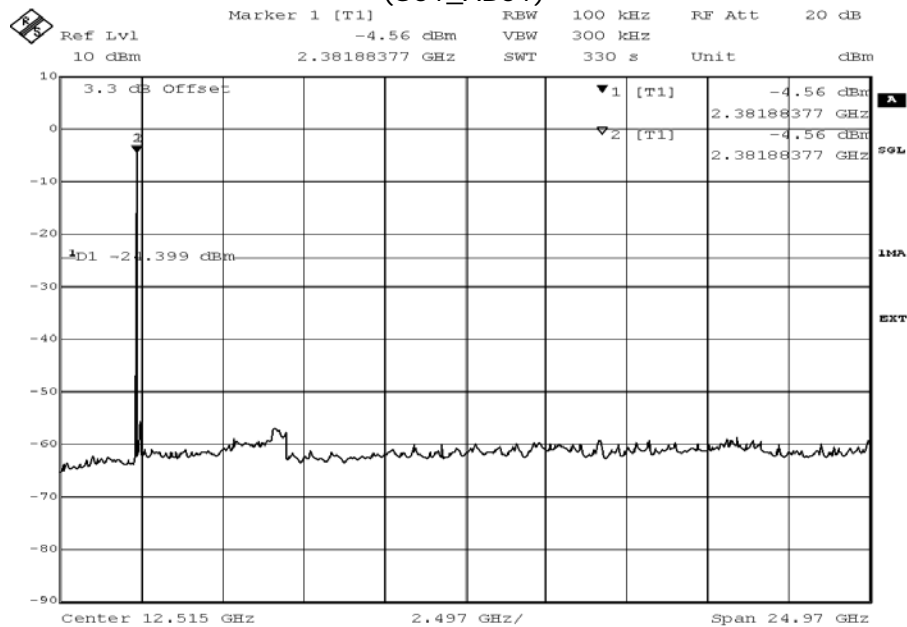

Title: spurious emissions
Comment A: CH B: 2402 MHz
Date: 12.DEC.2017 09:16:17

Radio Technology = Bluetooth EDR 3, Operating Frequency = mid
(S01_AB01)

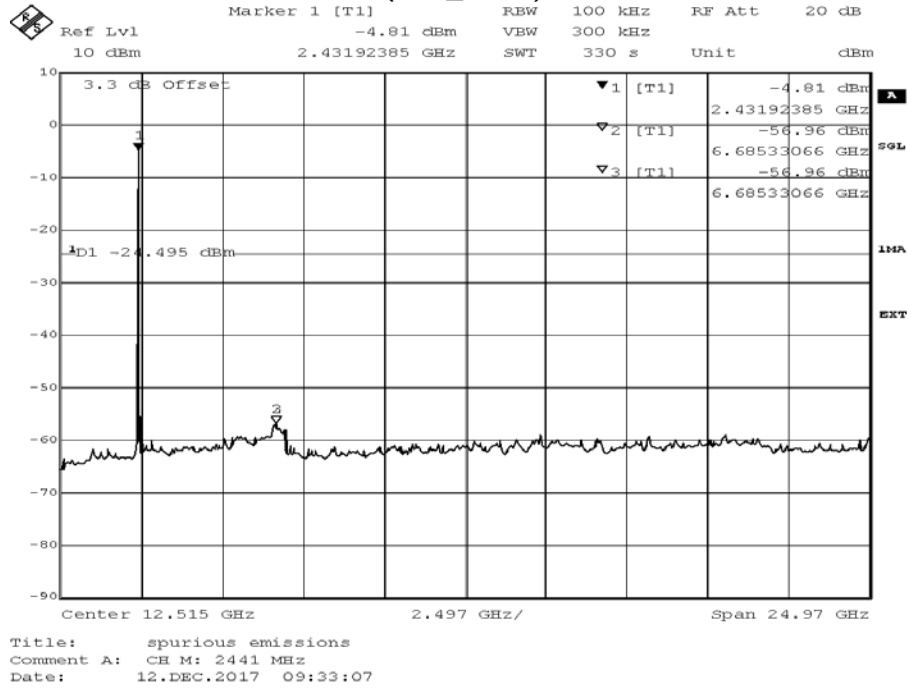

Radio Technology = Bluetooth EDR 3, Operating Frequency = high
(S01_AB01)

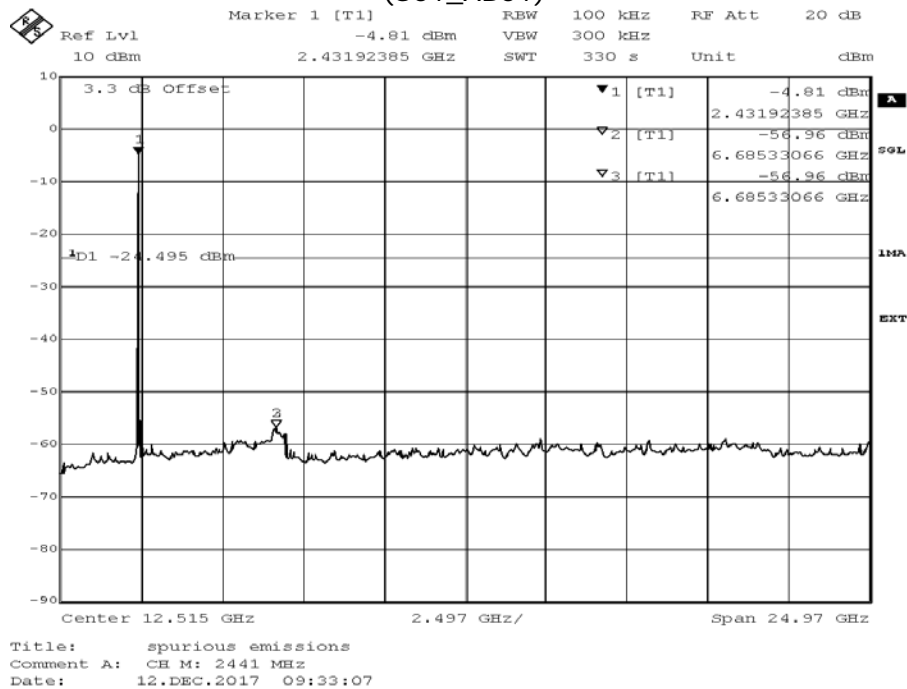

4.3.5 TEST EQUIPMENT USED

- Regulatory Bluetooth RF Test Solution

4.4 TRANSMITTER SPURIOUS RADIATED EMISSIONS

Standard **FCC Part 15 Subpart C**

The test was performed according to:
ANSI C63.10

4.4.1 TEST DESCRIPTION

The test set-up was made in accordance to the general provisions of ANSI C63.10 in a typical installation configuration. The Equipment Under Test (EUT) was set up on a non-conductive table 1.0 x 2.0 m² in the semi-anechoic chamber. The influence of the EUT support table that is used between 30–1000 MHz was evaluated.

The measurement procedure is implemented into the EMI test software EMC32 from R&S. Exploratory tests are performed at 3 orthogonal axes to determine the worst-case orientation of a body-worn or handheld EUT. The final test on all kind of EUTs is also performed at 3 axes. A pre-check is performed while the EUT is powered from a DC power source.

1. Measurement up to 30 MHz

The Loop antenna HFH2-Z2 is used.

Step 1: pre measurement

- Anechoic chamber
- Antenna distance: 3 m
- Detector: Peak-Maxhold
- Frequency range: 0.009 - 0.15 MHz and 0.15 – 30 MHz
- Frequency steps: 0.05 kHz and 2.25 kHz
- IF-Bandwidth: 0.2 kHz and 9 kHz
- Measuring time / Frequency step: 100 ms (FFT-based)

Intention of this step is, to determine the radiated EMI-profile of the EUT. Afterwards the relevant emissions for the final measurement are identified.

Step 2: final measurement

For the relevant emissions determined in step 1, an additional measurement with the following settings will be performed. Intention of this step is to find the maximum emission level.

- Open area test side
- Antenna distance: according to the Standard
- Detector: Quasi-Peak
- Frequency range: 0.009 – 30 MHz
- Frequency steps: measurement at frequencies detected in step 1
- IF-Bandwidth: 0.2 - 10 kHz
- Measuring time / Frequency step: 1 s

2. Measurement above 30 MHz and up to 1 GHz

Step 1: Preliminary scan

This is a preliminary test to identify the highest amplitudes relative to the limit.

Settings for step 1:

- Antenna distance: 3 m
- Detector: Peak-Maxhold / Quasipeak (FFT-based)
- Frequency range: 30 – 1000 MHz
- Frequency steps: 30 kHz
- IF-Bandwidth: 120 kHz
- Measuring time / Frequency step: 100 ms

- Turntable angle range: -180° to 90°
- Turntable step size: 90°
- Height variation range: 1 – 3 m
- Height variation step size: 2 m
- Polarisation: Horizontal + Vertical

Intention of this step is, to determine the radiated EMI-profile of the EUT. Afterwards the relevant emissions for the final measurement are identified.

Step 2: Adjustment measurement

In this step the accuracy of the turntable azimuth and antenna height will be improved. This is necessary to find out the maximum value of every frequency.

For each frequency, which was determined the turntable azimuth and antenna height will be adjusted. The turntable azimuth will slowly vary by $\pm 45^{\circ}$ around this value. During this action, the value of emission is continuously measured. The turntable azimuth at the highest emission will be recorded and adjusted. In this position, the antenna height will also slowly vary by ± 100 cm around the antenna height determined. During this action, the value of emission is also continuously measured. The antenna height of the highest emission will also be recorded and adjusted.

- Detector: Peak – Maxhold
- Measured frequencies: in step 1 determined frequencies
- IF – Bandwidth: 120 kHz
- Measuring time: 100 ms
- Turntable angle range: $\pm 45^{\circ}$ around the determined value
- Height variation range: ± 100 cm around the determined value
- Antenna Polarisation: max. value determined in step 1

Step 3: Final measurement with QP detector

With the settings determined in step 3, the final measurement will be performed:

EMI receiver settings for step 4:

- Detector: Quasi-Peak (< 1 GHz)
- Measured frequencies: in step 1 determined frequencies
- IF – Bandwidth: 120 kHz
- Measuring time: 1 s

After the measurement a plot will be generated which contains a diagram with the results of the preliminary scan and a chart with the frequencies and values of the results of the final measurement.

3. Measurement above 1 GHz

The following modifications apply to the measurement procedure for the frequency range above 1 GHz:

Step 1:

The Equipment Under Test (EUT) was set up on a non-conductive support (tilt device) at 1.5 m height in the fully-anechoic chamber.

All steps were performed with one height (1.5 m) of the receiving antenna only.

The EUT is turned during the preliminary measurement across the elevation axis, with a step size of 90° .

The turn table step size (azimuth angle) for the preliminary measurement is 45° .

Step 2:

Due to the fact, that in this frequency range the test is performed in a fully anechoic room, the height scan of the receiving antenna instep 2 is omitted. Instead of this, a maximum search with a step size $\pm 45^{\circ}$ for the elevation axis is performed.

The turn table azimuth will slowly vary by $\pm 22.5^{\circ}$.

The elevation angle will slowly vary by $\pm 45^{\circ}$

EMI receiver settings (for all steps):

- Detector: Peak, Average
- IF Bandwidth = 1 MHz

Step 3:

Spectrum analyser settings for step 3:

- Detector: Peak / Average
- Measured frequencies: in step 1 determined frequencies
- IF – Bandwidth: 1 MHz
- Measuring time: 1 s

4.4.2 TEST REQUIREMENTS / LIMITS

FCC Part 15, Subpart C, §15.247 (d)

... In addition, radiated emissions which fall in the restricted bands, as defined in Section 15.205(a), must also comply with the radiated emission limits specified in Section 15.209(a) (see Section 15.205(c)).

FCC Part 15, Subpart C, §15.209, Radiated Emission Limits

Frequency in MHz	Limit (µV/m)	Measurement distance (m)	Limits (dBµV/m)
0.009 – 0.49	2400/F(kHz)@300m	3	(48.5 – 13.8)@300m
0.49 – 1.705	24000/F(kHz)@30m	3	(33.8 – 23.0)@30m
1.705 – 30	30@30m	3	29.5@30m

The measured values are corrected with an inverse linear distance extrapolation factor (40 dB/decade) according FCC 15.31 (2).

Frequency in MHz	Limit (µV/m)	Measurement distance (m)	Limits (dBµV/m)
30 – 88	100@3m	3	40.0@3m
88 – 216	150@3m	3	43.5@3m
216 – 960	200@3m	3	46.0@3m
960 - 26000	500@3m	3	54.0@3m
26000 - 40000	500@3m	1	54.0@3m

The measured values above 26 GHz are corrected with an inverse linear distance extrapolation factor (20 dB/decade).

§15.35(b) ..., there is also a limit on the radio frequency emissions, as measured using instrumentation with a peak detector function, corresponding to 20 dB above the maximum permitted average limit....

Used conversion factor: Limit (dBµV/m) = 20 log (Limit (µV/m)/1µV/m)

4.4.3 TEST PROTOCOL

Module: UGXZEX304A

Ambient temperature: 22 - 23 °C
 Air Pressure: 971 - 1004 hPa
 Humidity: 35 - 38 %
 BT GFSK (1-DH1)
 Applied duty cycle correction (AV): 0 dB

Ch. No.	Ch. Center Freq. [MHz]	Spurious Freq. [MHz]	Spurious Level [dBµV/m]	Detector	RBW [kHz]	Limit [dBµV/m]	Margin to Limit [dB]	Limit Type
0	2402	332.1	35.0	QP	120	46.0	11.0	RB
39	2441	278.2	32.6	QP	120	46.0	13.4	RB
39	2441	281.6	34.2	QP	120	46.0	11.8	RB
39	2441	322.0	36.7	QP	120	46.0	9.3	RB
39	2441	328.8	34.6	QP	120	46.0	11.4	RB
39	2441	332.1	35.2	QP	120	46.0	10.8	RB

Module: UGKZ7A1001A

Ambient temperature: 22 - 23 °C
 Air Pressure: 971 - 1004 hPa
 Humidity: 35 - 38 %
 BT GFSK (1-DH1)
 Applied duty cycle correction (AV): 0 dB

Ch. No.	Ch. Center Freq. [MHz]	Spurious Freq. [MHz]	Spurious Level [dBµV/m]	Detector	RBW [kHz]	Limit [dBµV/m]	Margin to Limit [dB]	Limit Type
0	2402	4803.6	58.6	PEAK	1000	74.0	15.4	RB
0	2402	4804.2	45.9	AV	1000	54.0	8.1	RB
39	2441	4881.7	58.2	PEAK	1000	74.0	15.8	RB
39	2441	4881.7	44.7	AV	1000	54.0	9.3	RB
78	2480	4959.6	56.3	PEAK	1000	74.0	17.7	RB
78	2480	4959.9	49.1	AV	1000	54.0	4.9	RB
0	2402	74.0	34.0	QP	120	40.0	6.0	RB
39	2441	281.6	33.9	QP	120	46.0	12.1	RB
39	2441	322.0	37.6	QP	120	46.0	8.4	RB
39	2441	328.8	35.6	QP	120	46.0	10.4	RB
39	2441	332.1	36.6	QP	120	46.0	9.4	RB
78	2480	261.3	29.9	QP	120	46.0	16.1	RB
78	2480	268.1	30.3	QP	120	46.0	15.7	RB
78	2480	271.4	31.9	QP	120	46.0	14.1	RB
78	2480	281.6	34.2	QP	120	46.0	11.8	RB

Remark: Please see next sub-clause for the measurement plot.

4.4.4 MEASUREMENT PLOT (SHOWING THE HIGHEST VALUE, "WORST CASE")

Module: UGXZEX304A

Radio Technology = Bluetooth BDR, Operating Frequency = mid, Measurement range = 9 kHz - 30 MHz
(S01_AA01)

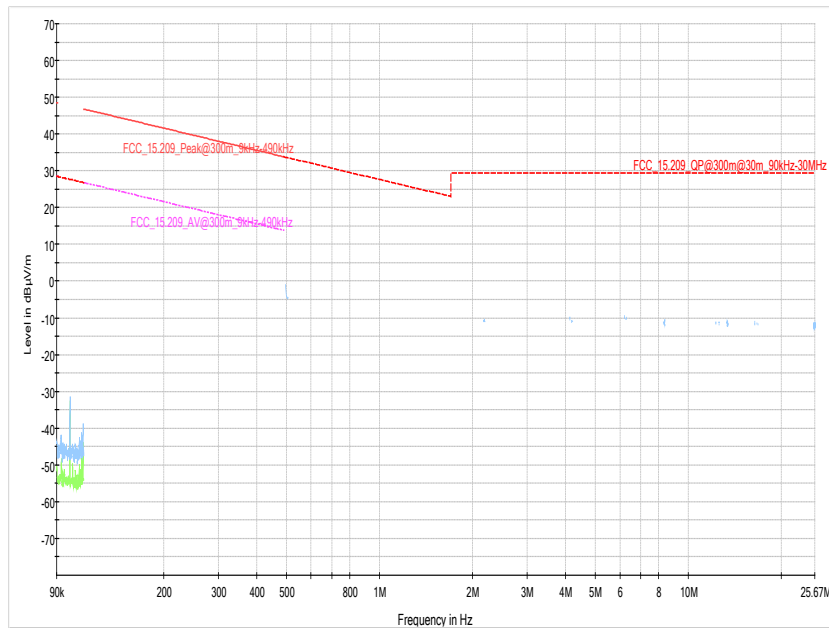

Radio Technology = Bluetooth BDR, Operating Frequency = mid, Measurement range = 1 GHz - 26 GHz
(S01_AA01)

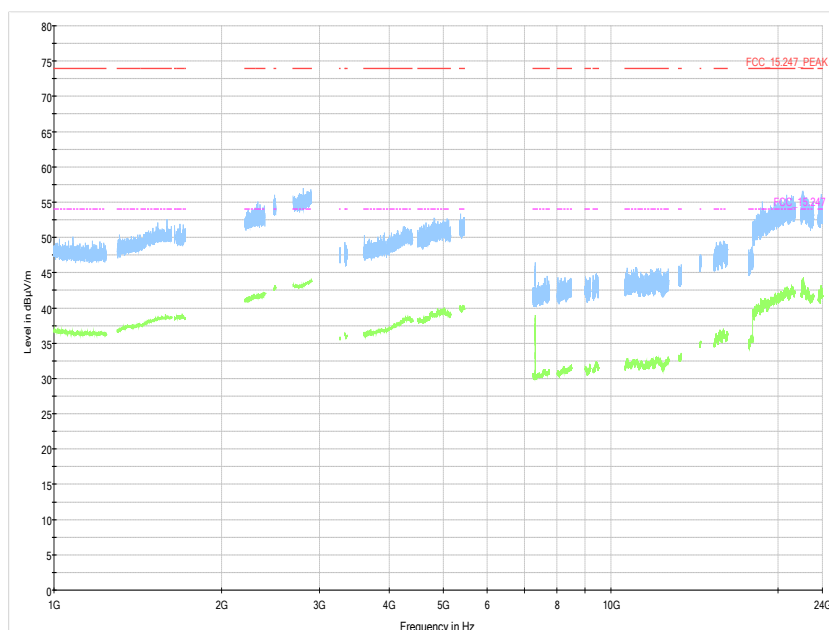

Radio Technology = Bluetooth EDR 2, Operating Frequency = high, Measurement range = 1 GHz - 26 GHz (S01_AA01)

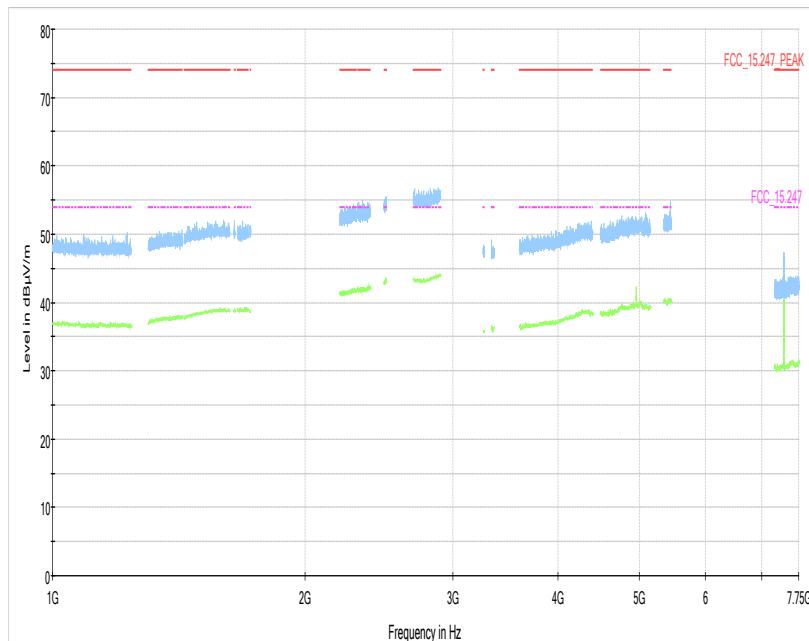

Radio Technology = Bluetooth EDR 2, Operating Frequency = low, Measurement range = 1 GHz - 26 GHz (S01_AA01)

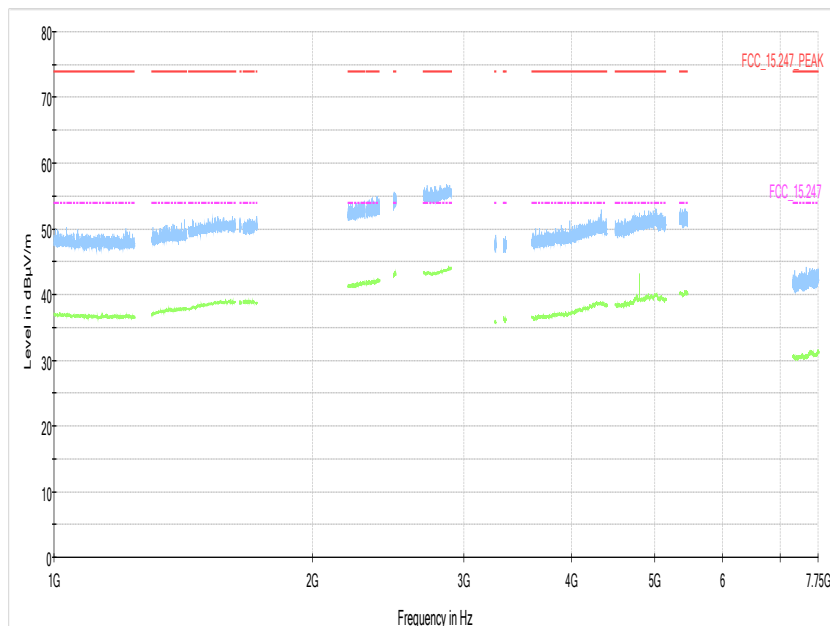

Radio Technology = Bluetooth BDR, Operating Frequency = high, Measurement range = 1 GHz - 26 GHz (S01_AA01)

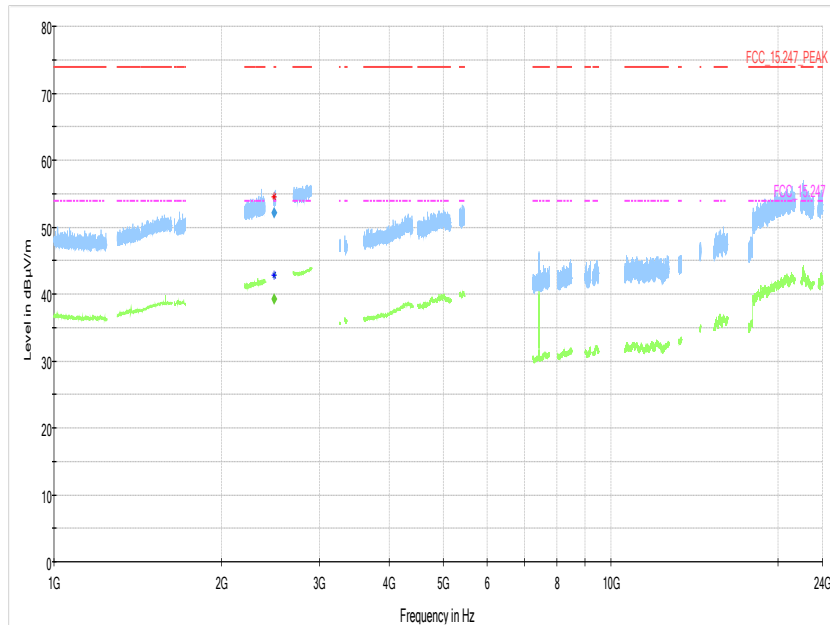

Radio Technology = Bluetooth EDR 2, Operating Frequency = mid, Measurement range = 1 GHz - 26 GHz (S01_AA01)

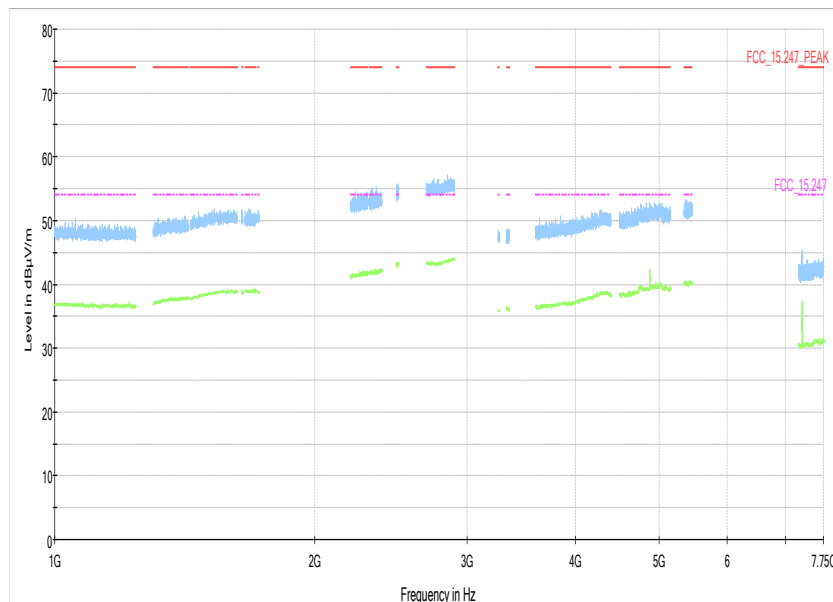

Radio Technology = Bluetooth BDR, Operating Frequency = high, Measurement range = 30 MHz - 1 GHz
(S01_AA01)

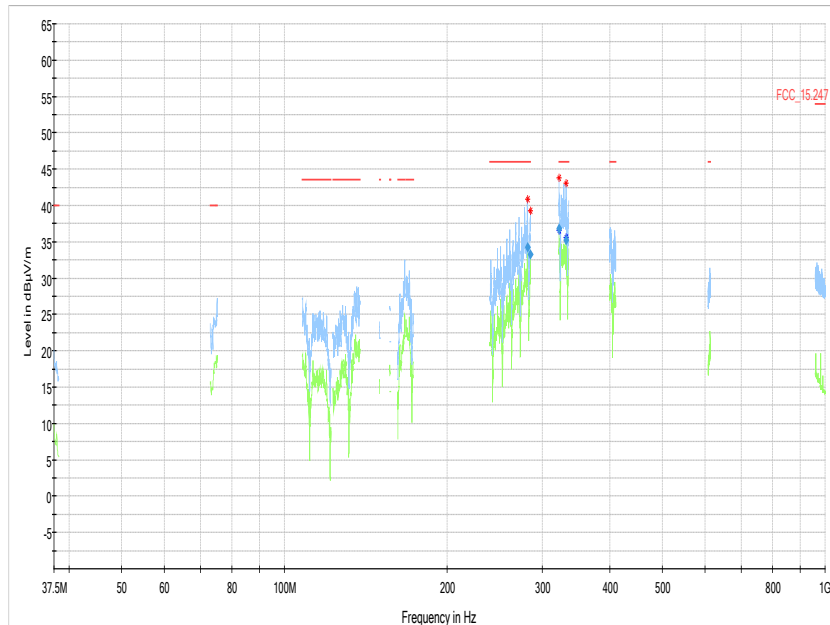

Radio Technology = Bluetooth BDR, Operating Frequency = low, Measurement range = 1 GHz - 26 GHz
(S01_AA01)

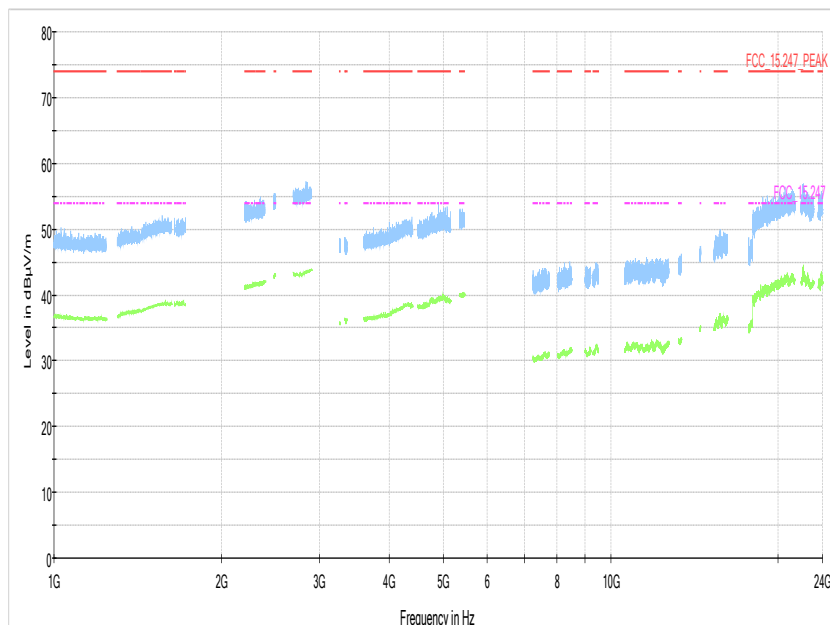

Radio Technology = Bluetooth BDR, Operating Frequency = low, Measurement range = 30 MHz - 1 GHz
(S01_AA01)

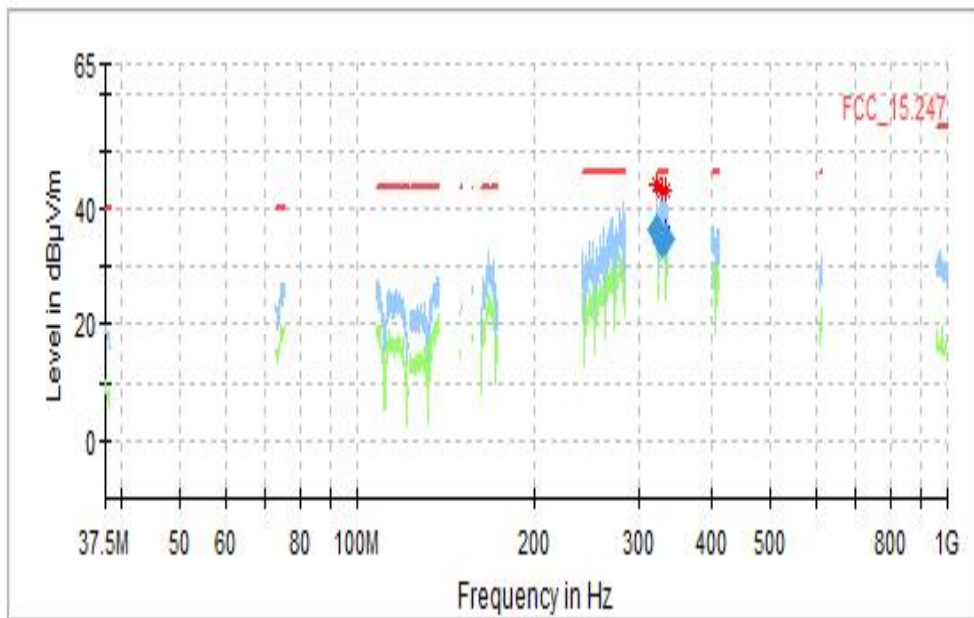

Radio Technology = Bluetooth BDR, Operating Frequency = mid, Measurement range = 30 MHz - 1 GHz
(S01_AA01)

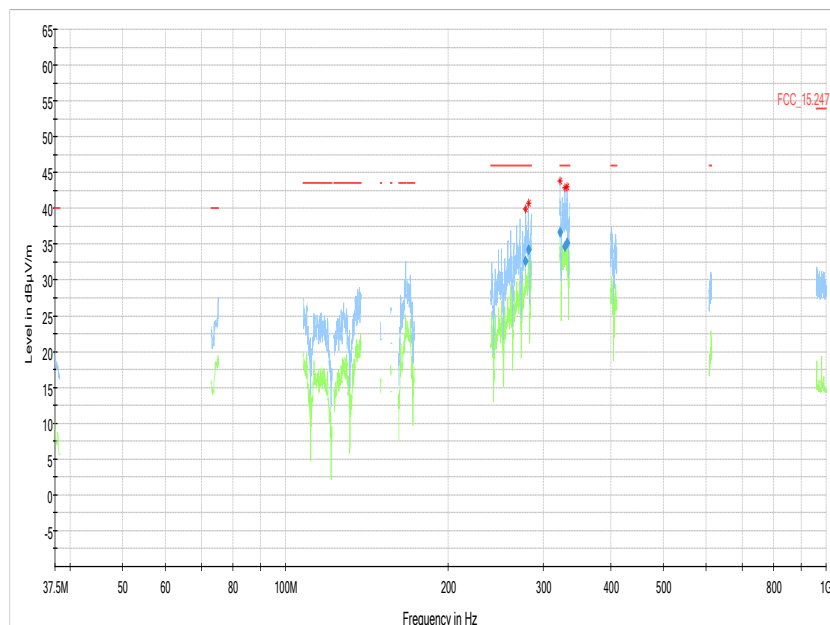

Module: UGKZ7A1001A

Radio Technology = Bluetooth EDR 2, Operating Frequency = high, Measurement range = 1 GHz - 26 GHz (S01_AA01)

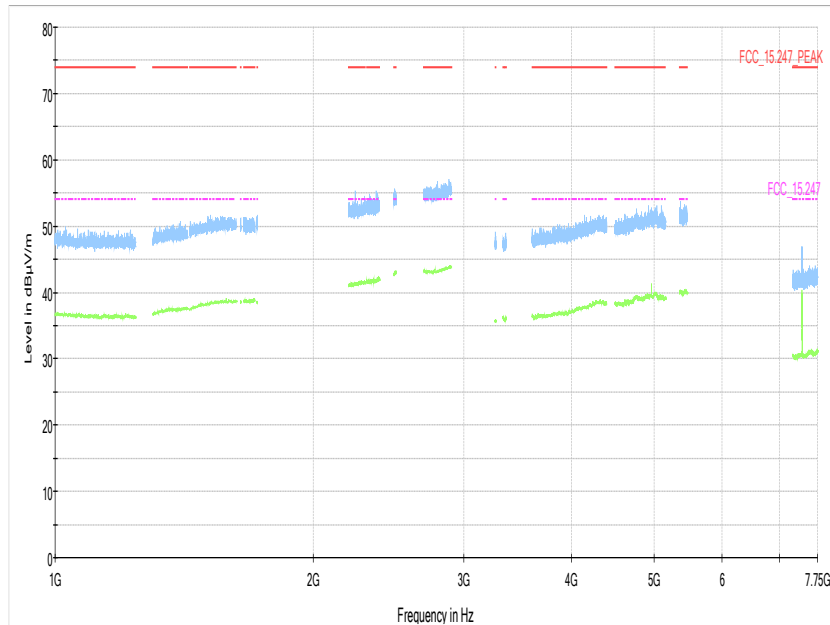

Radio Technology = Bluetooth EDR 2, Operating Frequency = low, Measurement range = 1 GHz - 26 GHz (S01_AA01)

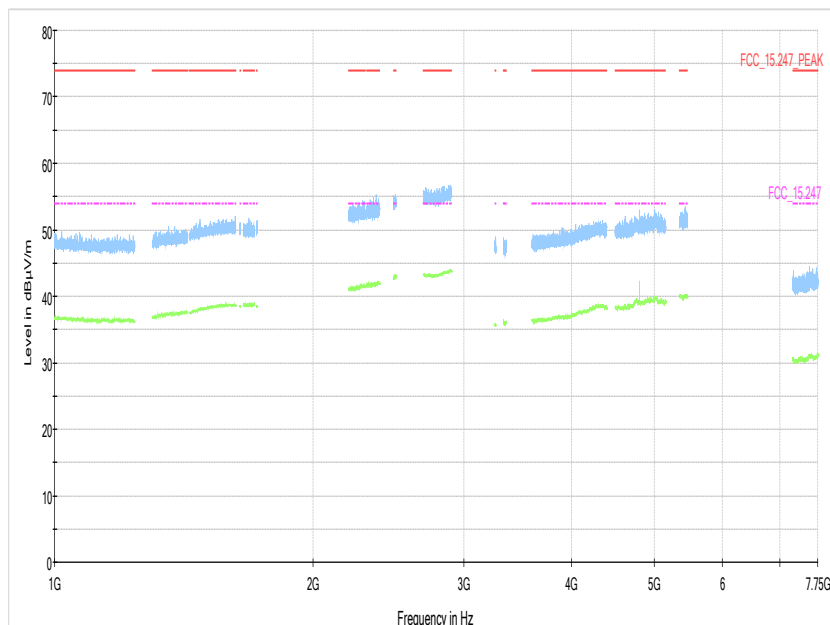

Radio Technology = Bluetooth EDR 2, Operating Frequency = mid, Measurement range = 1 GHz - 26 GHz (S01_AA01)

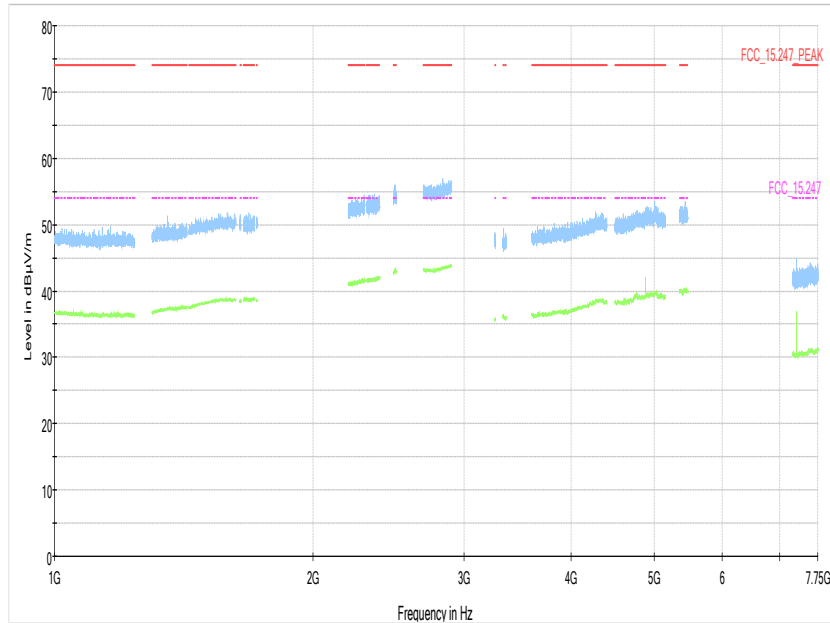

Radio Technology = Bluetooth BDR, Operating Frequency = mid, Measurement range = 9 kHz - 30 MHz (S01_AA01)

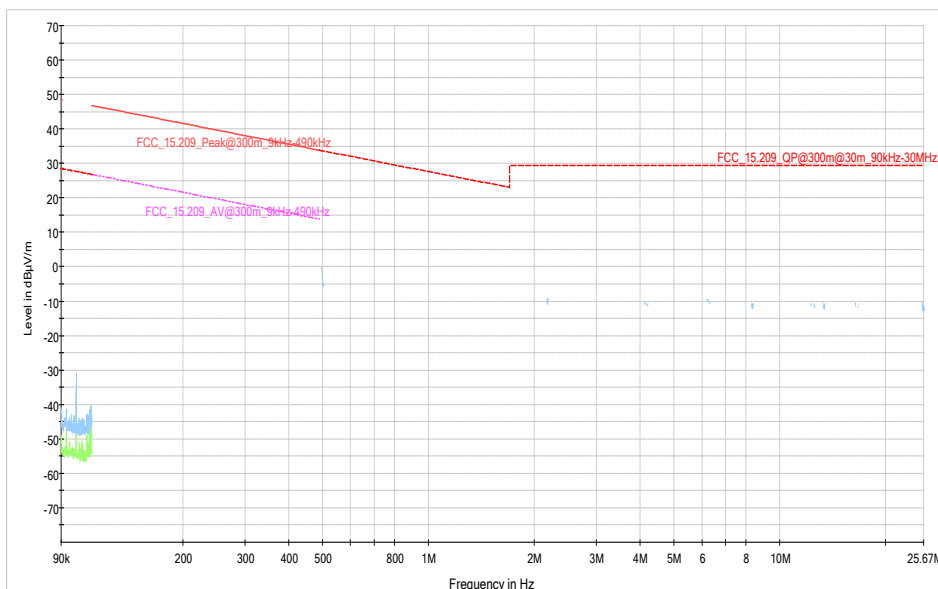

Radio Technology = Bluetooth BDR, Operating Frequency = low, Measurement range = 1 GHz
 - 26 GHz
 (S01_AA01)

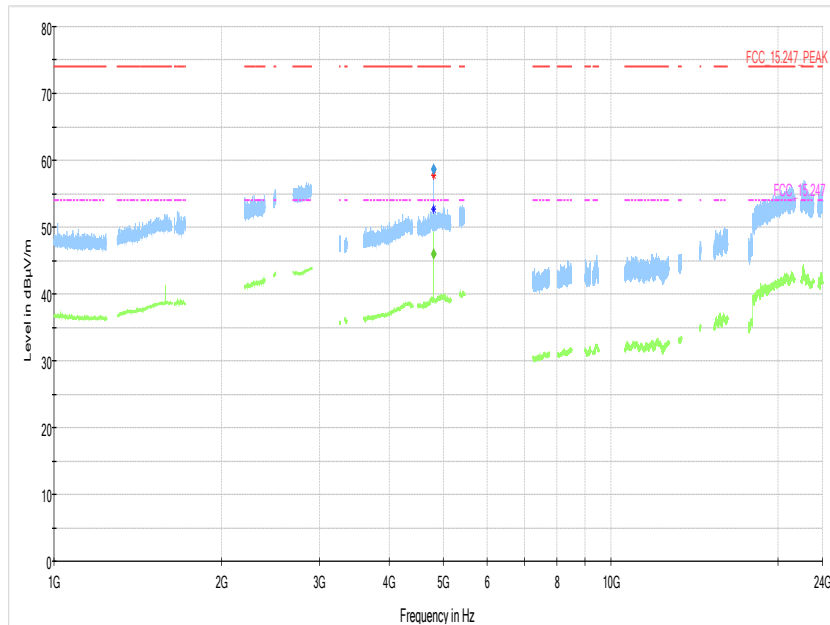

Radio Technology = Bluetooth BDR, Operating Frequency = mid, Measurement range = 1 GHz
 - 26 GHz
 (S01_AA01)

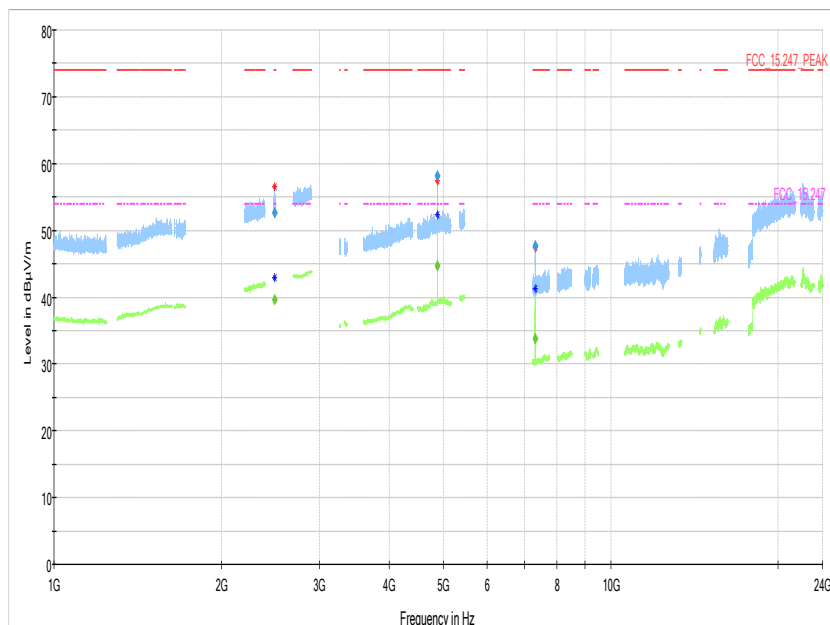

Radio Technology = Bluetooth BDR, Operating Frequency = high, Measurement range = 1 GHz - 26 GHz (S01_AA01)

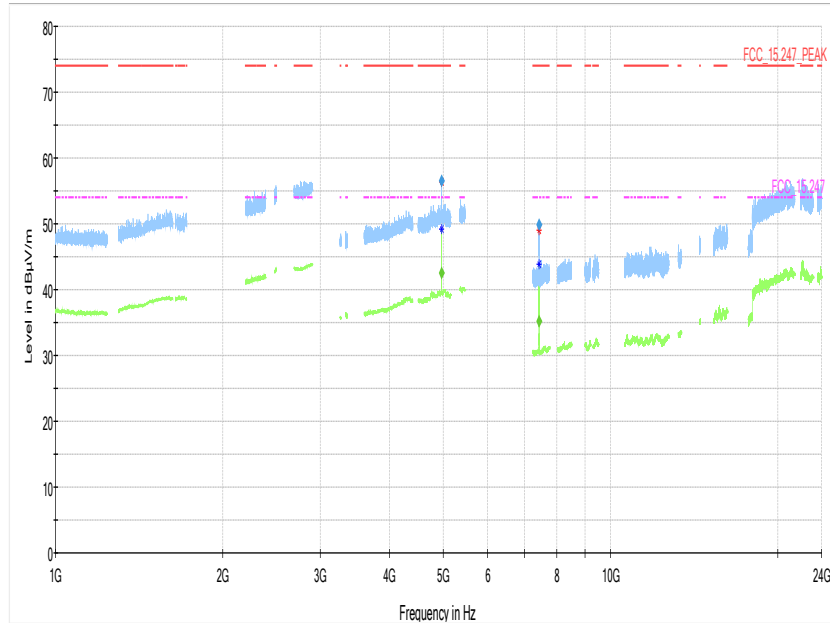

Radio Technology = Bluetooth BDR, Operating Frequency = low, Measurement range = 30 MHz - 1 GHz (S01_AA01)

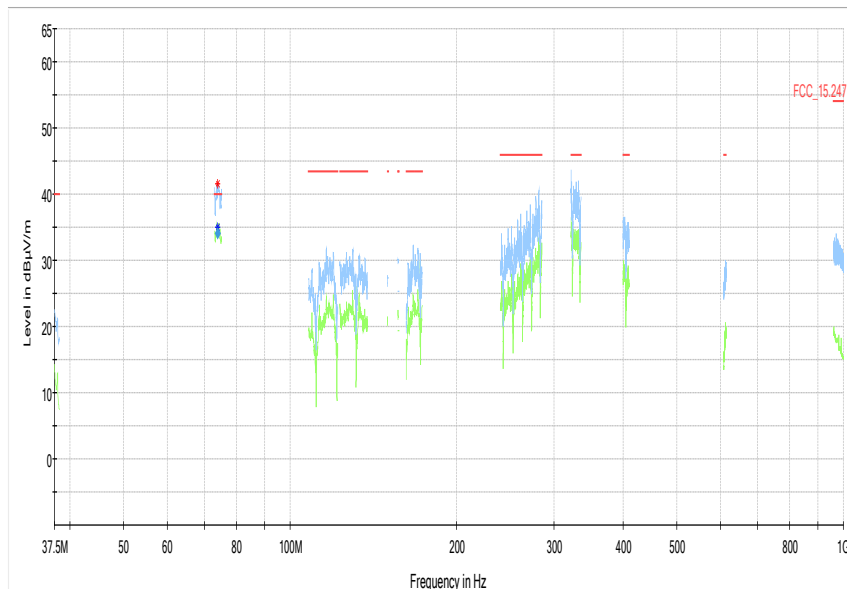

Radio Technology = Bluetooth BDR, Operating Frequency = mid, Measurement range = 30 MHz - 1 GHz (S01_AA01)

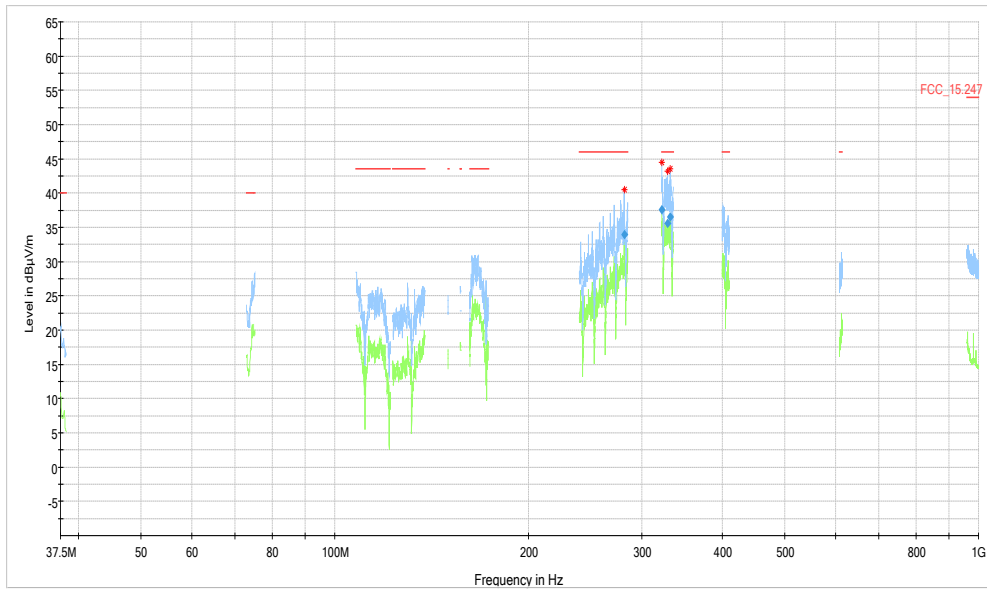

Radio Technology = Bluetooth BDR, Operating Frequency = high, Measurement range = 30 MHz - 1 GHz (S01_AA01)

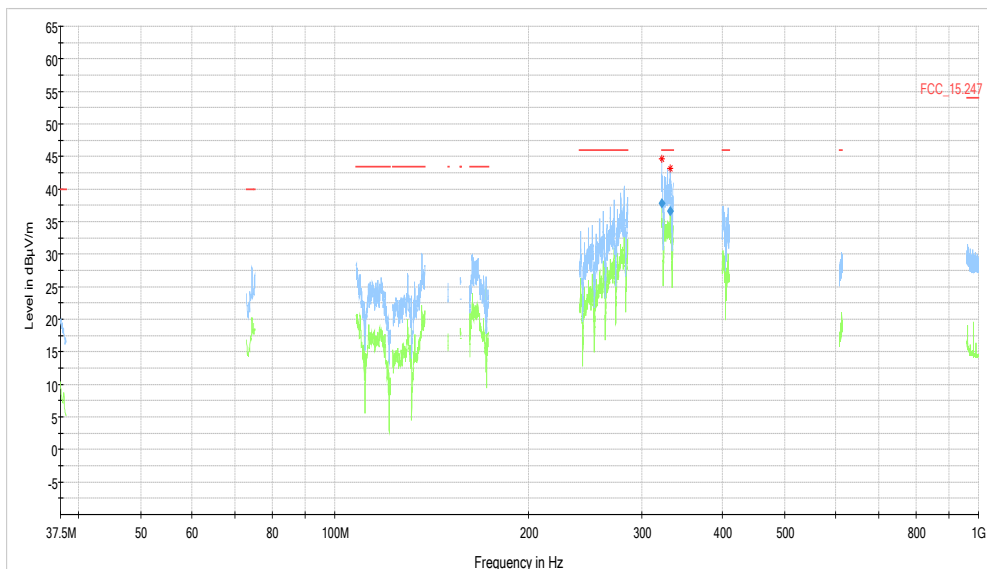

4.4.5 TEST EQUIPMENT USED

- Radiated Emissions

4.5 BAND EDGE COMPLIANCE CONDUCTED

Standard **FCC Part 15 Subpart C**

The test was performed according to:
ANSI C63.10

4.5.1 TEST DESCRIPTION

For the conducted measurement, the Equipment Under Test (EUT) is placed in a shielded room. The reference power was measured in the test case "Spurious RF Conducted Emissions". The EUT was connected to the spectrum analyzer via a short coax cable with a known loss.

Analyzer settings:

- Lower Band Edge:
Minimum frequency: 2397.0 MHz
Upper Band Edge
Maximum frequency: 2485.0 MHz
- Span:
Bluetooth: 6 MHz
WLAN: 25 / 45 / 85 MHz [depending on channel bandwidth]
- Detector: Peak
- Resolution Bandwidth (RBW): 100 kHz
- Video Bandwidth (VBW): 300 kHz
- Sweptime: 5 ms
- Sweeps: 2000
- Trace: Maxhold

4.5.2 TEST REQUIREMENTS / LIMITS

FCC Part 15.247 (d)

"In any 100 kHz bandwidth outside the frequency band in which the spread spectrum or digitally modulated intentional radiator is operating, the radio frequency power that is produced by the intentional radiator shall be at least 20 dB below that in the 100 kHz bandwidth within the band that contains the highest level of the desired power, based on either an RF conducted or a radiated measurement, provided the transmitter demonstrates compliance with the peak conducted power limits. ...

If the transmitter complies with the conducted power limits based on the use of RMS averaging over a time interval, as permitted under paragraph (b)(3) of this section, the attenuation required under this paragraph shall be 30 dB instead of 20 dB. Attenuation below the general limits specified in Section 15.209(a) is not required. In addition, radiated emissions which fall in the restricted bands, as defined in Section 15.205(a), must also comply with the radiated emission limits specified in Section 15.209(a) (see Section 15.205(c))."

For the conducted measurement the RF power at the band edge shall be "at least 20 dB below that in the 100 kHz bandwidth within the band that contains the highest level of the desired power..."

4.5.3 TEST PROTOCOL

Module: UGXZEX304A

Ambient temperature: 22°C
 Air Pressure: 1010hPa
 Humidity: 38%
 BT GFSK (1-DH1)

Channel No.	Channel Center Frequency [MHz]	Band Edge Freq. [MHz]	Spurious Level [dBm]	Detector	RBW [kHz]	Ref. Level [dBm]	Limit [dBm]	Margin to Limit [dB]
0	2402	2400.0	-53.4	PEAK	100	-2.8	-22.8	30.6
78	2480	2483.5	-64.6	PEAK	100	-2.0	-22.0	42.7
hopping	hopping	2400.0	-54.9	PEAK	100	-3.3	-23.3	31.6
hopping	hopping	2483.5	-62.6	PEAK	100	-1.9	-21.9	40.7

BT n/4 DQPSK (2-DH1)

Channel No.	Channel Center Frequency [MHz]	Band Edge Freq. [MHz]	Spurious Level [dBm]	Detector	RBW [kHz]	Ref. Level [dBm]	Limit [dBm]	Margin to Limit [dB]
0	2402	2400.0	-44.6	PEAK	100	-3.5	-23.5	21.1
78	2480	2483.5	-64.4	PEAK	100	-2.6	-22.6	41.8
hopping	hopping	2400.0	-44.8	PEAK	100	-3.7	-23.7	21.1
hopping	hopping	2483.5	-62.8	PEAK	100	-2.6	-22.6	40.2

BT 8-DPSK (3-DH1)

Channel No.	Channel Center Frequency [MHz]	Band Edge Freq. [MHz]	Spurious Level [dBm]	Detector	RBW [kHz]	Ref. Level [dBm]	Limit [dBm]	Margin to Limit [dB]
0	2402	2400.0	-44.6	PEAK	100	-3.7	-23.7	21.0
78	2480	2483.5	-63.8	PEAK	100	-2.7	-22.7	41.1
hopping	hopping	2400.0	-44.9	PEAK	100	-3.6	-23.6	21.3
hopping	hopping	2483.5	-62.2	PEAK	100	-2.5	-22.5	39.7

Module: UGKZ7A1001A

Ambient temperature: 22 °C
 Air Pressure: 1010 hPa
 Humidity: 34 %
 BT GFSK (1-DH1)

Channel No.	Channel Center Frequency [MHz]	Band Edge Freq. [MHz]	Spurious Level [dBm]	Detector	RBW [kHz]	Ref. Level [dBm]	Limit [dBm]	Margin to Limit [dB]
0	2402	2400.0	-62.4	PEAK	100	-5.1	-25.1	37.3
78	2480	2483.5	-56.6	PEAK	100	-4.1	-24.1	32.5
hopping	hopping	2400.0	-63.0	PEAK	100	-4.7	-24.7	38.4
hopping	hopping	2483.5	-62.8	PEAK	100	-4.2	-24.2	38.6

BT π/4 DQPSK (2-DH1)

Channel No.	Channel Center Frequency [MHz]	Band Edge Freq. [MHz]	Spurious Level [dBm]	Detector	RBW [kHz]	Ref. Level [dBm]	Limit [dBm]	Margin to Limit [dB]
0	2402	2400.0	-60.1	PEAK	100	-4.4	-24.4	35.7
78	2480	2483.5	-57.5	PEAK	100	-3.7	-23.7	33.8
hopping	hopping	2400.0	-59.0	PEAK	100	-4.3	-24.3	34.7
hopping	hopping	2483.5	-62.4	PEAK	100	-3.9	-23.9	38.5

BT 8-DPSK (3-DH1)

Channel No.	Channel Center Frequency [MHz]	Band Edge Freq. [MHz]	Spurious Level [dBm]	Detector	RBW [kHz]	Ref. Level [dBm]	Limit [dBm]	Margin to Limit [dB]
0	2402	2400.0	-57.6	PEAK	100	-4.4	-24.4	33.2
78	2480	2483.5	-62.4	PEAK	100	-3.7	-23.7	38.7
hopping	hopping	2400.0	-57.9	PEAK	100	-4.4	-24.4	33.4
hopping	hopping	2483.5	-60.3	PEAK	100	-4.0	-24.0	36.3

Remark: Please see next sub-clause for the measurement plot.

4.5.4 MEASUREMENT PLOT (SHOWING THE HIGHEST VALUE, "WORST CASE")

Module: UGXZEX304A

Radio Technology = Bluetooth BDR, Operating Frequency = low, Band Edge = low (S01_AB01)

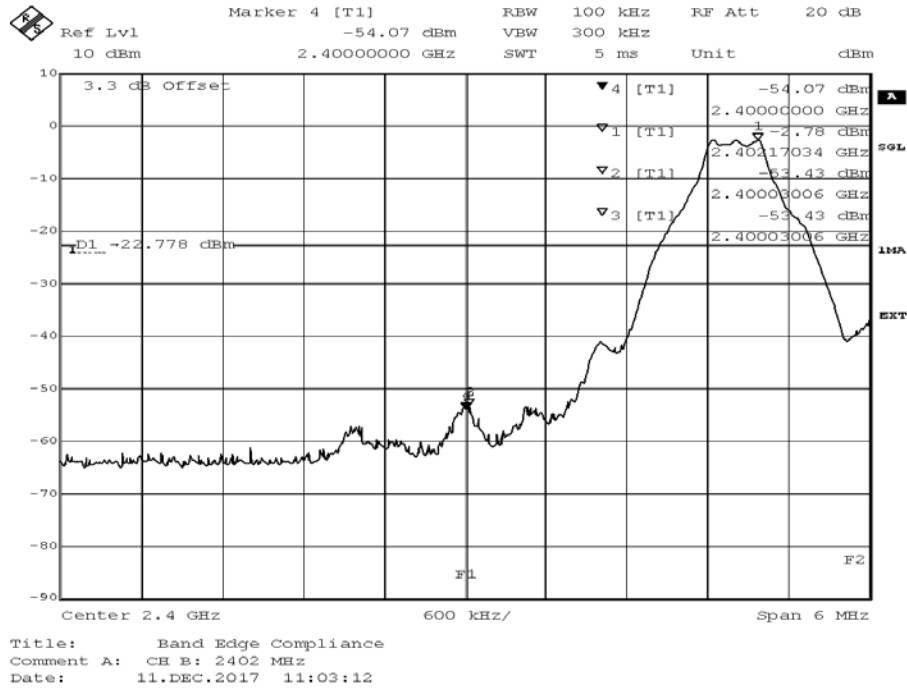

Radio Technology = Bluetooth BDR, Operating Frequency = high, Band Edge = high (S01_AB01)

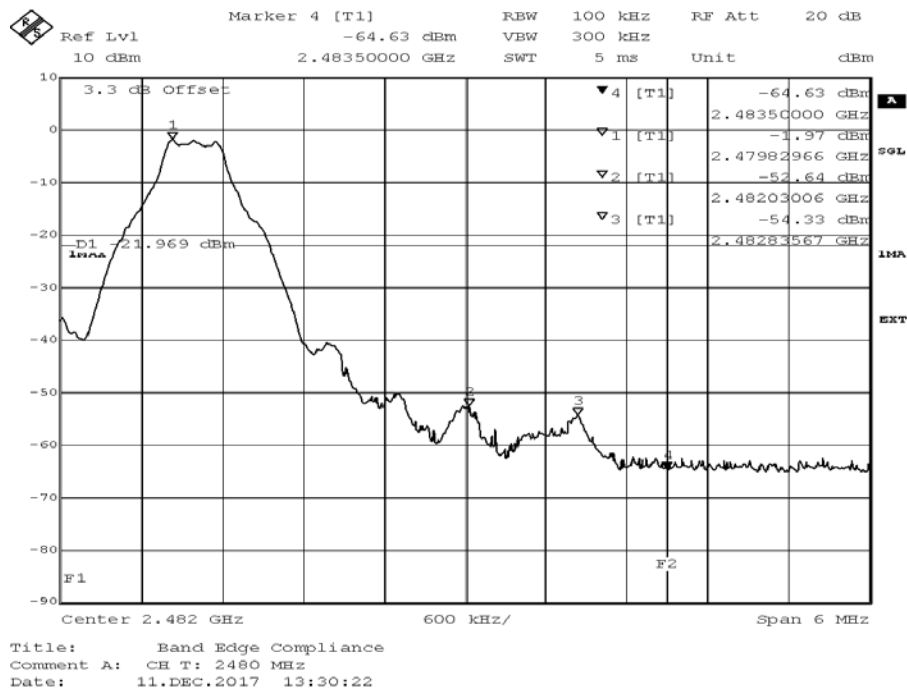

Radio Technology = Bluetooth BDR, Operating Frequency = hopping, Band Edge = low (S01_AB01)

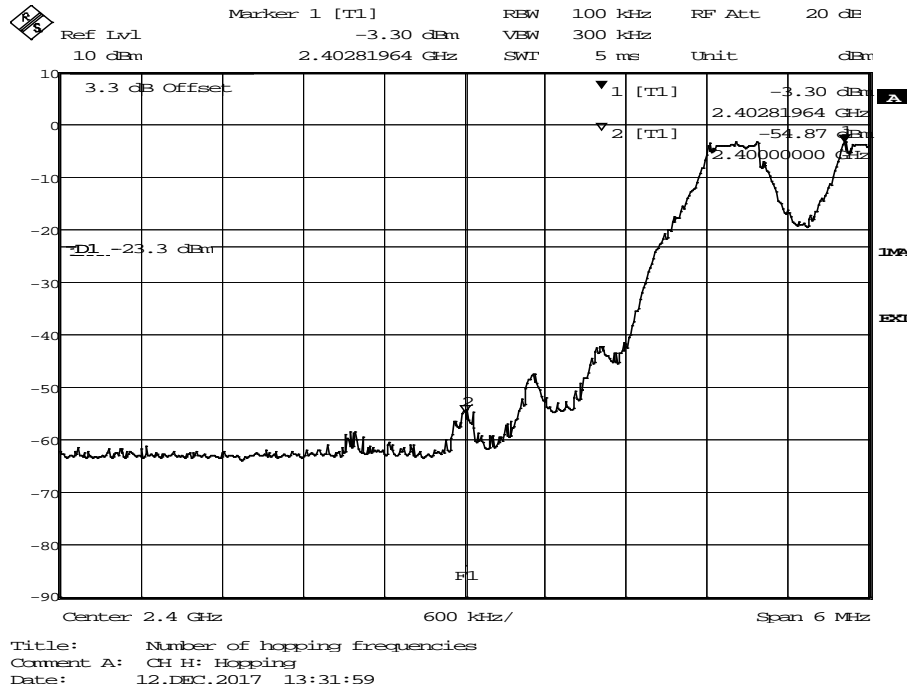

Radio Technology = Bluetooth BDR, Operating Frequency = hopping, Band Edge = high (S01_AB01)

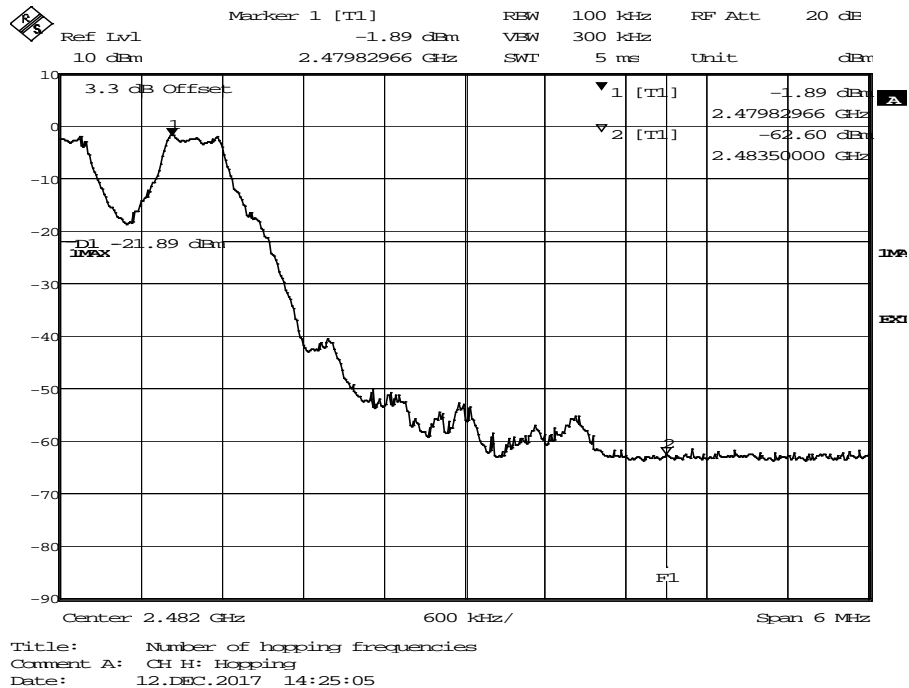

Radio Technology = Bluetooth EDR 2, Operating Frequency = low, Band Edge = low (S01_AB01)

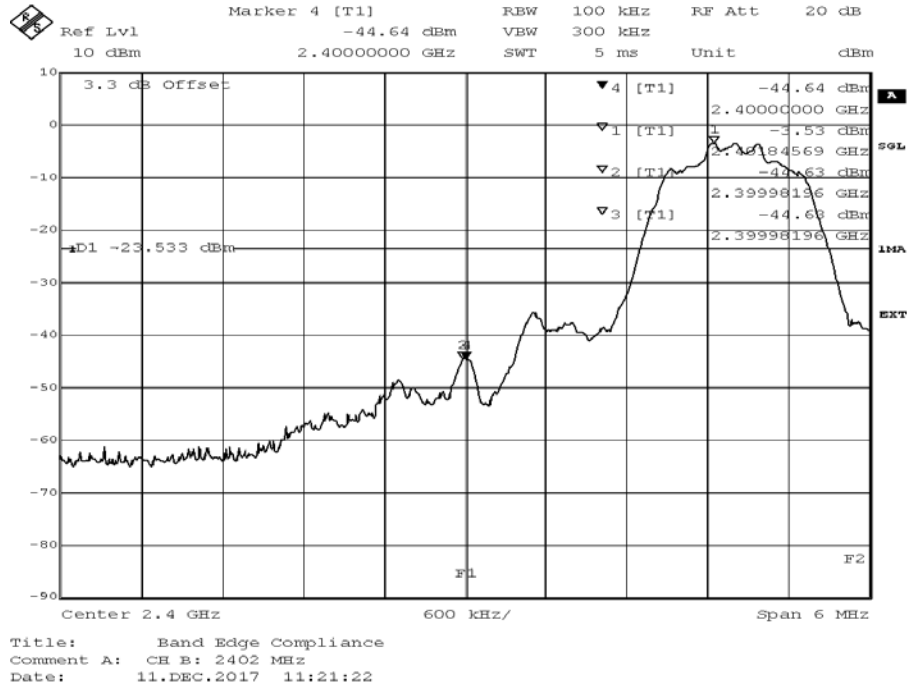

Radio Technology = Bluetooth EDR 2, Operating Frequency = high, Band Edge = high (S01_AB01)

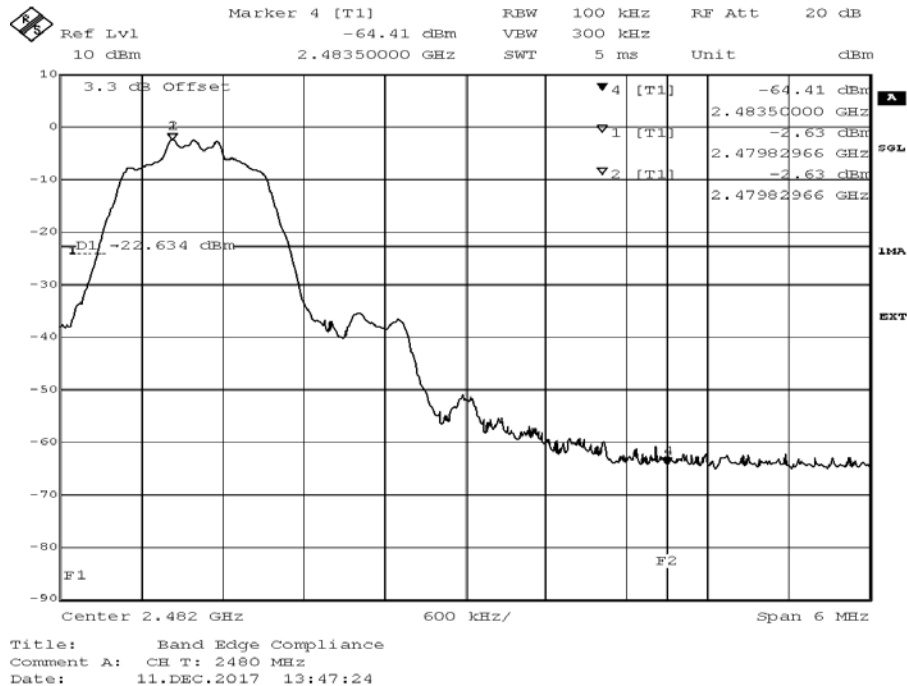

Radio Technology = Bluetooth EDR 2, Operating Frequency = hopping, Band Edge = low (S01_AB01)

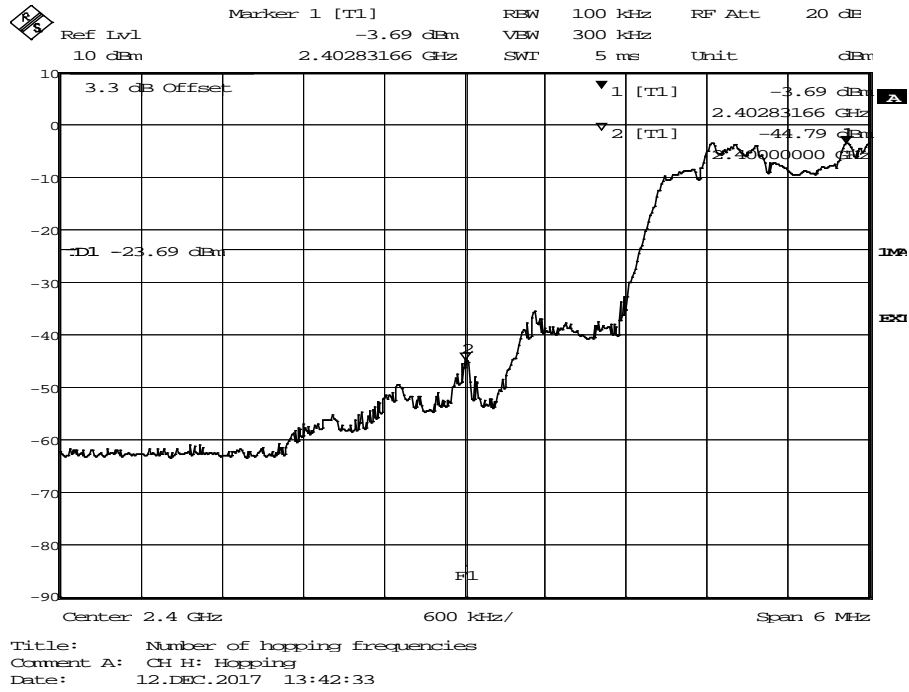

Radio Technology = Bluetooth EDR 2, Operating Frequency = hopping, Band Edge = high (S01_AB01)

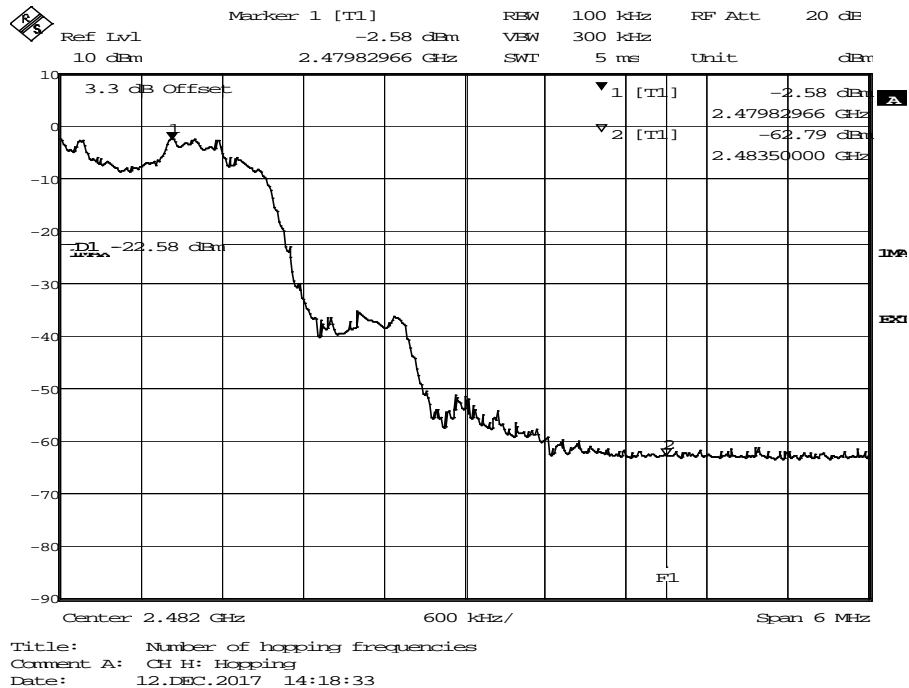

Radio Technology = Bluetooth EDR 3, Operating Frequency = low, Band Edge = low (S01_AB01)

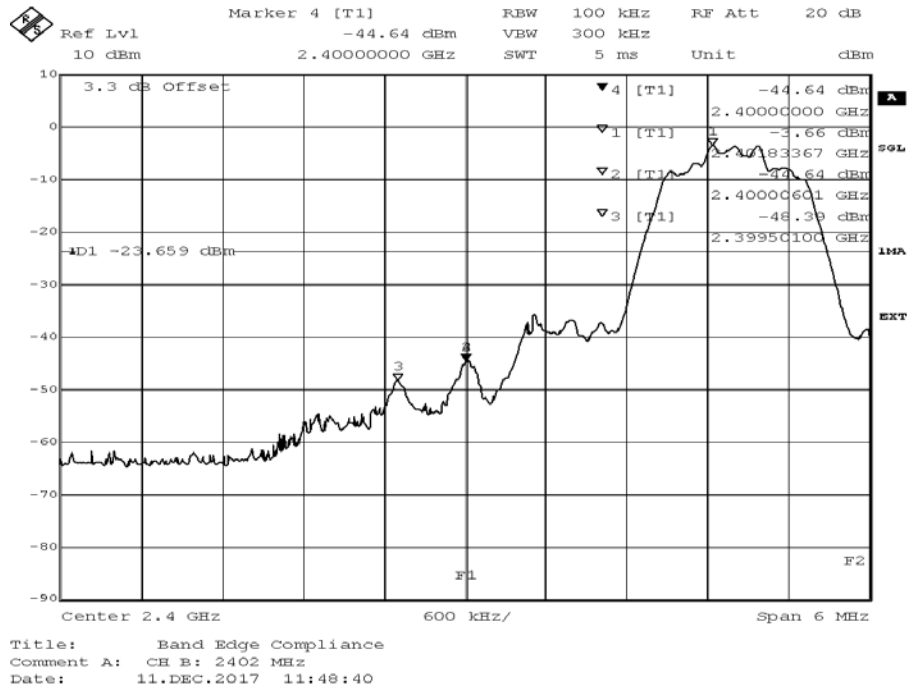

Radio Technology = Bluetooth EDR 3, Operating Frequency = high, Band Edge = high (S01_AB01)

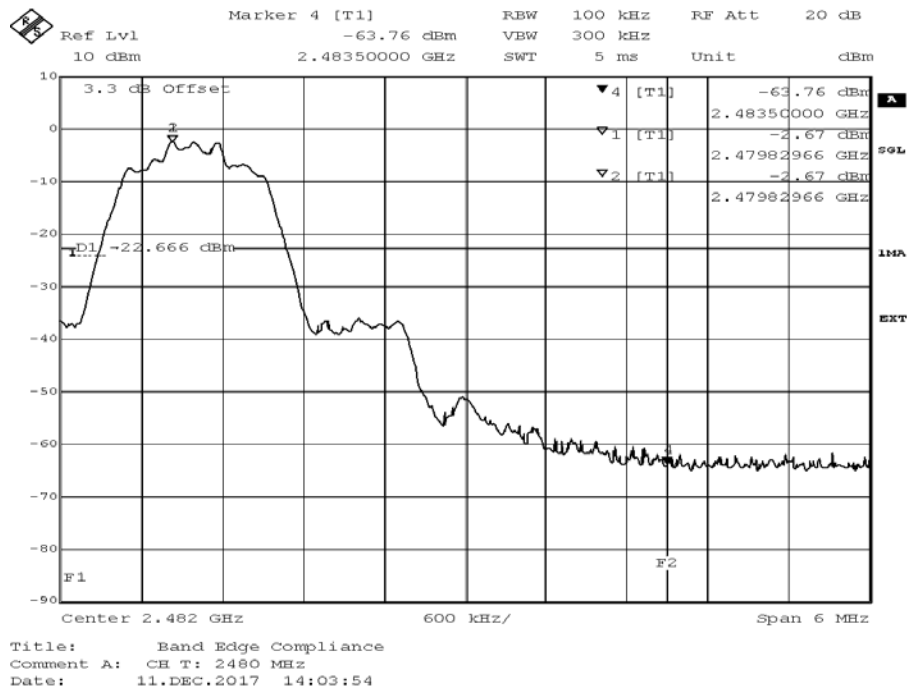

Radio Technology = Bluetooth EDR 3, Operating Frequency = hopping, Band Edge = low (S01_AB01)

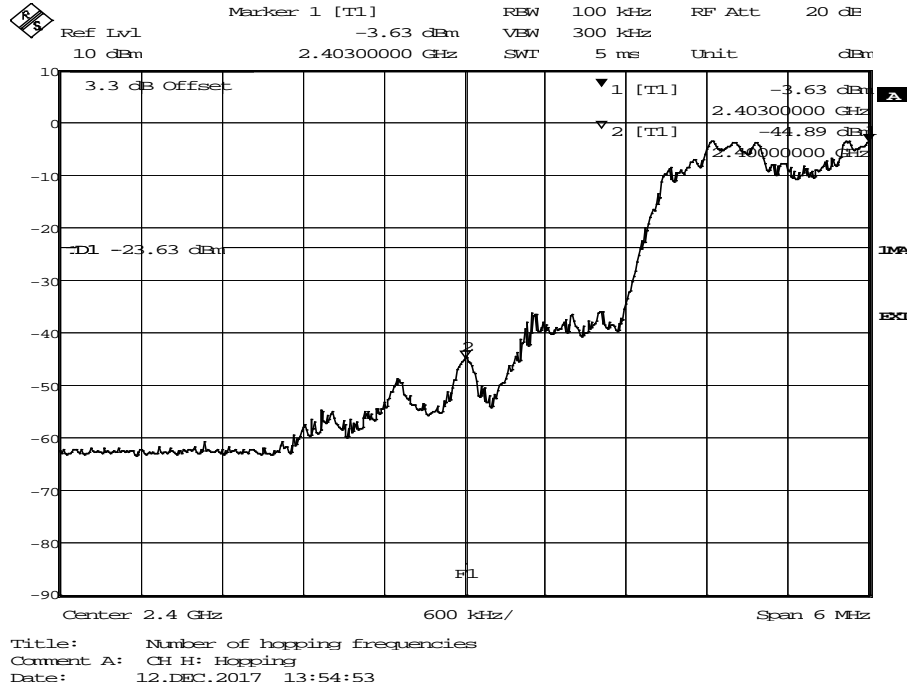

Radio Technology = Bluetooth EDR 3, Operating Frequency = hopping, Band Edge = high (S01_AB01)

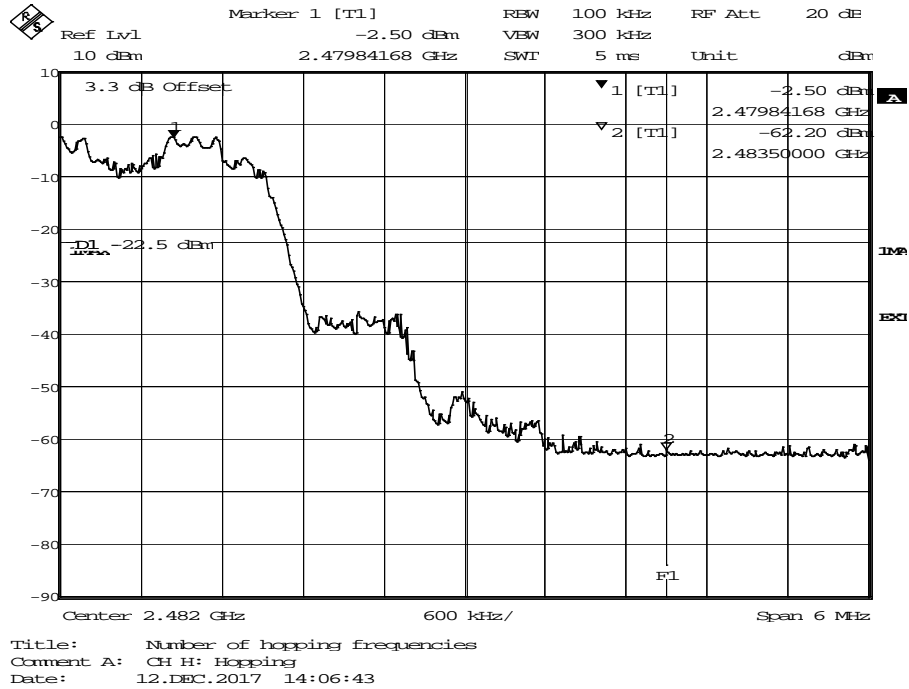

Module: UGKZ7A1001A

Radio Technology = Bluetooth BDR, Operating Frequency = low, Band Edge = low
(S01_AB01)

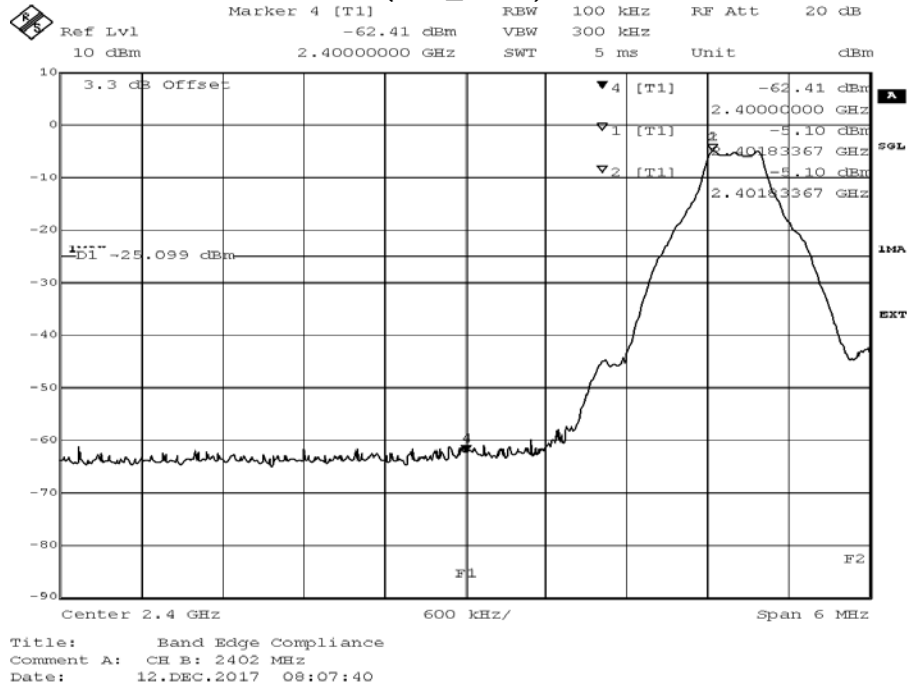

Radio Technology = Bluetooth BDR, Operating Frequency = high, Band Edge = high
(S01_AB01)

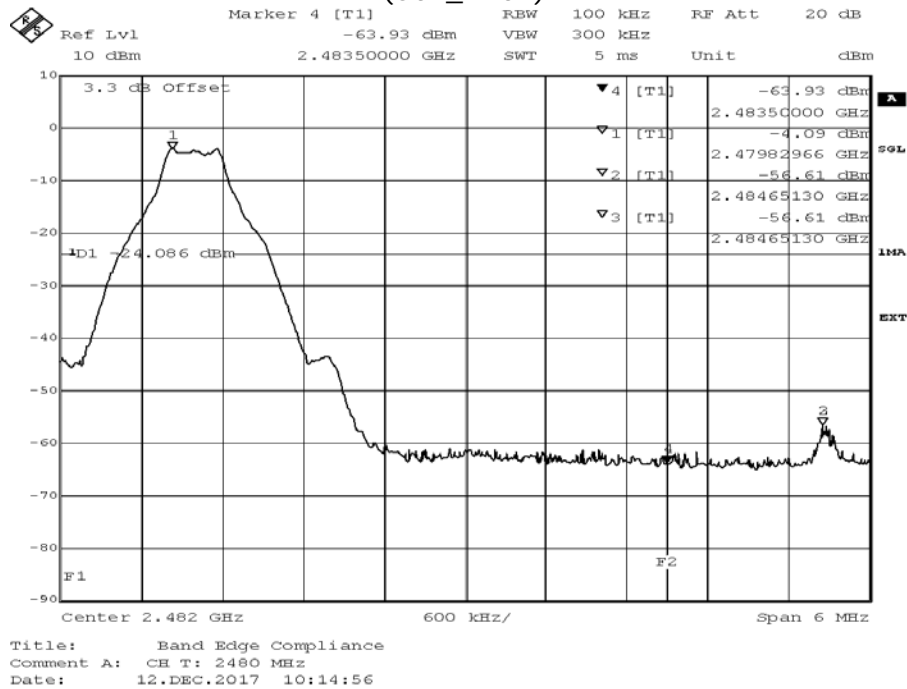

Radio Technology = Bluetooth BDR, Operating Frequency = hopping, Band Edge = low
(S01_AB01)

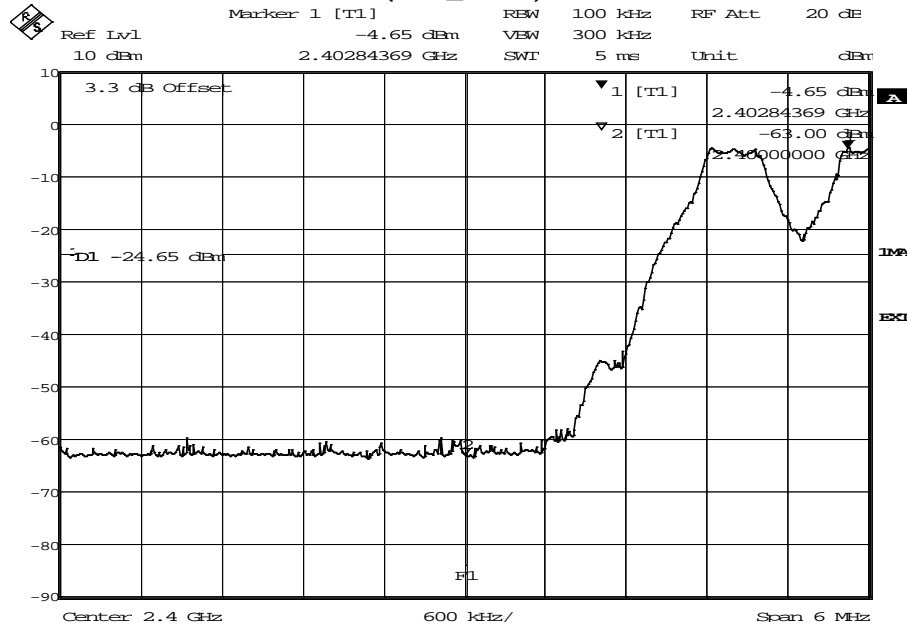

Title: Number of hopping frequencies
 Comment A: CH H: Hopping
 Date: 12.DEC.2017 12:51:15

Radio Technology = Bluetooth BDR, Operating Frequency = hopping, Band Edge = high
(S01_AB01)

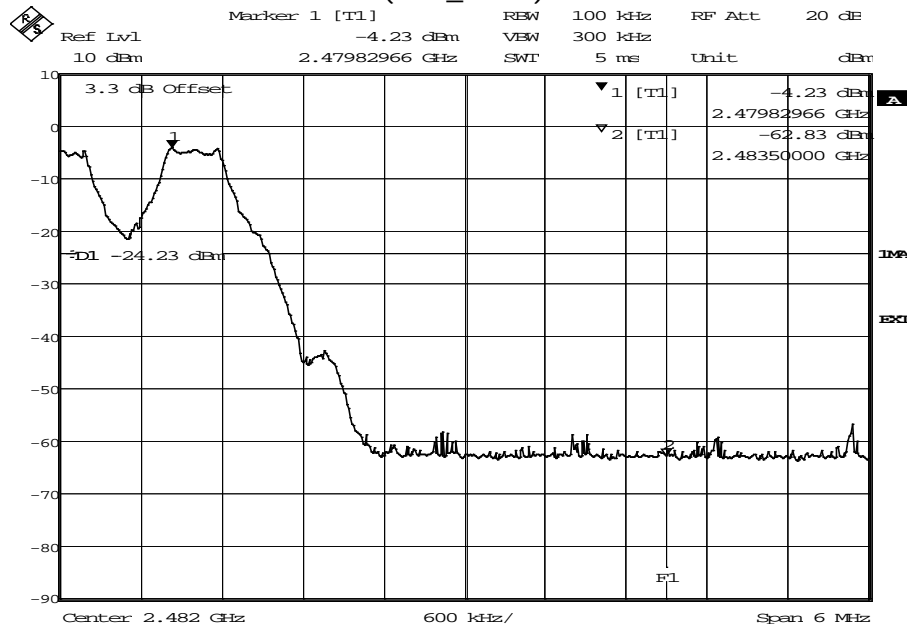

Title: Number of hopping frequencies
 Comment A: CH H: Hopping
 Date: 12.DEC.2017 14:35:06

Radio Technology = Bluetooth EDR 2, Operating Frequency = hopping, Band Edge = low
(S01_AB01)

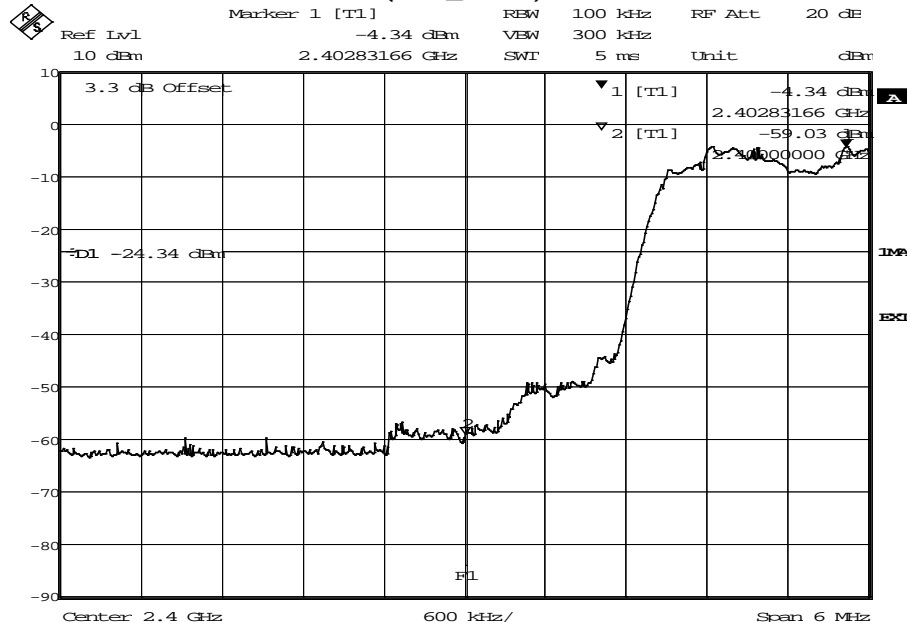

Title: Number of hopping frequencies
Comment A: CH H: Hopping
Date: 12.DEC.2017 13:03:18

Radio Technology = Bluetooth EDR 2, Operating Frequency = hopping, Band Edge = high
(S01_AB01)

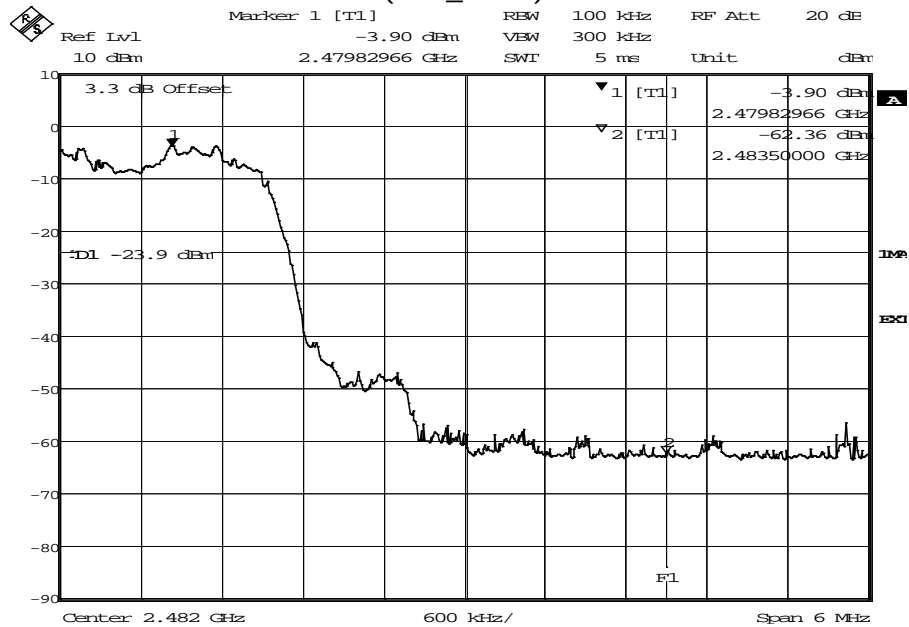

Title: Number of hopping frequencies
Comment A: CH H: Hopping
Date: 12.DEC.2017 14:47:31

Radio Technology = Bluetooth EDR 3, Operating Frequency = low, Band Edge = low
(S01_AB01)

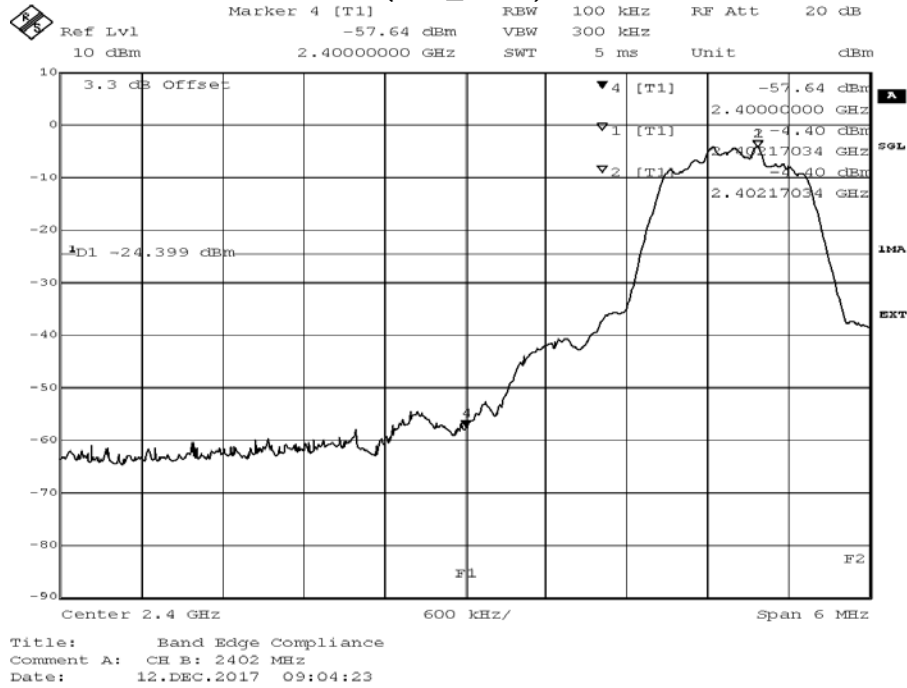

Radio Technology = Bluetooth EDR 3, Operating Frequency = high, Band Edge = high
(S01_AB01)

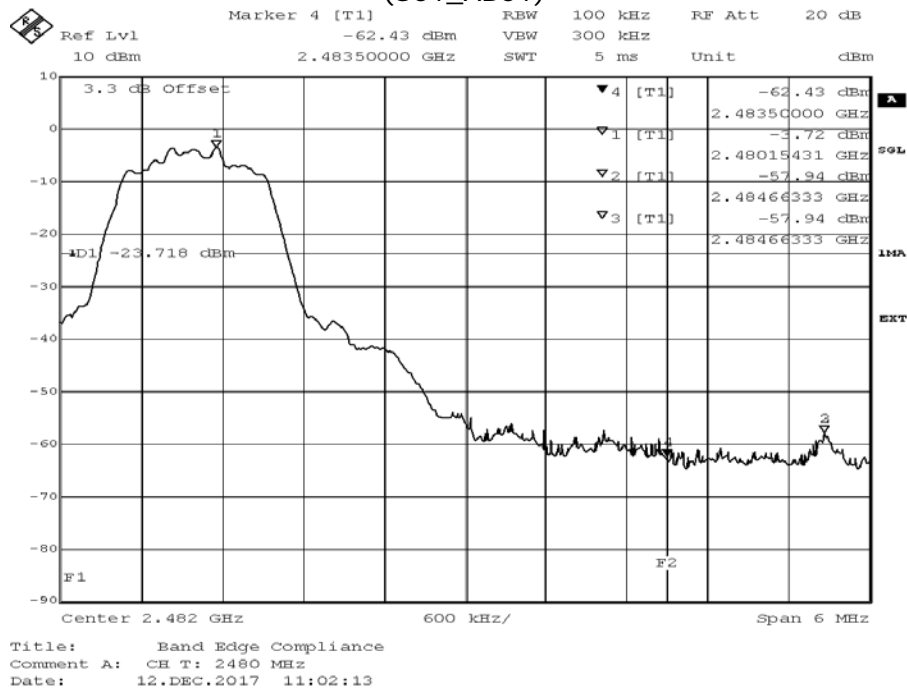

Radio Technology = Bluetooth EDR 3, Operating Frequency = hopping, Band Edge = low
(S01_AB01)

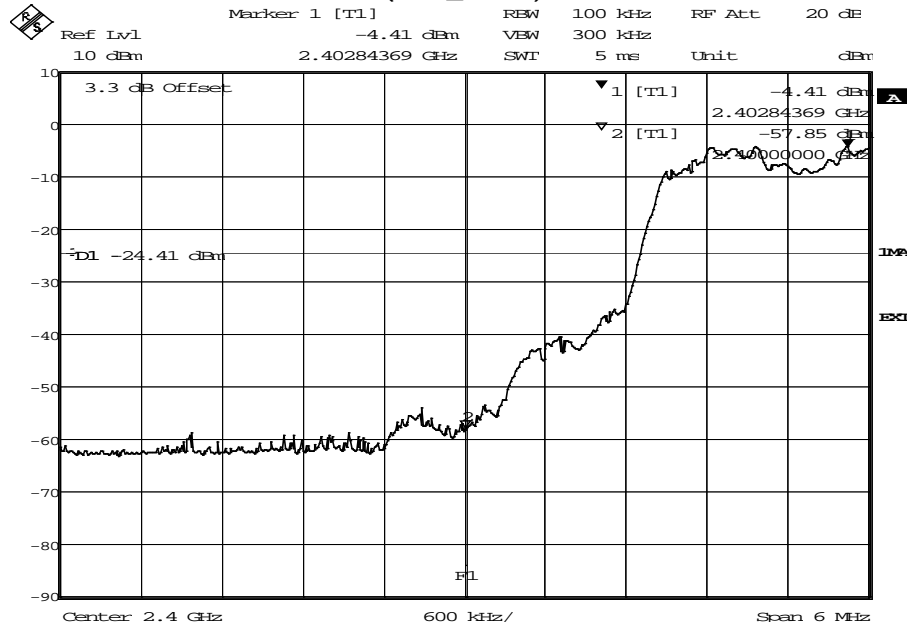

Title: Number of hopping frequencies
Comment A: CH H: Hopping
Date: 12.DEC.2017 13:21:41

Radio Technology = Bluetooth EDR 3, Operating Frequency = hopping, Band Edge = high
(S01_AB01)

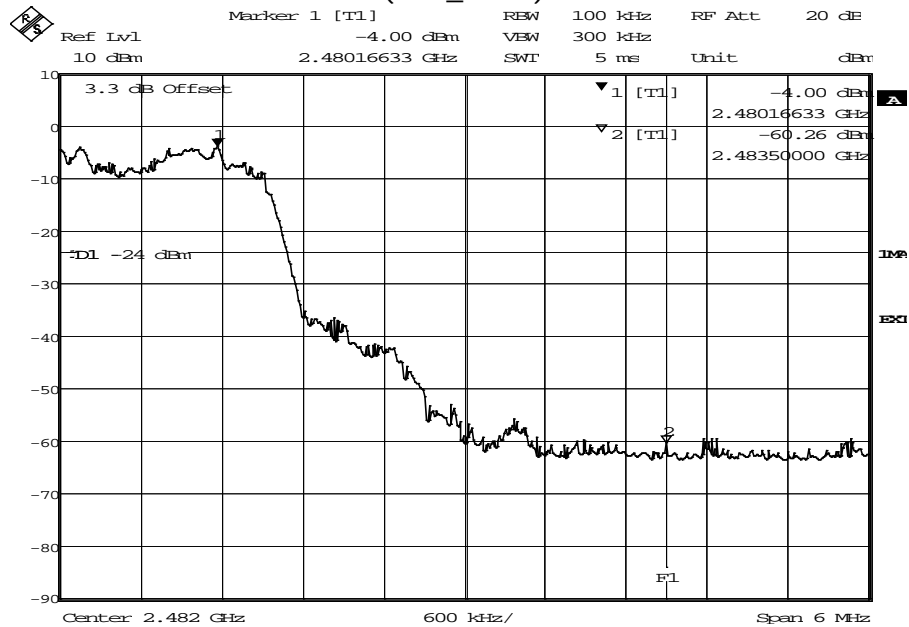

Title: Number of hopping frequencies
Comment A: CH H: Hopping
Date: 12.DEC.2017 14:55:01

4.5.5 TEST EQUIPMENT USED

- Regulatory Bluetooth RF Test Solution

4.6 BAND EDGE COMPLIANCE RADIATED

Standard **FCC Part 15 Subpart C**

The test was performed according to:
ANSI C63.10

4.6.1 TEST DESCRIPTION

Please see test description for the test case "Spurious Radiated Emissions"

4.6.2 TEST REQUIREMENTS / LIMITS

For band edges connected to a restricted band, the limits are specified in Section 15.209(a)

FCC Part 15, Subpart C, §15.209, Radiated Emission Limits

Frequency in MHz	Limit (µV/m)	Measurement distance (m)	Limits (dBµV/m)
0.009 – 0.49	2400/F(kHz)@300m	3	(48.5 – 13.8)@300m
0.49 – 1.705	24000/F(kHz)@30m	3	(33.8 – 23.0)@30m
1.705 – 30	30@30m	3	29.5@30m

The measured values are corrected with an inverse linear distance extrapolation factor (40 dB/decade) according FCC 15.31 (2).

Frequency in MHz	Limit (µV/m)	Measurement distance (m)	Limits (dBµV/m)
30 – 88	100@3m	3	40.0@3m
88 – 216	150@3m	3	43.5@3m
216 – 960	200@3m	3	46.0@3m
960 - 26000	500@3m	3	54.0@3m
26000 - 40000	500@3m	1	54.0@3m

The measured values above 26 GHz are corrected with an inverse linear distance extrapolation factor (20 dB/decade).

§15.35(b) ..., there is also a limit on the radio frequency emissions, as measured using instrumentation with a peak detector function, corresponding to 20 dB above the maximum permitted average limit....

Used conversion factor: $\text{Limit (dB}\mu\text{V/m)} = 20 \log (\text{Limit } (\mu\text{V/m})/1\mu\text{V/m)}$

4.6.3 TEST PROTOCOL

Module: UGXZEX304A

Ambient temperature: 22 - 23 °C
 Air Pressure: 971 - 1004 hPa
 Humidity: 35 - 38 %
 BT GFSK (1-DH1)
 Applied duty cycle correction (AV): 0 dB

Ch. No.	Ch. Center Freq. [MHz]	Band Edge Freq. [MHz]	Spurious Level [dBμV/m]	Detector	RBW [kHz]	Limit [dBμV/m]	Margin to Limit [dB]	Limit Type
78	2480	2483.5	54.6	PEAK	1000	74.0	19.4	BE
78	2480	2483.5	39.2	AV	1000	54.0	14.8	BE

BT π/4 DQPSK (2-DH1)
 Applied duty cycle correction (AV): 0 dB

Ch. No.	Ch. Center Freq. [MHz]	Band Edge Freq. [MHz]	Spurious Level [dBμV/m]	Detector	RBW [kHz]	Limit [dBμV/m]	Margin to Limit [dB]	Limit Type
78	2480	2483.5	52.2	PEAK	1000	74.0	21.8	BE
78	2480	2483.5	39.4	AV	1000	54.0	14.6	BE

BT 8-DPSK (3-DH1)
 Applied duty cycle correction (AV): 0 dB

Ch. No.	Ch. Center Freq. [MHz]	Band Edge Freq. [MHz]	Spurious Level [dBμV/m]	Detector	RBW [kHz]	Limit [dBμV/m]	Margin to Limit [dB]	Limit Type
78	2480	2483.5	52.9	PEAK	1000	74.0	21.1	BE
78	2480	2483.5	40.0	AV	1000	54.0	14.0	BE

Module: UGKZ7A1001A

Applied duty cycle correction (AV): 0 dB

Ch. No.	Ch. Center Freq. [MHz]	Band Edge Freq. [MHz]	Spurious Level [dBμV/m]	Detector	RBW [kHz]	Limit [dBμV/m]	Margin to Limit [dB]	Limit Type
78	2480	2483.5	54.6	PEAK	1000	74.0	19.4	BE
78	2480	2483.5	39.2	AV	1000	54.0	14.8	BE

BT π/4 DQPSK (2-DH1)
 Applied duty cycle correction (AV): 0 dB

Ch. No.	Ch. Center Freq. [MHz]	Band Edge Freq. [MHz]	Spurious Level [dBμV/m]	Detector	RBW [kHz]	Limit [dBμV/m]	Margin to Limit [dB]	Limit Type
78	2480	2483.5	55.2	PEAK	1000	74.0	18.8	BE
78	2480	2483.5	39.3	AV	1000	54.0	14.7	BE

BT 8-DPSK (3-DH1)
 Applied duty cycle correction (AV): 0 dB

Ch. No.	Ch. Center Freq. [MHz]	Band Edge Freq. [MHz]	Spurious Level [dBμV/m]	Detector	RBW [kHz]	Limit [dBμV/m]	Margin to Limit [dB]	Limit Type
78	2480	2483.5	54.9	PEAK	1000	74.0	19.1	BE
78	2480	2483.5	39.4	AV	1000	54.0	14.6	BE

Remark: Please see next sub-clause for the measurement plot.

4.6.4 MEASUREMENT PLOT (SHOWING THE HIGHEST VALUE, "WORST CASE")

Module: UGXZEX304A

Radio Technology = Bluetooth BDR, Operating Frequency = high, Band Edge = high (S01_AA01)

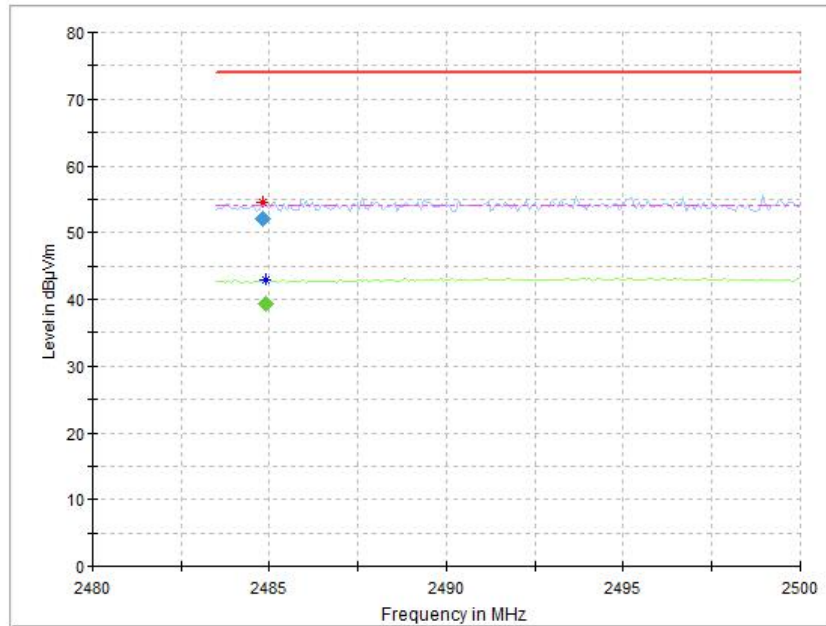

Radio Technology = Bluetooth EDR 2, Operating Frequency = high, Band Edge = high (S01_AA01)

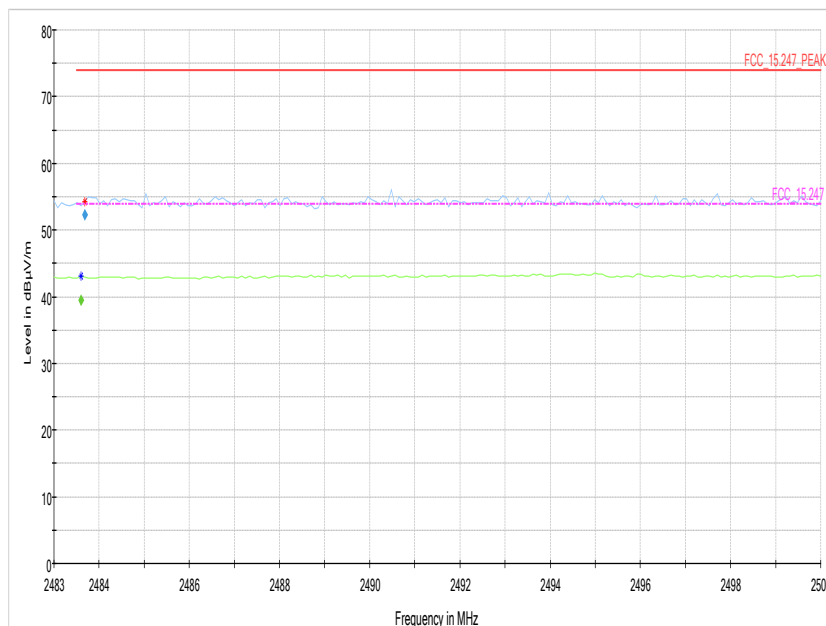

Radio Technology = Bluetooth EDR 3, Operating Frequency = high, Band Edge = high (S01_AA01)

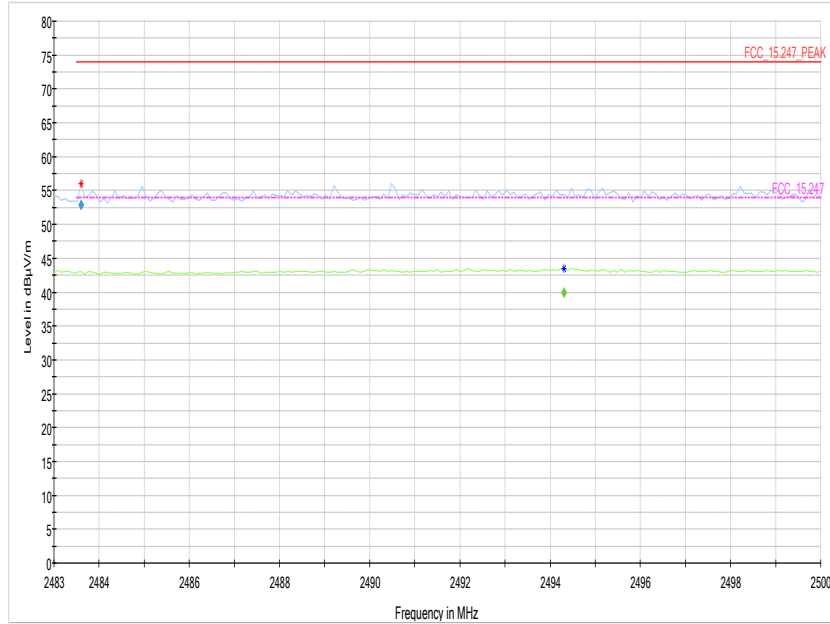

Module: UGKZ7A1001A

Radio Technology = Bluetooth BDR, Operating Frequency = high, Band Edge = high (S01_AA01)

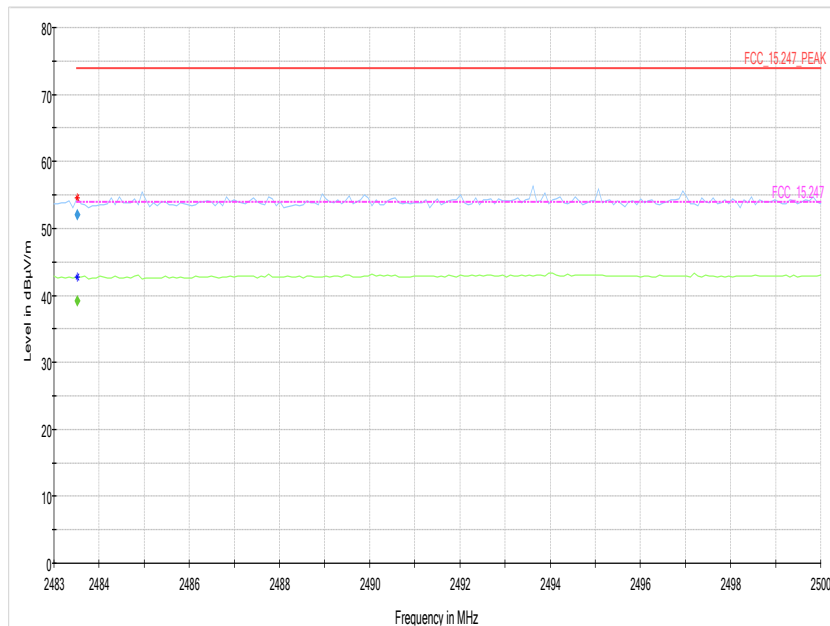

Radio Technology = Bluetooth EDR 2, Operating Frequency = high, Band Edge = high (S01_AA01)

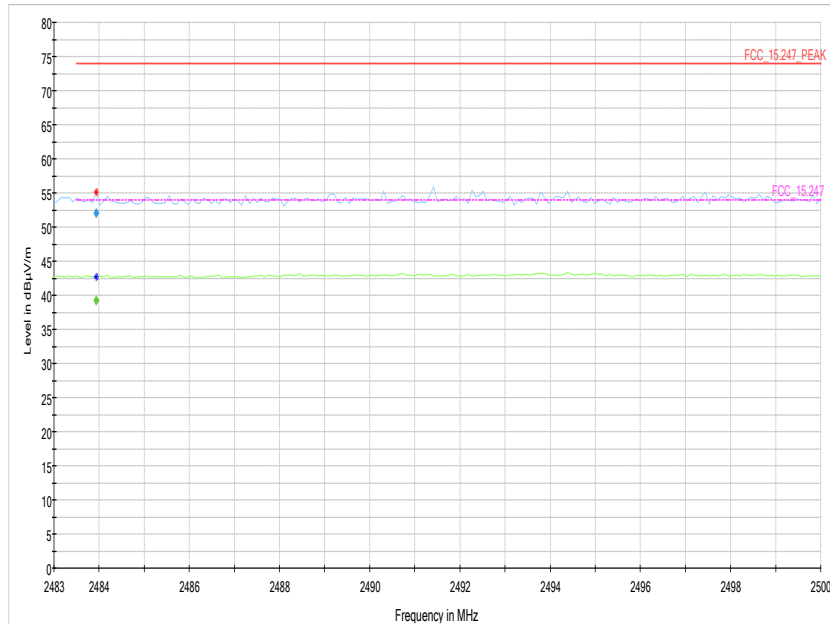

Radio Technology = Bluetooth EDR 3, Operating Frequency = high, Band Edge = high (S01_AA01)

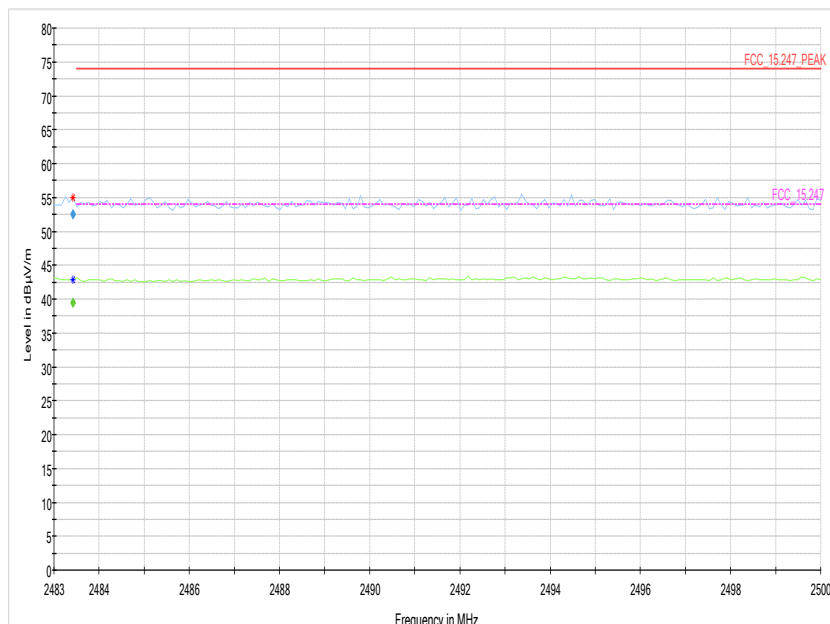

4.6.5 TEST EQUIPMENT USED

- Radiated Emissions

4.7 CHANNEL SEPARATION

Standard **FCC Part 15 Subpart C**

The test was performed according to:
ANSI C63.10

4.7.1 TEST DESCRIPTION

The Equipment Under Test (EUT) was set up to perform the channel separation measurements. The channel separation is independent from the modulation pattern.

The EUT was connected to the spectrum analyzer via a short coax cable with a known loss.

Analyzer settings:

- Detector: Peak
- Trace: Maxhold
- Span: appr. 3 x OBW
- Centre Frequency: a mid frequency of the used band
- Resolution Bandwidth (RBW): appr. 3 % of channel spacing
- Video Bandwidth (VBW): 3 x RBW
- Sweep Time: 8.5 ms
- Sweeps: 2000

The technology depending measurement parameters can be found in the measurement plot.

4.7.2 TEST REQUIREMENTS / LIMITS

FCC Part 15, Subpart C, §15.247 (a) (1)

Frequency hopping systems shall have hopping channel carrier frequencies separated by a minimum of 25 kHz or the 20 dB bandwidth of the hopping channel, whichever is greater. Alternatively, frequency hopping systems operating in the 2400–2483.5 MHz band may have hopping channel carrier frequencies that are separated by 25 kHz or two-thirds of the 20 dB bandwidth of the hopping channel, whichever is greater, provided the systems operate with an output power no greater than 125 mW. The system shall hop to channel frequencies that are selected at the system hopping rate from a pseudo randomly ordered list of hopping frequencies. Each frequency must be used equally on the average by each transmitter. The system receivers shall have input bandwidths that match the hopping channel bandwidths of their corresponding transmitters and shall shift frequencies in synchronization with the transmitted signals.

4.7.3 TEST PROTOCOL

Module: UGXZEX304A

Ambient temperature: 22°C
 Air Pressure: 1010hPa
 Humidity: 38%

Radio Technology	Channel Separation [MHz]	Limit [MHz]	Margin to Limit [MHz]
BT GFSK (1-DH1)	1.000	0.896	0.104

Module: UGKZ7A1001A

Ambient temperature: 22 °C
 Air Pressure: 1010 hPa
 Humidity: 34 %

Radio Technology	Channel Separation [MHz]	Limit [MHz]	Margin to Limit [MHz]
BT GFSK (1-DH1)	1.000	0.896	0.104

Remark: Please see next sub-clause for the measurement plot.

4.7.4 MEASUREMENT PLOT (SHOWING THE HIGHEST VALUE, "WORST CASE")

Module: UGXZEX304A

Radio Technology = Bluetooth BDR
 (S01_AB01)

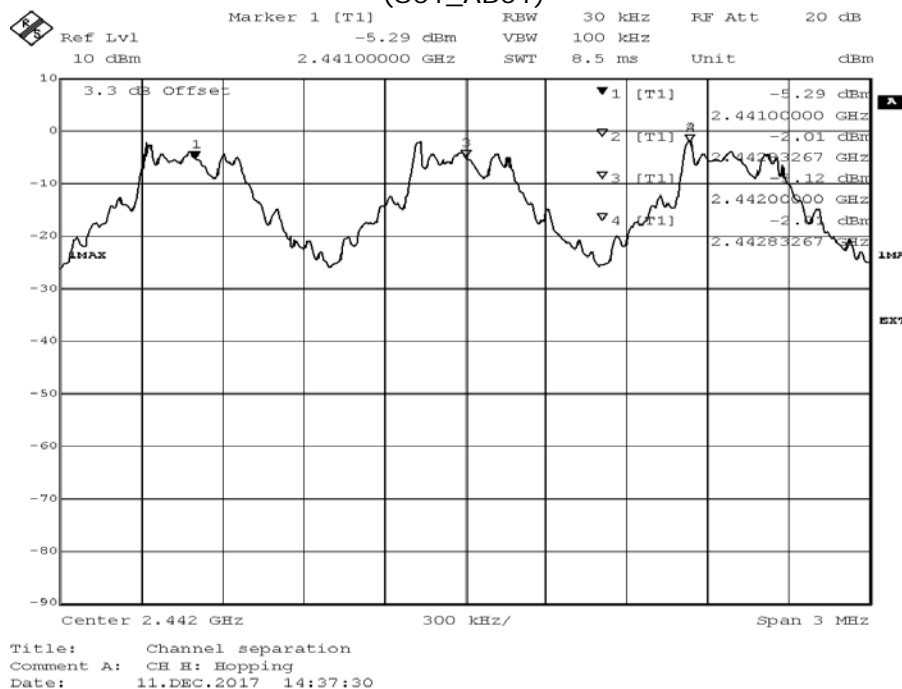

Module: UGKZ7A1001A

Radio Technology = Bluetooth BDR
(S01_AB01)

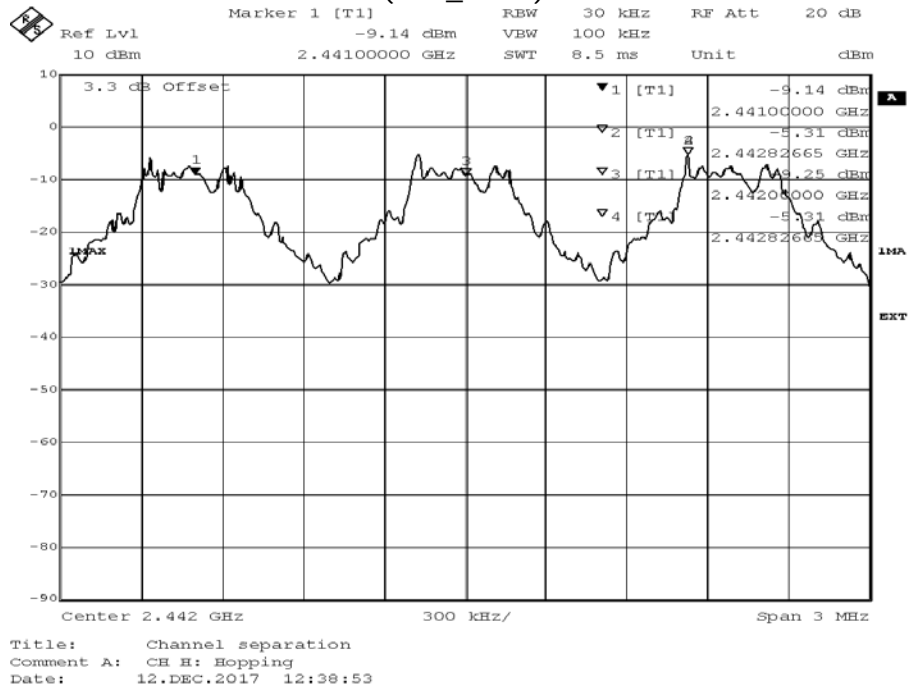

4.7.5 TEST EQUIPMENT USED

- Regulatory Bluetooth RF Test Solution

4.8 DWELL TIME

Standard **FCC Part 15 Subpart C**

The test was performed according to:
ANSI C63.10

4.8.1 TEST DESCRIPTION

The Equipment Under Test (EUT) was set up to perform the dwell time measurements. The dwell time is independent from the modulation pattern. The dwell time is calculated by:

The EUT was connected to the spectrum analyzer via a short coax cable with a known loss.

Dwell time = time slot length * hop rate / number of hopping channels * 31.6 s

with:

- hop rate = $1600 * 1/s$ for DH1 packets = $1600 s^{-1}$
- hop rate = $1600/3 * 1/s$ for DH3 packets = $533.33 s^{-1}$
- hop rate = $1600/5 * 1/s$ for DH5 packets = $320 s^{-1}$
- number of hopping channels = 79
- $31.6 s = 0.4$ seconds multiplied by the number of hopping channels = $0.4 s * 79$

The highest value of the dwell time is reported.

Analyzer settings:

- Center Frequency: mid channel frequency
- Span: Zero span
- Detector: Peak
- Trace: Maxhold
- Resolution Bandwidth (RBW): \leq channel separation
- Trigger: Video

4.8.2 TEST REQUIREMENTS / LIMITS

For the band: 902 – 928 MHz
FCC Part 15, Subpart C, §15.247 (a) (1) (i)

If the 20 dB bandwidth of the hopping channel is less than 250 kHz the average time of occupancy on any frequency shall not be greater than 0.4 seconds within a 20 second period. If the 20 dB bandwidth of the hopping channel is 250 kHz or greater, the average time of occupancy on any frequency shall not be greater than 0.4 seconds within a 10 second period.

For the band: 5725 – 5850 MHz
FCC Part 15, Subpart C, §15.247 (a) (1) (ii)

The average time of occupancy on any frequency shall not be greater than 0.4 seconds within a 30 second period.

For the frequency band 2400 – 2483.5 MHz:
FCC Part 15, Subpart C, §15.247 (a) (1) (iii)

...The average time of occupancy on any channel shall not be greater than 0.4 seconds within a period of 0.4 seconds multiplied by the number of hopping channels employed. Since the Bluetooth technology uses 79 channels this period is calculated to be 31.6 seconds.

4.8.3 TEST PROTOCOL

Module: UGXZEX304A

Ambient temperature: 22°C
 Air Pressure: 1010hPa
 Humidity: 38%

Radio Technology	Time Slot Length [ms]	Dwell Time [ms]	Limit [s]	Margin to Limit [ms]
BT GFSK (1-DH5)	2.910	372.480	0.4	27.520

Module: UGKZ7A1001A

Ambient temperature: 22 °C
 Air Pressure: 1010 hPa
 Humidity: 34 %

Radio Technology	Time Slot Length [ms]	Dwell Time [ms]	Limit [s]	Margin to Limit [ms]
BT GFSK (1-DH5)	2.910	372.480	0.4	27.520

Remark: Please see next sub-clause for the measurement plot.

4.8.4 MEASUREMENT PLOT (SHOWING THE HIGHEST VALUE, "WORST CASE")

Module: UGXZEX304A

Radio Technology = Bluetooth BDR
 (S01_AB01)

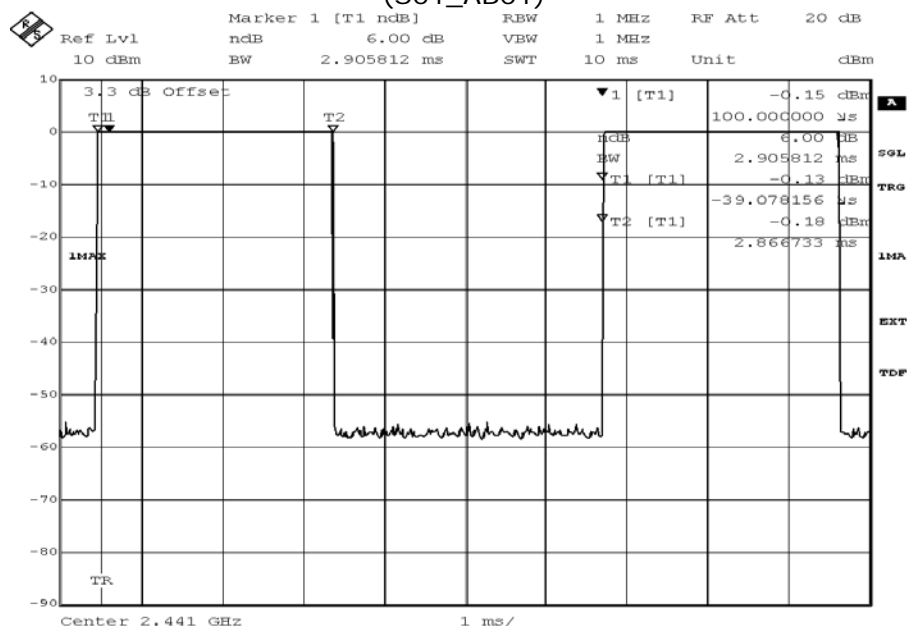

Title: Dwell time
 Comment A: CH M: 2441 MHz
 Date: 11.DEC.2017 13:24:11

Module: UGKZ7A1001A

Radio Technology = Bluetooth BDR
(S01_AB01)

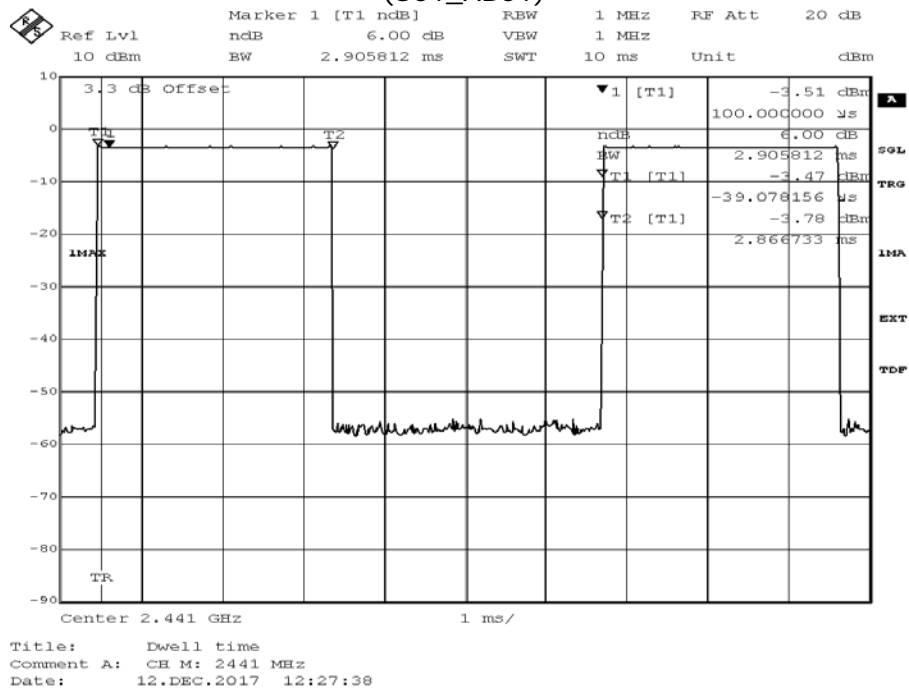

4.8.5 TEST EQUIPMENT USED

- Regulatory Bluetooth RF Test Solution

4.9 NUMBER OF HOPPING FREQUENCIES

Standard **FCC Part 15 Subpart C**

The test was performed according to:
ANSI C63.10

4.9.1 TEST DESCRIPTION

The Equipment Under Test (EUT) was set up to perform the number of hopping frequencies measurement. The number of hopping frequencies is independent from the modulation pattern.

The EUT was connected to the spectrum analyzer via a short coax cable with a known loss.

Analyzer settings:

- Detector: Peak
- Trace: Maxhold
- Centre frequency: 2442 MHz
- Frequency span: Frequency band of operation
- Resolution Bandwidth (RBW): < 30 % of channel spacing or 20 dB bandwidth (whichever is maller)
- Video Bandwidth (VBW): 3 x RBW
- Sweep Time: 21.5 ms
- Sweeps: 2000

The technology depending measurement parameters can be found in the measurement plot.

4.9.2 TEST REQUIREMENTS / LIMITS

For the band: 902 – 928 MHz
FCC Part 15, Subpart C, §15.247 (a) (1) (i)

If the 20 dB bandwidth of the hopping channel is less than 250 kHz, the system shall use at least 50 hopping frequencies.

If the 20 dB bandwidth of the hopping channel is 250 kHz or greater, the system shall use at least 25 hopping frequencies

For the band: 5725 – 5850 MHz
FCC Part 15, Subpart C, §15.247 (a) (1) (ii)

Frequency hopping systems operating in the 5725-5850 MHz band shall use at least 75 hopping frequencies.

For the band: 2400 – 2483.5 MHz
FCC Part 15, Subpart C, §15.247 (a) (1) (iii)

Frequency hopping systems in the 2400-2483.5 MHz band shall use at least 15 channels.

4.9.3 TEST PROTOCOL

Module: UGXZEX304A

Ambient temperature: 22°C
 Air Pressure: 1010hPa
 Humidity: 38%

Radio Technology	Number of Hopping Frequencies	Limit	Margin to Limit
BT GFSK (1-DH1)	79	15	64

Module: UGKZ7A1001A

Ambient temperature: 22 °C
 Air Pressure: 1010 hPa
 Humidity: 34 %

Radio Technology	Number of Hopping Frequencies	Limit	Margin to Limit
BT GFSK (1-DH1)	79	15	64

Remark: Please see next sub-clause for the measurement plot.

4.9.4 MEASUREMENT PLOT (SHOWING THE HIGHEST VALUE, "WORST CASE")

Module: UGXZEX304A

Radio Technology = Bluetooth BDR
 (S01_AB01)

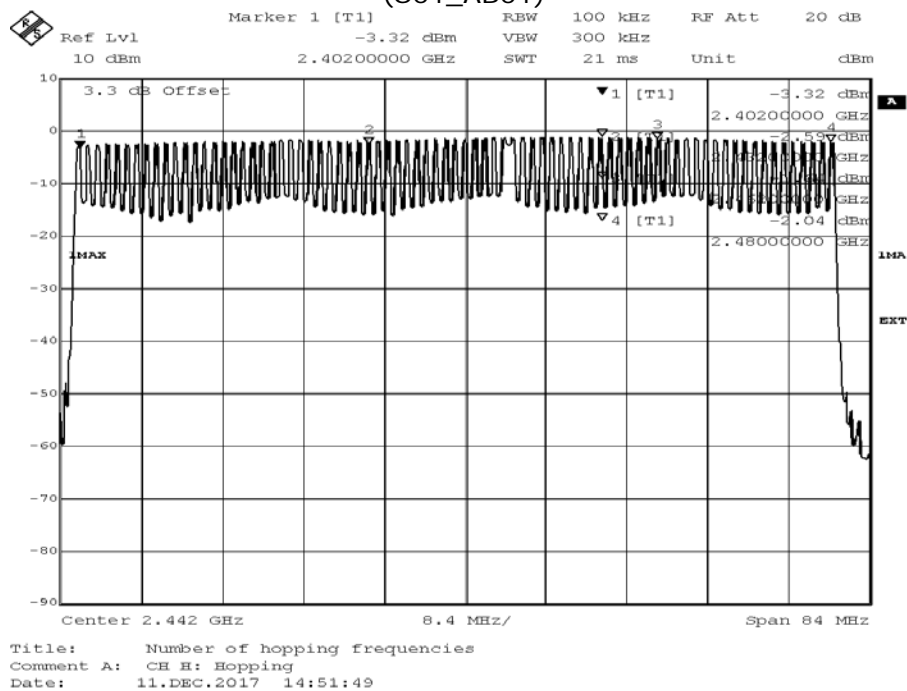

Module: UGKZ7A1001A

Radio Technology = Bluetooth BDR
(S01_AB01)

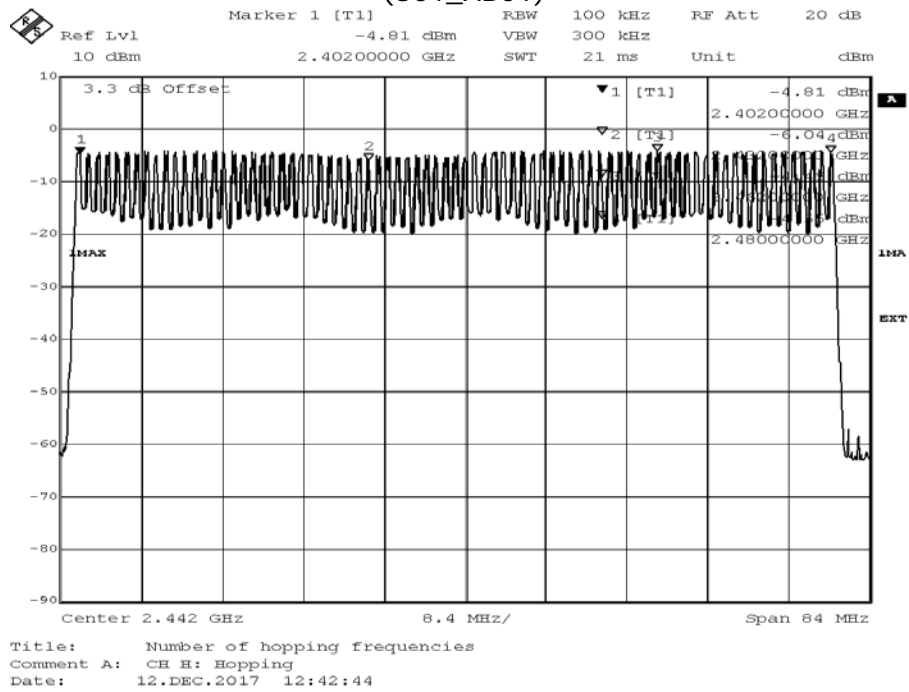

4.9.5 TEST EQUIPMENT USED

- Regulatory Bluetooth RF Test Solution

5 TEST EQUIPMENT

- 1 Radiated Emissions
Lab to perform radiated emission tests

Ref.No.	Device Name	Description	Manufacturer	Serial Number	Last Calibration	Calibration Due
1.1	NRV-Z1	Sensor Head A	Rohde & Schwarz	827753/005	2017-05	2018-05
1.2	MFS	Rubidium Frequency Normal MFS	Datum GmbH	002	2017-10	2018-10
1.3	Opus10 TPR (8253.00)	ThermoAirpressure Datalogger 13 (Environ)	Lufft Mess- und Regeltechnik GmbH	13936	2017-04	2019-04
1.4	Anechoic Chamber	10.58 x 6.38 x 6.00 m ³	Frankonia	none	2016-05	2019-05
1.5	HL 562	Ultralog new biconicals	Rohde & Schwarz	830547/003	2015-06	2018-06
1.6	5HC2700/12750-1.5-KK	High Pass Filter	Trilithic	9942012		
1.7	ASP 1.2/1.8-10 kg	Antenna Mast	Maturo GmbH	-		
1.8	Fully Anechoic Room	8.80m x 4.60m x 4.05m (l x w x h)	Albatross Projects	P26971-647-001-PRB	2015-06	2018-06
1.9	Fluke 177	Digital Multimeter 03 (Multimeter)	Fluke Europe B.V.	86670383	2016-02	2018-02
1.10	JS4-18002600-32-5P	Broadband Amplifier 18 GHz - 26 GHz	Miteq	849785		
1.11	FSW 43	Spectrum Analyzer	Rohde & Schwarz	103779	2016-12	2018-12
1.12	3160-09	Standard Gain / Pyramidal Horn Antenna 26.5 GHz	EMCO Elektronik GmbH	00083069		
1.13	WHKX 7.0/18G-8SS	High Pass Filter	Wainwright	09		
1.14	4HC1600/12750-1.5-KK	High Pass Filter	Trilithic	9942011		
1.15	Chroma 6404	AC Power Source	Chroma ATE INC.	64040001304		
1.16	JS4-00102600-42-5A	Broadband Amplifier 30 MHz - 26 GHz	Miteq	619368		
1.17	TT 1.5 WI	Turn Table	Maturo GmbH	-		
1.18	HL 562 Ultralog	Log.-per. Antenna	Rohde & Schwarz	100609	2016-04	2019-04
1.19	3160-10	Standard Gain / Pyramidal Horn Antenna 40 GHz	EMCO Elektronik GmbH	00086675		
1.20	5HC3500/18000-1.2-KK	High Pass Filter	Trilithic	200035008		
1.21	HFH2-Z2	Loop Antenna	Rohde & Schwarz	829324/006	2014-11	2017-11
1.22	Opus10 THI (8152.00)	ThermoHygro Datalogger 12 (Environ)	Lufft Mess- und Regeltechnik GmbH	12482	2017-03	2019-03
1.23	ESR 7	EMI Receiver / Spectrum Analyzer	Rohde & Schwarz	101424	2016-11	2018-11

1.24	JS4-00101800-35-5P	Broadband Amplifier 30 MHz - 18 GHz	Miteq	896037		
1.25	AS 620 P	Antenna mast	HD GmbH	620/37		
1.26	Tilt device Maturo (Rohacell)	Antrieb TD1.5-10kg	Maturo GmbH	TD1.5-10kg/024/3790709		
1.27	ESIB 26	Spectrum Analyzer	Rohde & Schwarz	830482/004	2015-12	2017-12
1.28	PAS 2.5 - 10 kg	Antenna Mast	Maturo GmbH	-		
1.29	AM 4.0	Antenna mast	Maturo GmbH	AM4.0/180/11920513		
1.30	HF 907	Double-ridged horn	Rohde & Schwarz	102444	2015-05	2018-05

2 Regulatory Bluetooth RF Test Solution
Regulatory Bluetooth RF Tests

Ref.No.	Device Name	Description	Manufacturer	Serial Number	Last Calibration	Calibration Due
2.1	MFS	Rubidium Frequency Normal MFS	Datum GmbH	002	2017-10	2018-10
2.2	EX520	Digital Multimeter 12 (Multimeter)	Extech Instruments Corp	05157876	2016-02	2018-02
2.3	NRV Z1 A	Power Sensor	Rohde & Schwarz	832279/013	2017-09	2018-09
2.4	Opus10 THI (8152.00)	T/H Logger 15	Lufft Mess- und Regeltechnik GmbH	13985	2017-04	2019-04
2.5	TOCT Switching Unit		7layers, Inc.	040107		
2.6	KWP 120/70	Temperature Chamber Weiss 01	Weiss	59226012190010	2016-03	2018-03
2.7	ADU 200 Relay Box 7	used for automated testing (EMMI) only	Ontrak Control Systems Inc	A04380		
2.8	CBT	IL BT RF Test Solution	Rohde & Schwarz	100302	2017-02	2018-02
2.9	NRVD	Powermeter	Rohde & Schwarz	832025/059	2017-09	2018-09
2.10	FSIQ26	Signal Analyser	Rohde & Schwarz	832695/007	2016-09	2018-09
2.11	SMP02	Signal Generator SMP	Rohde & Schwarz	833286/0014	2016-05	2019-05
2.12	SMIO03B	Signal Generator	Rohde & Schwarz	832870/017	2016-06	2019-06
2.13	CBT	Bluetooth Tester	Rohde & Schwarz	100589	2015-01	2018-01
2.14	NGSM 32/10	Power Supply	Rohde & Schwarz	2725	2017-06	2019-06

The calibration interval is the time interval between "Last Calibration" and "Calibration Due"

6 ANTENNA FACTORS, CABLE LOSS AND SAMPLE CALCULATIONS

This chapter contains the antenna factors with their corresponding path loss of the used measurement path for all antennas as well as the insertion loss of the LISN.

6.1 LISN R&S ESH3-Z5 (150 KHZ – 30 MHZ)

Frequency MHz	Corr. dB	LISN insertion loss ESH3- Z5 dB	cable loss (incl. 10 dB atten- uator) dB
0.15	10.1	0.1	10.0
5	10.3	0.1	10.2
7	10.5	0.2	10.3
10	10.5	0.2	10.3
12	10.7	0.3	10.4
14	10.7	0.3	10.4
16	10.8	0.4	10.4
18	10.9	0.4	10.5
20	10.9	0.4	10.5
22	11.1	0.5	10.6
24	11.1	0.5	10.6
26	11.2	0.5	10.7
28	11.2	0.5	10.7
30	11.3	0.5	10.8

Sample calculation

$$U_{\text{LISN}} (\text{dB } \mu\text{V}) = U (\text{dB } \mu\text{V}) + \text{Corr. (dB)}$$

U = Receiver reading

LISN Insertion loss = Voltage Division Factor of LISN

Corr. = sum of single correction factors of used LISN, cables, switch units (if used)

Linear interpolation will be used for frequencies in between the values in the table.

6.2 ANTENNA R&S HFH2-Z2 (9 KHZ – 30 MHZ)

Frequency MHz	AF HFH-Z2) dB (1/m)	Corr. dB	cable loss 1 (inside chamber) dB	cable loss 2 (outside chamber) dB	cable loss 3 (switch unit) dB	cable loss 4 (to receiver) dB	distance corr. (-40 dB/ decade) dB	d _{Limit} (meas. distance (limit) m	d _{used} (meas. distance (used) m
0.009	20.50	-79.6	0.1	0.1	0.1	0.1	-80	300	3
0.01	20.45	-79.6	0.1	0.1	0.1	0.1	-80	300	3
0.015	20.37	-79.6	0.1	0.1	0.1	0.1	-80	300	3
0.02	20.36	-79.6	0.1	0.1	0.1	0.1	-80	300	3
0.025	20.38	-79.6	0.1	0.1	0.1	0.1	-80	300	3
0.03	20.32	-79.6	0.1	0.1	0.1	0.1	-80	300	3
0.05	20.35	-79.6	0.1	0.1	0.1	0.1	-80	300	3
0.08	20.30	-79.6	0.1	0.1	0.1	0.1	-80	300	3
0.1	20.20	-79.6	0.1	0.1	0.1	0.1	-80	300	3
0.2	20.17	-79.6	0.1	0.1	0.1	0.1	-80	300	3
0.3	20.14	-79.6	0.1	0.1	0.1	0.1	-80	300	3
0.49	20.12	-79.6	0.1	0.1	0.1	0.1	-80	300	3
0.490001	20.12	-39.6	0.1	0.1	0.1	0.1	-40	30	3
0.5	20.11	-39.6	0.1	0.1	0.1	0.1	-40	30	3
0.8	20.10	-39.6	0.1	0.1	0.1	0.1	-40	30	3
1	20.09	-39.6	0.1	0.1	0.1	0.1	-40	30	3
2	20.08	-39.6	0.1	0.1	0.1	0.1	-40	30	3
3	20.06	-39.6	0.1	0.1	0.1	0.1	-40	30	3
4	20.05	-39.5	0.2	0.1	0.1	0.1	-40	30	3
5	20.05	-39.5	0.2	0.1	0.1	0.1	-40	30	3
6	20.02	-39.5	0.2	0.1	0.1	0.1	-40	30	3
8	19.95	-39.5	0.2	0.1	0.1	0.1	-40	30	3
10	19.83	-39.4	0.2	0.1	0.2	0.1	-40	30	3
12	19.71	-39.4	0.2	0.1	0.2	0.1	-40	30	3
14	19.54	-39.4	0.2	0.1	0.2	0.1	-40	30	3
16	19.53	-39.3	0.3	0.1	0.2	0.1	-40	30	3
18	19.50	-39.3	0.3	0.1	0.2	0.1	-40	30	3
20	19.57	-39.3	0.3	0.1	0.2	0.1	-40	30	3
22	19.61	-39.3	0.3	0.1	0.2	0.1	-40	30	3
24	19.61	-39.3	0.3	0.1	0.2	0.1	-40	30	3
26	19.54	-39.3	0.3	0.1	0.2	0.1	-40	30	3
28	19.46	-39.2	0.3	0.1	0.3	0.1	-40	30	3
30	19.73	-39.1	0.4	0.1	0.3	0.1	-40	30	3

Sample calculation

$$E \text{ (dB } \mu\text{V/m)} = U \text{ (dB } \mu\text{V)} + AF \text{ (dB 1/m)} + Corr. \text{ (dB)}$$

U = Receiver reading

AF = Antenna factor

Corr. = sum of single correction factors of used cables, switch unit, distance correction, amplifier (if applicable)

distance correction = $-40 * \text{LOG} (d_{\text{Limit}} / d_{\text{used}})$

Linear interpolation will be used for frequencies in between the values in the table.

Table shows an extract of values

6.3 ANTENNA R&S HL562 (30 MHz – 1 GHz)

($d_{Limit} = 3\text{ m}$)

Frequency	AF R&S HL562	Corr.
MHz	dB (1/m)	dB
30	18.6	0.6
50	6.0	0.9
100	9.7	1.2
150	7.9	1.6
200	7.6	1.9
250	9.5	2.1
300	11.0	2.3
350	12.4	2.6
400	13.6	2.9
450	14.7	3.1
500	15.6	3.2
550	16.3	3.5
600	17.2	3.5
650	18.1	3.6
700	18.5	3.6
750	19.1	4.1
800	19.6	4.1
850	20.1	4.4
900	20.8	4.7
950	21.1	4.8
1000	21.6	4.9

cable loss 1 (inside chamber)	cable loss 2 (outside chamber)	cable loss 3 (switch unit)	cable loss 4 (to receiver)	distance corr. (-20 dB/ decade)	d_{Limit} (meas. distance (limit))	d_{used} (meas. distance (used))
dB	dB	dB	dB	dB	m	m
0.29	0.04	0.23	0.02	0.0	3	3
0.39	0.09	0.32	0.08	0.0	3	3
0.56	0.14	0.47	0.08	0.0	3	3
0.73	0.20	0.59	0.12	0.0	3	3
0.84	0.21	0.70	0.11	0.0	3	3
0.98	0.24	0.80	0.13	0.0	3	3
1.04	0.26	0.89	0.15	0.0	3	3
1.18	0.31	0.96	0.13	0.0	3	3
1.28	0.35	1.03	0.19	0.0	3	3
1.39	0.38	1.11	0.22	0.0	3	3
1.44	0.39	1.20	0.19	0.0	3	3
1.55	0.46	1.24	0.23	0.0	3	3
1.59	0.43	1.29	0.23	0.0	3	3
1.67	0.34	1.35	0.22	0.0	3	3
1.67	0.42	1.41	0.15	0.0	3	3
1.87	0.54	1.46	0.25	0.0	3	3
1.90	0.46	1.51	0.25	0.0	3	3
1.99	0.60	1.56	0.27	0.0	3	3
2.14	0.60	1.63	0.29	0.0	3	3
2.22	0.60	1.66	0.33	0.0	3	3
2.23	0.61	1.71	0.30	0.0	3	3

($d_{Limit} = 10\text{ m}$)

30	18.6	-9.9
50	6.0	-9.6
100	9.7	-9.2
150	7.9	-8.8
200	7.6	-8.6
250	9.5	-8.3
300	11.0	-8.1
350	12.4	-7.9
400	13.6	-7.6
450	14.7	-7.4
500	15.6	-7.2
550	16.3	-7.0
600	17.2	-6.9
650	18.1	-6.9
700	18.5	-6.8
750	19.1	-6.3
800	19.6	-6.3
850	20.1	-6.0
900	20.8	-5.8
950	21.1	-5.6
1000	21.6	-5.6

0.29	0.04	0.23	0.02	-10.5	10	3
0.39	0.09	0.32	0.08	-10.5	10	3
0.56	0.14	0.47	0.08	-10.5	10	3
0.73	0.20	0.59	0.12	-10.5	10	3
0.84	0.21	0.70	0.11	-10.5	10	3
0.98	0.24	0.80	0.13	-10.5	10	3
1.04	0.26	0.89	0.15	-10.5	10	3
1.18	0.31	0.96	0.13	-10.5	10	3
1.28	0.35	1.03	0.19	-10.5	10	3
1.39	0.38	1.11	0.22	-10.5	10	3
1.44	0.39	1.20	0.19	-10.5	10	3
1.55	0.46	1.24	0.23	-10.5	10	3
1.59	0.43	1.29	0.23	-10.5	10	3
1.67	0.34	1.35	0.22	-10.5	10	3
1.67	0.42	1.41	0.15	-10.5	10	3
1.87	0.54	1.46	0.25	-10.5	10	3
1.90	0.46	1.51	0.25	-10.5	10	3
1.99	0.60	1.56	0.27	-10.5	10	3
2.14	0.60	1.63	0.29	-10.5	10	3
2.22	0.60	1.66	0.33	-10.5	10	3
2.23	0.61	1.71	0.30	-10.5	10	3

Sample calculation

$$E \text{ (dB } \mu\text{V/m)} = U \text{ (dB } \mu\text{V)} + \text{AF (dB 1/m)} + \text{Corr. (dB)}$$

U = Receiver reading

AF = Antenna factor

Corr. = sum of single correction factors of used cables, switch unit, distance correction, amplifier (if applicable)

distance correction = $-20 * \text{LOG} (d_{Limit} / d_{used})$

Linear interpolation will be used for frequencies in between the values in the table.

Tables show an extract of values.

6.4 ANTENNA R&S HF907 (1 GHZ – 18 GHZ)

Frequency	AF R&S HF907	Corr.
MHz	dB (1/m)	dB
1000	24.4	-19.4
2000	28.5	-17.4
3000	31.0	-16.1
4000	33.1	-14.7
5000	34.4	-13.7
6000	34.7	-12.7
7000	35.6	-11.0

cable loss 1 (relay + cable inside chamber)	cable loss 2 (outside chamber)	cable loss 3 (switch unit, attenuator & pre-amp)	cable loss 4 (to receiver)		
dB	dB	dB	dB		
0.99	0.31	-21.51	0.79		
1.44	0.44	-20.63	1.38		
1.87	0.53	-19.85	1.33		
2.41	0.67	-19.13	1.31		
2.78	0.86	-18.71	1.40		
2.74	0.90	-17.83	1.47		
2.82	0.86	-16.19	1.46		

Frequency	AF R&S HF907	Corr.
MHz	dB (1/m)	dB
3000	31.0	-23.4
4000	33.1	-23.3
5000	34.4	-21.7
6000	34.7	-21.2
7000	35.6	-19.8

cable loss 1 (relay inside chamber)	cable loss 2 (inside chamber)	cable loss 3 (outside chamber)	cable loss 4 (switch unit, attenuator & pre-amp)	cable loss 5 (to receiver)	used for FCC 15.247
dB	dB	dB	dB	dB	
0.47	1.87	0.53	-27.58	1.33	
0.56	2.41	0.67	-28.23	1.31	
0.61	2.78	0.86	-27.35	1.40	
0.58	2.74	0.90	-26.89	1.47	
0.66	2.82	0.86	-25.58	1.46	

Frequency	AF R&S HF907	Corr.
MHz	dB (1/m)	dB
7000	35.6	-57.3
8000	36.3	-56.3
9000	37.1	-55.3
10000	37.5	-56.2
11000	37.5	-55.3
12000	37.6	-53.7
13000	38.2	-53.5
14000	39.9	-56.3
15000	40.9	-54.1
16000	41.3	-54.1
17000	42.8	-54.4
18000	44.2	-54.7

cable loss 1 (relay inside chamber)	cable loss 2 (High Pass)	cable loss 3 (pre-amp)	cable loss 4 (inside chamber)	cable loss 5 (outside chamber)	cable loss 6 (to receiver)
dB	dB	dB	dB	dB	dB
0.56	1.28	-62.72	2.66	0.94	1.46
0.69	0.71	-61.49	2.84	1.00	1.53
0.68	0.65	-60.80	3.06	1.09	1.60
0.70	0.54	-61.91	3.28	1.20	1.67
0.80	0.61	-61.40	3.43	1.27	1.70
0.84	0.42	-59.70	3.53	1.26	1.73
0.83	0.44	-59.81	3.75	1.32	1.83
0.91	0.53	-63.03	3.91	1.40	1.77
0.98	0.54	-61.05	4.02	1.44	1.83
1.23	0.49	-61.51	4.17	1.51	1.85
1.36	0.76	-62.36	4.34	1.53	2.00
1.70	0.53	-62.88	4.41	1.55	1.91

Sample calculation

$E \text{ (dB } \mu\text{V/m)} = U \text{ (dB } \mu\text{V)} + \text{AF (dB 1/m)} + \text{Corr. (dB)}$
 U = Receiver reading
 AF = Antenna factor
 Corr. = sum of single correction factors of used cables, switch unit, distance correction, amplifier (if applicable)
 Linear interpolation will be used for frequencies in between the values in the table.
 Tables show an extract of values.

6.5 ANTENNA EMCO 3160-09 (18 GHZ – 26.5 GHZ)

Frequency	AF EMCO 3160-09	Corr.
MHz	dB (1/m)	dB
18000	40.2	-23.5
18500	40.2	-23.2
19000	40.2	-22.0
19500	40.3	-21.3
20000	40.3	-20.3
20500	40.3	-19.9
21000	40.3	-19.1
21500	40.3	-19.1
22000	40.3	-18.7
22500	40.4	-19.0
23000	40.4	-19.5
23500	40.4	-19.3
24000	40.4	-19.8
24500	40.4	-19.5
25000	40.4	-19.3
25500	40.5	-20.4
26000	40.5	-21.3
26500	40.5	-21.1

cable loss 1 (inside chamber)	cable loss 2 (pre- amp)	cable loss 3 (inside chamber)	cable loss 4 (switch unit)	cable loss 5 (to receiver)
dB	dB	dB	dB	dB
0.72	-35.85	6.20	2.81	2.65
0.69	-35.71	6.46	2.76	2.59
0.76	-35.44	6.69	3.15	2.79
0.74	-35.07	7.04	3.11	2.91
0.72	-34.49	7.30	3.07	3.05
0.78	-34.46	7.48	3.12	3.15
0.87	-34.07	7.61	3.20	3.33
0.90	-33.96	7.47	3.28	3.19
0.89	-33.57	7.34	3.35	3.28
0.87	-33.66	7.06	3.75	2.94
0.88	-33.75	6.92	3.77	2.70
0.90	-33.35	6.99	3.52	2.66
0.88	-33.99	6.88	3.88	2.58
0.91	-33.89	7.01	3.93	2.51
0.88	-33.00	6.72	3.96	2.14
0.89	-34.07	6.90	3.66	2.22
0.86	-35.11	7.02	3.69	2.28
0.90	-35.20	7.15	3.91	2.36

Sample calculation

$$E \text{ (dB } \mu\text{V/m)} = U \text{ (dB } \mu\text{V)} + AF \text{ (dB 1/m)} + Corr. \text{ (dB)}$$

U = Receiver reading

AF = Antenna factor

Corr. = sum of single correction factors of used cables, switch unit, distance correction, amplifier (if applicable)

Linear interpolation will be used for frequencies in between the values in the table.

Table shows an extract of values.

6.6 ANTENNA EMCO 3160-10 (26.5 GHZ – 40 GHZ)

Frequency GHz	AF EMCO 3160-10 dB (1/m)	Corr. dB	cable loss 1 (inside chamber) dB	cable loss 2 (outside chamber) dB	cable loss 3 (switch unit) dB	cable loss 4 (to receiver) dB	distance corr. (-20 dB/ decade) dB	d _{Limit} (meas. distance (limit) m	d _{used} (meas. distance (used) m
26.5	43.4	-11.2	4.4				-15.6	3	0.5
27.0	43.4	-11.2	4.4				-15.6	3	0.5
28.0	43.4	-11.1	4.5				-15.6	3	0.5
29.0	43.5	-11.0	4.6				-15.6	3	0.5
30.0	43.5	-10.9	4.7				-15.6	3	0.5
31.0	43.5	-10.8	4.7				-15.6	3	0.5
32.0	43.5	-10.7	4.8				-15.6	3	0.5
33.0	43.6	-10.7	4.9				-15.6	3	0.5
34.0	43.6	-10.6	5.0				-15.6	3	0.5
35.0	43.6	-10.5	5.1				-15.6	3	0.5
36.0	43.6	-10.4	5.1				-15.6	3	0.5
37.0	43.7	-10.3	5.2				-15.6	3	0.5
38.0	43.7	-10.2	5.3				-15.6	3	0.5
39.0	43.7	-10.2	5.4				-15.6	3	0.5
40.0	43.8	-10.1	5.5				-15.6	3	0.5

Sample calculation

$$E \text{ (dB } \mu\text{V/m)} = U \text{ (dB } \mu\text{V)} + AF \text{ (dB 1/m)} + Corr. \text{ (dB)}$$

U = Receiver reading

AF = Antenna factor

Corr. = sum of single correction factors of used cables, switch unit, distance correction, amplifier (if applicable)

Linear interpolation will be used for frequencies in between the values in the table.

distance correction = $-20 * \text{LOG} (d_{\text{Limit}} / d_{\text{used}})$

Linear interpolation will be used for frequencies in between the values in the table.

Table shows an extract of values.

7 SETUP DRAWINGS

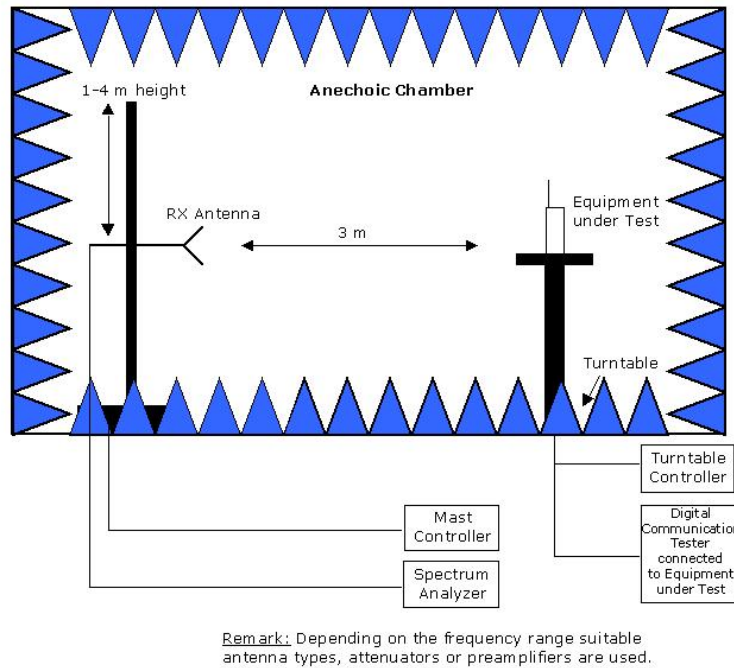

Drawing 1: Setup in the Anechoic chamber. For measurements below 1 GHz the ground was replaced by a conducting groundplane.

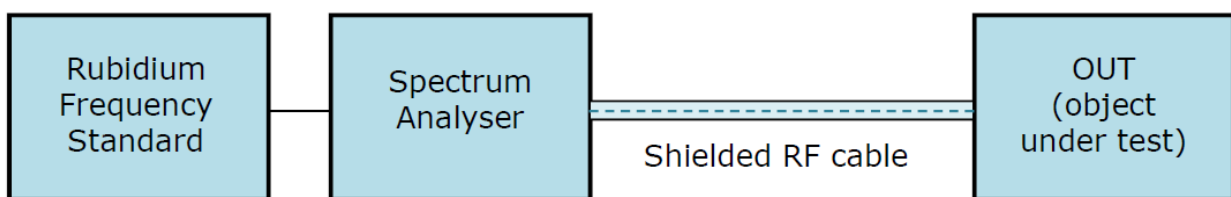

Drawing 2: Setup for conducted radio tests.

8 MEASUREMENT UNCERTAINTIES

Test Case	Parameter	Uncertainty
AC Power Line	Power	± 3.4 dB
Field Strength of spurious radiation	Power	± 5.5 dB
6 dB / 26 dB / 99% Bandwidth	Power Frequency	± 2.9 dB ± 11.2 kHz
Conducted Output Power	Power	± 2.2 dB
Band Edge Compliance	Power Frequency	± 2.2 dB ± 11.2 kHz
Frequency Stability	Frequency	± 25 Hz
Power Spectral Density	Power	± 2.2 dB

9 PHOTO REPORT

Please see separate photo report.