



FCC TEST REPORT
FCC ID: 2AMJR-MOINL1

On Behalf of
Gudsen Technology Co., Ltd
MIRFAK Moin L1
Model No.: Moin L1

Prepared for : Gudsen Technology Co., Ltd
Address : F6, 10th Building, Jiuxiang Ling Industrial Park, Ave Xili, Nanshan
District, Shenzhen, China

Prepared By : Shenzhen Alpha Product Testing Co., Ltd.
Address : Building i, No.2, Lixin Road, Fuyong Street, Bao'an District, 518103,
Shenzhen, Guangdong, China

Report Number : T1890190 01
Date of Receipt : February 14, 2019
Date of Test : February 14-22, 2019
Date of Report : February 22, 2019
Version Number : REV0

TABLE OF CONTENTS

Description	Page
1. Summary of Standards And Results-----	6
1.1. Description of Standards and Results -----	6
2. General Information -----	7
2.1. Description of Device (EUT)-----	7
2.2. Accessories of Device (EUT) -----	8
2.3. Tested Supporting System Details -----	8
2.4. Block Diagram of connection between EUT and simulators -----	8
2.5. Test Mode Description -----	8
2.6. Test Conditions -----	8
2.7. Test Facility -----	9
2.8. Measurement Uncertainty -----	9
2.9. Test Equipment List -----	10
3. Spurious Emission -----	11
3.1. Test Limits -----	11
3.2. Test Procedure -----	11
3.3. Test Setup -----	12
3.4. Test Results -----	13
4. Power Line Conducted Emission-----	17
4.1. Test Limits -----	17
4.2. Test Procedure -----	17
4.3. Test Setup -----	17
4.4. Test Results -----	18
5. Conducted Maximum Output Power -----	20
5.1. Test limits -----	20
5.2. Test Procedure -----	20
5.3. Test Setup -----	20
5.4. Test Results -----	20
6. Peak Power Spectral Density-----	21
6.1. Test limits -----	21
6.2. Test Procedure -----	21
6.3. Test Setup -----	21
6.4. Test Results -----	21
7. Bandwidth-----	24
7.1. Test limits -----	24
7.2. Test Procedure -----	24
7.3. Test Setup -----	24
7.4. Test Results -----	24
8. Band Edge Check-----	27
8.1. Test limits -----	27
8.2. Test Procedure -----	27
8.3. Test Setup -----	27
8.4. Test Results -----	27
9. Antenna Requirement -----	31
9.1. Standard Requirement -----	31
9.2. Antenna Connected Construction-----	31

9.3. Results -----	31
10. Test setup photo -----	32
10.1. Photos of Radiated emission -----	32
10.2. Photos of Power Line Conducted Emission -----	33
11. EUT photo-----	34

TEST REPORT DECLARATION

Applicant : Gudsen Technology Co., Ltd
 Address : F\6, 10th Building, Jiuxiang Ling Industrial Park, Ave Xili, Nanshan District, Shenzhen, China
 Manufacturer : Gudsen Technology Co., Ltd
 Address : F\6, 10th Building, Jiuxiang Ling Industrial Park, Ave Xili, Nanshan District, Shenzhen, China
 EUT Description : MIRFAK Moin L1
 (A) Model No. : MIRFAK Moin L1
 (B) Trademark : MIRFAK

Measurement Standard Used:

**FCC Rules and Regulations Part 15 Subpart C Section 15.247
ANSI C63.10-2013**

The device described above is tested by Shenzhen Alpha Product Testing Co., Ltd. to determine the maximum emission levels emanating from the device. The maximum emission levels are compared to the FCC Part 15 Subpart C limits both conducted and radiated emissions. The test results are contained in this test report and Shenzhen Alpha Product Testing Co., Ltd. is assumed of full responsibility for the accuracy and completeness of these tests.

After the test, our opinion is that EUT compliance with the requirement of the above standards.

This report applies to above tested sample only. This report shall not be reproduced in parts without written approval of Shenzhen Alpha Product Testing Co., Ltd.

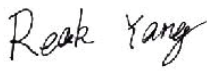
Tested by (name + signature).....: Reak Yang
 Project Engineer 

Approved by (name + signature).....: Simple Guan
 Project Manager 

Date of issue..... : February 22, 2019

Revision History

Revision	Issue Date	Revisions	Revised By
00	February 22, 2019	Initial released Issue	Simple Guan

1. SUMMARY OF STANDARDS AND RESULTS

1.1. Description of Standards and Results

The EUT have been tested according to the applicable standards as referenced below:

Test Item	Test Requirement	Standards Paragraph	Result
Conducted Emission	FCC PART 15	15.207	P
6dB Bandwidth	FCC PART 15	15.247 (a)(2)	P
Output Power	FCC PART 15	15.247 (b)(3)	P
Radiated Spurious Emission	FCC PART 15	15.247 (c)	P
Conducted Spurious & Band Edge Emission	FCC PART 15	15.247 (d)	P
Power Spectral Density	FCC PART 15	15.247 (e)	P
Radiated Band Edge Emission	FCC PART 15	15.205	P
Antenna Requirement	FCC PART 15	15.203	P
Note:	1. P is an abbreviation for Pass. 2. F is an abbreviation for Fail. 3. N/A is an abbreviation for Not Applicable.		

2. GENERAL INFORMATION

2.1. Description of Device (EUT)

Description : MIRFAK Moin L1

Model Number : Moin L1

Diff : N/A

Trademark : MIRFAK

Test Voltage : DC 7.4V from battery, DC 5V from Notebook PC with AC120V/60Hz

Bluetooth Version : Bluetooth V4.2 BLE

Operation frequency : 2402-2480MHz

Channel No. : 40 Channels

Modulation type : GFSK

Antenna Type : PCB Antenna, Maximum Gain is 0dBi

Software version : V1.0

Hardware version : V1.0

2.2. Accessories of Device (EUT)

Power Source : N/A

2.3. Tested Supporting System Details

No.	Description	Manufacturer	Model	Serial Number	Certification or DOC
1	Notebook PC	ACER	M1830	PTSF90C00305005C AC3000	DOC

2.4. Block Diagram of connection between EUT and simulators

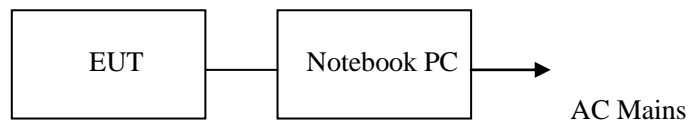

2.5. Test Mode Description

Tested mode, channel, and data rate information		
Mode	Channel	Frequency (MHz)
GFSK	Low :CH1	2402
	Middle: CH20	2440
	High: CH40	2480

2.6. Test Conditions

Items	Required	Actual
Temperature range:	15-35°C	27°C
Humidity range:	25-75%	56%
Pressure range:	86-106kPa	980kPa

2.7. Test Facility

Shenzhen Alpha Product Testing Co., Ltd
 Building i, No.2, Lixin Road, Fuyong Street, Bao'an District, 518103,
 Shenzhen, Guangdong, China

June 21, 2018 File on Federal Communication Commission
 Registration Number: 293961

July 25, 2017 Certificated by IC
 Registration Number: 12135A

2.8. Measurement Uncertainty

(95% confidence levels, k=2)

Item	Uncertainty
Uncertainty for Power point Conducted Emissions Test	2.42dB
Uncertainty for Radiation Emission test in 3m chamber (below 30MHz)	2.13 dB(Polarize: V)
	2.57dB(Polarize: H)
Uncertainty for Radiation Emission test in 3m chamber (30MHz to 1GHz)	3.54dB(Polarize: V)
	4.1dB(Polarize: H)
Uncertainty for Radiation Emission test in 3m chamber (1GHz to 25GHz)	2.08dB(Polarize: H)
	2.56dB(Polarize: V)
Uncertainty for radio frequency	1×10^{-9}
Uncertainty for conducted RF Power	0.65dB
Uncertainty for temperature	0.2°C
Uncertainty for humidity	1%
Uncertainty for DC and low frequency voltages	0.06%

2.9. Test Equipment List

Equipment	Manufacture	Model No.	Serial No.	Last cal.	Cal Interval
3m Semi-Anechoic	ETS-LINDGRE N	N/A	SEL0017	2018.09.21	1 Year
Spectrum analyzer	Agilent	E4407B	MY46185649	2018.09.21	1 Year
Receiver	R&S	ESCI	1166.5950K03-1011	2018.09.21	1 Year
Receiver	R&S	ESCI	101202	2018.09.21	1 Year
Bilog Antenna	Schwarzbeck	VULB 9168	VULB9168-438	2018.04.13	2 Year
Horn Antenna	EMCO	3115	640201028-06	2018.04.13	2 Year
Active Loop Antenna	Beijing Daze	ZN30900A	SEL0097	2018.04.13	2 Year
Cable	Resenberger	N/A	No.1	2018.09.21	1 Year
Cable	SCHWARZBECK	N/A	No.2	2018.09.21	1 Year
Cable	SCHWARZBECK	N/A	No.3	2018.09.21	1 Year
Pre-amplifier	Schwarzbeck	BBV9743	9743-019	2018.09.21	1 Year
Pre-amplifier	R&S	AFS33-18002650-30-8P-44	SEL0080	2018.09.21	1 Year
Temperature controller	Terchy	MHQ	120	2018.09.21	1 Year
L.I.S.N.#1	Schwarzbeck	NSLK8126	8126466	2018.09.21	1 Year
L.I.S.N.#2	ROHDE&SCHWARZ	ENV216	101043	2018.09.21	1 Year
20db Attenuator	ICPROBING	IATS1	82347	2018.09.21	1 Year
Horn Antenna	SCHWARZBECK	BBHA 9170	BBHA 9170294	2018.04.13	2 Year
Power Meter	Anritsu	ML2487A	6K00001491	2018.09.21	1 Year

3. SPURIOUS EMISSION

3.1. Test Limits

Frequencies (MHz)	Field Strength (micorvolts/meter)	Measurement Distance (meters)
0.009~0.490	2400/F(KHz)	300
0.490~1.705	24000/F(KHz)	30
1.705~30.0	30	30
30~88	100	3
88~216	150	3
216~960	200	3
Above 960	500	3

Harmonic emissions limits comply with below 54 dBuV/m at 3m. Other emissions radiated outside of the specified frequency bands, except for harmonics, shall be attenuated by at least 50 dB below the level of the fundamental or comply with the radiated emissions limits specified in section 15.209(a) limit in the table below has to be followed.

NOTE:

- a) The tighter limit applies at the band edges.
- b) Emission Level(dB uV/m)=20log Emission Level(uv/m)

3.2. Test Procedure

The measuring distance of 3m shall be used for measurements at frequency up to 1GH and above 1GHz, The EUT was placed on a rotating 0.8 m high above ground for below 1GHz and 1.5m high for above 1GHz testing, The table was rotated 360 degrees to determine the position of the highest radiation

The Test antenna shall vary between 1m and 4m, Both Horizontal and Vertical antenna are set of make measurement.

The initial step in collecting conducted emission data is a spectrum analyzer Peak detector mode pre-scanning the measurement frequency range. Significant Peaks are then marked. and then Qusia Peak Detector mode premeasured

If Peak value comply with QP limit Below 1GHz. The EUT deemed to comply with QP limit. But the Peak value and average value both need to comply with applicable limit above 1GHz.

For the actual test configuration, please see the test setup photo.

3.3. Test Setup

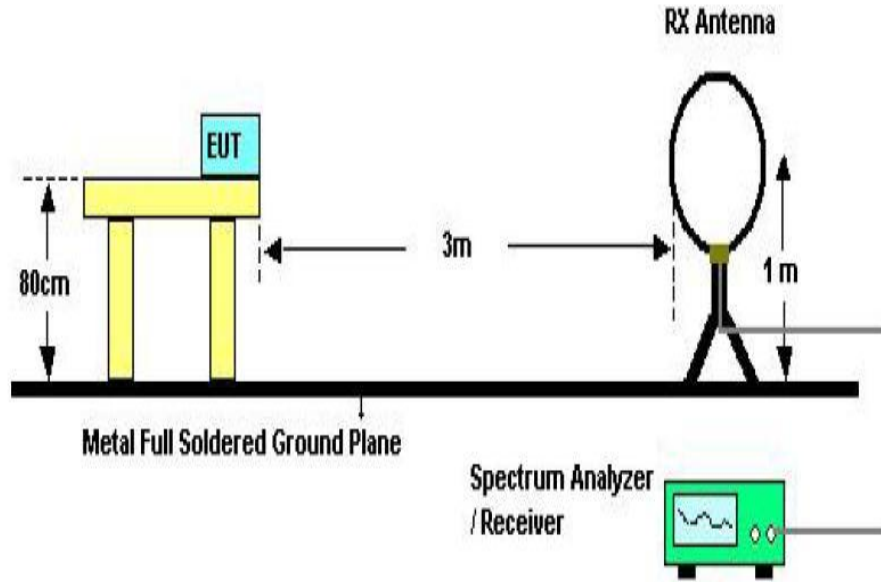

Below 30MHz Test Setup

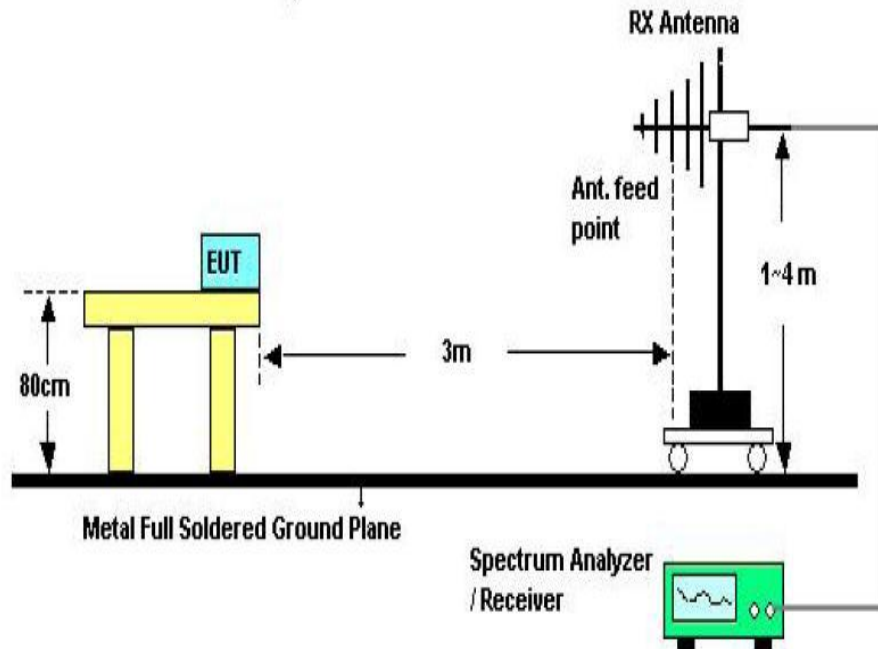

Above 30MHz Test Setup

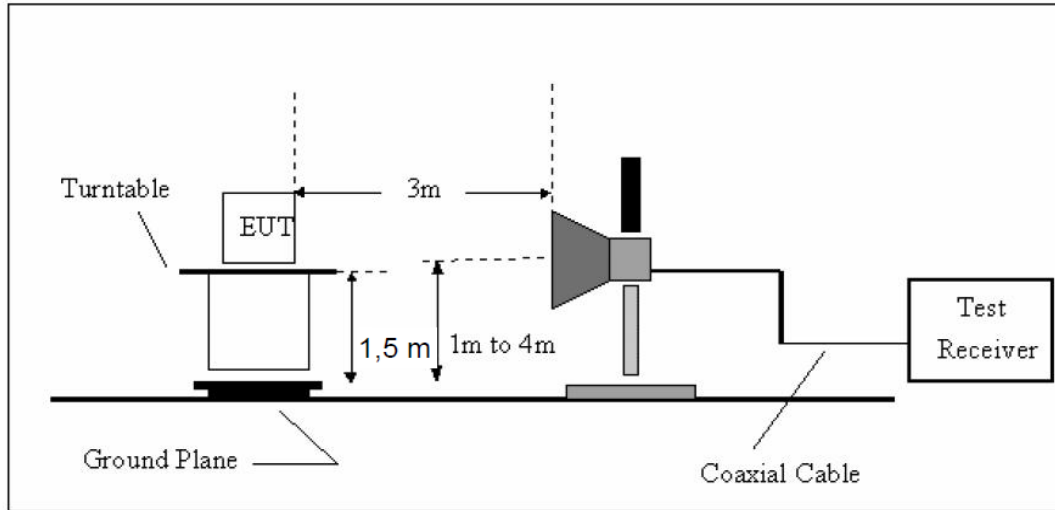

Above 1GHz Test Setup

3.4. Test Results

Test Condition

Continual Transmitting in maximum power.

9KHz~150KHz	RBW200Hz	VBW1KHz
150KHz~30MHz	RBW9KHz	VBW 30KHz
30MHz~1GHz	RBW120KHz	VBW 300KHz
Above1GHz	RBW1MHz	VBW 3MHz

We have scanned the 10th harmonic from 9 kHz to the EUT.

Detailed information please see the following page.

From 9KHz to 30MHz: Conclusion: PASS

Note: 1. The amplitude of spurious emissions which are attenuated by more than 20dB below the permissible value has no need to be reported.

2. Only show the test data of the worst Channel in this report.

H

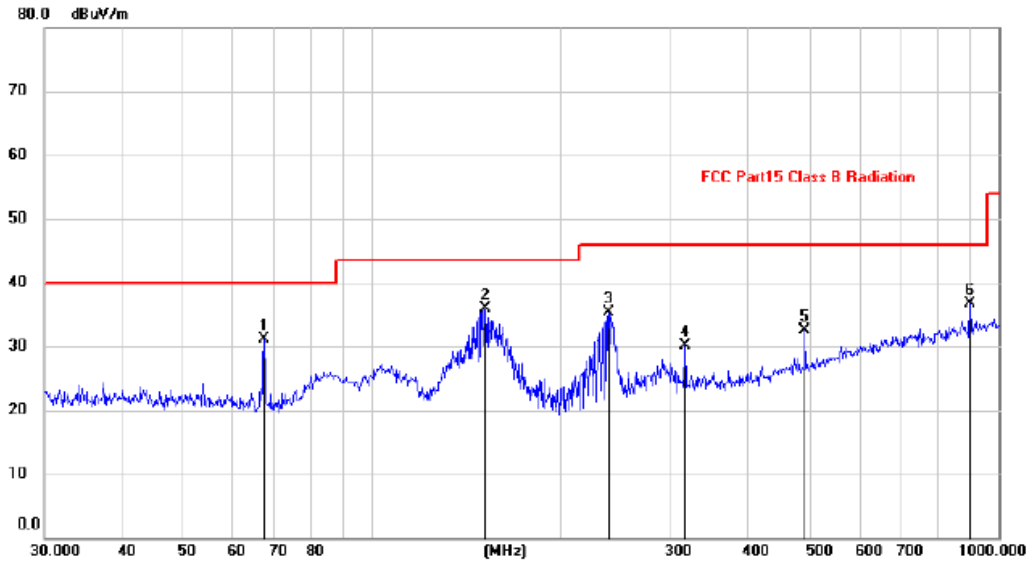

No.	Mk.	Freq.	Reading Level	Correct Factor	Measurement	Limit	Margin	Antenna Height	Table Degree	
		MHz	dBuV	dB	dBuV/m	dBuV/m	dB	cm	degree	Comment
1		67.2022	19.56	11.49	31.05	40.00	-8.95			peak
2	*	151.0666	21.33	14.56	35.89	43.50	-7.61			peak
3		239.1473	23.43	11.96	35.39	46.00	-10.61			peak
4		316.5890	16.35	13.79	30.14	46.00	-15.86			peak
5		490.7447	15.06	17.39	32.45	46.00	-13.55			peak
6		900.1474	13.81	22.95	36.76	46.00	-9.24			peak

V

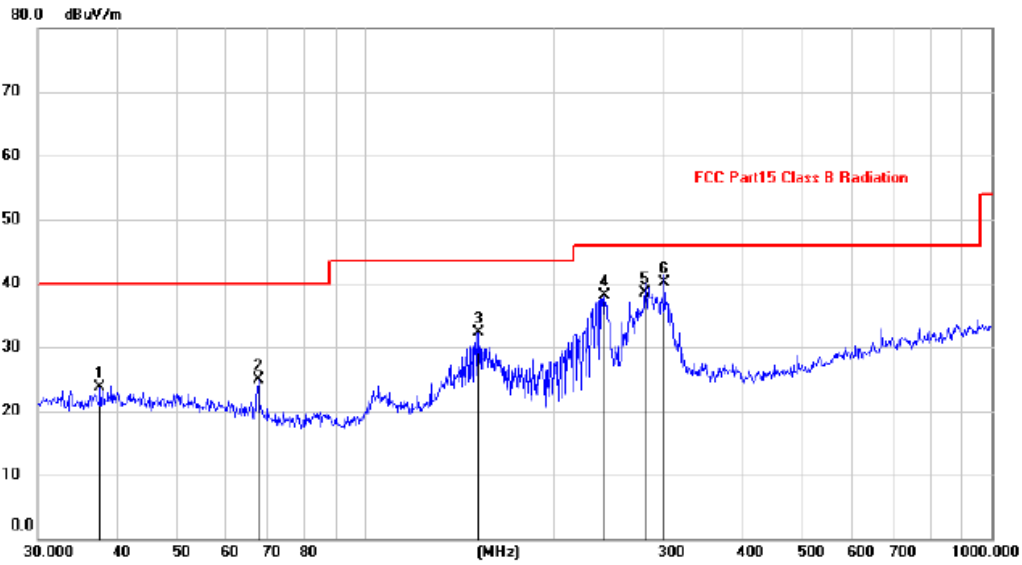

No.	Mk.	Freq. MHz	Reading Level dBuV	Correct Factor dB	Measure- ment dBuV/m	Limit dBuV/m	Margin dB	Detector	Antenna Height cm	Table Degree	Comment
1		37.6798	9.82	13.82	23.64	40.00	-16.36	peak			
2		67.4382	13.41	11.49	24.90	40.00	-15.10	peak			
3		151.0666	17.74	14.56	32.30	43.50	-11.20	peak			
4		240.8304	26.12	11.99	38.11	46.00	-7.89	peak			
5		280.0237	25.49	12.97	38.46	46.00	-7.54	QP	100	0	
6	*	301.4224	26.66	13.51	40.17	46.00	-5.83	QP	100	0	

Notes: Above is below 1GHz test data. This report only shall the worst case mode for TX 2440MHz.

From 1G-25GHz

Test Mode: TX Low									
Freq (MHz)	Read Level (dBuV/m)	Polar (H/V)	Antenna Factor (dB/m)	Cable loss(dB)	Amp Factor (dB)	Result (dBuV/m)	Limit (dBuV/m)	Margin (dB)	Remark
4804	42.32	V	33.95	10.18	34.26	52.19	74	21.81	PK
4804	33.21	V	33.95	10.18	34.26	43.08	54	10.92	AV
7206	/		/						
9608	/		/						
4804	43.11	H	33.95	10.18	34.26	52.98	74	21.02	PK
4804	30.23	H	33.95	10.18	34.26	40.1	54	13.90	AV
7206									
9608									
Test Mode: TX Mid									
4880	42.32	V	33.93	10.18	34.26	52.17	74	21.83	PK
4880	32.23	V	33.93	10.18	34.26	42.08	54	11.92	AV
7320	/								
9760	/								
4880	43.32	H	33.93	10.18	34.26	53.17	74	20.83	PK
4880	30.14	H	33.93	10.18	34.26	39.99	54	14.01	AV
7320									
9760									
Test Mode: TX High									
4960	42.45	V	33.98	10.18	34.26	52.35	74	21.65	PK
4960	33.21	V	33.98	10.18	34.26	43.11	54	10.89	AV
7440	/								
9920	/								
4960	43.65	H	33.98	10.18	34.26	53.55	74	20.45	PK
4960	30.13	H	33.98	10.18	34.26	40.03	54	13.97	AV
7440	/								
9920	/								
Note:									
1, Result = Read level + Antenna factor + cable loss-Amp factor									
2, All the other emissions not reported were too low to read and deemed to comply with FCC limit.									

4. POWER LINE CONDUCTED EMISSION

4.1. Test Limits

Frequency MHz	Limits dB(μ V)	
	Quasi-peak Level	Average Level
0.15 -0.50	66 -56*	56 - 46*
0.50 -5.00	56	46
5.00 -30.00	60	50

- Notes: 1. *Decreasing linearly with logarithm of frequency.
 2. The lower limit shall apply at the transition frequencies.
 3. The limit decreases in line with the logarithm of the frequency in rang of 0.15 to 0.50 MHz.

4.2. Test Procedure

The EUT is put on the plane 0.8m high above the ground by insulating support and is connected to the power mains through a line impedance stabilization network (L.I.S.N.). This provides a 50ohm coupling impedance for the EUT system. Please refer the block diagram of the test setup and photographs. Both sides of AC lines are checked to find out the maximum conducted emission. In order to find the maximum emission levels, the relative positions of equipment and all of the interface cables shall be changed according to ANSI ANSI C63.10:2013 on Conducted Emission Measurement.

The bandwidth of test receiver is set at 9 kHz.

4.3. Test Setup

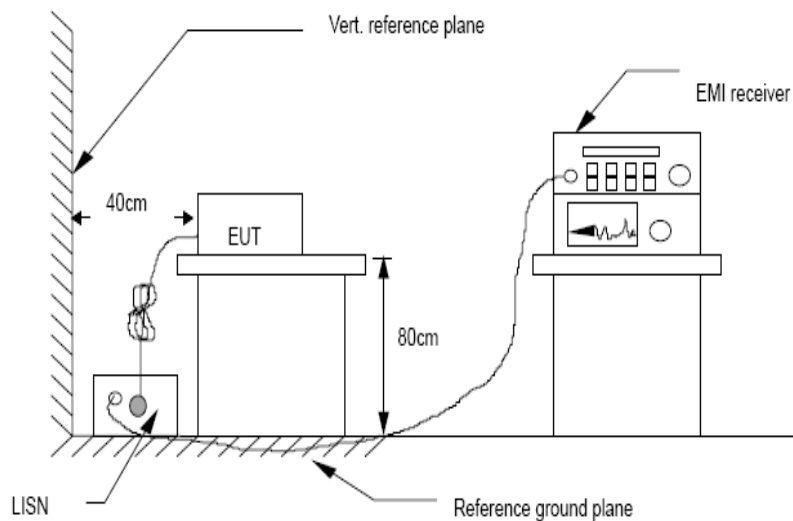

4.4. Test Results

Test Date	: 2019.02.20	Temperature	: 22.7°C
Test Engineer	: Reak Yang	Humidity	: 49%
Test Mode	: Link		
Test Voltage	DC 5V from Notebook PC with AC120V/60Hz		
Test Results	: PASS		

Note:

1. The test results are listed in next pages.
2. If the limits for the measurement with the average detector are met when using a receiver with a peak detector, the test unit shall be deemed to meet both limits and the measurement with the average detector and quasi-peak detector need not be carried out.
3. If the limits for the measurement with the average detector are met when using a receiver with a quasi-peak detector, the test unit shall be deemed to meet both limits and the measurement with the average detector need not be carried out.

Line

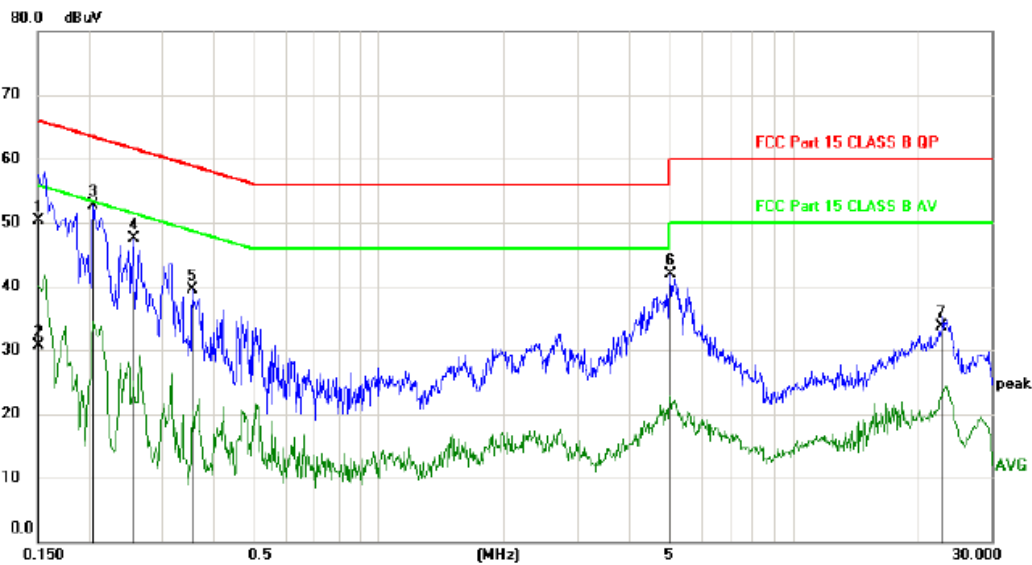

No.	Mk.	Freq. MHz	Reading Level dBuV	Correct Factor dB	Measure- ment dBuV	Limit dBuV	Margin dB	Detector	Comment
1		0.1500	50.27	0.13	50.40	66.00	-15.60	QP	
2		0.1500	30.65	0.13	30.78	56.00	-25.22	AVG	
3	*	0.2040	52.67	0.13	52.80	63.45	-10.65	peak	
4		0.2550	47.44	0.13	47.57	61.59	-14.02	peak	
5		0.3540	39.45	0.13	39.58	58.87	-19.29	peak	
6		5.0370	41.64	0.23	41.87	60.00	-18.13	peak	
7		22.7340	32.79	0.82	33.61	60.00	-26.39	peak	

Neutral:

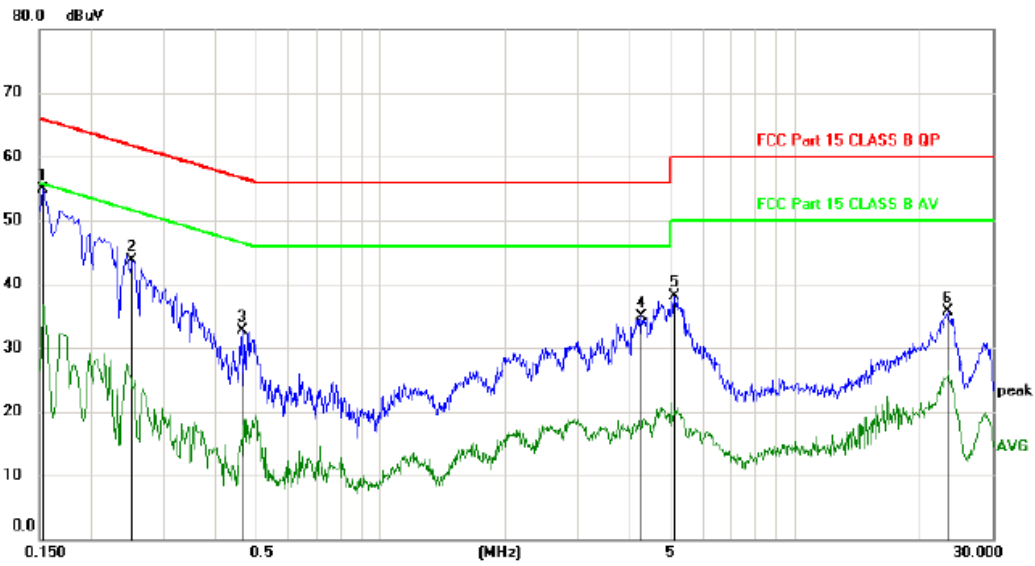

No.	Mk.	Freq. MHz	Reading Level dBuV	Correct Factor dB	Measure- ment dBuV	Limit dBuV	Margin dB	Detector	Comment
1	*	0.1530	54.70	0.13	54.83	65.84	-11.01	peak	
2		0.2519	43.61	0.13	43.74	61.69	-17.95	peak	
3		0.4650	32.50	0.13	32.63	56.60	-23.97	peak	
4		4.2510	34.78	0.22	35.00	56.00	-21.00	peak	
5		5.1240	37.89	0.23	38.12	60.00	-21.88	peak	
6		23.2770	34.78	0.85	35.63	60.00	-24.37	peak	

5. CONDUCTED MAXIMUM OUTPUT POWER

5.1. Test limits

Please refer section RSS-247 & 15.247.

5.2. Test Procedure

Details see the KDB558074 D01 Meas Guidance V04

5.2.1 Place the EUT on the table and set it in transmitting mode.

5.2.2 Measure out each mode and each bands peak output power of EUT.

Note: The cable loss and attenuator loss were offset into measure device as amplitude offset.

5.3. Test Setup

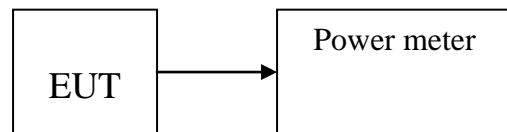

5.4. Test Results

Channel	Frequency (MHz)	PK Output Power (dBm)	PK Output Power (mW)	Limit (dBm)
CH1	2402	-0.235	0.947	30
CH20	2440	0.331	1.079	30
CH40	2480	0.029	1.007	30
Conclusion: PASS				

6. PEAK POWER SPECTRAL DENSITY

6.1. Test limits

6.1.1 Please refer section RSS-247 & 15.247.

6.1.2 For direct sequence systems, the peak power spectral density conducted from the intentional radiator to the antenna shall not be greater than 8dBm in any 3kHz band during any time interval of continuous transmission.

6.1.3 The direct sequence operating of the hybrid system, with the frequency hopping operation turned off, shall comply with the power density requirements of paragraph (d) of this section.

6.2. Test Procedure

Details see the KDB558074 D01 Meas Guidance V04

6.2.1 Place the EUT on the table and set it in transmitting mode.

6.2.2 Remove the antenna from the EUT and then connect a low loss RF cable from the antenna port to the spectrum analyzer.

6.2.3 Set the spectrum analyzer as RBW = 3kHz(Set the RBW to: $3\text{ kHz} \leq \text{RBW} \leq 100\text{ kHz}$.),
VBW = 10kHz(Set the VBW $\geq 3 \times \text{RBW}$), span= $1.5 \times \text{DTS bandwidth}$., detail see the test plot.

6.2.4 Record the max reading.

6.2.5 Repeat the above procedure until the measurements for all frequencies are completed.

6.3. Test Setup

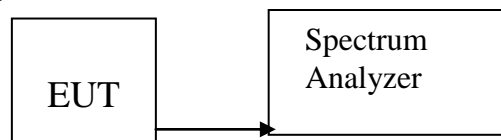

6.4. Test Results

Channel	Frequency (MHz)	Power Spectral Density (dBm)	Limit (dBm)	Result
CH1	2402	-16.634	8	PASS
CH20	2440	-17.148	8	PASS
CH40	2480	-16.901	8	PASS
Conclusion: PASS				

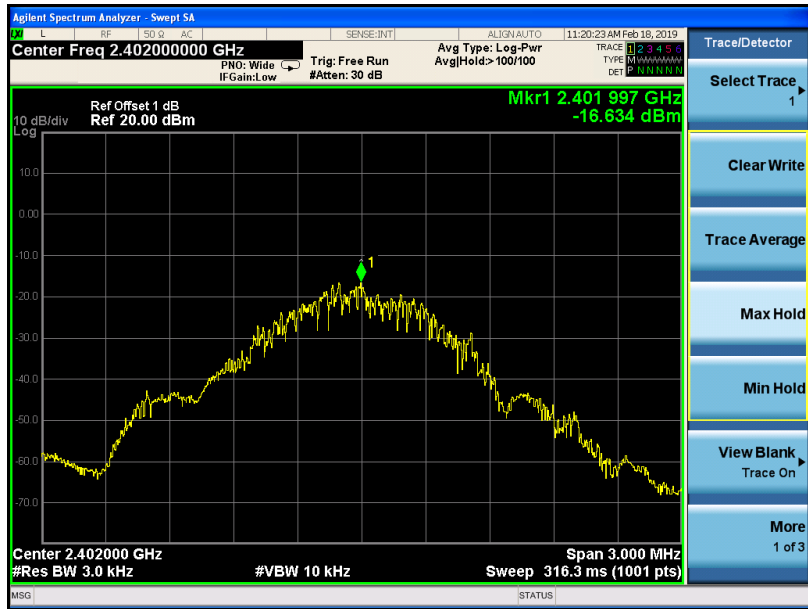



7. BANDWIDTH

7.1. Test limits

Please refer section RSS-247 & 15.247

For direct sequence systems, the minimum 6dB bandwidth shall be at least 500 kHz.

7.2. Test Procedure

Details see the KDB558074 D01 Meas Guidance V04

a) The bandwidth is measured at an amplitude level reduced 20dB from the reference level. The reference level is the level of the highest amplitude signal observed from the transmitter at the fundamental frequency. Once the reference level is established, the equipment is conditioned with typical modulating signal to produce the worst-case (i.e. the widest) bandwidth.

b) The test receiver set RBW = 100kHz, VBW $\geq 3 \cdot$ RBW = 300kHz, Sweep time set auto, detail see the test plot.

7.3. Test Setup

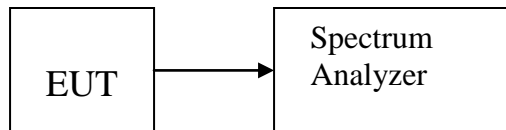

7.4. Test Results

Channel	Frequency (MHz)	6dB Bandwidth (MHz)	Limit (MHz)	Result
CH1	2402	0.704	0.5	PASS
CH20	2440	0.686	0.5	PASS
CH40	2480	0.679	0.5	PASS

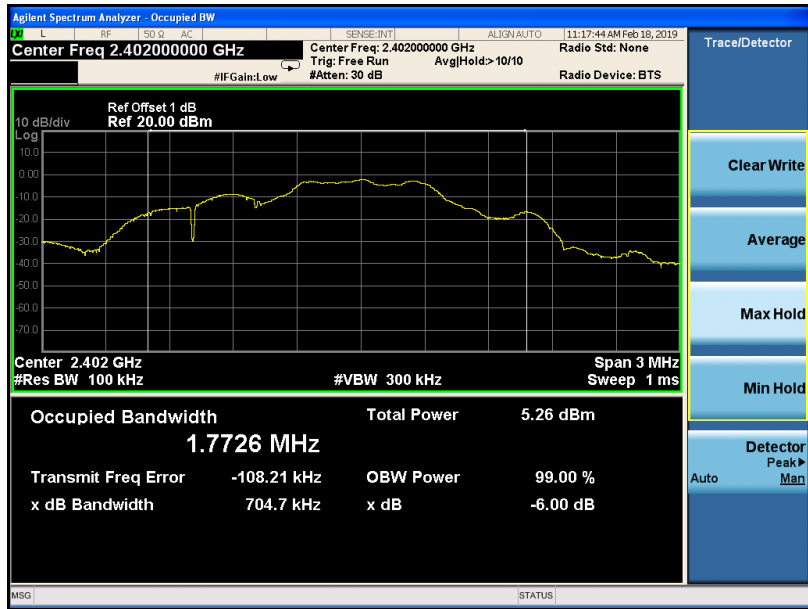



8. BAND EDGE CHECK

8.1. Test limits

Please refer section RSS-GEN&15.247.

8.2. Test Procedure

Details see the KDB558074 D01 Meas Guidance V04

8.2.1 Put the EUT on a 0.8m high table, power on the EUT. Emissions were scanned and measured rotating the EUT to 360 degrees, Find the maximum Emission

8.2.2 Check the spurious emissions out of band.

8.2.3 RBW 1MHz ,VBW 3MHz ,peak detector for peak value , RBW 1MHz ,VBW 3MHz ,RMS detector for AV value.

8.3. Test Setup

Same as 5.2.2.

8.4. Test Results

Radiated Method:

H

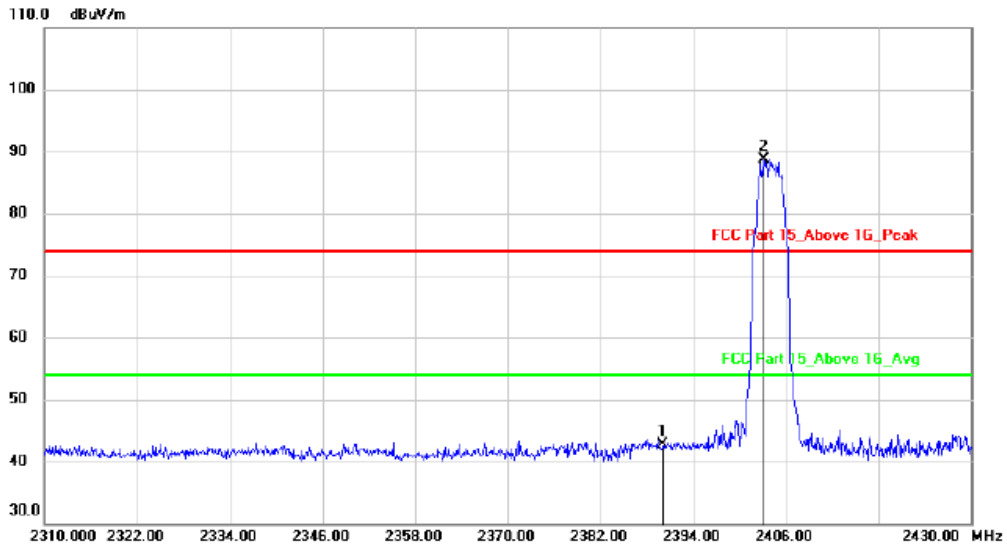

No. Mk.	Freq. MHz	Reading Level dBuV	Correct Factor dB	Measurement dBuV/m	Limit dBuV/m	Margin dB	Detector	Antenna Height cm	Table Degree	Comment
1	2390.000	46.00	-3.40	42.60	74.00	-31.40	peak			
2 *	2403.120	92.09	-3.41	88.68	74.00	14.68	peak			

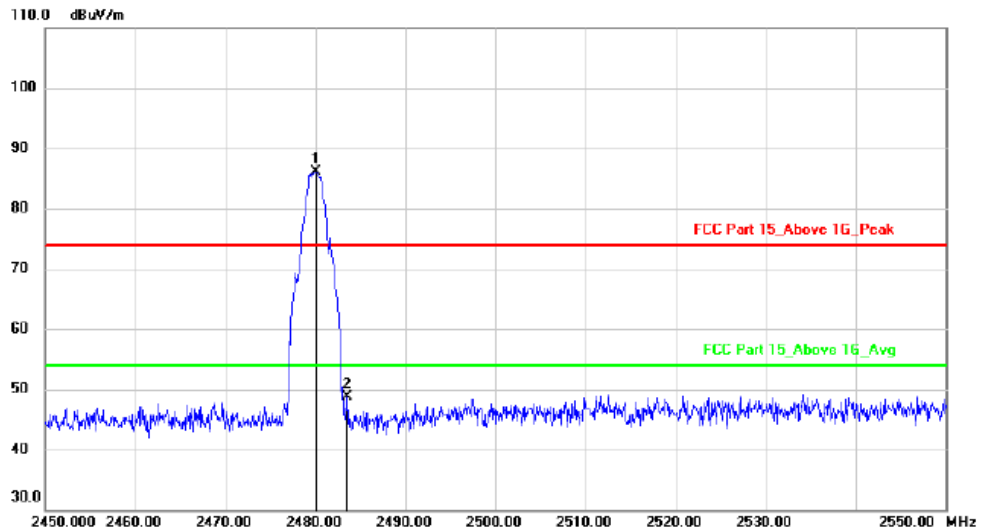

No. Mk.	Freq. MHz	Reading Level dBuV	Correct Factor dB	Measurement dBuV/m	Limit dBuV/m	Margin dB	Detector	Antenna Height cm	Table Degree	Comment
1 *	2480.100	89.55	-3.38	86.17	74.00	12.17	peak			
2	2483.500	52.07	-3.38	48.69	74.00	-25.31	peak			

V

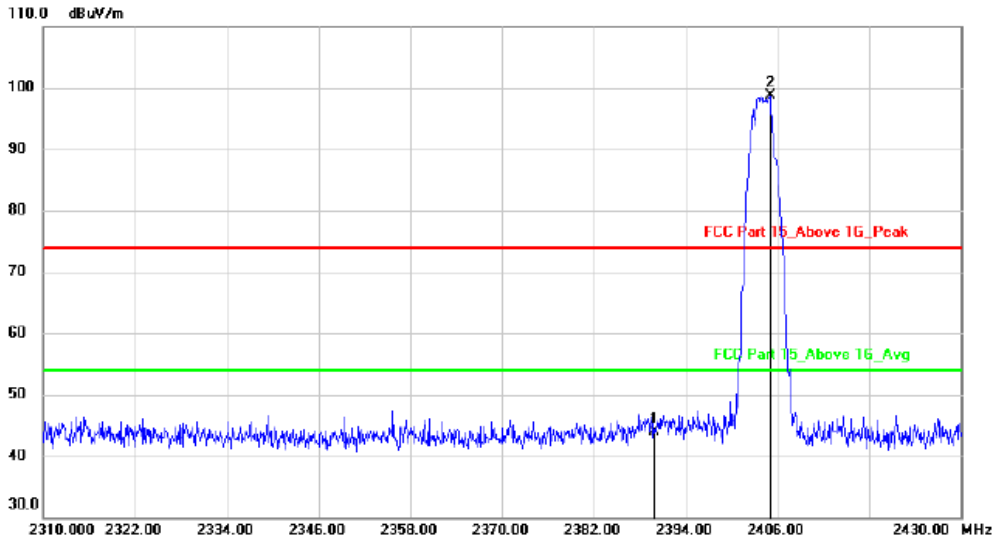

No.	Mk.	Freq.	Reading Level	Correct Factor	Measurement	Limit	Margin	Antenna Height	Table Degree
		MHz	dBuV	dB	dBuV/m	dBuV/m	dB	cm	degree
1		2390.000	47.30	-3.40	43.90	74.00	-30.10	peak	
2	*	2405.040	102.02	-3.41	98.61	74.00	24.61	peak	

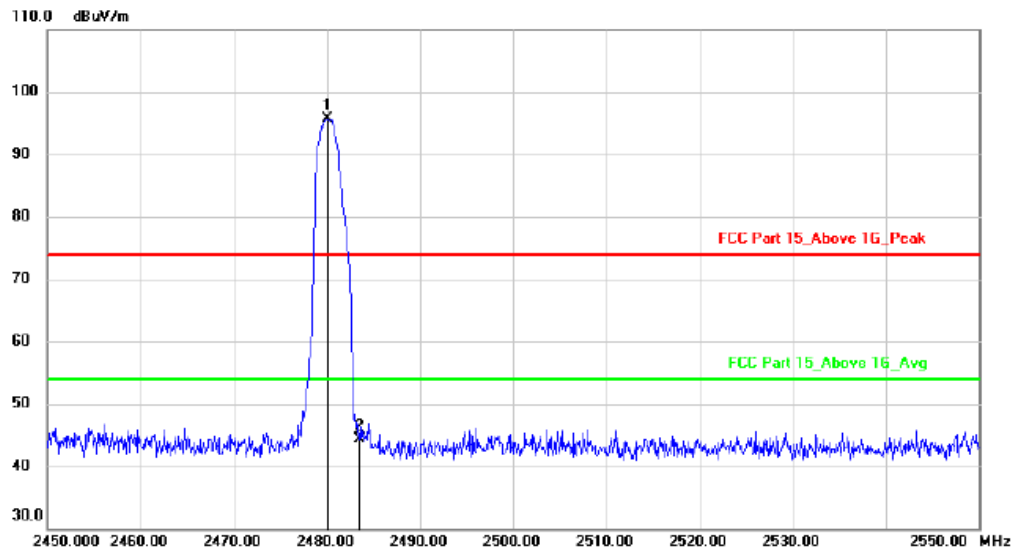

No.	Mk.	Freq.	Reading Level	Correct Factor	Measurement	Limit	Margin	Antenna Height	Table Degree
		MHz	dBuV	dB	dBuV/m	dBuV/m	dB	cm	degree
1	*	2480.000	99.03	-3.38	95.65	74.00	21.65	peak	
2		2483.500	47.77	-3.38	44.39	74.00	-29.61	peak	

Conducted Method:
GFSK

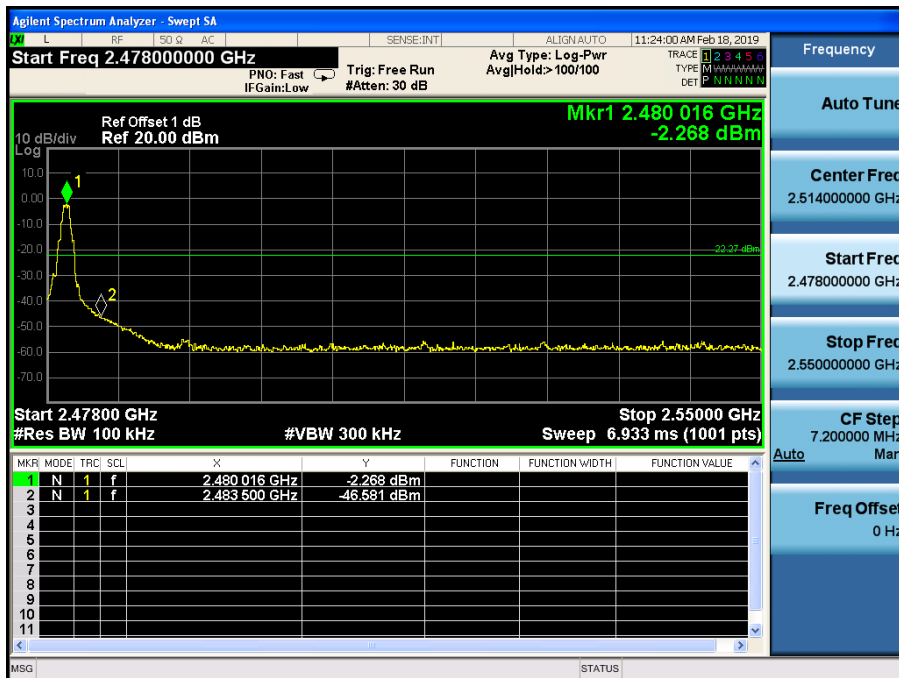
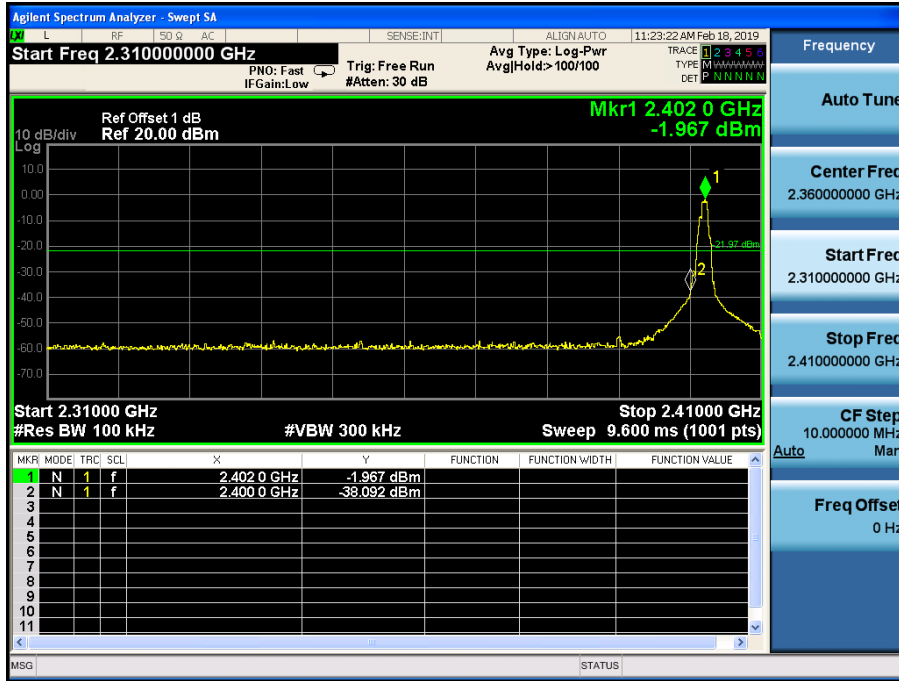

9. ANTENNA REQUIREMENT

9.1. Standard Requirement

An intentional radiator shall be designed to ensure that no antenna other than that furnished by the responsible party shall be used with the device. The use of a permanently attached antenna or of an antenna that uses a unique coupling to the intentional radiator shall be considered sufficient to comply with the provisions of this Section. The manufacturer may design the unit so that a broken antenna can be replaced by the user, but the use of a standard antenna jack or electrical connector is prohibited.

9.2. Antenna Connected Construction

The antenna is PCB antenna and no consideration of replacement. Please see EUT photo for details.

9.3. Results

The EUT antenna is PCB Antenna. It complies with the standard requirement.

10. TEST SETUP PHOTO

10.1. Photos of Radiated emission

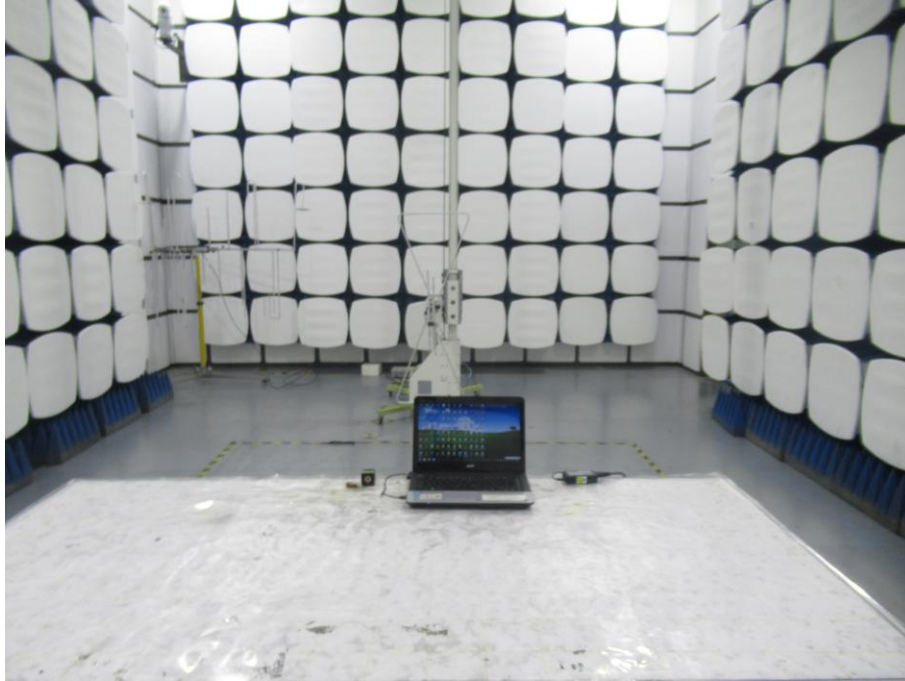

10.2.Photos of Power Line Conducted Emission



11.EUT PHOTO

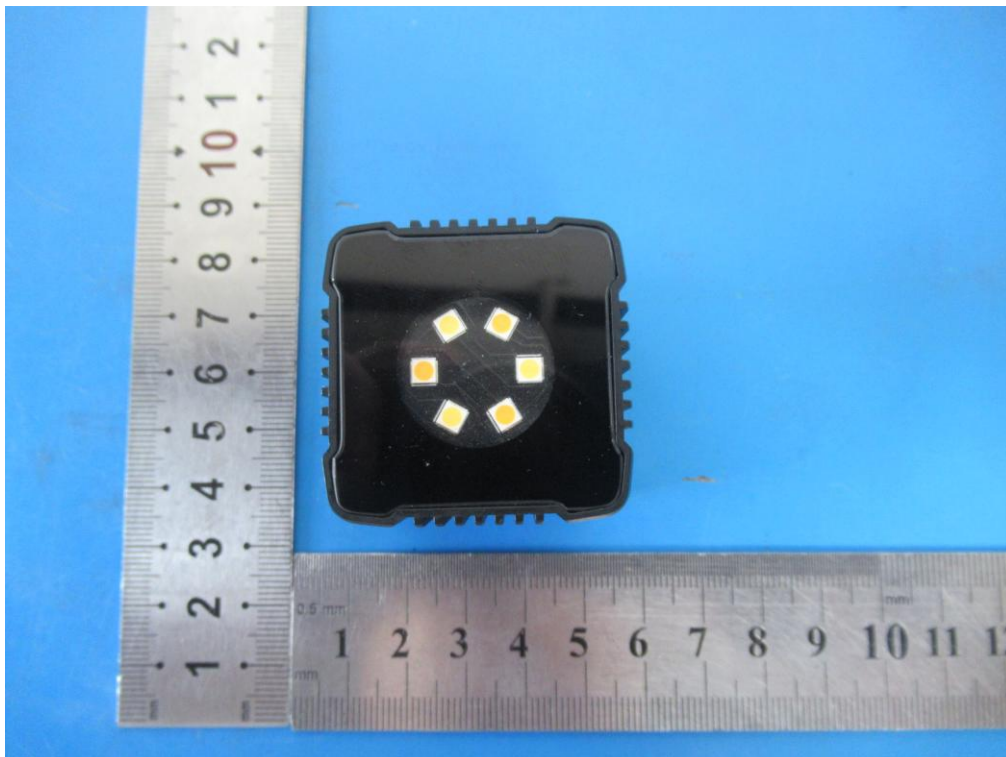

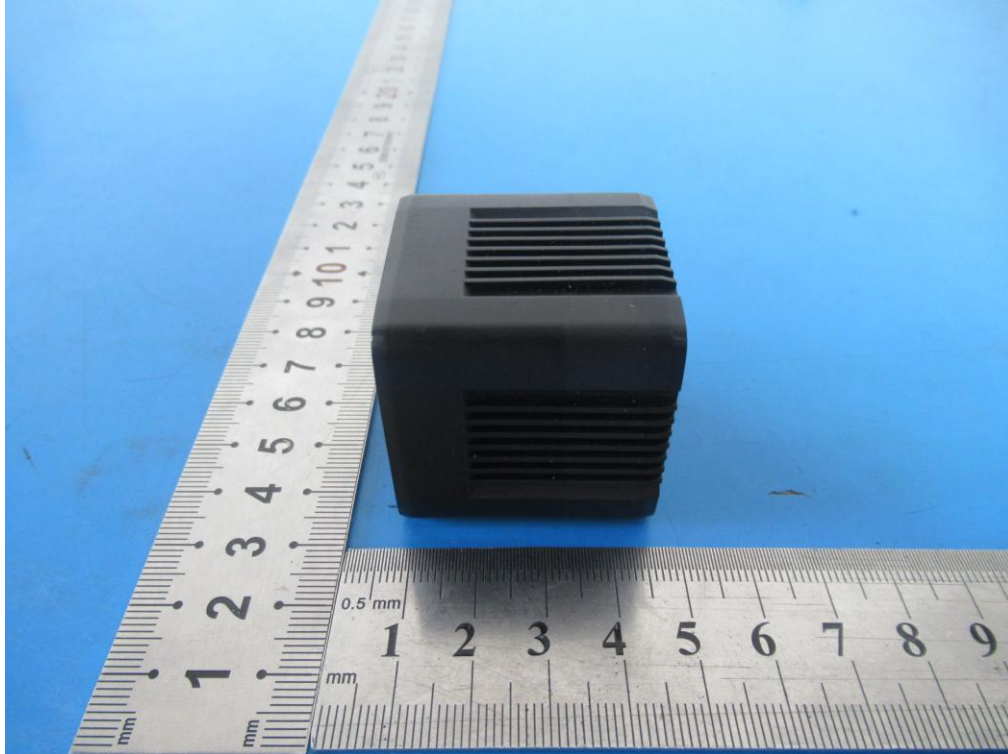
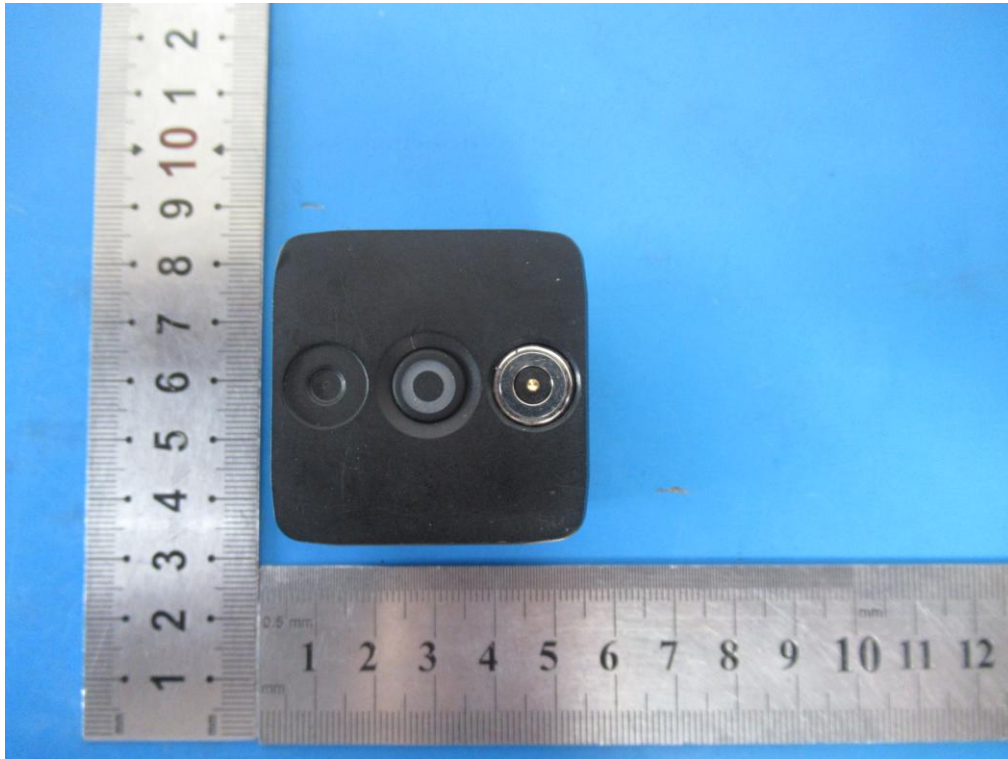

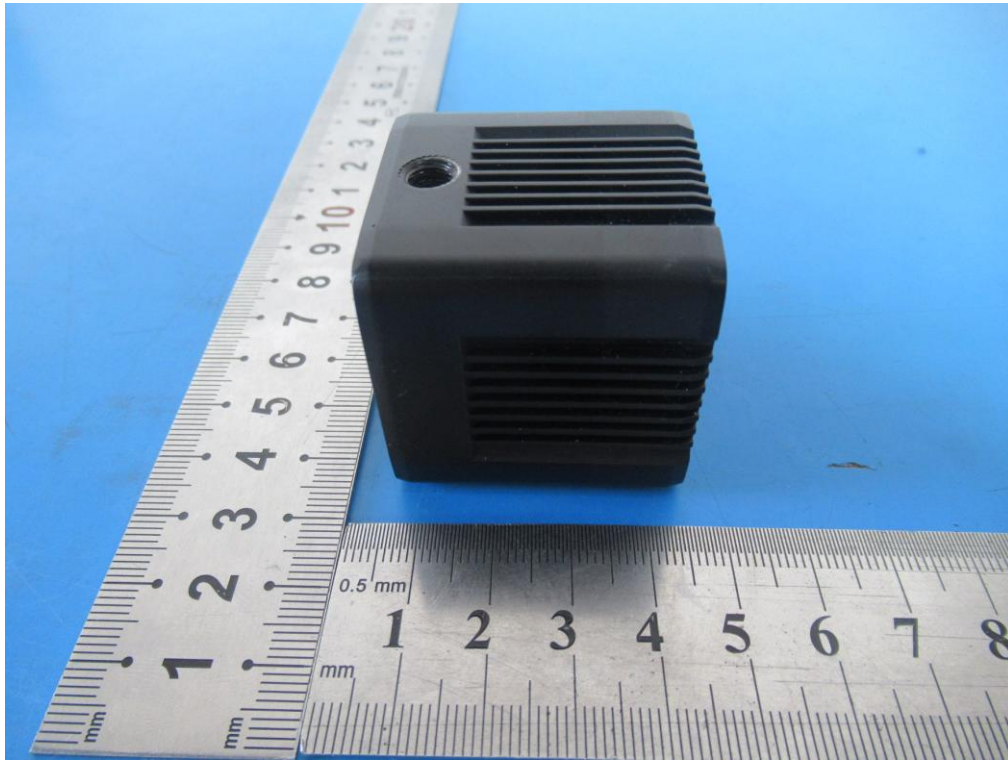

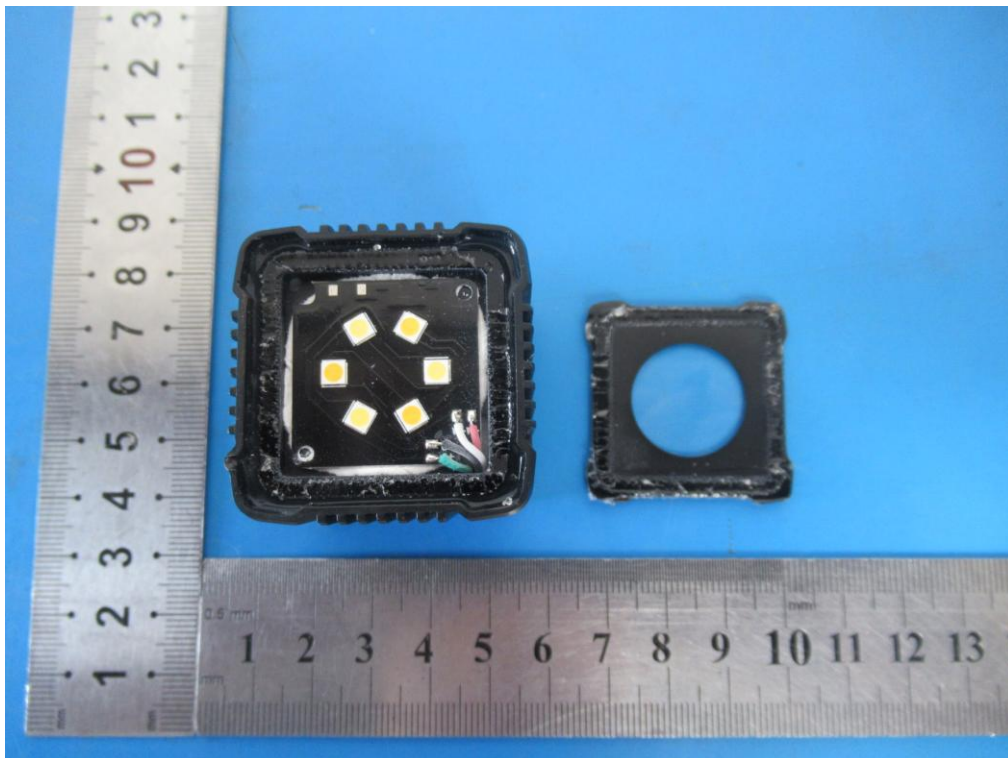
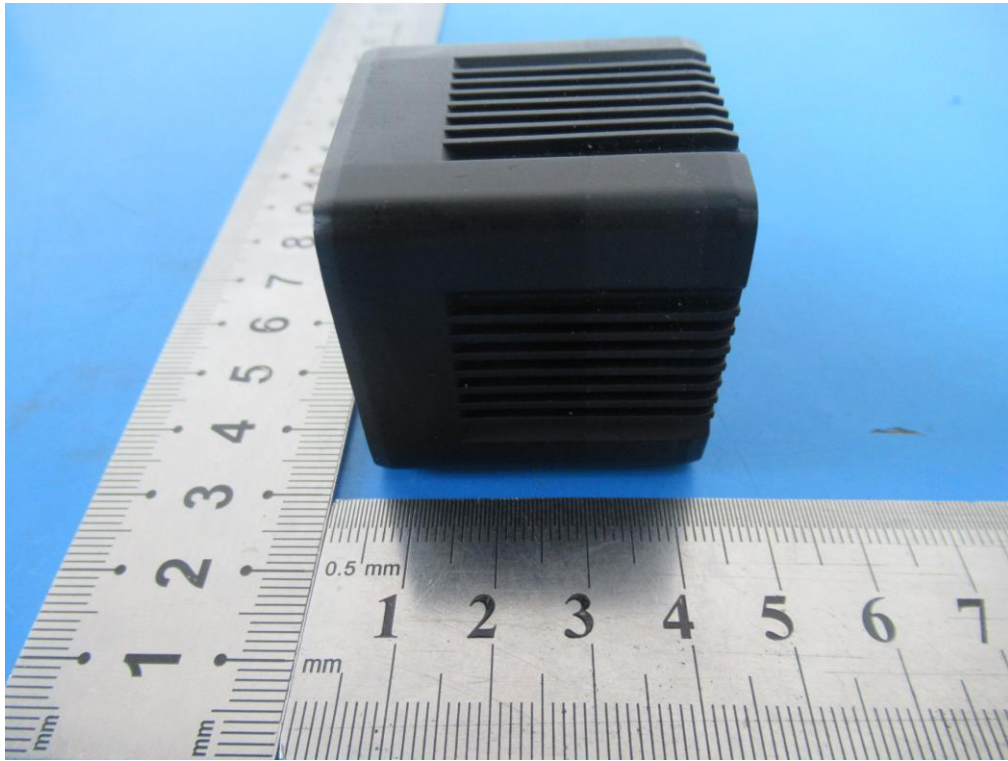

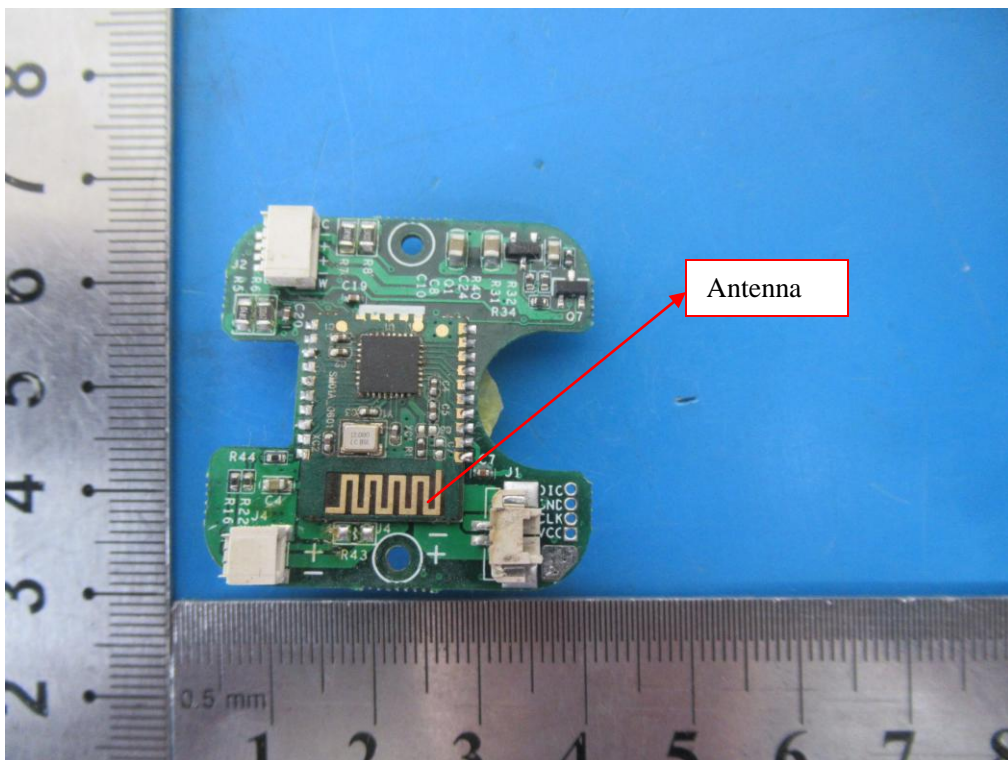

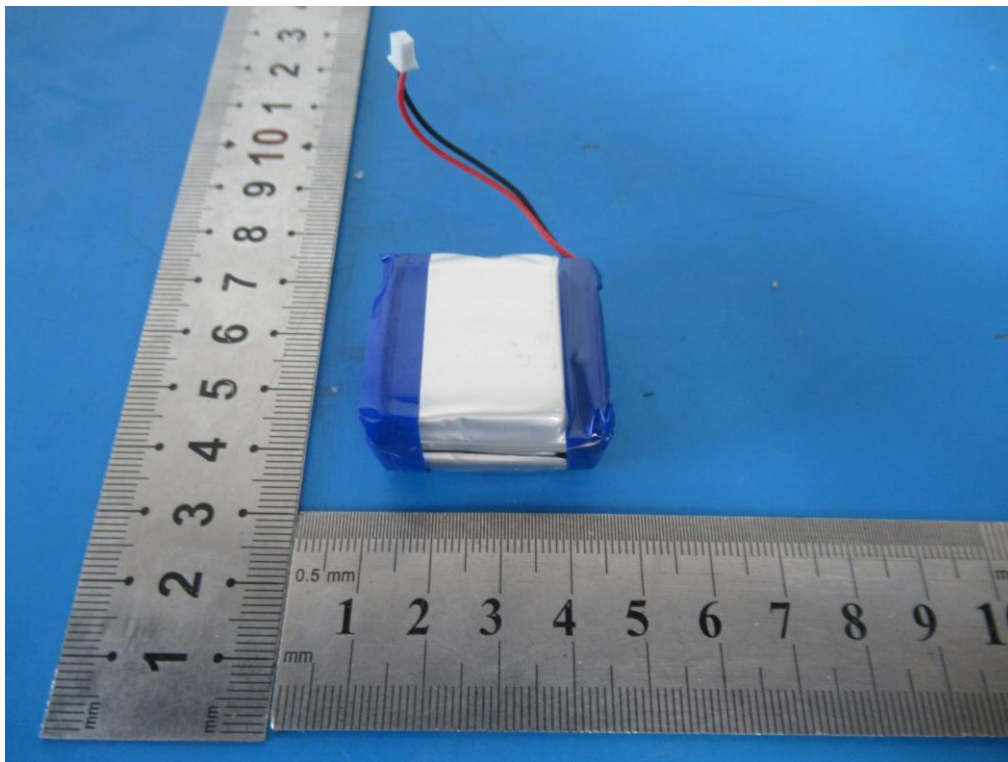
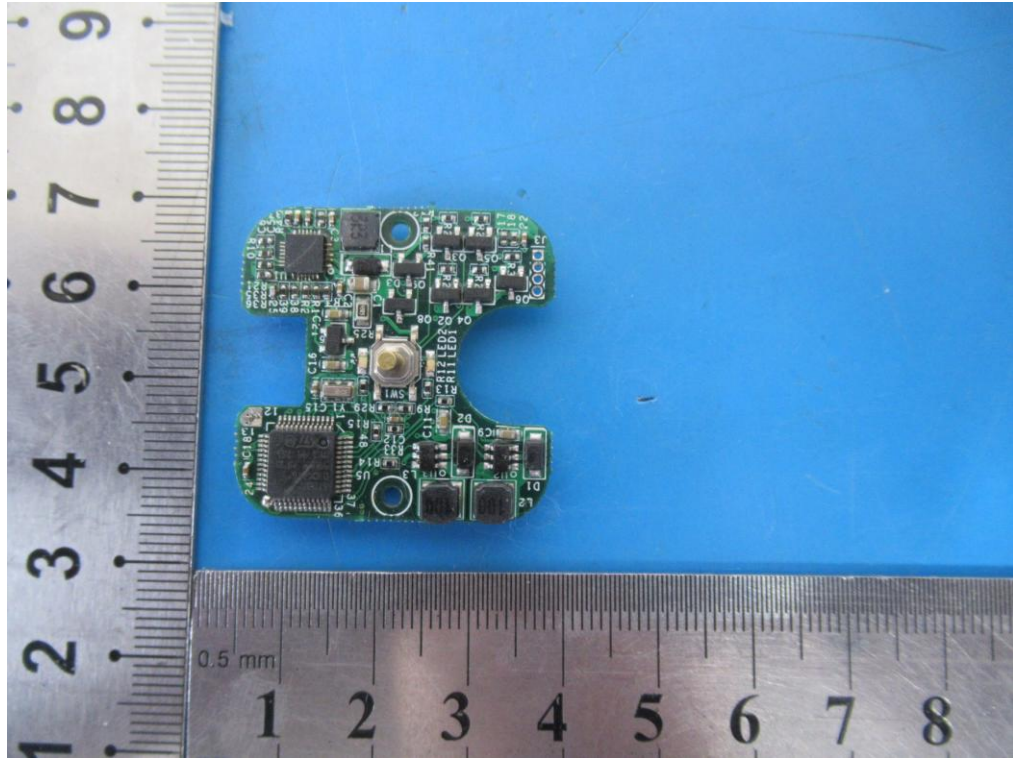

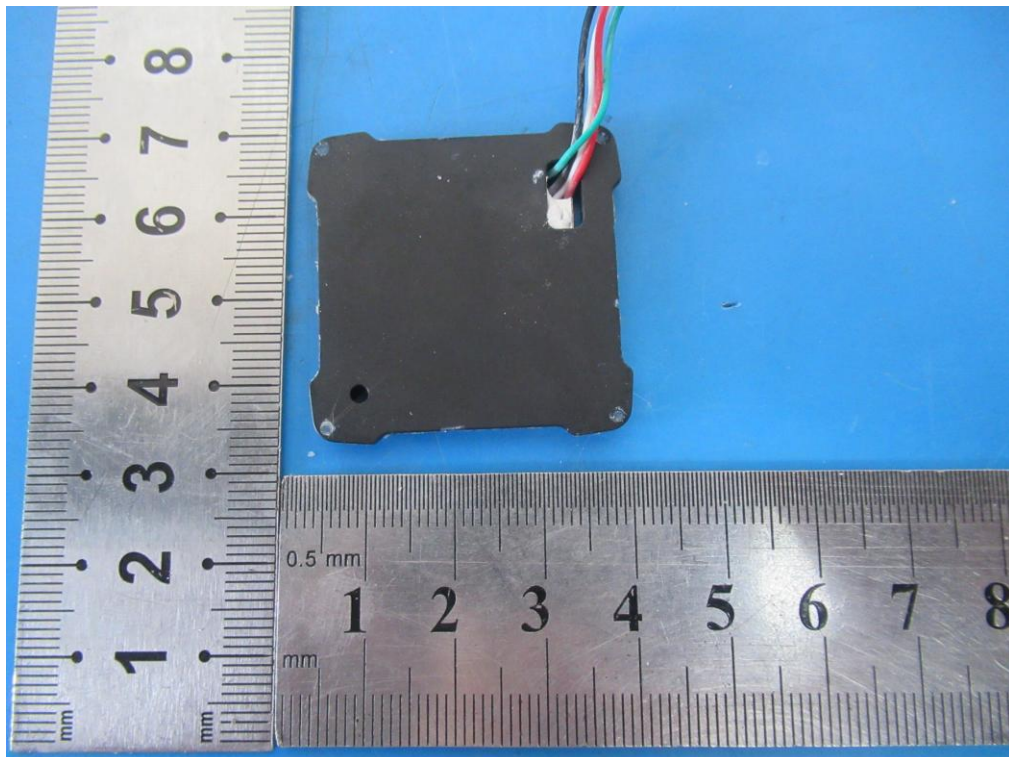
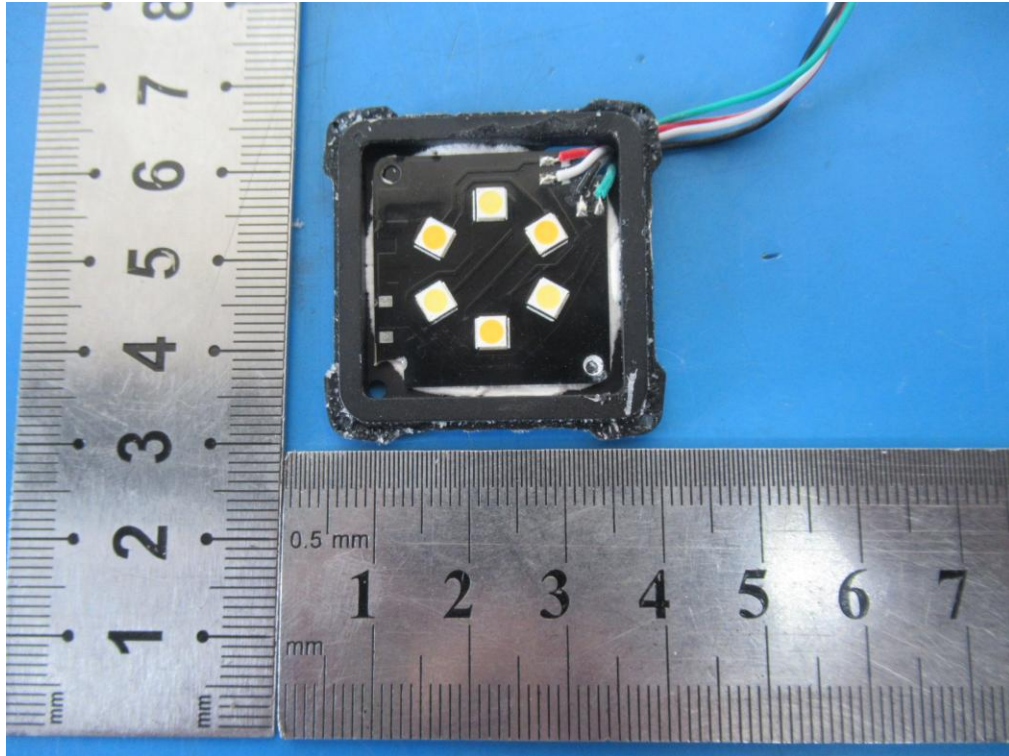



-----THE END OF REPORT-----