

MOZA AIR 2S

User Manual

Contents

■	Packing List	1
■	MOZA Air 2S Overview	3
■	Air 2S Installation.....	4
•	Attaching the Tripod	4
•	Battery startup and shutdown	4
•	Mounting the Camera	5
•	Connecting Camera Control Cable	6
•	Installing the Support Rod	6
■	Balance Adjustment	7
•	Balancing the Camera	7
•	Balancing the Tilt Axis	7
•	Balancing the Roll Axis	8
•	Balancing the Pan Axis	8
■	Buttons and OLED Display	9
•	Button Functions	9
•	Main Interface	9
•	Menu Description	10
■	Features Description	12
•	Camera Control.....	12
•	Motor Output.....	14
•	FPV,Sport Gear Mode.....	15
•	Manual Positioning	16
•	Button Customization.....	16
•	Inception Mode.....	16
•	Balance Check	17
•	Sensor Calibration	18
•	Language Switch.....	19
•	User Configuration.....	19
■	Management	20
•	Smartphone and PC connection	20
•	Install the Phone Holder	20
•	FirmwareUpgrade	20
■	SPECS.....	21

Packing List

Check that all of the following items are in your package. If any item is missing, please contact MOZA or your local dealer.

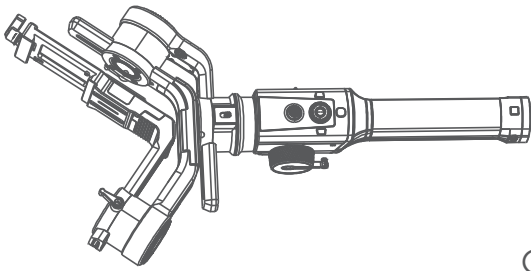

x1

Gimbal

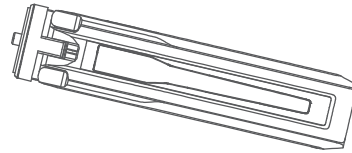

x1

Tripod

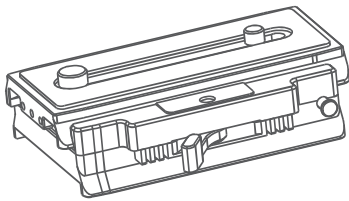

x1

Quick Release System

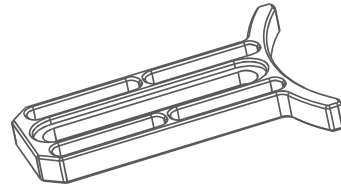

x1

Lens Support

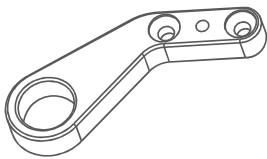

x1

Support Rod Adapter



x2

M3 Screw



x1

H2 L-Allen Wrench

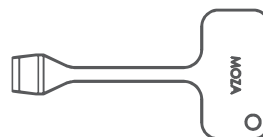

x1

Disassembly spanner

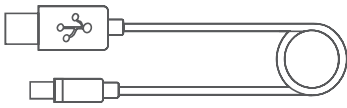

x1

USB-C Cable

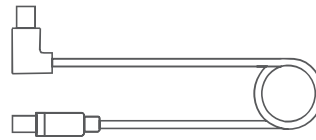

x1

M3C-Micro

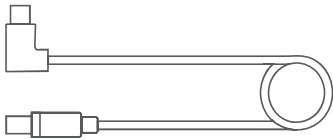

x1

M3C-Mini

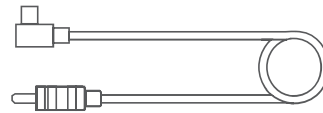

x1

MCSC-Remote

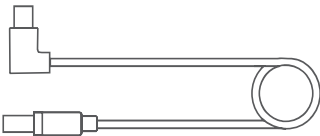

x1

MCSC-Multi

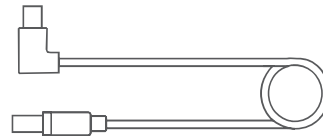

x1

MCSC-Multi/C



x2

Follow Focus Support Rod



x1

Lens Support Screw

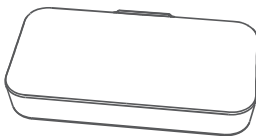

x1

Storage Case



x1

Tool Box



x1

User Manual

MOZA Air 2S Overview

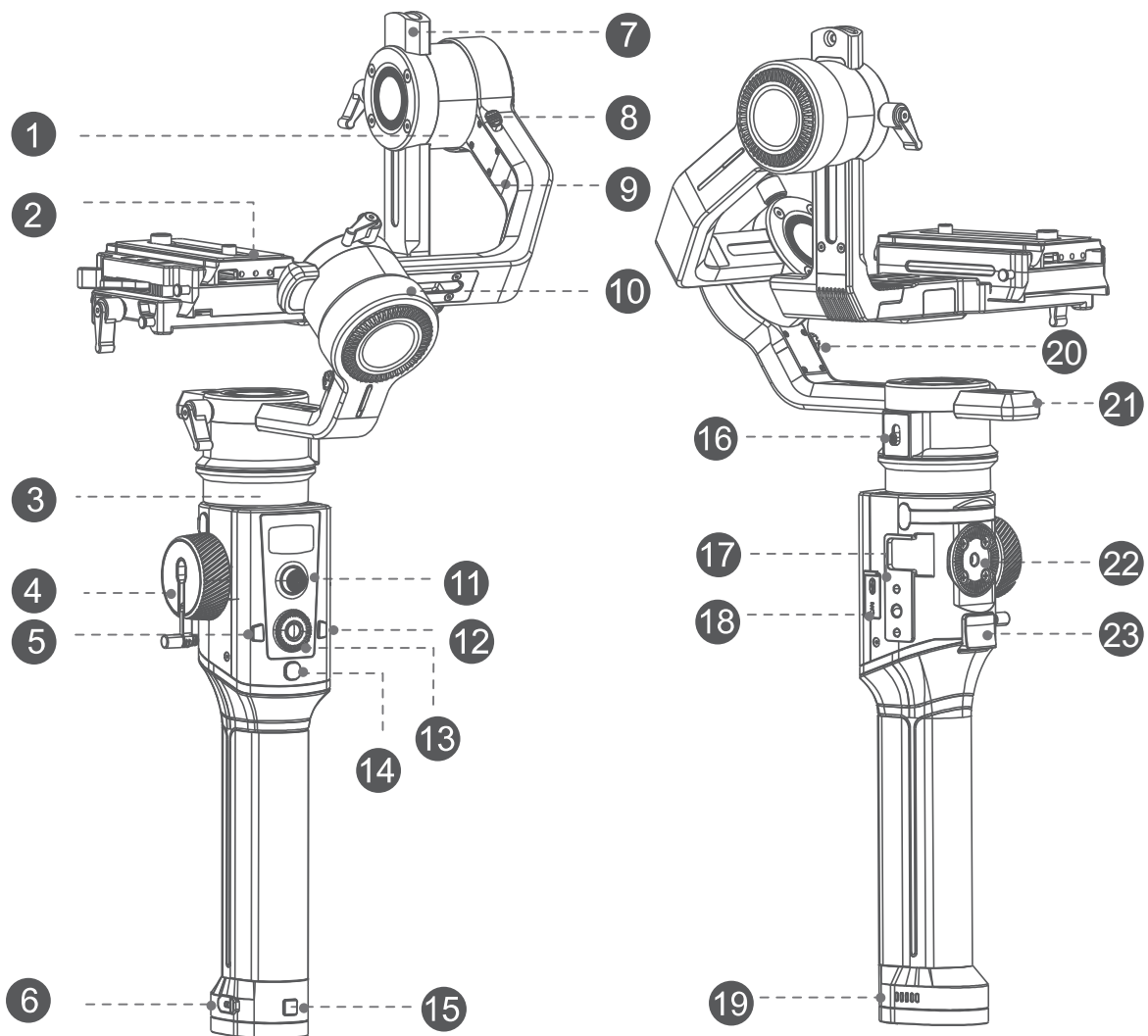

- | | | | |
|------------------------------------------|-------------------|-----------------------------------------------------|----------------------------|
| 1 Tilt Motor | 7 Tilt Arm | 13 Dial | 19 Battery Indicator Light |
| 2 Mechanical Memory Quick Release System | 8 Tilt Motor Lock | 14 Power Button | 20 Roll Motor Lock |
| 3 Pan Motor | 9 Roll Arm | 15 Battery on/off Button | 21 Pan Arm |
| 4 Wheel | 10 Roll Motor | 16 Pan Motor Lock | 22 1/4"Extension Port |
| 5 M Button | 11 Joystick | 17 Extension Port | 23 Smart Trigger |
| 6 Type-C Port | 12 Fn Button | 18 Adjust parameters and firmware upgrade interface | |

Air 2S Installation

Attaching the Tripod

2 screw holes are equipped at the bottom of grip: 1/4" for mini tripod and 3/8" for large accessories like slider and big tripod. Screw the mini tripod, then expand as shown below.

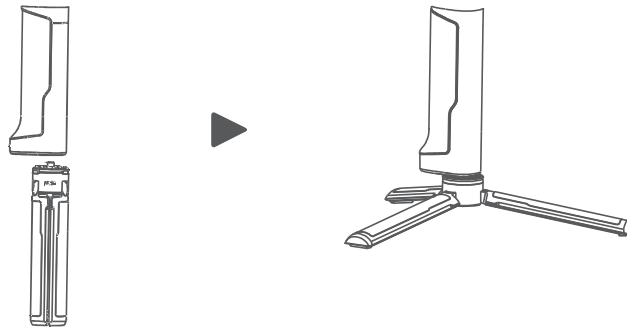

Battery startup and shutdown

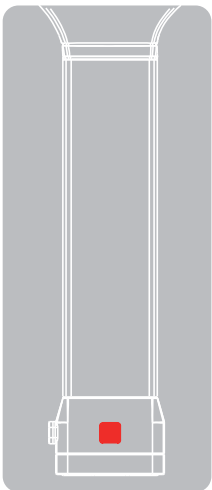

- a. Long press the power button,
- b. Press the power button of battery, then long press the power button again three seconds later. After the battery indicator lights turn off from left to right, release the battery on key and the battery will turn off.
- c. When the battery is in the off state of PTZ, it will automatically turn off 10 minutes later. To start the PTZ, you need to turn on the battery first.

! It is recommended to press the on / off key of the stabilizer for a long time to turn off the stabilizer, and then turn off the battery according to the operation when shutting down.

Mounting the Camera

The Air 2S quick release plate is equipped with 2 screws, select an appropriate one according to the camera type. There is no limit to the installing direction of the quick release plate. When mounting the camera, make sure the lens slightly extends beyond the quick release plate in order to reserve extra room for lens support and rod adaptor

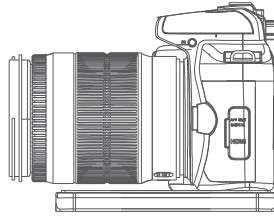

- After mounting the camera onto the quick release plate, loosen the lever A, then slide the quick release plate onto the baseplate. The quick release plate can be installed from both back and forth.
- Please make sure the safety lock 1 and 2 will eject once each, and a rough back and forth balance is reached.

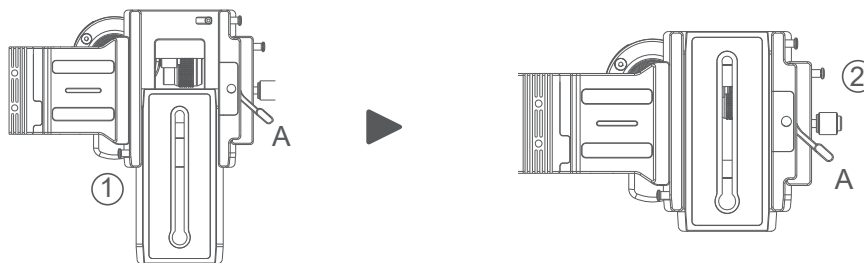

- Press the safety lock 1, the quick release plate will be removed in the direction shown below.

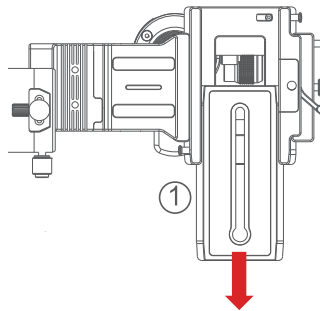

- Press the safety lock 1, slide the plate as shown below, then press the lock 2 when the plate is moved to the end. The quick release plate will be removed in the reverse direction.

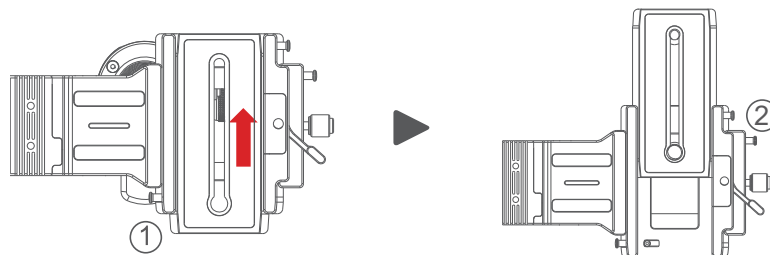

! Note: It is recommended to use the lens support for the best effect.

Connecting Camera Control Cable

4 different control cables are stored in the tool box

- a. M3C-Mini cable: For cameras with Mini port like Canon 5D3, etc
- b. M3C-Micro cable: For cameras with Micro port like Canon 5D4, etc
- c. MCSC-Remote cable: For Panasonic cameras with 2.5mm port like GH3, GH4, etc
- d. MCSC-Multi cable: For Sony cameras with Multi port like A7s II , A7 III , etc
- e. MCSC-Multi/C cable: For Sony cameras with Multi port and USB power supply like A7s II , A7 III , etc

Connect the control cable to the CAM CTRL port on the Air 2S gimbal, and then the other end to the control port on the camera. The camera icon will be displayed on the OLED screen. Then parameters adjusting, video recording or photo taking, and follow focus can be directly operated on the gimbal.

! Note:

1. For details of different cameras and lenses, please refer to 'Camera Control'.
2. If USB control is not supported, the camera icon won't display on the screen, please choose your camera control protocol manually.

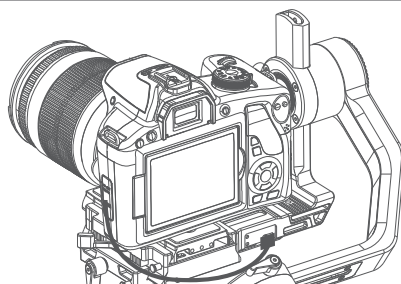

Installing the Support Rod

Please install the rod before using the follow focus.

Take out the rod adaptor, M3x10 screws, Allen wrench first. Fix the adaptor on the front or back of the quick release plate with M3x10 screws, then revolve the support rod into the adaptor.

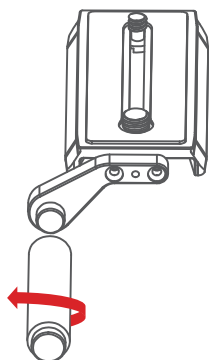

When installed at the left side, please match the stud of the rod adaptor and the screw hole of the support rod, then tighten the support rod counterclockwise.

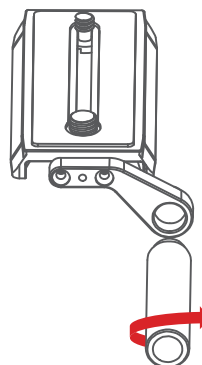

When installed at the right side, please match the screw hole of the rod adaptor and the stud of the support rod, then tighten the support rod clockwise.

! Note: 1. Please install the support rod and rod adaptor according to the position shown above for fear of falling off. 2. Can't assemble 2 support rods together as extending use

Balance Adjustment

⚠ Attention: Balance Adjustment can refer to the function of Air 2S' balance check, and it will be more convenient to adjust according to the instructions of check.

⚠ Attention: If the roll arm is locked at the overlapping position with the heading arm, please unlock the roll motor first, and do not drag it by force.

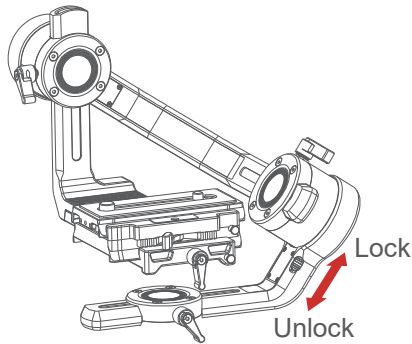

Balancing the Camera

- a. Mount the camera onto the Air 2S, release hands to check the direction of camera
- b. b.If lens is tilted upward, then the camera position is backward. Loosen quick release base and tighten the knob, move the quick release plate until lens points to frontage.
- c. c.If lens is tilted downward, then the camera position is forward. Loosen quick release base and tighten the knob, move the quick release plate until lens points to frontage.
- d. d.Tighten the quick release base and knob.

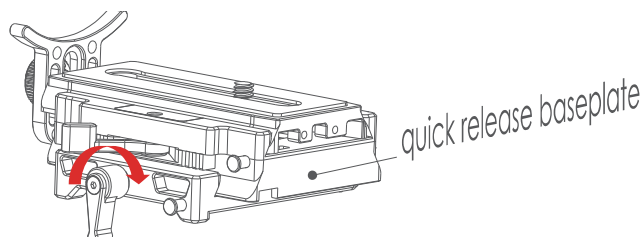

Balancing the Tilt Axis

- a. Rotate the camera so that the lens is pointing upward, release hands to check the direction in which the camera swings.
- b. Loosen the knob 1 on the tilt motor to slide the tilt arm 2 until the camera stays still without tilting it up or down.
- c. Tighten the knob 1.

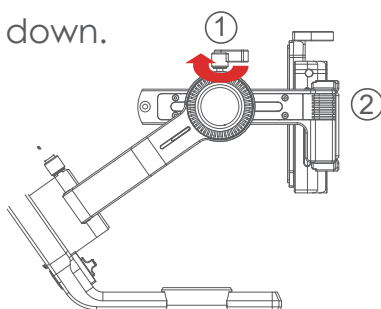

Balancing the Roll Axis

- a. Move the roll motor lock switch to the unlock end.
- b. Release hands to observe the direction in which the roll axis swings.
- c. Loosen the roll axis knob 1 to slide the roll arm 2 until the roll arm 2 stays still.
- d. Tighten the knob 1.

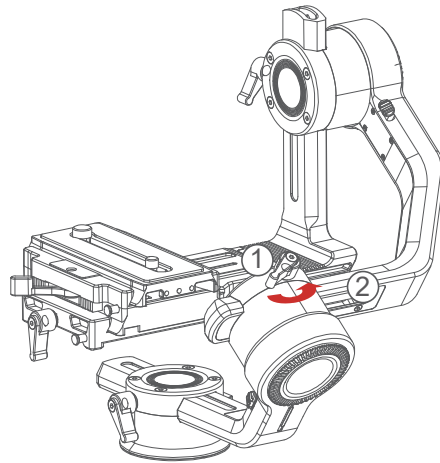

Balancing the Pan Axis

- a. Grab the Air 2S horizontally, make the pan arm level. Release hands to check the direction in which the camera swings.
- b. Loosen the knob 1 on the pan motor. Move the pan arm 2 leftwards or rightwards until it keeps level.
- c. Tighten the knob 1.

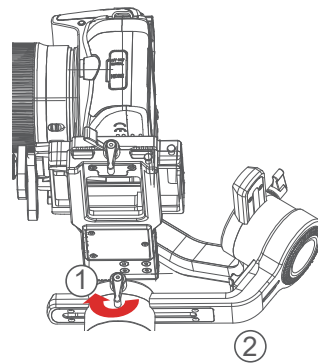

⚠ Note: If the balance of the pan axis is not adjusted properly, the pan axis may become hot, and the inception mode cannot be used properly.

Buttons and OLED Display

Button Functions:

Button	Operation	Function	Customizable Function						Meun
Trigger	1 X	—	N/A	Focus	Shutter	—	—	—	The same
	2 X	Re-Center	N/A	Re-Center	Selfie	—	—	—	The same
	3 X	Selfie	N/A	Re-Center	Selfie	—	—	—	The same
	Press	Pan-Tilt Follow	N/A	Pan-Tilt Follow	All lock	Sport gear mode	FPV mode	—	The same
Power Button	1 X	Video recording	—	—	—	—	—	—	The same
	2 X	Take photo	—	—	—	—	—	—	The same
	3s	ON/OFF	—	—	—	—	—	—	The same
Wheel	Turn	Pan axis	Focus motor1	Focus motor 2	E-focus	Tilt axis	Roll axis	—	The same
M Button	1 X	Switch wheel modes	—	—	—	—	—	—	The same
Fn Button	1 X	Sport gear mode	—	—	—	—	—	—	The same
	2 X	Inception mode	—	—	—	—	—	—	The same
	3 X	FPV mode	—	—	—	—	—	—	The same
	3s	Auto tune	—	—	—	—	—	—	The same
Joystick	Push Up-Down	Move the tilt axis	Tilt axis	Roll axis	Pan axis	—	—	—	The same
	Push Left-Right	Move the pan axis	Tilt axis	Roll axis	Pan axis	—	—	—	The same
Top	1 X	TV	—	—	—	—	—	—	Option-up
	2 X	Tilt follow	—	—	—	—	—	—	—
Down	1 X	AV	—	—	—	—	—	—	Option-down
	2 X	Pan follow	—	—	—	—	—	—	—
Left	1 X	ISO	—	—	—	—	—	—	Return
	2 X	Roll folow	—	—	—	—	—	—	—
Right	1 X	Enter/Exit preview	—	—	—	—	—	—	Confirm/Next menu
Menu Button	1 X	Enter the menu	—	—	—	—	—	—	The same
	3 X	Language	—	—	—	—	—	—	The same
	3s	Sleep/wake up	—	—	—	—	—	—	The same
Dial	Turn	Follow speed	—	—	—	—	—	—	Adjust relevant
Combo	Menu+Power	Upgrade mode	—	—	—	—	—	—	—

Main interface

A: Smart wheel working modes

- Controlling external follow focus motor 1
- Controlling external follow focus motor 2
- Electronic follow focus
- Controlling the tilt axis
- Controlling the roll axis
- Controlling the pan axis

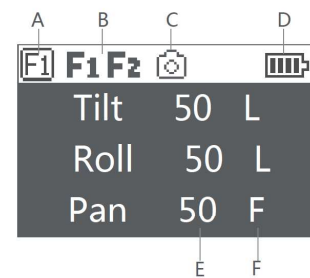

B: Focus motor connection status. Icon will be displayed after

connection, otherwise it won't be displayed. Up to two focus motors can be connected at the same time.

C: Camera connection status. Icon will be displayed after USB connection, otherwise it won't be displayed.

D: Battery quantity. Each grid represents 25% battery level. When the battery is empty, please charge the battery in time.

E: Follow speed value: 0-100. Turn the dial to adjust the value

F: Follow status

L: Lock. The axis locks and doesn't follow.

F: Follow. The axis follows.

Q: Sport Gear Mode

Menu Description

L1	L2	L3	L4	L5	Value	Function	
camera	Choice	Shutter Cable			*	set the connection type to universal shutter cable	
		MCSC-Multi			*	set the connection type to Sony-Multi port	
		MCSC-Multi/C			*	set the connection type to Sony-Multi port and power supply	
		MCSC-Remote			*	set the connection type to Panasonic-Remote port	
		M3C-USB			*	set the connection type to USB port	
	Parameters	ISO			32--106400	Set the camera ISO	
	TV			30--1/8000	Set the camera shutter		
	AV			F1--F22	Set the camera aperture		
gimbal	motor	switch			? /ok	turn on/off motor	
		power	autotune			? /ok	tuning/tuned
			level	ultra light		*	set motor level to the minimum
				light		*	set motor level to light
				medium		*	set motor level to medium
				heavy		*	set motor level to heavy
		ultra heavy			*	set motor level to ultra heavy	
		custom	tilt		0-100	set tilt motor power	
			roll		0-100	set roll motor power	
			pan		0-100	set pan motor power	
		filter	tilt		0-100	set tilt motor filter	
			roll		0-100	set roll motor filter	
			pan		0-100	set pan motor filter	
		follow	switch	tilt		on/off	enter/exit tilt follow mode
				roll		on/off	enter/exit roll follow mode
	pan				on/off	enter/exit pan follow mode	
	speed		tilt		0-100	set the following speed of tilt motor	
			roll		0-100	set the following speed of roll motor	
			pan		0-100	set the following speed of pan motor	
	deadband		tilt		0-100	set the following initiation angle of tilt motor	
			roll		0-100	set the following initiation angle of roll motor	
			pan		0-100	set the following initiation angle of pan motor	
	operation		joystick	function	left-right	tilt/rol/pan	move the joystick left/right to control the tilt/roll/pan rotation
					up-down	tilt/rol/pan	move the joystick up/down to control the tilt/roll/pan rotation
				sensitivity	left-right	0-100	set sensitivity level of left-right movement
		up-down			0-100	set sensitivity level of up-down movement	
		habits		left-right	+/-	set the control habit of joystick left/right movement	
				up-down	+/-	set the control habit of joystick up/down movement	
		wheel	function	focus-1	*	control the external focus motor 1	
				focus-2	*	control the external focus motor 2	
				focus-e	*	control the electronic focus	
				tilt	*	control the pan axis	
				roll	*	control the tilt axis	
				pan	*	control the roll axis	
			sensitivity	0-100	wheel sensitivity		
		habits	+/-	set the control direction of wheel rotation			
		trigger	press	none	*	none	
				follow	*	enter pan-tilt follow mode	
				lock	*	enter all lock mode	
				quick	*	enter sport gear mode	
				FPV	*	enter FPV mode	
			click	none	*	none	
				shutter	*	take photo	
				focus	*	auto focus	
			double-click	none	*	none	
				re-center	*	re-center	
			triple-click	selfie	*	rotate the gimbal 180° for selfie	
none				*	none		
re-center				*	re-center		
	selfie		*	rotate the gimbal 180° for selfie			

L1	L2	L3	L4	L5	Value	Function	
gimbal	operation	dial	habits		+/-	rotate the dial clockwise to increase/decrease value	
advanced	autotune				? /ok	auto tune	
	balance check					check the balance state of camera	
	iFocus	F1		switch		? /ok/err	turn on/off the focus motor 1
				set A		? /ok/err	set the point A of focus motor 1
				set B		? /ok/err	set the point B of focus motor 1
				Clear AB		? /ok/err	Clear the calibration information
				Guidance		>	Enter the guidance mode
		F2		switch		? /ok/err	turn on/off the focus motor 1
				set A		? /ok/err	set the point A of focus motor 1
				set B		? /ok/err	set the point B of focus motor 1
				Clear AB		? /ok/err	Clear the calibration information
				Guidance		>	Enter the guidance mode
		Dolly Zoom				>	Enter the dolly zoom mode
	inception	speed				0--100	set the rotation speed of inception mode
	motion control	switch		tilt		? /on/off	turn on/off the motion control of tilt axis
				roll		? /on/off	turn on/off the motion control of roll axis
				pan		? /on/off	turn on/off the motion control of pan axis
		speed				0-100	set the rotation speed of motion control
	tracking	speed				0-100	set the max speed of tracking
	manual positioning		tilt			on/off	turn on/off the manual positioning of tilt axis
		roll			on/off	turn on/off the manual positioning of roll axis	
		pan			on/off	turn on/off the manual positioning of pan axis	
calibration	gyro				? /ok	calibrating/calibrated the gyroscope	
	acc				? /ok	calibrating/calibrated the accelerometer	
	angle offset		tilt		0-100	set the offset value of tilt axis	
			roll		0-100	set the offset value of roll axis	
		pan		0-100	set the offset value of pan axis		
general	language	English			*	switch display language to English	
		中文			*	switch display language to Chinese	
	config	config1		save		? /ok	save to configuration 1
				load		? /ok	load configuration 1
		config2		save		? /ok	save to configuration 2
				load		? /ok	load configuration 2
		config3		save		? /ok	save to configuration 3
				load		? /ok	load configuration 3
		reset				? /ok	restore default parameter settings
	about						device name and firmware information

Menu type introduction:

If there is a ">" mark at the right side of the selected item, press the dial right button for the next menu.

If the selected item has a "[]" and contains a number, rotate the dial to adjust its value.

If the selected item has a "()" and contains an option, press the right button to switch among options.

! Notes:

1. If there is a "*" at the right side of one item, the current list is the final option, press the dial right button to launch it.
2. If the selected item and other items in the menu list don't have any marks, press the dial right button to launch the option once. ">" is displayed during the process. "OK" is displayed after the process is completed, and "ERR" is displayed if the option fails.

- ⚠ 3. Filtering parameters: When the motor vibrates with high frequency, the value should be turned down. When the motor vibrates with low-frequency, the value should be increased.
4. The manual positioning function has lower priority than the following function. When using manual positioning function normally, following function of the axis should be turned off.

Features Description

Camera Control

The Air 2S can support camera video recording, photo taking and electronic focus control. Please refer to the compatibility list for more details

(* Please set the lens to "MF" mode)

Brand	Model	Select	Cable	Shutter	Record	ISO	TV	AV	Auto Focus	Focus Control	Power Supply		
CANON	EOS R	M3C-USB	M3C-Micro+ Micro to Type-C Adapter (optional)	√	√	√	√	√	√	√	—		
	EOS RP			√	√	√	√	√	√	√	—		
	EOS 6D Mark II		M3C-Mini	*	√	√	√	√	√	√	√	—	
	EOS 6D			*	√	√	√	√	√	√	√	—	
	EOS 60D			*	√	√	√	√	√	√	√	—	
	EOS 70D			*	√	√	√	√	√	√	√	—	
	EOS 77D			*	√	√	√	√	√	√	√	—	
	EOS 80D			*	√	√	√	√	√	√	√	—	
	EOS 5D2			*	√	√	√	√	√	√	√	—	
	EOS 5D3			*	√	√	√	√	√	√	√	—	
	EOS 800D			*	√	—	√	√	√	√	√	—	
	EOS 5D Mark IV			*	√	√	√	√	√	√	√	—	
	EOS 200D II		M3C-Micro	*	√	√	√	√	√	√	√	—	
	EOS M50			*	√	√	√	√	√	√	√	—	
EOS M5	MCSC-C1	C1 Shutter Cable (optional)	√	—	—	—	—	—	—	—			
SONY	Alpha 7S	M3C-USB	M3C-Micro	—	√	√	✗	√	√	—	√		
	Alpha 7R			—	√	√	√	√	√	—	√		
	Alpha 6300			—	√	√	√	√	√	—	√		
	Alpha 6400			—	√	√	√	√	√	√	√		
	Alpha 6500			—	√	√	√	√	√	—	√		
	Alpha 7S II			—	√	√	√	√	√	—	√		
	Alpha 7R II			—	√	√	√	√	√	—	√		
	Alpha 7 II			—	√	√	√	√	√	—	√		
	Alpha 7 III			—	√	√	√	√	√	√	√		
	Alpha 7R III			—	√	√	√	√	√	√	√		
	DSC-RX100M3			—	√	√	√	√	√	—	√		
	DSC-RX100M4			—	√	√	√	√	√	—	√		
	DSC-RX100M5			—	√	√	√	√	√	—	√		
	Alpha 7S			MCSC-Multi	MCSC-Multi	√	√	—	—	—	√	—	√
	Alpha 7R	√	√			—	—	—	√	—	√		
	Alpha 6300	MCSC-Multi/C	MCSC-Multi/C	√	√	—	—	—	√	—	√		
	Alpha 6400			√	√	—	—	—	√	—	√		
	Alpha 6500			√	√	—	—	—	√	—	√		
	Alpha 7S II			√	√	—	—	—	√	—	√		
	Alpha 7R II			√	√	—	—	—	√	—	√		
Alpha 7 II	√			√	—	—	—	√	—	√			
Alpha 7 III	√			√	—	—	—	√	—	√			
Alpha 7R III	√			√	—	—	—	√	—	√			
DSC-RX100M3	√			√	—	—	—	√	—	√			
DSC-RX100M4	√			√	—	—	—	√	—	√			
DSC-RX100M5	√			√	—	—	—	√	—	√			
Panasonic	DMC-G7KGK			MCSC-Remote	MCSC-Remote	√	√	—	—	—	√	—	—
	DMC-G85GK					√	√	—	—	—	√	—	—
	DMC-GH3					√	√	—	—	—	√	—	—
	Lumix GH4	√	√			—	—	—	√	—	—		
	DC-S1GK-K	M3C-USB	M3C-Micro+ Micro to Type-C Adapter (optional)	√	√	√	√	√	√	√	√		
	Lumix GH5			√	√	√	√	√	√	√	—		
DC- GH5SGK-K			√	√	√	√	√	√	√	—			
Nikon	Z6	M3C-USB	M3C-Micro+ Micro to Type-C Adapter (optional)	√	√	√	√	√	√	√	—		
	Z7		√	√	√	√	√	√	√	—			
	D850		M3C-Micro	√	√	√	√	√	√	√	—		
FUJIFILM	X-T2	MCSC-C1	C1 Shutter Cable (optional)	√	√	—	—	—	√	—	—		
	X-T3			√	√	—	—	—	√	—	—		
	X-T20			√	√	—	—	—	√	—	—		
	X-T30			√	√	—	—	—	√	—	—		
				√	√	—	—	—	√	—	—		

Note: please refer to the official website for the latest camera control list.

Operation Steps:

- Long press the center button to enter the menu, refer to the compatibility list to select the correct camera type.

b. Refer to the list to choose and connect the camera control cable. Connect the Mini-USB end of the control cable to the control port of Air 2S. Connect the other end to the corresponding control port of the camera.

c. You can achieve recording by clicking the menu button one time and taking photos by clicking menu button twice after selecting the camera type and connecting the camera control cable.

! Note:

1. Cameras equipped with Micro USB 3.0 interface, such as the Nikon D850, can be normally controlled by half plugging the M3C-Micro cable.

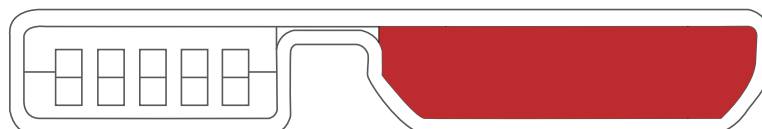

2. After plugging the camera control cable, please operate the camera according to the prompts on the camera screen, otherwise the camera control function may not work properly.

- Start/Stop: Press power button once
- Shoot photos: Press power button twice
- Adjust shutter: Press the up button of the dial (TV)
- Adjust aperture: Press the down button of the dial (AV)
- Adjust ISO: Press the left button of the dial (ISO)

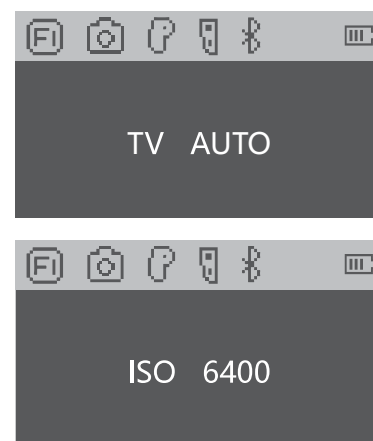

When adjusting camera parameters, press the corresponding button and the screen will display the value, then turn the dial to adjust the value. After the adjustment is completed, press the corresponding button again to turn off the adjustment of camera parameters.

- Turn on/ off preview: press the right button of the dial to turn on or off live preview.

! Note:

1. Only when start camera settings can turn the dial adjust parameters. Under the default state, turn the dial would adjust the follow speed.

2. Some cameras with sensor, like Sony A7S2 will shut down the screen and switch to viewfinder for preview, if there is obstruction before the viewfinder. Set preview setting to screen

Motor Output

The payload of Air 2S is from 300g to 4200g. Different payload requires different motor power to achieve the best stability. There are three methods for adjusting the output of the motor:

Auto-tuning operation method:

- a. Install the camera and adjust the balance
- b. Unlock all motor lock
- c. Turn on the stabilizer, long press the center button to enter the menu, select 'Gimbal' > 'Motor' > 'Power' > 'Auto-tune'
- d. During the auto-tuning, the stabilizer will vibrate automatically to match the most suitable output value. Wait for about 5 seconds, the stabilizer stops shaking, and the auto-tuning completes.

camera >	motor >	switch >	aututune >
gimbal >	follow >	power >	level >
advanced >	operation >	filter >	custom >
general >			

Set the output gear:

Factory default presets 5 groups of motor output values, which are suitable for cameras of different weight levels.

Customize the output value of each motor:

The users can customize the output value of each motor to reach more precise control of the motor output. The adjustment range is 0 to 100.

 Note:

1. Under the camera lens combination of the limit, the auto-tuning function may not accurately calculate the appropriate output value. Please manually adjust the motor output according to the situation.
2. If the motor output is too low, the video is not stable enough; if the motor output is too high, it will cause high-frequency vibration of the stabilizer.
3. When the motor output is at the critical value, the stabilizer will not vibrate in the upright state, but it will vibrate in the forward or inverted state. Please reduce the motor output moderately.

FPV, Sport Gear Mode

When the follow function is enabled, the camera will follow the movement of the gimbal. Users can enable the follow mode of each axis through dial buttons and turn the dial to adjust the following speed, which can be also enabled in the menu.

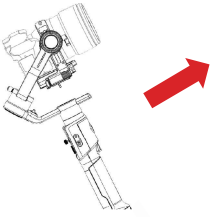
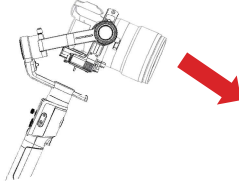
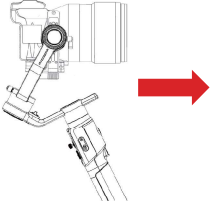
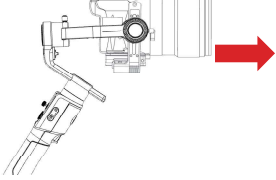
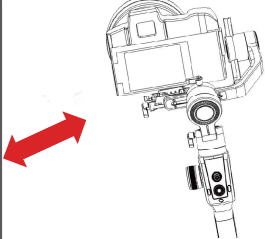
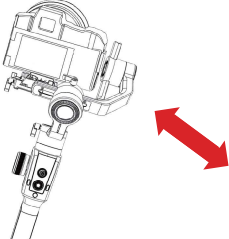
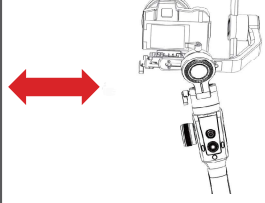
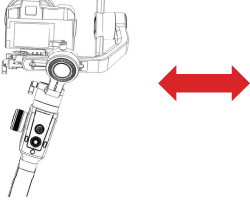
Follow Mode Switch	Example 1	Example 2
Enter the tilt follow		
Exit the tilt follow		
Enter the roll follow		
Exit the roll follow		

⚠ Note:

1. The Air 2S is in pan follow mode by default.
2. In addition to controlling the follow mode by the switches of each axis independently, follow modes can be also enabled by the trigger, please refer to 'Button Functions' for more details.
3. The angle of the roll follow is 45°. For a larger following angle, please triple click the left button to enter the FPV mode to achieve 360° follow of three axes.
4. If faster following speed is required, please click the right button to enter the sport gear mode. (Currently only supports the pan axis)

Manual Positioning

Manual positioning is used to quickly adjust the direction of the camera. When the function of manual positioning is enabled, the camera orientation can be adjusted by hand which will not automatically return to the initial position. The adjustment speed is faster than using the joystick or the following mode. The manual positioning of the tilt axis is enabled by default on the Air 2S. Manual positioning of the roll and pan axes can be enabled in the menu.

camera	>	balance chk		tilt	[off]	tilt	[on]
gimbal	>	iFocus	>	roll	[off]	roll	[off]
advanced	>	inception	>	pan	[on]	pan	[on]
general	>	manual pos	>				

! Note: The follow function has higher priority than manual positioning. When the follow function of any axis is on, the manual positioning function cannot be used. Only after the follow function is off, the manual positioning can be used normally.

Button Customization

Button Customization is used to specify the function, sensitivity and operation direction of each button according to the user's habits.

For Example:

By default, moving the joystick up and down controls the tilt axis rotation. It can be changed to control the roll or pan axis rotation by customizing;

By default, moving the joystick left and right controls the pan axis rotation. It can be changed to control the tilt or roll axis rotation by customizing.

camera	>	motor	>	joystick	>	function	>	left-right	[pan]
gimbal	>	follow	>	wheel	>	sensitivity	>	up-down	[tilt]
advanced	>	operation	>	trigger	>	habits	>		
general	>			dial	>				

The higher the sensitivity of the button, the more sensitive and faster the control is. If you change the 'custom' to -, the direction of operation will be opposite. For more button customization, please refer to 'Menu Description'.

Inception Mode

The Inception Mode is used to control the camera to rotate in the roll direction for shooting upside down and rotating footages. In the main interface, triple click the right button to enter the Inception Mode. After entering the Inception Mode, the camera lens is vertically up and each axis automatically follows.

Button Definition for Inception Mode:

- Turn the joystick left or right: the gimbal turns to left or right, when

release or turn to a specified angle, the gimbal stops.

- Turn the dial: adjust the rotation speed
- Press the left button on the dial once: the gimbal rotates to the left automatically. If the gimbal is rotating, press once to stop.
- Press right button on the dial once: the gimbal rotates to the right automatically. If the gimbal is rotating, press once to stop.
- Press up/down button on the dial: select rotation angle
- Normal: gimbal rotates and does not stop automatically
- 180: the gimbal rotates 180° and stops automatically.
- 360: the gimbal rotates 360° and stops automatically.

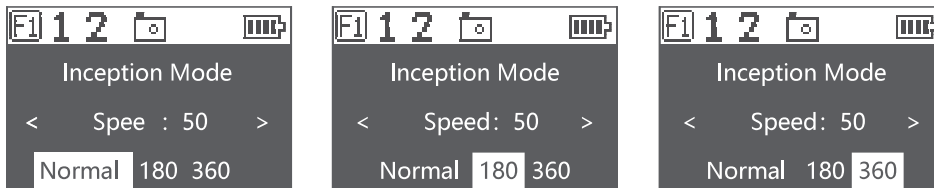

Triple click the right button again to exit the Inception Mode.

Balance Check

The gimbal can check the balance status of tilt and roll axis automatically and instruct users to make the correct adjustment.

- Attach a tripod to the gimbal, turn on the gimbal and place it on a horizontal tabletop.
- Enter the menu, select advanced>balance chk, the gimbal begins to check the balance adjustment.



- When balance check is completed, the balance status of each axis will be displayed on the screen, direction guide will be also displayed if the adjustment is needed.
- ' C ' means quick release plate, ' T ' means tilt axis, ' R ' means roll axis, then start the adjustment according to the screen prompts.
- When adjustment is completed, press the right button and check it again until the gimbal is well balanced.

! Note:

- Balance check can be only used with the tilt and roll axis, the pan axis balance cannot be checked, please check the pan axis manually. Be sure that the motor lock has been released when using balance check.
- Motors turned off after balance check, please long press 'menu' button to start the gimbal.

Sensor Calibration

● Gyroscope Calibration

Turn on the gimbal and leave it quietly for 5 minutes, the gyroscope calibration is required when the gimbal drifts obviously.

The steps are as follows:

- Turn on the gimbal (long press the power button)
- Turn off the motors (double press the power button/enter the menu, select gimbal>motor>switch, set 'off')
- Place air 2S on a horizontal table so that the platform is completely horizontal, keep the stabilizer stationary, and do not wiggle or tilt the stabilizer.
- Enter the menu, select advanced>calibrate>Gyro cali and press the dial right button, wait about 5 seconds, when the '?' changes to 'OK', the calibration is completed.

camera >	iFocus >	gyro	gyro ok
gimbal >	inception >	acc	acc
advanced >	manual pos >	angle offset >	angle offset >
general >	calibration >		

● Accelerometer Calibration

Turn on the gimbal and there is no obvious drift, the accelerometer calibration is required when the camera doesn't keep level. The steps are as follows:

- Turn on the gimbal (long press the power button)
- Turn off the motors (double press the power button/enter the menu, select gimbal>motor>switch, set 'off')
- Leave the L-shaped quick release plate on the horizontal table. Avoid the bottom screw and keep the Air 2S at static position. Do not shake the it or tilt it. (or mount the camera to refer to its level)
- Enter the menu, select advanced>calibrate>Acc cali, and press the dial right button to enter calibration. Wait about 5 seconds, when the '?' changes to 'OK', the calibration is completed.

camera >	iFocus >	gyro	gyro
gimbal >	inception >	acc	acc ok
advanced >	manual pos >	angle offset >	angle offset >
general >	calibration >		

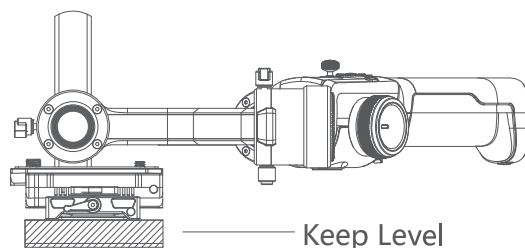

Note:

- Please keep the gimbal stationary during the calibration, any shaking will cause the calibration to deviate.
- Any drastic shaking might cause 'err' shown on the screen, please calibrate again.
- Do not arbitrarily perform calibration operations while it is not necessary.

● Offset

In case of emergency shooting, the camera cannot be leveled and there is no time for sensor calibration, the camera can be adjusted to a horizontal state by offset.

- Turn on the gimbal and the camera level, check the offset of the tilt and yaw axis.
- Enter the menu, select advanced>calibrate>offset, select an axis that is not horizontal, and then turn the dial to adjust the fine adjustment value of the axis until the camera completely keeps level.

camera >	iFocus >	gyro	tilt [0]	tilt [1]
gimbal >	inception >	acc	roll [0]	roll [0]
advanced >	manual pos >	angle offset >	pan [0]	pan [0]
general >	calibration >			

! Notes:

- The offset can only adjust the angle of each axis within the range of about $\pm 5^\circ$, if there is too much offset, the camera cannot be completely leveled.
- Offset is only a temporary solution, after shooting, accelerometer calibration is still needed.
- The parameters of the offset will not be saved and will become invalid after restart.

Language Switch

The Air 2S supports both Chinese and English. After turning on the gimbal, users can switch language in the menu.

camera >	language >	English	English *
gimbal >	config >	中文 *	中文
advanced >	about		
general >			

User Configuration Management

The Air 2S can save 3 groups of user data like camera type, motor output, button operations and other parameters, so users can retrieve relevant parameters previously used and avoid trouble of setting parameters each time when changing the camera.

camera >	language >	config1 >	save
gimbal >	config >	config2 >	load
advanced >	about	config3 >	
general >		reset	

When configuration data is confusing, users can select “restore configuration” to clear all previous configuration data.

Management

Smartphone and PC Connection

The Air 2S is equipped with BLUETOOTH 5.0 and can be connected with smartphones. Users can set parameters, shot time-lapse video, upgrade firmware and make other operations via the MOZA Master App. With a Type-C USB interface, the Air 2S is able to be connected to a computer. Users can set parameter, upgrade firmware and make other operations via the MOZA Master software.

Download Link: <https://www.gudsen.com>

⚠ Note:

1. The MOZA Master supports iOS, Android, Windows and MacOS
2. Before using the MOZA Master on computer, please install the driver first, otherwise the computer cannot recognize the Air 2S
3. Smart phones cannot directly pair with the Air 2S via Bluetooth, MOZA Master App must be used to connect your phone with the Air 2S

Install the Phone Holder

Install the phone on top of the camera. Operate object tracking through App.

- a. Fix the phone holder to the hot shoe connector on the top of the camera
- b. Place the phone horizontally in the phone holder
- c. Open the App. Enter the object tracking feature. Adjust the phone angle. Make the phone framing as consistent as possible with the camera framing.

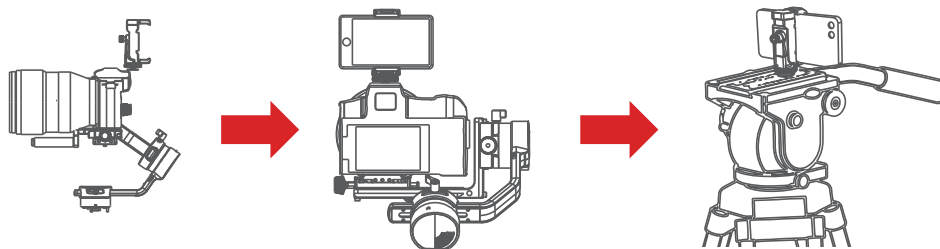

In addition to being mounted on the top of the camera for object tracking, the phone holder can also be used to fasten the phone to tripod head for mimic motion control.

Firmware Upgrade

Upgrade via computer:

- a. Turn off the gimbal.
- b. Hold the Menu button and do not release, then press the power button with the other hand until the prompt 'Boot Mode' appears on the screen.
- c. Connect the gimbal to the computer with a USB Type-C cable.
- d. The software will automatically identify the device and load the firmware. Press the 'Upgrade' button and wait for about 30s.

e.Restart the gimbal after the upgrade.

Upgrade via App:

a.Turn off the gimbal.

b. Hold the Menu button and do not release, then press the power button with your another hand until the prompt “Boot Mode” appears on the screen.

c.Start App, press Bluetooth to search for Air 2S device and connect.

d. The App will automatically enter the firmware upgrade interface, please wait for the firmware download to complete, press the 'upgrade' button and wait for about 5 minutes.

e. During the upgrade process, 'upgrading' will be displayed on the gimbal screen, and ' upgrade success' will be displayed on the screen after the upgrade is completed, and then Air 2S can be restarted.

 Note: Your gimbal will automatically update to the latest firmware after firmware update process.

Specifications

Air 2S	
Payload Range	0.3kg~4.2kg
Dimension	478*206*184mm(W*D*H)
Tilt Camera Tray Dimension	110 mm
Roll Camera Tray Dimension	100 mm
Pan Mechanical Endpoint Range	360°
Roll Mechanical Endpoint Range	-100°~+200°
Tilt Mechanical Endpoint Range	-190°~+110°
Battery Type	Li-ion 18650MH1-4S1P 41NR19/66
Battery Capacity	3200 mAh
Working Votage	14.8V
Static Current	150mA
Communication	BT5.0 BLE
	USB
Camera Control Port	Mini USB 5V 1A
Dummy Battery Port	DC2.0mm 7.8V 1A
Accessory Power Supply Port	DC5.5mm 16.8V
TYPE-C Port	Quick-acting charging is available
Temperature	0--50℃

FCC regulatory conformance:

This device complies with Part 15 of the FCC Rules. Operation is subject to the following two conditions:

- (1) This device may not cause harmful interference.
- (2) This device must accept any interference received, including interference that may cause undesired operation.

NOTE: This equipment has been tested and found to comply with the limits for a Class B digital device, pursuant to part 15 of the FCC Rules. These limits are designed to provide reasonable protection against harmful interference in a residential installation.

This equipment generates uses and can radiate radio frequency energy and, if not installed and used in accordance with the instructions, may cause harmful interference to radio communications. However, there is no guarantee that interference will not occur in a particular installation. If this equipment does cause harmful interference to radio or television reception, which can be determined by turning the equipment off and on, the user is encouraged to try to correct the interference by one or more of the following measures:

- Reorient or relocate the receiving antenna.
- Increase the separation between the equipment and receiver.
- Connect the equipment into an outlet on a circuit different from that to which the receiver is connected.
- Consult the dealer or an experienced radio/TV technician for help

NOTE: The manufacturer is not responsible for any radio or TV interference caused by unauthorized modifications to this equipment. Such modifications could void the user's authority to operate the equipment.

This equipment complies with FCC radiation exposure limits set forth for an uncontrolled environment.



Follow us
魔爪社交媒体



MOZA WeChat
魔爪微信公众号

GUDSEN
INVENTED FOR VIDEO
Shenzhen Gudsen Technology Co., Ltd
Web: www.gudsen.com