



FCC TEST REPORT
FCC ID: 2AMIL-FLOWERBUD

On Behalf of

Fonerics Electronics Co., Ltd
VOCOLinc Smart Aroma Diffuser
Model No.: Flowerbud

Prepared for : Fonerics Electronics Co., Ltd
Address : 201, Floor 2, No.2 Building, Foxda Industrial Zone, Northern Lanzhu
Road, Pingshan, Shenzhen, Guangdong, 518038 China

Prepared By : Shenzhen Alpha Product Testing Co., Ltd.
Address : Building i, No.2, Lixin Road, Fuyong Street, Bao'an District, 518103,
Shenzhen, Guangdong, China

Report Number : T1881504 06
Date of Receipt : September 20, 2018
Date of Test : September 20-October 19, 2018
Date of Report : October 19, 2018
Version Number : REV0

TABLE OF CONTENTS

Description	Page
1. Summary of Standards And Results-----	6
1.1. Description of Standards and Results -----	6
2. General Information -----	7
2.1. Description of Device (EUT)-----	7
2.2. Accessories of Device (EUT) -----	8
2.3. Tested Supporting System Details -----	8
2.4. Block Diagram of connection between EUT and simulators -----	8
2.5. Test Mode Description -----	9
2.6. Test Conditions -----	9
2.7. Test Facility -----	10
2.8. Measurement Uncertainty -----	10
2.9. Test Equipment List -----	11
3. Spurious Emission -----	12
3.1. Test Limits -----	12
3.2. Test Procedure -----	12
3.3. Test Setup -----	13
3.4. Test Results -----	14
4. Power line Conducted Emission -----	21
4.1. Test Limits -----	21
4.2. Test Procedure -----	21
4.3. Test Setup -----	21
4.4. Test Results -----	22
5. Conducted Maximum Output Power -----	24
5.1. Test limits -----	24
5.2. Test Procedure -----	24
5.3. Test Setup -----	24
5.4. Test Results -----	24
6. Peak Power Spectral Density-----	26
6.1. Test limits -----	26
6.2. Test Procedure -----	26
6.3. Test Setup -----	26
6.4. Test Results -----	27
7. Bandwidth-----	34
7.1. Test limits -----	34
7.2. Test Procedure -----	34
7.3. Test Setup -----	34
7.4. Test Results -----	34
8. Band Edge Check-----	42
8.1. Test limits -----	42
8.2. Test Procedure -----	42
8.3. Test Setup -----	42
8.4. Test Results -----	42

- 9. Antenna Requirement ----- 55**
 - 9.1. Standard Requirement----- 55
 - 9.2. Antenna Connected Construction----- 55
 - 9.3. Results ----- 55
- 10. Test setup photo ----- 56**
 - 10.1. Photos of Radiated emission ----- 56
- 11. photo OF EUT----- 57**

TEST REPORT DECLARATION

Applicant : Fonerics Electronics Co., Ltd
 Address : 201, Floor 2, No.2 Building, Foxda Industrial Zone, Northern Lanzhu Road, Pingshan, Shenzhen, Guangdong, 518038 China
 Manufacturer : Fonerics Electronics Co., Ltd
 Address : 201, Floor 2, No.2 Building, Foxda Industrial Zone, Northern Lanzhu Road, Pingshan, Shenzhen, Guangdong, 518038 China
 EUT Description : VOCOLinc Smart Aroma Diffuser
 (A) Model No. : Flowerbud
 (B) Trademark : N/A

Measurement Standard Used:

FCC Rules and Regulations Part 15 Subpart C Section 15.247: 2016, ANSI C63.10-2013

The device described above is tested by Shenzhen Alpha Product Testing Co., Ltd. to determine the maximum emission levels emanating from the device. The maximum emission levels are compared to the FCC Part 15 Subpart C limits both conducted and radiated emissions. The test results are contained in this test report and Shenzhen Alpha Product Testing Co., Ltd. is assumed of full responsibility for the accuracy and completeness of these tests.

After the test, our opinion is that EUT compliance with the requirement of the above standards.

This report applies to above tested sample only. This report shall not be reproduced in parts without written approval of Shenzhen Alpha Product Testing Co., Ltd.

Tested by (name + signature).....: Reak Yang
 Project Engineer 

Approved by (name + signature).....: Simple Guan
 Project Manager 

Date of issue.....: October 19, 2018

Revision History

Revision	Issue Date	Revisions	Revised By
00	October 09, 2018	Initial released Issue	Simple Guan

1. SUMMARY OF STANDARDS AND RESULTS

1.1. Description of Standards and Results

The EUT have been tested according to the applicable standards as referenced below:

Test Item	Test Requirement	Standards Paragraph	Result
Conducted Emission	FCC PART 15:2016	15.207	P
6dB Bandwidth	FCC PART 15:2016	15.247 (a)(2)	P
Output Power	FCC PART 15:2016	15.247 (b)(3)	P
Radiated Spurious Emission	FCC PART 15:2016	15.247 (c)	P
Conducted Spurious & Band Edge Emission	FCC PART 15:2016	15.247 (d)	P
Power Spectral Density	FCC PART 15:2016	15.247 (e)	P
Radiated Band Edge Emission	FCC PART 15:2016	15.205	P
Antenna Requirement	FCC PART 15:2016	15.203	P
Note:	1. P is an abbreviation for Pass. 2. F is an abbreviation for Fail. 3. N/A is an abbreviation for Not Applicable.		

2. GENERAL INFORMATION

2.1. Description of Device (EUT)

Description	: VOCOLinc Smart Aroma Diffuser
Model Number	: Flowerbud
Diff	: N/A
Trademark	: N/A
Test Voltage	: DC 24V from adapter
Operation frequency	: IEEE 802.11b/g: 2412MHz-2462MHz IEEE 802.11n HT20: 2412MHz-2462MHz IEEE 802.11n HT40: 2422MHz-2452MHz IEEE 802.11b/g: 11Channels
Channel No.	: IEEE 802.11n HT20: 11 Channels IEEE 802.11n HT40: 7Channels IEEE 802.11b: DSSS(CCK,DQPSK,DBPSK)
Modulation type	: IEEE 802.11g: OFDM(64QAM, 16QAM, QPSK, BPSK) IEEE 802.11n :OFDM(64QAM, 16QAM, QPSK, BPSK)
Antenna Type	: Internal Antenna, Maximum Gain is 3.79dBi
Software version	: V 3.98.52
Hardware version	: V0.3

2.2. Accessories of Device (EUT)

Accessories1 : Adapter
Manufacturer : VOCOLinc
Model : SK02T-2400060Z
Power supply : AC 100-240V, 50/60Hz
DC 24V,0.6A

2.3. Tested Supporting System Details

No.	Description	Manufacturer	Model	Serial Number	Certification or DOC
1	N/A	N/A	N/A	N/A	N/A

2.4. Block Diagram of connection between EUT and simulators

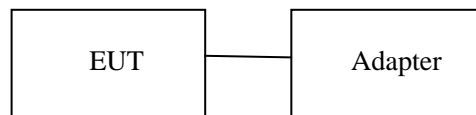

2.5. Test Mode Description

Duty cycle :100% Keeping TX					
Mode	Setting output power (Max)	data rate (Mbps)(see Note)	Channel	Frequency (MHz)	
IEEE 802.11b	0.5dBm	1	Low :CH1	2412	
		1	Middle: CH6	2437	
		1	High: CH11	2462	
IEEE 802.11g	0.5dBm	6	Low :CH1	2412	
		6	Middle: CH6	2437	
		6	High: CH11	2462	
IEEE 802.11 n/HT20 with 2.4G	0.5 dBm	6.5	Low :CH1	2412	
		6.5	Middle: CH6	2437	
		6.5	High: CH11	2462	
IEEE 802.11 n/HT40 with 2.4G	0.5 dBm	13.5	Low :CH3	2422	
		13.5	Middle:CH6	2437	
		13.5	High:CH9	2452	
Note: According exploratory test, EUT will have maximum output power in those data rate. so those data rate were used for all test.					
Channel list:					
For IEEE 802.11b/g and IEEE 802.11n/HT20 with 2.4G					
Channel	Frequency (MHz)	Channel	Frequency (MHz)	Channel	Frequency (MHz)
CH1	2412	CH5	2432	CH9	2452
CH2	2417	CH6	2437	CH10	2457
CH3	2422	CH7	2442	CH11	2462
CH4	2427	CH8	2447		
For IEEE 802.11n/HT40 with 2.4G					
Channel	Frequency (MHz)	Channel	Frequency (MHz)	Channel	Frequency (MHz)
CH1	/	CH5	2432	CH9	2452
CH2	/	CH6	2437	/	/
CH3	2422	CH7	2442	/	/
CH4	2427	CH8	2447	/	/

2.6. Test Conditions

Items	Required	Actual
Temperature range:	15-35°C	27°C
Humidity range:	25-75%	56%
Pressure range:	86-106kPa	980kPa

2.7. Test Facility

Shenzhen Alpha Product Testing Co., Ltd
 Building i, No.2, Lixin Road, Fuyong Street, Bao'an District, 518103,
 Shenzhen, Guangdong, China

June 21, 2018 File on Federal Communication Commission
 Registration Number: 293961

July 25, 2017 Certificated by IC
 Registration Number: 12135A

2.8. Measurement Uncertainty

(95% confidence levels, k=2)

Item	Uncertainty
Uncertainty for Power point Conducted Emissions Test	2.42dB
Uncertainty for Radiation Emission test in 3m chamber (below 30MHz)	2.13 dB(Polarize: V)
	2.57dB(Polarize: H)
Uncertainty for Radiation Emission test in 3m chamber (30MHz to 1GHz)	3.54dB(Polarize: V)
	4.1dB(Polarize: H)
Uncertainty for Radiation Emission test in 3m chamber (1GHz to 25GHz)	2.08dB(Polarize: H)
	2.56dB(Polarize: V)
Uncertainty for radio frequency	1×10^{-9}
Uncertainty for conducted RF Power	0.65dB
Uncertainty for temperature	0.2°C
Uncertainty for humidity	1%
Uncertainty for DC and low frequency voltages	0.06%

2.9. Test Equipment List

Equipment	Manufacture	Model No.	Serial No.	Last cal.	Cal Interval
Horn Antenna	SCHWARZBECK	BBHA 9120 D	BBHA 9120 D(1201)	2018.04.13	2020.04.12
Filter	KANGMAI	ZLPF-LDC-1000- 1959	1209002075	2018.09.21	2019.09.20
Filter	WAINWRIGHT	WHKX2.80 /18G- 12SS	SN1	2018.09.21	2019.09.20
RF Cable	Resenberger	Cable 4	N/A	2018.09.21	2019.09.20
Signal Analyzer	Agilent	N9020A	MY499100060	2018.09.21	2019.09.20
Filter	WAINWRIGHT	WHKX1.0G/15G- 10SS	SN40	2018.09.21	2019.09.20
Test Receiver	ROHDE&SCHWARZ	ESR	1316.3003K03-102082-Wa	2018.09.21	2019.09.20
Bilog Antenna	SCHWARZBECK	VULB 9168	9168-438	2018.04.13	2020.04.12
9*6*6 anechoic chamber	CHENYU	9*6*6	N/A	2018.09.21	2019.09.20
RF Cable	Resenberger	Cable 1	N/A	2018.09.21	2019.09.20
RF Cable	Resenberger	Cable 2	N/A	2018.09.21	2019.09.20
RF Cable	Resenberger	Cable 3	N/A	2018.09.21	2019.09.20
Loop Antenna	SCHWARZBECK	FMZB 1519B	00005	2018.09.21	2019.09.20
Horn Antenna	SCHWARZBECK	BBHA 9170	BBHA 9170294	2017.03.16	2019.03.15
Preamplifier	SCHWARZBECK	BBV9721	9721-031	2018.09.02	2019.09.01
Spectrum analyzer	ROHDE&SCHWARZ	FSQ40	200061	2017.12.28	2018.12.27
Power Meter	Anritsu	ML2487A	6K00001491	2018.09.21	2019.09.20
20dB Attenuator	ICPROBING	IATS1	82347	2018.09.21	2019.09.20

3. SPURIOUS EMISSION

3.1. Test Limits

Frequencies (MHz)	Field Strength (micorvolts/meter)	Measurement Distance (meters)
0.009~0.490	2400/F(KHz)	300
0.490~1.705	24000/F(KHz)	30
1.705~30.0	30	30
30~88	100	3
88~216	150	3
216~960	200	3
Above 960	500	3

Harmonic emissions limits comply with below 54 dBuV/m at 3m. Other emissions radiated outside of the specified frequency bands, except for harmonics, shall be attenuated by at least 50 dB below the level of the fundamental or comply with the radiated emissions limits specified in section 15.209(a) limit in the table below has to be followed.

NOTE:

- a) The tighter limit applies at the band edges.
- b) Emission Level(dB uV/m)=20log Emission Level(Uv/m)

3.2. Test Procedure

The measuring distance of 3m shall be used for measurements at frequency up to 1GH and above 1GHz, The EUT was placed on a rotating 0.8 m high above ground for below 1GHz and 1.5m high for above1GHz testing, The table was rotated 360 degrees to determine the position of the highest radiation

The Test antenna shall vary between 1m and 4m,Both Horizontal and Vertical antenna are set of make measurement.

The initial step in collecting conducted emission data is a spectrum analyzer Peak detector mode pre-scanning the measurement frequency range. Significant Peaks are then marked. and then Qusia Peak Detector mode premeasured

If Peak value comply with QP limit Below 1GHz.The EUT deemed to comply with QP limit. But the Peak value and average value both need to comply with applicable limit above 1GHz.

For the actual test configuration, please see the test setup photo.

3.3. Test Setup

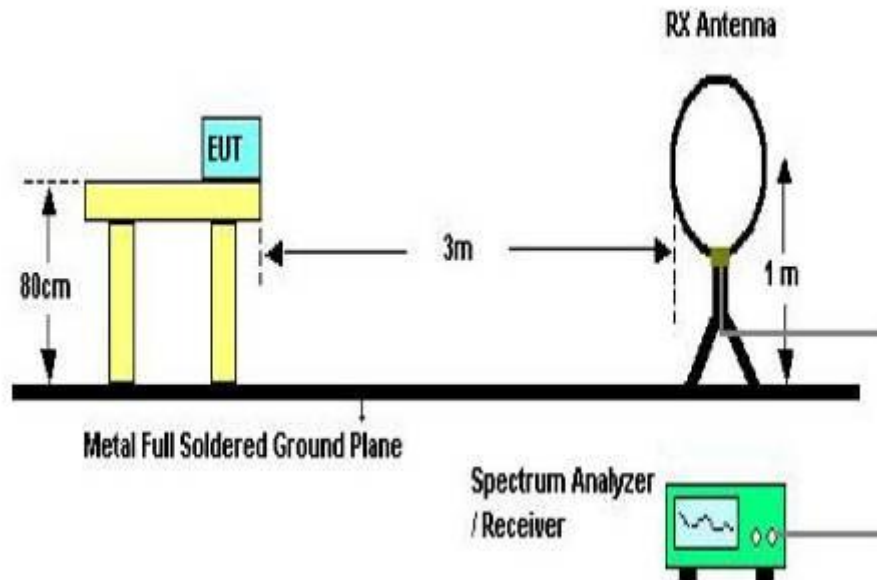

Below 30MHz Test Setup

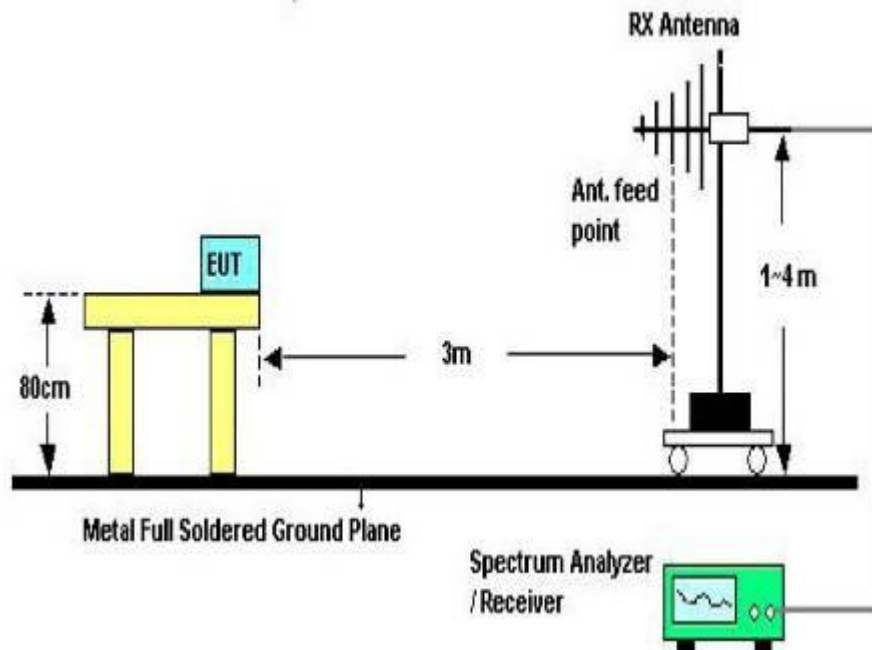

Above 30MHz Test Setup

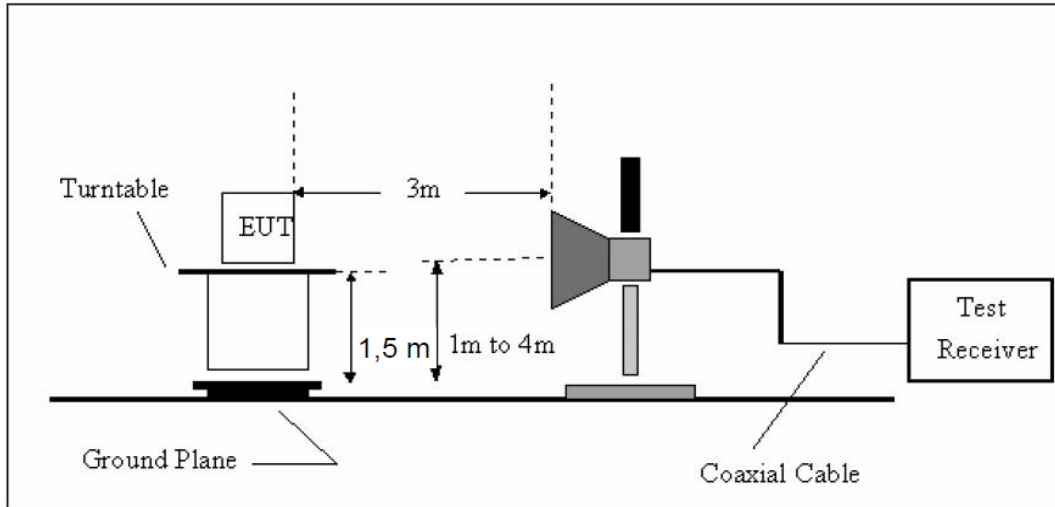

Above 1GHz Test Setup

3.4. Test Results

Test Condition

Continual Transmitting in maximum power.

9KHz~150KHz	RBW200Hz	VBW1KHz
150KHz~30MHz	RBW9KHz	VBW 30KHz
30MHz~1GHz	RBW120KHz	VBW 300KHz
Above1GHz	RBW1MHz	VBW 3MHz

We have scanned the 10th harmonic from 9 kHz to the EUT.

Detailed information please see the following page.

From 9KHz to 30MHz: Conclusion: PASS

Note:1.The amplitude of spurious emissions which are attenuated by more than 20dB below the permissible value has no need to be reported.

2.Only show the test data of the worst Channel in this report.

H

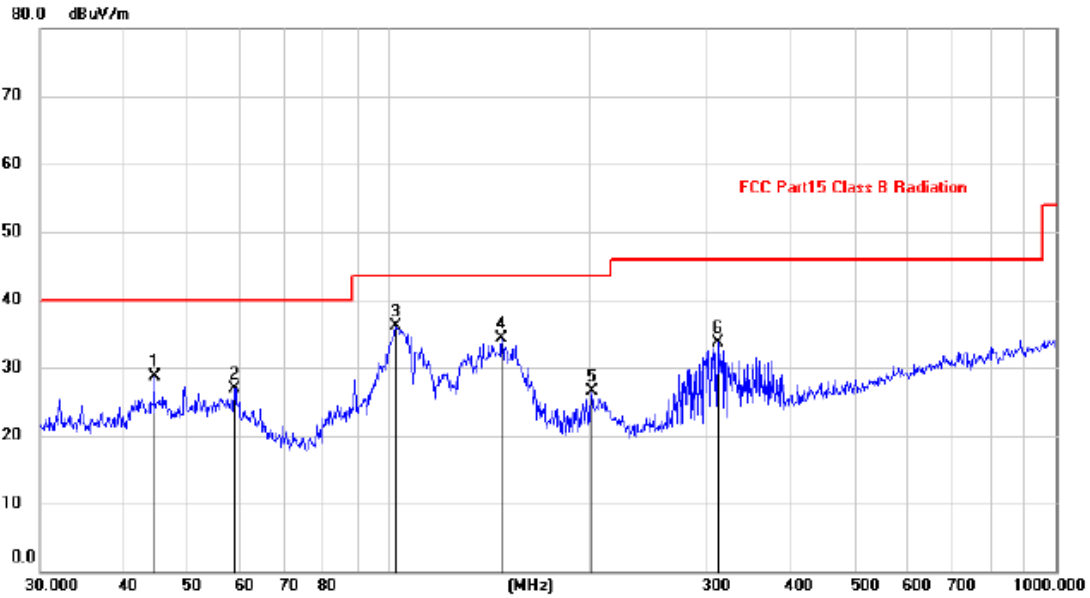

No.	Mk.	Freq. MHz	Reading Level dBuV	Correct Factor dB	Measure- ment dBuV/m	Limit dBuV/m	Margin dB	Detector	Antenna Height cm	Table Degree	Comment
1		44.4308	14.94	13.79	28.73	40.00	-11.27	peak			
2		58.6126	13.79	13.10	26.89	40.00	-13.11	peak			
3	*	102.3597	25.24	10.82	36.06	43.50	-7.44	peak			
4		147.4036	19.89	14.36	34.25	43.50	-9.25	peak			
5		201.3930	16.06	10.38	26.44	43.50	-17.06	peak			
6		311.0867	20.01	13.66	33.67	46.00	-12.33	peak			

V

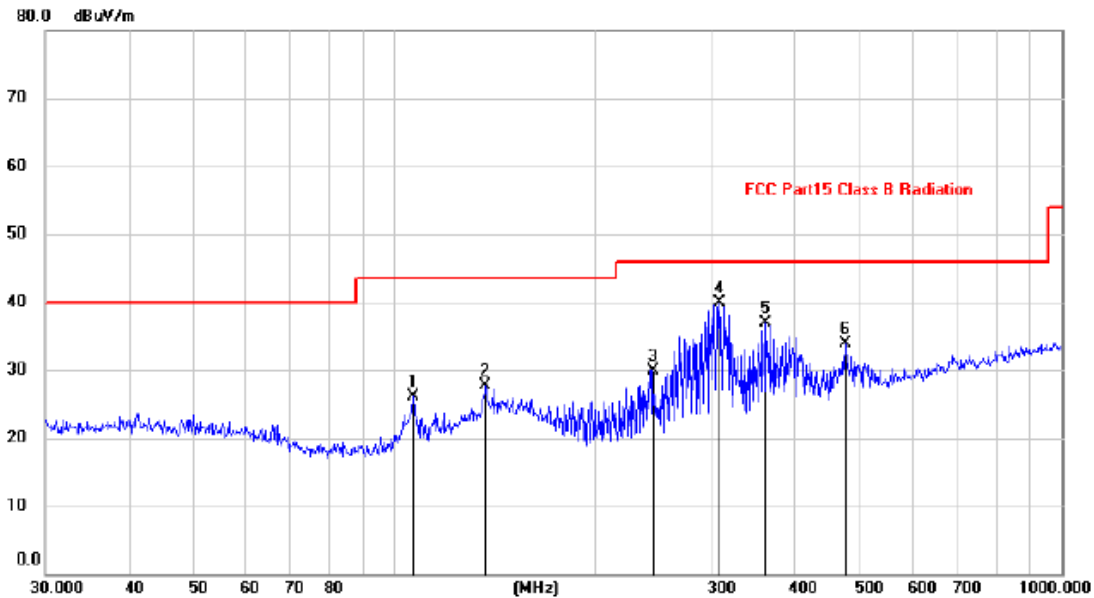

No.	Mk.	Freq.	Reading Level	Correct Factor	Measurement	Limit	Margin	Antenna Height	Table Degree
		MHz	dBuV	dB	dBuV/m	dBuV/m	dB	cm	degree
1		106.7587	14.94	11.22	26.16	43.50	-17.34	peak	
2		136.9391	14.14	13.65	27.79	43.50	-15.71	peak	
3		243.3772	17.94	12.00	29.94	46.00	-16.06	peak	
4	*	306.7537	26.38	13.59	39.97	46.00	-6.03	peak	
5		360.4476	22.31	14.53	36.84	46.00	-9.16	peak	
6		473.8347	16.77	17.04	33.81	46.00	-12.19	peak	

Remark: Above is below 1GHz test data. This report only shall the worst case mode for TX IEEE 802.11b 2437MHz.

From 1G-25GHz

Test Mode: IEEE 802.11b TX Low									
Freq (MHz)	Read Level (dBuV/m)	Polar (H/V)	Antenna Factor (dB/m)	Cable loss(dB)	Amp Factor (dB)	Result (dBuV/m)	Limit (dBuV/m)	Margin (dB)	Remark
4824	43.87	V	33.95	10.18	34.26	53.74	74	20.26	PK
4824	34.85	V	33.95	10.18	34.26	44.72	54	9.28	AV
7236									
9648									
4824	43.16	H	33.95	10.18	34.26	53.03	74	20.97	PK
4824	33.96	H	33.95	10.18	34.26	43.83	54	10.17	AV
7236									
9648									
Test Mode: IEEE 802.11b TX Mid									
4874	41.31	V	33.93	10.2	34.29	51.15	74	22.85	PK
4874	32.20	V	33.93	10.2	34.29	42.04	54	11.96	AV
7311									
9748									
4874	41.51	H	33.93	10.2	34.29	51.35	74	22.65	PK
4874	32.83	H	33.93	10.2	34.29	42.67	54	11.33	AV
7311									
9748									
Test Mode: IEEE 802.11b TX High									
4924	41.78	V	33.98	10.22	34.25	51.73	74	22.27	PK
4924	32.73	V	33.98	10.22	34.25	42.68	54	11.32	AV
7386									
9848									
4924	42.68	H	33.98	10.22	34.25	52.63	74	21.37	PK
4924	32.02	H	33.98	10.22	34.25	41.97	54	12.03	AV
7386									
9848									
Note:									
1, Result = Read level + Antenna factor + cable loss-Amp factor									
2, All the other emissions not reported were too low to read and deemed to comply with FCC limit.									

Test Mode: IEEE 802.11g TX Low									
Freq (MHz)	Read Level (dBuV/m)	Polar (H/V)	Antenna Factor (dB/m)	Cable loss(dB)	Amp Factor (dB)	Result (dBuV/m)	Limit (dBuV/m)	Margin (dB)	Remark
4824	42.34	V	33.95	10.18	34.26	52.21	74	21.79	PK
4824	31.90	V	33.95	10.18	34.26	41.77	54	12.23	AV
7236	/								
9648	/								
4824	44.19	H	33.95	10.18	34.26	54.06	74	19.94	PK
4824	31.73	H	33.95	10.18	34.26	41.60	54	12.40	AV
7236									
9648									
Test Mode: IEEE 802.11g TX Mid									
4874	43.76	V	33.98	10.2	34.25	53.69	74	20.31	PK
4874	31.14	V	33.98	10.2	34.25	41.07	54	12.93	AV
7311	/								
9748	/								
4874	43.17	H	33.93	10.2	34.29	53.01	74	20.99	PK
4874	33.33	H	33.93	10.2	34.29	43.17	54	10.83	AV
7311									
9748									
Test Mode: IEEE 802.11g TX High									
4924	42.25	V	33.98	10.22	34.25	52.20	74	21.80	PK
4924	32.29	V	33.98	10.22	34.25	42.24	54	11.76	AV
7386	/								
9848	/								
4924	42.68	H	33.98	10.22	34.25	52.63	74	21.37	PK
4924	31.25	H	33.98	10.22	34.25	41.20	54	12.80	AV
7386									
9848									
Note:									
1, Result = Read level + Antenna factor + cable loss-Amp factor									
2, All the other emissions not reported were too low to read and deemed to comply with FCC limit.									

Test Mode:IEEE 802.11n HT20 TX Low									
Freq (MHz)	Read Level (dBuV/m)	Polar (H/V)	Antenna Factor (dB/m)	Cable loss(dB)	Amp Factor (dB)	Result (dBuV/m)	Limit (dBuV/m)	Margin (dB)	Remark
4824	42.20	V	33.95	10.18	34.26	52.07	74	21.93	PK
4824	31.76	V	33.95	10.18	34.26	41.63	54	12.37	AV
7236	/								
9648	/								
4824	40.75	H	33.95	10.18	34.26	50.62	74	23.38	PK
4824	31.86	H	33.95	10.18	34.26	41.73	54	12.27	AV
7236									
9648									
Test Mode:IEEE 802.11n HT20 TX Mid									
4874	41.76	V	33.93	10.2	34.29	51.60	74	22.40	PK
4874	32.62	V	33.93	10.2	34.29	42.46	54	11.54	AV
7311	/								
9748	/								
4874	42.74	H	33.93	10.2	34.29	52.58	74	21.42	PK
4874	32.36	H	33.93	10.2	34.29	42.20	54	11.80	AV
7311									
9748									
Test Mode:IEEE 802.11n HT20 TX High									
4924	41.95	V	33.98	10.22	34.25	51.90	74	22.10	PK
4924	32.51	V	33.98	10.22	34.25	42.46	54	11.54	AV
7386	/								
9848	/								
4924	42.39	H	33.98	10.22	34.25	52.34	74	21.66	PK
4924	32.69	H	33.98	10.22	34.25	42.64	54	11.36	AV
7386									
9848									
Note:									
1, Result = Read level + Antenna factor + cable loss-Amp factor									
2, All the other emissions not reported were too low to read and deemed to comply with FCC limit.									

Test Mode:IEEE 802.11n HT40 TX Low									
Freq (MHz)	Read Level (dBuV/m)	Polar (H/V)	Antenna Factor (dB/m)	Cable loss(dB)	Amp Factor (dB)	Result (dBuV/m)	Limit (dBuV/m)	Margin (dB)	Remark
4844	41.42	V	33.95	10.18	34.26	51.29	74	22.71	PK
4844	31.85	V	33.95	10.18	34.26	41.72	54	12.28	AV
7266	/								
9688	/								
4844	40.40	H	33.95	10.18	34.26	50.27	74	23.73	PK
4844	31.67	H	33.95	10.18	34.26	41.54	54	12.46	AV
7266									
9688									
Test Mode:IEEE 802.11n HT40 TX Mid									
4874	42.16	V	33.93	10.2	34.29	52.00	74	22.00	PK
4874	32.47	V	33.93	10.2	34.29	42.31	54	11.69	AV
7311	/								
9748	/								
4874	42.62	H	33.93	10.2	34.29	52.46	74	21.54	PK
4874	33.05	H	33.93	10.2	34.29	42.89	54	11.11	AV
7311									
9748									
Test Mode:IEEE 802.11n HT40 TX High									
4904	41.57	V	33.98	10.22	34.25	51.52	74	22.48	PK
4904	32.39	V	33.98	10.22	34.25	42.34	54	11.66	AV
7356	/								
9808	/								
4904	42.09	H	33.98	10.22	34.25	52.04	74	21.96	PK
4904	33.29	H	33.98	10.22	34.25	43.24	54	10.76	AV
7356									
9808									
Note:									
1, Result = Read level + Antenna factor + cable loss-Amp factor									
2, All the other emissions not reported were too low to read and deemed to comply with FCC limit.									

4. POWER LINE CONDUCTED EMISSION

4.1. Test Limits

Frequency MHz	Limits dB(μ V)	
	Quasi-peak Level	Average Level
0.15 -0.50	66 -56*	56 - 46*
0.50 -5.00	56	46
5.00 -30.00	60	50

- Notes: 1. *Decreasing linearly with logarithm of frequency.
 2. The lower limit shall apply at the transition frequencies.
 3. The limit decreases in line with the logarithm of the frequency in the rang of 0.15 to 0.50 MHz.

4.2. Test Procedure

The EUT is put on the plane 0.8m high above the ground by insulating support and is connected to the power mains through a line impedance stabilization network (L.I.S.N.). This provides a 50ohm coupling impedance for the EUT system. Please refer the block diagram of the test setup and photographs. Both sides of AC lines are checked to find out the maximum conducted emission. In order to find the maximum emission levels, the relative positions of equipment and all of the interface cables shall be changed according to ANSI C63.10:2013 on Conducted Emission Measurement.

The bandwidth of test receiver is set at 9 kHz.

4.3. Test Setup

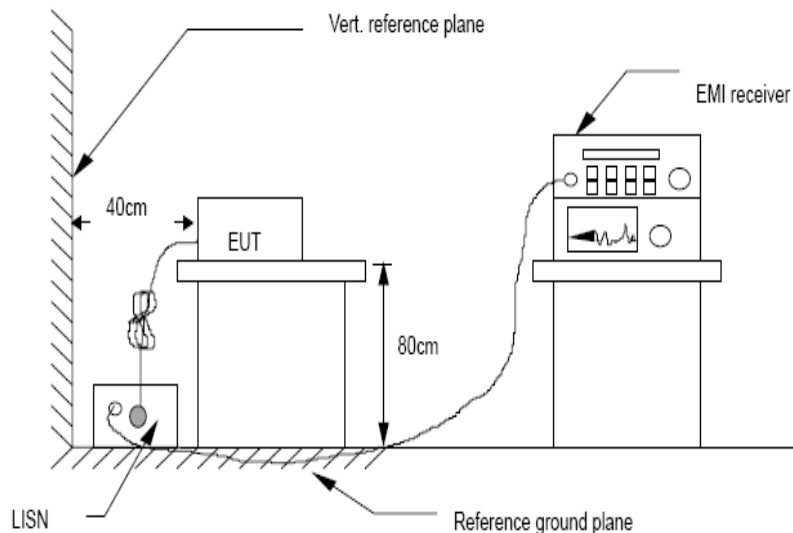

4.4. Test Results

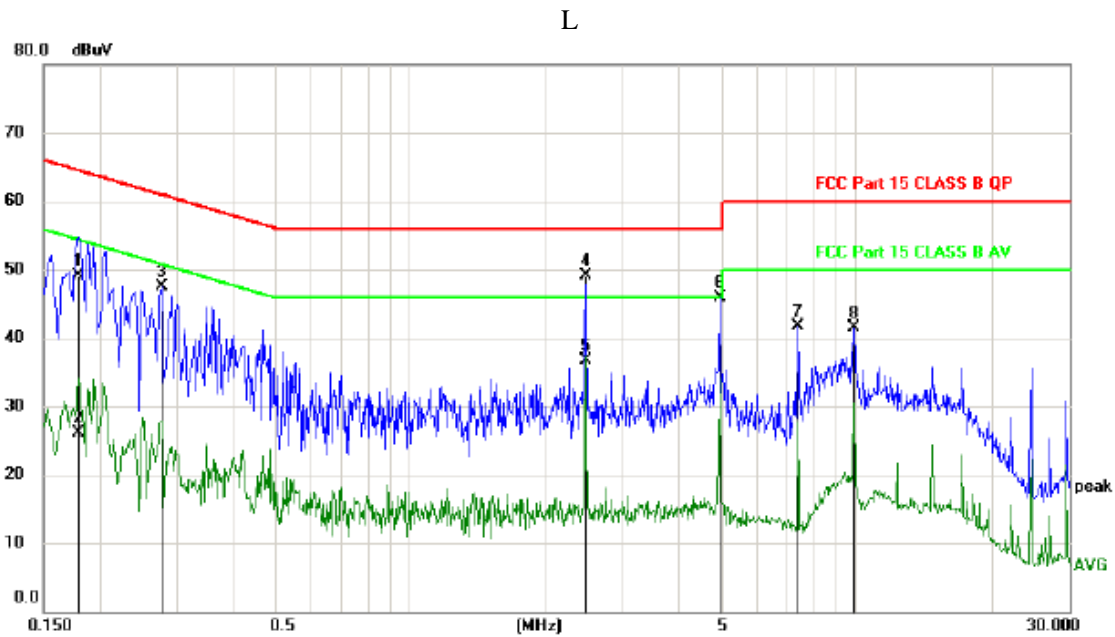

No.	Mk.	Freq. MHz	Reading Level dBuV	Correct Factor dB	Measure- ment dBuV	Limit dBuV	Margin dB	Detector	Comment
1		0.1800	39.39	9.74	49.13	64.49	-15.36	QP	
2		0.1800	16.37	9.74	26.11	54.49	-28.38	AVG	
3		0.2760	37.77	9.76	47.53	60.94	-13.41	peak	
4	*	2.4660	39.14	9.98	49.12	56.00	-6.88	QP	
5		2.4660	26.74	9.98	36.72	46.00	-9.28	AVG	
6		4.9320	35.81	10.19	46.00	56.00	-10.00	peak	
7		7.4040	31.47	10.28	41.75	60.00	-18.25	peak	
8		9.8730	31.07	10.35	41.42	60.00	-18.58	peak	

N

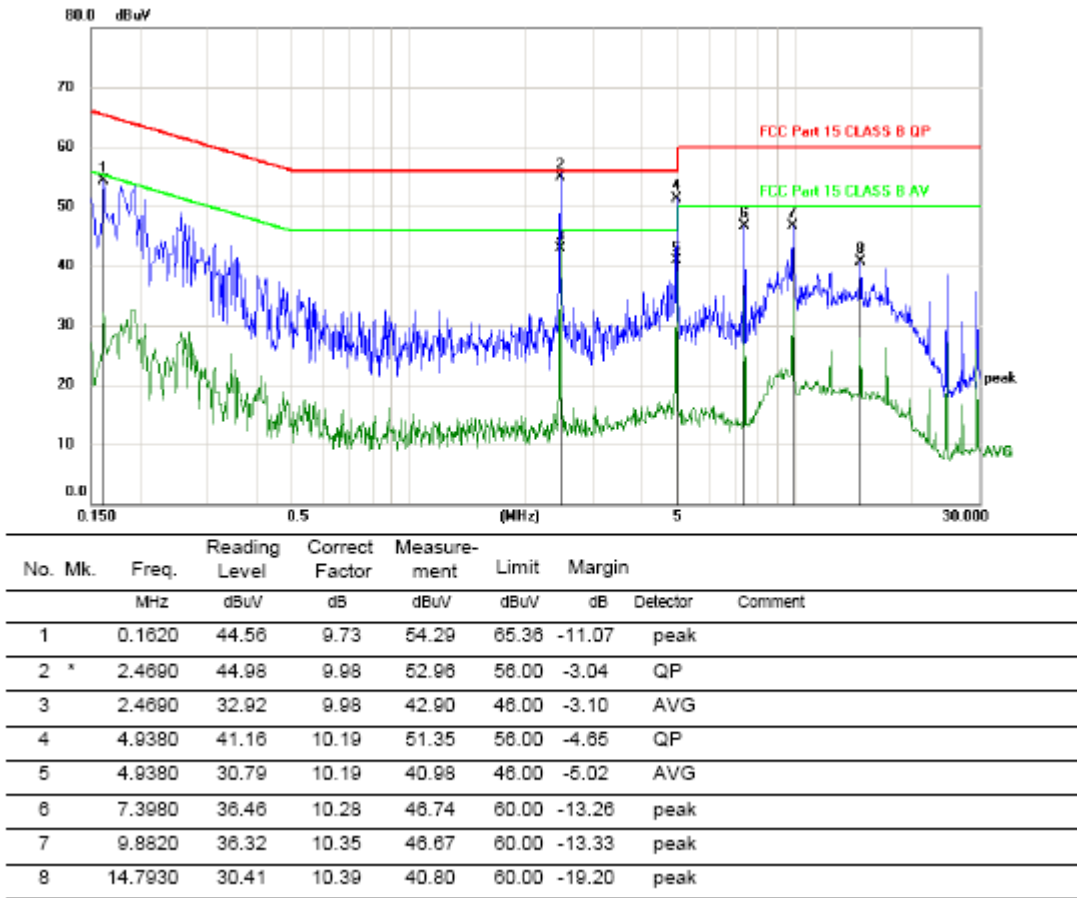

Remark: All modes and channels have been tested and only listed WiFi link mode that is worst data.

5. CONDUCTED MAXIMUM OUTPUT POWER

5.1. Test limits

Please refer section 15.247.

Regulation 15.247(b) The limit of Maximum Peak Output Power Measurement is 1 W(30dBm)

5.2. Test Procedure

Details see the KDB558074 D01 Meas Guidance V04

5.2.1 Place the EUT on the table and set it in transmitting mode.

5.2.2 Connected the EUT's antenna port to peak power meter by 20dB attenuator.

5.2.3 Measure out each mode and each bands peak output power of EUT.

Note: The cable loss and attenuator loss were offset into measure device as amplitude offset.

5.3. Test Setup

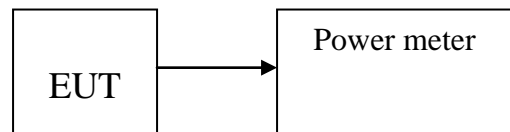

5.4. Test Results

PASS

Detailed information please see the following page.

Mode	Frequency (MHz)	Ant Port	PK Output power(dBm)		Limit (dBm)	Margin (dB)
IEEE 802.11 b	CH1: 2412	1	-0.72	-0.72	30	30.72
		/	/			
	CH6: 2437	1	0.11	0.11	30	29.89
		/	/			
	CH11: 2462	1	-0.15	-0.15	30	30.15
		/	/			
IEEE 802.11 g	CH1: 2412	1	0.12	0.12	30	30.12
		/	/			
	CH6: 2437	1	0	0	30	30.00
		/	/			
	CH11: 2462	1	0.27	0.27	30	29.73
		/	/			
IEEE 802.11 n/HT20 with 2.4G	CH1: 2412	1	0.15	0.15	30	29.85
		/	/			
	CH6: 2437	1	-0.19	-0.19	30	30.19
		/	/			
	CH11: 2462	1	-0.36	-0.36	30	30.36
		/	/			
IEEE 802.11 n/HT40 with 2.4G	CH1: 2422	1	0.16	0.16	30	29.84
		/	/			
	CH4: 2437	1	0.09	0.09	30	29.91
		/	/			
	CH7: 2452	1	0.06	0.06	30	29.94
		/	/			
Conclusion: PASS						

6. PEAK POWER SPECTRAL DENSITY

6.1. Test limits

6.1.1 Please refer section 15.247.

6.1.2 For direct sequence systems, the peak power spectral density conducted from the intentional radiator to the antenna shall not be greater than 8dBm in any 3kHz band during any time interval of continuous transmission.

6.1.3 The direct sequence operating of the hybrid system, with the frequency hopping operation turned off, shall comply with the power density requirements of paragraph (d) of this section.

6.2. Test Procedure

Details see the KDB558074 D01 Meas Guidance V04

6.2.1 Place the EUT on the table and set it in transmitting mode.

6.2.2 Remove the antenna from the EUT and then connect a low loss RF cable from the antenna port to the spectrum analyzer.

6.2.3 Set the spectrum analyzer as $RBW = 3\text{kHz}$ (Set the RBW to: $3\text{ kHz} \leq RBW \leq 100\text{ kHz}$.), $VBW = 10\text{kHz}$ (Set the $VBW \geq 3 \times RBW$), $\text{span} = 1.5 \times \text{DTS bandwidth}$., detail see the test plot.

6.2.4 Record the max reading.

6.2.5 Repeat the above procedure until the measurements for all frequencies are completed.

6.3. Test Setup

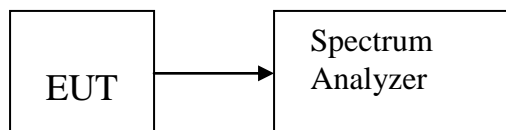

6.4. Test Results

Mode	Frequency (MHz)	Ant Port	PK Output power(dBm)		Limit (dBm)	Result
IEEE 802.11 b	CH1: 2412	1	-22.010	-22.010	8	PASS
		/	/			
	CH6: 2437	1	-22.210	-22.210	8	PASS
		/	/			
	CH11: 2462	1	-22.090	-22.090	8	PASS
		/	/			
IEEE 802.11 g	CH1: 2412	1	-26.775	-26.775	8	PASS
		/	/			
	CH6: 2437	1	-27.560	-27.560	8	PASS
		/	/			
	CH11: 2462	1	-28.973	-28.973	8	PASS
		/	/			
IEEE 802.11 n/HT20 with 2.4G	CH1: 2412	1	-29.197	-29.197	8	PASS
		/	/			
	CH6: 2437	1	-28.418	-28.418	8	PASS
		/	/			
	CH11: 2462	1	-28.765	-28.765	8	PASS
		/	/			
IEEE 802.11 n/HT40 with 2.4G	CH1: 2422	1	-31.195	-31.195	8	PASS
		/	/			
	CH4: 2437	1	-29.040	-29.040	8	PASS
		/	/			
	CH7: 2452	1	-30.063	-30.063	8	PASS
		/	/			
Conclusion: PASS						

IEEE 802.11b :
CH Low :

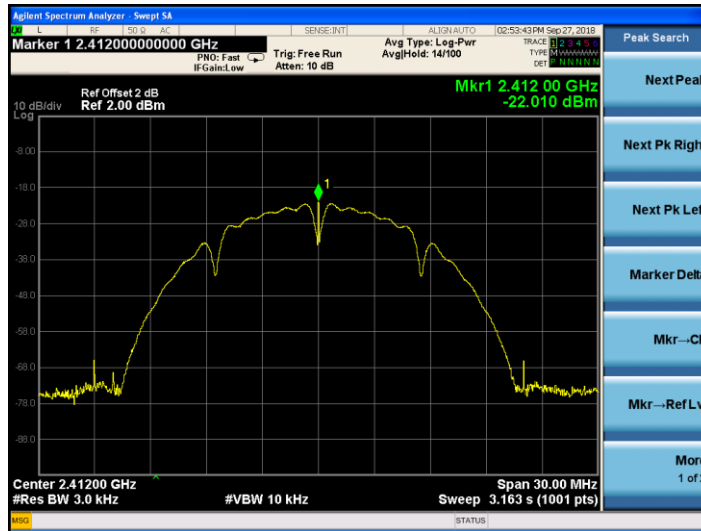

CH Mid:

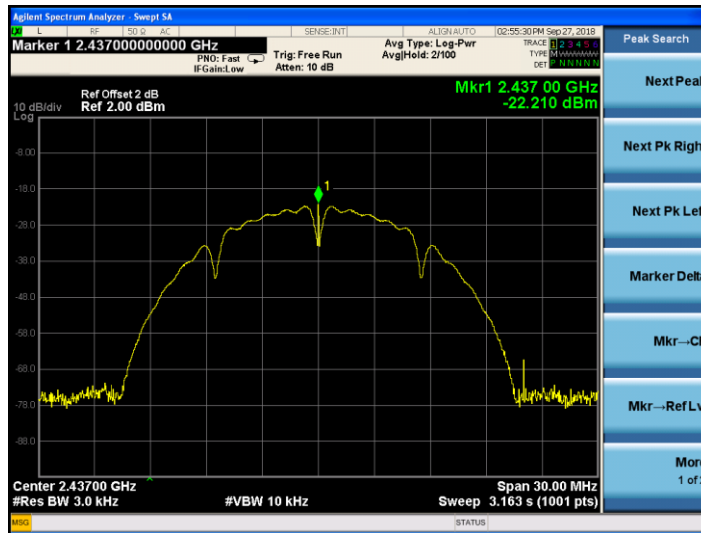

CH Hig:

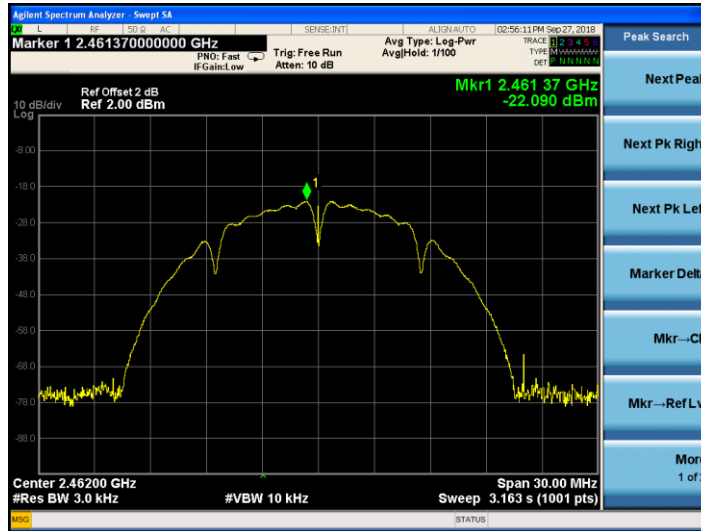

IEEE 802.11g :
CH Low

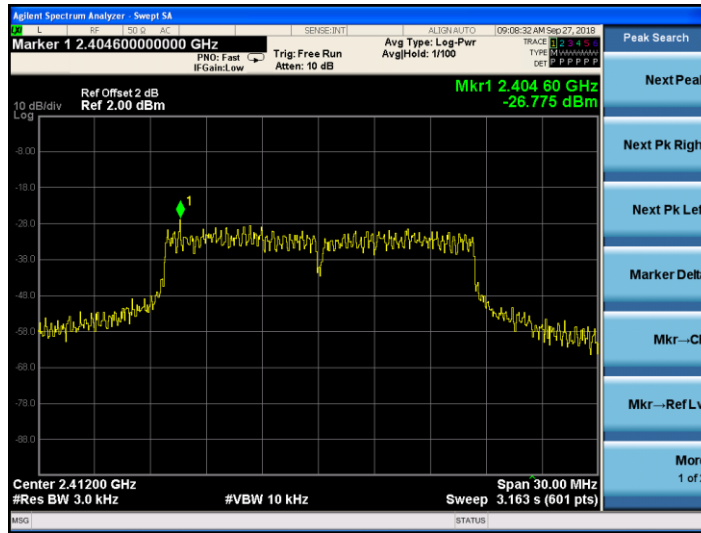

CH Mid:

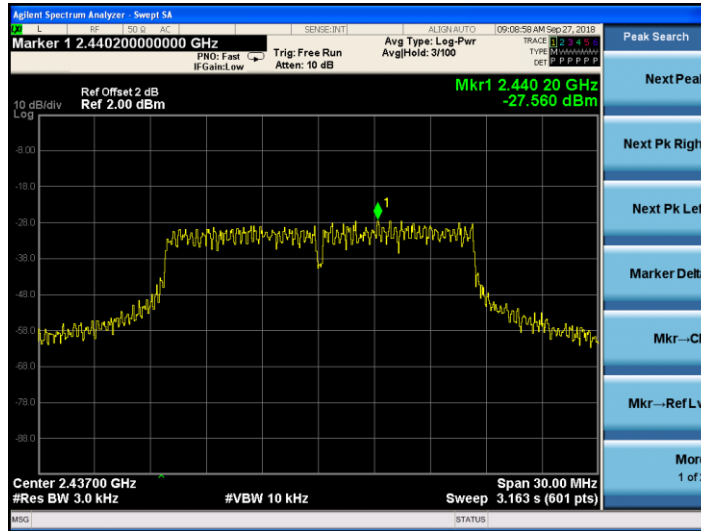

CH Hig:

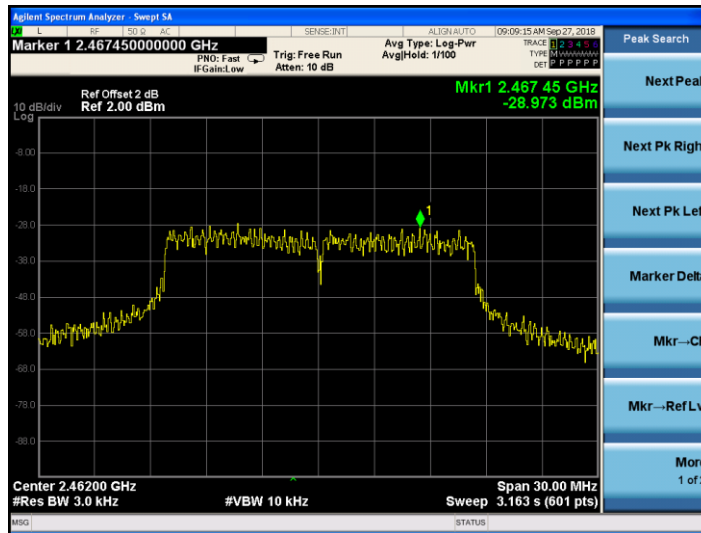

IEEE 802.11n HT20 :
CH Low :

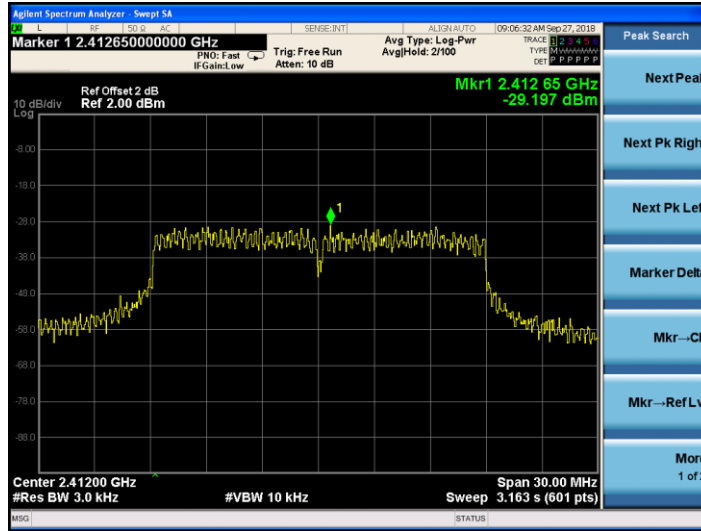

CH Mid:

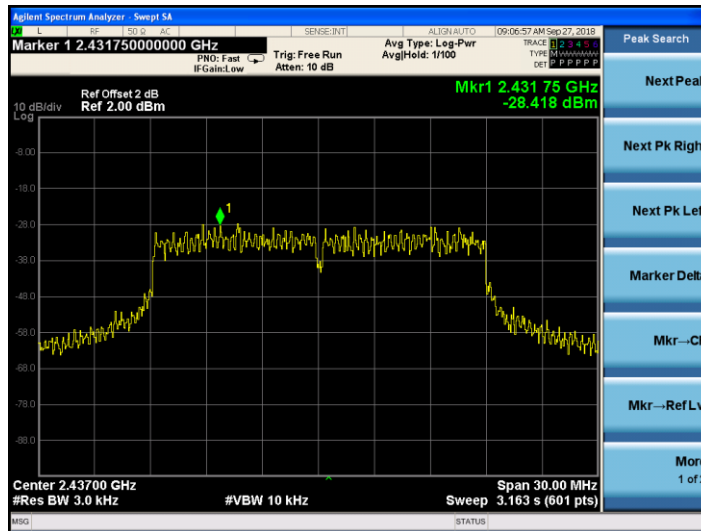

CH High:

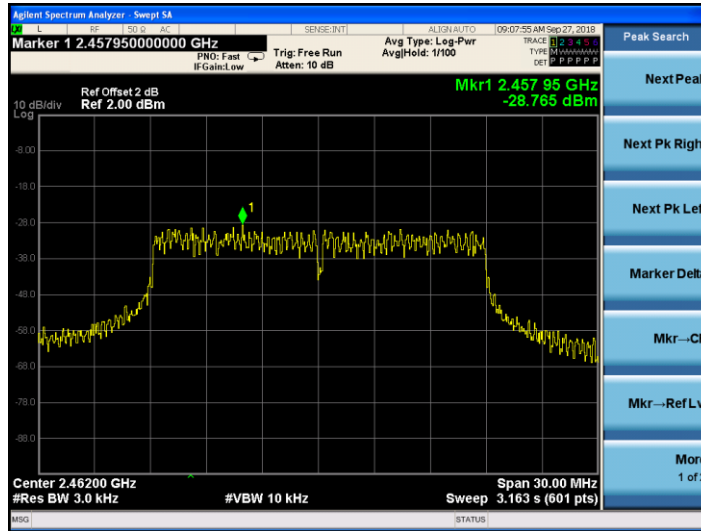

IEEE 802.11n HT40 :
CH Low :

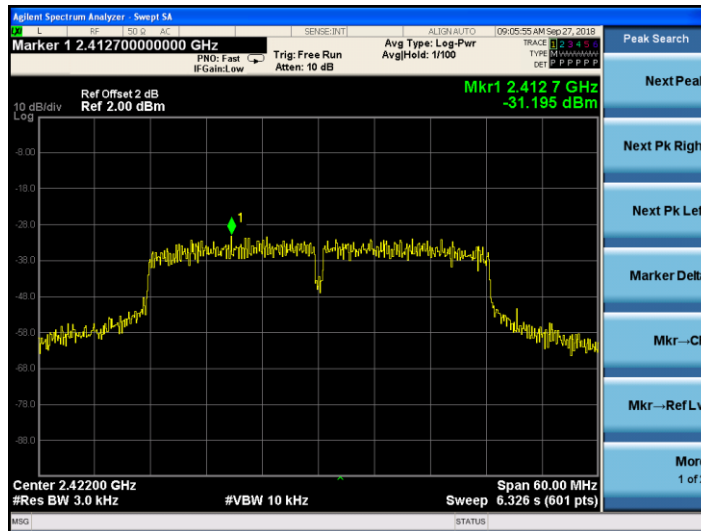

CH Mid:

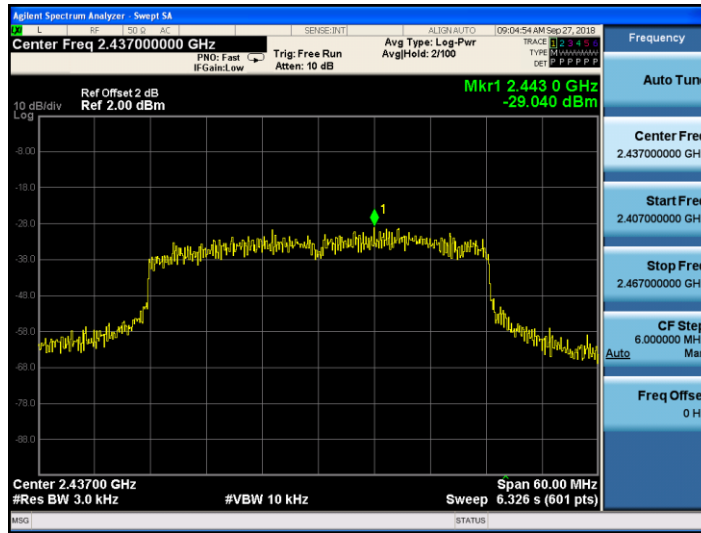

CH High:

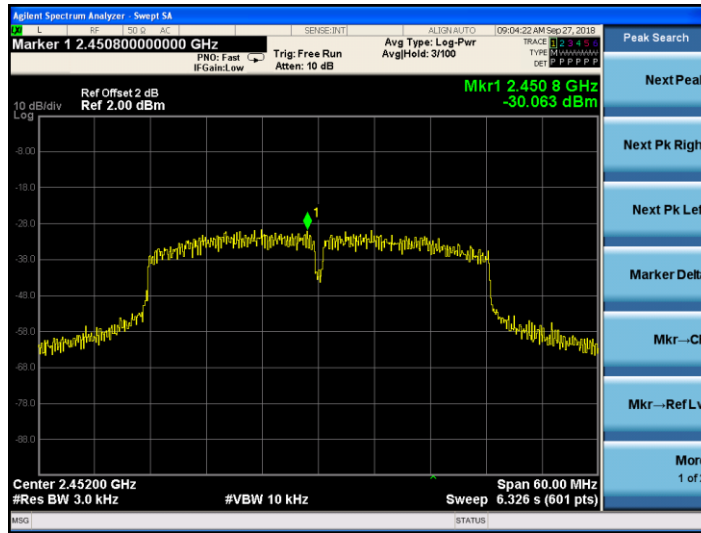

7. BANDWIDTH

7.1. Test limits

Please refer section 15.247

For direct sequence systems, the minimum 6dB bandwidth shall be at least 500 kHz.

7.2. Test Procedure

Details see the KDB558074 D01 Meas Guidance V04

- a) The bandwidth is measured at an amplitude level reduced 20dB from the reference level. The reference level is the level of the highest amplitude signal observed from the transmitter at the fundamental frequency. Once the reference level is established, the equipment is conditioned with typical modulating signal to produce the worst-case (i.e. the widest) bandwidth.
- b) The test receiver set $RBW = 100\text{kHz}$, $VBW \geq 3 * RBW = 300\text{kHz}$, Peak Detector, Sweep time set auto, detail see the test plot.

7.3. Test Setup

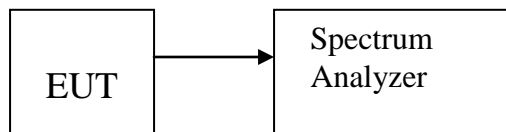

7.4. Test Results

Channel	Frequency (MHz)	6dB Bandwidth (MHz)	99% Occupied Bandwidth (MHz)	Limit (MHz)	Result
IEEE 802.11b:					
Low	2412	8.608	14.279	0.5	PASS
Mid	2437	9.075	14.070	0.5	PASS
High	2462	9.063	14.142	0.5	PASS
IEEE 802.11g					
Low	2412	16.36	16.850	0.5	PASS
Mid	2437	16.35	16.538	0.5	PASS
High	2462	16.40	16.601	0.5	PASS
IEEE 802.11n/HT20					
Low	2412	17.18	17.822	0.5	PASS
Mid	2437	16.05	17.696	0.5	PASS
High	2462	17.09	17.729	0.5	PASS
IEEE 802.11n/HT40					
Low	2422	35.08	36.252	0.5	PASS
Mid	2437	33.77	35.892	0.5	PASS
High	2452	35.00	35.928	0.5	PASS

IEEE 802.11b:
CH Low :

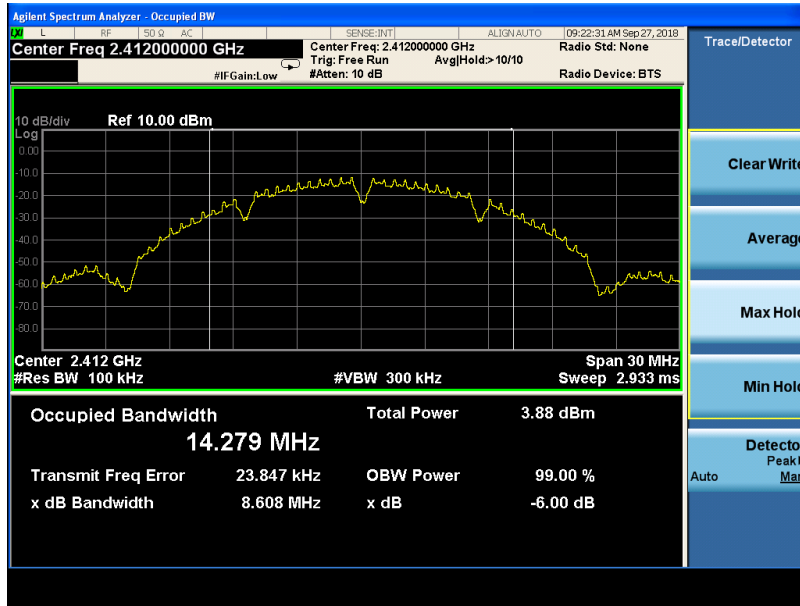

CH Mid :

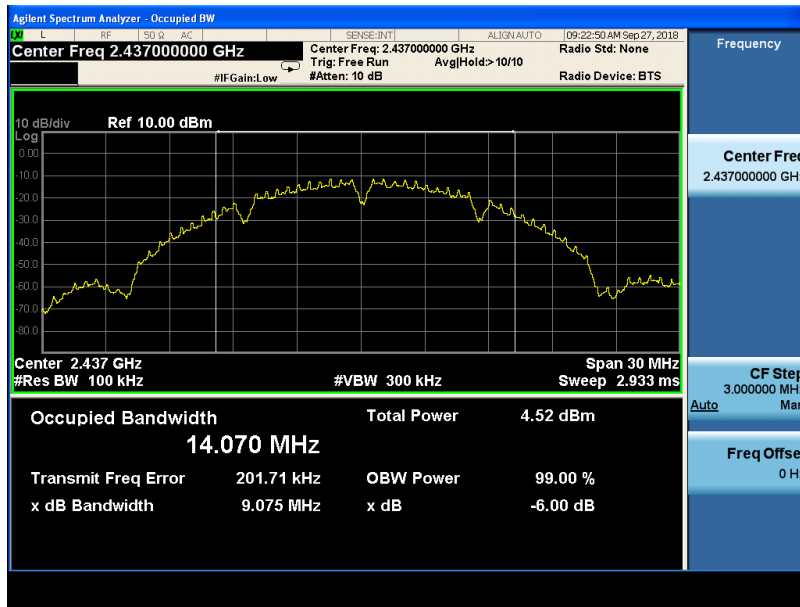

CH High :

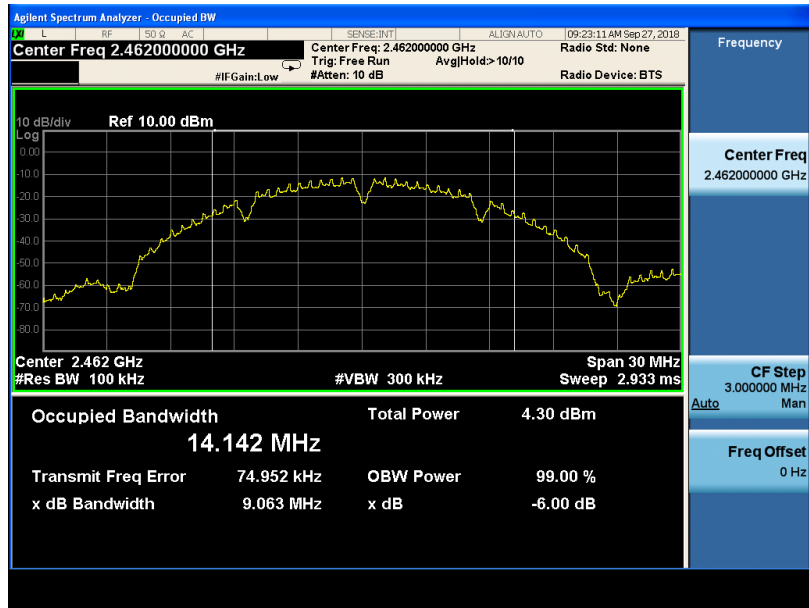

IEEE 802.11g:
CH Low :

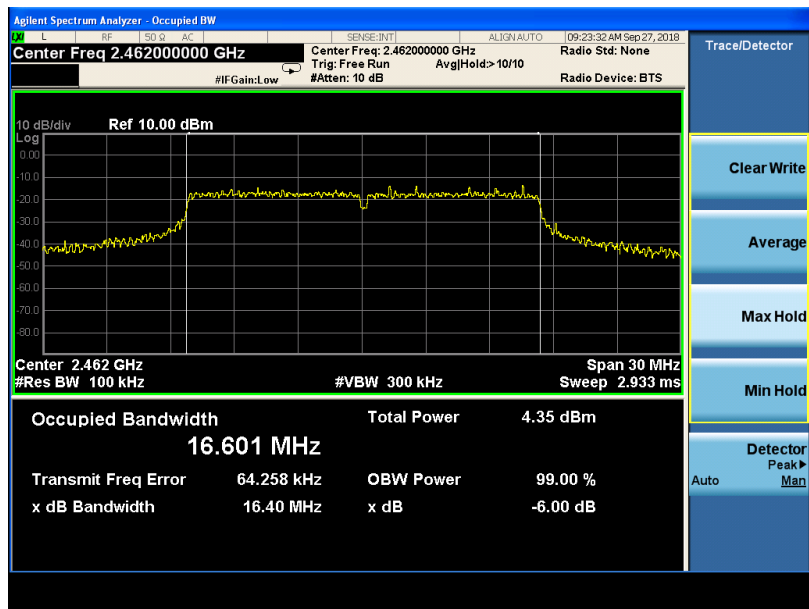

CH Mid:

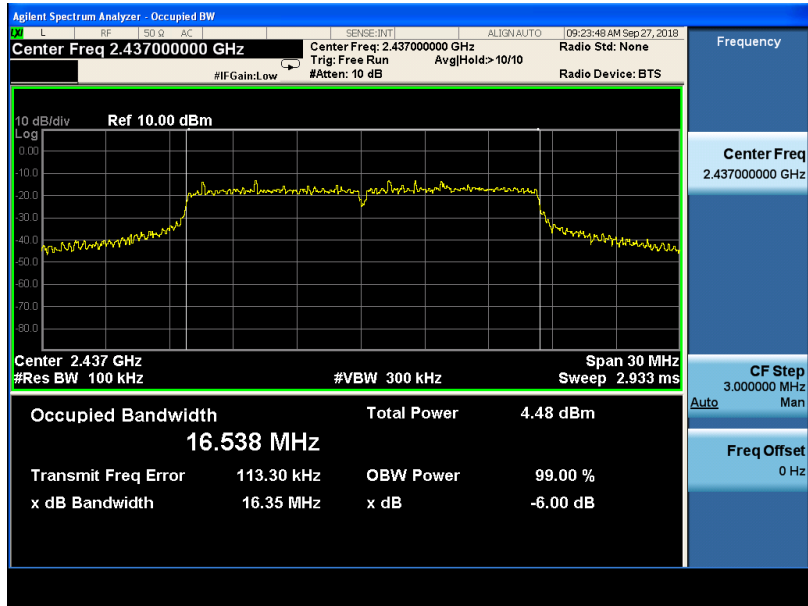

CH High

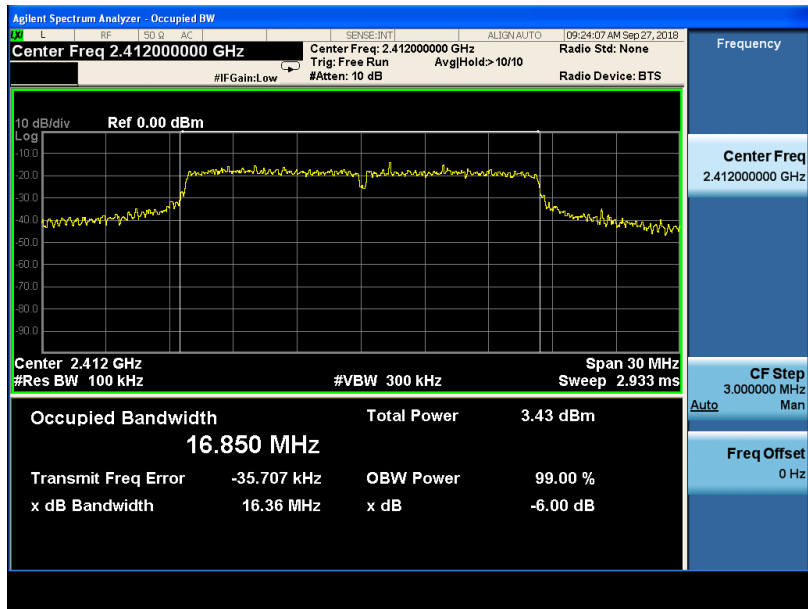

IEEE 802.11n HT20:
CH Low :

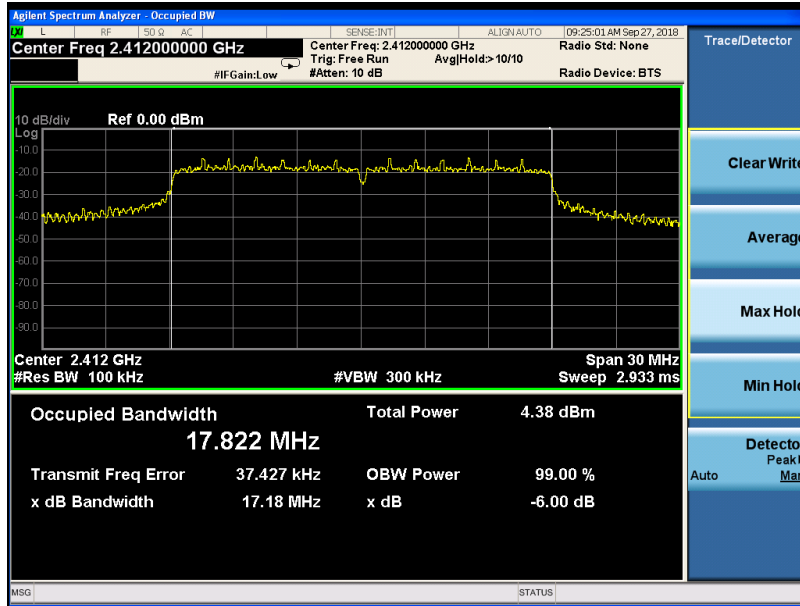

CH Mid :

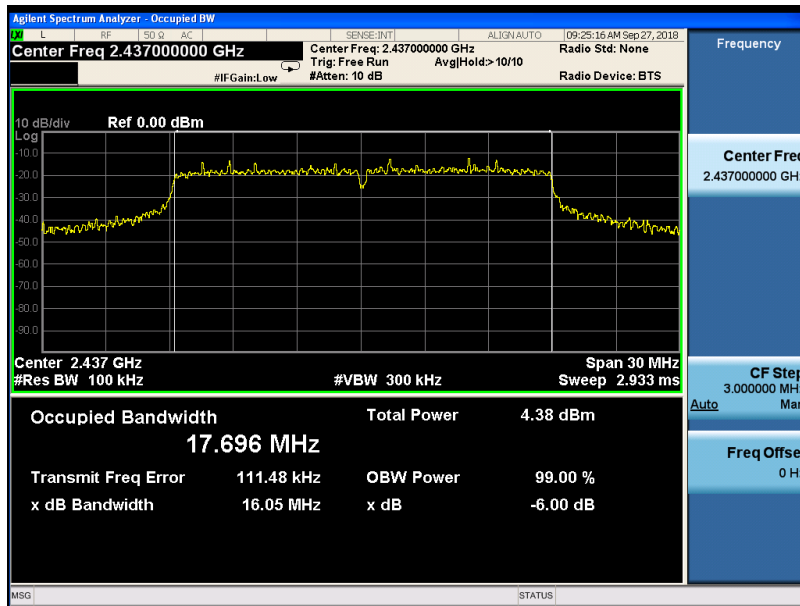

CH High :

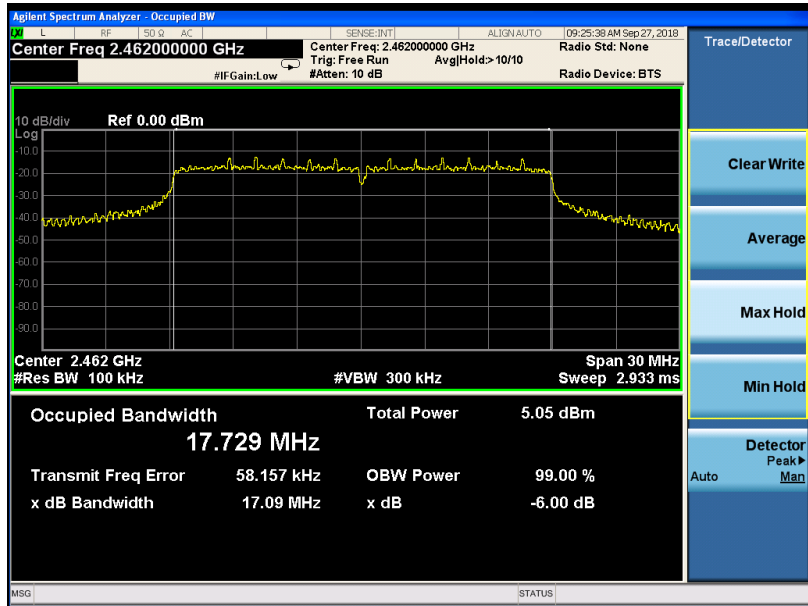

IEEE 802.11n HT40:

CH Low :

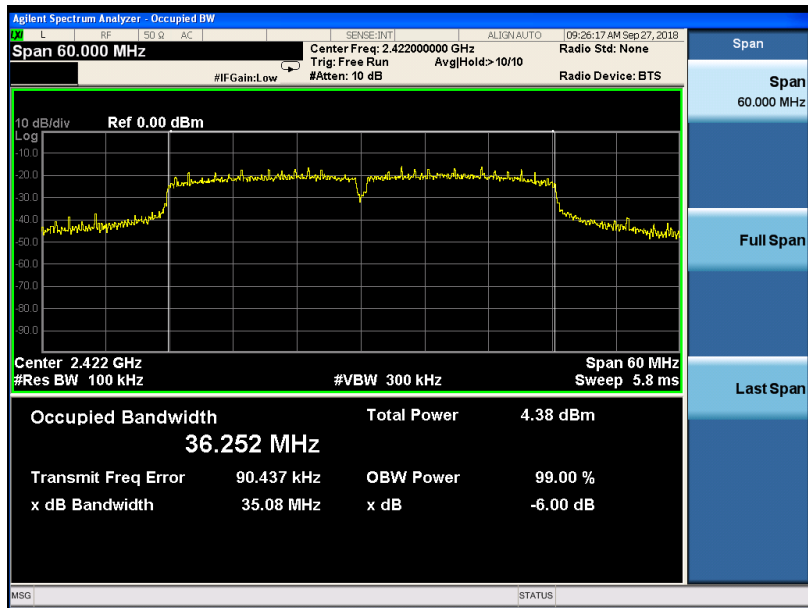

CH Mid :

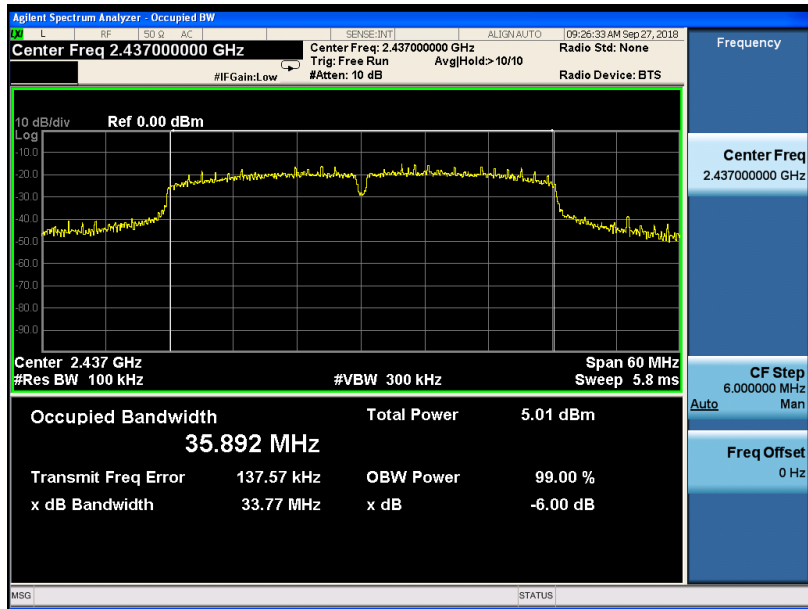

CH High :

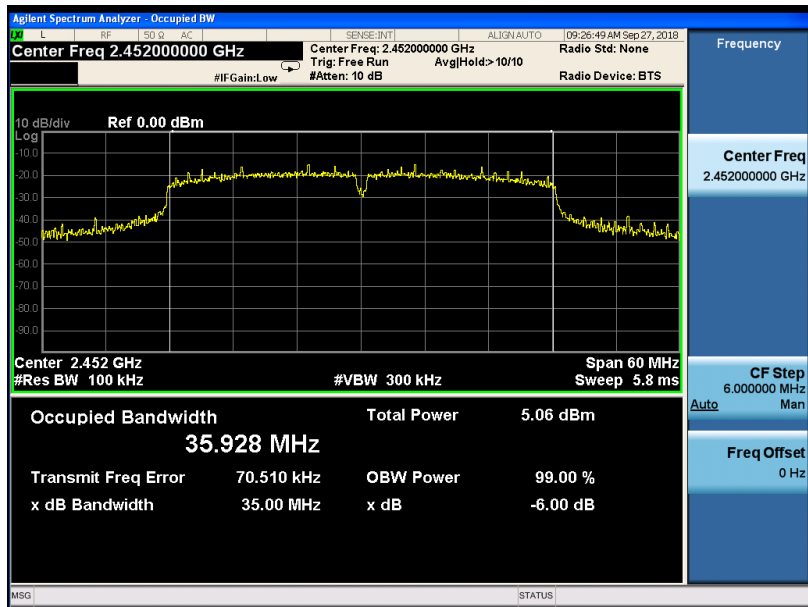

8. BAND EDGE CHECK

8.1. Test limits

Please refer section 15.247

All the lower and upper band-edges emissions appearing within 2310MHz to 2390MHz and 2483.5MHz to 2500MHz restricted frequency bands shall not exceed the limits shown in 15.209, all the other emissions outside operation frequency band 2400MHz to 2483.5MHz and 5725MHz to 5850MHz shall be at least 20dB below the fundamental emissions, or comply with 15.209 limits.

8.2. Test Procedure

Details see the KDB558074 D01 Meas Guidance V04

8.2.1 Put the EUT on a 0.8m high table, power on the EUT. Emissions were scanned and measured rotating the EUT to 360 degrees, Find the maximum Emission

8.2.2 Check the spurious emissions out of band.

8.2.3 RBW 1MHz, VBW 3MHz, peak detector for peak value , RBW 1MHz ,VBW 3MHz , RMS detector for AV value.

8.3. Test Setup

Same as 5.2.2.

8.4. Test Results

PASS.

Detailed information please see the following page.

Radiated Method:
IEEE 802.11b TX Low:

Polarization: V

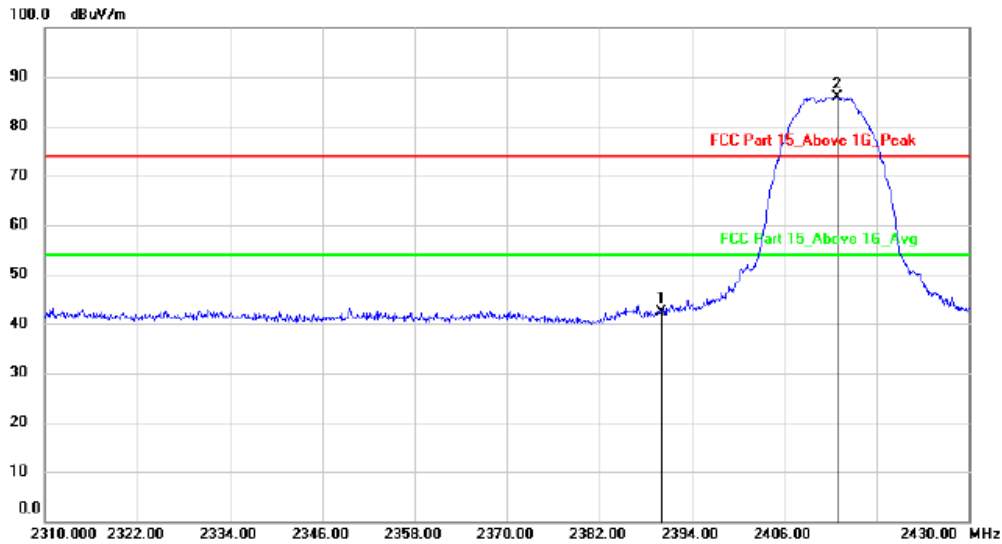

No.	Mk.	Freq.	Reading Level	Correct Factor	Measurement	Limit	Margin	Antenna Height	Table Degree	
		MHz	dBuV	dB	dBuV/m	dBuV/m	dB	cm	degree	Comment
1		2390.000	45.87	-3.40	42.47	74.00	-31.53			peak
2	*	2412.960	89.37	-3.41	85.96	74.00	11.96			peak

Polarization: H

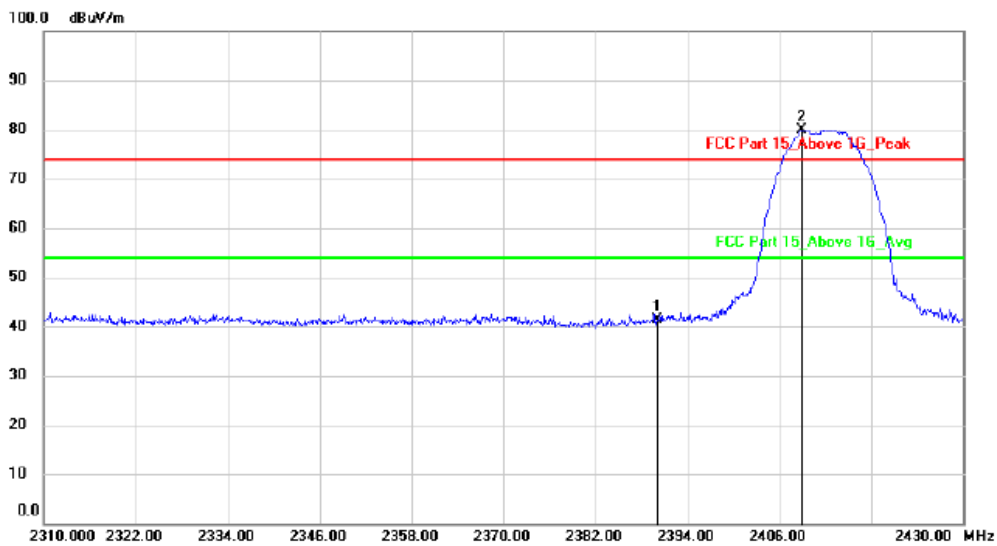

No.	Mk.	Freq.	Reading Level	Correct Factor	Measurement	Limit	Margin	Antenna Height	Table Degree	
		MHz	dBuV	dB	dBuV/m	dBuV/m	dB	cm	degree	Comment
1		2390.000	44.70	-3.40	41.30	74.00	-32.70			peak
2	*	2408.880	83.35	-3.40	79.95	74.00	5.95			peak

IEEE 802.11b TX High:

Polarization: V

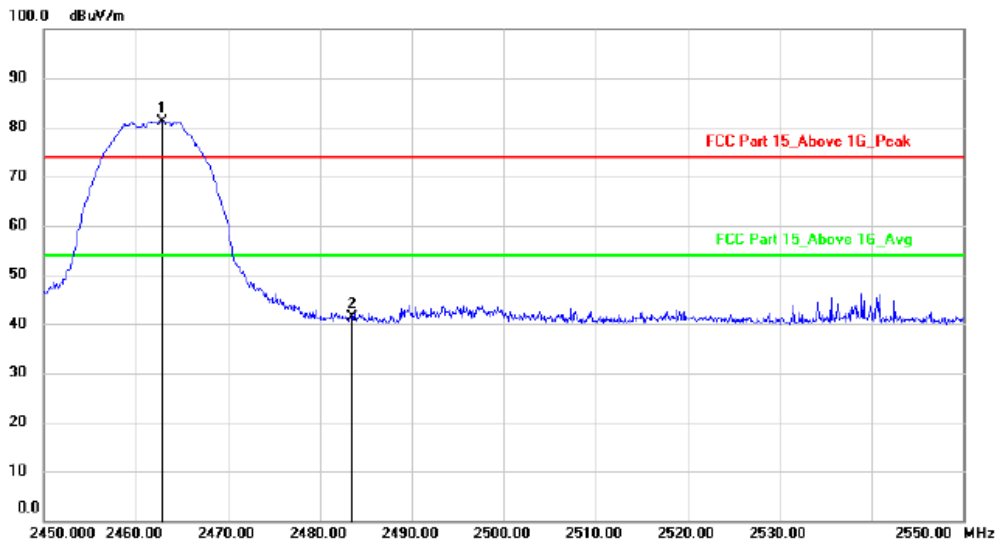

No.	Mk.	Freq.	Reading Level	Correct Factor	Measurement	Limit	Margin	Antenna Height	Table Degree	
		MHz	dBuV	dB	dBuV/m	dBuV/m	dB	cm	degree	Comment
1	*	2462.900	84.61	-3.40	81.21	74.00	7.21			peak
2		2483.500	44.75	-3.38	41.37	74.00	-32.63			peak

Polarization: H

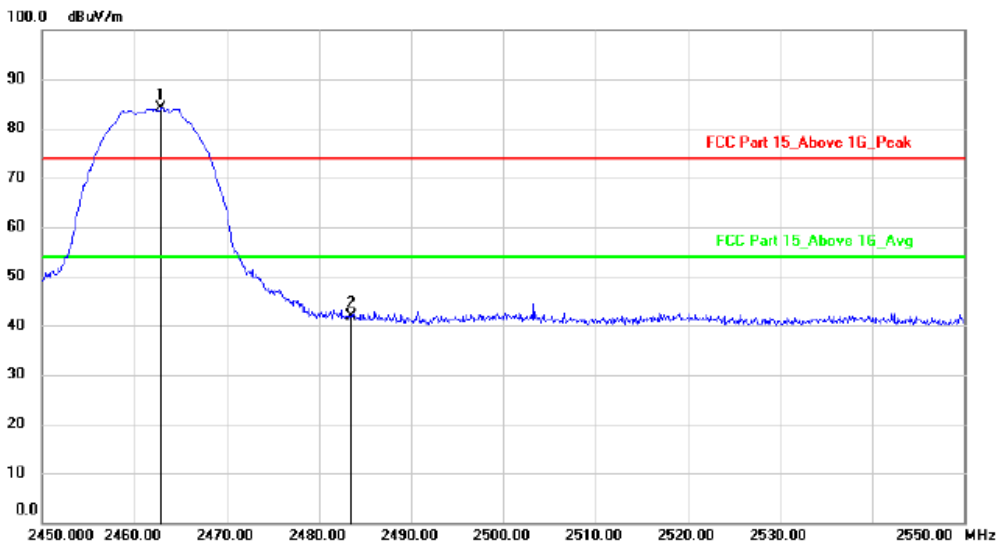

No.	Mk.	Freq.	Reading Level	Correct Factor	Measurement	Limit	Margin	Antenna Height	Table Degree	
		MHz	dBuV	dB	dBuV/m	dBuV/m	dB	cm	degree	Comment
1	*	2462.900	87.52	-3.40	84.12	74.00	10.12			peak
2		2483.500	45.30	-3.38	41.92	74.00	-32.08			peak

IEEE 802.11g TX Low:

Polarization: V

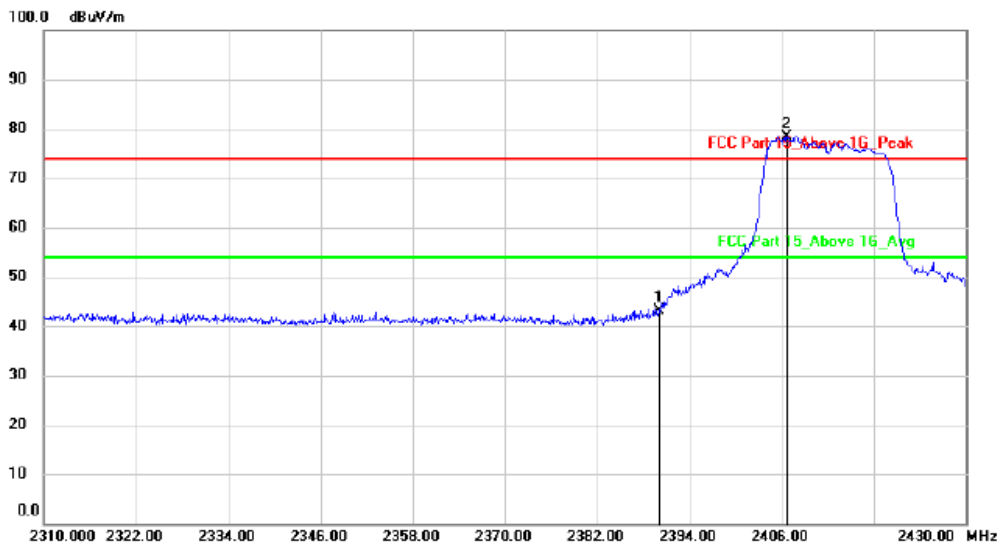

No.	Mk.	Freq.	Reading Level	Correct Factor	Measurement	Limit	Margin	Antenna Height	Table Degree	
		MHz	dBuV	dB	dBuV/m	dBuV/m	dB	cm	degree	Comment
1		2390.000	46.58	-3.40	43.18	74.00	-30.82			peak
2	*	2406.720	81.89	-3.41	78.48	74.00	4.48			peak

Polarization: H

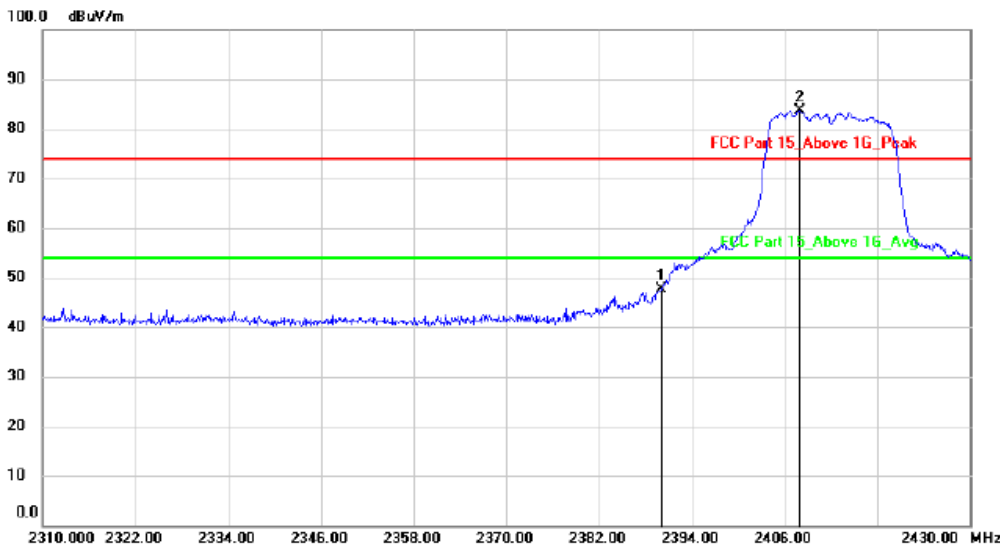

No.	Mk.	Freq.	Reading Level	Correct Factor	Measurement	Limit	Margin	Antenna Height	Table Degree	
		MHz	dBuV	dB	dBuV/m	dBuV/m	dB	cm	degree	Comment
1		2390.000	51.14	-3.40	47.74	74.00	-26.26			peak
2	*	2407.920	86.97	-3.40	83.57	74.00	9.57			peak

IEEE 802.11g TX High:

Polarization: V

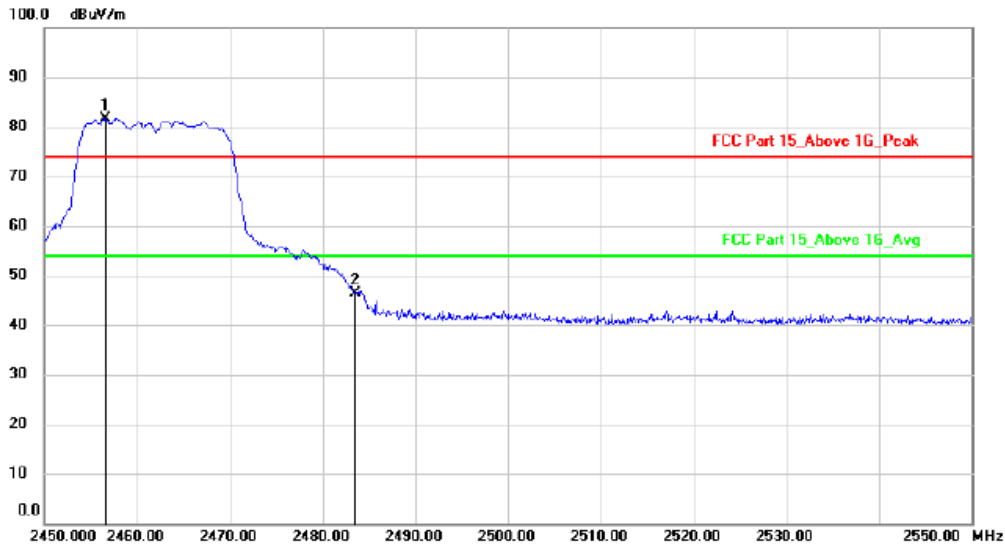

No.	Mk.	Freq.	Reading Level	Correct Factor	Measurement	Limit	Margin	Antenna Height	Table Degree
		MHz	dBuV	dB	dBuV/m	dBuV/m	dB	cm	degree
1	*	2456.600	84.98	-3.39	81.59	74.00	7.59	peak	
2		2483.500	49.75	-3.38	46.37	74.00	-27.63	peak	

Polarization: H

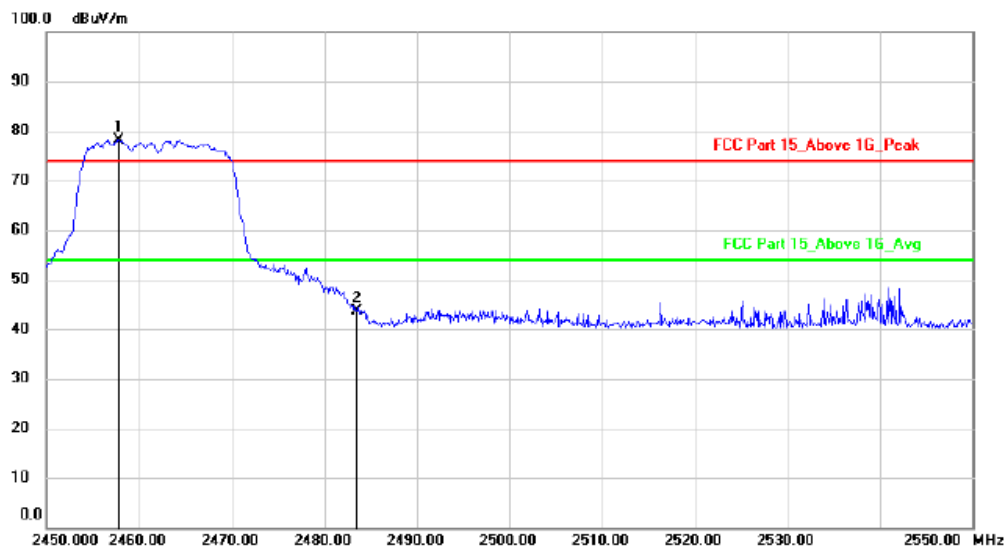

No.	Mk.	Freq.	Reading Level	Correct Factor	Measurement	Limit	Margin	Antenna Height	Table Degree
		MHz	dBuV	dB	dBuV/m	dBuV/m	dB	cm	degree
1	*	2457.800	81.58	-3.39	78.19	74.00	4.19	peak	
2		2483.500	47.01	-3.38	43.63	74.00	-30.37	peak	

IEEE 802.11n HT20TX Low:

Polarization: V

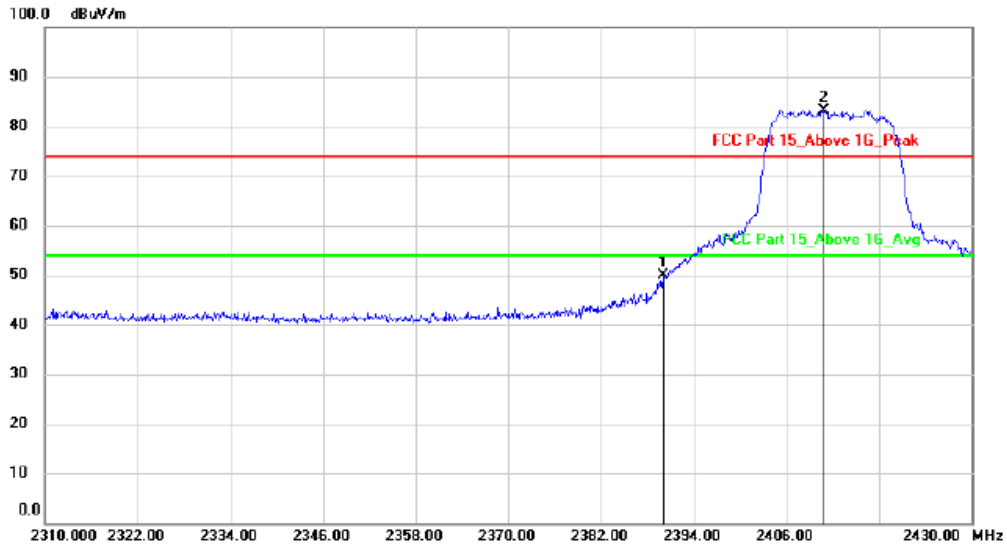

No.	Mk.	Freq.	Reading Level	Correct Factor	Measurement	Limit	Margin	Antenna Height	Table Degree	
		MHz	dBuV	dB	dBuV/m	dBuV/m	dB	cm	degree	Comment
1		2390.000	53.34	-3.40	49.94	74.00	-24.06			peak
2	*	2410.920	86.63	-3.40	83.23	74.00	9.23			peak

Polarization: H

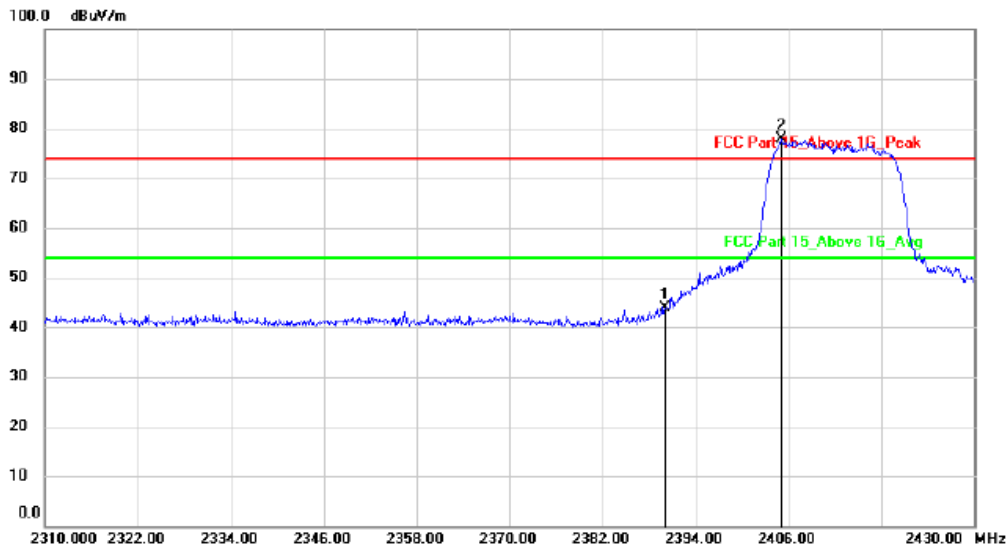

No.	Mk.	Freq.	Reading Level	Correct Factor	Measurement	Limit	Margin	Antenna Height	Table Degree	
		MHz	dBuV	dB	dBuV/m	dBuV/m	dB	cm	degree	Comment
1		2390.000	47.38	-3.40	43.98	74.00	-30.02			peak
2	*	2405.040	81.30	-3.41	77.89	74.00	3.89			peak

IEEE 802.11n HT20TX High:

Polarization: V

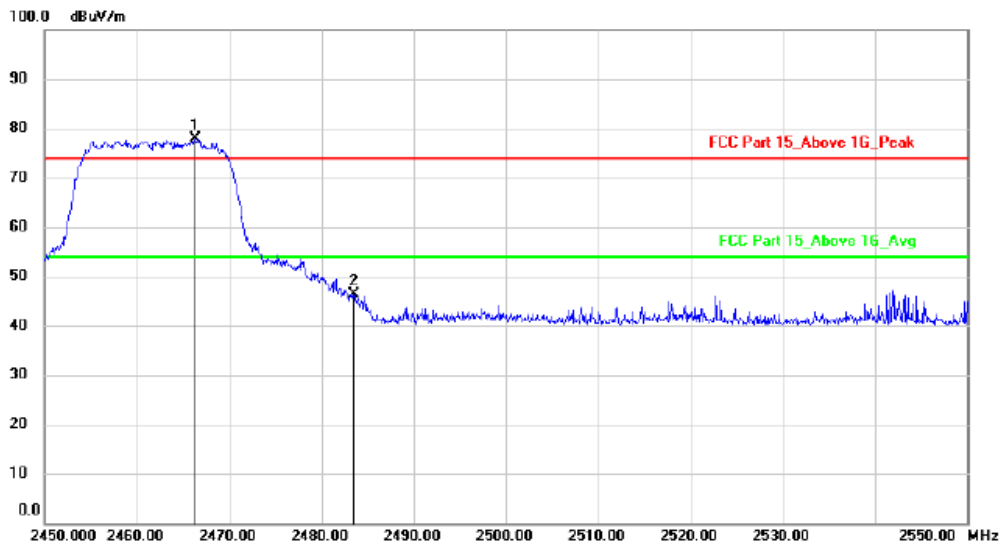

No.	Mk.	Freq. MHz	Reading Level dBuV	Correct Factor dB	Measure- ment dBuV/m	Limit dBuV/m	Margin dB	Detector	Antenna Height cm	Table Degree	Comment
1	*	2466.300	81.38	-3.39	77.99	74.00	3.99	peak			
2		2483.500	49.72	-3.38	46.34	74.00	-27.66	peak			

Polarization: H

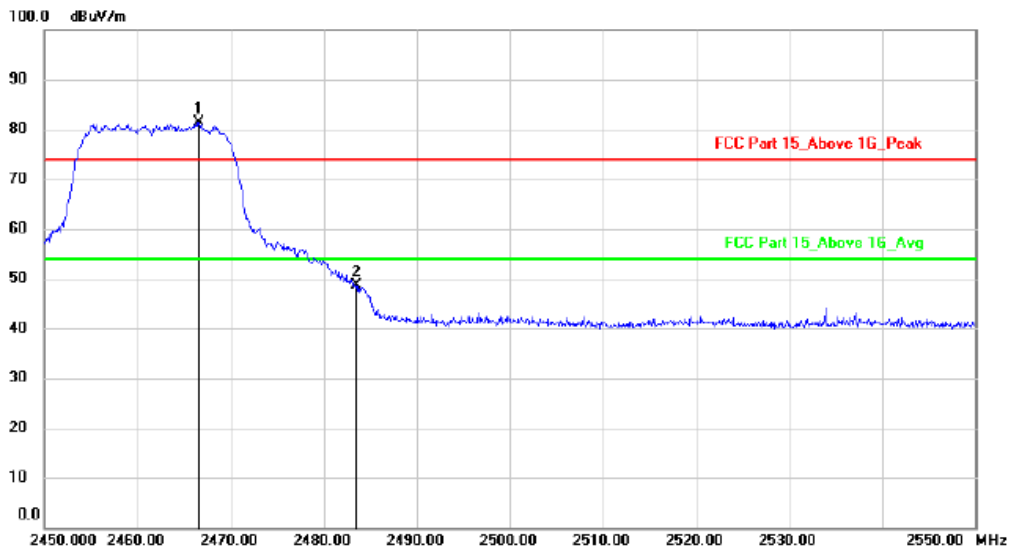

No.	Mk.	Freq. MHz	Reading Level dBuV	Correct Factor dB	Measure- ment dBuV/m	Limit dBuV/m	Margin dB	Detector	Antenna Height cm	Table Degree	Comment
1	*	2466.600	84.80	-3.39	81.41	74.00	7.41	peak			
2		2483.500	52.01	-3.38	48.63	74.00	-25.37	peak			

IEEE 802.11n HT40TX Low:

Polarization: V

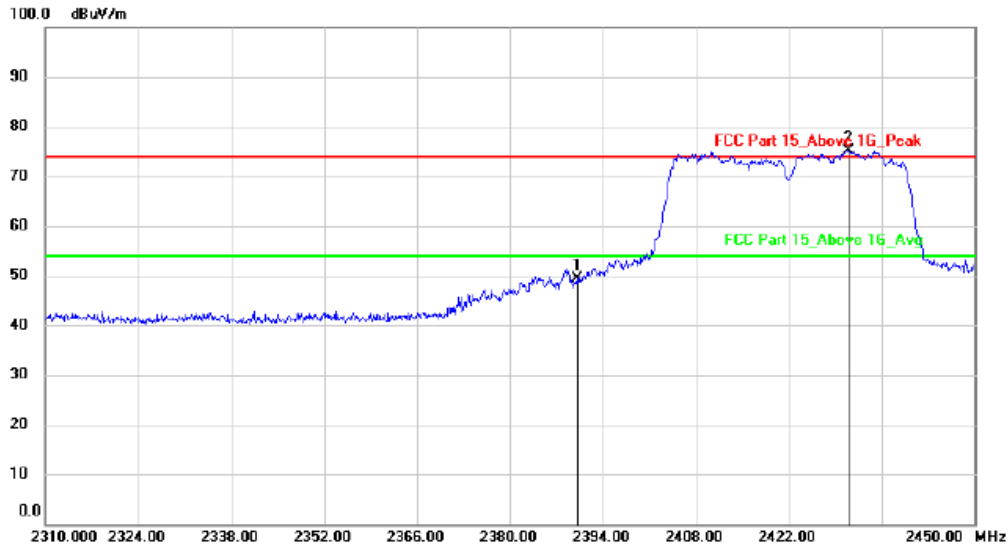

No.	Mk.	Freq.	Reading Level	Correct Factor	Measurement	Limit	Margin	Antenna Height	Table Degree	
		MHz	dBuV	dB	dBuV/m	dBuV/m	dB	cm	degree	Comment
1		2390.000	52.73	-3.40	49.33	74.00	-24.67	peak		
2	*	2430.960	78.63	-3.40	75.23	74.00	1.23	peak		

Polarization: H

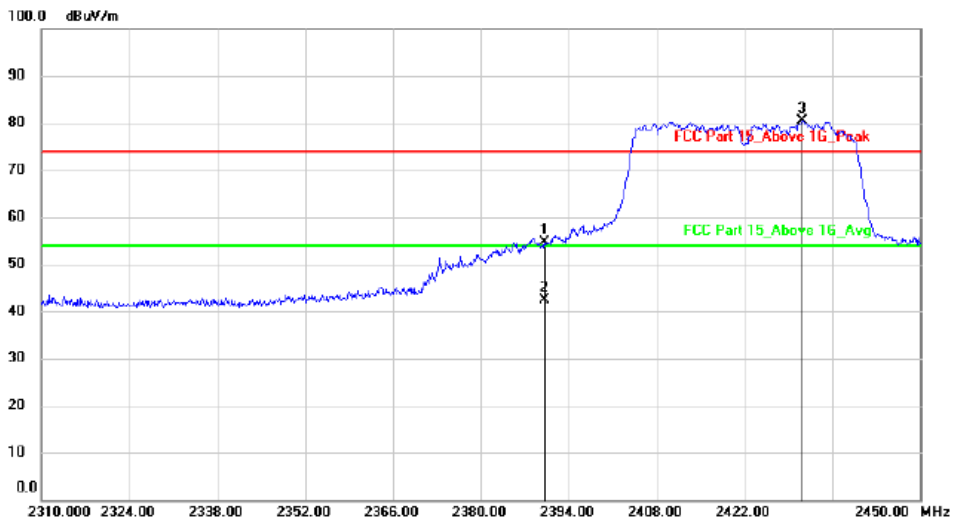

No.	Mk.	Freq.	Reading Level	Correct Factor	Measurement	Limit	Margin	Antenna Height	Table Degree	
		MHz	dBuV	dB	dBuV/m	dBuV/m	dB	cm	degree	Comment
1		2390.000	57.92	-3.40	54.52	74.00	-19.48	peak		
2		2390.000	45.81	-3.40	42.41	54.00	-11.59	AVG		
3	*	2431.240	83.86	-3.40	80.46	74.00	6.46	peak		

IEEE 802.11n HT40TX High:

Polarization: V

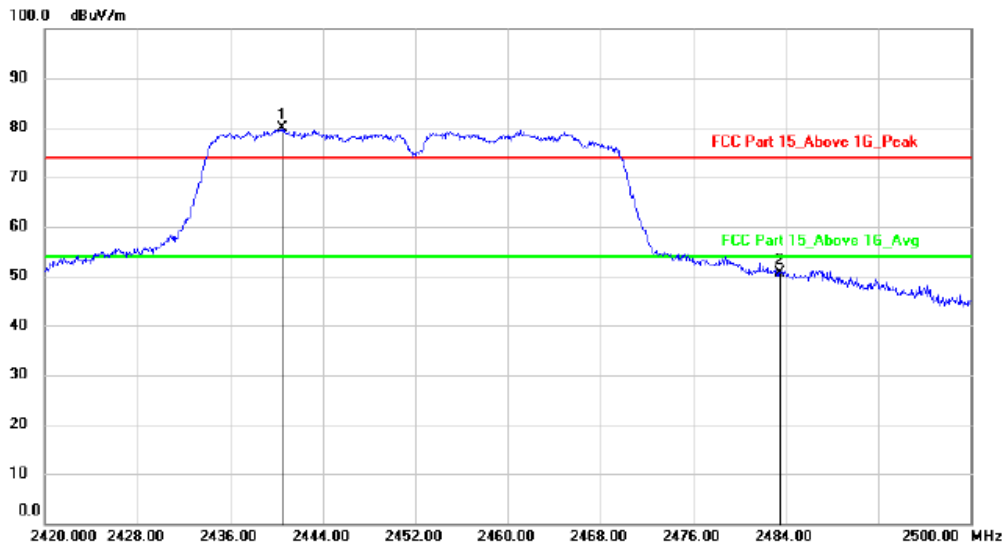

No.	Mk.	Freq.	Reading Level	Correct Factor	Measurement	Limit	Margin	Antenna Height	Table Degree	
		MHz	dBuV	dB	dBuV/m	dBuV/m	dB	cm	degree	Comment
1	*	2440.560	83.19	-3.40	79.79	74.00	5.79			peak
2		2483.500	54.05	-3.38	50.67	74.00	-23.33			peak

Polarization: H

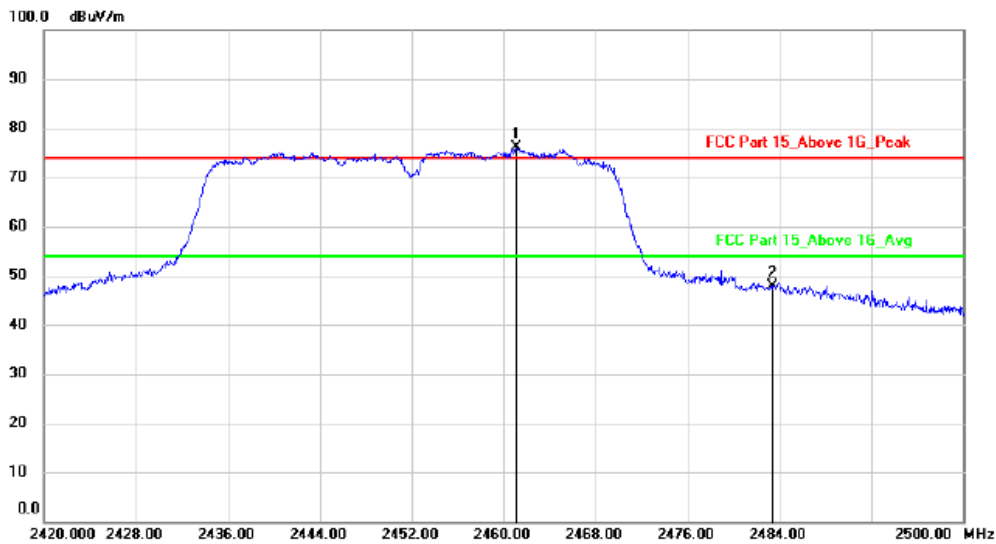

No.	Mk.	Freq.	Reading Level	Correct Factor	Measurement	Limit	Margin	Antenna Height	Table Degree	
		MHz	dBuV	dB	dBuV/m	dBuV/m	dB	cm	degree	Comment
1	*	2461.120	79.45	-3.39	76.06	74.00	2.06			peak
2		2483.500	51.15	-3.38	47.77	74.00	-26.23			peak

802.11n HT40



9. ANTENNA REQUIREMENT

9.1. Standard Requirement

An intentional radiator shall be designed to ensure that no antenna other than that furnished by the responsible party shall be used with the device. The use of a permanently attached antenna or of an antenna that uses a unique coupling to the intentional radiator shall be considered sufficient to comply with the provisions of this Section. The manufacturer may design the unit so that a broken antenna can be replaced by the user, but the use of a standard antenna jack or electrical connector is prohibited.

9.2. Antenna Connected Construction

The antenna is PCB antenna and no consideration of replacement. Please see EUT photo for details.

9.3. Results

The EUT antenna is PCB Antenna. It comply with the standard requirement.

Antenna connector type: ipex connector

10. TEST SETUP PHOTO

10.1. Photos of Radiated emission

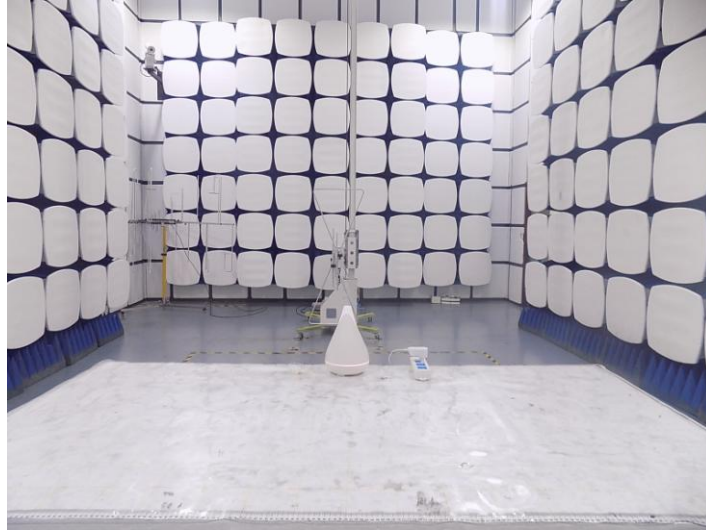

11.PHOTO OF EUT



-----THE END OF REPORT-----