



Report No.: EA21100184F03201

1 of 70

**ELECTROMAGNETIC EMISSIONS COMPLIANCE REPORT  
INTENTIONAL RADIATOR CERTIFICATION TO  
FCC PART 15 SUBPART C REQUIREMENT**

*OF*

**500LM Rechargeable Work Light with Bluetooth Speaker**

**Model No.: 7801 ,7802, 7803**

**Trademark: N/A**

**FCC ID: 2AMI2-7801**

**Report No.: EA21100184F03201**

**Issue Date: Oct. 21, 2021**

*Prepared for*

**Hangzhou Great Star Industrial Co., Ltd.  
No.35 Jiuhuan Road, Jianggan District, Hangzhou, Zhejiang Province,  
China**

*Prepared by*

**Dong Guan Anci Electronic Technology Co., Ltd.**

**1-2 Floor, Building A, No.11, Headquarters 2 Road, Songshan, Lake Hi-tech  
Industrial Development Zone, Dongguan City, Guangdong Pr., China.**

**This report shall not be reproduced, except in full, without the written approval of  
Dong Guan Anci Electronic Technology Co., Ltd.**



### VERIFICATION OF COMPLIANCE

|                      |   |
|----------------------|---|
| Applicant:           | Hangzhou Great Star Industrial Co., Ltd.<br>No.35 Jiuhan Road, Jianggan District, Hangzhou, Zhejiang Province, China      |
| Manufacturer:        | Hangzhou Great Star Industrial Co., Ltd.<br>No.35 Jiuhan Road, Jianggan District, Hangzhou, Zhejiang Province, China      |
| Product Description: | 500LM Rechargeable Work Light with Bluetooth Speaker  |
| Trade Mark:          | N/A   |
| Model Number:        | 7801 ,7802, 7803<br>(All models are identical except for the different shell colors. We choose model: 7801for all tests.) |

### We hereby certify that:

The above equipment was tested by Dong Guan Anci Electronic Technology Co., Ltd.The test data, data evaluation, test procedures, and equipment configurations shown in this report were made in accordance with the procedures given in ANSI C63.10-2013 and the energy emitted by the sample EUT tested as described in this report is in compliance with conducted and radiated emission limits of FCC Rules Part 15.247(2020).

Date of Test : Oct. 15, 2021 to Oct. 21, 2021

Prepared by : Tomas Yang/Supervisor

Reviewer & Authorized Signer : Alan He/Manager



### Modified Information

| Version | Summary         | Revision Date | Report No.       |
|---------|-----------------|---------------|------------------|
| Ver.1.0 | Original Report | /             | EA21100184F03201 |
|         |                 |               |                  |
|         |                 |               |                  |
|         |                 |               |                  |
|         |                 |               |                  |
|         |                 |               |                  |
|         |                 |               |                  |



### Table of Contents

- 1. GENERAL INFORMATION ..... 6**
  - 1.1 PRODUCT DESCRIPTION ..... 6
  - 1.2 TEST METHODOLOGY ..... 6
  - 1.3 TEST FACILITY ..... 7
- 2. SYSTEM TEST CONFIGURATION..... 8**
  - 2.1 EUT CONFIGURATION ..... 8
  - 2.2 EUT EXERCISE..... 8
  - 2.3 TEST PROCEDURE..... 8
  - 2.4 CONFIGURATION OF TESTED SYSTEM..... 9
- 3. SUMMARY OF TEST RESULTS..... 10**
- 4. DESCRIPTION OF TEST MODES ..... 11**
- 5. TEST SYSTEM UNCERTAINTY ..... 12**
- 6. CONDUCTED EMISSIONS TEST ..... 13**
  - 6.1 MEASUREMENT PROCEDURE: ..... 13
  - 6.2 TEST SET-UP (BLOCK DIAGRAM OF CONFIGURATION) ..... 13
  - 6.3 MEASUREMENT EQUIPMENT USED: ..... 13
  - 6.4 MEASUREMENT RESULT: ..... 13
  - CONDUCTED MEASUREMENT PHOTOS: ..... 15
  - 6.5 CONDUCTED MEASUREMENT PHOTOS: ..... 16
- 7. RADIATED EMISSION TEST ..... 17**
  - 7.1 MEASUREMENT PROCEDURE ..... 17
  - 7.2 TEST SET-UP (BLOCK DIAGRAM OF CONFIGURATION) ..... 19
  - 7.3 MEASUREMENT EQUIPMENT USED: ..... 20
  - 7.4 RADIATED EMISSION LIMIT ..... 21
  - 7.5 MEASUREMENT RESULT ..... 22
  - 7.5 RADIATED MEASUREMENT PHOTOS: ..... 29
- 8. CHANNEL SEPARATION TEST ..... 30**
  - 8.1 MEASUREMENT PROCEDURE ..... 30
  - 8.2 TEST SET-UP (BLOCK DIAGRAM OF CONFIGURATION) ..... 30
  - 8.3 MEASUREMENT EQUIPMENT USED: ..... 30
  - 8.4 MEASUREMENT RESULTS: ..... 30
- 9. 20DB BANDWIDTH TEST ..... 35**
  - 9.1 MEASUREMENT PROCEDURE ..... 35
  - 9.2 TEST SET-UP (BLOCK DIAGRAM OF CONFIGURATION) ..... 35
  - 9.3 MEASUREMENT EQUIPMENT USED: ..... 35
  - 9.4 MEASUREMENT RESULTS: ..... 35



**10. QUANTITY OF HOPPING CHANNEL TEST ..... 40**

- 10.1 MEASUREMENT PROCEDURE ..... 40
- 10.2 TEST SET-UP (BLOCK DIAGRAM OF CONFIGURATION) ..... 40
- 10.3 MEASUREMENT EQUIPMENT USED: ..... 40
- 10.4 MEASUREMENT RESULTS: ..... 40

**11. TIME OF OCCUPANCY (DWELL TIME) TEST ..... 41**

- 11.1 TEST DESCRIPTION ..... 41
- 11.2 TEST SET-UP (BLOCK DIAGRAM OF CONFIGURATION) ..... 41
- 11.3 MEASUREMENT EQUIPMENT USED: ..... 41
- 11.4 TEST REQUIREMENTS / LIMITS ..... 41
- 11.5 TEST RESULT ..... 42

**12. MAXIMUM PEAK OUTPUT POWER TEST ..... 44**

- 12.1 MEASUREMENT PROCEDURE ..... 44
- 12.2 TEST SET-UP (BLOCK DIAGRAM OF CONFIGURATION) ..... 44
- 12.3 MEASUREMENT EQUIPMENT USED: ..... 44
- 12.4 MEASUREMENT RESULTS: ..... 45

**13. BAND EDGE TEST ..... 49**

- 13.1 MEASUREMENT PROCEDURE ..... 49
- 13.2 TEST SET-UP (BLOCK DIAGRAM OF CONFIGURATION) ..... 50
- 13.3 MEASUREMENT EQUIPMENT USED: ..... 50
- 13.4 MEASUREMENT RESULTS: ..... 51

**14. ANTENNA APPLICATION ..... 64**

- 14.1 ANTENNA REQUIREMENT ..... 64
- 14.2 RESULT ..... 64

APPENDIX (PHOTOS OF EUT) (8 PAGES)



## 1. GENERAL INFORMATION

### 1.1 Product Description

| Characteristics           | Description  |
|---------------------------|--|
| Product Name              | 500LM Rechargeable Work Light with Bluetooth Speaker |
| Model number              | 7801   |
| Input rating              | DC 5V, 1A  |
| Power Supply              | DC 5V form adapter and 3.7V from battery             |
| Kind of Device            | Bluetooth Ver. 5.0                                   |
| Modulation                | GFSK, $\pi/4$ -DQPSK                                 |
| Operating Frequency Range | 2402-2480MHz   |
| Number of Channels        | 79   |
| Transmit Power Max(PK)    | 6.52dBm(0.0045W)                                     |
| Antenna Type              | Internal PCB antenna                                 |
| Antenna Gain              | -0.58dBi   |

### 1.2 Test Methodology

Both conducted and radiated testing was performed according to the procedures in ANSI C63.10-2013. Radiated testing was performed at an antenna to EUT distance 3 meters.



### 1.3 Test Facility

#### Site Description

EMC Lab. : Accredited by CNAS, 2017.06.26  
The certificate is valid until 2022.10.28  
The Laboratory has been assessed and proved to be in compliance with CNAS-CL01:2018 (identical to ISO/IEC 17025:2017)  
The Certificate Registration Number is L6214.

Accredited by A2LA, 2018.03.15  
The Certificate Number is 4422.01.

Name of Firm : Dong Guan Anci Electronic Technology Co., Ltd.

Site Location : 1-2 Floor, Building A, No.11, Headquarters 2 Road, Songshan, Lake Hi-tech Industrial Development Zone, Dongguan City, Guangdong Pr., China.

## **2. System Test Configuration**

### **2.1 EUT Configuration**

The EUT configuration for testing is installed on RF field strength measurement to meet the Commissions requirement and operating in a manner which intends to maximize its emission characteristics in a continuous normal application.

### **2.2 EUT Exercise**

The Transmitter was operated in the normal operating mode. The Tx frequency was fixed which was for the purpose of the measurements.

### **2.3 Test Procedure**

#### **2.3.1 Conducted Emissions**

The EUT is placed on a turn table which is 0.8 m above ground plane. According to the requirements in Section 13.1.4.1 of ANSI C63.10-2013. Conducted emissions from the EUT measured in the frequency range between 0.15 MHz and 30MHz using CISPR Quasi-Peak and average detector mode.

#### **2.3.2 Radiated Emissions**

Below 1000MHz, The EUT was placed on a turn table which is 0.8m above ground plane. And above 1000MHz, The EUT was placed on a styrofoam table which is 1.5m above ground plane. The turn table shall rotate 360 degrees to determine the position of maximum emission level. EUT is set 3m away from the receiving antenna which varied from 1m to 4m to find out the highest emission. And also, each emission was to be maximized by changing the polarization of receiving antenna both horizontal and vertical. In order to find out the max. emission, the relative positions of EUT was fixed in a particular direction according to the requirements in Section 13.1.4.1 of ANSI C63.10-2013.



## 2.4 Configuration of Tested System

**Fig. 2-1 Configuration of Tested System**

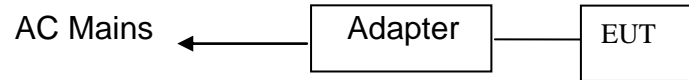

Table 2-1 Equipment Used in Tested System

| Item | Equipment  | Trademark | Model No.   | FCC ID     | Note                     |
|------|--|-----------|---|------------|--------------------------|
| 1.   | 500LM Rechargeable Work Light with Bluetooth Speaker | N/A       | 7801  | 2AMI2-7801 | <i>EUT</i>               |
| 2.   | Adapter  | N/A       | Model: PS06C050K2000U<br>Input: AC 100-240V~50/60Hz,<br>0.3A Max<br>Output: DC 5V, 1A | N/A        | <i>Support Equipment</i> |

**Note:**

- (1) Unless otherwise denoted as EUT in 『Remark』 column , device(s) used in tested system is a support equipment.



### 3. Summary of Test Results

| <b>FCC Rules</b>   | <b>Description Of Test</b>    | <b>Result</b> |
|--------------------|-------------------------------|---------------|
| §15.207            | AC Power Conducted Emission   | Compliant     |
| §15.247(d),§15.209 | Radiated Emission             | Compliant     |
| §15.247(a)(1)      | Channel Separation test       | Compliant     |
| §15.247(a)(1)      | 20dB Bandwidth                | Compliant     |
| §15.247(a)(1)(iii) | Quantity of Hopping Channel   | Compliant     |
| §15.247(a)(1)(iii) | Time of Occupancy(Dwell Time) | Compliant     |
| §15.247(b)         | Max Peak output Power test    | Compliant     |
| §15.247(d)         | Band edge test                | Compliant     |
| §15.203            | Antenna Requirement           | Compliant     |

Remark: The product was tested under the battery fully charged.

#### 4. Description of test modes

The EUT has been tested under its typical operating condition and fully-charged battery for EUT tested alone. Pre-defined engineering program for regulatory testing used to control the EUT for staying in continuous transmitting. Only the worst case data were reported.

The EUT has been associated with peripherals pursuant to ANSI C63.10-2013 and configuration operated in a manner tended to maximize its emission characteristics in a typical application. Frequency range investigated: radiation (9 KHz to the 10th harmonics of the highest fundamental frequency or to 40 GHz, whichever is lower).

The EUT has been tested under TX operating condition.

This EUT is a FHSS system, were conducted to determine the final configuration from all possible combinations. We use software control the EUT, Let EUT hopping on and transmit with highest power, all the modes GFSK,  $\pi/4$ -DQPSK have been tested. 79 Channels are provided by EUT. The 3 channels of lower, medium and higher were chosen for test.

| Channel | Frequency(MHz) |
|---------|----------------|
| 1       | 2402           |
| 40      | 2441           |
| 79      | 2480           |



### 5. TEST SYSTEM UNCERTAINTY

The following measurement uncertainty levels have been estimated for tests performed on the apparatus:

| Parameter                      | Uncertainty             |
|--------------------------------|-------------------------|
| Radio Frequency                | $\pm 1 \times 10^{-5}$  |
| Maximum Peak Output Power Test | $\pm 1.0\text{dB}$      |
| Conducted Emissions Test       | $\pm 2.0\text{dB}$      |
| Radiated Emission Test         | $\pm 2.0\text{dB}$      |
| Power Density                  | $\pm 2.0\text{dB}$      |
| Occupied Bandwidth Test        | $\pm 1.0\text{dB}$      |
| Band Edge Test                 | $\pm 3\text{dB}$        |
| All emission, radiated         | $\pm 3\text{dB}$        |
| Antenna Port Emission          | $\pm 3\text{dB}$        |
| Temperature                    | $\pm 0.5^\circ\text{C}$ |
| Humidity                       | $\pm 3\%$               |

Remark: The coverage Factor ( $k=2$ ), and measurement Uncertainty for a level of Confidence of 95%

## 6. Conducted Emissions Test

### 6.1 Measurement Procedure:

1. The EUT was placed on a table, which is 0.8m above ground plane.
2. Maximum procedure was performed on the six highest emissions to ensure EUT compliance.
3. Repeat above procedures until all frequency measured was complete.

### 6.2 Test SET-UP (Block Diagram of Configuration)

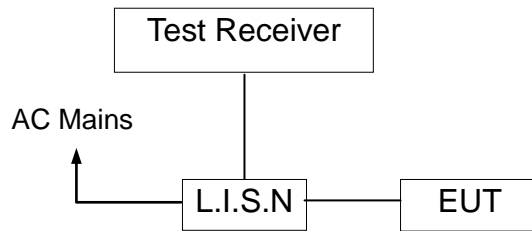

### 6.3 Measurement Equipment Used:

| EQUIPMENT TYPE    | MFR           | MODEL NUMBER | SERIAL NUMBER | Calibrated until |
|-------------------|---------------|--------------|---------------|------------------|
| L.I.S.N           | SCHWARZBECK   | NSLK 8127    | 8127-669      | 2022-05-22       |
| 10 db attenuator  | JFW           | 50FP-010-H4  | 4360846-427-1 | 2022-05-22       |
| RF Cable          | N/A           | N/A          | 2#            | 2022-05-22       |
| EMI Test Receiver | ROHDE&SCHWARZ | ESCI         | 101358        | 2022-05-22       |

### 6.4 Measurement Result:

Operation Mode: TX                      Test Date : Oct. 21, 2021  
 Frequency Range: 0.15MHz~30MHz      Temperature : 24°C  
 Test Result: PASS                      Humidity : 58 %  
 Test By: Zero

All the modulation modes were tested the data of the worst mode (  $\pi/4$ -DQPS TX 2441MHz) are recorded in the following pages and the others modulation methods do not exceed the limits.

Please refer to the following data.

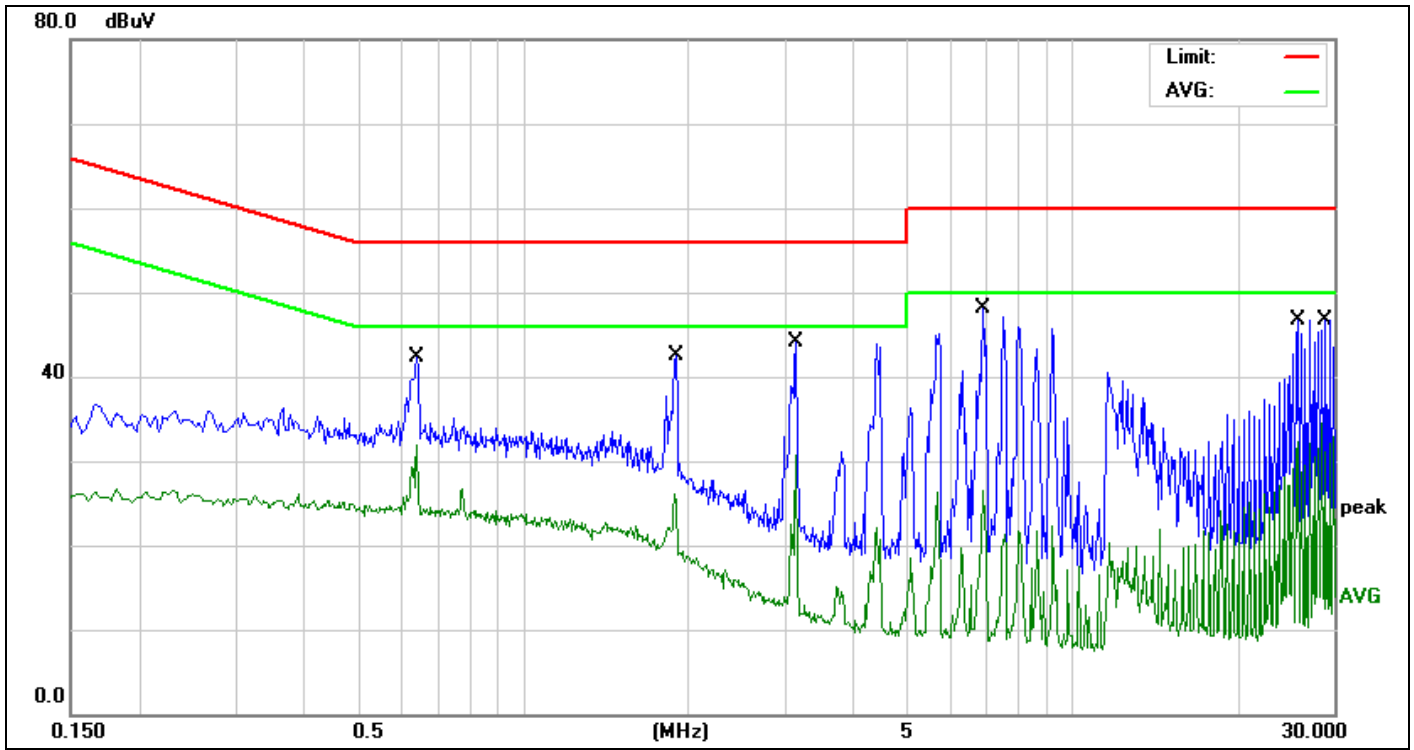

|        |  |                |              |                 |       |
|--------|--|----------------|--------------|-----------------|-------|
| Site:  | 843  | Phase:         | L1           | Temperature(C): | 26(C) |
| Limit: | FCC Part 15 C Conduction(QP)                         | Test Time:     |              | Humidity(%):    | 60%   |
| EUT:   | 500LM Rechargeable Work Light with Bluetooth Speaker | Power Rating:  | AC 120V/60Hz | Note:           |       |
| M/N.:  | 7801   | Test Engineer: | Jack         |                 |       |
| Mode:  | TX2441   |                |              |                 |       |

| No. | Frequency (MHz) | Reading Level(dBuV) | Factor (dB) | Measurement(dBuV) | Limit (dBuV) | Over (dB) | Detector | Comment |
|-----|-----------------|---------------------|-------------|-------------------|--------------|-----------|----------|---------|
| 1   | 0.6419          | 28.07               | 9.75        | 37.82             | 56.00        | -18.18    | QP       |         |
| 2   | 0.6419          | 18.20               | 9.75        | 27.95             | 46.00        | -18.05    | AVG      |         |
| 3   | 1.8980          | 20.60               | 9.85        | 30.45             | 56.00        | -25.55    | QP       |         |
| 4   | 1.8980          | 16.26               | 9.85        | 26.11             | 46.00        | -19.89    | AVG      |         |
| 5   | 3.1460          | 21.02               | 9.86        | 30.88             | 56.00        | -25.12    | QP       |         |
| 6 * | 3.1460          | 20.89               | 9.86        | 30.75             | 46.00        | -15.25    | AVG      |         |
| 7   | 6.8980          | 17.99               | 9.99        | 27.98             | 60.00        | -32.02    | QP       |         |
| 8   | 6.8980          | 16.44               | 9.99        | 26.43             | 50.00        | -23.57    | AVG      |         |
| 9   | 25.7340         | 27.54               | 10.20       | 37.74             | 60.00        | -22.26    | QP       |         |
| 10  | 25.7340         | 22.16               | 10.20       | 32.36             | 50.00        | -17.64    | AVG      |         |
| 11  | 28.9940         | 30.37               | 10.25       | 40.62             | 60.00        | -19.38    | QP       |         |
| 12  | 28.9940         | 24.18               | 10.25       | 34.43             | 50.00        | -15.57    | AVG      |         |

\*:Maximum data x:Over limit !:over margin

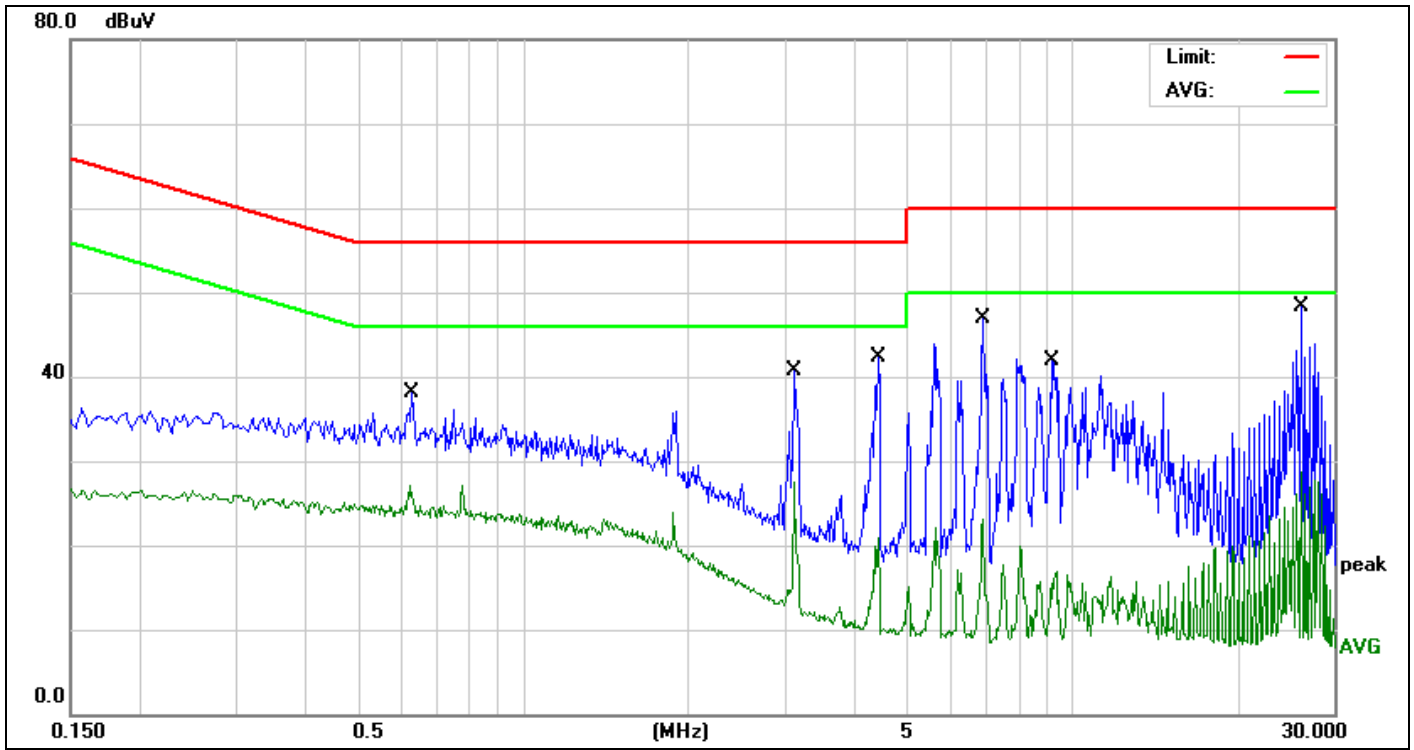

|               |  |                      |   |                        |       |
|---------------|--|----------------------|---|------------------------|-------|
| <b>Site:</b>  | 843  | <b>Phase:</b>        | N | <b>Temperature(C):</b> | 26(C) |
| <b>Limit:</b> | FCC Part 15 C Conduction(QP)                         | <b>Test Time:</b>    |   | <b>Humidity(%):</b>    | 60%   |
| <b>EUT:</b>   | 500LM Rechargeable Work Light with Bluetooth Speaker | <b>Power Rating:</b> |   | <b>Test Engineer:</b>  | Jack  |
| <b>M/N.:</b>  | 7801   |                      |   |                        |       |
| <b>Mode:</b>  | TX2441   |                      |   |                        |       |
| <b>Note:</b>  |  |                      |   |                        |       |

| No. | Frequency (MHz) | Reading Level(dBuV) | Factor (dB) | Measurement(dBuV) | Limit (dBuV) | Over (dB) | Detector | Comment |
|-----|-----------------|---------------------|-------------|-------------------|--------------|-----------|----------|---------|
| 1   | 0.6300          | 23.13               | 9.75        | 32.88             | 56.00        | -23.12    | QP       |         |
| 2 * | 0.6300          | 16.63               | 9.75        | 26.38             | 46.00        | -19.62    | AVG      |         |
| 3   | 3.1260          | 16.61               | 9.86        | 26.47             | 56.00        | -29.53    | QP       |         |
| 4   | 3.1260          | 4.72                | 9.86        | 14.58             | 46.00        | -31.42    | AVG      |         |
| 5   | 4.4420          | 22.74               | 9.91        | 32.65             | 56.00        | -23.35    | QP       |         |
| 6   | 4.4420          | 4.47                | 9.91        | 14.38             | 46.00        | -31.62    | AVG      |         |
| 7   | 6.8860          | 23.43               | 9.99        | 33.42             | 60.00        | -26.58    | QP       |         |
| 8   | 6.8860          | 6.20                | 9.99        | 16.19             | 50.00        | -33.81    | AVG      |         |
| 9   | 9.1860          | 13.83               | 10.08       | 23.91             | 60.00        | -36.09    | QP       |         |
| 10  | 9.1860          | 0.94                | 10.08       | 11.02             | 50.00        | -38.98    | AVG      |         |
| 11  | 26.1780         | 28.80               | 10.20       | 39.00             | 60.00        | -21.00    | QP       |         |
| 12  | 26.1780         | 18.57               | 10.20       | 28.77             | 50.00        | -21.23    | AVG      |         |

\*:Maximum data x:Over limit !:over margin

**6.5 Conducted Measurement Photos:**





## 7. Radiated Emission Test

### 7.1 Measurement Procedure

1. The testing follows the guidelines in Spurious Radiated Emissions of ANSI C63.10-2013.
2. Below 1000MHz, The EUT was placed on a turn table which is 0.8m above ground plane. And above 1000MHz, The EUT was placed on a styrofoam table which is 1.5m above ground plane.
3. The EUT was set 3 meters from the interference receiving antenna, which was mounted on the top of a variable height antenna tower.
4. For each suspected emission, the EUT was arranged to its worst case and then tune the Antenna tower (From 1m to 4m) and turntable (from 0 degree to 360 degree) to find the maximum reading. A pre-amp and a high pass filter are used for the test in order to get better signal level to comply with the guidelines.
5. Set to the maximum power setting and enable the EUT transmit continuously.
6. Final measurement (Above 1GHz): The frequency range will be divided into different sub ranges depending of the frequency range of the used horn antenna. The EMI Receiver set to peak and average mode and a resolution bandwidth of 1MHz. The measurement will be performed in horizontal and vertical polarization of the measuring antenna and while rotating the EUT in its vertical axis in the range of 0 degree to 360 degree in order to have the antenna inside the cone of radiation.
7. Test Procedure of measurement (For Above 1GHz):
  - 1) Monitor the frequency range at horizontal polarization and move the antenna over all sides of the EUT(if necessary move the EUT to another orthogonal axis).
  - 2) Change the antenna polarization and repeat 1) with vertical polarization.
  - 3) Make a hardcopy of the spectrum.
  - 4) Measure the frequency of the detected emissions with a lower span and resolution bandwidth to increase the accuracy and note the frequency value.
  - 5) Change the analyser mode to Clear/ Write and found the cone of emission.
  - 6) Rotate and move the EUT, so that the measuring distance can be enlarged to 3m and the antenna will be still inside the cone of emission.
  - 7) Measure the level of the detected frequency with the correct resolution bandwidth, with the antenna polarization and azimuth and the peak and average detector, which causes the maximum emission.
  - 8) Repeat steps 1) to 7) for the next antenna spot if the EUT is larger than the antenna beamwidth.



Use the following spectrum analyzer settings:

When spectrum scanned from 30MHz to 1GHz setting resolution bandwidth 120KHz and video bandwidth 300KHz:

| EMI Test Receiver | Setting  |
|-------------------|----------|
| Attenuation       | Auto     |
| RB                | 120KHz   |
| VB                | 300KHz   |
| Detector          | QP       |
| Trace             | Max hold |

When spectrum scanned above 1GHz setting resolution bandwidth 1MHz, video bandwidth 3MHz:

| EMI Test Receiver | Setting  |
|-------------------|----------|
| Attenuation       | Auto     |
| RB                | 1MHz     |
| VB                | 3MHz     |
| Detector          | Peak     |
| Trace             | Max hold |

When spectrum scanned above 1GHz setting resolution bandwidth 1MHz, video bandwidth 10Hz:

| EMI Test Receiver | Setting  |
|-------------------|----------|
| Attenuation       | Auto     |
| RB                | 1MHz     |
| VB                | 10Hz     |
| Detector          | Peak     |
| Trace             | Max hold |

## 7.2 Test SET-UP (Block Diagram of Configuration)

(A) Radiated Emission Test Set-Up, Frequency Below 30MHz

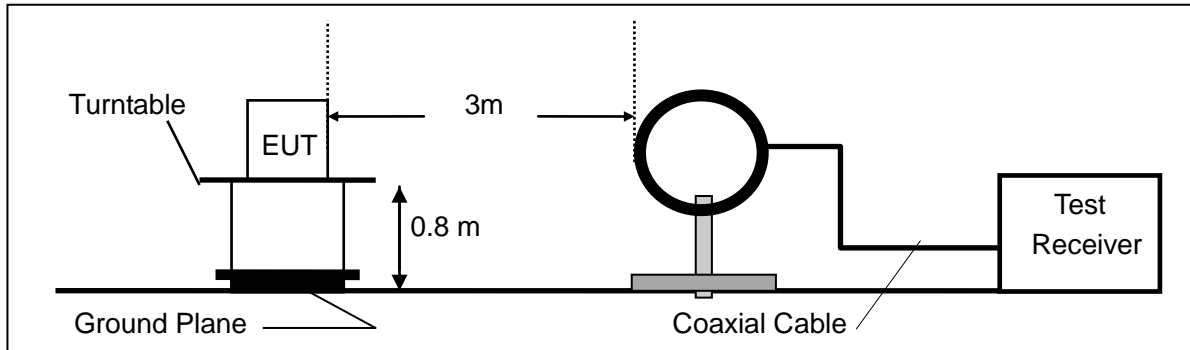

(B) Radiated Emission Test Set-Up, Frequency Below 1000MHz

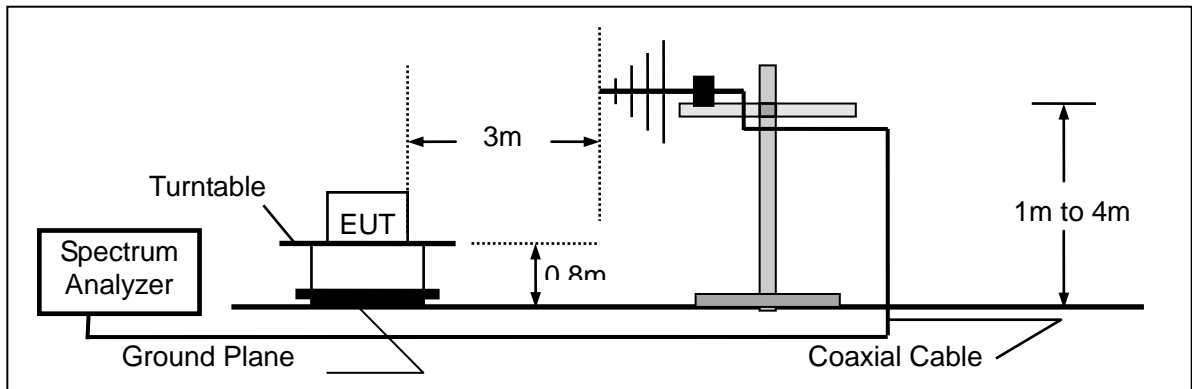

(C) Radiated Emission Test Set-Up, Frequency above 1000MHz

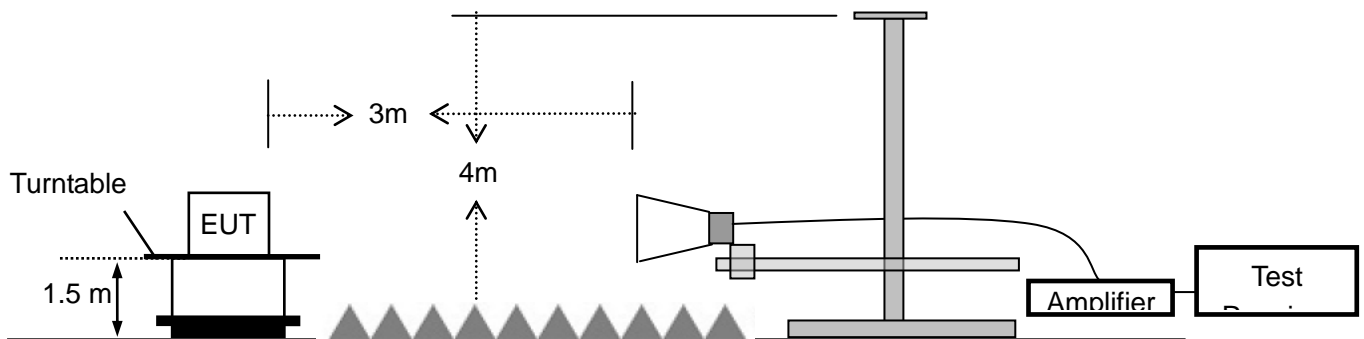

### 7.3 Measurement Equipment Used:

| Item | Equipment                    | Manufacturer       | Model No.                 | Serial No.         | Calibrated until |
|------|------------------------------|--------------------|---------------------------|--------------------|------------------|
| 1.   | EMI Test Receiver            | Rohde & Schwarz    | ESPI                      | 100502             | 2021-11-19       |
| 2.   | Pre-Amplifier                | HP                 | 8447D                     | 2727A06172         | 2022-05-22       |
| 3.   | Bilog Antenna                | Schwarzbeck        | VULB9163                  | VULB9163-588       | 2022-05-22       |
| 4.   | Loop Antenna                 | Schwarzbeck        | FMZB 1516                 | 1516-141           | 2021-11-19       |
| 5.   | Spectrum Analyzer            | Rohde & Schwarz    | FSV40                     | US40240623         | 2021-11-19       |
| 6.   | Low noise Amplifiers         | A-INFO             | LA1018N4009               | J101313052400<br>1 | 2022-05-22       |
| 7.   | Horn antenna                 | A-INFO             | LB-10180-SF               | J203109061212<br>3 | 2022-05-22       |
| 8.   | Broadband RF Power Amplifier | AEROFLEX           | AEROFLEX10<br>0KHz-40GHz  | J101313052400<br>1 | 2021-11-19       |
| 9.   | DRG Horn Antenna             | A.H.SYSTEMS        | SAS-574                   | J203109061212<br>3 | 2021-11-19       |
| 10.  | RF Cable                     | Gigalink Microwave | ZT40-2.92J-2.<br>92J-2m   | N/A                | 2021-11-19       |
| 11.  | RF Cable                     | Gigalink Microwave | ZT40-2.92J-2.<br>92J-0.3m | N/A                | 2021-11-19       |
| 12.  | RF Cable                     | N/A                | N/A                       | 6#                 | 2022-05-21       |
| 13.  | RF Cable                     | N/A                | N/A                       | 1-1#               | 2022-05-21       |
| 14.  | RF Cable                     | N/A                | N/A                       | 1-2#               | 2022-05-21       |
| 15.  | RF Cable                     | N/A                | N/A                       | 7#                 | 2022-05-21       |
| 16.  | 3m Semi-anechoic Chamber     | chengyu            | 9m*6m*6m                  | N/A                | 2022-05-22       |
| 17.  | Test Software                | Farad              | EZ-EMC<br>Ver:ANCI-3A1    | N/A                | N/A              |

### 7.4 Radiated Emission Limit

The emissions from an intentional radiator shall not exceed the field strength levels specified in the following table 15.209(a):

| Frequencies (MHz) | Field Strength (micorvolts/meter) | Measurement Distance (meters) |
|-------------------|-----------------------------------|-------------------------------|
| 0.009~0.490       | 2400/F(KHz)                       | 300                           |
| 0.490~1.705       | 24000/F(KHz)                      | 30                            |
| 1.705~30.0        | 30                                | 30                            |
| 30~88             | 100                               | 3                             |
| 88~216            | 150                               | 3                             |
| 216~960           | 200                               | 3                             |
| Above 960         | 500                               | 3                             |

### 15.205 Restricted bands of operation

| MHz                        | MHz                   | MHz             | GHz           |
|----------------------------|-----------------------|-----------------|---------------|
| 0.090 - 0.110              | 16.42 - 16.423        | 399.9 - 410     | 4.5 - 5.15    |
| <sup>1</sup> 0.495 - 0.505 | 16.69475 - 16.69525   | 608 - 614       | 5.35 - 5.46   |
| 2.1735 - 2.1905            | 16.80425 - 16.80475   | 960 - 1240      | 7.25 - 7.75   |
| 4.125 - 4.128              | 25.5 - 25.67          | 1300 - 1427     | 8.025 - 8.5   |
| 4.17725 - 4.17775          | 37.5 - 38.25          | 1435 - 1626.5   | 9.0 - 9.2     |
| 4.20725 - 4.20775          | 73 - 74.6             | 1645.5 - 1646.5 | 9.3 - 9.5     |
| 6.215 - 6.218              | 74.8 - 75.2           | 1660 - 1710     | 10.6 - 12.7   |
| 6.26775 - 6.26825          | 108 - 121.94          | 1718.8 - 1722.2 | 13.25 - 13.4  |
| 6.31175 - 6.31225          | 123 - 138             | 2200 - 2300     | 14.47 - 14.5  |
| 8.291 - 8.294              | 149.9 - 150.05        | 2310 - 2390     | 15.35 - 16.2  |
| 8.362 - 8.366              | 156.52475 - 156.52525 | 2483.5 - 2500   | 17.7 - 21.4   |
| 8.37625 - 8.38675          | 156.7 - 156.9         | 2690 - 2900     | 22.01 - 23.12 |
| 8.41425 - 8.41475          | 162.0125 - 167.17     | 3260 - 3267     | 23.6 - 24.0   |
| 12.29 - 12.293             | 167.72 - 173.2        | 3332 - 3339     | 31.2 - 31.8   |
| 12.51975 - 12.52025        | 240 - 285             | 3345.8 - 3358   | 36.43 - 36.5  |
| 12.57675 - 12.57725        | 322 - 335.4           | 3600 - 4400     | (3)           |

- Remark 1. Emission level in dBuV/m=20 log (uV/m)
- : 2. Measurement was performed at an antenna to the closed point of EUT distance of meters.
3. Only spurious frequency is permitted to locate within the Restricted Bands specified in provision of § 15.205, and the emissions located in restricted bands also comply with 15.209 limit.



### 7.5 Measurement Result

|                    |      |               |               |
|--------------------|------|---------------|---------------|
| Operation Mode:    | TX   | Test Date :   | Oct. 20, 2021 |
| Test By:           | Zero | Temperature : | 25°C          |
| Test Result:       | PASS | Humidity :    | 58 %          |
| Measured Distance: | 3m   |               |               |

#### Below 30MHz:

| Freq.<br>(MHz) | Ant.Pol.<br>H/V | Emission<br>Level<br>(dBuV/m) | Limit 3m<br>(dBuV/m) | Over<br>(dB) |
|----------------|-----------------|-------------------------------|----------------------|--------------|
| --             | --              | --                            | --                   | --           |

Note: The low frequency, which started from 9KHz-30MHz, was pre-scanned and the result which was 20dB lower than the limit line per 15.31(o) was not reported.

#### Below 1000MHz:

Pass.

All the modulation modes were tested the data of the worst mode ( $\pi$  /4-DQPSK TX 2441MHz) are recorded in the following pages and the others modulation methods do not exceed the limits.

Please refer to the following data.

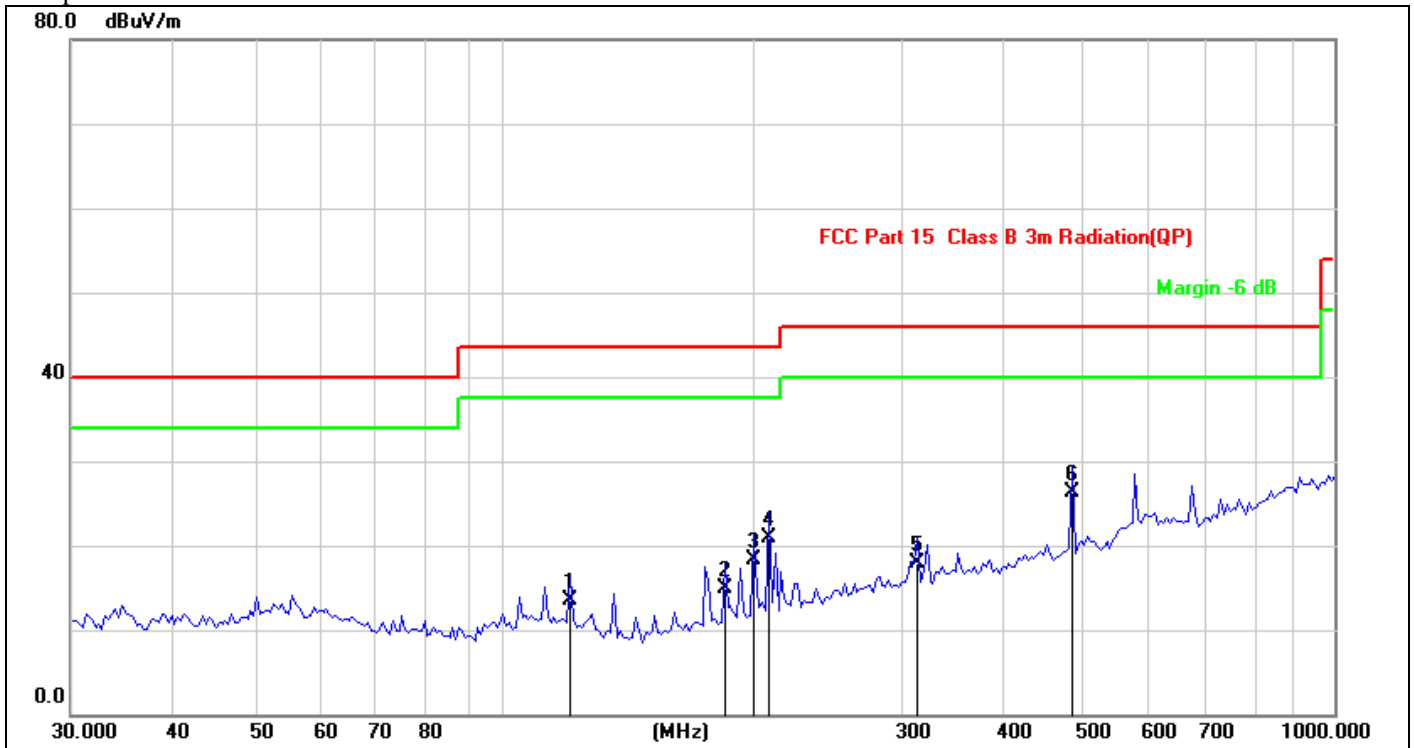

|        |  |                |          |                 |       |
|--------|--|----------------|----------|-----------------|-------|
| Site:  | LAB  | Antenna::      | Vertical | Temperature(C): | 26(C) |
| Limit: | FCC Part 15 C 3m Radiation(QP)                       | Test Time:     |          | Humidity(%):    | 60%   |
| EUT:   | 500LM Rechargeable Work Light with Bluetooth Speaker | Power Rating:  |          | Battery         | 3.7V  |
| M/N.:  | 7801   | Test Engineer: |          | Zero            |       |
| Mode:  | TX2441   |                |          |                 |       |
| Note:  |  |                |          |                 |       |

| No. | Frequency (MHz) | Reading (dBuV) | Factor (dB/m) | Level (dBuV/m) | Limit (dBuV/m) | Margin (dB) | Det. | Remark |
|-----|-----------------|----------------|---------------|----------------|----------------|-------------|------|--------|
| 1   | 119.8556        | 30.65          | -17.16        | 13.49          | 43.50          | -30.01      | QP   |        |
| 2   | 184.1667        | 32.16          | -17.24        | 14.92          | 43.50          | -28.58      | QP   |        |
| 3   | 199.2855        | 34.66          | -16.37        | 18.29          | 43.50          | -25.21      | QP   |        |
| 4   | 208.2148        | 36.90          | -15.92        | 20.98          | 43.50          | -22.52      | QP   |        |
| 5   | 314.3765        | 31.02          | -13.05        | 17.97          | 46.00          | -28.03      | QP   |        |
| 6 * | 483.0618        | 36.13          | -9.85         | 26.28          | 46.00          | -19.72      | QP   |        |

\*:Maximum data x:Over limit !:over margin

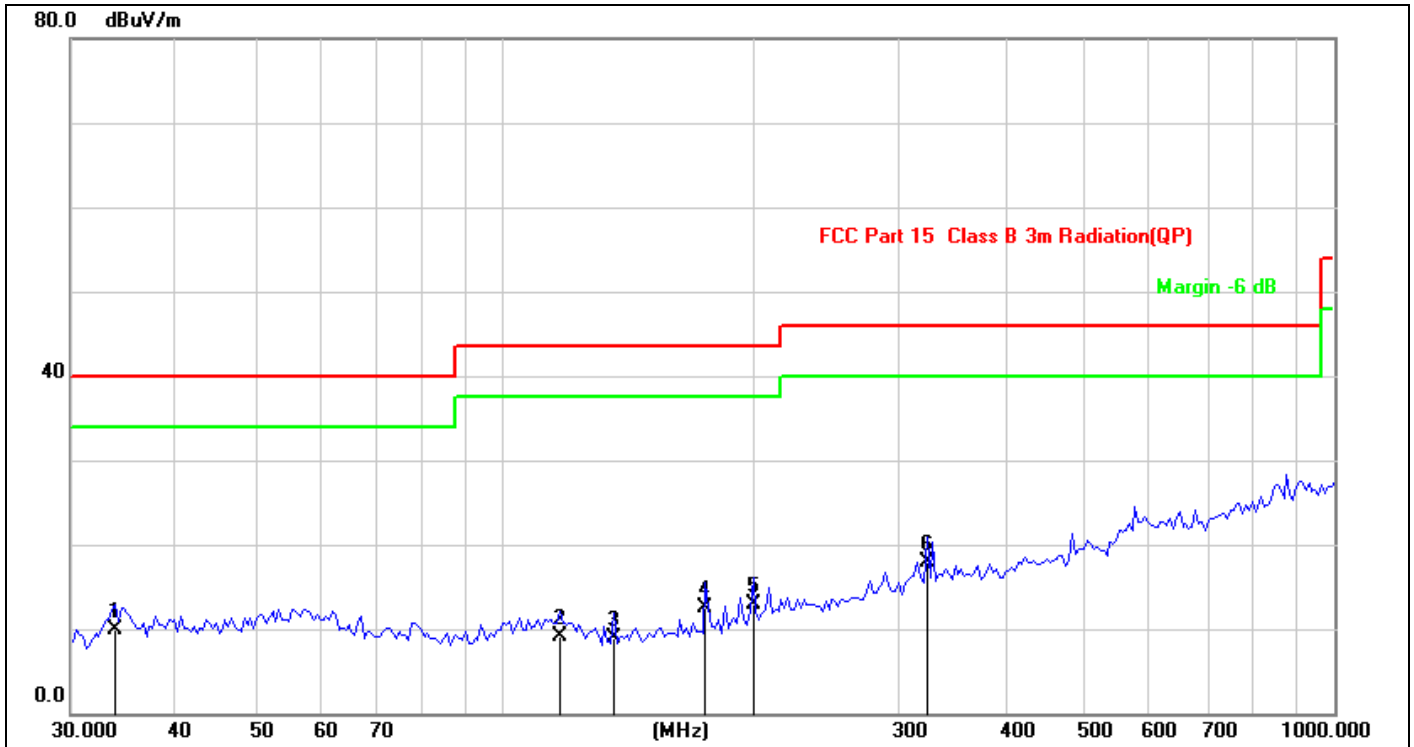

|        |  |                     |                      |
|--------|--|---------------------|----------------------|
| Site:  | LAB  | Antenna::Horizontal | Temperature(C):26(C) |
| Limit: | FCC Part 15C 3m Radiation(QP)                        |                     | Humidity(%):60%      |
| EUT:   | 500LM Rechargeable Work Light with Bluetooth Speaker | Test Time:          | 2021/10/21           |
| M/N.:  | 7801   | Power Rating:       | Battery 3.7V         |
| Mode:  | TX2441   | Test Engineer:      | Zero                 |
| Note:  |  |                     |                      |

| No. | Frequency (MHz) | Reading (dBuV) | Factor (dB/m) | Level (dBuV/m) | Limit (dBuV/m) | Margin (dB) | Det. | Remark |
|-----|-----------------|----------------|---------------|----------------|----------------|-------------|------|--------|
| 1   | 33.9174         | 27.87          | -18.02        | 9.85           | 40.00          | -30.15      | QP   |        |
| 2   | 116.7446        | 25.97          | -16.93        | 9.04           | 43.50          | -34.46      | QP   |        |
| 3   | 135.5062        | 27.60          | -18.74        | 8.86           | 43.50          | -34.64      | QP   |        |
| 4   | 174.7301        | 30.00          | -17.57        | 12.43          | 43.50          | -31.07      | QP   |        |
| 5   | 199.2855        | 29.37          | -16.37        | 13.00          | 43.50          | -30.50      | QP   |        |
| 6 * | 322.7540        | 30.91          | -13.08        | 17.83          | 46.00          | -28.17      | QP   |        |

\*:Maximum data x:Over limit !:over margin



**Above 1000MHz~10<sup>th</sup> Harmonics:**

Please refer to the following data.

Operation Mode:

GFSK (CH1: 2402MHz)

Test Date :

2021-10-21

| Freq.<br>(MHz) | Ant.<br>Pol. | Reading<br>Level(dBuV/m) |       | Correct<br>Factor<br>dB | Emission<br>Level(dBuV/m) |       | Limit<br>3m |    | Margin(dB) |        |
|----------------|--------------|--------------------------|-------|-------------------------|---------------------------|-------|-------------|----|------------|--------|
|                |              | PK                       | AV    |                         | PK                        | AV    | PK          | AV | PK         | AV     |
| 4804           | V            | 57.21                    | 38.3  | 4.02                    | 61.23                     | 42.32 | 74          | 54 | -12.77     | -11.68 |
| 7206           | V            | 49.87                    | 30.8  | 9.45                    | 59.32                     | 40.25 | 74          | 54 | -14.68     | -13.75 |
| 9608           | V            | 42.64                    | 23.4  | 14.92                   | 57.56                     | 38.32 | 74          | 54 | -16.44     | -15.68 |
| 12010          | V            | 37.78                    | 19.04 | 17.54                   | 55.32                     | 36.58 | 74          | 54 | -18.68     | -17.42 |
| 14412          | V            | 34.4                     | 15.34 | 22.07                   | 56.47                     | 37.41 | 74          | 54 | -17.53     | -16.59 |
| 16814          | V            | 32.03                    | 13.02 | 24                      | 56.03                     | 37.02 | 74          | 54 | -17.97     | -16.98 |
| 4804           | H            | 57.47                    | 38.29 | 4.02                    | 61.49                     | 42.31 | 74          | 54 | -12.51     | -11.69 |
| 7206           | H            | 50.06                    | 30.88 | 9.45                    | 59.51                     | 40.33 | 74          | 54 | -14.49     | -13.67 |
| 9608           | H            | 42.85                    | 23.71 | 14.92                   | 57.77                     | 38.63 | 74          | 54 | -16.23     | -15.37 |
| 12010          | H            | 38.82                    | 20    | 17.54                   | 56.36                     | 37.54 | 74          | 54 | -17.64     | -16.46 |
| 14412          | H            | 33.62                    | 14.18 | 22.07                   | 55.69                     | 36.25 | 74          | 54 | -18.31     | -17.75 |
| 16814          | H            | 32.11                    | 13.22 | 24                      | 56.11                     | 37.22 | 74          | 54 | -17.89     | -16.78 |

Operation Mode:

GFSK (CH40: 2441MHz)

Test Date :

2021-10-21

| Freq.<br>(MHz) | Ant.<br>Pol. | Reading<br>Level(dBuV/m) |       | Correct<br>Factor<br>dB | Emission<br>Level(dBuV/m) |       | Limit<br>3m(dBuV/m) |    | Margin(dB) |        |
|----------------|--------------|--------------------------|-------|-------------------------|---------------------------|-------|---------------------|----|------------|--------|
|                |              | PK                       | AV    |                         | PK                        | AV    | PK                  | AV | PK         | AV     |
| 4882           | V            | 58                       | 39.1  | 4.02                    | 62.02                     | 43.12 | 74                  | 54 | -11.98     | -10.88 |
| 7323           | V            | 50.18                    | 30.75 | 9.45                    | 59.63                     | 40.2  | 74                  | 54 | -14.37     | -13.8  |
| 9764           | V            | 42.68                    | 23.4  | 14.92                   | 57.6                      | 38.32 | 74                  | 54 | -16.4      | -15.68 |
| 12205          | V            | 38.78                    | 19.97 | 17.54                   | 56.32                     | 37.51 | 74                  | 54 | -17.68     | -16.49 |
| 14646          | V            | 33.78                    | 14.18 | 22.07                   | 55.85                     | 36.25 | 74                  | 54 | -18.15     | -17.75 |
| 17087          | V            | 32.02                    | 13.11 | 24                      | 56.02                     | 37.11 | 74                  | 54 | -17.98     | -16.89 |
| 4882           | H            | 57.94                    | 38.5  | 4.02                    | 61.96                     | 42.52 | 74                  | 54 | -12.04     | -11.48 |
| 7323           | H            | 49.87                    | 31.1  | 9.45                    | 59.32                     | 40.55 | 74                  | 54 | -14.68     | -13.45 |
| 9764           | H            | 42.6                     | 23.71 | 14.92                   | 57.52                     | 38.63 | 74                  | 54 | -16.48     | -15.37 |
| 12205          | H            | 38.08                    | 18.98 | 17.54                   | 55.62                     | 36.52 | 74                  | 54 | -18.38     | -17.48 |
| 14646          | H            | 33.29                    | 13.95 | 22.07                   | 55.36                     | 36.02 | 74                  | 54 | -18.64     | -17.98 |
| 17087          | H            | 32.2                     | 13.11 | 24                      | 56.20                     | 37.11 | 74                  | 54 | -17.8      | -16.89 |



Operation Mode: GFSK (CH79: 2480MHz) Test Date : 2021-10-21

| Freq.<br>(MHz) | Ant.<br>Pol.<br>H/V | Reading<br>Level(dBuV/m) |       | Correct<br>Factor<br>dB | Emission<br>Level(dBuV/m) |       | Limit<br>3m(dBuV/m) |    | Margin(dB) |        |
|----------------|---------------------|--------------------------|-------|-------------------------|---------------------------|-------|---------------------|----|------------|--------|
|                |                     | PK                       | AV    |                         | PK                        | AV    | PK                  | AV | PK         | AV     |
| 4960           | V                   | 57.94                    | 38.29 | 4.02                    | 61.96                     | 42.31 | 74                  | 54 | -12.04     | -11.69 |
| 7440           | V                   | 49.87                    | 30.8  | 9.45                    | 59.32                     | 40.25 | 74                  | 54 | -14.68     | -13.75 |
| 9920           | V                   | 42.4                     | 24.96 | 14.92                   | 57.32                     | 39.88 | 74                  | 54 | -16.68     | -14.12 |
| 12400          | V                   | 38.09                    | 19.04 | 17.54                   | 55.63                     | 36.58 | 74                  | 54 | -18.37     | -17.42 |
| 14880          | V                   | 34.01                    | 15.56 | 22.07                   | 56.08                     | 37.63 | 74                  | 54 | -17.92     | -16.37 |
| 17360          | V                   | 32.13                    | 13.42 | 24                      | 56.13                     | 37.42 | 74                  | 54 | -17.87     | -16.58 |
| 4960           | H                   | 58.07                    | 39    | 4.02                    | 62.09                     | 43.02 | 74                  | 54 | -11.91     | -10.98 |
| 7440           | H                   | 49.91                    | 31.68 | 9.45                    | 59.36                     | 41.13 | 74                  | 54 | -14.64     | -12.87 |
| 9920           | H                   | 42.36                    | 23.68 | 14.92                   | 57.28                     | 38.6  | 74                  | 54 | -16.72     | -15.4  |
| 12400          | H                   | 38.85                    | 19.69 | 17.54                   | 56.39                     | 37.23 | 74                  | 54 | -17.61     | -16.77 |
| 14880          | H                   | 34.18                    | 15.4  | 22.07                   | 56.25                     | 37.47 | 74                  | 54 | -17.75     | -16.53 |
| 17360          | H                   | 31.93                    | 12.58 | 24                      | 55.93                     | 36.58 | 74                  | 54 | -18.07     | -17.42 |

Operation Mode: Pi/4-DQPSK (CH1: 2402MHz) Test Date : 2021-10-21

| Freq.<br>(MHz) | Ant.<br>Pol.<br>H/V | Reading<br>Level(dBuV/m) |       | Correct<br>Factor<br>dB | Emission<br>Level(dBuV/m) |       | Limit<br>3m(dBuV/m) |    | Over(dB) |        |
|----------------|---------------------|--------------------------|-------|-------------------------|---------------------------|-------|---------------------|----|----------|--------|
|                |                     | PK                       | AV    |                         | PK                        | AV    | PK                  | AV | PK       | AV     |
| 4804           | V                   | 57.96                    | 38.56 | 4.02                    | 61.98                     | 42.58 | 74                  | 54 | -12      | -11.42 |
| 7206           | V                   | 50.87                    | 31.82 | 9.45                    | 60.32                     | 41.27 | 74                  | 54 | -13.7    | -12.73 |
| 9608           | V                   | 43.4                     | 24.86 | 14.92                   | 58.32                     | 39.78 | 74                  | 54 | -15.7    | -14.22 |
| 12010          | V                   | 39.04                    | 19.91 | 17.54                   | 56.58                     | 37.45 | 74                  | 54 | -17.4    | -16.55 |
| 14412          | V                   | 34.25                    | 15.25 | 22.07                   | 56.32                     | 37.32 | 74                  | 54 | -17.7    | -16.68 |
| 16814          | V                   | 32.47                    | 13.56 | 24                      | 56.47                     | 37.56 | 74                  | 54 | -17.5    | -16.44 |
| 4804           | H                   | 57.56                    | 38.3  | 4.02                    | 61.58                     | 42.32 | 74                  | 54 | -12.4    | -11.68 |
| 7206           | H                   | 50.7                     | 31.91 | 9.45                    | 60.15                     | 41.36 | 74                  | 54 | -13.9    | -12.64 |
| 9608           | H                   | 43.5                     | 24.49 | 14.92                   | 58.42                     | 39.41 | 74                  | 54 | -15.6    | -14.59 |
| 12010          | H                   | 39.98                    | 20.8  | 17.54                   | 57.52                     | 38.34 | 74                  | 54 | -16.5    | -15.66 |
| 14412          | H                   | 34.34                    | 15.14 | 22.07                   | 56.41                     | 37.21 | 74                  | 54 | -17.6    | -16.79 |
| 16814          | H                   | 32.03                    | 13.17 | 24                      | 56.03                     | 37.17 | 74                  | 54 | -18      | -16.83 |



Report No.: EA21100184F03201

27 of 70

Operation Mode: Pi/4-DQPSK (CH40: 2441MHz)

Test Date : 2021-10-21

| Freq.<br>(MHz) | Ant.<br>Pol. | Reading<br>Level(dBuV/m) |       | Correct<br>Factor<br>dB | Emission<br>Level(dBuV/m) |       | Limit<br>3m(dBuV/m) |    | Over(dB) |        |
|----------------|--------------|--------------------------|-------|-------------------------|---------------------------|-------|---------------------|----|----------|--------|
|                |              | PK                       | AV    |                         | PK                        | AV    | PK                  | AV | PK       | AV     |
| 4882           | V            | 55.61                    | 36.94 | 4.02                    | 59.63                     | 40.96 | 74                  | 54 | -14.37   | -13.04 |
| 7323           | V            | 47.87                    | 28.87 | 9.45                    | 57.32                     | 38.32 | 74                  | 54 | -16.68   | -15.68 |
| 9764           | V            | 41.4                     | 23.1  | 14.92                   | 56.32                     | 38.02 | 74                  | 54 | -17.68   | -15.98 |
| 12205          | V            | 37.79                    | 20.09 | 17.54                   | 55.33                     | 37.63 | 74                  | 54 | -18.67   | -16.37 |
| 14646          | V            | 34.07                    | 15.18 | 22.07                   | 56.14                     | 37.25 | 74                  | 54 | -17.86   | -16.75 |
| 17087          | V            | 32.32                    | 13.15 | 24                      | 56.32                     | 37.15 | 74                  | 54 | -17.68   | -16.85 |
| 4882           | H            | 56.01                    | 37.23 | 4.02                    | 60.03                     | 41.25 | 74                  | 54 | -13.97   | -12.75 |
| 7323           | H            | 48.41                    | 29.18 | 9.45                    | 57.86                     | 38.63 | 74                  | 54 | -16.14   | -15.37 |
| 9764           | H            | 41.52                    | 22.64 | 14.92                   | 56.44                     | 37.56 | 74                  | 54 | -17.56   | -16.44 |
| 12205          | H            | 37.78                    | 19.31 | 17.54                   | 55.32                     | 36.85 | 74                  | 54 | -18.68   | -17.15 |
| 14646          | H            | 34.06                    | 15.07 | 22.07                   | 56.13                     | 37.14 | 74                  | 54 | -17.87   | -16.86 |
| 17087          | H            | 31.63                    | 12.25 | 24                      | 55.63                     | 36.25 | 74                  | 54 | -18.37   | -17.75 |

Operation Mode: Pi/4-DQPSK (CH79: 2480MHz)

Test Date : 2021-10-21

| Freq.<br>(MHz) | Ant.<br>Pol. | Reading<br>Level(dBuV/m) |       | Correct<br>Factor<br>dB | Emission<br>Level(dBuV/m) |       | Limit<br>3m(dBuV/m) |    | Over(dB) |        |
|----------------|--------------|--------------------------|-------|-------------------------|---------------------------|-------|---------------------|----|----------|--------|
|                |              | PK                       | AV    |                         | PK                        | AV    | PK                  | AV | PK       | AV     |
| 4960           | V            | 56.21                    | 37.61 | 4.02                    | 60.23                     | 41.63 | 74                  | 54 | -13.77   | -12.37 |
| 7440           | V            | 49.91                    | 30.8  | 9.45                    | 59.36                     | 40.25 | 74                  | 54 | -14.64   | -13.75 |
| 9920           | V            | 42.44                    | 23.71 | 14.92                   | 57.36                     | 38.63 | 74                  | 54 | -16.64   | -15.37 |
| 12400          | V            | 38.78                    | 19.91 | 17.54                   | 56.32                     | 37.45 | 74                  | 54 | -17.68   | -16.55 |
| 14880          | V            | 34.96                    | 16.16 | 22.07                   | 57.03                     | 38.23 | 74                  | 54 | -16.97   | -15.77 |
| 17360          | V            | 32.19                    | 13.11 | 24                      | 56.19                     | 37.11 | 74                  | 54 | -17.81   | -16.89 |
| 4960           | H            | 56.27                    | 37.94 | 4.02                    | 60.29                     | 41.96 | 74                  | 54 | -13.71   | -12.04 |
| 7440           | H            | 50.02                    | 30.67 | 9.45                    | 59.47                     | 40.12 | 74                  | 54 | -14.53   | -13.88 |
| 9920           | H            | 42.53                    | 23.4  | 14.92                   | 57.45                     | 38.32 | 74                  | 54 | -16.55   | -15.68 |
| 12400          | H            | 39.23                    | 19.98 | 17.54                   | 56.77                     | 37.52 | 74                  | 54 | -17.23   | -16.48 |
| 14880          | H            | 33.25                    | 13.95 | 22.07                   | 55.32                     | 36.02 | 74                  | 54 | -18.68   | -17.98 |
| 17360          | H            | 32.31                    | 13.25 | 24                      | 56.31                     | 37.25 | 74                  | 54 | -17.69   | -16.75 |



**Other harmonics emissions are lower than 20dB below the allowable limit.**

- Note:**
- (1) All Readings are Peak Value and AV.
  - (2) Emission Level= Reading Level+ Probe Factor +Cable Loss.
  - (3) The average measurement was not performed when the peak measured data under the limit of average detection.
  - (4) Measuring frequencies from 1GHz to 25GHz.

**7.5 Radiated Measurement Photos:**

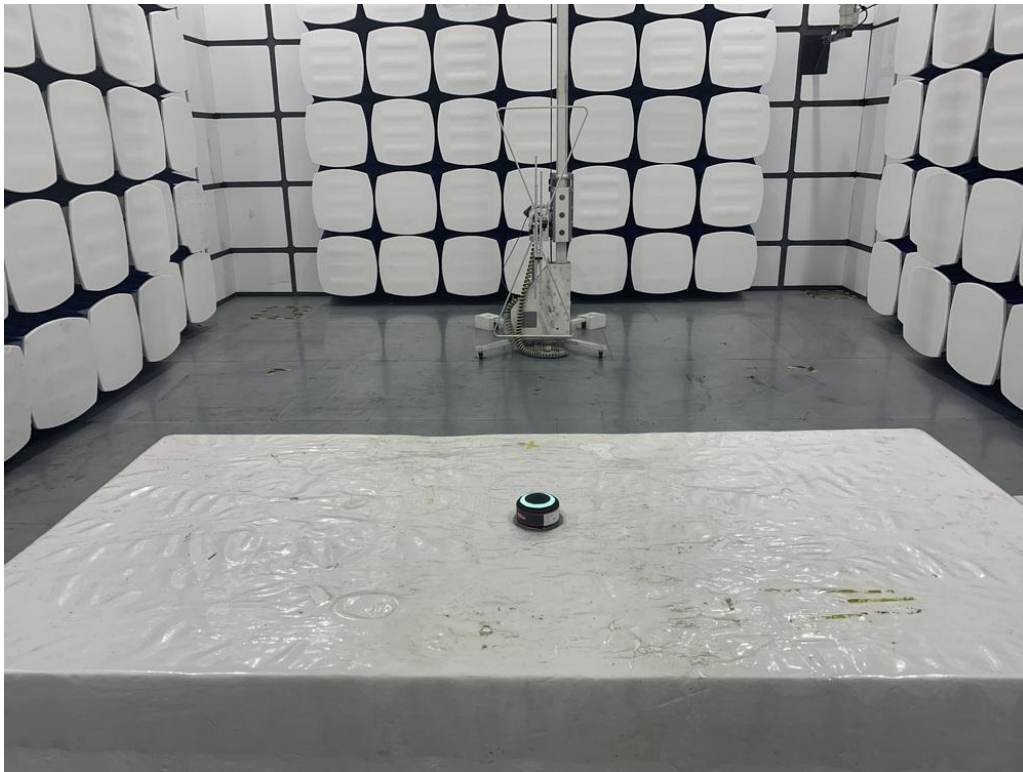

## 8. Channel Separation test

### 8.1 Measurement Procedure

The EUT was operating in hopping mode or could be controlled its channel. Printed out the test result from the spectrum by hard copy function.

### 8.2 Test SET-UP (Block Diagram of Configuration)

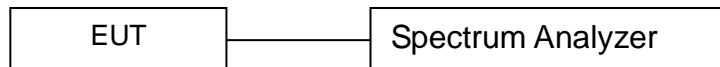

### 8.3 Measurement Equipment Used:

| EQUIPMENT TYPE    | MFR                | MODEL NUMBER | SERIAL NUMBER | CALIBRATED UNTIL |
|-------------------|--------------------|--------------|---------------|------------------|
| Spectrum Analyzer | Rohde & Schwarz    | FSV40        | US40240623    | 2021-11-19       |
| Coaxial Cable     | Gigalink Microwave | ZT40         | 19022092      | 2021-11-19       |
| Antenna Connector | ARTHUR-YANG        | 2244-N1TG1   | N/A           | 2021-11-19       |

Remark: The temporary antenna connector is soldered on the PCB board in order to perform conducted tests and this temporary antenna connector is listed in the equipment list.

### 8.4 Measurement Results:

Refer to attached data chart.



Spectrum Detector: PK                      Test Date :                      Oct. 18, 2021  
Test By: Zero                                  Temperature :                      24°C  
Test Result: PASS                              Humidity :                        53 %  
Modulation: GFSK

| Channel number | Channel frequency (MHz) | Separation Read Value (kHz) | Separation Limit 20dB Down BW(kHz) |
|----------------|-------------------------|-----------------------------|------------------------------------|
| 1              | 2402                    | 1000                        | >947                               |
| 40             | 2441                    | 1000                        | >950                               |
| 79             | 2480                    | 1000                        | >900                               |

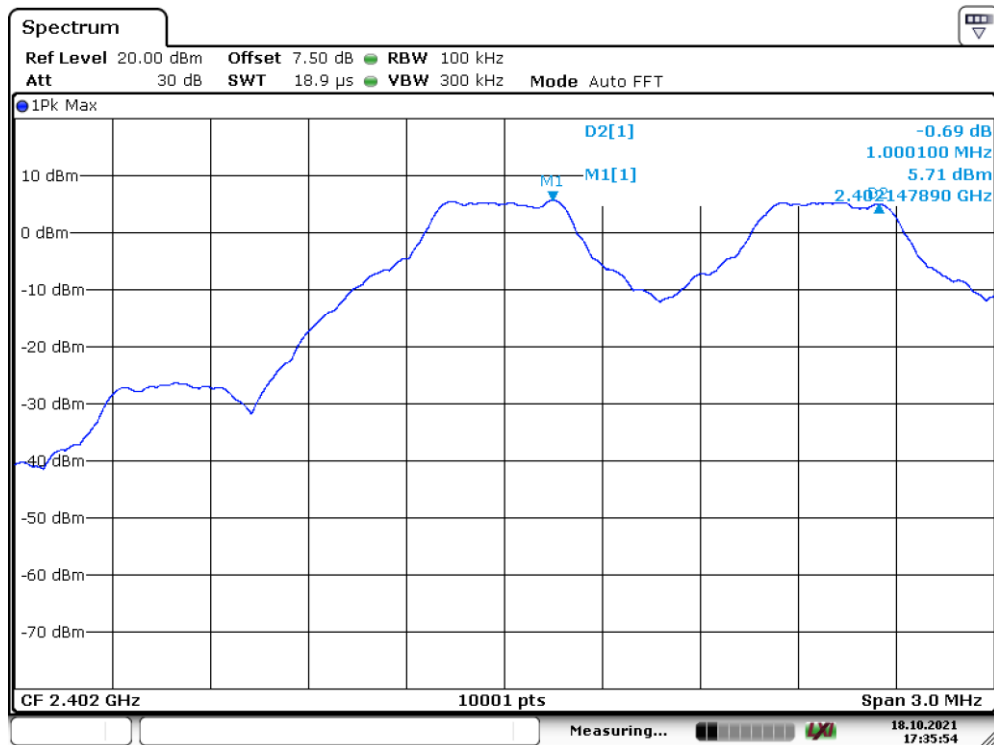

Date: 18.OCT.2021 17:35:54

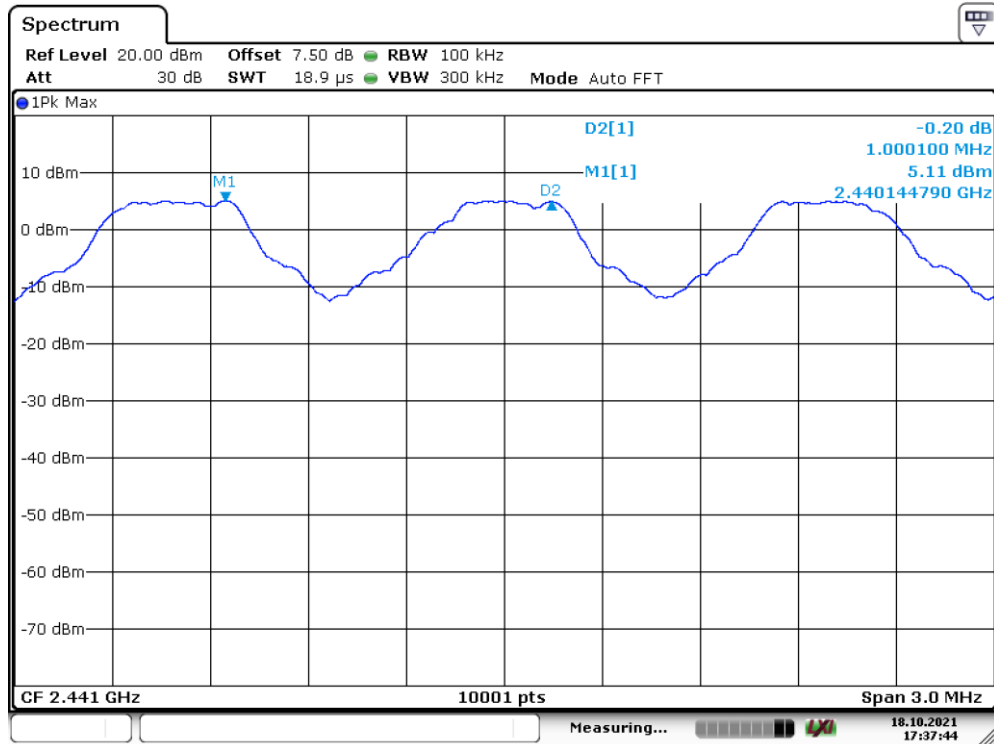

Date: 18.OCT.2021 17:37:44

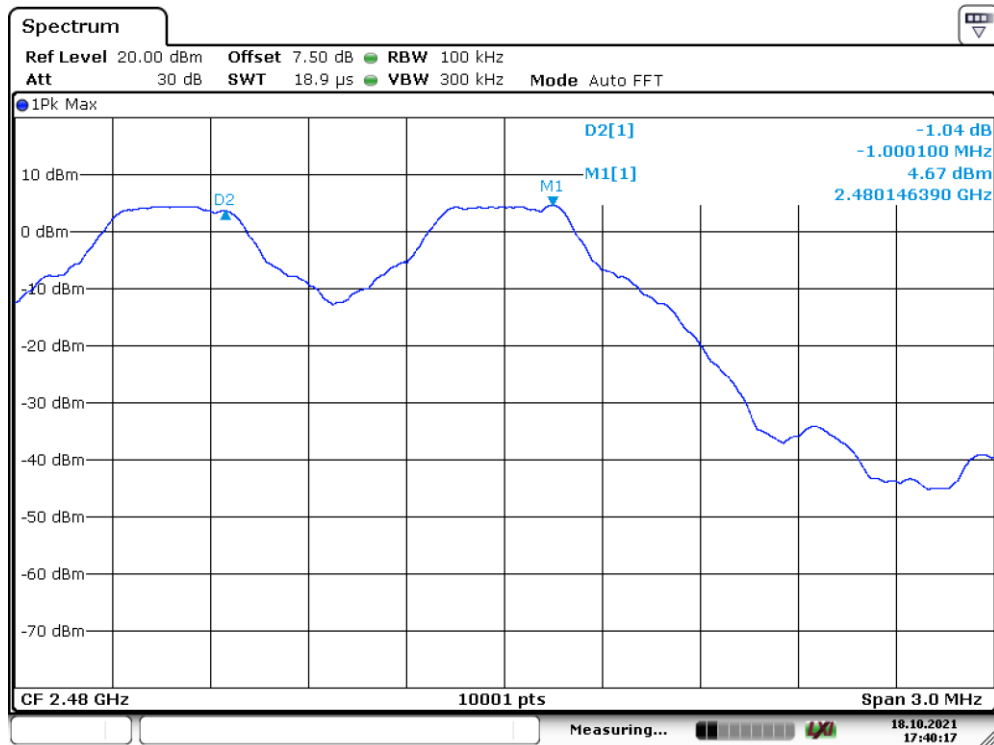

Date: 18.OCT.2021 17:40:17





Report No.: EA21100184F03201

33 of 70

|                    |           |               |               |
|--------------------|-----------|---------------|---------------|
| Spectrum Detector: | PK        | Test Date :   | Oct. 18, 2021 |
| Test By:           | Zero      | Temperature : | 24°C          |
| Test Result:       | PASS      | Humidity :    | 53 %          |
| Modulation:        | Π/4-DQPSK |               |               |

| Channel number | Channel frequency (MHz) | Separation Read Value (kHz) | Separation Limit 2/3 20dB Down BW(kHz) |
|----------------|-------------------------|-----------------------------|--|
| 1              | 2402                    | 1000                        | >881                                   |
| 40             | 2441                    | 1000                        | >873                                   |
| 79             | 2480                    | 1000                        | >881                                   |

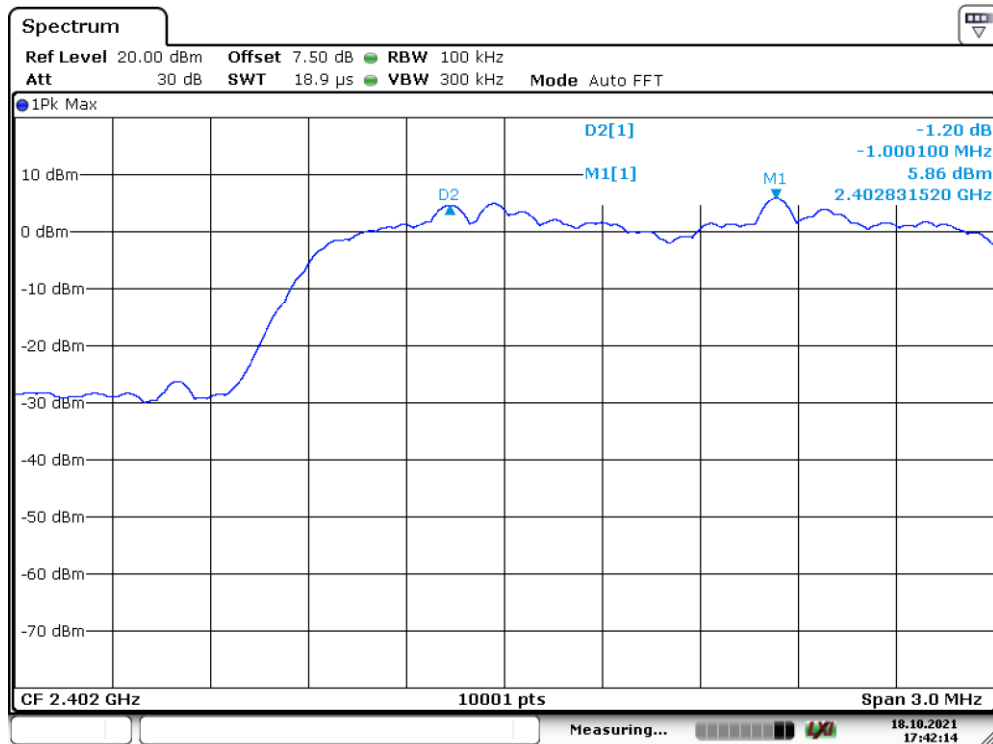

Date: 18.OCT.2021 17:42:14

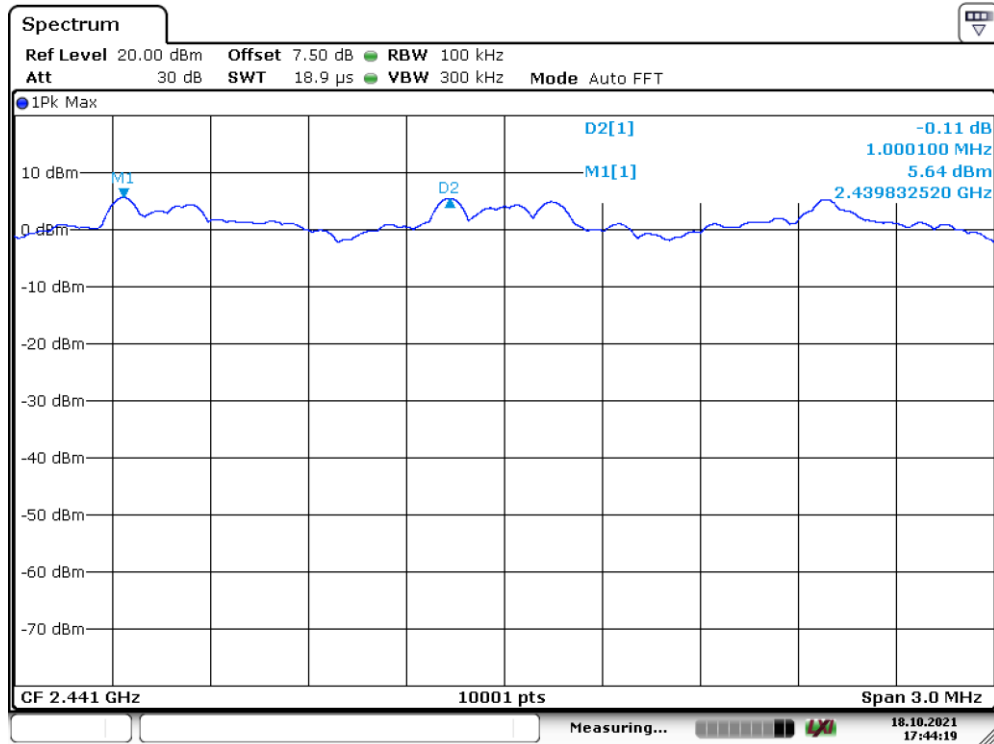

Date: 18.OCT.2021 17:44:19

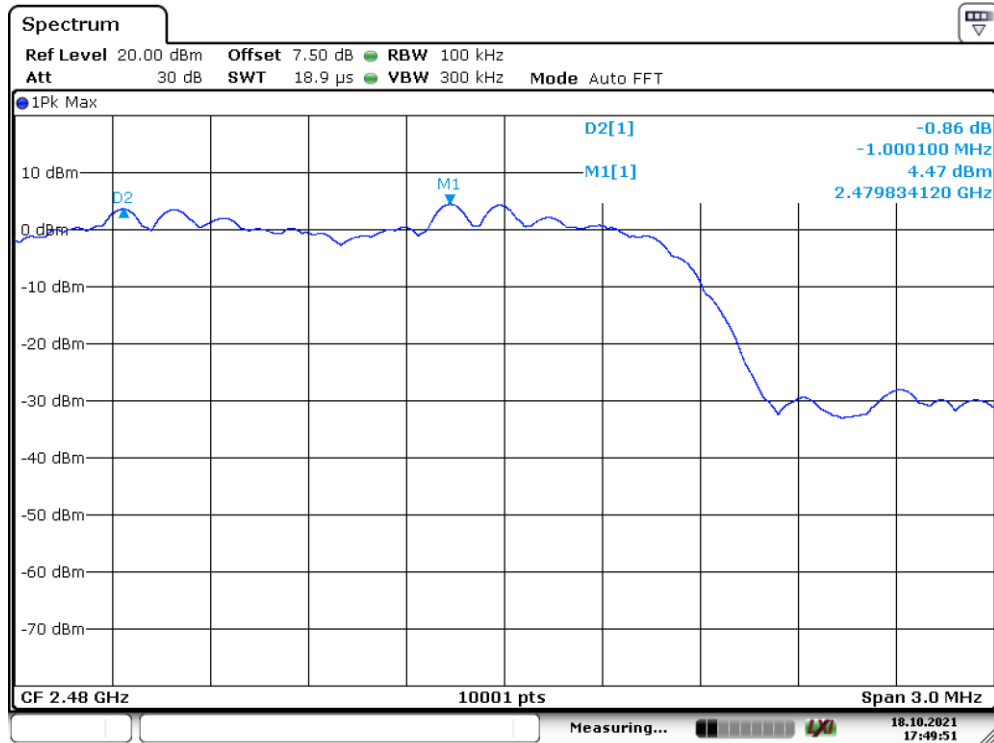

Date: 18.OCT.2021 17:49:52

## 9. 20dB Bandwidth test

### 9.1 Measurement Procedure

The EUT was operating in hopping mode or could be controlled its channel. Printed out the test result from the spectrum by hard copy function.

### 9.2 Test SET-UP (Block Diagram of Configuration)

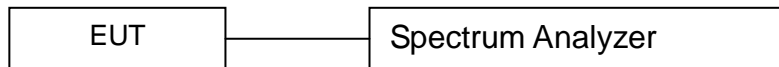

### 9.3 Measurement Equipment Used:

| EQUIPMENT TYPE    | MFR                | MODEL NUMBER | SERIAL NUMBER | CALIBRATED UNTIL |
|-------------------|--------------------|--------------|---------------|------------------|
| Spectrum Analyzer | Rohde & Schwarz    | FSV40        | US40240623    | 2021-11-19       |
| Coaxial Cable     | Gigalink Microwave | ZT40         | 19022092      | 2021-11-19       |
| Antenna Connector | ARTHUR-YANG        | 2244-N1TG1   | N/A           | 2021-11-19       |

Remark: The temporary antenna connector is soldered on the PCB board in order to perform conducted tests and this temporary antenna connector is listed in the equipment list.

### 9.4 Measurement Results:

Refer to attached data chart.

|                    |      |               |               |
|--------------------|------|---------------|---------------|
| Spectrum Detector: | PK   | Test Date :   | Oct. 18, 2021 |
| Test By:           | Zero | Temperature : | 24°C          |
| Test Result:       | PASS | Humidity :    | 53 %          |
| Modulation:        | GFSK |               |               |

| Channel number | Channel frequency (MHz) | 20dB Down BW(kHz) |
|----------------|-------------------------|-------------------|
| 1              | 2402                    | 947               |
| 40             | 2441                    | 950               |
| 79             | 2480                    | 900               |

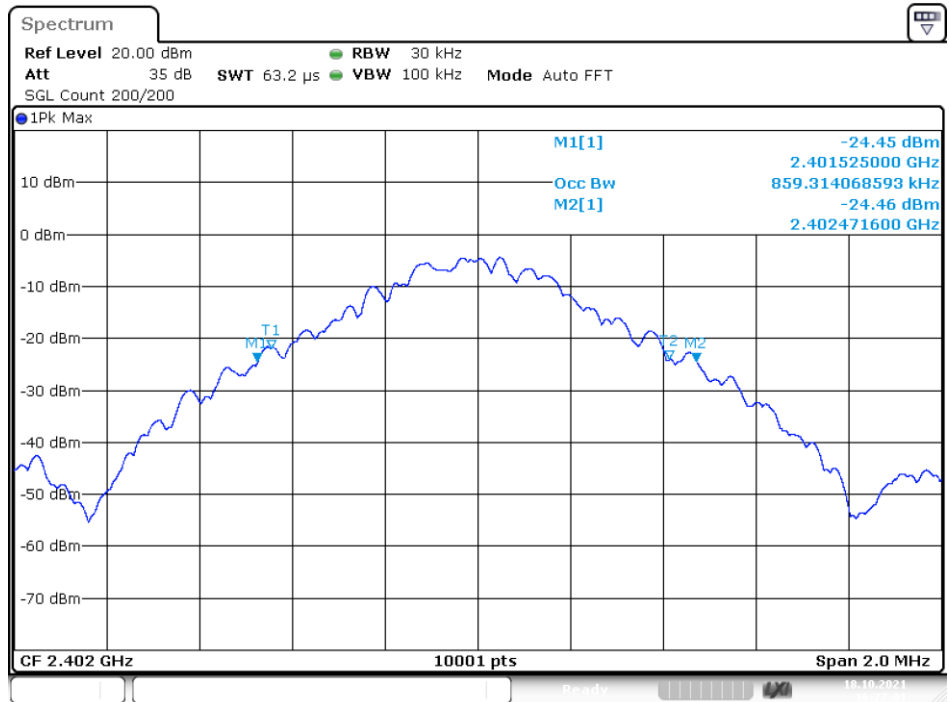

Date: 18.OCT.2021 16:27:00

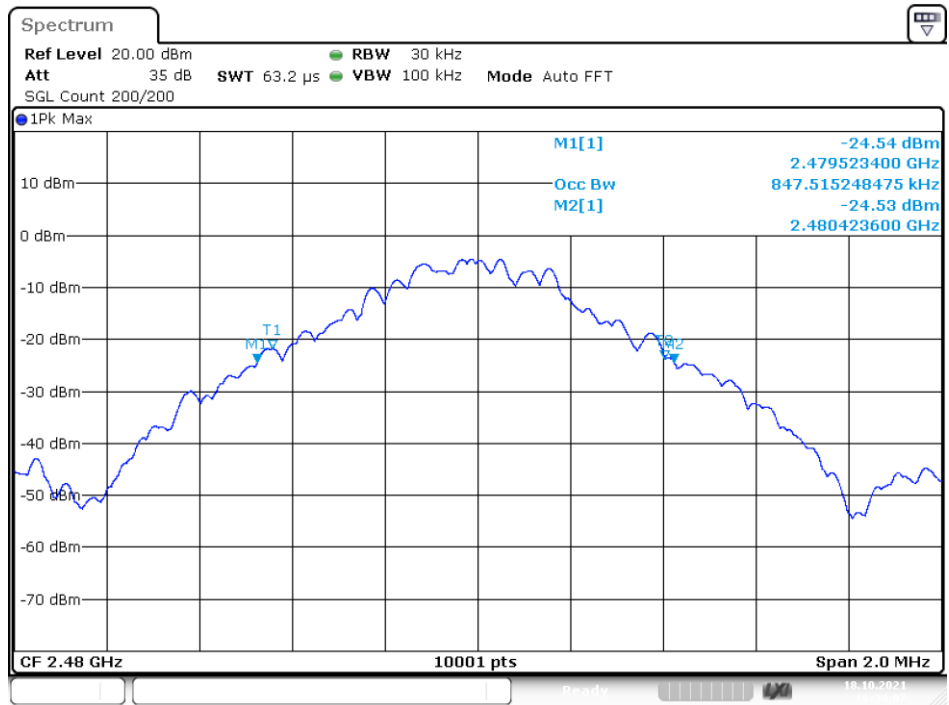
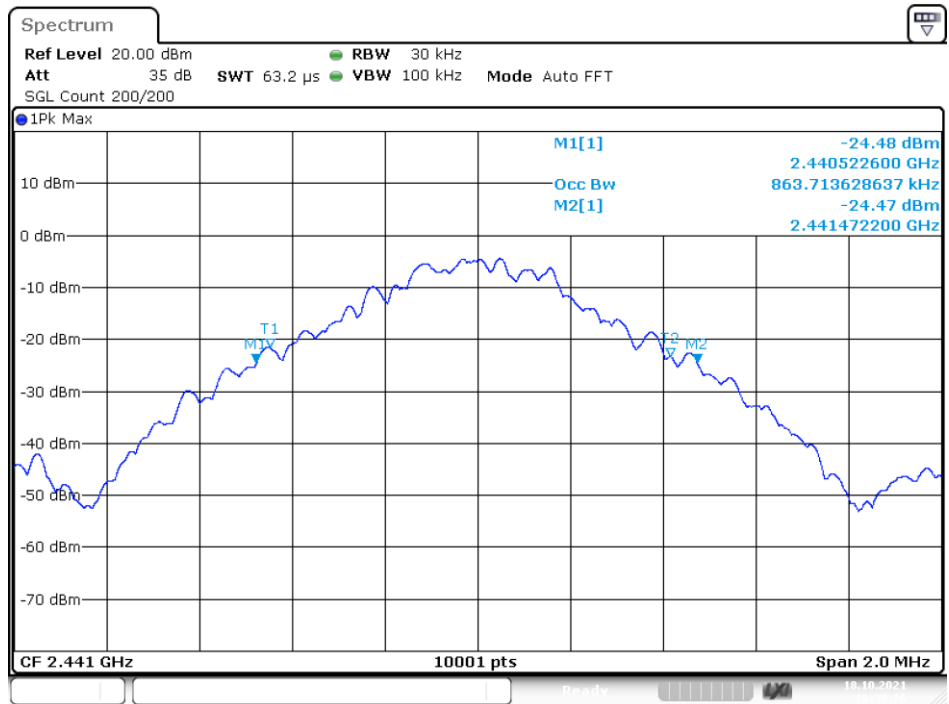



Spectrum Detector: PK                      Test Date :                      Oct. 18, 2021  
Test By: Zero                                  Temperature :                      24°C  
Test Result: PASS                              Humidity :                        53 %  
Modulation: Π/4-DQPSK

| Channel number | Channel frequency (MHz) | 20dB Down BW(kHz) |
|----------------|-------------------------|-------------------|
| 1              | 2402                    | 1321              |
| 40             | 2441                    | 1309              |
| 79             | 2480                    | 1322              |

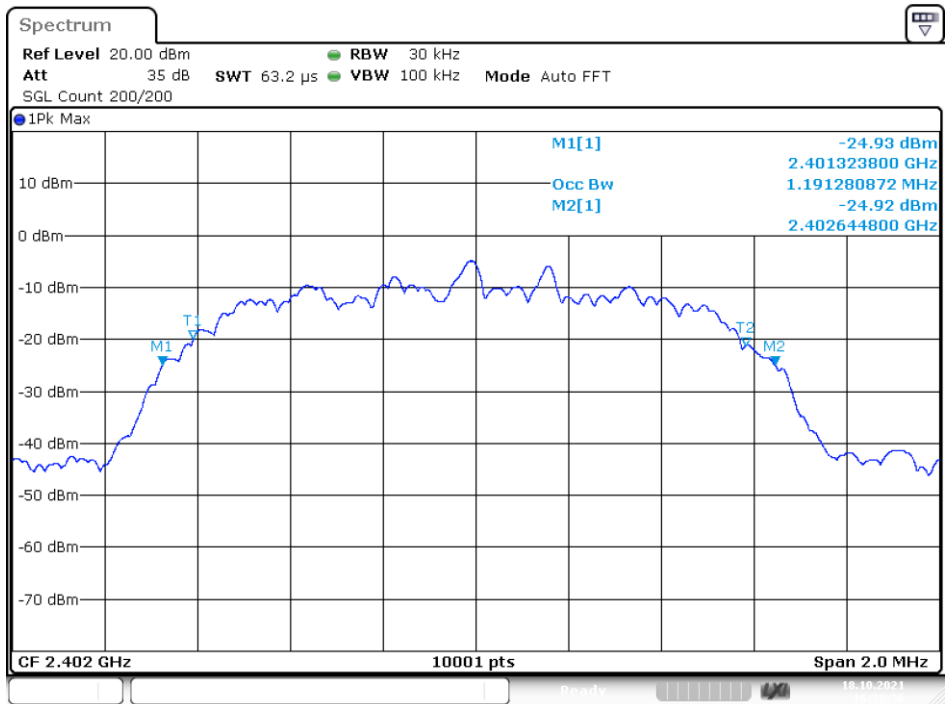

Date: 18.OCT.2021 16:38:36

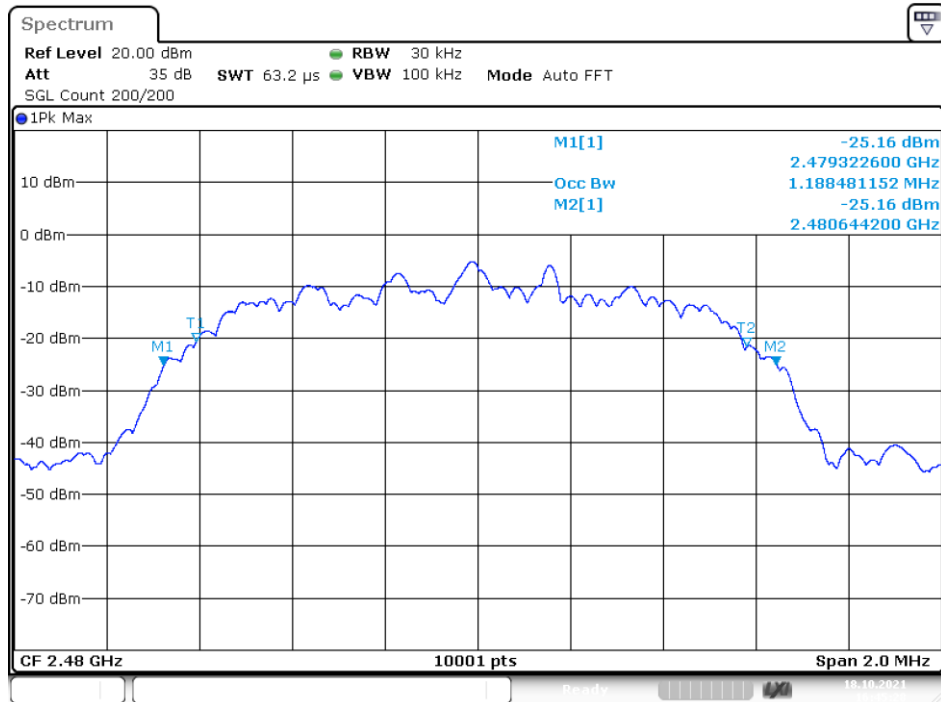
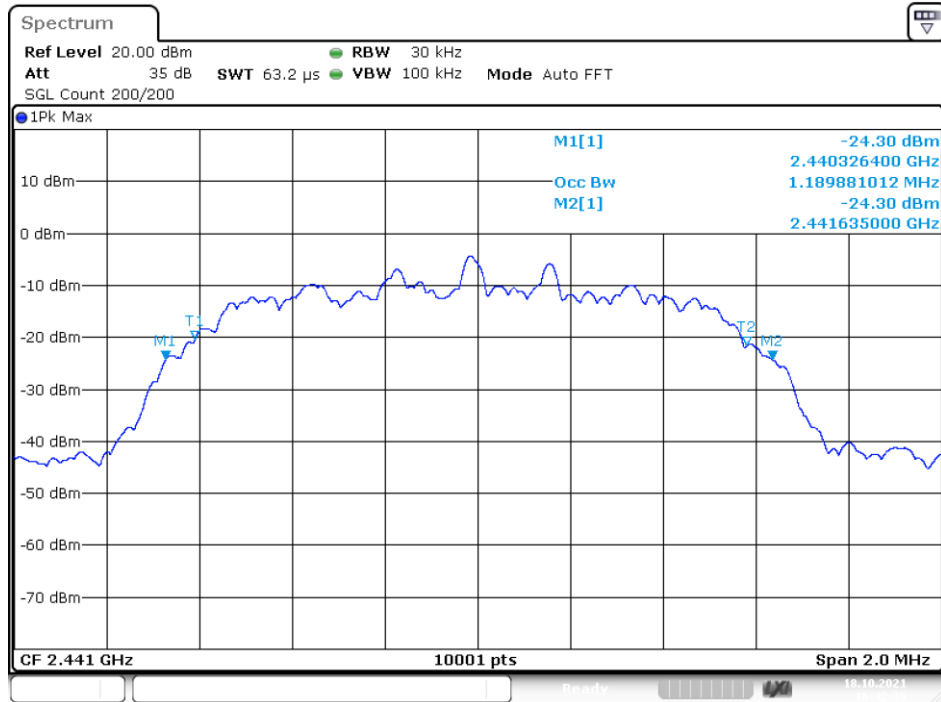

## 10. Quantity of Hopping Channel Test

### 10.1 Measurement Procedure

The EUT was operating in hopping mode or could be controlled its channel. Printed out the test result from the spectrum by hard copy function.

### 10.2 Test SET-UP (Block Diagram of Configuration)

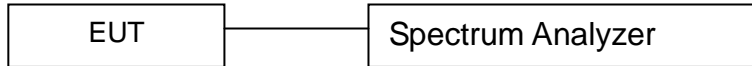

### 10.3 Measurement Equipment Used:

| EQUIPMENT TYPE    | MFR                | MODEL NUMBER | SERIAL NUMBER | CALIBRATED UNTIL |
|-------------------|--------------------|--------------|---------------|------------------|
| Spectrum Analyzer | Rohde & Schwarz    | FSV40        | US40240623    | 2021-11-19       |
| Coaxial Cable     | Gigalink Microwave | ZT40         | 19022092      | 2021-11-19       |
| Antenna Connector | ARTHUR-YANG        | 2244-N1TG1   | N/A           | 2021-11-19       |

Remark: The temporary antenna connector is soldered on the PCB board in order to perform conducted tests and this temporary antenna connector is listed in the equipment list.

### 10.4 Measurement Results:

Refer to attached data chart.

|                 |      |               |               |
|-----------------|------|---------------|---------------|
| Worst Test Mode | GFSK | Test Date :   | Oct. 18, 2021 |
| Test By:        | Zero | Temperature : | 24 °C         |
| Test Result:    | PASS | Humidity :    | 53 %          |

| Hopping Channel Frequency Range | Quantity of Hopping Channel | Quantity of Hopping Channel |
|---------------------------------|-----------------------------|-----------------------------|
| 2402-2480                       | 79                          | > 15                        |

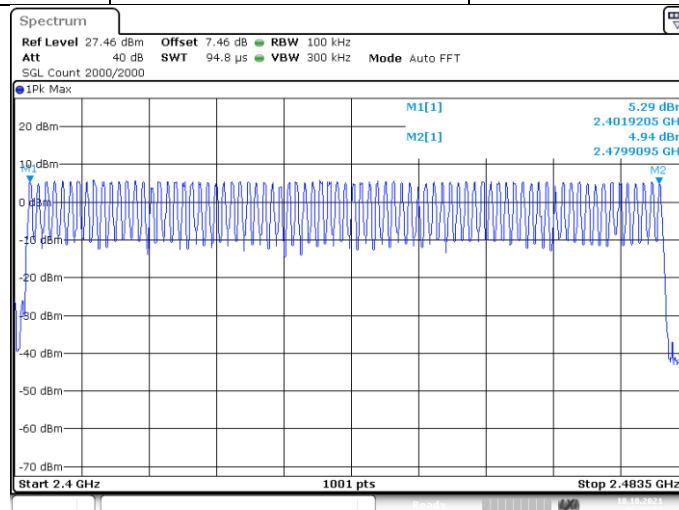

Date: 18.OCT.2021 16:28:26



## 11. Time of Occupancy (Dwell Time) test

### 11.1 Test Description

The Equipment Under Test (EUT) was set up to perform the dwell time measurements. The EUT was connected to the spectrum analyzer via a short coax cable. The dwell time is calculated by:

$$\text{Dwell time} = \text{time slot length} * \text{hop rate} / \text{number of hopping channels} * 31.6\text{s}$$

with:

- hop rate =  $1600 * 1/\text{s}$  for DH1 packets =  $1600 \text{ s}^{-1}$
- hop rate =  $1600/3 * 1/\text{s}$  for DH3 packets =  $533.33 \text{ s}^{-1}$
- number of hopping channels = 79
- $31.6 \text{ s} = 0.4 \text{ seconds multiplied by the number of hopping channels} = 0.4 \text{ s} * 79$

The highest value of the dwell time is reported.

### 11.2 Test SET-UP (Block Diagram of Configuration)

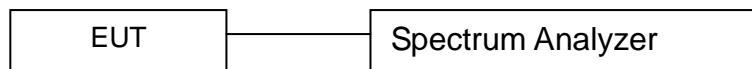

### 11.3 Measurement Equipment Used:

| EQUIPMENT TYPE    | MFR                | MODEL NUMBER | SERIAL NUMBER | CALIBRATED UNTIL |
|-------------------|--------------------|--------------|---------------|------------------|
| Spectrum Analyzer | Rohde & Schwarz    | FSV40        | US40240623    | 2021-11-19       |
| Coaxial Cable     | Gigalink Microwave | ZT40         | 19022092      | 2021-11-19       |
| Antenna Connector | ARTHUR-YANG        | 2244-N1TG1   | N/A           | 2021-11-19       |

Remark: The temporary antenna connector is soldered on the PCB board in order to perform conducted tests and this temporary antenna connector is listed in the equipment list.

### 11.4 Test Requirements / Limits

FCC Part 15, Subpart C, §15.247 (a) (1) (iii)

Frequency hopping systems in the 2400-2483.5 MHz band shall use at least 15 channels. The average time of occupancy on any channel shall not be greater than 0.4 seconds within a period of 0.4 seconds multiplied by the number of hopping channels employed. Since the Bluetooth technology uses 79 channels this period is calculated to be 31.6seconds. Refer to attached data chart.

|              |      |               |               |
|--------------|------|---------------|---------------|
| Modulation:  | GFSK | Test Date :   | Oct. 18, 2021 |
| Test By:     | Zero | Temperature : | 24 °C         |
| Test Result: | PASS | Humidity :    | 53 %          |

### 11.5 Test result

| Mode | Number of transmission in a 31.6( 79 Hopping*0.4) | Length of transmissions time(msec) | Result (msec) | Limit (msec) |
|------|---|------------------------------------|---------------|--------------|
| DH1  | $1600/(2*79) \times 31.6 = 320$                   | 0.373                              | 119.36        | 400          |
| DH3  | $1600/(4*79) \times 31.6 = 160$                   | 1.630                              | 260.80        | 400          |
| DH5  | $1600/(6*79) \times 31.6 = 106.67$                | 2.876                              | 306.78        | 400          |

Remark: The results of worst cased was recorded.

DH1:

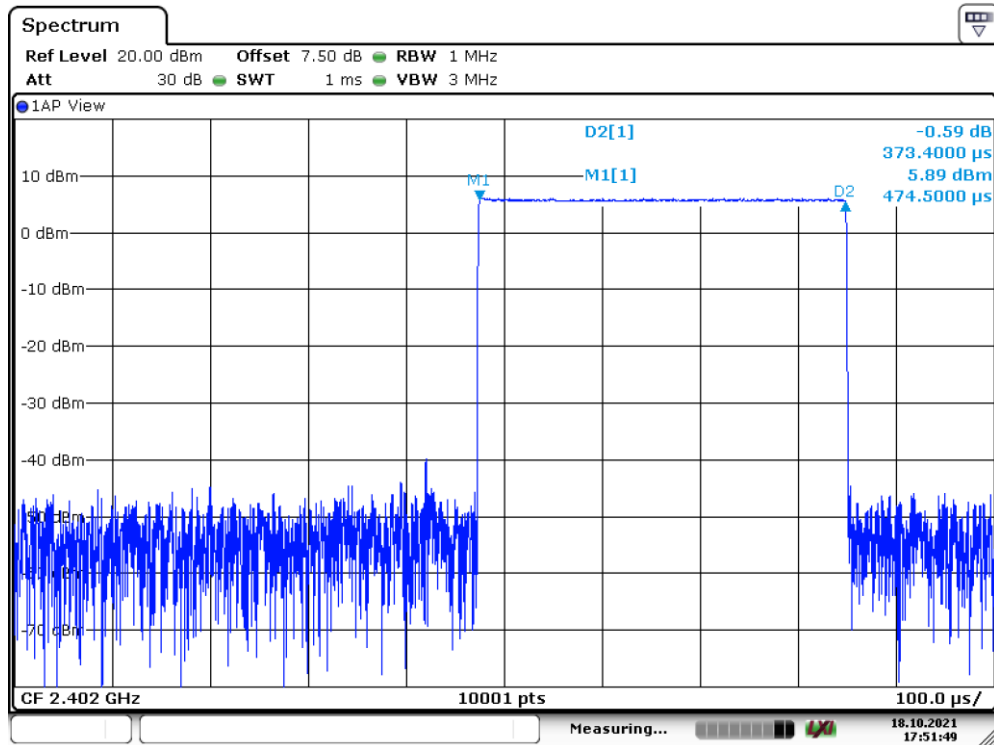

Date: 18.OCT.2021 17:51:50

Report No.: EA21100184F03201  
 DH3:

43 of 70

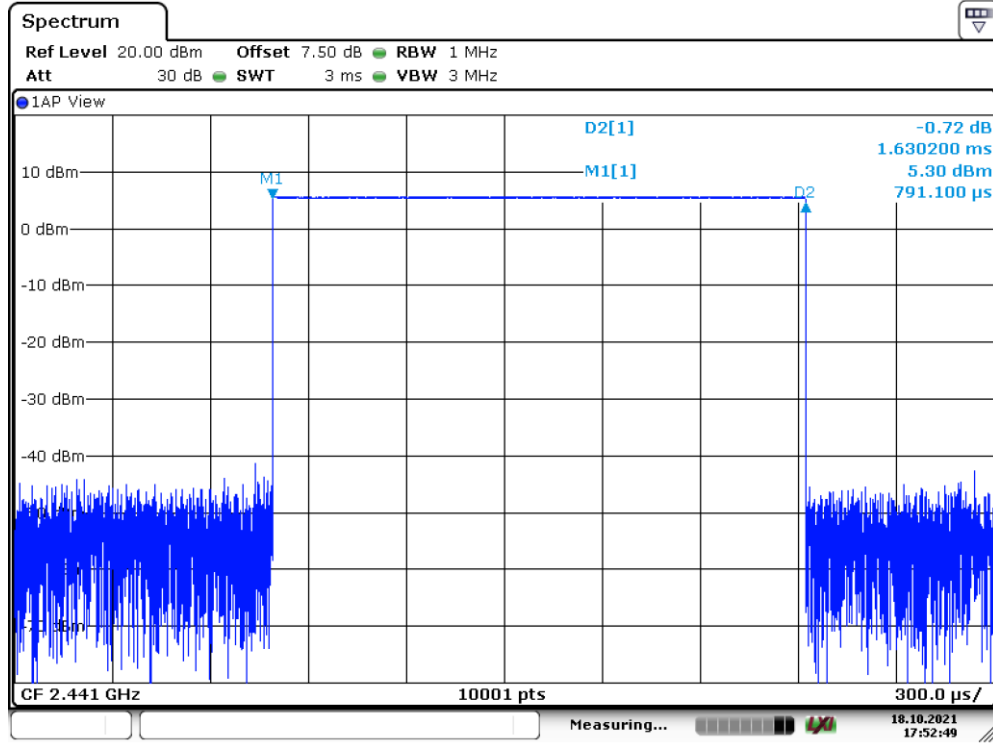

Date: 18.OCT.2021 17:52:49

DH5:

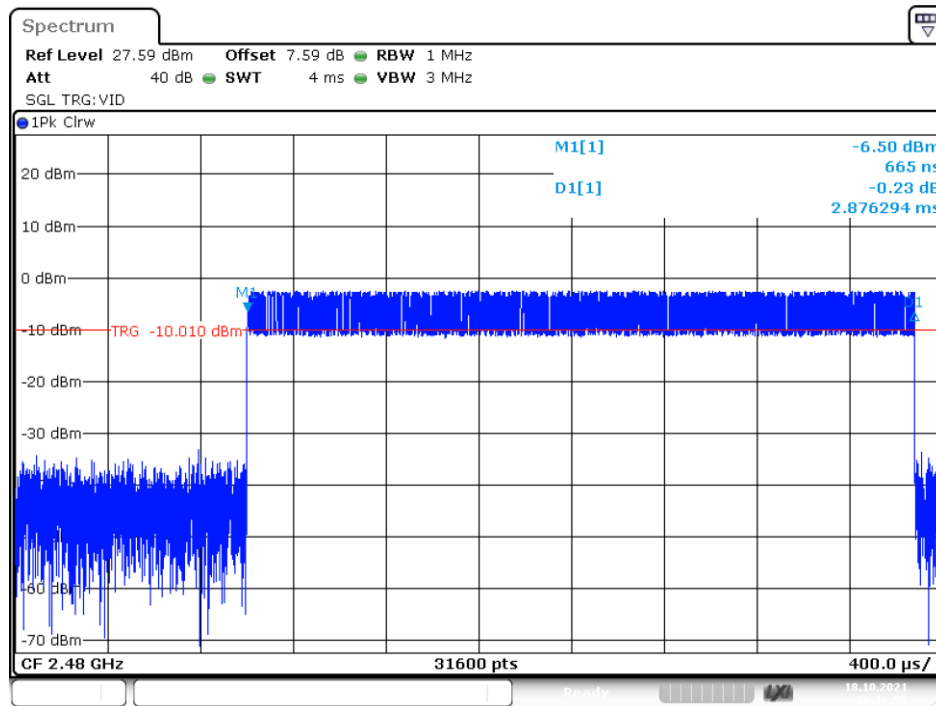

Date: 18.OCT.2021 16:36:54

## 12. MAXIMUM PEAK OUTPUT POWER TEST

### 12.1 Measurement Procedure

- a. Check the calibration of the measuring instrument(SA) using either an internal calibrator or a known signal from an external generator.
- b. Turn on the EUT and connect it to measurement instrument. Then set it to any one convenient frequency within its operating range. Set a reference level on the measuring instrument equal to the highest peak value.
- c. The center frequency of the spectrum analyzer is set to the fundamental frequency and using proper RBW and VBW setting.
- d. Measure the captured power within the band and recording the plot.
- e. Repeat above procedures until all frequencies required were complete.

### 12.2 Test SET-UP (Block Diagram of Configuration)

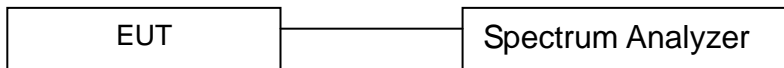

### 12.3 Measurement Equipment Used:

| EQUIPMENT TYPE    | MFR                | MODEL NUMBER | SERIAL NUMBER | CALIBRATED UNTIL |
|-------------------|--------------------|--------------|---------------|------------------|
| Spectrum Analyzer | Rohde & Schwarz    | FSV40        | US40240623    | 2021-11-19       |
| Coaxial Cable     | Gigalink Microwave | ZT40         | 19022092      | 2021-11-19       |
| Antenna Connector | ARTHUR-YANG        | 2244-N1TG1   | N/A           | 2021-11-19       |

Remark: The temporary antenna connector is soldered on the PCB board in order to perform conducted tests and this temporary antenna connector is listed in the equipment list.

### 12.4 Measurement Results:

Refer to attached data chart.

|                    |      |               |               |
|--------------------|------|---------------|---------------|
| Spectrum Detector: | PK   | Test Date :   | Oct. 18, 2021 |
| Test By:           | Zero | Temperature : | 24 °C         |
| Test Result:       | PASS | Humidity :    | 53 %          |
| Modulation:        | GFSK |               |               |

| Channel number | Channel Frequency (MHz) | Peak Power output(dBm) | Peak Power output(mW) | Peak Power Limit(mW) | Pass/Fail |
|----------------|-------------------------|------------------------|-----------------------|----------------------|-----------|
| 01             | 2402                    | 6.16                   | 4.130                 | 1000                 | PASS      |
| 40             | 2441                    | 6.18                   | 4.150                 | 1000                 | PASS      |
| 79             | 2480                    | 6.03                   | 4.009                 | 1000                 | PASS      |

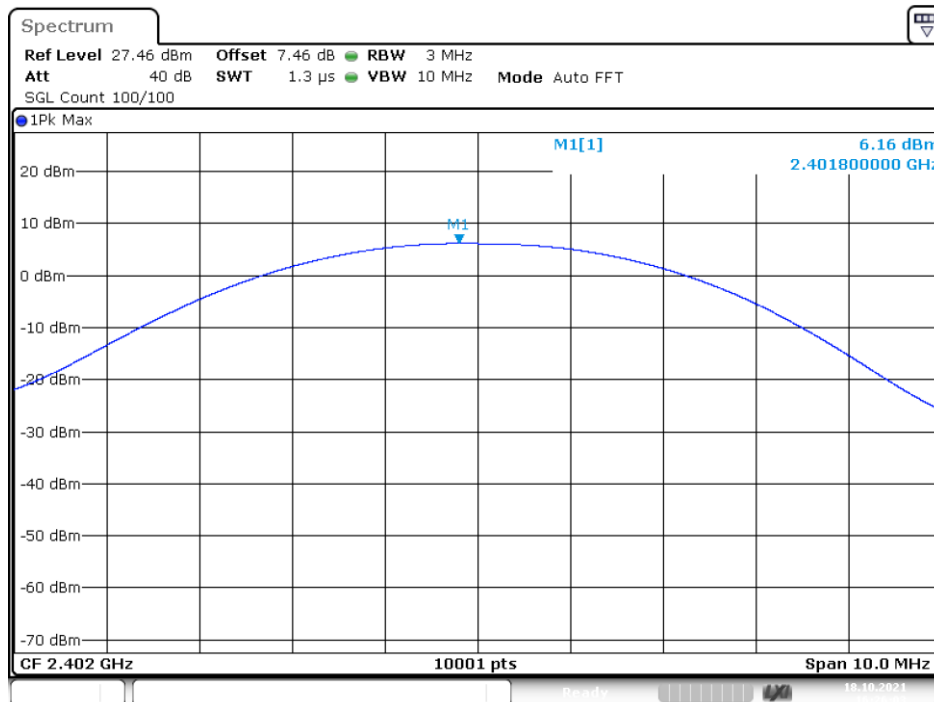

Date: 18.OCT.2021 16:26:03

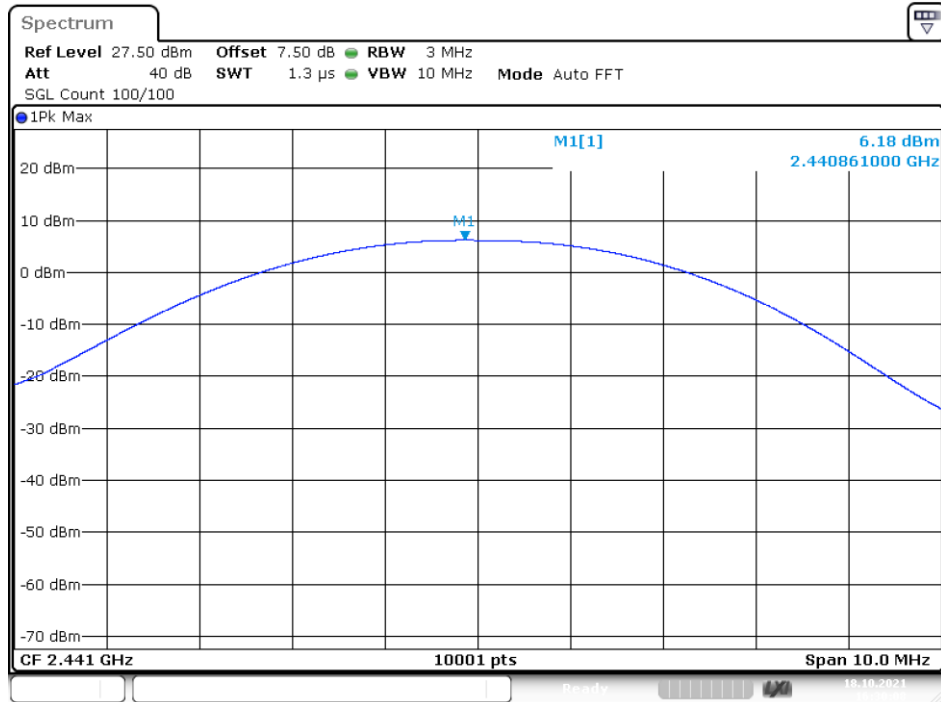

Date: 18.OCT.2021 16:30:09

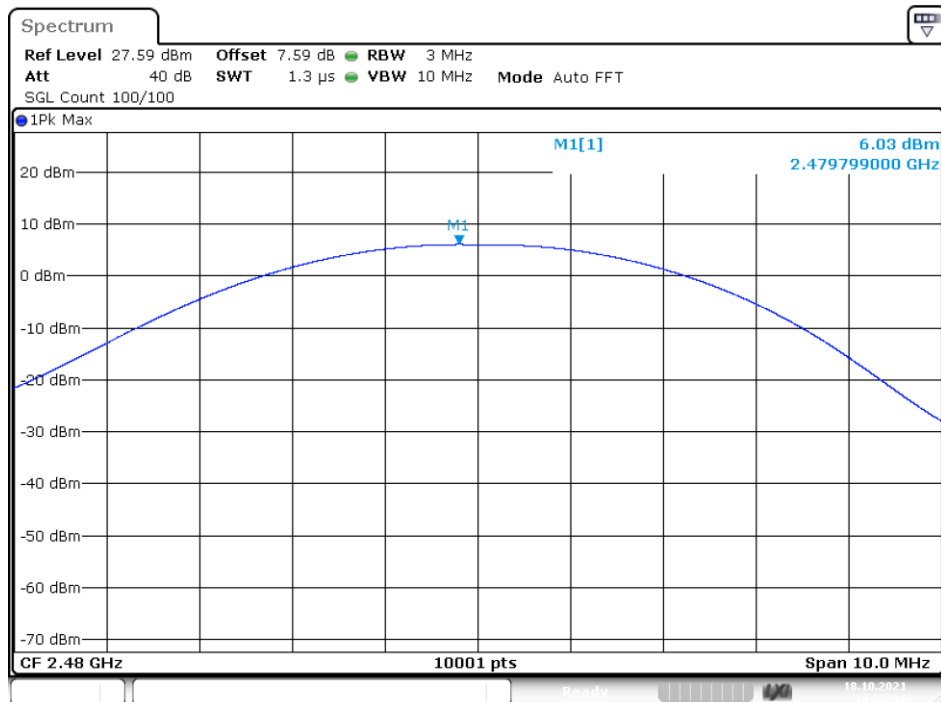

Date: 18.OCT.2021 16:33:31

Report No.: EA21100184F03201  
 Spectrum Detector: PK  
 Test By: Zero  
 Test Result: PASS  
 Modulation:  $\Pi/4$ -DQPSK

47 of 70  
 Test Date : Oct. 07, 2021  
 Temperature : 24 °C  
 Humidity : 53 %

| Channel number | Channel Frequency (MHz) | Peak Power output(dBm) | Peak Power output(mW) | Peak Power Limit(mW) | Pass/Fail |
|----------------|-------------------------|------------------------|-----------------------|----------------------|-----------|
| 01             | 2402                    | 6.5                    | 4.467                 | 125                  | PASS      |
| 40             | 2441                    | 6.52                   | 4.487                 | 125                  | PASS      |
| 79             | 2480                    | 6.35                   | 4.315                 | 125                  | PASS      |

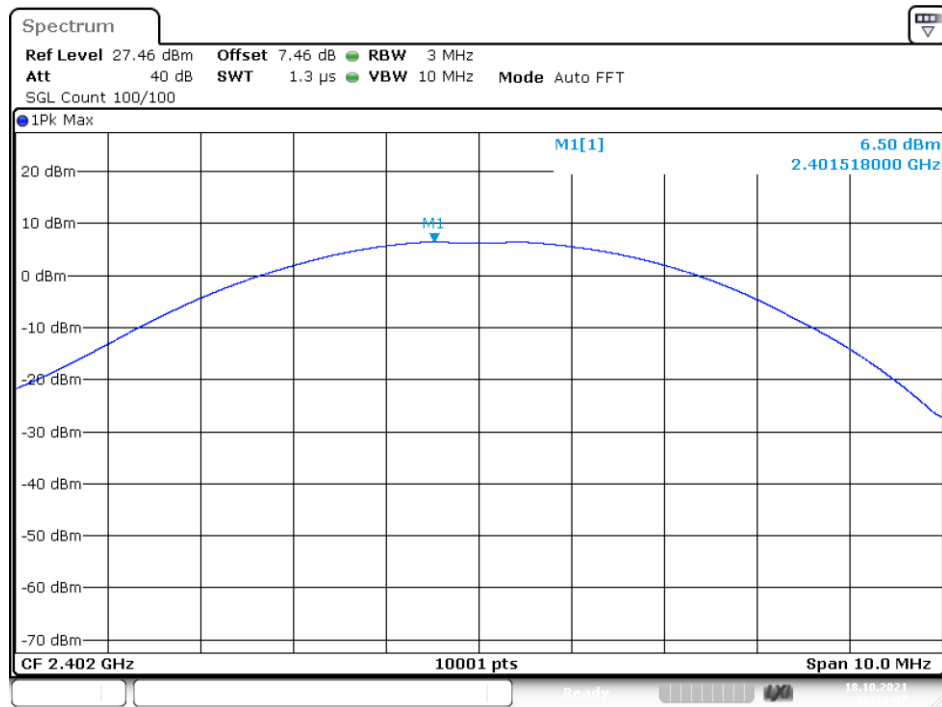

Date: 18.OCT.2021 16:38:07

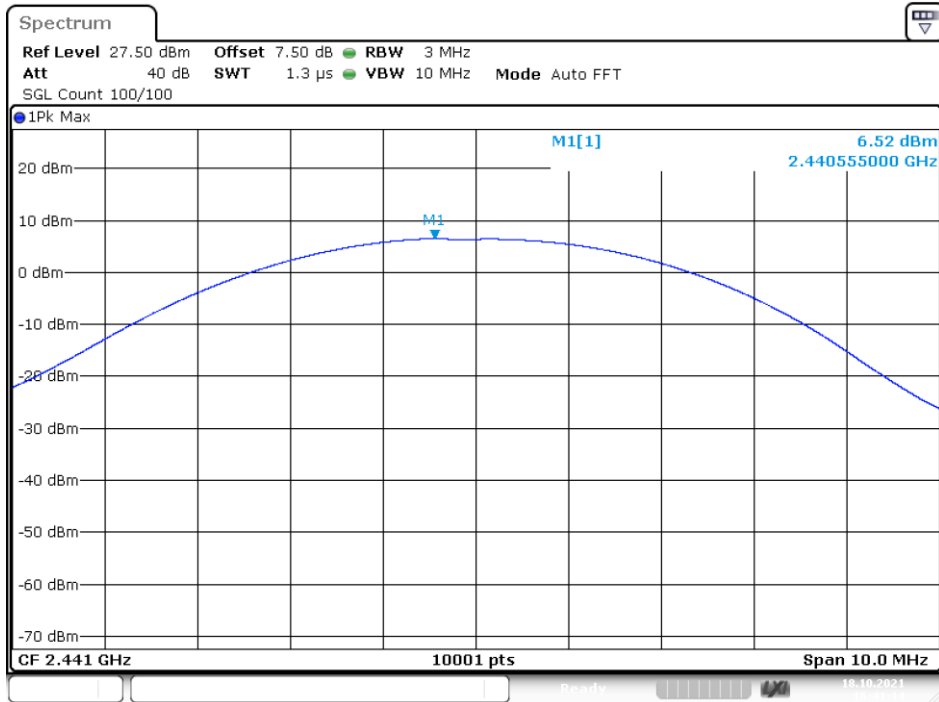

Date: 18.OCT.2021 16:41:14

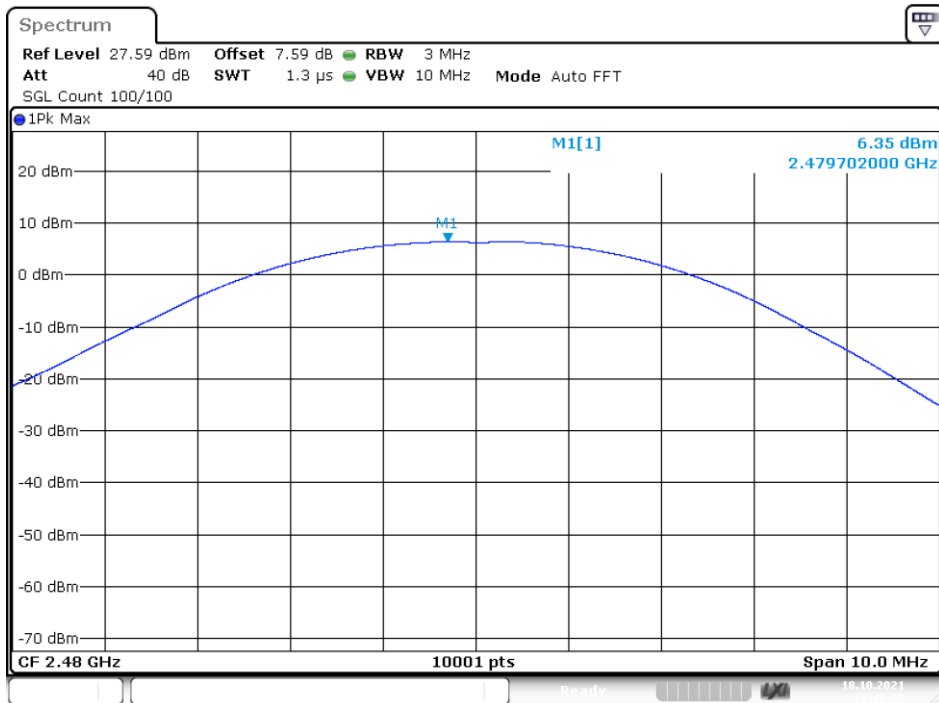

Date: 18.OCT.2021 16:45:08



### 13. Band EDGE test

#### 13.1 Measurement Procedure

##### For Conducted Test

1. The transmitter output is connected to a spectrum analyzer. The resolution bandwidth is set to 100KHz. The video bandwidth is set to 300KHz.
2. The spectrum from 30MHz to 26 GHz is investigated with the transmitter set to the lowest, middle, and highest channels.

| EMI Test Receiver | Setting  |
|-------------------|----------|
| Attenuation       | Auto     |
| RBW               | 100KHz   |
| VBW               | 300KHz   |
| Detector          | Peak     |
| Trace             | Max hold |

##### For Radiated emission Test

The EUT was placed on a styrofoam table which is 1.5m above ground plane.

The measurement procedure at the band edges was simplified by performing the measurement in just one plot. Both, the in-band-emission and the unwanted emission were encompassed by the span. After trace stabilization, the maximum peak was determined by a peak detector and the value was marked by an appropriate limit line. The second limit line, which is 20dB below the first, marks the limit for the emissions in the unrestricted band. A maximum-peak-detector marks the highest emission in the unrestricted band next to the band edge.

The measurements were performed at the lower end of the 2.4GHz band.

Use the following spectrum analyzer settings:

For Restricted Band, When spectrum scanned above 1GHz setting resolution bandwidth 1MHz, video bandwidth 3MHz:

| EMI Test Receiver | Setting  |
|-------------------|----------|
| Attenuation       | Auto     |
| RBW               | 1MHz     |
| VBW               | 3MHz     |
| Detector          | Peak     |
| Trace             | Max hold |

| EMI Test Receiver | Setting  |
|-------------------|----------|
| Attenuation       | Auto     |
| RBW               | 1MHz     |
| VBW               | 10Hz     |
| Detector          | Peak     |
| Trace             | Max hold |

### 13.2 Test SET-UP (Block Diagram of Configuration)

For Conducted Test

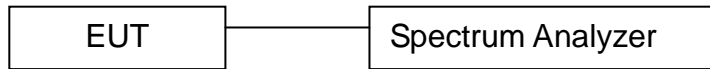

For Radiated emission Test

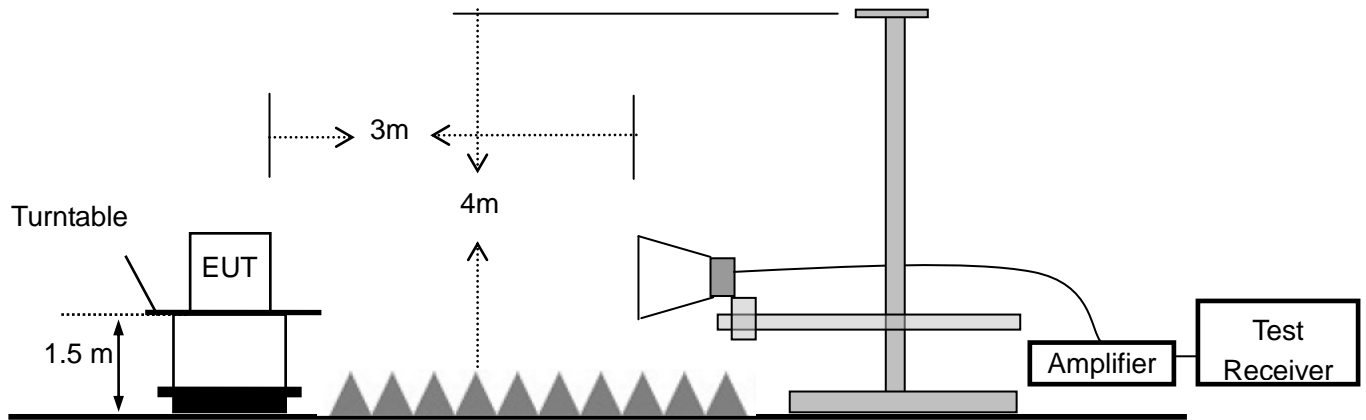

### 13.3 Measurement Equipment Used:

For Conducted Test

| EQUIPMENT TYPE    | MFR                | MODEL NUMBER | SERIAL NUMBER | CALIBRATED UNTIL |
|-------------------|--------------------|--------------|---------------|------------------|
| Spectrum Analyzer | Rohde & Schwarz    | FSV40        | US40240623    | 2021-11-19       |
| Coaxial Cable     | Gigalink Microwave | ZT40         | 19022092      | 2021-11-19       |
| Antenna Connector | ARTHUR-YANG        | 2244-N1TG1   | N/A           | 2021-11-19       |

Remark: The temporary antenna connector is soldered on the PCB board in order to perform conducted tests and this temporary antenna connector is listed in the equipment list.

For Radiated emission Test

| Item | Equipment                    | Manufacturer       | Model No.             | Serial No.      | Calibrated Until |
|------|------------------------------|--------------------|-----------------------|-----------------|------------------|
| 1    | Signal Analyzer              | Rohde & Schwarz    | FSV40                 | US40240623      | 2021-11-19       |
| 2    | Broadband RF Power Amplifier | AEROFLEX           | AEROFLEX100KHz-40G Hz | J1013130524 001 | 2021-11-19       |
| 3    | DRG Horn Antenna             | A.H.SYSTEMS        | SAS-574               | J2031090612 123 | 2021-11-19       |
| 4    | RF Cable                     | Gigalink Microwave | ZT40-2.92J-2.92J-2m   | N/A             | 2021-11-19       |
| 5    | RF Cable                     | Gigalink Microwave | ZT40-2.92J-2.92J-0.3m | N/A             | 2021-11-19       |

### 13.4 Measurement Results:

Refer to attached data chart.

|                    |      |               |               |
|--------------------|------|---------------|---------------|
| Spectrum Detector: | PK   | Test Date :   | Oct. 18, 2021 |
| Test By:           | Zero | Temperature : | 24 °C         |
| Test Result:       | PASS | Humidity :    | 53 %          |

#### 1. Conducted Test

For Non-Hopping Mode:

| Frequency (MHz) | Modulation | Peak Power Output(dBm) | Emission(dBm) | Result of Band edge(dBc) | Band edge Limit(dBc) |
|-----------------|------------|------------------------|---------------|--------------------------|----------------------|
| 2369.40         | GFSK       | 5.51                   | -41.33        | 46.84                    | >20dBc               |
| 2329.20         | pi/4-DQPSK | 5.85                   | -42.57        | 48.42                    | >20dBc               |
| 2484.40         | GFSK       | 5.23                   | -37.66        | 42.89                    | >20dBc               |
| 2483.50         | pi/4-DQPSK | 2.46                   | -39.11        | 41.57                    | >20dBc               |

#### Test plots of GFSK

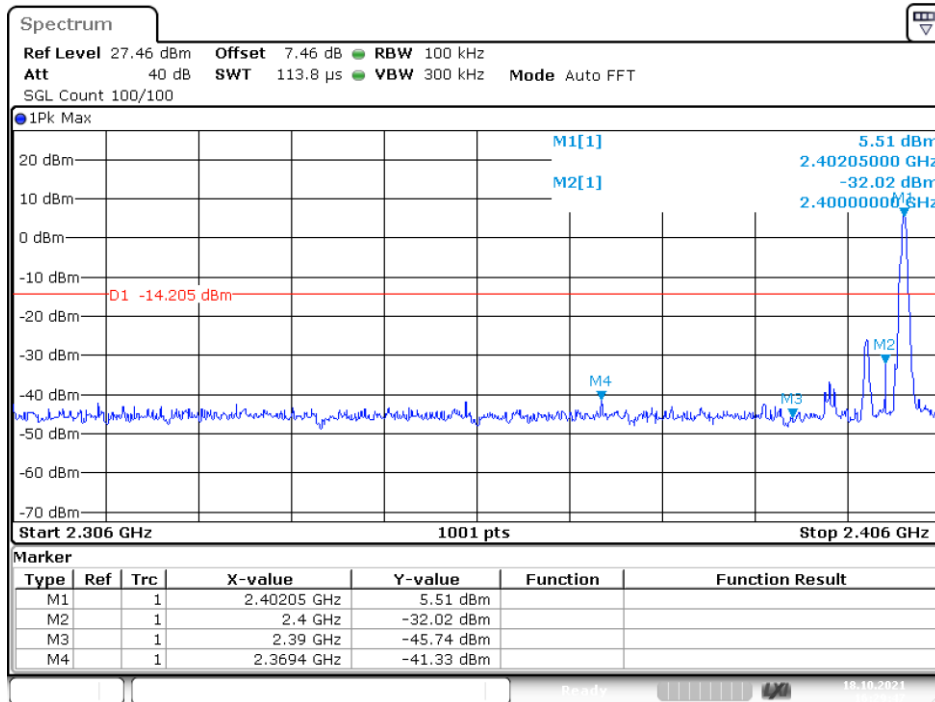

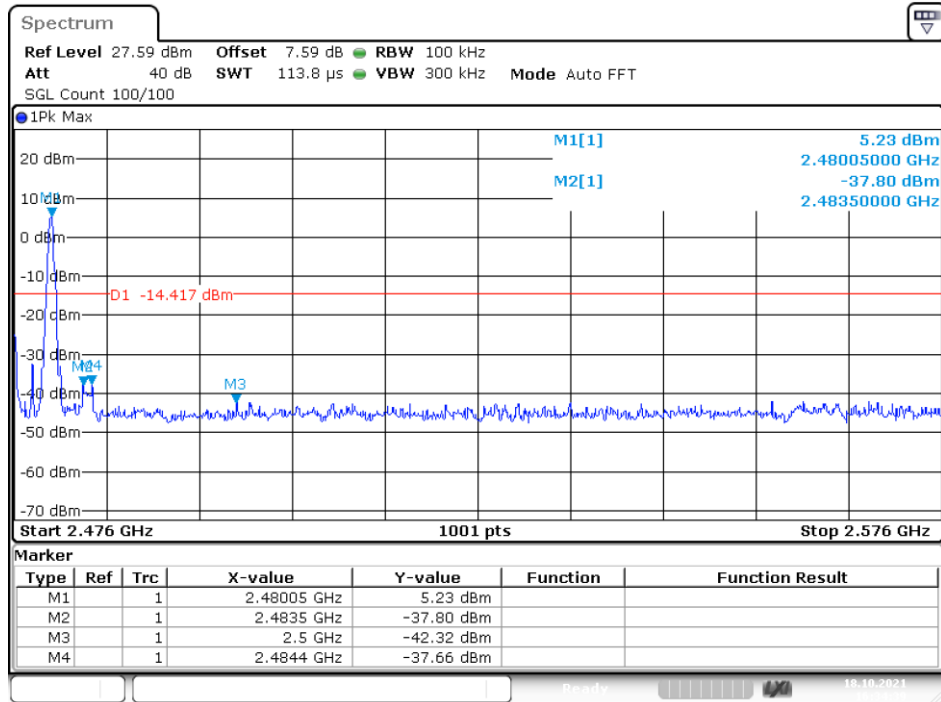

Date: 18.OCT.2021 16:34:39

### Test plots of pi/4-DQPSK

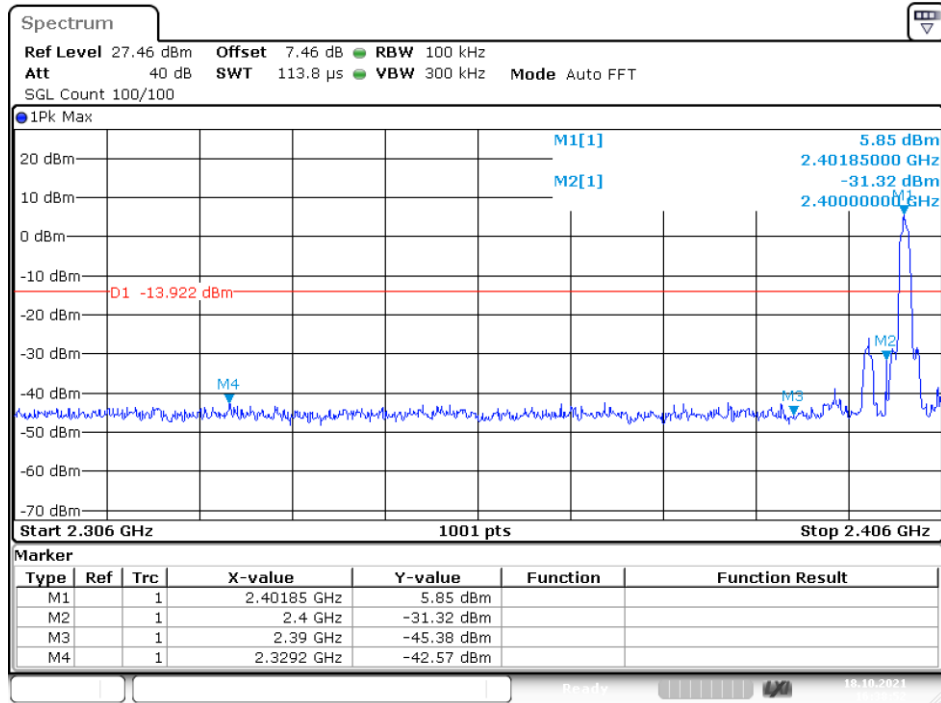

Date: 18.OCT.2021 16:38:52

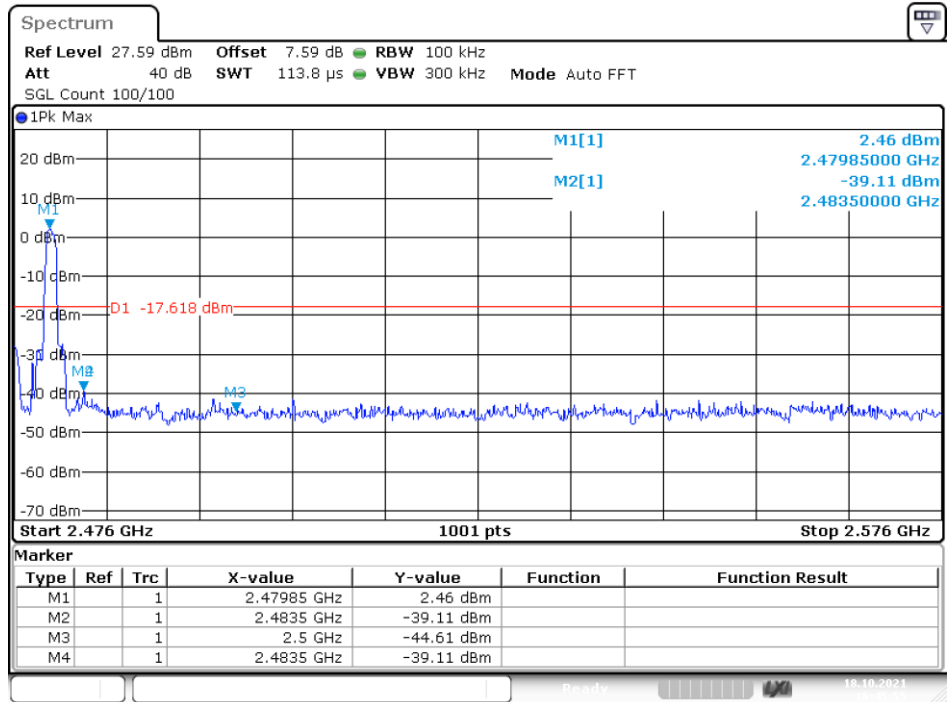

Date: 18.OCT.2021 16:45:55

For Hopping Mode:

| Frequency (MHz) | Modulation | Peak Power Output(dBm) | Emission(dBm) | Result of Band edge(dBc) | Band edge Limit(dBc) |
|-----------------|------------|------------------------|---------------|--------------------------|----------------------|
| 2374.00         | GFSK       | 4.85                   | -41.28        | 46.13                    | >20dBc               |
| 2351.70         | pi/4-DQPSK | 2.76                   | -41.65        | 44.41                    | >20dBc               |
| 2483.50         | GFSK       | 4.54                   | -38.93        | 43.47                    | >20dBc               |
| 2483.80         | pi/4-DQPSK | 0.95                   | -42.63        | 43.58                    | >20dBc               |

### Test plots of GFSK

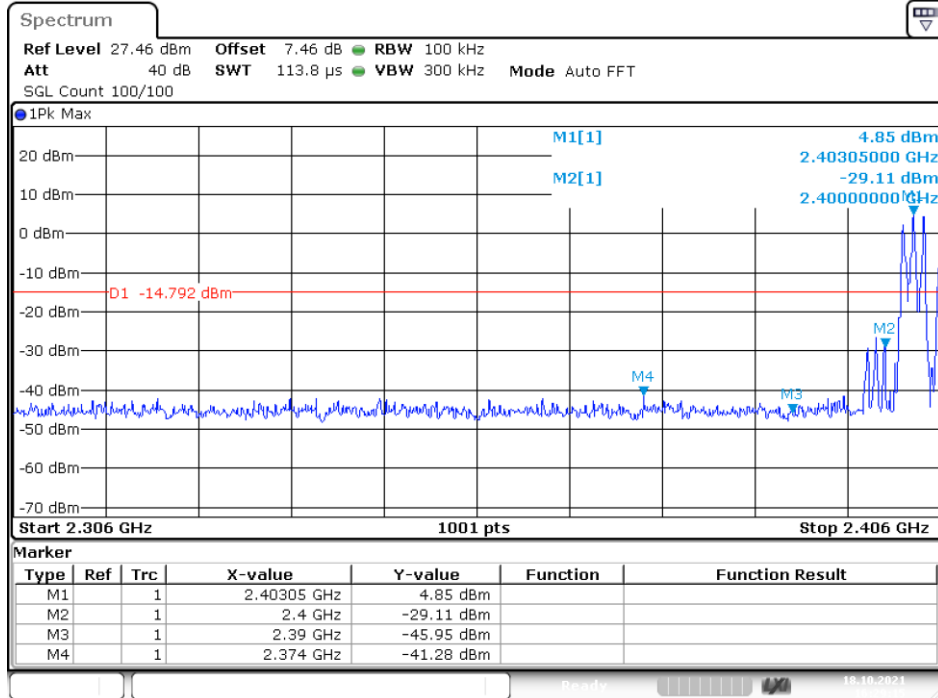

Date: 18.OCT.2021 16:29:14

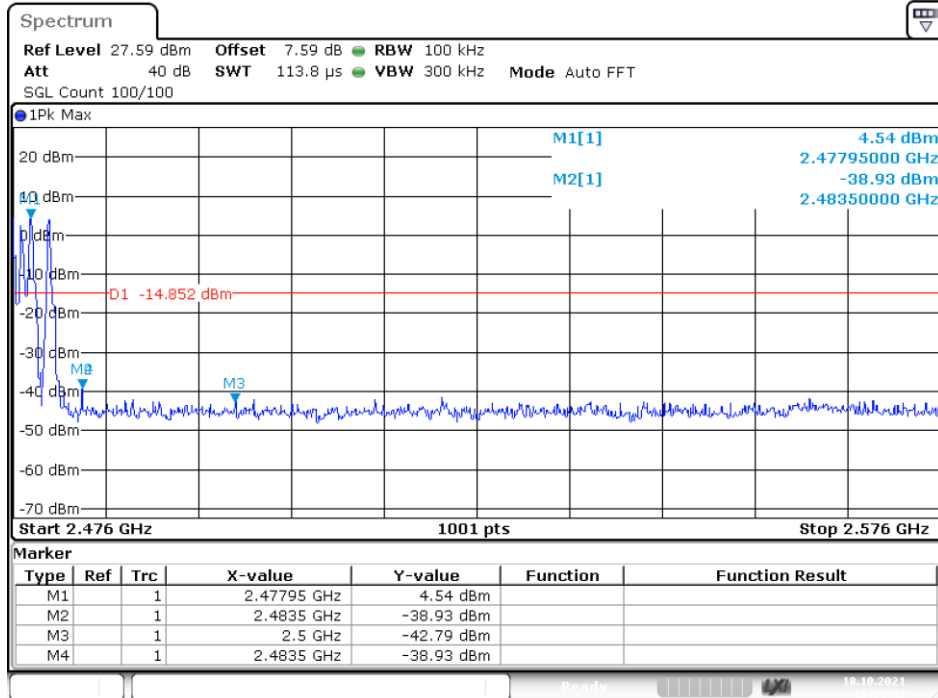

Date: 18.OCT.2021 16:35:32

### Test plots of pi/4-DQPSK

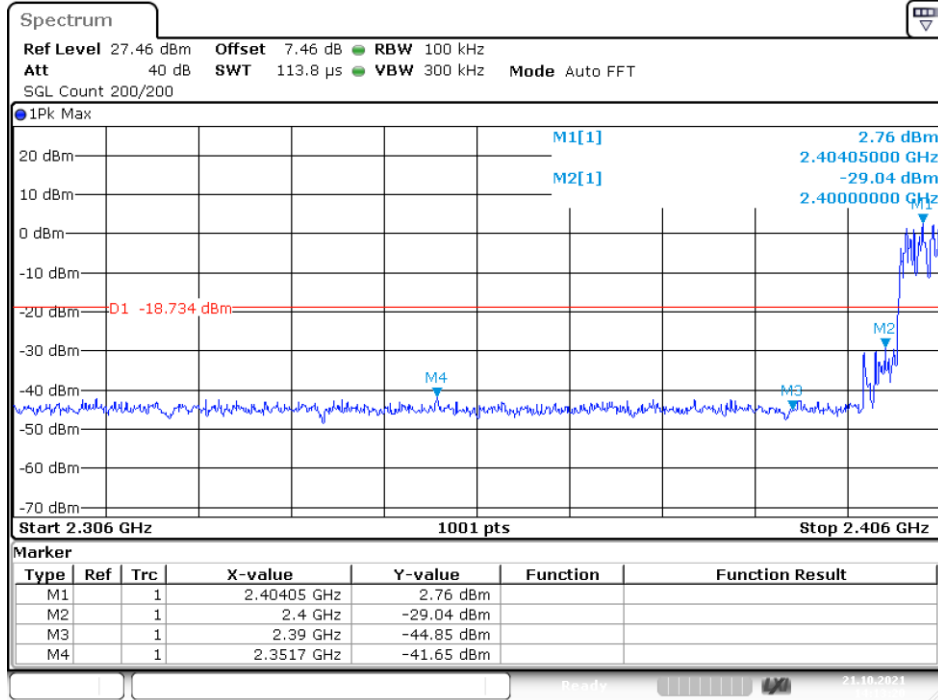

Date: 21.OCT.2021 14:13:20

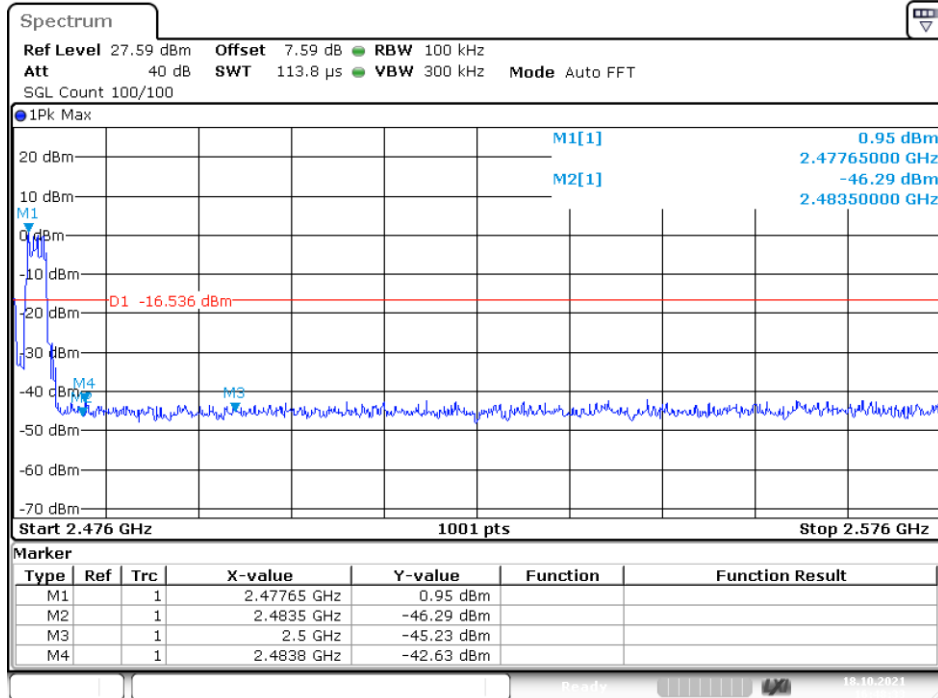

Date: 18.OCT.2021 16:48:33

2. Radiated emission Test

**Worst test modulation  $\Pi$ /4-DQPSK**

For Non-Hopping Mode:

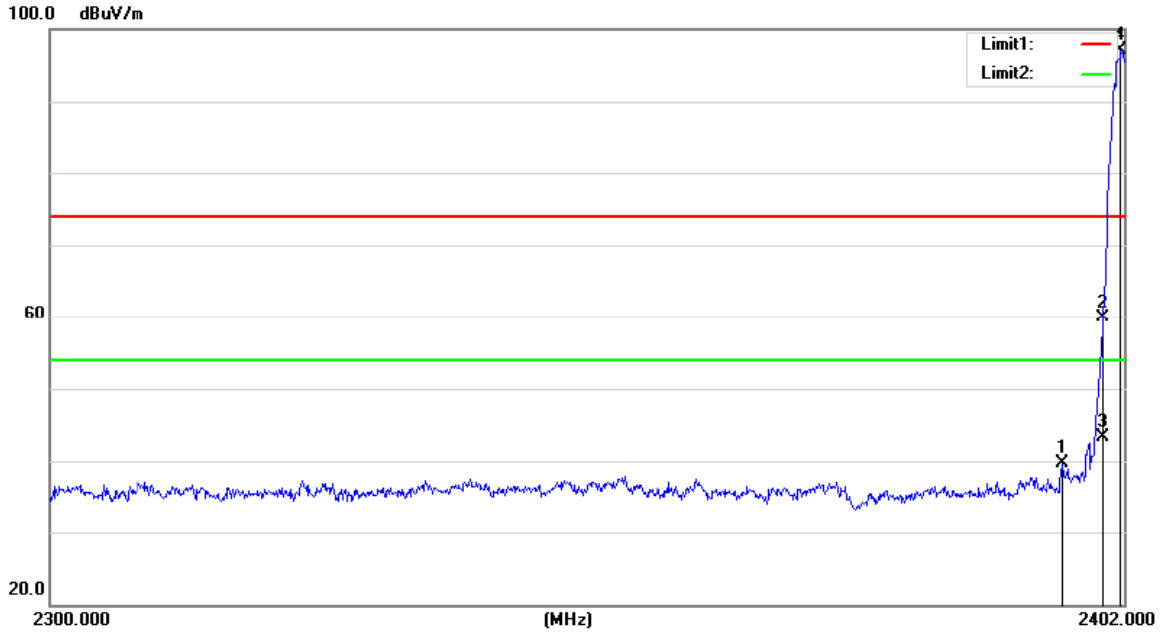

Site site #1      Polarization: **Horizontal**      Temperature: 26  
 Limit: (RE)FCC PART 15 C 3m\_PEAK      Power: Battery 3.7V      Humidity: 55 %  
 Mode:DSS (TX2402)

Note:

| No. | Mk. | Freq.    | Reading Level | Correct Factor | Measurement | Limit  | Over   | Antenna Height | Table Degree | Comment |
|-----|-----|----------|---------------|----------------|-------------|--------|--------|----------------|--------------|---------|
|     |     | MHz      | dBuV          | dB             | dBuV/m      | dBuV/m | dB     | cm             | degree       |         |
| 1   |     | 2396.084 | 60.65         | -20.95         | 39.70       | 74.00  | -34.30 | peak           | 0            |         |
| 2   |     | 2400.000 | 80.87         | -20.93         | 59.94       | 74.00  | -14.06 | peak           | 0            |         |
| 3   |     | 2400.000 | 64.20         | -20.93         | 43.27       | 54.00  | -10.73 | AVG            | 0            |         |
| 4   | *   | 2401.694 | 118.02        | -20.93         | 97.09       | 74.00  | 23.09  | peak           | 0            |         |



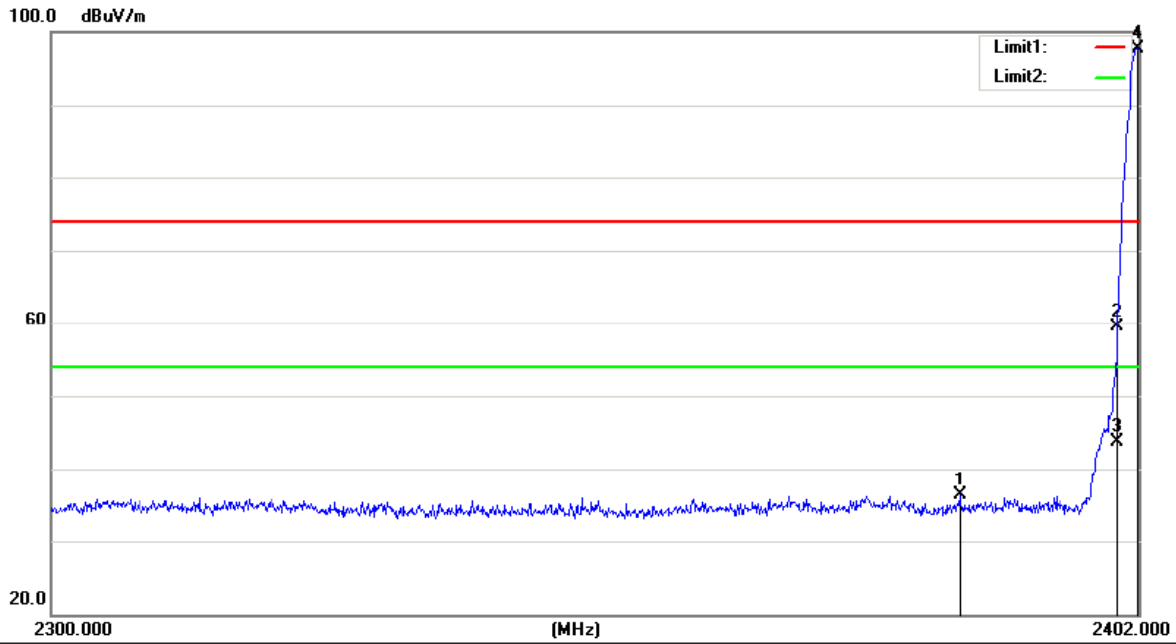

Site site #1 Polarization: **Vertical** Temperature: 26  
 Limit: (RE)FCC PART 15 C 3m\_PEAK Power: Battery 3.7V Humidity: 55 %  
 Mode:DSS (TX2402)  
 Note:

| No. | Mk. | Freq.    | Reading Level | Correct Factor | Measure-ment | Limit  | Over   | Antenna Height | Table Degree | Comment |
|-----|-----|----------|---------------|----------------|--------------|--------|--------|----------------|--------------|---------|
|     |     | MHz      | dBuV          | dB             | dBuV/m       | dBuV/m | dB     | cm             | degree       |         |
| 1   |     | 2385.068 | 56.15         | -19.85         | 36.30        | 74.00  | -37.70 | peak           | 0            |         |
| 2   |     | 2400.000 | 79.22         | -19.77         | 59.45        | 74.00  | -14.55 | peak           | 0            |         |
| 3   |     | 2400.000 | 63.50         | -19.77         | 43.73        | 54.00  | -10.27 | AVG            | 0            |         |
| 4   | *   | 2401.898 | 117.48        | -19.76         | 97.72        | 74.00  | 23.72  | peak           | 0            |         |

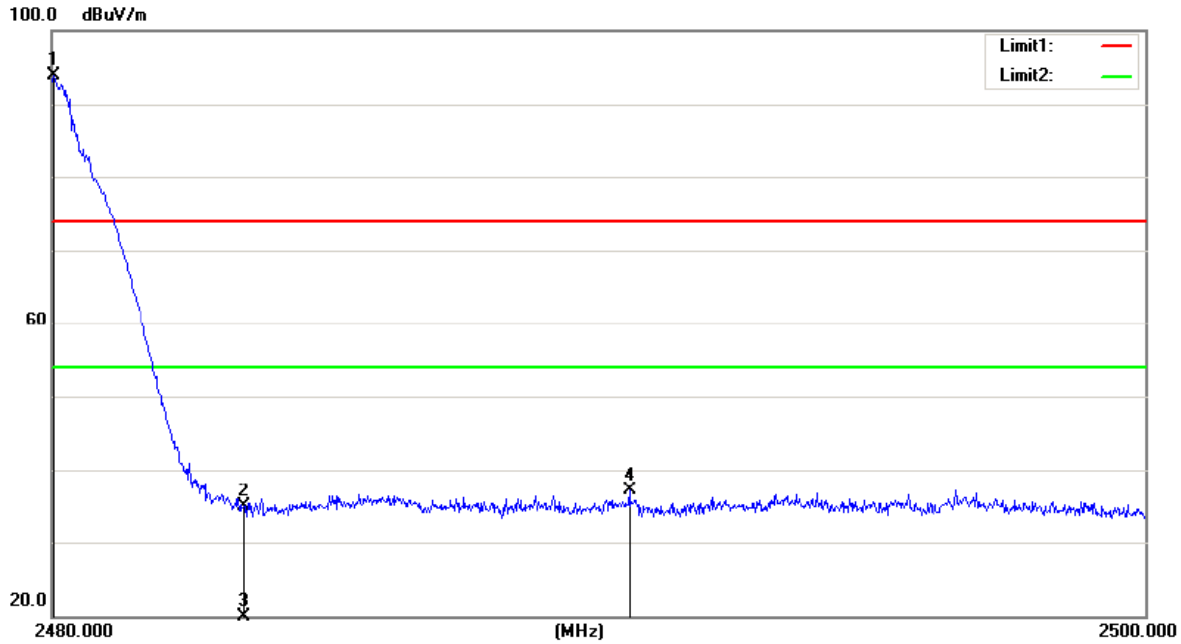

Site site #1 Polarization: **Horizontal** Temperature: 26  
 Limit: (RE)FCC PART 15 C 3m\_PEAK Power: Battery 3.7V Humidity: 55 %  
 Mode:DSS (TX2480)

Note:

| No. | Mk. | Freq.<br>MHz | Reading<br>Level<br>dBuV | Correct<br>Factor<br>dB | Measure-<br>ment<br>dBuV/m | Limit<br>dBuV/m | Over<br>dB | Detector | Antenna<br>Height<br>cm | Table<br>Degree | Comment |
|-----|-----|--------------|--------------------------|-------------------------|----------------------------|-----------------|------------|----------|-------------------------|-----------------|---------|
| 1   | *   | 2480.040     | 114.60                   | -20.71                  | 93.89                      | 74.00           | 19.89      | peak     |                         | 0               |         |
| 2   |     | 2483.500     | 55.55                    | -20.72                  | 34.83                      | 74.00           | -39.17     | peak     |                         | 0               |         |
| 3   |     | 2483.500     | 37.15                    | -20.72                  | 16.43                      | 54.00           | -37.57     | AVG      |                         | 0               |         |
| 4   |     | 2490.540     | 57.78                    | -20.69                  | 37.09                      | 74.00           | -36.91     | peak     |                         | 0               |         |



For Hopping Mode:

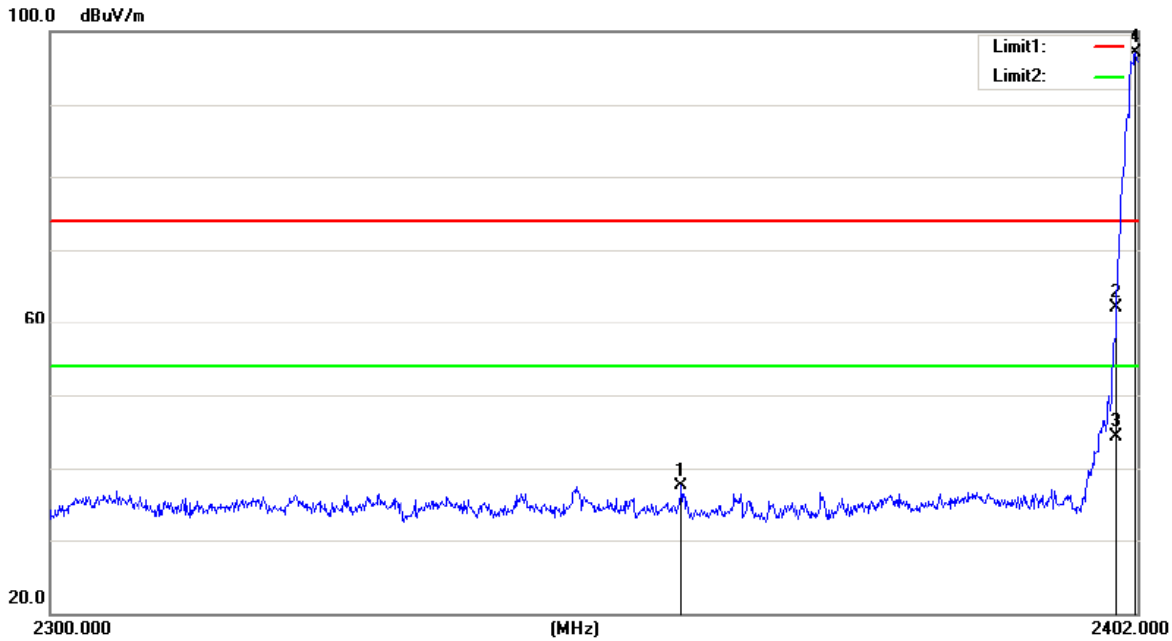

Site site #1      Polarization: **Horizontal**      Temperature: 26  
 Limit: (RE)FCC PART 15 C 3m PEAK      Power: Battery 3.7V      Humidity: 55 %  
 Mode:Hopping

Note:

| No. | Mk. | Freq.    | Reading Level | Correct Factor | Measurement | Limit  | Over   | Antenna Height | Table Degree |         |
|-----|-----|----------|---------------|----------------|-------------|--------|--------|----------------|--------------|---------|
|     |     | MHz      | dBuV          | dB             | dBuV/m      | dBuV/m | dB     | cm             | degree       | Comment |
| 1   |     | 2358.752 | 58.51         | -21.04         | 37.47       | 74.00  | -36.53 | peak           | 0            |         |
| 2   |     | 2400.000 | 83.07         | -20.93         | 62.14       | 74.00  | -11.86 | peak           | 0            |         |
| 3   |     | 2400.000 | 65.32         | -20.93         | 44.39       | 54.00  | -9.61  | AVG            | 0            |         |
| 4   | *   | 2401.796 | 118.09        | -20.93         | 97.16       | 74.00  | 23.16  | peak           | 0            |         |



Report No.: EA21100184F03201

61 of 70

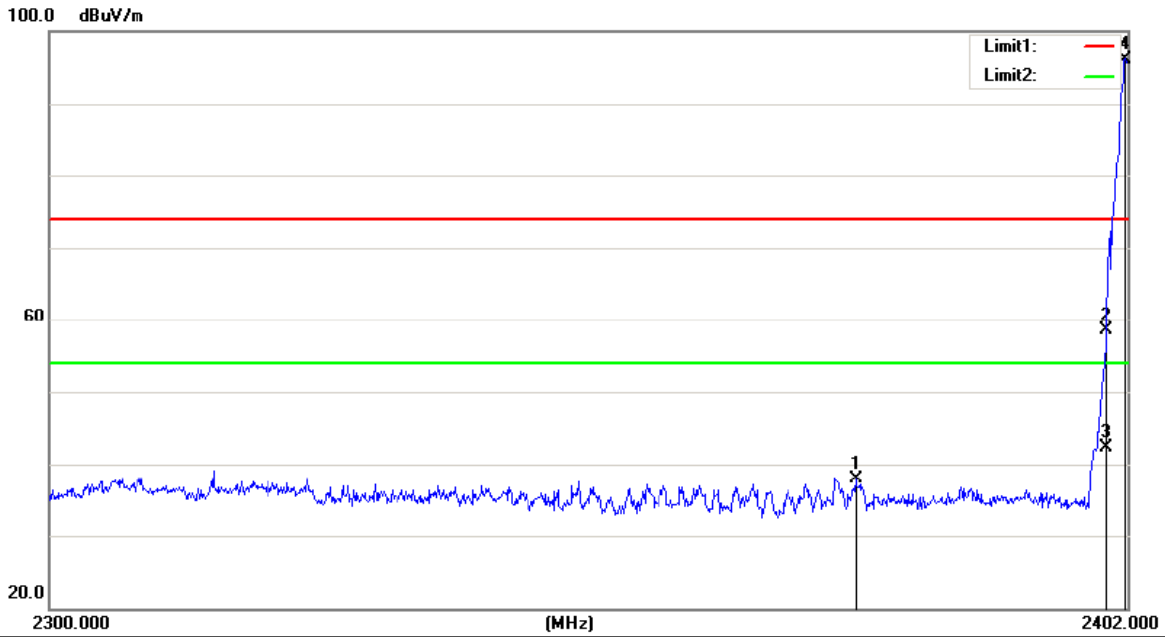

Site site #1 Polarization: **Vertical** Temperature: 26  
 Limit: (RE)FCC PART 15 C 3m\_PEAK Power: Battery 3.7V Humidity: 55 %  
 Mode: Hopping  
 Note:

| No. | Mk. | Freq.    | Reading Level | Correct Factor | Measurement | Limit  | Over   | Antenna Height | Table Degree | Comment |
|-----|-----|----------|---------------|----------------|-------------|--------|--------|----------------|--------------|---------|
|     |     | MHz      | dBuV          | dB             | dBuV/m      | dBuV/m | dB     | cm             | degree       |         |
| 1   |     | 2375.888 | 57.78         | -19.92         | 37.86       | 74.00  | -36.14 | peak           | 0            |         |
| 2   |     | 2400.000 | 78.22         | -19.77         | 58.45       | 74.00  | -15.55 | peak           | 0            |         |
| 3   |     | 2400.000 | 62.10         | -19.77         | 42.33       | 54.00  | -11.67 | AVG            | 0            |         |
| 4   | *   | 2401.796 | 115.96        | -19.76         | 96.20       | 74.00  | 22.20  | peak           | 0            |         |

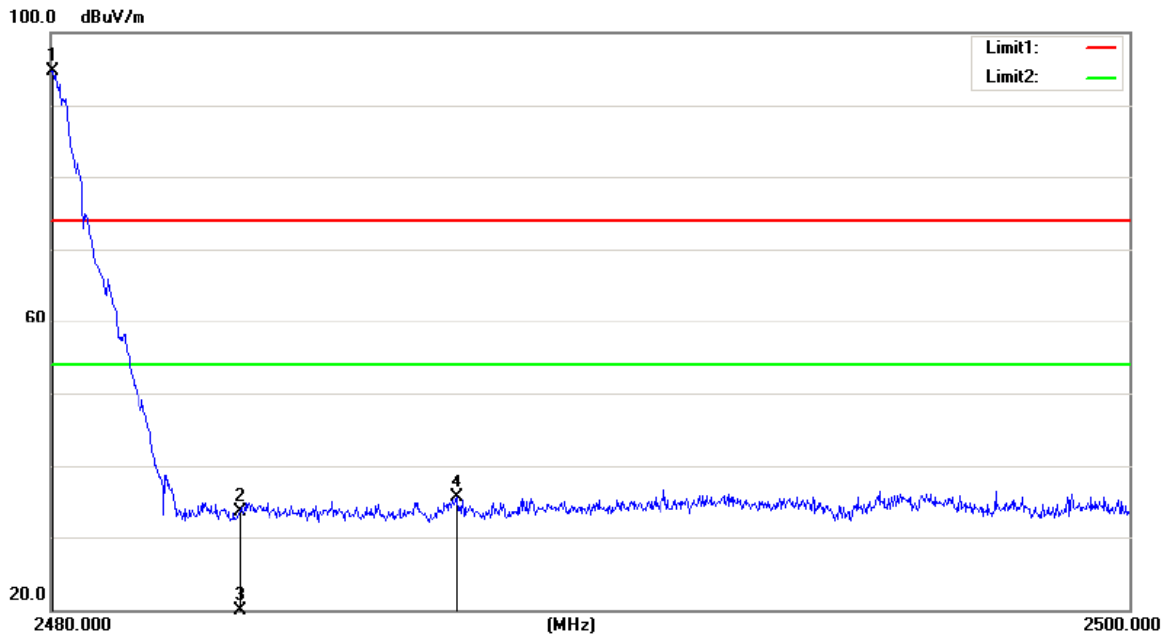

Site site #1 Polarization: **Horizontal** Temperature: 26  
 Limit: (RE)FCC PART 15 C 3m\_PEAK Power: Battery 3.7V Humidity: 55 %  
 Mode: Hopping  
 Note:

| No. | Mk. | Freq.    | Reading Level | Correct Factor | Measurement | Limit  | Over   | Antenna Height | Table Degree | Comment |
|-----|-----|----------|---------------|----------------|-------------|--------|--------|----------------|--------------|---------|
|     |     | MHz      | dBuV          | dB             | dBuV/m      | dBuV/m | dB     | cm             | degree       |         |
| 1   | *   | 2480.040 | 115.34        | -20.71         | 94.63       | 74.00  | 20.63  | peak           | 0            |         |
| 2   |     | 2483.500 | 54.27         | -20.72         | 33.55       | 74.00  | -40.45 | peak           | 0            |         |
| 3   |     | 2483.500 | 37.14         | -20.72         | 16.42       | 54.00  | -37.58 | AVG            | 0            |         |
| 4   |     | 2487.520 | 56.27         | -20.70         | 35.57       | 74.00  | -38.43 | peak           | 0            |         |

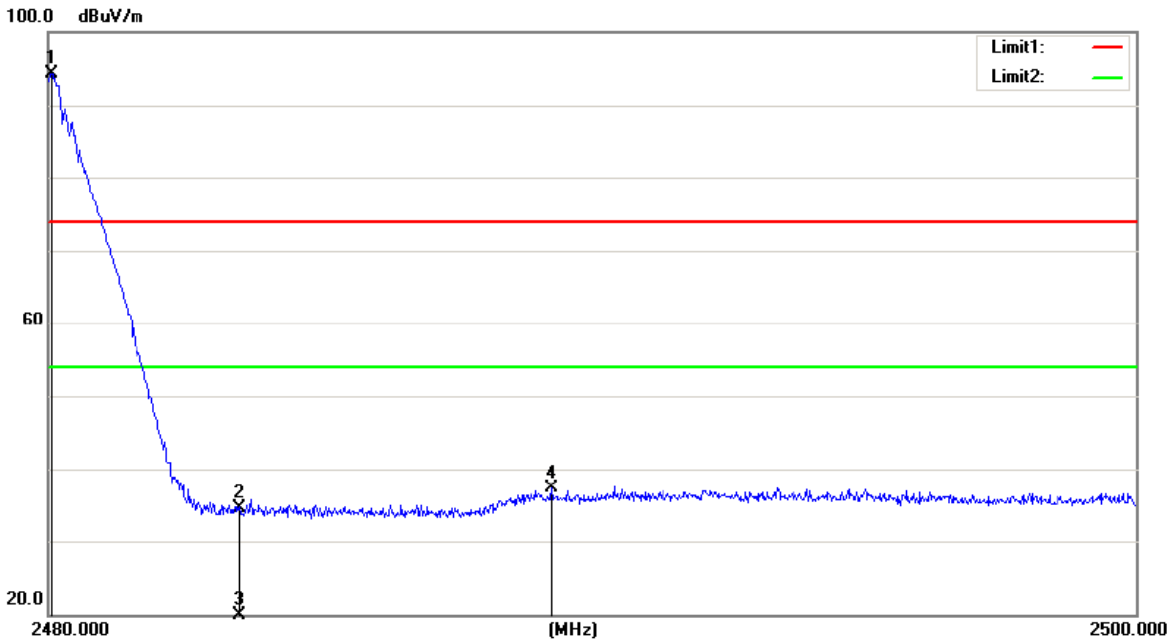

Site site #1 Polarization: *Vertical* Temperature: 26  
 Limit: (RE)FCC PART 15 C 3m\_PEAK Power: Battery 3.7V Humidity: 55 %  
 Mode:Hopping  
 Note:

| No. | Mk. | Freq.<br>MHz | Reading<br>Level<br>dBuV | Correct<br>Factor<br>dB | Measure-<br>ment<br>dBuV/m | Limit<br>dBuV/m | Over<br>dB | Antenna<br>Height<br>cm | Table<br>Degree | Comment |
|-----|-----|--------------|--------------------------|-------------------------|----------------------------|-----------------|------------|-------------------------|-----------------|---------|
| 1   | *   | 2480.060     | 113.50                   | -19.28                  | 94.22                      | 74.00           | 20.22      | peak                    | 0               |         |
| 2   |     | 2483.500     | 53.87                    | -19.27                  | 34.60                      | 74.00           | -39.40     | peak                    | 0               |         |
| 3   |     | 2483.500     | 37.14                    | -19.27                  | 17.87                      | 54.00           | -36.13     | AVG                     | 0               |         |
| 4   |     | 2489.260     | 56.46                    | -19.23                  | 37.23                      | 74.00           | -36.77     | peak                    | 0               |         |

## **14. Antenna Application**

### **14.1 Antenna requirement**

The EUT'S antenna is met the requirement of FCC part 15C section 15.203 and 15.247.

FCC part 15C section 15.247 requirements:

Systems operating in the 2402-2480MHz band that are used exclusively for fixed, point-to-point operations may employ transmitting antennas with directional gain greater than 6dBi provided the maximum peak output power of the intentional radiator is reduced by 1dB for every 3dB that the directional gain of the antenna exceeds 6dBi.

### **14.2 Result**

The EUT's antenna, permanent attached antenna, used a metal PCB antenna and integrated on PCB, The antenna's gain is -0.58dBi and meets the requirement.





## APPENDIX (Photos of EUT)

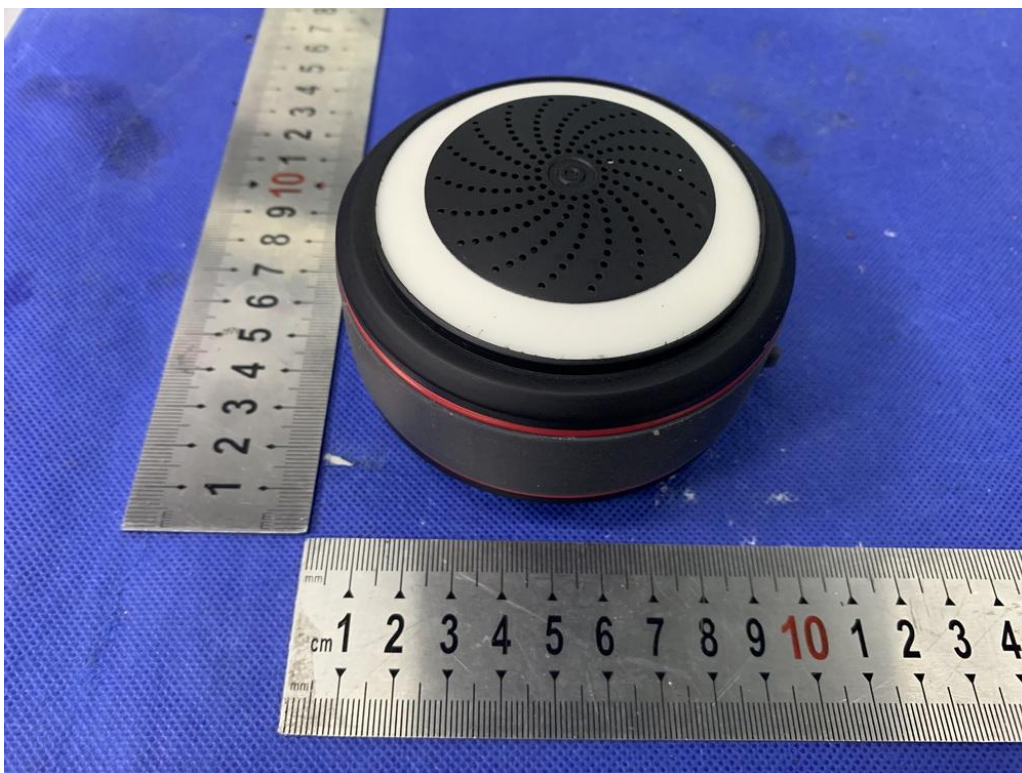
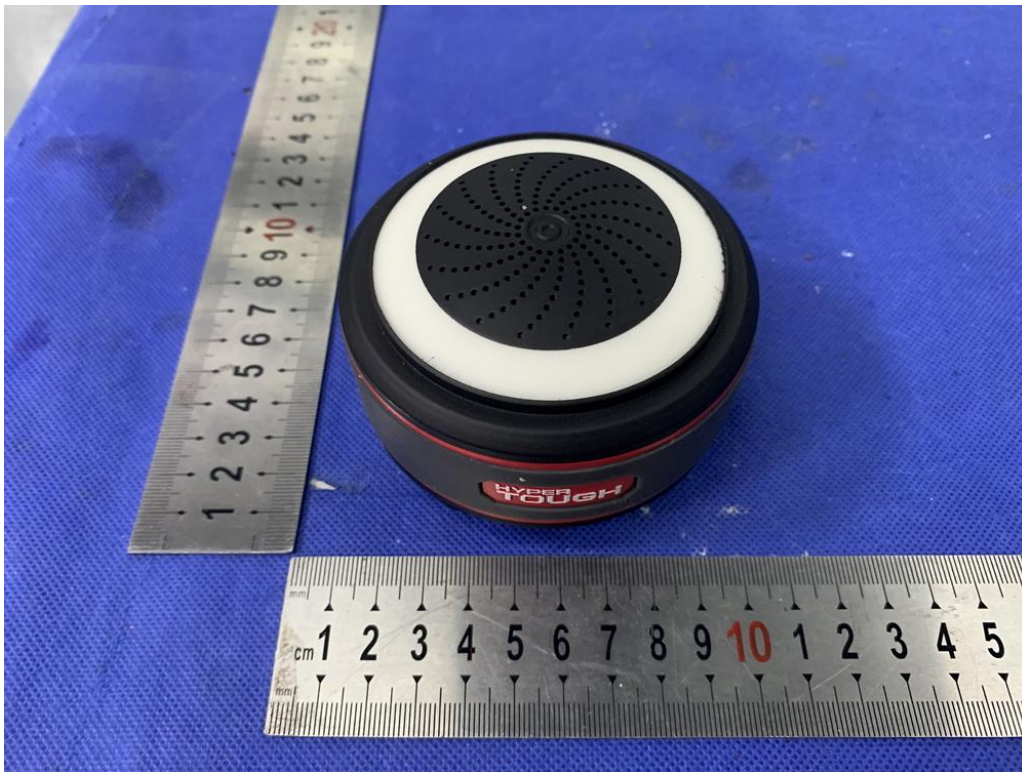



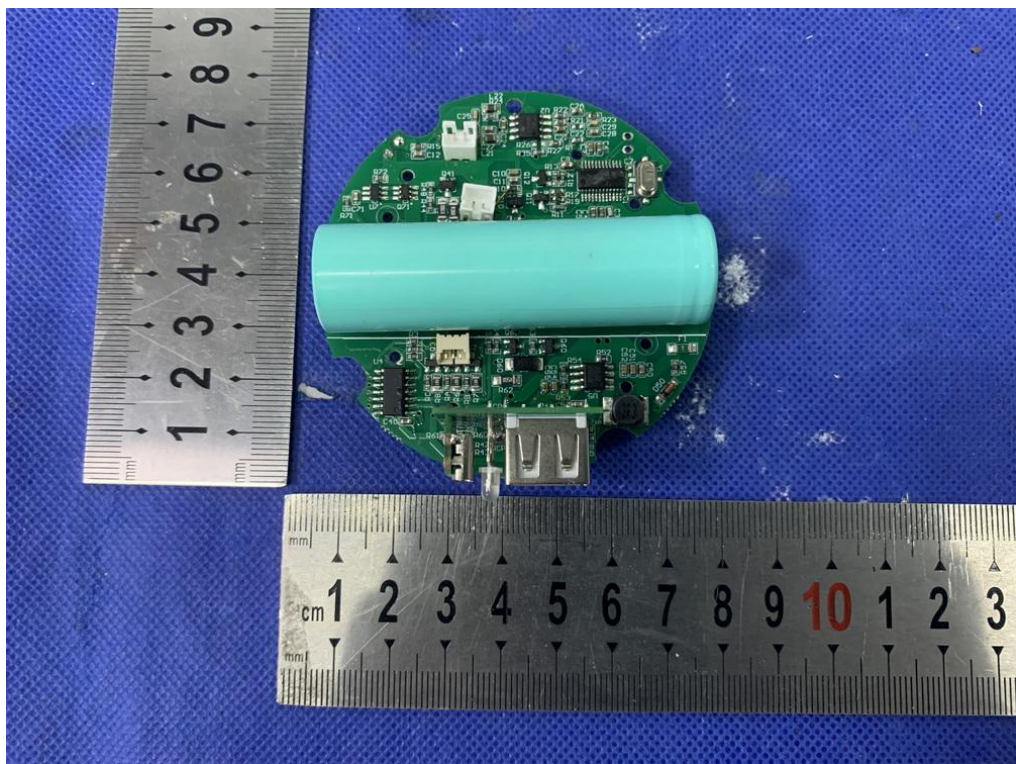
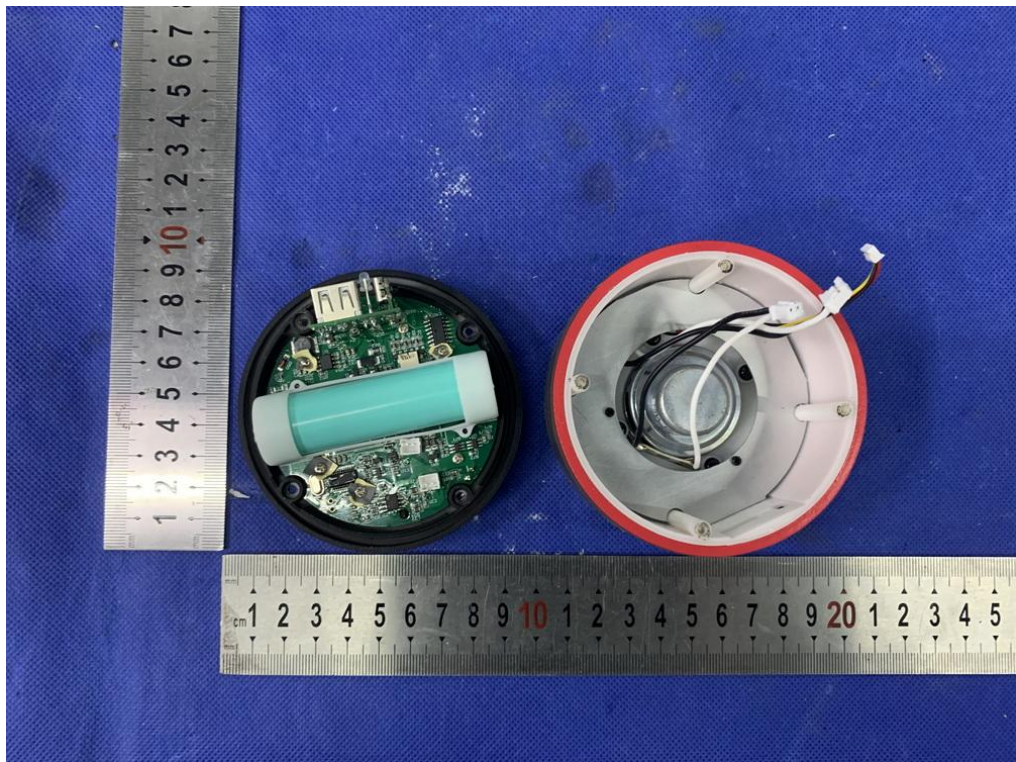

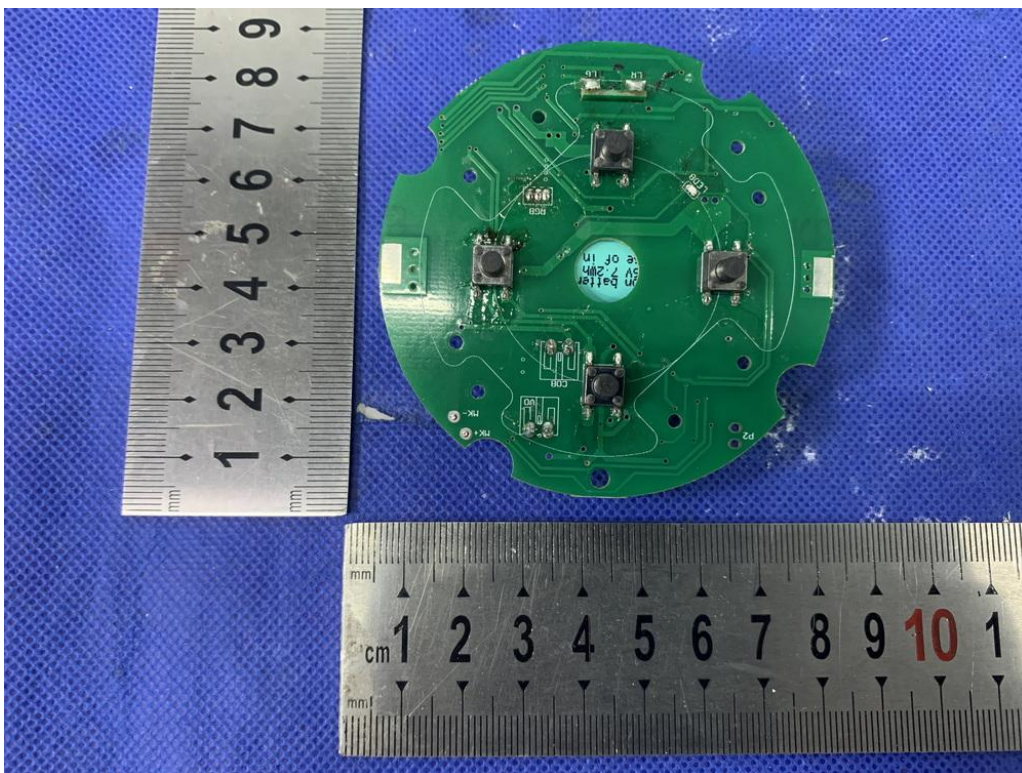
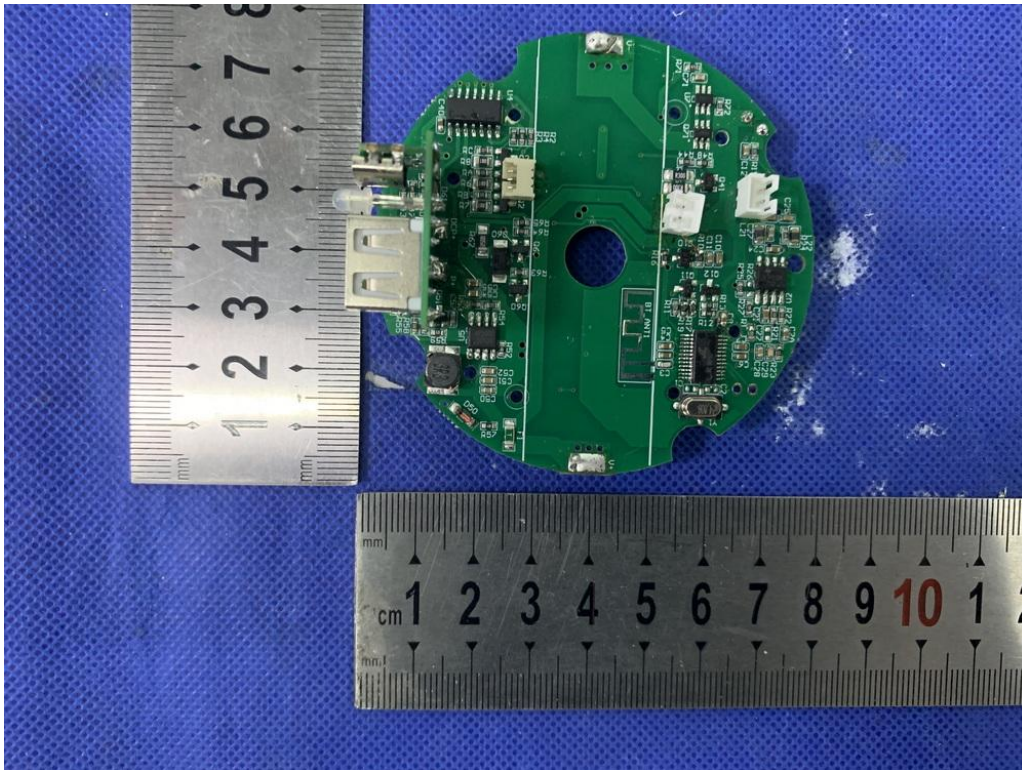

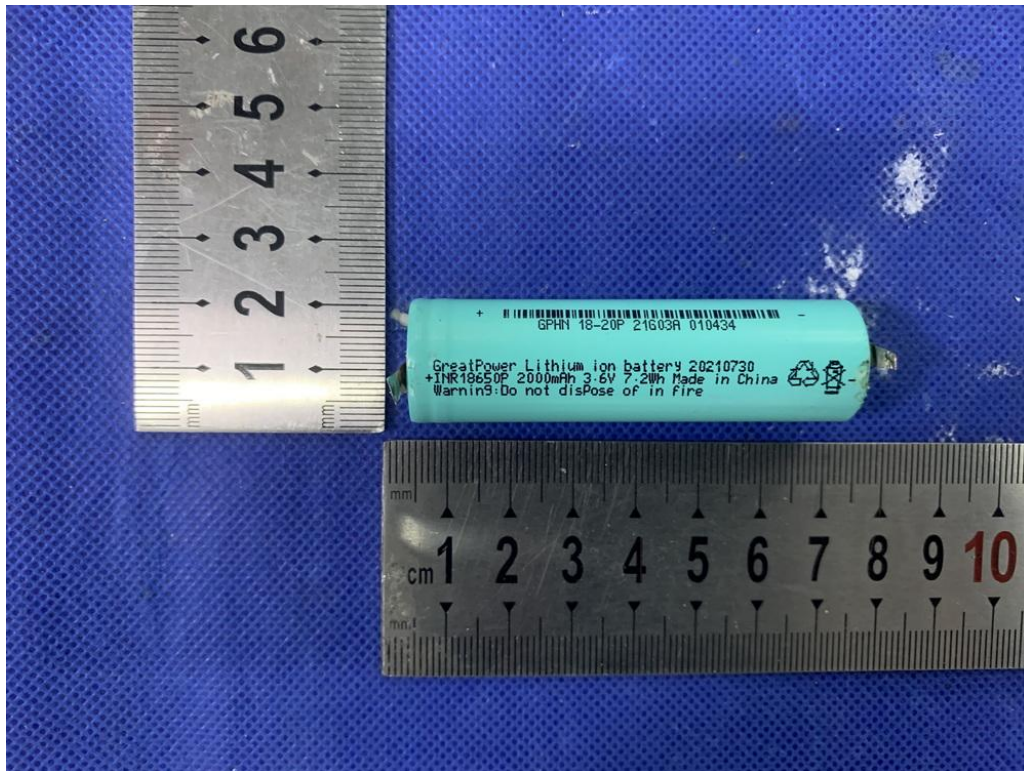

-----The end of Report-----