



FCC Part 15.247

TEST REPORT

For

3Egreen Technology, INC.

5F, No. 283 Songjiang Road, Zhongshan District, Taipei, Taiwan

FCC ID: 2AMHJRP01000000

Report Type: Original Report	Product Type: Tiny BLE to Sub-1G Repeater
Report Producer : <u>Kaylee Chiang</u> <i>Kaylee Chiang</i>	
Report Number : <u>RXZ190226004-00A</u>	
Report Date : <u>2019-06-06</u>	
Reviewed By: <u>Jerry Chang</u> <i>Jerry Chang</i>	
Prepared By: Bay Area Compliance Laboratories Corp.(Taiwan) 70, Lane 169, Sec. 2, Datong Road, Xizhi Dist., New Taipei City 22183, Taiwan, R.O.C. Tel: +886 (2) 2647 6898 Fax: +886 (2) 2647 6895 www.bacl.com.tw	

Note: This test report is prepared for the customer shown above and for the device described herein. It may not be duplicated or used in part without prior written consent from Bay Area Compliance Laboratories Corp. (Taiwan) The determination of the test results does not require consideration of the uncertainty of the measurement, unless the assessment is required by customer agreement, regulation or standard document specification.

Revision History

Revision	No.	Report Number	Issue Date	Description	Author/ Revised by
1.0	RXZ190226004	RXZ190226004-00A	2019-06-06	Original Report	Kaylee Chiang

TABLE OF CONTENTS

1 General Information 5

1.1 Product Description for Equipment under Test (EUT) 5

1.2 Objective 6

1.3 Related Submittal(s)/Grant(s)..... 6

1.4 Test Methodology..... 6

1.5 Test Facility 6

2 System Test Configuration..... 7

2.1 Description of Test Configuration..... 7

2.2 Equipment Modifications 7

2.3 EUT Exercise Software 7

2.4 Support Equipment List and Details..... 7

2.5 External Cable List and Details 7

2.6 Block Diagram of Test Setup 8

2.7 Duty Cycle..... 10

3 Summary of Test Results..... 11

4 Test Equipment List and Details 12

5 FCC §15.247(i), §1.1310, § 2.1091 - Maximum Permissible Exposure (MPE) 14

5.1 Applicable Standard 14

5.2 RF Exposure Evaluation Result..... 15

6 FCC §15.203 – Antenna Requirements..... 16

6.1 Applicable Standard 16

6.2 Antenna Information 16

7 FCC §15.207(a) – AC Line Conducted Emissions 17

7.1 Applicable Standard..... 17

7.2 Measurement Uncertainty 17

7.3 EUT Setup 18

7.4 EMI Test Receiver Setup 18

7.5 Test Procedure 18

7.6 Corrected Factor & Margin Calculation 19

7.7 Environmental Conditions..... 19

7.8 Test Results 20

7 22

8 FCC §15.209, §15.205 , §15.247(d) – Spurious Emissions 22

8.1 Applicable Standard..... 22

8.2 Measurement Uncertainty 23

8.3 EUT Setup 24

8.4 EMI Test Receiver & Spectrum Analyzer Setup..... 24

8.5 Test Procedure 25

8.6 Corrected Factor & Margin Calculation 25

8.7 Test Results Summary 25

8.8 Environmental Conditions..... 25

8.9 Test Results 26

9 FCC §15.247(a)(2) – 6 dB Emission Bandwidth..... 33

9.1	Applicable Standard.....	33
9.2	Test Procedure.....	33
9.3	Environmental Conditions.....	33
9.4	Test Results	34
10	FCC §15.247(b)(3) – Maximum Output Power	36
10.1	Applicable Standard.....	36
10.2	Test Procedure.....	36
10.3	Environmental Conditions.....	36
10.4	Test Results	36
11	FCC§15.247(d) – 100 kHz Bandwidth of Frequency Band Edge	37
11.1	Applicable Standard.....	37
11.2	Test Procedure.....	37
11.3	Environmental Conditions.....	37
11.4	Test Results	38
12	FCC §15.247(e) – Power Spectral Density	40
12.1	Applicable Standard.....	40
12.2	Test Procedure.....	40
12.3	Environmental Conditions.....	40
12.4	Test Results	41

1 General Information

1.1 Product Description for Equipment under Test (EUT)

Applicant	3Egreen Technology, INC.
	5F, No. 283 Songjiang Road, Zhongshan District, Taipei, Taiwan
Manufacturer	3Egreen Technology, INC.
	5F, No. 283 Songjiang Road, Zhongshan District, Taipei, Taiwan
Brand(Trade) Name	3Egreen
Product (Equipment)	Tiny BLE to Sub-1G Repeater
Main Model Name	RP01
Series Model Name	N/A
Frequency Range	2402 ~ 2480 MHz
Transmit Power	BLE Mode: 3.48 dBm
Modulation Technique	BLE Mode: GFSK
Transmit Data Rate	BLE Mode: 1 Mbps
Number of Channels	BLE Mode: 40 Channels
Antenna Specification	PCB Antenna / 3.3 dBi
Power Operation (Voltage Range)	<input type="checkbox"/> AC 120V/60Hz <input type="checkbox"/> Adapter <input type="checkbox"/> By AC Power Cord <input type="checkbox"/> PoE
	<input checked="" type="checkbox"/> DC Type <input type="checkbox"/> Battery <input type="checkbox"/> DC Power Supply <input checked="" type="checkbox"/> External from USB Cable: 5Vdc <input type="checkbox"/> External DC Adapter
	<input type="checkbox"/> Host System
Received Date	Feb 26, 2019
Date of Test	May 17, 2019 ~ May 23, 2019

**All measurement and test data in this report was gathered from production sample serial number: 190226004 (Assigned by BA CL, Taiwan).*

1.2 Objective

This report is prepared on behalf of *3Egreen Technology, INC.* in accordance with Part 2, Subpart J, Part 15, Subparts A and C of the Federal Communication Commission's rules.

The objective is to determine compliance with FCC Part 15.247 rules for Output Power, Antenna Requirements, 6 dB Bandwidth, Power Spectral Density, 100 kHz Bandwidth of Band Edges Measurement, Conducted and Radiated Spurious Emissions.

1.3 Related Submittal(s)/Grant(s)

FCC Part 15.249 DXX submission with FCC ID: 2AMHJRP01000000

1.4 Test Methodology

All measurements contained in this report were conducted with ANSI C63.10-2013, American National Standard of Procedures for Compliance Testing of Unlicensed Wireless Devices.

1.5 Test Facility

The Test site used by Bay Area Compliance Laboratories Corp. (Taiwan) to collect test data is located on

70, Lane 169, Sec. 2, Datong Road, Xizhi Dist., New Taipei City 22183, Taiwan, R.O.C.

68-3, Lane 169, Sec. 2, Datong Road, Xizhi Dist., New Taipei City 22183, Taiwan, R.O.C.

Bay Area Compliance Laboratories Corp. (Taiwan) Lab is accredited to ISO 17025 by Taiwan Accreditation Foundation (TAF code: 3180) and the FCC designation No.TW3180 under the Mutual Recognition Agreement (MRA) in FCC Test. The facility also complies with the radiated and AC line conducted test site criteria set forth in ANSI C63.10.

The Federal Communications Commission has the reports on file and is listed under FCC Registration No.: 974454. The test site has been approved by the FCC for public use and is listed in the FCC Public Access Link (PAL) database.

2 System Test Configuration

2.1 Description of Test Configuration

For BT BLE mode, there are totally 40 channels.

Channel	Frequency (MHz)	Channel	Frequency (MHz)
1	2402	21	2442
2	2404	--	--
3	2406	--	--
4	2408	38	2476
--	--	39	2478
20	2440	40	2480

For BLE Modes were tested with channel 1, 20 and 40.

2.2 Equipment Modifications

No modification was made to the EUT.

2.3 EUT Exercise Software

The software was used “SmartRF_Studio_7-2.6.1”.

2.4 Support Equipment List and Details

Description	Manufacturer	Model Number	BSMI	FCC ID	S/N
NB	DELL	E6410	N/A	PD98260NGU	10912240367
FIX	N/A	N/A	N/A	N/A	N/A

2.5 External Cable List and Details

Cable Description	Length (m)	From	To
Micro USB Cable	1.5	NB	EUT
Micro USB Cable	1.5	NB	FIX
Control Cable	0.5	FIX	EUT

2.6 Block Diagram of Test Setup

See test photographs attached in setup photos for the actual connections between EUT and support equipment.

Radiation:

Below 1GHz:

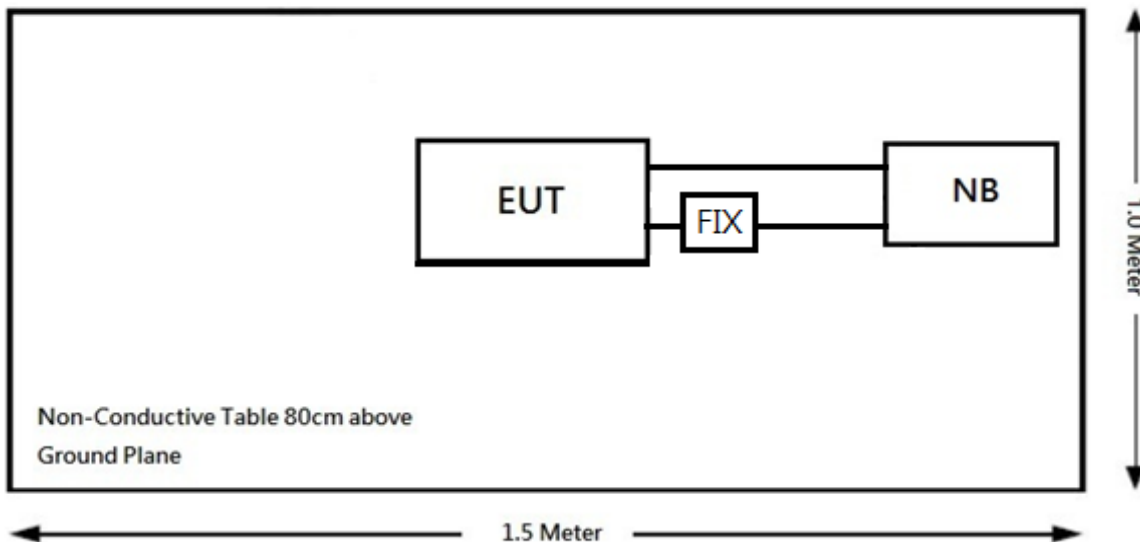

Above 1GHz:

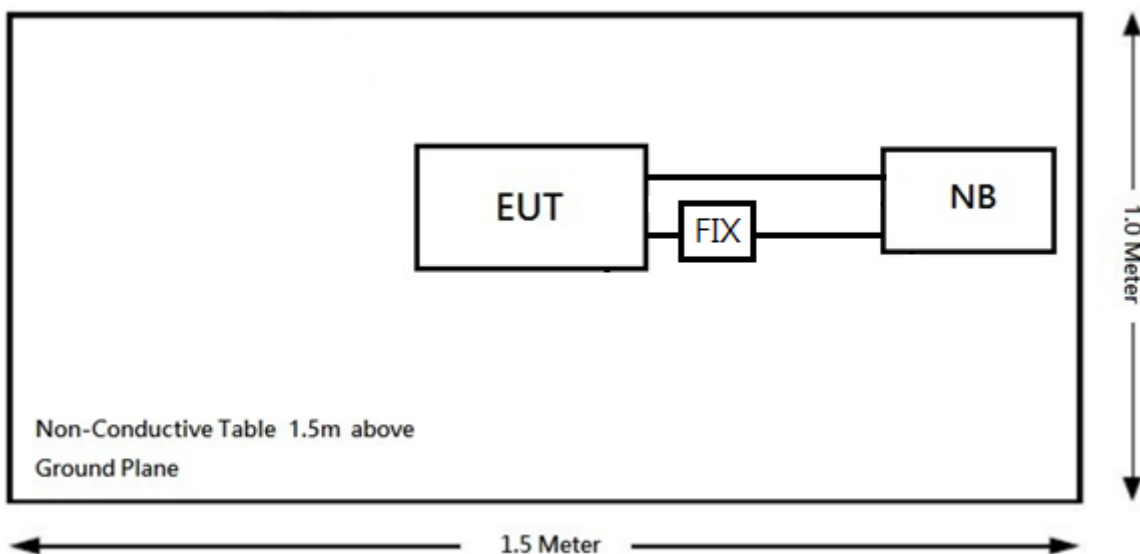

Conduction:

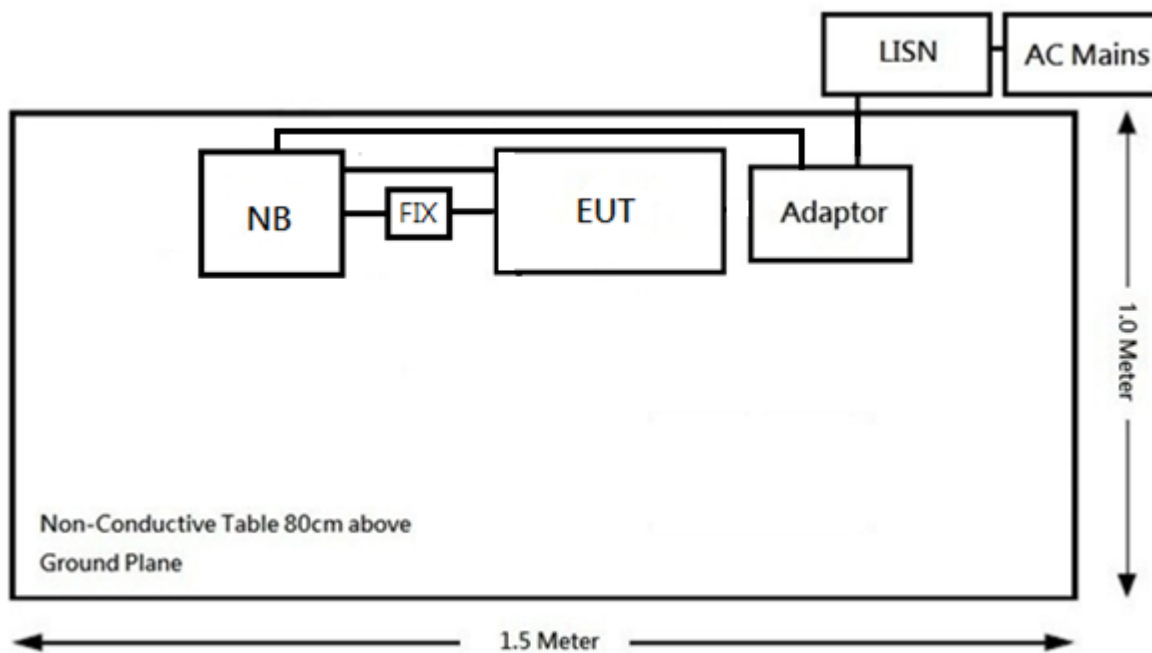

2.7 Duty Cycle

According to KDB 558074 D01 15.247 Meas Guidance v05 section 6.0:

All measurements are to be performed with the EUT transmitting at 100% duty cycle at its maximum power control level; however, if 100% duty cycle cannot be achieved, measurements of duty cycle, x, and maximum power transmission duration, T, are required for each tested mode of operation.

Radio Mode	On Time (ms)	Period (ms)	Duty Cycle (%)	Duty Cycle Correction Factor (dB)
BLE	10	10	100	0

Note: Duty Cycle Correction Factor = $10 \cdot \log(1/\text{duty cycle})$

Please refer to the following plots.

BLE Mode

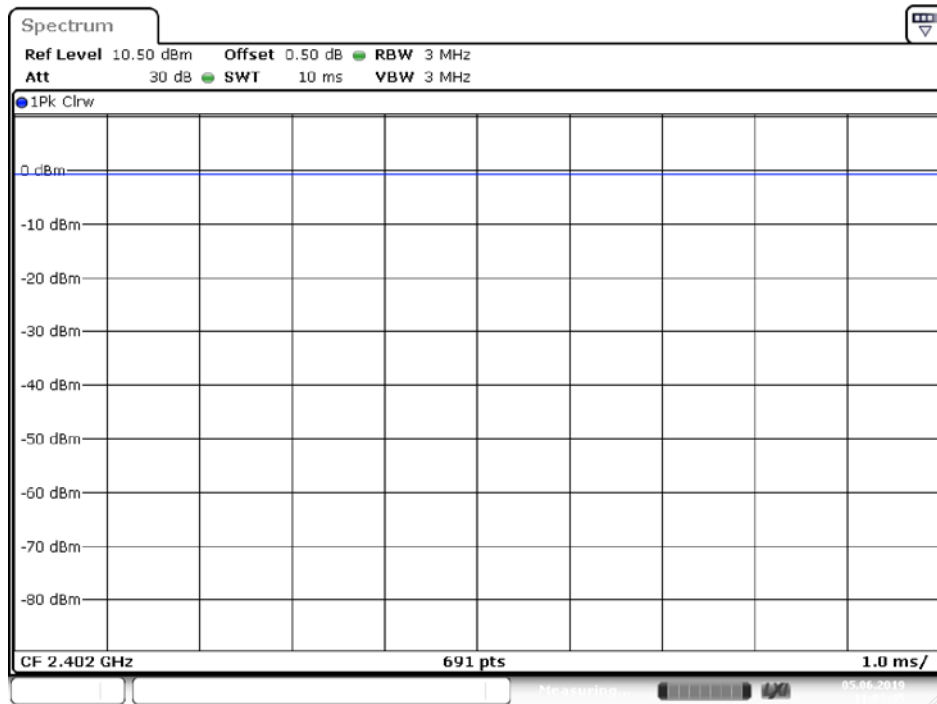

Date: 5.JUN.2019 11:03:46

3 Summary of Test Results

FCC Rules	Description of Test	Results
§15.247(i), §1.1310, §2.1091	Maximum Permissible Exposure (MPE)	Compliance
§15.203	Antenna Requirement	Compliance
§15.207(a)	AC Line Conducted Emissions	Compliance
§15.205, §15.209, §15.247(d)	Spurious Emissions	Compliance
§15.247(a)(2)	6 dB Emission Bandwidth	Compliance
§15.247(b)(3)	Maximum Peak Output Power	Compliance
§15.247(d)	100 kHz Bandwidth of Frequency Band Edge	Compliance
§15.247(e)	Power Spectral Density	Compliance

4 Test Equipment List and Details

Description	Manufacturer	Model	Serial Number	Calibration Date	Calibration Due Date
AC Line Conduction Room (CON-A)					
LISN	Rohde & Schwarz	ENV216	101612	2019/02/21	2020/02/20
EMI Test Receiver	Rohde & Schwarz	ESR7	101419	2018/10/23	2019/10/22
Pulse Limiter	Rohde & Schwarz	ESH3Z2	TXZEM104	2018/08/03	2019/08/02
RF Cable	EMEC	EM-CB5D	001	2018/07/02	2019/07/01
Software	AUDIX	E3	V9.150826k	N.C.R	N.C.R
Radiated Room (966-A)					
Bilog Antenna with 6 dB Attenuator	SUNOL SCIENCES & MINI-CIRCUITS	JB6/UNAT-6+	A050115/1554 2_01	2018/12/11	2019/12/10
Horn Antenna	EMCO	3115	9311-4158	2019/04/17	2020/04/16
Horn Antenna	ETS-Lindgren	3116	62638	2018/08/29	2019/08/28
Preamplifier	Sonoma	310N	130602	2018/07/04	2019/07/03
Preamplifier	EM Electronics Corp.	EM01G18G	060657	2018/12/07	2019/12/06
Microwave Preamplifier	EM Electronics Corporation	EM18G40G	060656	2019/01/11	2020/01/10
EMI Test Receiver	Rohde & Schwarz	ESR7	101419	2018/10/23	2019/10/22
Spectrum Analyzer	Rohde & Schwarz	FSV40	101435	2019/02/13	2020/02/12
Micro flex Cable	UTIFLEX	FSCM 64639 / (2M)	93D0127	2018/07/31	2019/07/30
Micro flex Cable	UTIFLEX	UFA210A-1-3149-300300	MFR64639 226389-001	2018/11/16	2019/11/15
Micro flex Cable	ROSNOL	K1K50-UP0264-K1K50-450CM	160309-1	2019/03/04	2020/03/03
Micro flex Cable	ROSNOL	K1K50-UP0264-K1K50-80CM	160309-2	2019/01/16	2020/01/15
Turn Table	Champro	TT-2000	060772-T	N.C.R	N.C.R
Antenna Tower	Champro	AM-BS-4500-B	060772-A	N.C.R	N.C.R
Controller	Champro	EM1000	60772	N.C.R	N.C.R
Software	Farad	EZ_EM C	BACL-03A1	N.C.R	N.C.R

Description	Manufacturer	Model	Serial Number	Calibration Date	Calibration Due Date
Conducted Room					
Spectrum Analyzer	Rohde & Schwarz	FSV40	101140	2018/11/22	2019/11/21
Cable	WOKEN	SFL402	S02-160323-07	2019/02/11	2020/02/10
Attenuator	MINI-CIRCUITS	BW-S10W5+	N/A	2019/03/07	2020/03/07
Power Sensor	KEYSIGHT	U2021XA	MY54080018	2019/03/06	2020/03/05

**Statement of Traceability: BACL Corp. attests that all of the calibrations on the equipment items listed above were traceable to the SI System of Units via the R.O.C. Center for Measurement Standards of the Electronics Testing Center, Taiwan (ETC) or to another internationally recognized National Metrology Institute (NMI), and were compliant with the current Taiwan Accreditation Foundation (TAF) requirements*

5 FCC §15.247(i), §1.1310, § 2.1091 - Maximum Permissible Exposure (MPE)

5.1 Applicable Standard

According to subpart 15.247(i)and subpart §1.1310, systems operating under the provisions of this section shall be operated in a manner that ensures that the public is not exposed to radio frequency energy level in excess of the Commission’s guidelines.

Limits for Maximum Permissible Exposure (MPE) (§1.1310, §2.1091)

(B) Limits for General Population/Uncontrolled Exposure				
Frequency Range (MHz)	Electric Field Strength (V/m)	Magnetic Field Strength (A/m)	Power Density (mW/cm²)	Averaging Time (minutes)
0.3–1.34	614	1.63	*(100)	30
1.34–30	824/f	2.19/f	*(180/f ²)	30
30–300	27.5	0.073	0.2	30
300–1500	/	/	f/1500	30
1500–100,000	/	/	1.0	30

f = frequency in MHz; * = Plane-wave equivalent power density;

According to §1.1310 and §2.1091 RF exposure is calculated.

Calculated Formulary:

Predication of MPE limit at a given distance

S = PG/4πR² = power density (in appropriate units, e.g. mW/cm²);

P = power input to the antenna (in appropriate units, e.g., mW);

G = power gain of the antenna in the direction of interest relative to an isotropic radiator, the power gain factor, is normally numeric gain;

R = distance to the center of radiation of the antenna (appropriate units, e.g., cm);

For simultaneously transmit system, the calculated power density should comply with:

$$\sum_i \frac{S_i}{S_{Limit,i}} \leq 1$$

5.2 RF Exposure Evaluation Result

MPE evaluation:

Mode	Frequency Range (MHz)	Antenna Gain		Target Power		Evaluation Distance (cm)	Power Density (mW/cm ²)	MPE Limit (mW/cm ²)
		(dBi)	(numeric)	(dBm)	(mW)			
BLE	2402-2480	3.3	2.14	4	2.51	20	0.0011	1
Sub-1G	920.5-924.5	3	1.995	-4	0.398	20	0.0002	0.613

Sub-1G EIRP = 93.83 dBμV/m – 95.23 = -1.4dBm

Conducted Power = -1.4dBm -3dBi = -4.4dBm

MPE evaluation for simultaneous transmission:

BLE and Sub-1G can transmit at the same time, MPE evaluation is as below formula:

$PD1/Limit1+PD2/Limit2+\dots < 1$, PD (Power Density)

MPE evaluation:

MPE of BLE/1 + MPE of Sub-1G/0.613

= 0.0011/1+0.0002/0.613 = 0.001426 < 1.0

Result: MPE evaluation of single and simultaneous transmission meet the requirement of standard.

6 FCC §15.203 – Antenna Requirements

6.1 Applicable Standard

According to § 15.203,

An intentional radiator shall be designed to ensure that no antenna other than that furnished by the responsible party shall be used with the device. The use of a permanently attached antenna or of an antenna that uses a unique coupling to the intentional radiator shall be considered sufficient to comply with the provisions of this section. The manufacturer may design the unit so that a broken antenna can be replaced by the user, but the user of a standard antenna jack or electrical connector is prohibited.

And according to FCC 47 CFR section 15.247 (b), if the transmitting antennas of directional gain greater than 6dBi are used, the power shall be reduced by the amount in dB that the directional gain of the antenna does not exceed 6dBi.

6.2 Antenna Information

Manufacturer	Type	Antenna Gain	Result
Texas Instruments	PCB Antenna	3.3 dBi	Compliance

The EUT has one integral antenna arrangement, which was permanently attached; fulfill the requirement of this section.

7 FCC §15.207(a) – AC Line Conducted Emissions

7.1 Applicable Standard

According to §15.207

For an intentional radiator that is designed to be connected to the public utility (AC) power line, the radio frequency voltage that is conducted back onto the AC power line on any frequency or frequencies within the band 150 kHz to 30 MHz shall not exceed the limits in the following table, as measured using a 50 μH/50 ohms line impedance stabilization network (LISN). Compliance with the provisions of this paragraph shall be based on the measurement of the radio frequency voltage between each power line and ground at the power terminal. The lower limit applies at the boundary between the frequencies ranges.

Frequency of Emission (MHz)	Conducted Limit (dBuV)	
	Quasi-Peak	Average
0.15-0.5	66 to 56 ^{Note 1}	56 to 46 ^{Note 2}
0.5-5	56	46
5-30	60	50

Note 1: Decreases with the logarithm of the frequency.

Note 2: A linear average detector is required

7.2 Measurement Uncertainty

Input quantities to be considered for conducted disturbance measurements maybe receiver reading, attenuation of the connection between LISN/ISN and receiver, LISN/ISN voltage division factor, LISN/ISN VDF frequency interpolation and receiver related input quantities, etc.

Based on CISPR 16-4-2:2011, the expended combined standard uncertainty of conducted disturbance test at Bay Area Compliance Laboratories Corp. (Taiwan) is shown as below. And the uncertainty will not be taken into consideration for the test data recorded in the report

Port	Expanded Measurement uncertainty
AC Mains	4.22 dB (k=2, 95% level of confidence)

7.3 EUT Setup

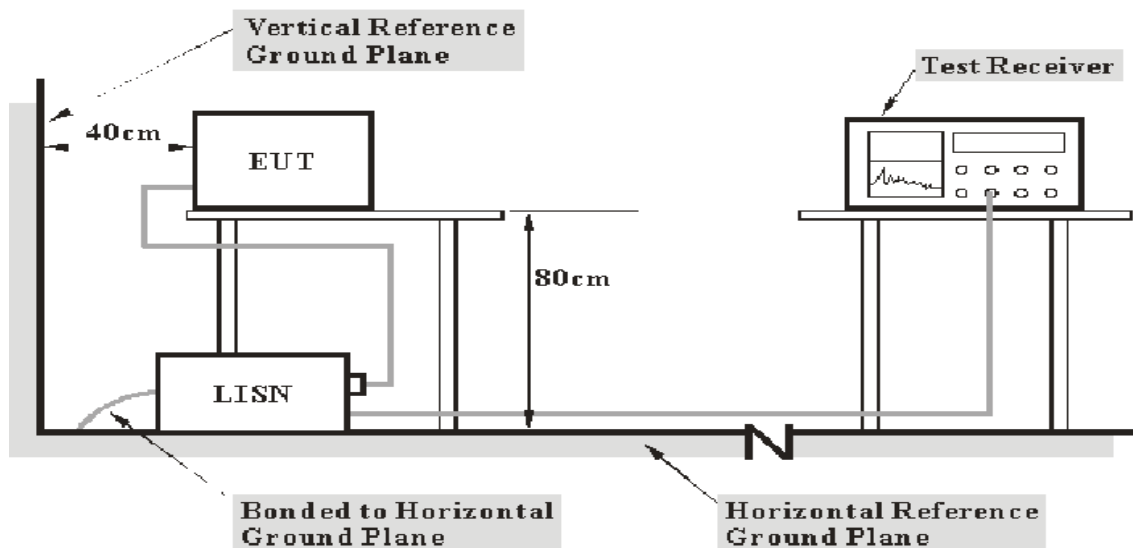

- Note:**
1. Support units were connected to second LISN.
 2. Both of LISNs (AMN) 80 cm from EUT and at the least 80 cm from other units and other metal planes support units.

The setup of EUT is according with per ANSI C63.10-2013 measurement procedure. The specification used was with the FCC Part 15.207 limits.

7.4 EMI Test Receiver Setup

The EMI test receiver was set to investigate the spectrum from 150kHz to 30MHz.

During the conducted emission test, the EMI test receiver was set with the following configurations

Frequency Range	IF B/W
150kHz – 30MHz	9kHz

7.5 Test Procedure

During the conducted emission test, the adapter was connected to the outlet of the LISN.

Maximizing procedure was performed on the six (6) highest emissions of the EUT.

All data was recorded in the Quasi-peak and average detection mode.

7.6 Corrected Factor & Margin Calculation

The factor is calculated by adding LISN/ISN VDF (Voltage Division Factor), Cable Loss and Transient Limiter Attenuation. The basic equation is as follows:

$$\text{Factor} = \text{LISN VDF} + \text{Cable Loss} + \text{Transient Limiter Attenuation}$$

The “Over Limit” column of the following data tables indicates the degree of compliance with the applicable limit. For example, an over limit of -7 dB means the emission is 7 dB below the limit. The equation for Over Limit calculation is as follows:

$$\text{Over Limit} = \text{Level} - \text{Limit Line}$$

7.7 Environmental Conditions

Temperature:	25 °C
Relative Humidity:	55 %
ATM Pressure:	1010 hPa

The testing was performed by Tom Hsu on 2019-05-31.

7.8 Test Results

Test Mode: Transmitting

Main: AC120 V, 60 Hz, Line

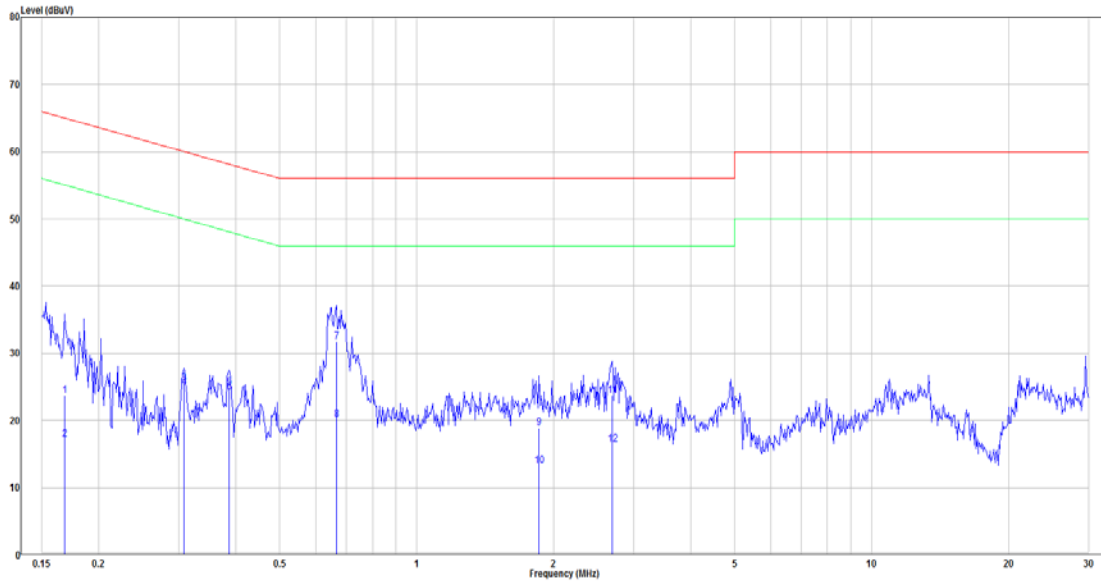

No.	Frequency (MHz)	Reading (dBµV)	Correct Factor(dB)	Result (dBµV)	Limit (dBµV)	Over limit (dB)	Remark
1	0.168	4.29	19.45	23.74	65.05	-41.31	QP
2	0.168	-2.30	19.45	17.16	55.05	-37.89	Average
3	0.307	6.04	19.47	25.51	60.04	-34.53	QP
4	0.307	5.52	19.47	24.99	50.04	-25.05	Average
5	0.387	5.45	19.47	24.92	58.13	-33.22	QP
6	0.387	4.70	19.47	24.17	48.13	-23.97	Average
7	0.666	12.24	19.48	31.73	56.00	-24.27	QP
8	0.666	0.62	19.48	20.11	46.00	-25.89	Average
9	1.859	-0.64	19.54	18.90	56.00	-37.10	QP
10	1.859	-6.21	19.54	13.33	46.00	-32.67	Average
11	2.688	4.14	19.56	23.70	56.00	-32.30	QP
12	2.688	-3.15	19.56	16.41	46.00	-29.59	Average

Note:

Level = Read Level + Factor

Over Limit = Level – Limit Line

Factor = (LISN, ISN, PLC or current probe) Factor + Cable Loss + Attenuator

Main: AC120 V, 60 Hz, Neutral

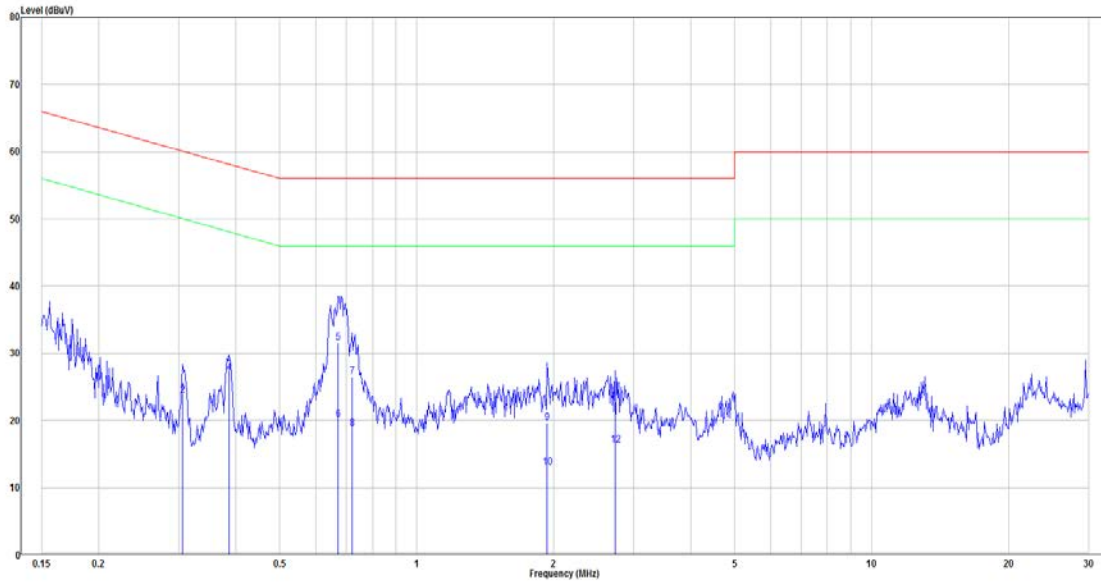

No.	Frequency (MHz)	Reading (dBµV)	Correct Factor(dB)	Result (dBµV)	Limit (dBµV)	Over limit (dB)	Remark
1	0.306	4.61	19.46	24.07	60.08	-36.01	QP
2	0.306	4.30	19.46	23.76	50.08	-26.32	Average
3	0.387	8.02	19.46	27.48	58.13	-30.66	QP
4	0.387	7.52	19.46	26.98	48.13	-21.15	Average
5	0.672	12.11	19.47	31.58	56.00	-24.42	QP
6	0.672	0.64	19.47	20.11	46.00	-25.89	Average
7	0.721	7.10	19.47	26.58	56.00	-29.42	QP
8	0.721	-0.63	19.47	18.84	46.00	-27.16	Average
9	1.934	0.10	19.54	19.63	56.00	-36.37	QP
10	1.934	-6.48	19.54	13.05	46.00	-32.95	Average
11	2.728	3.26	19.56	22.81	56.00	-33.19	QP
12	2.728	-3.16	19.56	16.39	46.00	-29.61	Average

Note:

Level = Read Level + Factor

Over Limit = Level – Limit Line

Factor = (LISN, ISN, PLC or current probe) Factor + Cable Loss + Attenuator

8 FCC §15.209, §15.205 , §15.247(d) – Spurious Emissions

8.1 Applicable Standard

As per FCC §15.35(d): Unless otherwise specified, on any frequency or frequencies above 1000 MHz, the radiated emission limits are based on the use of measurement instrumentation employing an average detector function. Unless otherwise specified, measurements above 1000 MHz shall be performed using a minimum resolution bandwidth of 1MHz.

As Per FCC §15.205(a) except as show in paragraph (d) of this section, only spurious emissions are permitted in any of the frequency bands listed below:

MHz	MHz	MHz	GHz
0.090 – 0.110	16.42 – 16.423	960 – 1240	4.5 – 5.15
0.495 – 0.505	16.69475 – 16.69525	1300 – 1427	5.35 – 5.46
2.1735 – 2.1905	25.5 – 25.67	1435 – 1626.5	7.25 – 7.75
4.125 – 4.128	37.5 – 38.25	1645.5 – 1646.5	8.025 – 8.5
4.17725 – 4.17775	73 – 74.6	1660 – 1710	9.0 – 9.2
4.20725 – 4.20775	74.8 – 75.2	1718.8 – 1722.2	9.3 – 9.5
6.215 – 6.218	108 – 121.94	2200 – 2300	10.6 – 12.7
6.26775 – 6.26825	123 – 138	2310 – 2390	13.25 – 13.4
6.31175 – 6.31225	149.9 – 150.05	2483.5 – 2500	14.47 – 14.5
8.291 – 8.294	156.52475 – 156.52525	2690 – 2900	15.35 – 16.2
8.362 – 8.366	156.7 – 156.9	3260 – 3267	17.7 – 21.4
8.37625 – 8.38675	162.0125 – 167.17	3332 – 3339	22.01 – 23.12
8.41425 – 8.41475	167.72 – 173.2	3345.8 – 3358	23.6 – 24.0
12.29 – 12.293	240 – 285	3600 – 4400	31.2 – 31.8
12.51975 – 12.52025	322 – 335.4		36.43 – 36.5
12.57675 – 12.57725	399.9 – 410		Above 38.6
13.36 – 13.41	608 – 614		

As per FCC §15.209(a): Except as provided elsewhere in this Subpart, the emissions from an intentional radiator shall not exceed the field strength levels specified in the following table:

Frequency (MHz)	Field Strength (micro volts/meter)	Measurement Distance (meters)
0.009 - 0.490	2400/F(kHz)	300
0.490 - 1.705	24000/F(kHz)	30
1.705 - 30.0	30	30
30 - 88	100**	3
88 - 216	150**	3
216 - 960	200**	3
Above 960	500	3

** Except as provided in paragraph (g), fundamental emissions from intentional radiators operating under this Section shall not be located in the frequency bands 54-72 MHz, 76-88 MHz, 174-216 MHz or 470-806 MHz. However, operation within these frequency bands is permitted under other sections of this Part, e.g., Sections 15.231 and 15.241.

As per FCC §15.247 (d) In any 100 kHz bandwidth outside the frequency band in which the spread spectrum or digitally modulated intentional radiator is operating, the radio frequency power that is produced by the intentional radiator shall be at least 20 dB below that in the 100 kHz bandwidth within the band that contains the highest level of the desired power, based on either an RF conducted or a radiated measurement, provided the transmitter demonstrates compliance with the peak conducted power limits. If the transmitter complies with the conducted power limits based on the use of RMS averaging over a time interval, as permitted under paragraph (b)(3) of this section, the attenuation required under this paragraph shall be 30 dB instead of 20 dB. Attenuation below the general limits specified in §15.209(a) is not required. In addition, radiated emissions which fall in the restricted bands, as defined in §15.205(a), must also comply with the radiated emission limits specified in §15.209(a) (see §15.205(c)).

8.2 Measurement Uncertainty

All measurements involve certain levels of uncertainties, especially in field of EMC. The factors contributing to uncertainties are spectrum analyzer, cable loss, antenna factor calibration, antenna directivity, antenna factor variation with height, antenna phase center variation, antenna factor frequency interpolation, measurement distance variation, site imperfections, mismatch (average), and system repeatability.

Based on CISPR 16-4-2:2011, the expended combined standard uncertainty of radiation emissions at Bay Area Compliance Laboratories Corp. (Taiwan) is shown in below table. And the uncertainty will not be taken into consideration for the test data recorded in the report.

Frequency	Measurement uncertainty
30 MHz~200 MHz	3.75 dB (k=2, 95% level of confidence)
200 MHz~1 GHz	4.21 dB (k=2, 95% level of confidence)
1 GHz~6 GHz	4.83 dB (k=2, 95% level of confidence)
6 GHz~18 GHz	5.18 dB (k=2, 95% level of confidence)
18 GHz~26 GHz	4.55 dB (k=2, 95% level of confidence)
26 GHz~40 GHz	4.67 dB (k=2, 95% level of confidence)

8.3 EUT Setup

Below 1 GHz:

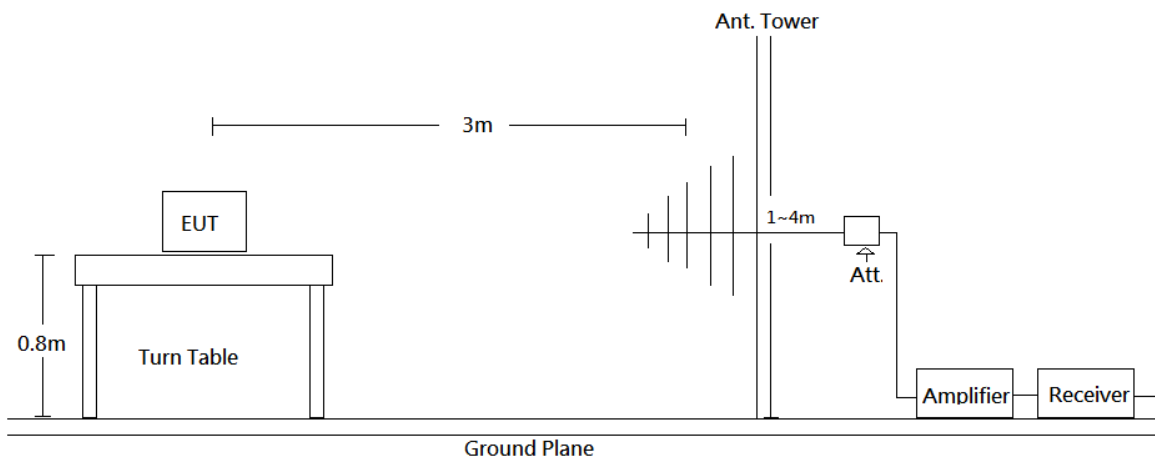

Above 1 GHz:

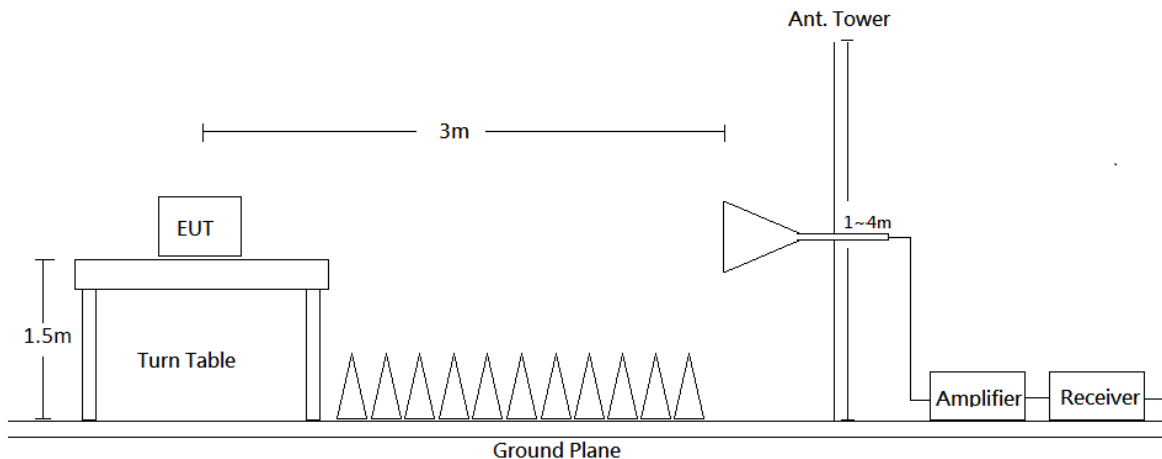

Radiated emission tests were performed in the 3 meters chamber test site, using the setup accordance with the ANSI C63.10-2013. The specification used was the FCC Part 15.209 and FCC 15.247 Limits.

8.4 EMI Test Receiver & Spectrum Analyzer Setup

The system was investigated from 30 MHz to 26.5 GHz. During the radiated emission test, the EMI test receiver was set with the following configurations measurement method 6.3 in ANSI C63.10.

Frequency Range	RBW	VBW	Detector	Duty cycle	Measurement method
30-1000 MHz	120 kHz	/	QP		QP
Above 1 GHz	1 MHz	3 MHz	PK		PK
	1 MHz	3 MHz	RMS	>98%	Ave
	1 MHz	1/T	PK	<98%	Ave

8.5 Test Procedure

Maximizing procedure was performed on the highest emissions to ensure that the EUT complied with all installation combinations.

All data was recorded in the Quasi-peak detector mode from 30 MHz to 1 GHz and PK and average detector modes for frequencies above 1 GHz.

8.6 Corrected Factor & Margin Calculation

The Correct Factor is calculated by adding the Antenna Factor and Cable Loss, and subtracting the Amplifier Gain from the Meter Reading. The basic equation is as follows:

$$\text{Correct Factor} = \text{Antenna Factor} + \text{Cable Loss} - \text{Amplifier Gain}$$

The “Margin” column of the following data tables indicates the degree of compliance with the applicable limit. For example, a margin of -7 dB means the emission is 7 dB below the limit. The equation for margin calculation is as follows:

$$\text{Margin} = \text{Result} - \text{Limit}$$

8.7 Test Results Summary

According to the data in the following table, the EUT complied with the FCC §15.209 Limit.

8.8 Environmental Conditions

Temperature:	25 °C
Relative Humidity:	55 %
ATM Pressure:	1010 hPa

The Radiation Spurious Emissions testing was performed by Tom Hsu on 2019-05-17.

The Conducted Spurious Emissions testing was performed by Tom Hsu on 2019-05-21.

8.9 Test Results

Test Mode: Transmitting

BLE Mode (Pre-scan with three orthogonal axis, and worse case as Y axis.)

Horizontal (worst case is BLE mode high channel)

30MHz-1GHz:

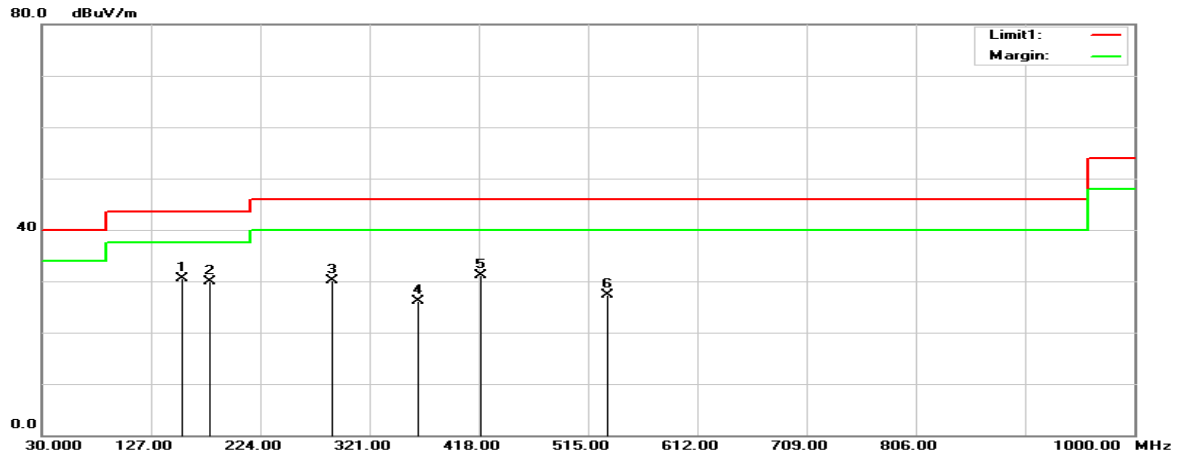

1GHz-18GHz:

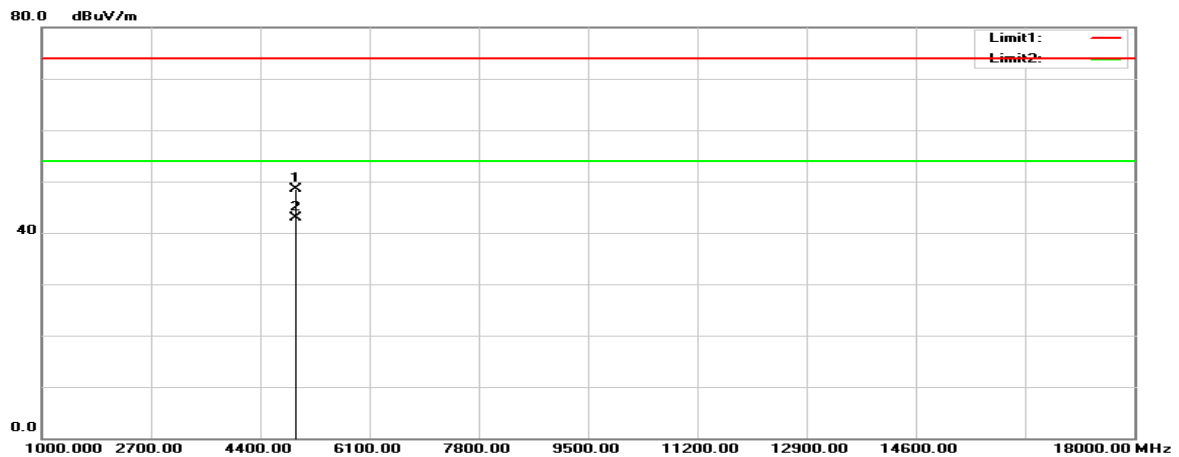

18GHz-26.5GHz:

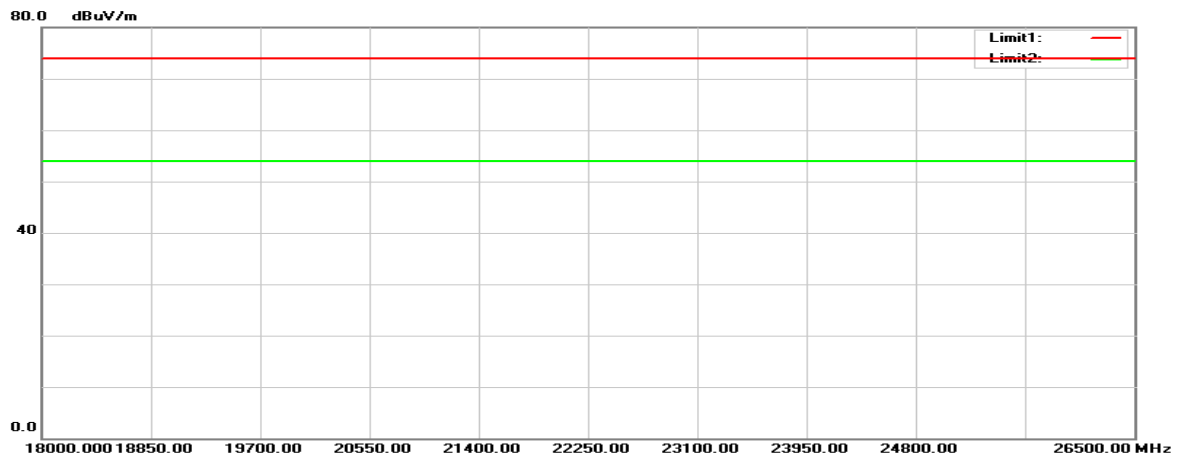

Vertical (worst case is BLE mode low channel)

30MHz-1GHz:

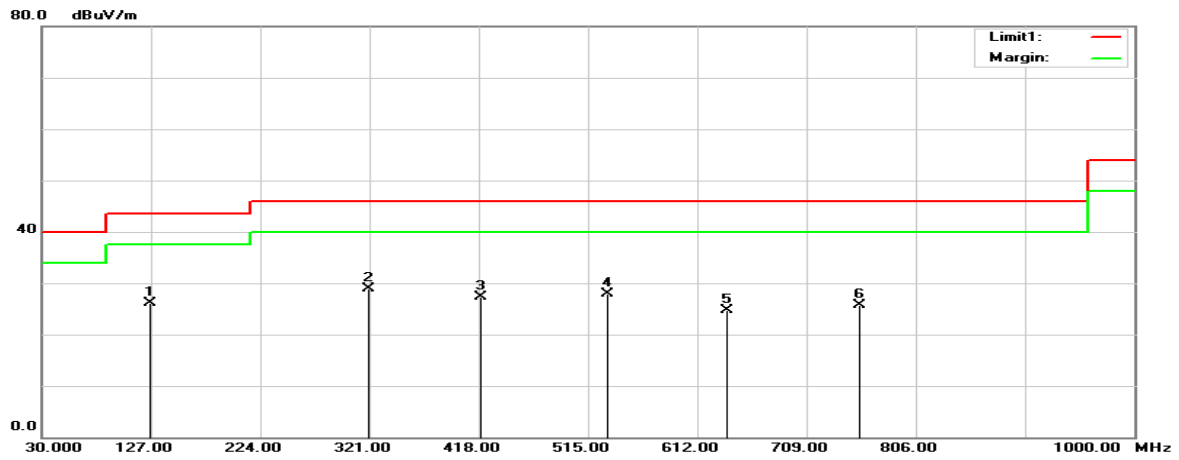

1GHz-18GHz:

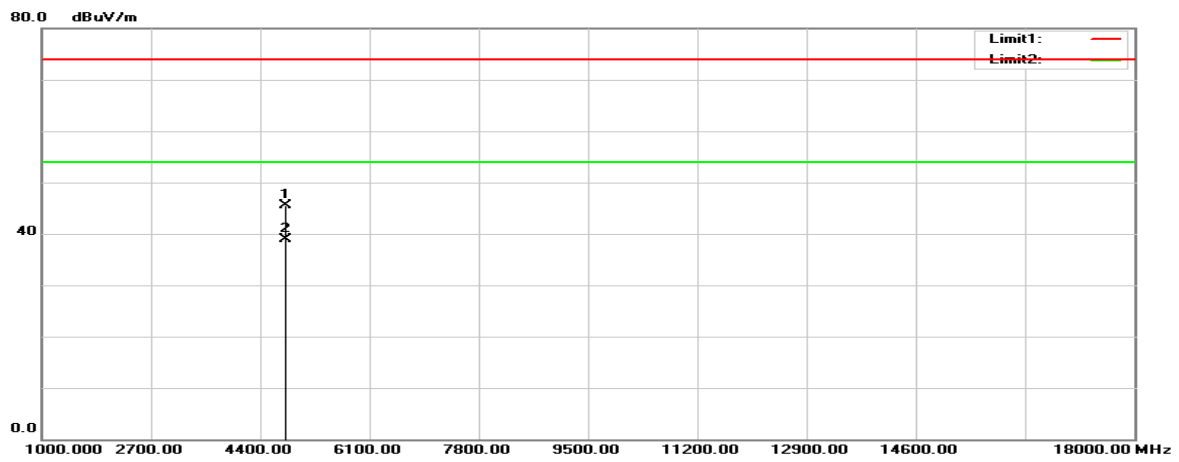

18GHz-26.5GHz:

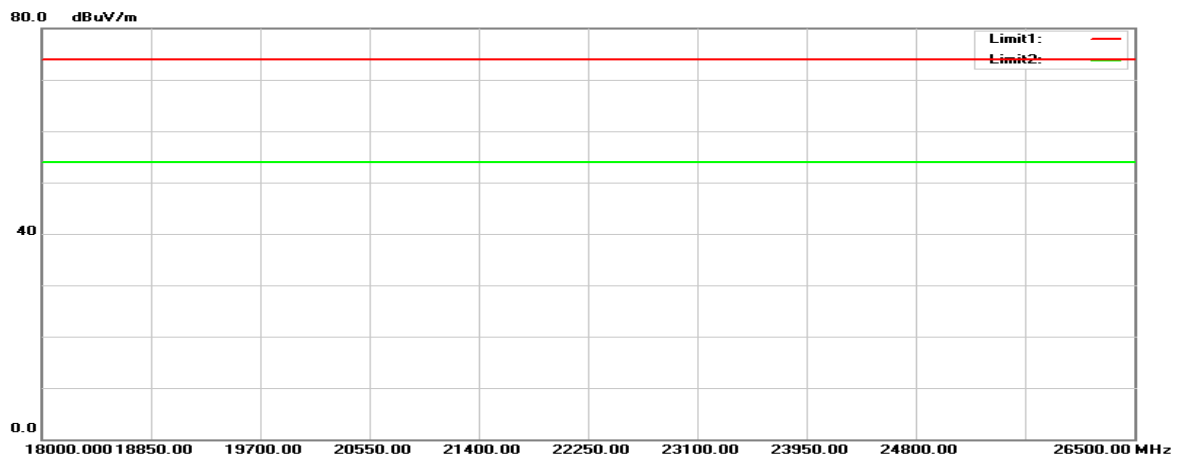

Below 1GHz**Horizontal**

Frequency (MHz)	Reading (dB μ V)	Correct Factor(dB/m)	Result (dB μ V/m)	Limit (dB μ V/m)	Margin (dB)	Height (cm)	Degree ($^{\circ}$)	Remark
154.1600	40.24	-9.73	30.51	43.50	-12.99	100	105	QP
179.3800	41.45	-11.47	29.98	43.50	-13.52	100	325	QP
288.0200	38.37	-8.17	30.20	46.00	-15.80	100	58	QP
364.6500	32.76	-6.67	26.09	46.00	-19.91	100	143	QP
419.9400	36.82	-5.69	31.13	46.00	-14.87	100	349	QP
532.4600	31.48	-4.21	27.27	46.00	-18.73	100	18	QP

Vertical

Frequency (MHz)	Reading (dB μ V)	Correct Factor(dB/m)	Result (dB μ V/m)	Limit (dB μ V/m)	Margin (dB)	Height (cm)	Degree ($^{\circ}$)	Remark
126.0300	35.37	-9.26	26.11	43.50	-17.39	100	65	QP
320.0300	36.55	-7.56	28.99	46.00	-17.01	100	282	QP
419.9400	33.08	-5.69	27.39	46.00	-18.61	100	88	QP
532.4600	32.19	-4.21	27.98	46.00	-18.02	100	72	QP
638.1900	27.84	-3.05	24.79	46.00	-21.21	100	345	QP
755.5600	27.48	-1.73	25.75	46.00	-20.25	100	347	QP

Result = Reading + Correct Factor

Margin = Result – Limit

Correct Factor = Antenna Factor + Cable Loss – Amplifier Gain

Spurious emissions more than 20 dB below the limit were not reported.

Above 1GHz

Horizontal

Frequency (MHz)	Reading (dBµV)	Correct Factor(dB/m)	Result (dBµV/m)	Limit (dBµV/m)	Margin (dB)	Height (cm)	Degree (°)	Remark
Low channel								
2390.000	50.22	-3.87	46.35	74.00	-27.65	300	34	peak
2390.000	39.09	-3.87	35.22	54.00	-18.78	300	34	AVG
2402.000	93.35	-3.77	89.58	N/A	N/A	300	118	peak
2402.000	93.09	-3.77	89.32	N/A	N/A	300	118	AVG
4804.000	45.40	1.81	47.21	74.00	-26.79	100	230	peak
4804.000	39.17	1.81	40.98	54.00	-13.02	100	230	AVG
Middle channel								
2440.000	93.87	-3.35	90.52	N/A	N/A	300	198	peak
2440.000	93.06	-3.35	89.71	N/A	N/A	300	198	AVG
4880.000	45.67	2.66	48.33	74.00	-25.67	100	227	peak
4880.000	39.90	2.66	42.56	54.00	-11.44	100	227	AVG
High channel								
2480.000	92.28	-2.92	89.36	N/A	N/A	300	196	peak
2480.000	91.79	-2.92	88.87	N/A	N/A	300	196	AVG
2483.500	52.44	-2.88	49.56	74.00	-24.44	300	239	peak
2483.500	39.08	-2.88	36.20	54.00	-17.80	300	239	AVG
4960.000	45.79	2.72	48.51	74.00	-25.49	100	225	peak
4960.000	40.25	2.72	42.97	54.00	-11.03	100	225	AVG

Vertical

Frequency (MHz)	Reading (dBµV)	Correct Factor(dB/m)	Result (dBµV/m)	Limit (dBµV/m)	Margin (dB)	Height (cm)	Degree (°)	Remark
Low channel								
2390.000	52.48	-3.87	48.61	74.00	-25.39	200	17	peak
2390.000	38.84	-3.87	34.97	54.00	-19.03	200	17	AVG
2402.000	97.13	-3.77	93.36	N/A	N/A	200	57	peak
2402.000	96.67	-3.77	92.90	N/A	N/A	200	57	AVG
4804.000	43.64	1.81	45.45	74.00	-28.55	100	192	peak
4804.000	37.11	1.81	38.92	54.00	-15.08	100	192	AVG
Middle channel								
2440.000	96.88	-3.35	93.53	N/A	N/A	200	62	peak
2440.000	93.34	-3.35	89.99	N/A	N/A	200	62	AVG
4880.000	42.70	2.66	45.36	74.00	-28.64	100	266	peak
4880.000	36.03	2.66	38.69	54.00	-15.31	100	266	AVG
High channel								
2480.000	95.52	-2.92	92.60	N/A	N/A	200	130	peak
2480.000	95.03	-2.92	92.11	N/A	N/A	200	130	AVG
2483.500	51.37	-2.88	48.49	74.00	-25.51	200	355	peak
2483.500	39.44	-2.88	36.56	54.00	-17.44	200	355	AVG
4960.000	42.58	2.72	45.30	74.00	-28.70	100	120	peak
4960.000	35.75	2.72	38.47	54.00	-15.53	100	120	AVG

Result = Reading + Correct Factor

Margin = Result – Limit

Correct Factor = Antenna Factor + Cable Loss – Amplifier Gain

Spurious emissions more than 20 dB below the limit were not reported.

Test Mode: simultaneous transmissions (BLE+Sub-1G)**Horizontal**

Frequency (MHz)	Reading (dBuV)	Correct Factor(dB/m)	Result (dBuV/m)	Limit (dBuV/m)	Margin (dB)	Height (cm)	Degree (°)	Remark
71.7100	40.29	-15.77	24.52	40.00	-15.48	100	223	QP
165.8000	44.35	-10.31	34.04	43.50	-9.46	100	190	QP
259.8900	41.66	-9.59	32.07	46.00	-13.93	100	151	QP
288.0200	38.37	-8.17	30.20	46.00	-15.80	100	302	QP
364.6500	32.76	-6.67	26.09	46.00	-19.91	100	252	QP
532.4600	31.48	-4.21	27.27	46.00	-18.73	100	124	QP
1841.000	38.82	-6.81	32.01	74.00	-41.99	100	75	peak
1841.000	29.69	-6.81	22.88	54.00	-31.12	100	75	AVG
4804.000	38.41	1.81	40.22	74.00	-33.78	100	131	peak
4804.000	25.43	1.81	27.24	54.00	-26.76	100	131	AVG

Vertical

Frequency (MHz)	Reading (dBuV)	Correct Factor(dB/m)	Result (dBuV/m)	Limit (dBuV/m)	Margin (dB)	Height (cm)	Degree (°)	Remark
121.1800	33.47	-9.30	24.17	43.50	-19.33	100	285	QP
165.8000	38.97	-10.31	28.66	43.50	-14.84	100	102	QP
332.6400	34.75	-7.29	27.46	46.00	-18.54	100	242	QP
532.4600	31.77	-4.21	27.56	46.00	-18.44	100	141	QP
700.2700	31.18	-2.33	28.85	46.00	-17.15	100	45	QP
960.2300	31.62	1.97	33.59	54.00	-20.41	100	24	QP
1841.000	38.38	-6.81	31.57	74.00	-42.43	100	291	peak
1841.000	28.39	-6.81	21.58	54.00	-32.42	100	291	AVG
4804.000	37.50	1.81	39.31	74.00	-34.69	100	352	peak
4804.000	25.40	1.81	27.21	54.00	-26.79	100	352	AVG

Result = Reading + Correct Factor

Margin = Result – Limit

Correct Factor = Antenna Factor + Cable Loss – Amplifier Gain

Spurious emissions more than 20 dB below the limit were not reported.

Conducted Spurious Emissions:

Channel	Frequency (MHz)	Delta Peak to Band Emission (dBc)	Limit (dBc)	Result
Low	2402	32.78	≥ 20	PASS
Mid	2441	32.31	≥ 20	PASS
High	2480	32.54	≥ 20	PASS

**BLE Mode
Low Channel**

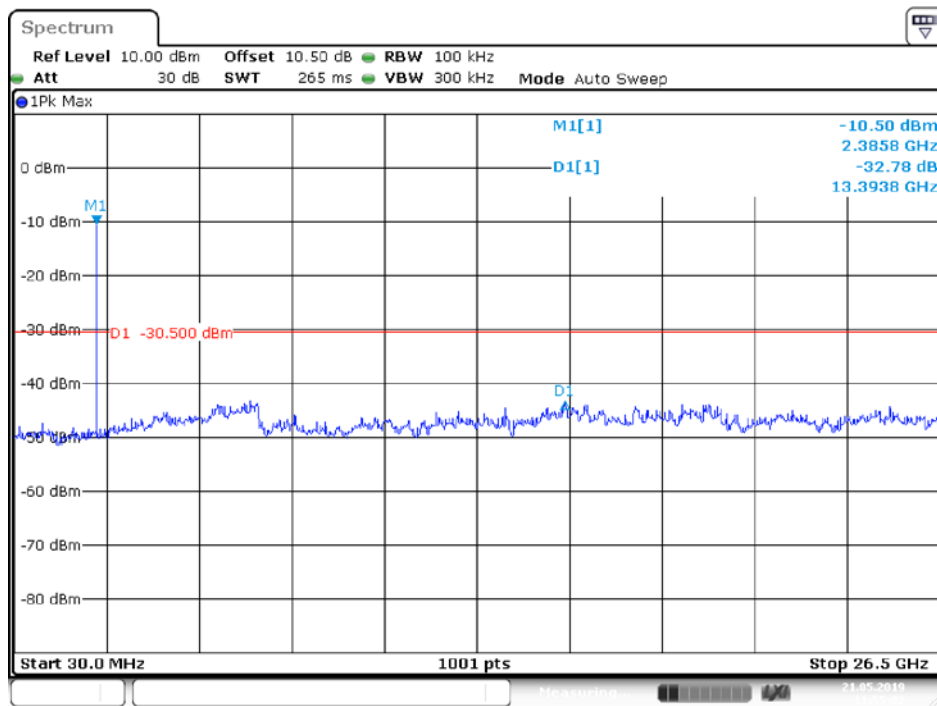

Date: 21.MAY.2019 11:55:02

Middle Channel

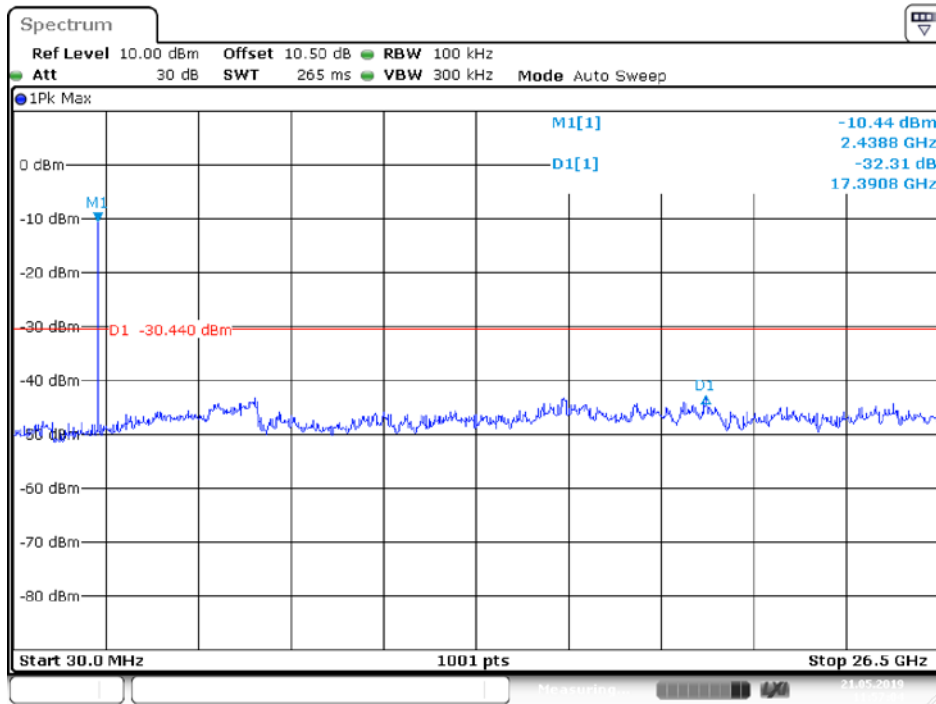

Date: 21.MAY.2019 11:57:05

High Channel

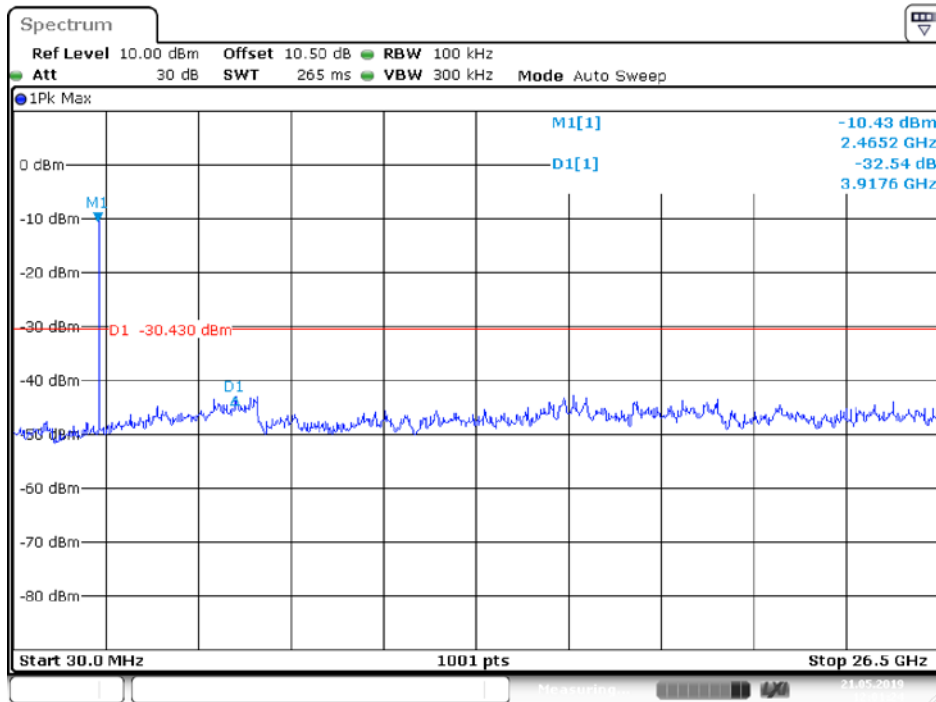

Date: 21.MAY.2019 12:01:24

9 FCC §15.247(a)(2) – 6 dB Emission Bandwidth

9.1 Applicable Standard

According to FCC §15.247(a)(2).

Systems using digital modulation techniques may operate in the 902–928 MHz, 2400–2483.5 MHz, and 5725–5850 MHz bands. The minimum 6 dB bandwidth shall be at least 500 kHz.

9.2 Test Procedure

The steps for the first option are as follows:

- a) Set RBW = 100 kHz.
- b) Set the VBW $\geq [3 \times \text{RBW}]$.
- c) Detector = peak.
- d) Trace mode = max hold.
- e) Sweep = auto couple.
- f) Allow the trace to stabilize.
- g) Measure the maximum width of the emission that is constrained by the frequencies associated with the two outermost amplitude points (upper and lower frequencies) that are attenuated by 6 dB relative to the maximum level measured in the fundamental emission.

9.3 Environmental Conditions

Temperature:	25 °C
Relative Humidity:	55 %
ATM Pressure:	1010 hPa

The testing was performed by Tom Hsu on 2019-05-21.

9.4 Test Results

Channel	Frequency (MHz)	6 dB Emission Bandwidth (kHz)	Limit (kHz)	Result
Low	2402	723	> 500	Compliance
Middle	2440	732	> 500	Compliance
High	2480	750	> 500	Compliance

Please refer to the following plots

BLE Mode Low Channel

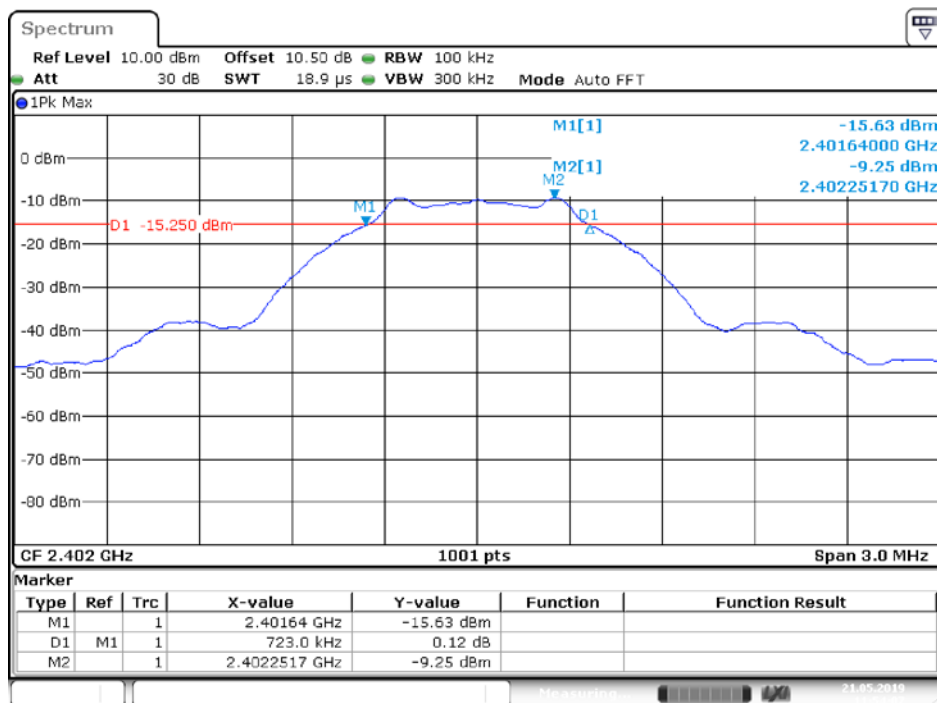

Date: 21.MAY.2019 11:54:07

Middle Channel

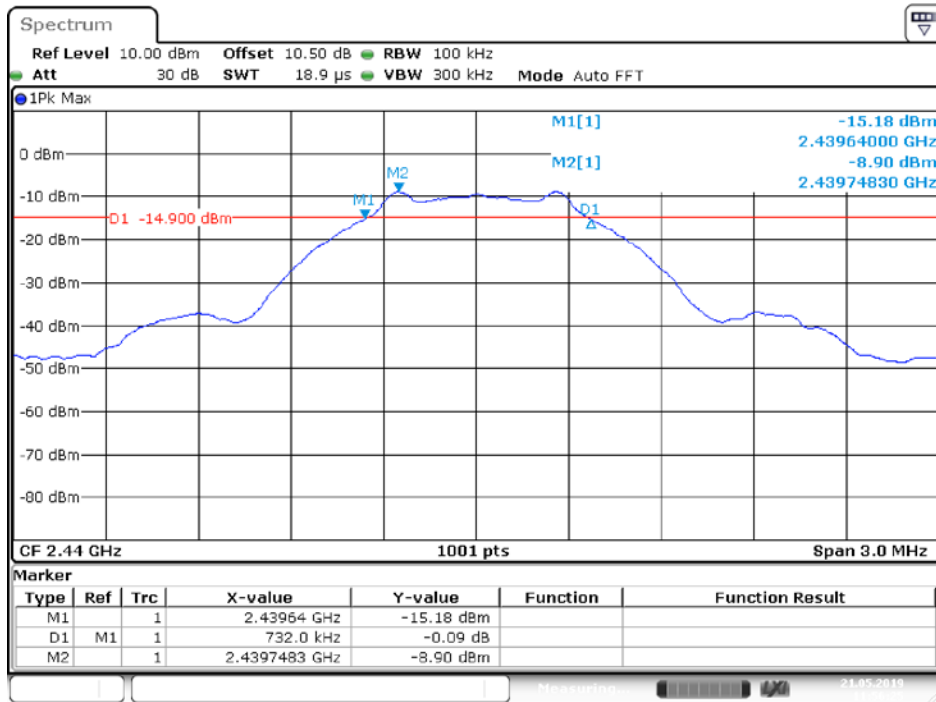

Date: 21.MAY.2019 11:56:25

High Channel

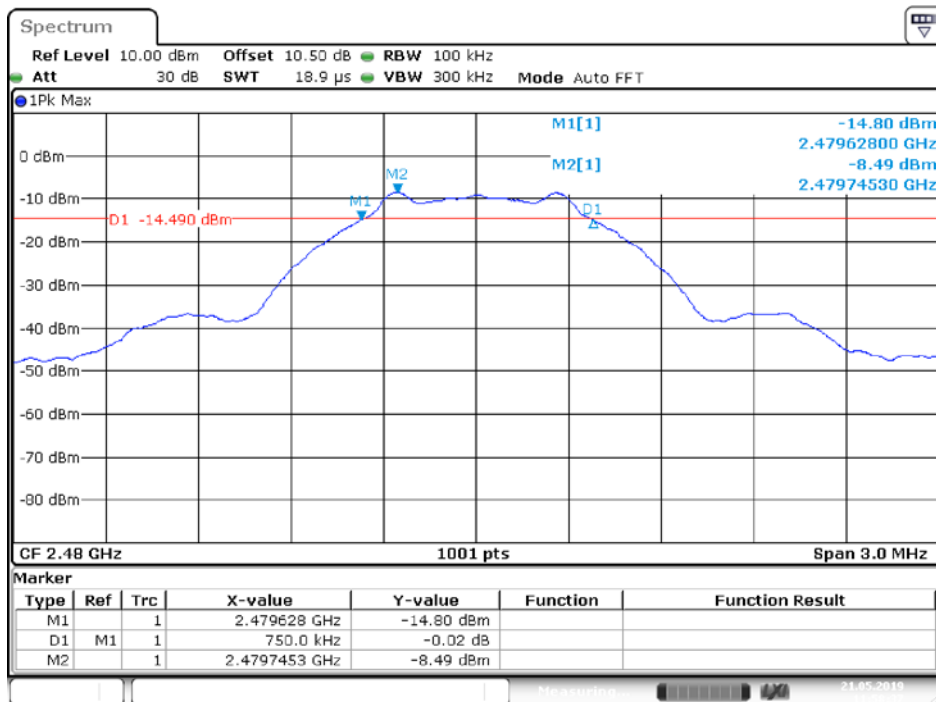

Date: 21.MAY.2019 11:58:38

10 FCC §15.247(b)(3) – Maximum Output Power

10.1 Applicable Standard

According to FCC §15.247(b) (3).

Systems using digital modulation in the 902-928 MHz, 2400-2483.5 MHz, and 5725-5850 MHz bands: 1 Watt. As an alternative to a peak power measurement, compliance with the one Watt limit can be based on a measurement of the maximum conducted output power. Maximum Conducted Output Power is defined as the total transmit power delivered to all antennas and antenna elements averaged across all symbols in the signaling alphabet when the transmitter is operating at its maximum power control level. Power must be summed across all antennas and antenna elements. The average must not include any time intervals during which the transmitter is off or is transmitting at a reduced power level. If multiple modes of operation are possible (e.g., alternative modulation methods), the maximum conducted output power is the highest total transmit power occurring in any mode.

10.2 Test Procedure

1. Place the EUT on a bench and set it in transmitting mode.
2. Remove the antenna from the EUT and then connect a low loss RF cable from the antenna port to measuring equipment.

10.3 Environmental Conditions

Temperature:	25 °C
Relative Humidity:	55 %
ATM Pressure:	1010 hPa

The testing was performed by Tom Hsu on 2019-05-21.

10.4 Test Results

Channel	Frequency (MHz)	Maximum peak Conducted Output Power		Limit (W)	Result
		(dBm)	(W)		
BLE Mode					
Low	2402	3.48	0.00223	1	PASS
Middle	2440	3.35	0.00216	1	PASS
High	2480	3.11	0.00205	1	PASS

11 FCC§15.247(d) – 100 kHz Bandwidth of Frequency Band Edge

11.1 Applicable Standard

According to FCC §15.247(d).

In any 100 kHz bandwidth outside the frequency band in which the spread spectrum or digitally modulated intentional radiator is operating, the radio frequency power that is produced by the intentional radiator shall be at least 20 dB below that in the 100 kHz bandwidth within the band that contains the highest level of the desired power, based on either an RF conducted or a radiated measurement, provided the transmitter demonstrates compliance with the peak conducted power limits. If the transmitter complies with the conducted power limits based on the use of RMS averaging over a time interval, as permitted under paragraph (b)(3) of this section, the attenuation required under this paragraph shall be 30 dB instead of 20 dB. Attenuation below the general limits specified in §15.209(a) is not required. In addition, radiated emissions which fall in the restricted bands, as defined in §15.205(a), must also comply with the radiated emission limits specified in §15.209(a) (see §15.205(c)).

11.2 Test Procedure

1. Check the calibration of the measuring instrument using either an internal calibrator or a known signal from an external generator.
2. Position the EUT without connection to measurement instrument. Turn on the EUT and connect its antenna terminal to measurement instrument via a low loss cable. Then set it to any one measured frequency within its operating range, and make sure the instrument is operated in its linear range.
3. Set RBW to 100 kHz and VBW of spectrum analyzer to 300 kHz with a convenient frequency span including 100 kHz bandwidth from band edge.
4. Measure the highest amplitude appearing on spectral display and set it as a reference level. Plot the graph with marking the highest point and edge frequency.
5. Repeat above procedures until all measured frequencies were complete.

11.3 Environmental Conditions

Temperature:	25 °C
Relative Humidity:	55 %
ATM Pressure:	1010 hPa

The testing was performed by Tom Hsu on 2019-05-21.

Band Edge, Right Side

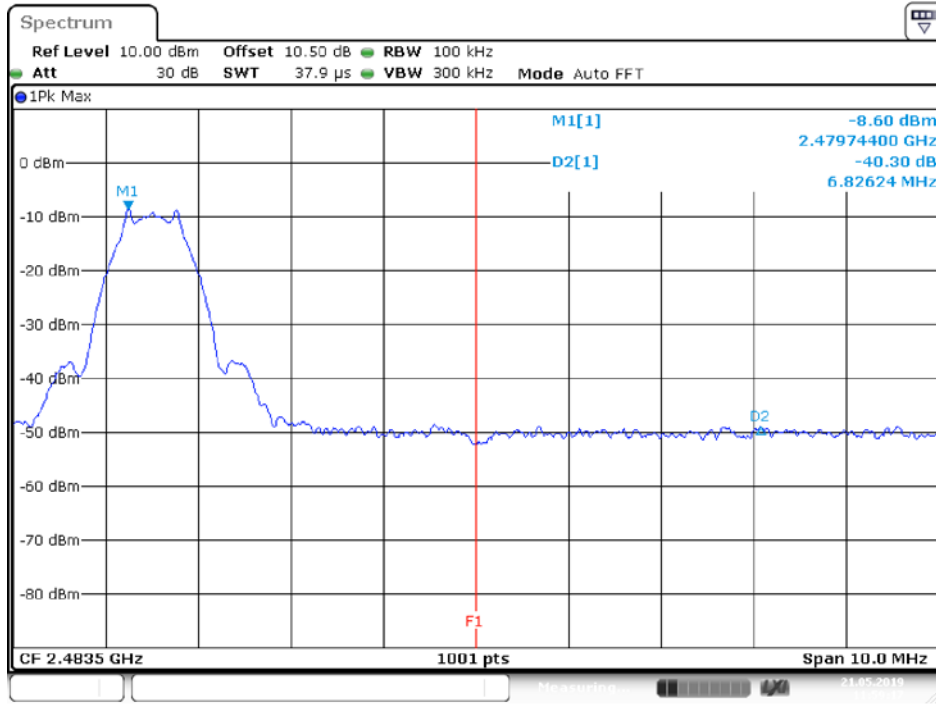

Date: 21.MAY.2019 11:59:18

12 FCC §15.247(e) – Power Spectral Density

12.1 Applicable Standard

According to FCC §15.247(e).

For digitally modulated systems, the power spectral density conducted from the intentional radiator to the antenna shall not be greater than 8 dBm in any 3 kHz band during any time interval of continuous transmission. This power spectral density shall be determined in accordance with the provisions of paragraph (b) of this section. The same method of determining the conducted output power shall be used to determine the power spectral density.

12.2 Test Procedure

According to ANSI C63.10-2013

- a) Set analyzer center frequency to DTS channel center frequency.
- b) Set the span to 1.5 times the DTS bandwidth.
- c) Set the RBW to $3 \text{ kHz} \leq \text{RBW} \leq 100 \text{ kHz}$.
- d) Set the VBW $\geq [3 \times \text{RBW}]$.
- e) Detector = peak.
- f) Sweep time = auto couple.
- g) Trace mode = max hold.
- h) Allow trace to fully stabilize.
- i) Use the peak marker function to determine the maximum amplitude level within the RBW.
- j) If measured value exceeds requirement, then reduce RBW (but no less than 3 kHz) and repeat

12.3 Environmental Conditions

Temperature:	25 °C
Relative Humidity:	55 %
ATM Pressure:	1010 hPa

The testing was performed by Tom Hsu on 2019-05-21.

12.4 Test Results

Channel	Frequency (MHz)	Power Spectral Density (dBm/3 kHz)	Limit (dBm/3 kHz)	Result
Low	2402	-18.07	8	Compliance
Middle	2440	-17.62	8	Compliance
High	2480	-16.99	8	Compliance

Please refer to the following plots

**BLE Mode
Low Channel**

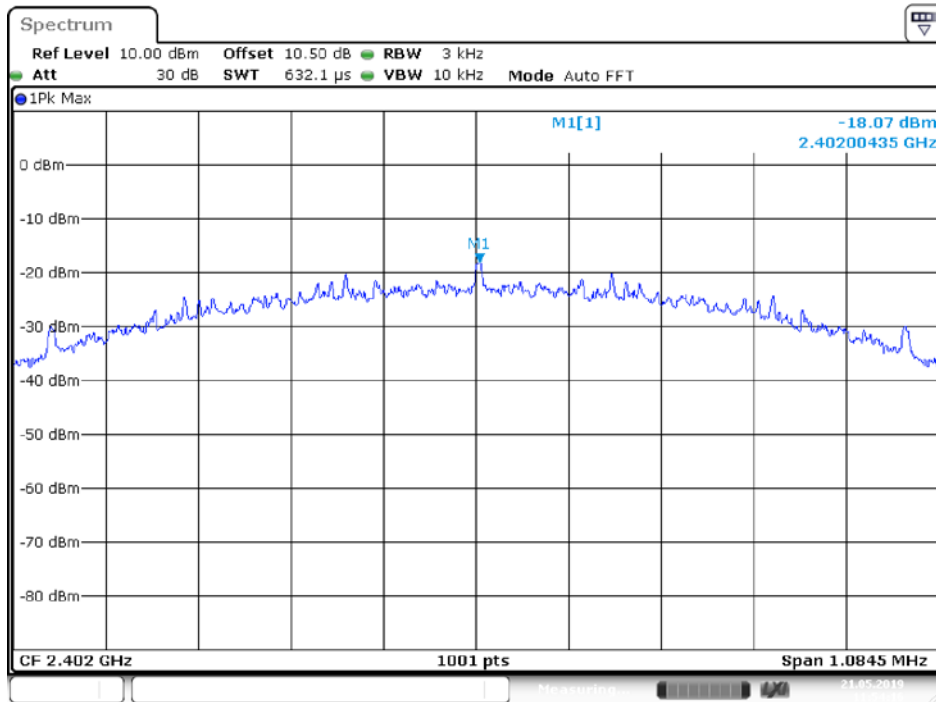

Date: 21.MAY.2019 11:54:16

Middle Channel

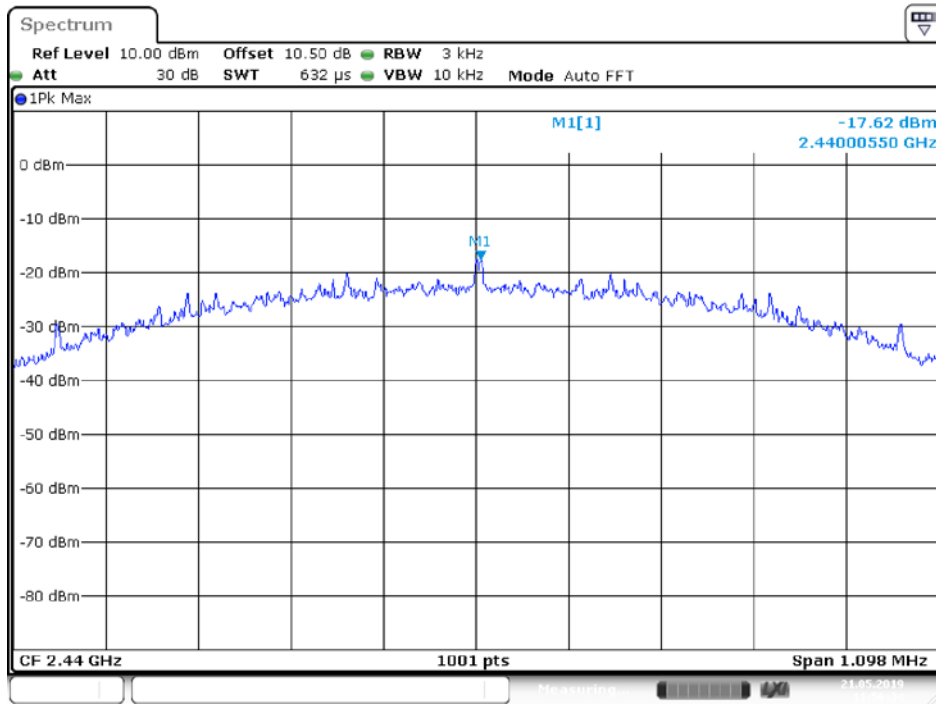

Date: 21.MAY.2019 11:56:34

High Channel

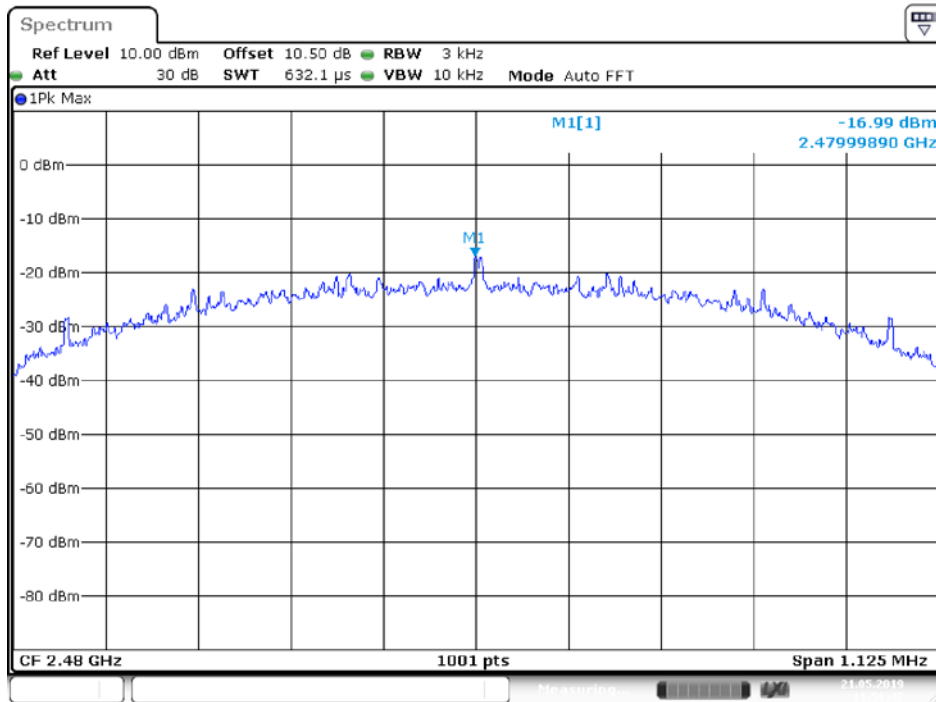

Date: 21.MAY.2019 11:58:47

***** END OF REPORT *****