

FCC PART 15.249
RSS-GEN, ISSUE 5 MARCH 2019 AMENDMENT 1
RSS-210, ISSUE 10, DECEMBER 2019
TEST REPORT

For

MPOW TECHNOLOGY CO., LIMITED

FLAT/RM 605 6/F FA YUEN COMMERCIAL BUILDING 75-77 FA YUEN STREET
MONGKOK KL HONG KONG

FCC ID:2AMH2-BH455A-1
IC:25122-BH455A1

Report Type: Original Report	Product Type: transmitter
Report Number:	<u>RDG210308006-00A</u>
Report Date:	<u>2021-04-08</u>
Reviewed By:	Ivan Cao Assistant Manager 
Test Laboratory:	Bay Area Compliance Laboratories Corp. (Dongguan) No.12, Pulong East 1 st Road, Tangxia Town, Dongguan, Guangdong, China Tel: +86-769-86858888 Fax: +86-769-86858891 www.baclcorp.com.cn

TABLE OF CONTENTS

GENERAL INFORMATION.....	3
PRODUCT DESCRIPTION FOR EQUIPMENT UNDER TEST (EUT).....	3
OBJECTIVE	3
TEST METHODOLOGY	3
MEASUREMENT UNCERTAINTY	4
TEST FACILITY	4
DECLARATIONS.....	4
SYSTEM TEST CONFIGURATION.....	5
JUSTIFICATION	5
EUT EXERCISE SOFTWARE	5
EQUIPMENT MODIFICATIONS	5
SUPPORT EQUIPMENT LIST AND DETAILS	5
SUPPORT CABLE LIST AND DETAILS	5
BLOCK DIAGRAM OF TEST SETUP	6
SUMMARY OF TEST RESULTS	7
RSS-102 § 2.5.1 EXEMPTION LIMITS FOR ROUTINE EVALUATION – SAR EVALUATION	8
APPLICABLE STANDARD	8
FCC§15.203 , RSS-GEN CLAUSE 6.8 - ANTENNA REQUIREMENT.....	9
APPLICABLE STANDARD	9
ANTENNA CONNECTOR CONSTRUCTION	9
FCC §15.207 (A) & RSS-GEN CLAUSE 8.8– AC LINE CONDUCTED EMISSIONS.....	10
APPLICABLE STANDARD	10
EUT SETUP.....	10
EMI TEST RECEIVER SETUP.....	10
TEST PROCEDURE	11
CORRECTED AMPLITUDE & MARGIN CALCULATION	11
TEST EQUIPMENT LIST AND DETAILS.....	11
TEST DATA	12
FCC§15.205, §15.209&§15.249, RSS-210 ANNEX B.10,RSS -GEN CLAUSE 8.10- RADIATED EMISSIONS	14
APPLICABLE STANDARD	14
EUT SETUP.....	15
TEST EQUIPMENT SETUP.....	16
TEST PROCEDURE	16
CORRECTED AMPLITUDE & MARGIN CALCULATION	17
TEST EQUIPMENT LIST AND DETAILS.....	17
TEST DATA	17
FCC §15.215(C), RSS-GEN CLAUSE 6.7 – 20 DB BANDWIDTH TESTING&99% OCCUPIED BANDWIDTH.....	23
APPLICABLE STANDARD	23
TEST PROCEDURE	24
TEST EQUIPMENT LIST AND DETAILS.....	24
TEST DATA	24

GENERAL INFORMATION

Product Description for Equipment under Test (EUT)

EUT Name:	transmitter
EUT Model:	FCC:BH455A IC: BH455A1
Operation Frequency:	2403-2478 MHz
Antenna Gain[▲]:	0dBi
Modulation Type:	GFSK
Rated Input Voltage:	DC 5V from system
Serial Number:	RDG210308006-RF-S2
EUT Received Date:	2021.03.09
EUT Received Status:	Good

Objective

This type approval report is prepared on behalf of **MPOW TECHNOLOGY CO., LIMITED** in accordance with Part 2-Subpart J, and Part 15-Subparts A and C of the Federal Communication Commissions rules and RSS-210, Issue 10, December 2019 of the Innovation, Science and Economic Development Canada.

The tests were performed in order to determine compliance with FCC Rules Part 15, Subpart C, and section 15.203, 15.205, 15.209, 15.215 and 15.249 rules and RSS-Gen Issue 5, March 2019, Amendment 1, General Requirements for Compliance of Radio Apparatus.

Test Methodology

All measurements contained in this report were conducted with ANSI C63.10-2013, American National Standard of Procedures for Compliance Testing of Unlicensed Wireless Devices. and the RSS-210, Issue 10, December 2019. Applicable Standard: Licence-Exempt Radio Apparatus: Category I Equipment. And RSS-Gen Issue 5, March 2019, Amendment 1,, General Requirements for Compliance of Radio Apparatus.

All emissions measurement was performed and Bay Area Compliance Laboratories Corp. (Dongguan).

Measurement Uncertainty

Parameter	Measurement Uncertainty
Occupied Channel Bandwidth	±5 %
Unwanted Emissions, radiated	30M~200MHz: 4.58 dB for Horizontal, 4.59 dB for Vertical 200M~1GHz: 4.83 dB for Horizontal, 5.85 dB for Vertical 1G~6GHz: 4.45 dB, 6G~26.5GHz: 5.23 dB
Temperature	±1 °C
Humidity	±5%
DC and low frequency voltages	±0.4%
Duty Cycle	1%
AC Power Lines Conducted Emission	3.12 dB (150 kHz to 30 MHz)

Note: Otherwise required by the applicant or Product Regulations, Decision Rule in this report did not consider the uncertainty. The extended uncertainty given in this report is obtained by combining the standard uncertainty times the coverage factor K with the 95% confidence interval.

Test Facility

The Test site used by Bay Area Compliance Laboratories Corp. (Dongguan) to collect test data is located on the No.12, Pulong East 1st Road, Tangxia Town, Dongguan, Guangdong, China.

The lab has been recognized as the FCC accredited lab under the KDB 974614 D01 and is listed in the FCC Public Access Link (PAL) database, FCC Registration No. : 897218, the FCC Designation No. : CN1220.

The lab has been recognized by Innovation, Science and Economic Development Canada to test to Canadian radio equipment requirements, the CAB identifier: CN0022.

Declarations

BACL is not responsible for the authenticity of any test data provided by the applicant. Data included from the applicant that may affect test results are marked with a triangle symbol “▲”. Customer model name, addresses, names, trademarks etc. are not considered data.

Unless otherwise stated the results shown in this test report refer only to the sample(s) tested.

This report cannot be reproduced except in full, without prior written approval of the Company.

This report is valid only with a valid digital signature. The digital signature may be available only under the Adobe software above version 7.0.

This report may contain data that are not covered by the accreditation scope and shall be marked with an asterisk “★”.

SYSTEM TEST CONFIGURATION

Justification

The system was configured for testing in Engineering Mode, which was provided by the manufacturer.

The device employs total 26 channels as below:

Channel	Frequency (MHz)	Channel	Frequency (MHz)
1	2403	14	2442
2	2406	15	2445
3	2409	16	2448
...
...
11	2433	24	2472
12	2436	25	2475
13	2439	26	2478

EUT was tested with channel 1, 13 and 26.

EUT Exercise Software

No software was used in test, the device was configured to engineer mode by manufacturer, the channel was switched by keys.

Equipment Modifications

No modifications were made to the EUT.

Support Equipment List and Details

Manufacturer	Description	Model	Serial Number
MPOW	Earphone	BH455A	RDG210308005-RF-S2
MPOW	Earphone Charger	BH455A	RDG210308005-RF-S3
DELL	Laptop	E6410	586N3Q1

Support Cable List and Details

Cable Description	Shielding Type	Ferrite Core	Length (m)	From Port	To
USB Cable	No	No	1.5	USB Port of Laptop	Charger

Block Diagram of Test Setup

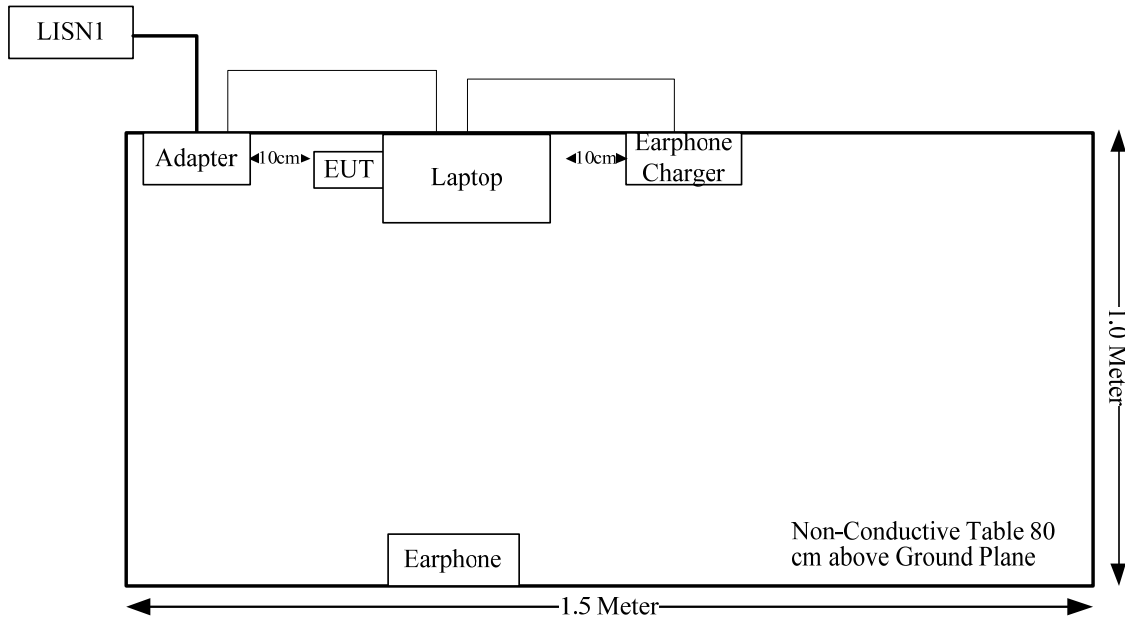

SUMMARY OF TEST RESULTS

Rules	Description of Test	Result
RSS-102 Clause 2.5.1	Exemption Limits For Routine Evaluation-SAR Evaluation	Compliance
§15.203, RSS-GEN Clause 6.8	Antenna Requirement	Compliance
§15.207(a), RSS-Gen Clause 8.8	Conduction Emissions	Compliance
15.205, §15.209, §15.249, RSS-210 ANNEX B.10, RSS -GEN CLAUSE 8.10	Radiated Emissions	Compliance
§15.215 (c), RSS-GEN CLAUSE 6.7	20 dB Bandwidth	Compliance

RSS-102 § 2.5.1 EXEMPTION LIMITS FOR ROUTINE EVALUATION – SAR EVALUATION

Applicable Standard

SAR evaluation is required if the separation distance between the user and/or bystander and the antenna and/or radiating element of the device is less than or equal to 20 cm, except when the device operates at or below the applicable output power level (adjusted for tune-up tolerance) for the specified separation distance defined in Table 1. For limb-worn devices where the 10 gram value applies, the exemption limits for routine evaluation in Table 1 are multiplied by a factor of 2.5.

Table 1: SAR evaluation – Exemption limits for routine evaluation based on frequency and separation distance⁴⁵

Frequency (MHz)	Exemption Limits (mW)				
	At separation distance of ≤ 5 mm	At separation distance of 10 mm	At separation distance of 15 mm	At separation distance of 20 mm	At separation distance of 25 mm
≤ 300	71 mW	101 mW	132 mW	162 mW	193 mW
450	52 mW	70 mW	88 mW	106 mW	123 mW
835	17 mW	30 mW	42 mW	55 mW	67 mW
1900	7 mW	10 mW	18 mW	34 mW	60 mW
2450	4 mW	7 mW	15 mW	30 mW	52 mW
3500	2 mW	6 mW	16 mW	32 mW	55 mW
5800	1 mW	6 mW	15 mW	27 mW	41 mW

Frequency (MHz)	Exemption Limits (mW)				
	At separation distance of 30 mm	At separation distance of 35 mm	At separation distance of 40 mm	At separation distance of 45 mm	At separation distance of ≥ 50 mm
≤ 300	223 mW	254 mW	284 mW	315 mW	345 mW
450	141 mW	159 mW	177 mW	195 mW	213 mW
835	80 mW	92 mW	105 mW	117 mW	130 mW
1900	99 mW	153 mW	225 mW	316 mW	431 mW
2450	83 mW	123 mW	173 mW	235 mW	309 mW
3500	86 mW	124 mW	170 mW	225 mW	290 mW
5800	56 mW	71 mW	85 mW	97 mW	106 mW

Measurement Result:

The device is a very low power device, the stand-alone SAR evaluation can be exempted.

FCC§15.203 , RSS-GEN CLAUSE 6.8 - ANTENNA REQUIREMENT

Applicable Standard

According to § 15.203, an intentional radiator shall be designed to ensure that no antenna other than that furnished by the responsible party shall be used with the device. The use of a permanently attached antenna or of an antenna that uses a unique coupling to the intentional radiator shall be considered sufficient to comply with the provisions of this section. The manufacturer may design the unit so that a broken antenna can be replaced by the user, but the user of a standard antenna jack or electrical connector is prohibited. The structure and application of the EUT were analyzed to determine compliance with section §15.203 of the rules. §15.203 state that the subject device must meet the following criteria:

- a. Antenna must be permanently attached to the unit.
- b. Antenna must use a unique type of connector to attach to the EUT.
- c. Unit must be professionally installed, and installer shall be responsible for verifying that the correct antenna is employed with the unit.

According to RSS-Gen §6.8, The applicant for equipment certification shall provide a list of all antenna types that may be used with the transmitter, where applicable (i.e. for transmitters with detachable antenna), indicating the maximum permissible antenna gain (in dBi) and the required impedance for each antenna. The test report shall demonstrate the compliance of the transmitter with the limit for maximum equivalent isotropically radiated power (e.i.r.p.) specified in the applicable RSS, when the transmitter is equipped with any antenna type, selected from this list.

For expediting the testing, measurements may be performed using only the antenna with highest gain of each combination of transmitter and antenna type, with the transmitter output power set at the maximum level. However, the transmitter shall comply with the applicable requirements under all operational conditions and when in combination with any type of antenna from the list provided in the test report (and in the notice to be included in the user manual, provided below).

When measurements at the antenna port are used to determine the RF output power, the effective gain of the device's antenna shall be stated, based on a measurement or on data from the antenna's manufacturer. The test report shall state the RF power, output power setting and spurious emission measurements with each antenna type that is used with the transmitter being tested.

For licence-exempt equipment with detachable antennas, the user manual shall also contain the following notice in a conspicuous location:

This radio transmitter [enter the device's ISED certification number] has been approved by Innovation, Science and Economic Development Canada to operate with the antenna types listed below, with the maximum permissible gain indicated. Antenna types not included in this list that have a gain greater than the maximum gain indicated for any type listed are strictly prohibited for use with this device.

Immediately following the above notice, the manufacturer shall provide a list of all antenna types which can be used with the transmitter, indicating the maximum permissible antenna gain (in dBi) and the required impedance for each antenna type.

Antenna Connector Construction

The EUT has internal PCB Antenna permanently attached to the unit, the antenna gain is 0 dBi, fulfill the requirement of this section. Please refer to the EUT photos.

Result: Compliant.

FCC §15.207 (a) & RSS-GEN CLAUSE 8.8– AC LINE CONDUCTED EMISSIONS

Applicable Standard

FCC§15.207(a), RSS-GEN CLAUSE 8.8.

EUT Setup

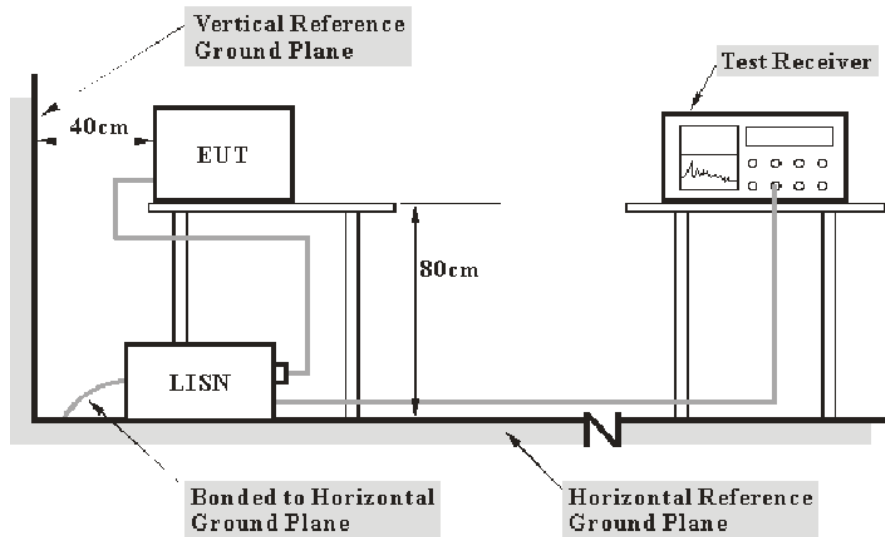

- Note: 1. Support units were connected to second LISN.
 2. Both of LISNs (AMN) 80 cm from EUT and at the least 80 cm from other units and other metal planes support units.

The setup of EUT is according with per ANSI C63.10-2013 measurement procedure. The specification used was with the FCC Part 15.207 and RSS-Gen limits.

The spacing between the peripherals was 10 cm.

The EUT was connected to the main LISN with a 120 V/60 Hz AC power source.

EMI Test Receiver Setup

The EMI test receiver was set to investigate the spectrum from 150 kHz to 30 MHz.

During the conducted emission test, the EMI test receiver was set with the following configurations:

Frequency Range	IF B/W
150 kHz – 30 MHz	9 kHz

Test Procedure

During the conducted emission test, the EUT was connected to the first LISN.

Maximizing procedure was performed on the six (6) highest emissions of the EUT.

All data was recorded in the Quasi-peak and average detection mode.

Corrected Amplitude & Margin Calculation

The basic equation is as follows:

$$V_C = V_R + A_C + VDF$$

$$C_f = A_C + VDF$$

Herein,

V_C (cord. Reading): corrected voltage amplitude

V_R : reading voltage amplitude

A_C : attenuation caused by cable loss

VDF: voltage division factor of AMN

C_f : Correction Factor

The “**Margin**” column of the following data tables indicates the degree of compliance within the applicable limit. For example, a margin of 7dB means the emission is 7dB below the limit. The equation for margin calculation is as follows:

$$\text{Margin} = \text{Limit} - \text{Corrected Amplitude}$$

Test Equipment List and Details

Manufacturer	Description	Model	Serial Number	Calibration Date	Calibration Due Date
R&S	LISN	ENV 216	101614	2020-09-12	2021-09-12
R&S	EMI Test Receiver	ESCI	101121	2020-07-07	2021-07-07
MICRO-COAX	Coaxial Cable	C-NJNJ-50	C-0200-01	2020-09-05	2021-09-05
R&S	Test Software	EMC32	Version 9.10.00	N/A	N/A

* **Statement of Traceability:** Bay Area Compliance Laboratories Corp. (Dongguan) attests that all calibrations have been performed, traceable to National Primary Standards and International System of Units (SI).

Test Data

Environmental Conditions

Temperature:	20.9°C
Relative Humidity:	43%
ATM Pressure:	102.1kPa
Tester:	Walker Chen
Test Date:	2021-03-22

Test Mode: Transmitting

AC120V, 60 Hz, Line:

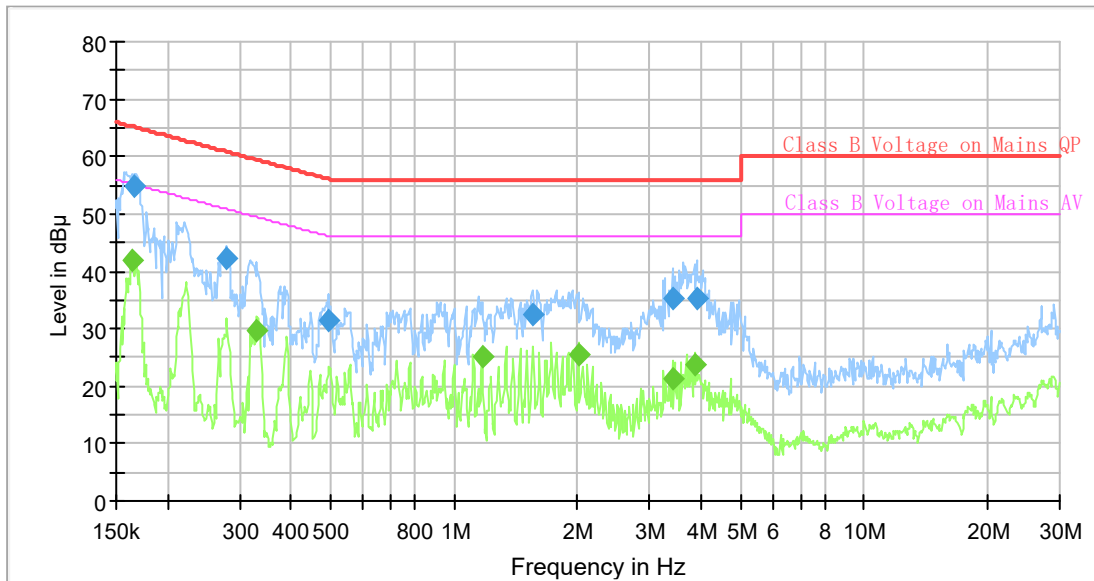

Final Result

Frequency (MHz)	QuasiPeak (dB µ V)	Average (dB µ V)	Limit (dB µ V)	Margin (dB)	Bandwidth (kHz)	Line	Corr. (dB)
0.164089	---	41.96	55.25	13.29	9.000	L1	9.6
0.166563	54.79	---	65.13	10.34	9.000	L1	9.6
0.278409	42.20	---	60.86	18.66	9.000	L1	9.6
0.331509	---	29.81	49.41	19.60	9.000	L1	9.6
0.494060	31.35	---	56.10	24.75	9.000	L1	9.6
1.170870	---	24.99	46.00	21.01	9.000	L1	9.7
1.555873	32.55	---	56.00	23.45	9.000	L1	9.7
2.006519	---	25.60	46.00	20.40	9.000	L1	9.7
3.404442	35.29	---	56.00	20.71	9.000	L1	9.7
3.404442	---	21.18	46.00	24.82	9.000	L1	9.7
3.856537	---	23.67	46.00	22.33	9.000	L1	9.7
3.895198	35.33	---	56.00	20.67	9.000	L1	9.7

AC120V, 60 Hz, Neutral:

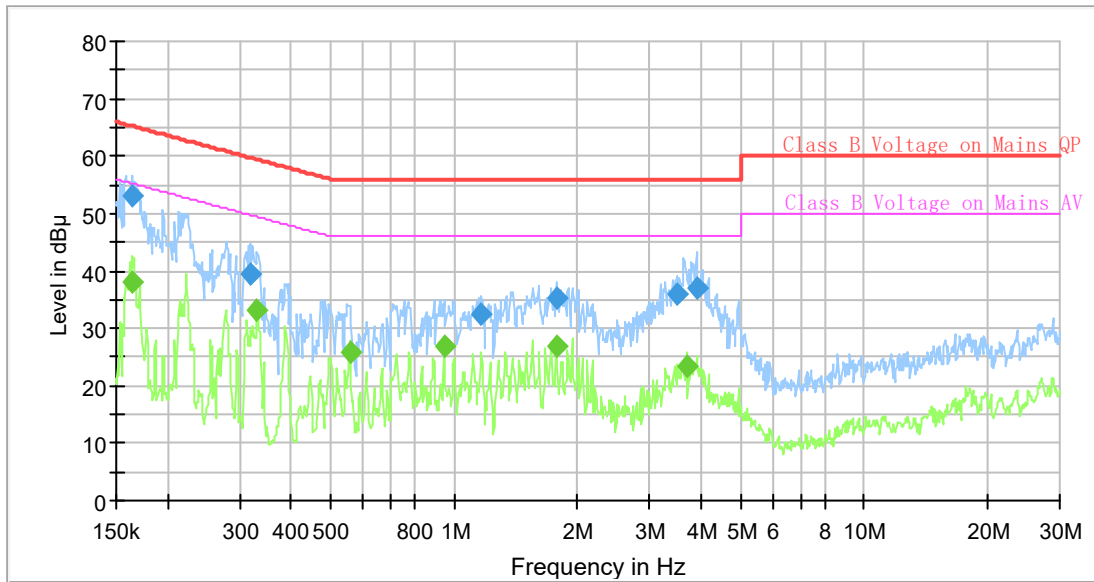

Final Result

Frequency (MHz)	QuasiPeak (dB µ V)	Average (dB µ V)	Limit (dB µ V)	Margin (dB)	Bandwidth (kHz)	Line	Corr. (dB)
0.163273	---	38.16	55.30	17.14	9.000	N	9.6
0.164089	52.93	---	65.25	12.32	9.000	N	9.6
0.318542	39.43	---	59.74	20.31	9.000	N	9.6
0.331509	---	33.28	49.41	16.13	9.000	N	9.6
0.556885	---	25.86	46.00	20.14	9.000	N	9.6
0.944861	---	26.81	46.00	19.19	9.000	N	9.6
1.165045	32.53	---	56.00	23.47	9.000	N	9.6
1.780155	35.28	---	56.00	20.72	9.000	N	9.6
1.780155	---	27.06	46.00	18.94	9.000	N	9.6
3.507860	36.13	---	56.00	19.87	9.000	N	9.6
3.687253	---	23.49	46.00	22.51	9.000	N	9.6
3.895198	37.07	---	56.00	18.93	9.000	N	9.6

**FCC§15.205, §15.209&§15.249, RSS-210 ANNEX B.10,RSS -GEN CLAUSE
8.10- RADIATED EMISSIONS**

Applicable Standard

As per FCC§15.249 (a), except as provided in paragraph (b) of this section, the field strength of emissions from intentional radiators operated within these frequency bands shall comply with the following:

Fundamental frequency	Field strength of fundamental (millivolts/meter)	Field strength of harmonics (microvolts/meter)
902–928 MHz	50	500
2400–2483.5 MHz	50	500
5725–5875 MHz	50	500
24.0–24.25 GHz	250	2500

As per FCC§15.249 (c), Field strength limits are specified at a distance of 3 meters.

(d) Emissions radiated outside of the specified frequency bands, except for harmonics, shall be attenuated by at least 50 dB below the level of the fundamental or to the general radiated emission limits in §15.209, whichever is the lesser attenuation.

As per RSS-210 Annex B.10

Devices shall comply with the following requirements:

- (a) The field strength of fundamental and harmonic emissions measured at 3 m shall not exceed the limits in table B2.

Table B2 — Field strength limits at various frequencies

Frequency bands (MHz)	Field strength (mV/m)	
	Fundamental emissions	Harmonic emissions
902-928	50	0.5
2400-2483.5	50	0.5
5725-5875	50	0.5
24000-24250	250	2.5

The field strength shall be measured using an average detector, except for the fundamental emission in the frequency band 902-928 MHz, which is based on measurements using an International Special Committee on Radio Interference (CISPR) quasi-peak detector.

- (b) Emissions radiated outside of the specified frequency bands, except for harmonic emissions, shall be attenuated by at least 50 dB below the level of the fundamental emissions or to the general field strength limits listed in [RSS-Gen](#), whichever is less stringent.

EUT Setup

Below 1 GHz:

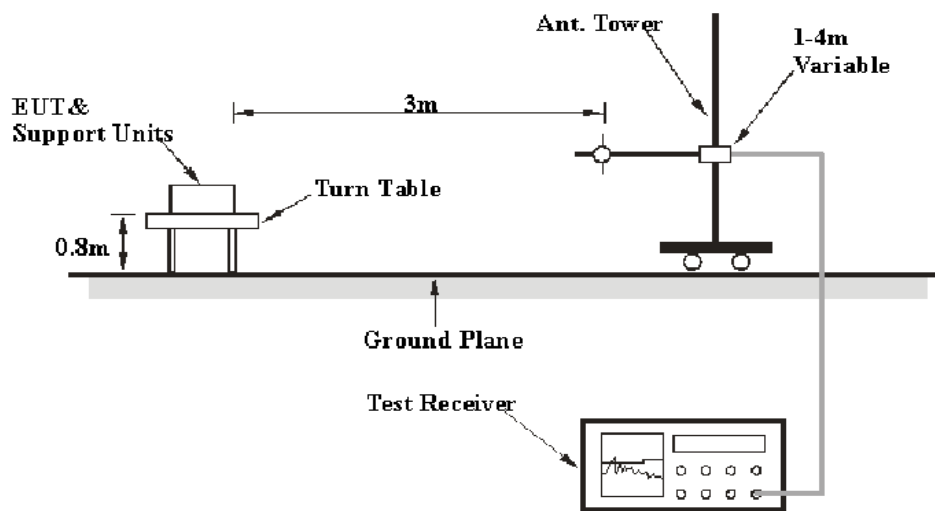

1-25 GHz:

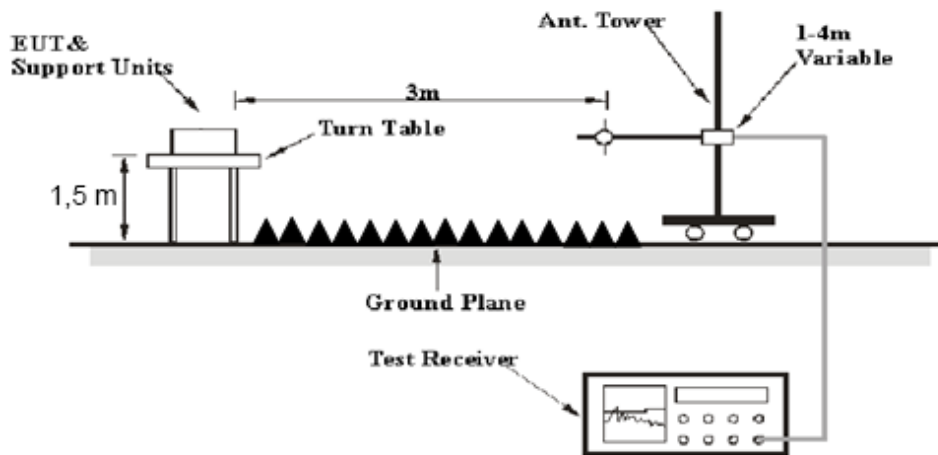

The radiated emission below 1GHz tests were performed in the 3 meters chamber test site A, above 1GHz tests were performed in the 3 meters chamber test site B, using the setup accordance with the ANSI C63.10-2013. The specification used was the FCC 15.209, and FCC 15.249 limits.

Test Equipment Setup

The system was investigated from 30 MHz to 25 GHz.

During the radiated emission test, the EMI test receiver & Spectrum Analyzer Setup were set with the following configurations:

Frequency Range	RBW	Video B/W	IF B/W	Measurement
30 MHz – 1000 MHz	120 kHz	300 kHz	120 kHz	QP
Above 1 GHz	1MHz	3 MHz	/	PK
	1MHz	10 Hz	/	AV

If the maximized peak measured value complies with under the QP/Average limit more than 6dB, then it is unnecessary to perform an QP/Average measurement.

Test Procedure

Maximizing procedure was performed on the highest emissions to ensure that the EUT complied with all installation combinations.

Data was recorded in Quasi-peak detection mode for frequency range of 30 MHz - 1 GHz, peak and average detection modes for frequencies above 1 GHz.

Corrected Amplitude & Margin Calculation

The Corrected Amplitude is calculated by adding the Antenna Factor and Cable Loss, and subtracting the Amplifier Gain from the Meter Reading. The basic equation is as follows:

$$\text{Corrected Amplitude} = \text{Meter Reading} + \text{Antenna Factor} + \text{Cable Loss} - \text{Amplifier Gain}$$

The “**Margin**” column of the following data tables indicates the degree of compliance with the applicable limit. For example, a margin of 7dB means the emission is 7dB below the limit. The equation for margin calculation is as follows:

$$\text{Margin} = \text{Limit} - \text{Corrected Amplitude}$$

Test Equipment List and Details

Manufacturer	Description	Model	Serial Number	Calibration Date	Calibration Due Date
Radiation Below 1GHz					
Sunol Sciences	Antenna	JB3	A060611-1	2020-11-10	2023-11-10
R&S	EMI Test Receiver	ESR3	102453	2020-09-12	2021-09-12
Unknown	Coaxial Cable	C-NJNJ-50	C-0075-01	2020-09-05	2021-09-05
Unknown	Coaxial Cable	C-NJNJ-50	C-0400-01	2020-09-05	2021-09-05
Unknown	Coaxial Cable	C-NJNJ-50	C-1400-01	2020-05-06	2021-05-06
HP	Amplifier	8447D	2727A05902	2020-09-05	2021-09-05
Farad	Test Software	EZ-EMC	V1.1.4.2	N/A	N/A
Radiation Above 1GHz					
ETS-Lindgren	Horn Antenna	3115	000 527 35	2018-10-12	2021-10-12
Agilent	Spectrum Analyzer	E4440A	SG43360054	2020-07-07	2021-07-07
Unknown	Coaxial Cable	C-SJSJ-50	C-0800-01	2020-09-05	2021-09-05
Mini-Circuit	Amplifier	ZVA-213-S+	54201245	2020-09-05	2021-09-05
Farad	Test Software	EZ-EMC	V1.1.4.2	N/A	N/A
Quinstar	Amplifier	QLW-18405536-JO	15964001001	2020-06-27	2021-06-27
Farad	Test Software	EZ-EMC	V1.1.4.2	N/A	N/A
E-Microwave	Band-stop Filters	OBSF-2400-2483.5-S	OE01601525	2020-06-16	2021-06-16
Mini Circuits	High Pass Filter	VHF-6010+	31118	2020-06-16	2021-06-16
Ducommun Technologies	Horn Antenna	ARH-4223-02	1007726-01 1304	2020-12-05	2023-12-04

* **Statement of Traceability:** Bay Area Compliance Laboratories Corp. (Dongguan) attests that all calibrations have been performed, traceable to National Primary Standards and International System of Units (SI).

Test Data

Environmental Conditions

Test Items	Radiation Below 1GHz	Radiation Above 1GHz
Temperature:	22.7°C	28 °C
Relative Humidity:	65 %	54 %
ATM Pressure:	101.5kPa	101.8 kPa
Tester:	Bond Qin	Joker Chen
Test Date:	2021-03-11	2021-04-05

Test Mode: Transmitting

1) 30MHz-1GHz(Middle channel was the worst)

Horizontal:

80.0 dBuV/m

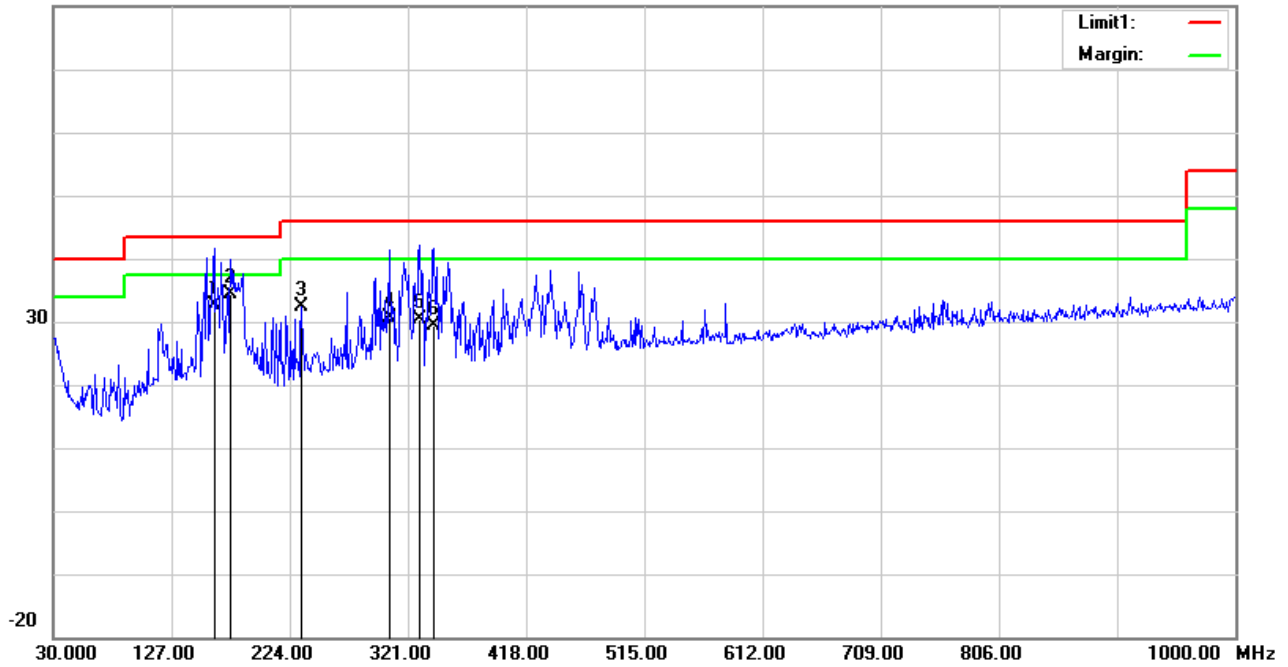

Frequency (MHz)	Reading (dBuV/m)	Detector	Corrected dB/m	Result (dBuV/m)	Limit (dBuV/m)	Margin (dB)
161.9200	38.90	QP	-6.24	32.66	43.50	10.84
175.5000	41.40	QP	-7.00	34.40	43.50	9.10
233.7000	38.79	peak	-6.30	32.49	46.00	13.51
305.4800	34.25	QP	-3.60	30.65	46.00	15.35
330.7000	33.63	QP	-3.33	30.30	46.00	15.70
342.3400	32.54	QP	-3.28	29.26	46.00	16.74

Vertical:

80.0 dBuV/m

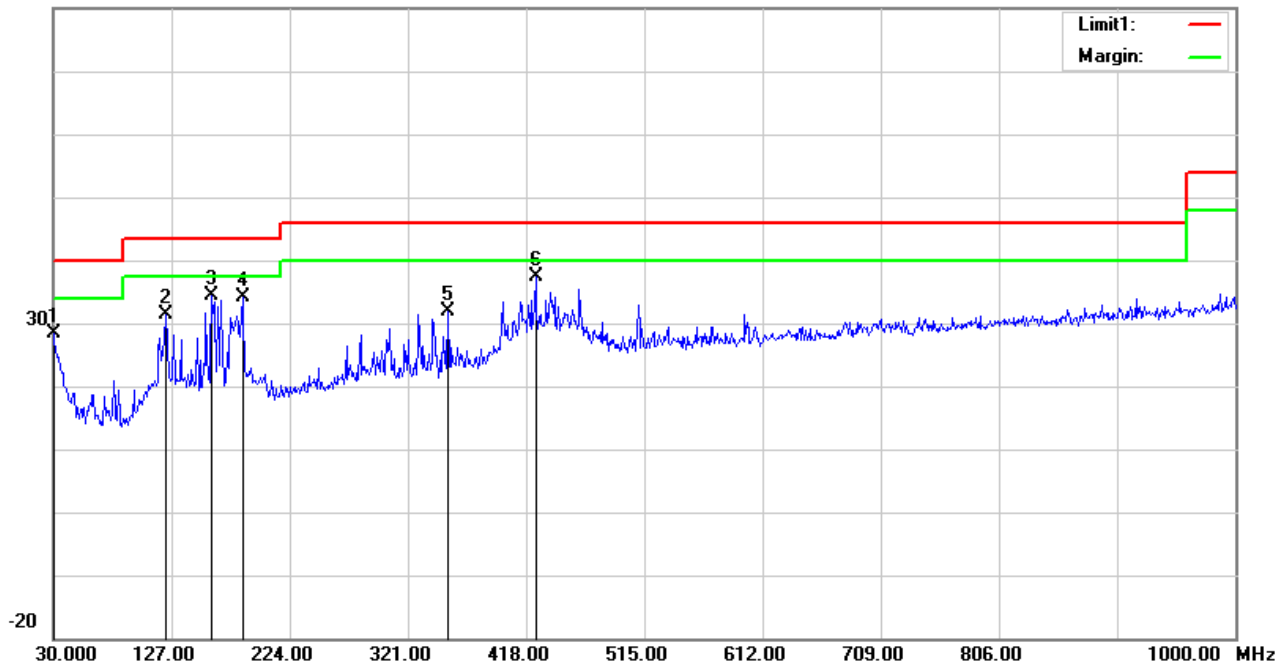

Frequency (MHz)	Reading (dBμV)	Detector	Corrected (dB/m)	Result (dBμV/m)	Limit (dBμV/m)	Margin (dB)
30.0000	26.82	peak	1.46	28.28	40.00	11.72
122.1500	36.22	peak	-4.78	31.44	43.50	12.06
159.9800	40.31	peak	-6.03	34.28	43.50	9.22
185.2000	41.22	peak	-7.17	34.05	43.50	9.45
353.9800	34.84	peak	-2.92	31.92	46.00	14.08
425.7600	38.75	peak	-1.49	37.26	46.00	8.74

2) 1GHz-25GHz:

Frequency	Receiver		Rx Antenna		Cable loss	Amplifier Gain	Corrected Amplitude	Limit	Margin
	Reading	Detector	Polar	Factor					
MHz	dB μ V	PK/QP/AV	H/V	dB/m	dB	dB	dB μ V/m	dB μ V/m	dB
Low Channel									
2403.00	57.33	PK	H	28.11	1.80	0.00	87.24	113.98	26.74
2403.00	53.14	AV	H	28.11	1.80	0.00	83.05	93.98	10.93
2403.00	52.94	PK	V	28.11	1.80	0.00	82.85	113.98	31.13
2403.00	48.78	AV	V	28.11	1.80	0.00	78.69	93.98	15.29
2400.00	38.02	PK	H	28.10	1.80	0.00	67.92	74.00	6.08
2400.00	16.16	AV	H	28.10	1.80	0.00	46.06	54.00	7.94
4806.00	36.34	PK	H	32.92	3.17	25.61	46.82	74.00	27.18
4806.00	23.28	AV	H	32.92	3.17	25.61	33.76	54.00	20.24
7209.00	35.99	PK	H	35.75	4.81	25.61	50.94	74.00	23.06
7209.00	23.09	AV	H	35.75	4.81	25.61	38.04	54.00	15.96
Middle Channel									
2439.00	57.04	PK	H	28.18	1.82	0.00	87.04	113.98	26.94
2439.00	52.93	AV	H	28.18	1.82	0.00	82.93	93.98	11.05
2439.00	52.62	PK	V	28.18	1.82	0.00	82.62	113.98	31.36
2439.00	48.45	AV	V	28.18	1.82	0.00	78.45	93.98	15.53
4878.00	36.27	PK	H	33.06	3.27	25.65	46.95	74.00	27.05
4878.00	23.11	AV	H	33.06	3.27	25.65	33.79	54.00	20.21
7317.00	35.78	PK	H	36.02	4.63	25.72	50.71	74.00	23.29
7317.00	22.76	AV	H	36.02	4.63	25.72	37.69	54.00	16.31
High Channel									
2478.00	55.13	PK	H	28.26	1.84	0.00	85.23	113.98	28.75
2478.00	51.29	AV	H	28.26	1.84	0.00	81.39	93.98	12.59
2478.00	50.74	PK	V	28.26	1.84	0.00	80.84	113.98	33.14
2478.00	46.53	AV	V	28.26	1.84	0.00	76.63	93.98	17.35
2483.50	25.85	PK	H	28.27	1.84	0.00	55.96	74.00	18.04
2483.50	13.80	AV	H	28.27	1.84	0.00	43.91	54.00	10.09
4956.00	36.67	PK	H	33.21	3.23	25.63	47.48	74.00	26.52
4956.00	23.20	AV	H	33.21	3.23	25.63	34.01	54.00	19.99
7434.00	35.64	PK	H	36.33	4.42	25.84	50.55	74.00	23.45
7434.00	22.88	AV	H	36.33	4.42	25.84	37.79	54.00	16.21

Test plots(Low Channel was the worst):

Horizontal

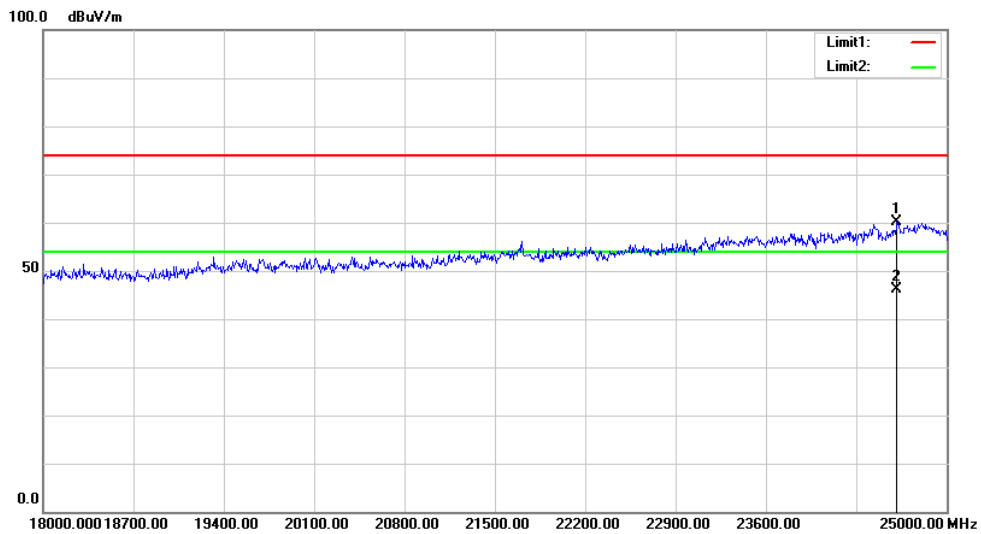
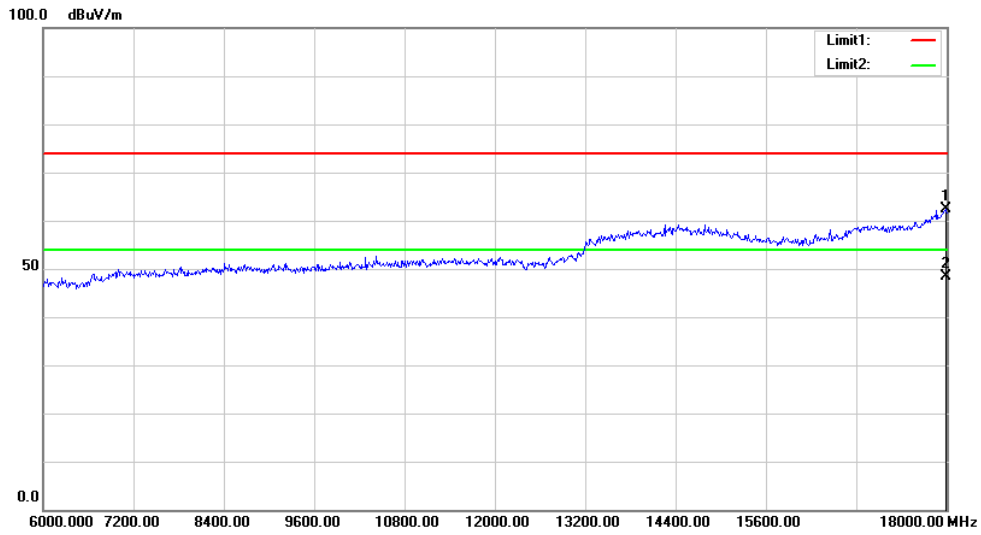
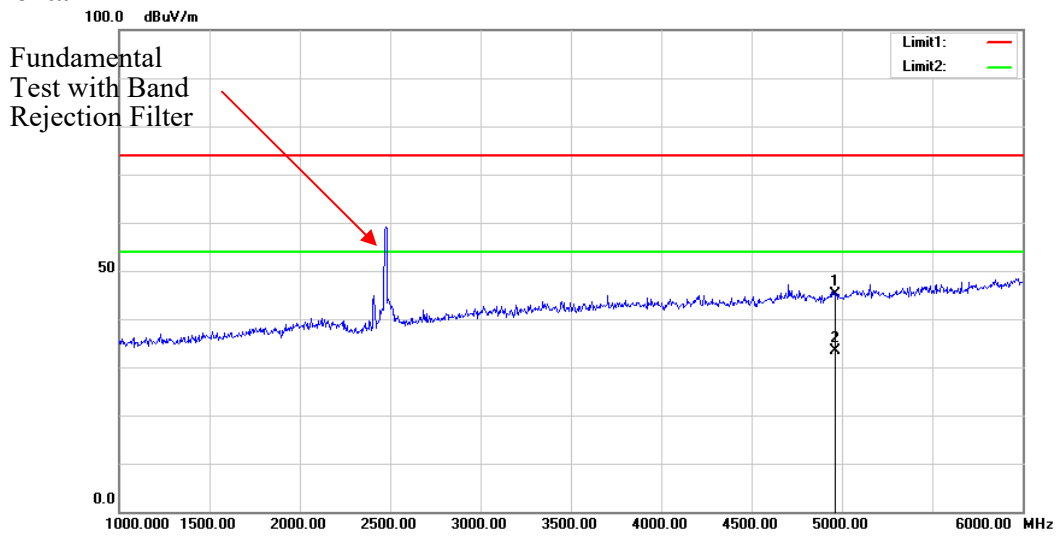

Vertical:

Fundamental
Test with Band
Rejection Filter

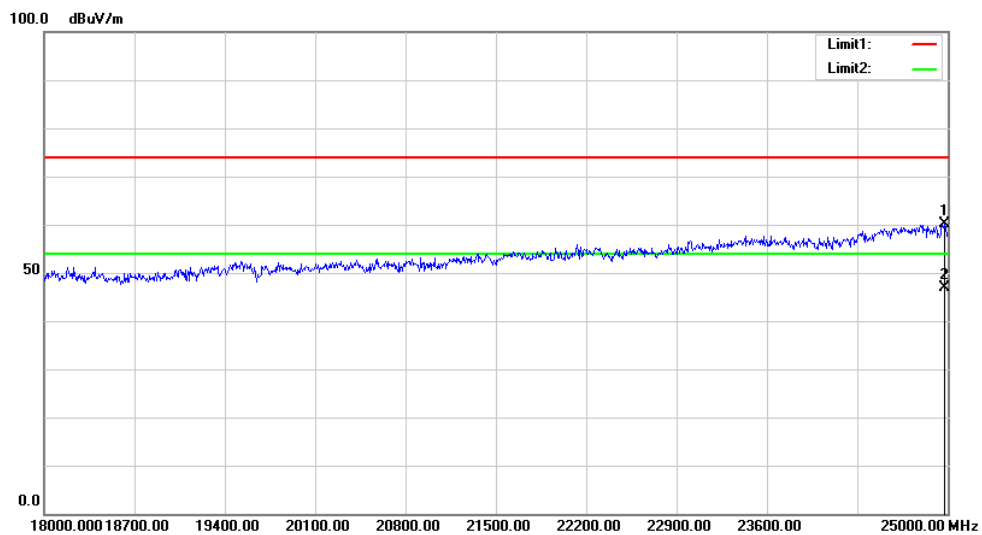
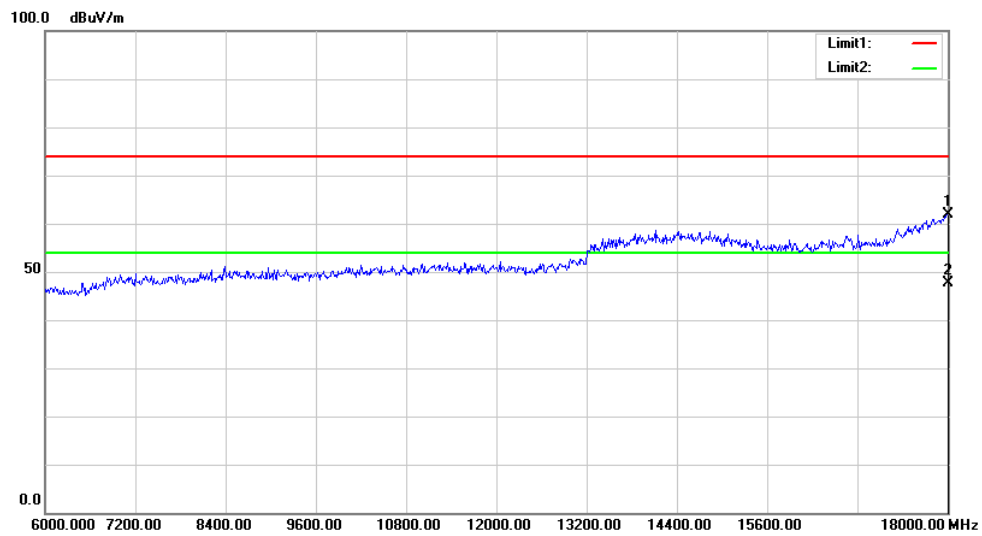
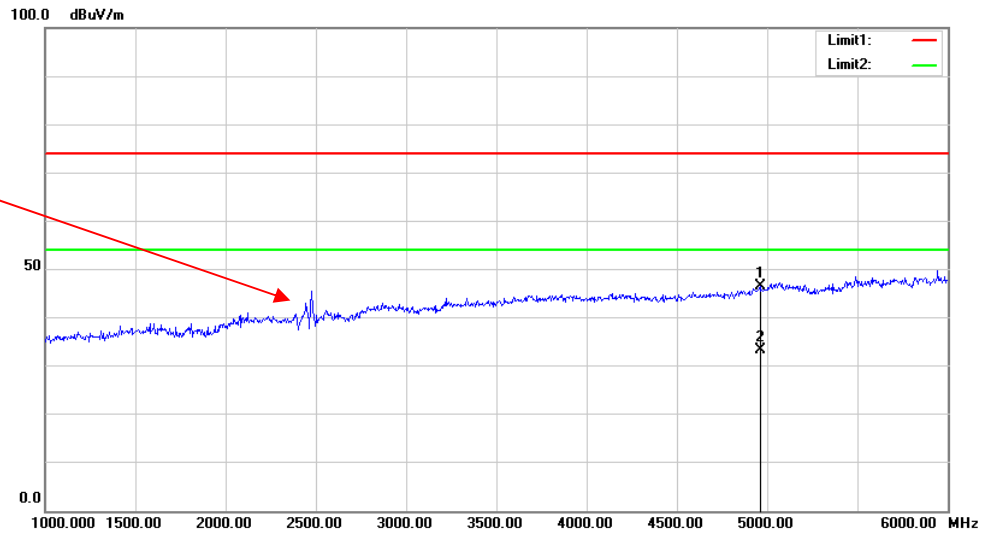

FCC §15.215(c), RSS-GEN CLAUSE 6.7 – 20 dB BANDWIDTH TESTING & 99% OCCUPIED BANDWIDTH

Applicable Standard

According to FCC §15.215(c)

Intentional radiators operating under the alternative provisions to the general emission limits, as contained in §§ 15.217 through 15.257 and in Subpart E of this part, must be designed to ensure that the 20 dB bandwidth of the emission, or whatever bandwidth may otherwise be specified in the specific rule section under which the equipment operates, is contained within the frequency band designated in the rule section under which the equipment is operated.

According to RSS-Gen §6.7

The occupied bandwidth or the “99% emission bandwidth” is defined as the frequency range between two points, one above and the other below the carrier frequency, within which 99% of the total transmitted power of the fundamental transmitted emission is contained. The occupied bandwidth shall be reported for all equipment in addition to the specified bandwidth required in the applicable RSSs.

In some cases, the “x dB bandwidth” is required, which is defined as the frequency range between two points, one at the lowest frequency below and one at the highest frequency above the carrier frequency, at which the maximum power level of the transmitted emission is attenuated x dB below the maximum in-band power level of the modulated signal, where the two points are on the outskirts of the in-band emission.

The following conditions shall be observed for measuring the occupied bandwidth and x dB bandwidth:

- The transmitter shall be operated at its maximum carrier power measured under normal test conditions.
- The span of the spectrum analyzer shall be set large enough to capture all products of the modulation process, including the emission skirts, around the carrier frequency, but small enough to avoid having other emissions (e.g. on adjacent channels) within the span.
- The detector of the spectrum analyzer shall be set to “Sample”. However, a peak, or peak hold, may be used in place of the sampling detector since this usually produces a wider bandwidth than the actual bandwidth (worst-case measurement). Use of a peak hold (or “Max Hold”) may be necessary to determine the occupied / x dB bandwidth if the device is not transmitting continuously.
- The resolution bandwidth (RBW) shall be in the range of 1% to 5% of the actual occupied / x dB bandwidth and the video bandwidth (VBW) shall not be smaller than three times the RBW value. Video averaging is not permitted.

Note: It may be necessary to repeat the measurement a few times until the RBW and VBW are in compliance with the above requirement.

For the 99% emission bandwidth, the trace data points are recovered and directly summed in linear power level terms. The recovered amplitude data points, beginning at the lowest frequency, are placed in a running sum until 0.5% of the total is reached, and that frequency recorded. The process is repeated for the highest frequency data points (starting at the highest frequency, at the right side of the span, and going down in frequency). This frequency is then recorded. The difference between the two recorded frequencies is the occupied bandwidth (or the 99% emission bandwidth)

Test Procedure

1. Check the calibration of the measuring instrument using either an internal calibrator or a known signal from an external generator.
2. Measure the frequency difference of two frequencies that were attenuated 20 dB from the reference level. Record the frequency difference as the emission bandwidth.
3. Repeat above procedures until all frequencies measured were complete.
4. Test 99% Occupied bandwidth use the function of the equipment.

Test Equipment List and Details

Manufacturer	Description	Model	Serial Number	Calibration Date	Calibration Due Date
R&S	Spectrum Analyzer	FSU 26	200256	2020-07-07	2021-07-07
yzjingcheng	Coaxial Cable	KTRFBU-141-50	41005012	Each time	N/A

* **Statement of Traceability:** Bay Area Compliance Laboratories Corp. (Dongguan) attests that all calibrations have been performed, traceable to National Primary Standards and International System of Units (SI).

Test Data

Environmental Conditions

Temperature:	23.0~23.9 °C
Relative Humidity:	36~59 %
ATM Pressure:	101.0~101.6 kPa
Tester:	Bond Qin
Test Date:	2021-03-10~2021-03-24

Test Result: Compliant. Please refer to following tables and plots

Test Mode: Transmitting

Channel	Frequency (MHz)	20 dB Bandwidth (MHz)	99% Occupied Bandwidth (MHz)
Low	2403	3.664	3.34
Middle	2439	3.855	3.50
High	2478	3.712	3.38

20dB Bandwidth:

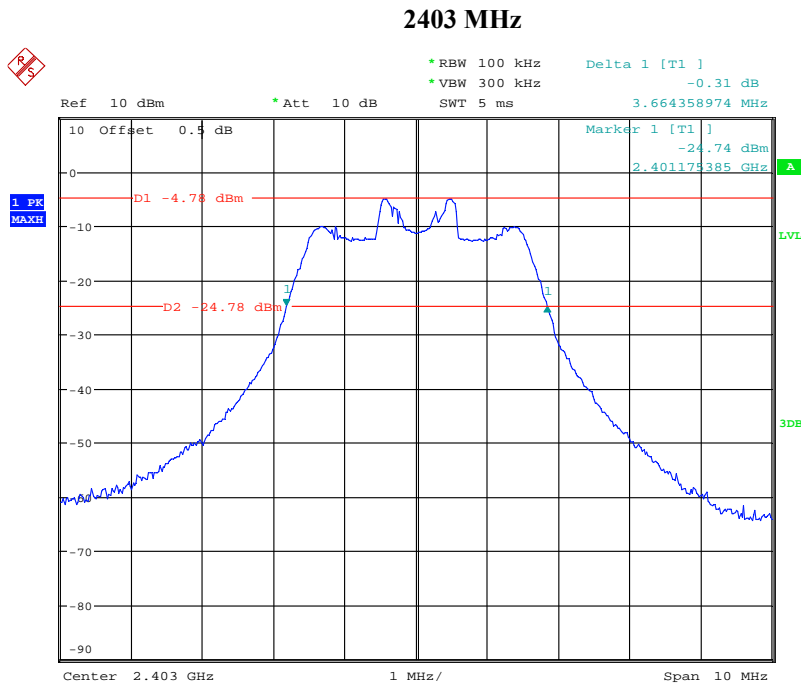

Date: 10.MAR.2021 19:01:54

2439 MHz

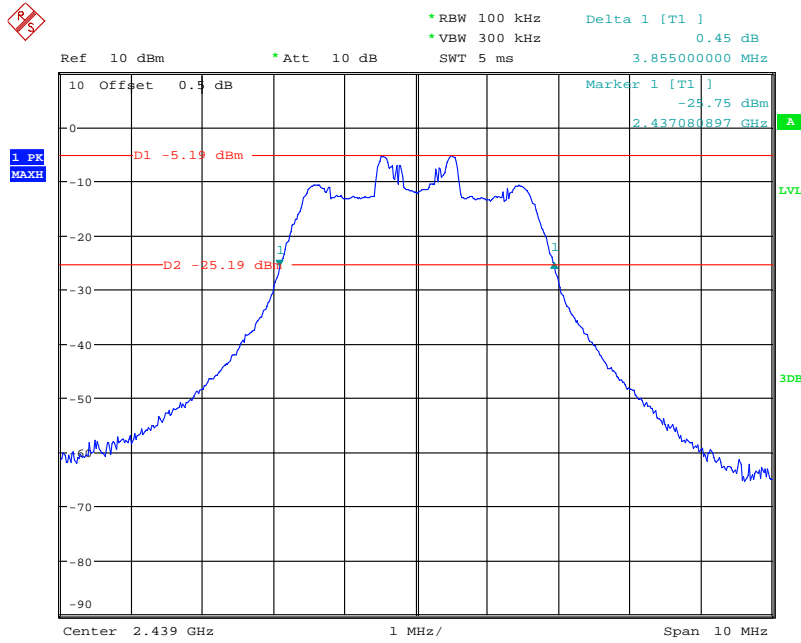

Date: 10.MAR.2021 19:02:57

2478 MHz

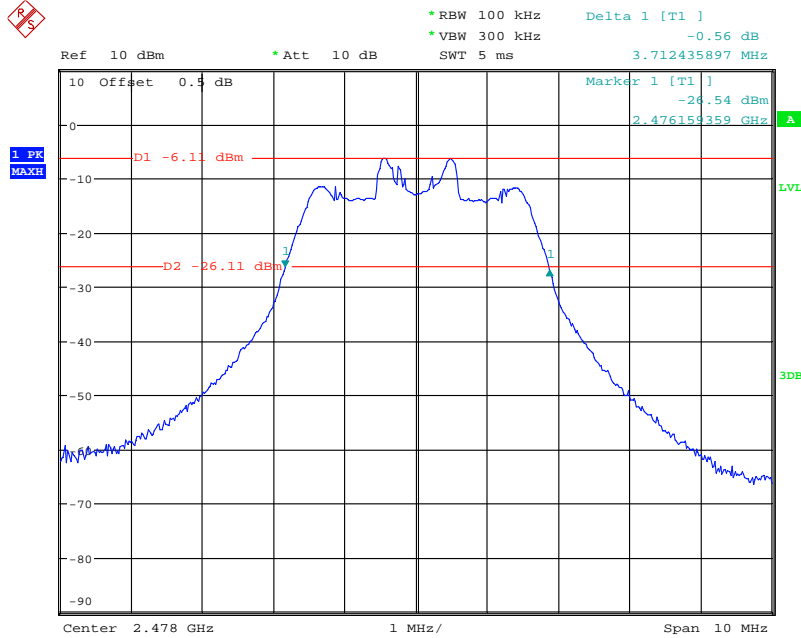

Date: 10.MAR.2021 19:04:06

99% Occupied Bandwidth:

2403 MHz

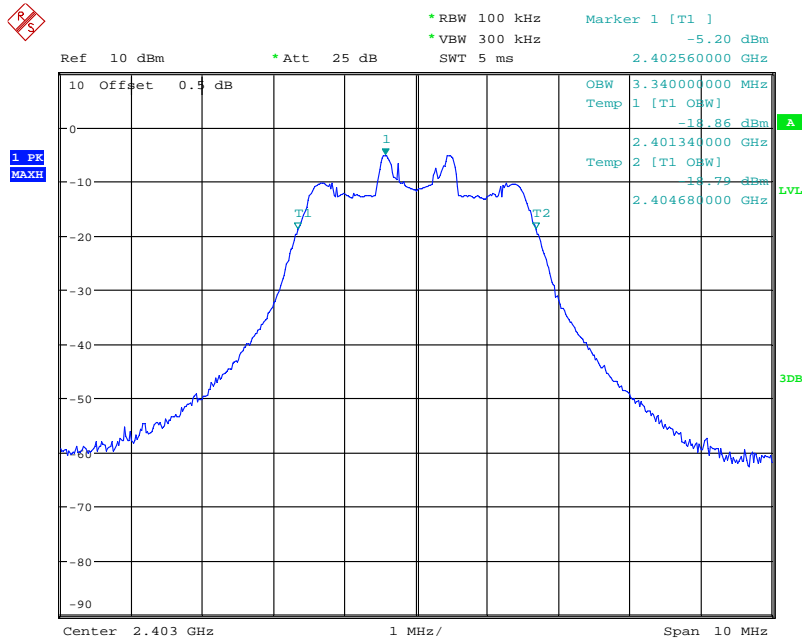

Date: 24.MAR.2021 15:20:25

2439 MHz

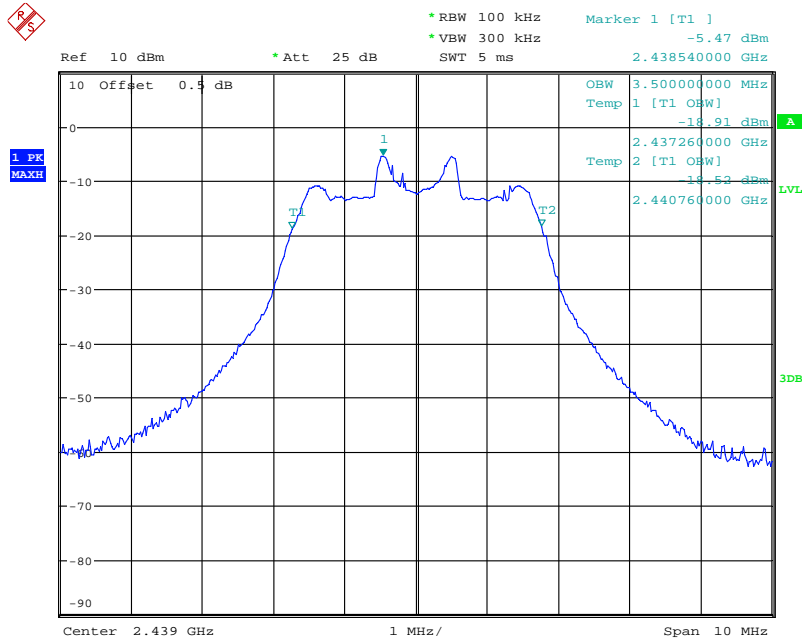

Date: 24.MAR.2021 15:21:00

2478 MHz

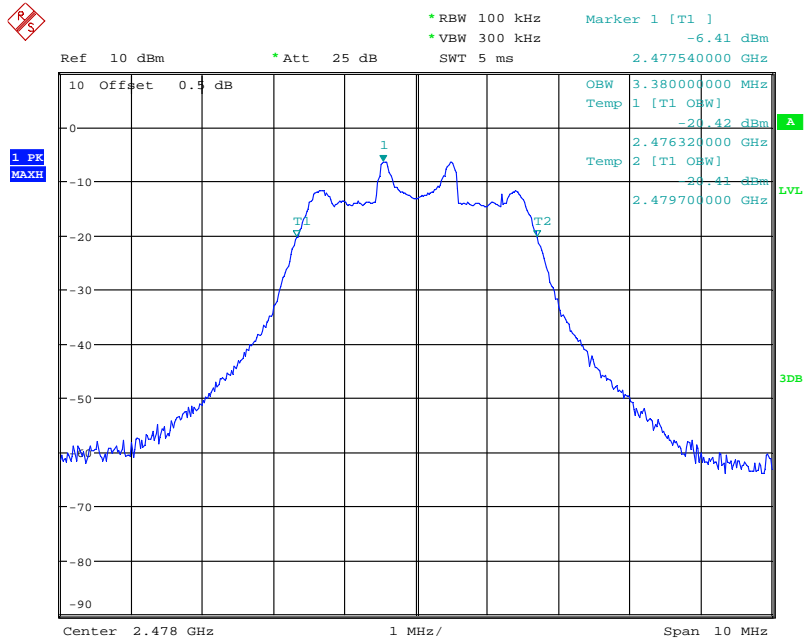

Date: 24.MAR.2021 15:21:24

***** END OF REPORT *****