



TESTING LABORATORY
CERTIFICATE #4820.01



FCC PART 15.247

TEST REPORT

For

MPOW TECHNOLOGY CO.,LIMITED

FLAT/RM 605 6/F FA YUEN COMMERCIAL BUILDING 75-77 FA YUEN STREET MONGKOK KL
HONG KONG

FCC ID: 2AMH2-BH316A

Report Type: Original Report	Product Name: Wireless Transmitter
Report Number:	<u>RDG190723010-00A</u>
Report Date:	<u>2019-08-20</u>
Reviewed By:	Jerry Zhang EMC Manager <i>Jerry Zhang</i>
Test Laboratory:	Bay Area Compliance Laboratories Corp. (Dongguan) No.69 Pulongcun, Puxihu Industry Area, Tangxia, Dongguan, Guangdong, China Tel: +86-769-86858888 Fax: +86-769-86858891 www.baclcorp.com.cn

Note: This test report is prepared for the customer shown above and for the device described herein. It may not be duplicated or used in part without prior written consent from Bay Area Compliance Laboratories Corp. (Dongguan). This report must not be used by the customer to claim product certification, approval, or endorsement by A2LA* or any agency of the Federal Government. * This report may contain data that are not covered by the A2LA accreditation and are marked with an asterisk “*”.

TABLE OF CONTENTS

GENERAL INFORMATION	4
PRODUCT DESCRIPTION FOR EQUIPMENT UNDER TEST (EUT).....	4
OBJECTIVE	4
RELATED SUBMITTAL(S)/GRANT(S).....	4
TEST METHODOLOGY	4
MEASUREMENT UNCERTAINTY.....	5
TEST FACILITY	5
SYSTEM TEST CONFIGURATION	6
DESCRIPTION OF TEST CONFIGURATION	6
EQUIPMENT MODIFICATIONS	6
EUT EXERCISE SOFTWARE	6
LOCAL SUPPORT EQUIPMENT LIST AND DETAILS	7
SUPPORT CABLE LIST AND DETAILS	7
BLOCK DIAGRAM OF TEST SETUP	8
SUMMARY OF TEST RESULTS	9
FCC §15.247 (i) & §1.1310 & §2.1091- MAXIMUM PERMISSIBLE EXPOSURE (MPE)	10
APPLICABLE STANDARD	10
FCC §15.203 - ANTENNA REQUIREMENT	11
APPLICABLE STANDARD	11
ANTENNA INFORMATION AND CONNECTOR CONSTRUCTION.....	11
FCC §15.207 (a)– AC LINE CONDUCTED EMISSIONS	12
APPLICABLE STANDARD	12
EUT SETUP.....	12
EMI TEST RECEIVER SETUP.....	12
TEST PROCEDURE	12
CORRECTED AMPLITUDE & MARGIN CALCULATION	13
TEST EQUIPMENT LIST AND DETAILS.....	13
TEST DATA	13
FCC §15.209, §15.205, §15.247(d) - SPURIOUS EMISSIONS	16
APPLICABLE STANDARD	16
EUT SETUP	16
EMI TEST RECEIVER & SPECTRUM ANALYZER SETUP	17
TEST PROCEDURE	17
CORRECTED AMPLITUDE & MARGIN CALCULATION	17
TEST EQUIPMENT LIST AND DETAILS.....	18
TEST DATA	18
FCC §15.247(a) (2) –6 dB EMISSION BANDWIDTH	24
APPLICABLE STANDARD	24
TEST PROCEDURE	24
TEST EQUIPMENT LIST AND DETAILS.....	24
TEST DATA	24
FCC §15.247(b) (3) - MAXIMUM PEAK CONDUCTED OUTPUT POWER	27
APPLICABLE STANDARD	27
TEST PROCEDURE	27

TEST EQUIPMENT LIST AND DETAILS.....27
TEST DATA28

FCC §15.247(d) – 100 kHz BANDWIDTH OF FREQUENCY BAND EDGE.....29

APPLICABLE STANDARD29
TEST PROCEDURE29
TEST EQUIPMENT LIST AND DETAILS.....29
TEST DATA30

FCC §15.247(e) - POWER SPECTRAL DENSITY32

APPLICABLE STANDARD32
TEST PROCEDURE32
TEST EQUIPMENT LIST AND DETAILS.....32
TEST DATA32

GENERAL INFORMATION

Product Description for Equipment under Test (EUT)

EUT Name:	Wireless Transmitter
EUT Model:	BH316A
Operation Frequency:	2402-2480MHz
Maximum Output Power (Conducted):	8.34dBm
Modulation Type:	GFSK
Rated Input Voltage:	DC 5V from USB port
External Dimension:	260mm(L)*45mm(W)*12mm(H)
Serial Number:	190723010
EUT Received Date:	2019-07-23

Objective

This report is prepared on behalf of the MPOW TECHNOLOGY CO.,LIMITED in accordance with Part 2, Subpart J, Part 15, Subparts A and C of the Federal Communications Commission's rules

The tests were performed in order to determine the compliance of the EUT with FCC Rules Part 15-Subpart C, section 15.203, 15.205, 15.207, 15.209, 15.247 rules.

Related Submittal(s)/Grant(s)

FCC Part 15C DSS submissions with FCC ID: 2AMH2-BH316A.

Test Methodology

All measurements contained in this report were conducted with ANSI C63.10-2013, American National Standard of Procedures for Compliance Testing of Unlicensed Wireless Devices and KDB 558074 D01 DTS Meas Guidance v05r02.

All emissions measurement was performed and Bay Area Compliance Laboratories Corp. (Dongguan).

Measurement Uncertainty

Parameter	Measurement Uncertainty
Occupied Channel Bandwidth	±5 %
RF output power, conducted	±0.61dB
Power Spectral Density, conducted	±0.61 dB
Unwanted Emissions, radiated	30M~200MHz: 4.55 dB, 200M~1GHz: 5.92 dB, 1G~6GHz: 4.98 dB, 6G~18GHz: 5.89 dB, 18G~26.5G: 5.47 dB, 26.5G~40G: 5.63 dB
Unwanted Emissions, conducted	±1.5 dB
Temperature	±1°C
Humidity	±5%
DC and low frequency voltages	±0.4%
Duty Cycle	1%
AC Power Lines Conducted Emission	3.12 dB (150 kHz to 30 MHz)

Test Facility

The Test site used by Bay Area Compliance Laboratories Corp. (Dongguan) to collect test data is located on the No.69 Pulongcun, Puxinhu Industry Area, Tangxia, Dongguan, Guangdong, China.

The lab has been recognized as the FCC accredited lab under the KDB 974614 D01 and is listed in the FCC Public Access Link (PAL) database, FCC Registration No. : 897218, the FCC Designation No. : CN1220.

The lab has been recognized by Innovation, Science and Economic Development Canada to test to Canadian radio equipment requirements, the CAB identifier: CN0022.

SYSTEM TEST CONFIGURATION

Description of Test Configuration

The system was configured for testing in engineering mode.

For Bluetooth LE mode, 40 channels are provided for testing:

Channel	Frequency (MHz)	Channel	Frequency (MHz)
0	2402	20	2442
1	2404
...
...
..	...	38	2478
19	2440	39	2480

EUT was tested with channel 0, 19 and 39.

Equipment Modifications

No modification was made to the EUT tested.

EUT Exercise Software

The software 'Bluetest 3' was used for testing, which was provided by manufacturer and the maximum power was configured as below table:

Channel	Frequency (MHz)	Power level
Low	2402	10
Middle	2440	10
High	2480	10

The duty cycle as below:

T _{on} (ms)	T _{on+off} (ms)	Duty Cycle (%)
0.449	0.629	71.38

Block Diagram of Test Setup

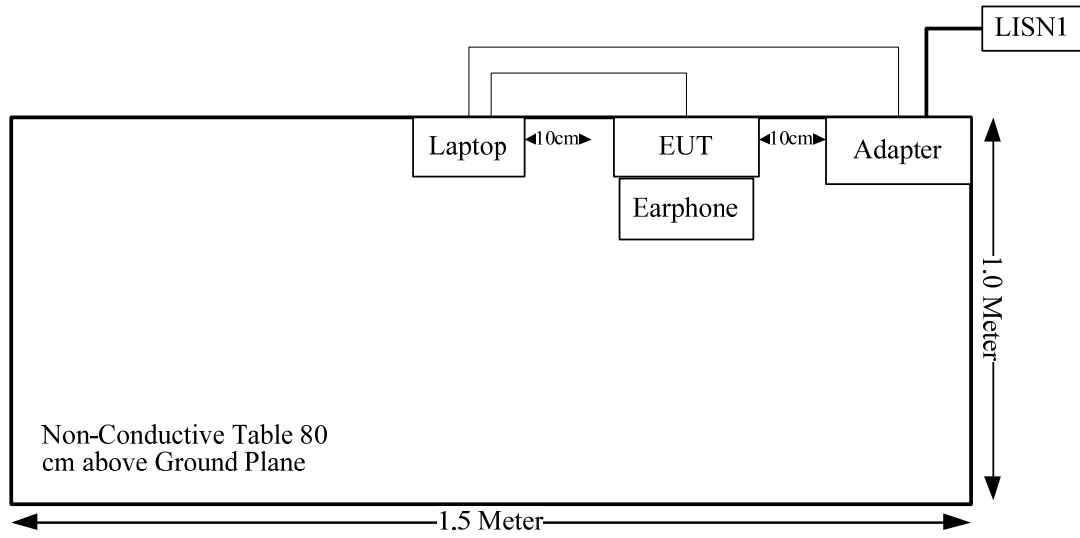

SUMMARY OF TEST RESULTS

FCC Rules	Description of Test	Result
FCC§15.247 (i) & §1.1310 & §2.1091	Maximum Permissible Exposure (MPE)	Compliance
FCC §15.203	Antenna requirement	Compliance
FCC §15.207(a)	AC line conducted emissions	Compliance
FCC §15.205, §15.209, §15.247(d)	Spurious emissions	Compliance
FCC §15.247(a)(2)	6 dB emission bandwidth	Compliance
FCC §15.247(b)(3)	Maximum conducted output power	Compliance
FCC §15.247(d)	100 kHz Bandwidth of frequency band edge	Compliance
FCC §15.247(e)	Power spectral density	Compliance

FCC §15.247 (i) & §1.1310 & §2.1091- MAXIMUM PERMISSIBLE EXPOSURE (MPE)

Applicable Standard

According to §15.247(i) and §1.1310, systems operating under the provisions of this section shall be operated in a manner that ensures that the public is not exposed to radio frequency energy level in excess of the Commission’s guidelines.

Limits for Maximum Permissible Exposure (MPE) (§1.1310, §2.1091)

(B) Limits for General Population/Uncontrolled Exposure				
Frequency Range (MHz)	Electric Field Strength (V/m)	Magnetic Field Strength (A/m)	Power Density (mW/cm ²)	Averaging Time (minutes)
0.3–1.34	614	1.63	*(100)	30
1.34–30	824/f	2.19/f	*(180/f ²)	30
30–300	27.5	0.073	0.2	30
300–1500	/	/	f/1500	30
1500–100,000	/	/	1.0	30

f = frequency in MHz; * = Plane-wave equivalent power density;

According to §1.1310 and §2.1091 RF exposure is calculated.

Calculated Formulary:

Predication of MPE limit at a given distance

$S = PG/4\pi R^2$ = power density (in appropriate units, e.g. mW/cm²);

P = power input to the antenna (in appropriate units, e.g., mW);

G = power gain of the antenna in the direction of interest relative to an isotropic radiator, the power gain factor, is normally numeric gain;

R = distance to the center of radiation of the antenna (appropriate units, e.g., cm);

Calculated Data:

Frequency Range (MHz)	Antenna Gain		Max. Target Power including Tolerance		Evaluation Distance (cm)	Power Density (W/m ²)	MPE Limit (W/m ²)
	(dBi)	(numeric)	(dBm)	(mW)			
2402-2480	0	1.00	9	7.94	20.00	0.002	1.0

Note: the Max. Target Power including Tolerance was declared by manufacturer.

Result: Compliance, The device meets MPE requirement for Devices Used by the General Public (Uncontrolled Environment) at distance ≥20 cm.

FCC §15.203 - ANTENNA REQUIREMENT

Applicable Standard

According to § 15.203, an intentional radiator shall be designed to ensure that no antenna other than that furnished by the responsible party shall be used with the device. The use of a permanently attached antenna or of an antenna that uses a unique coupling to the intentional radiator shall be considered sufficient to comply with the provisions of this section. The manufacturer may design the unit so that a broken antenna can be replaced by the user, but the user of a standard antenna jack or electrical connector is prohibited. The structure and application of the EUT were analyzed to determine compliance with section §15.203 of the rules. §15.203 state that the subject device must meet the following criteria:

- a. Antenna must be permanently attached to the unit.
- b. Antenna must use a unique type of connector to attach to the EUT.
- c. Unit must be professionally installed, and installer shall be responsible for verifying that the correct antenna is employed with the unit.

Antenna Information And Connector Construction

The EUT has one internal antenna arrangement for BT, and the antenna gain is 0 dBi, fulfill the requirement of this section. Please refer to the EUT photos.

Result: Compliance.

FCC §15.207 (a)– AC LINE CONDUCTED EMISSIONS

Applicable Standard

FCC§15.207(a)

EUT Setup

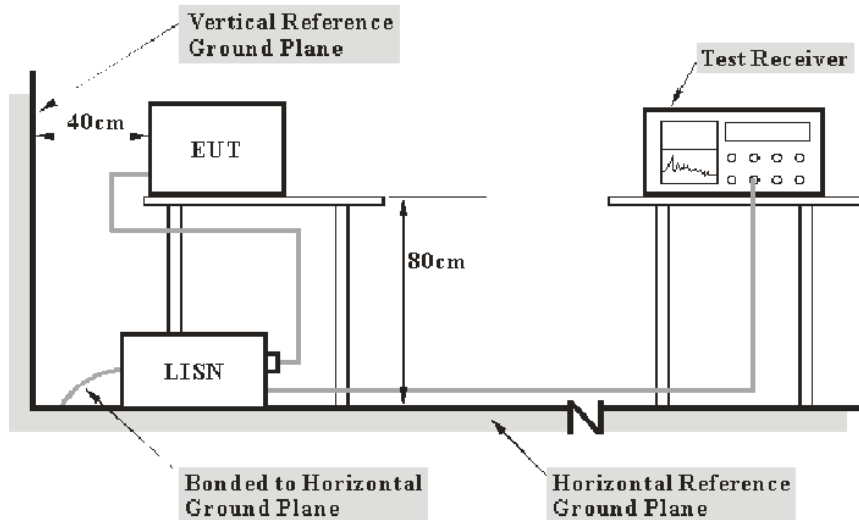

- Note: 1. Support units were connected to second LISN.
 2. Both of LISNs (AMN) 80 cm from EUT and at the least 80 cm from other units and other metal planes support units.

The setup of EUT is according with per ANSI C63.10-2013 measurement procedure. The specification used was with the FCC Part 15.207.

The spacing between the peripherals was 10 cm.

The adapter was connected to the main lisn with a 120 V/60 Hz AC power source.

EMI Test Receiver Setup

The EMI test receiver was set to investigate the spectrum from 150 kHz to 30 MHz.

During the conducted emission test, the EMI test receiver was set with the following configurations:

Frequency Range	IF B/W
150 kHz – 30 MHz	9 kHz

Test Procedure

During the conducted emission test, the adapter was connected to the first LISN.

Maximizing procedure was performed on the six (6) highest emissions of the EUT.

All data was recorded in the Quasi-peak and average detection mode.

Corrected Amplitude & Margin Calculation

The basic equation is as follows:

$$V_C = V_R + A_C + VDF$$

$$C_f = A_C + VDF$$

Herein,

V_C (cord. Reading): corrected voltage amplitude

V_R : reading voltage amplitude

A_C : attenuation caused by cable loss

VDF: voltage division factor of AMN

C_f : Correction Factor

The “**Margin**” column of the following data tables indicates the degree of compliance within the applicable limit. For example, a margin of 7dB means the emission is 7dB below the limit. The equation for margin calculation is as follows:

$$\text{Margin} = \text{Limit} - \text{Corrected Amplitude}$$

Test Equipment List and Details

Manufacturer	Description	Model	Serial Number	Calibration Date	Calibration Due Date
Unknown	Coaxial Cable	C-NJNJ-50	C-0200-01	2018-09-05	2019-09-05
R&S	Test Software	EMC32	Version8.53.0	N/A	N/A
R&S	Two-line V-network	ENV 216	101614	2018-12-10	2019-12-10
R&S	EMI Test Receiver	ESPI	100120	2019-05-09	2020-05-09

* **Statement of Traceability:** Bay Area Compliance Laboratories Corp. (Dongguan) attests that all calibrations have been performed, traceable to National Primary Standards and International System of Units (SI).

Test Data

Environmental Conditions

Temperature:	28.4°C
Relative Humidity:	46%
ATM Pressure:	100.8kPa
Tester:	Ade Xiao
Test Date:	2019-08-06

Test Result: Compliance

Test Mode: Transmitting

AC120 V, 60 Hz, Line:

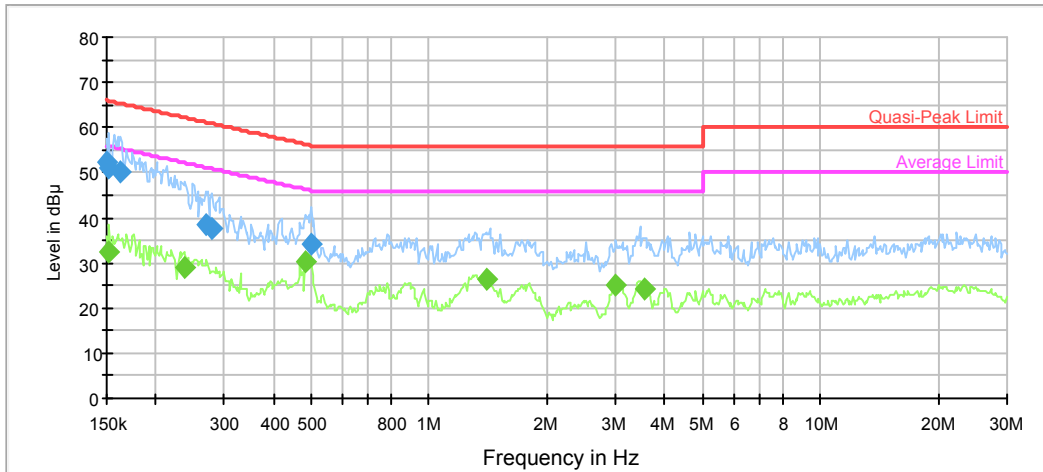

Frequency (MHz)	QuasiPeak (dB μ V)	Bandwidth (kHz)	Line	Corr. (dB)	Margin (dB)	Limit (dB μ V)
0.150000	52.4	9.000	L1	11.2	13.6	66.0
0.152410	51.2	9.000	L1	11.1	14.7	65.9
0.162441	50.1	9.000	L1	11.0	15.3	65.3
0.268355	38.6	9.000	L1	10.2	22.6	61.2
0.279263	37.6	9.000	L1	10.2	23.2	60.8
0.499611	34.1	9.000	L1	9.9	22.0	56.0

Frequency (MHz)	Average (dB μ V)	Bandwidth (kHz)	Line	Corr. (dB)	Margin (dB)	Limit (dB μ V)
0.152410	32.5	9.000	L1	11.1	23.4	55.9
0.236234	28.8	9.000	L1	10.4	23.4	52.2
0.483938	30.4	9.000	L1	9.9	15.9	46.3
1.407671	26.3	9.000	L1	9.8	19.7	46.0
3.000901	25.0	9.000	L1	9.8	21.0	46.0
3.547503	24.3	9.000	L1	9.8	21.7	46.0

AC120 V, 60 Hz, Neutral:

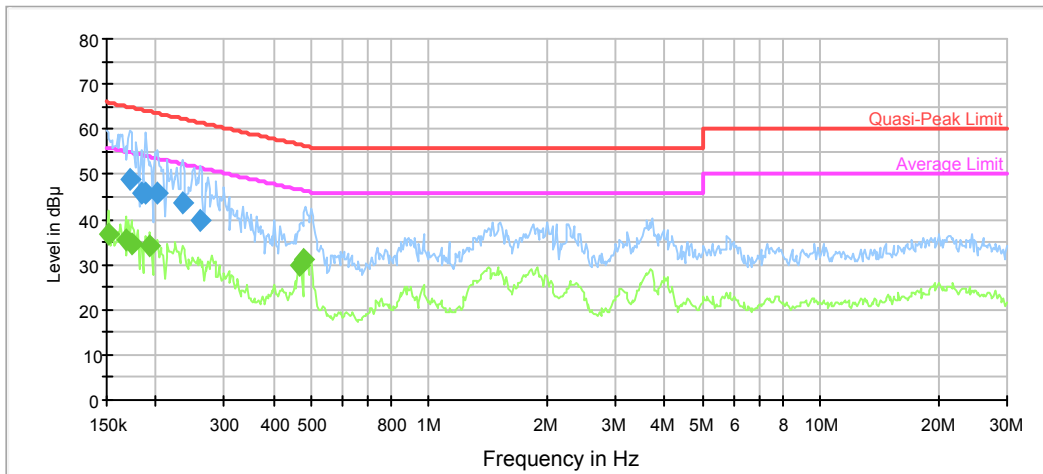

Frequency (MHz)	QuasiPeak (dBμV)	Bandwidth (kHz)	Line	Corr. (dB)	Margin (dB)	Limit (dBμV)
0.171759	49.0	9.000	N	10.9	15.8	64.9
0.184529	45.9	9.000	N	10.7	18.4	64.3
0.188994	45.7	9.000	N	10.7	18.3	64.1
0.203045	45.7	9.000	N	10.6	17.8	63.5
0.234359	43.7	9.000	N	10.4	18.6	62.3
0.259937	39.6	9.000	N	10.3	21.9	61.4

Frequency (MHz)	Average (dBμV)	Bandwidth (kHz)	Line	Corr. (dB)	Margin (dB)	Limit (dBμV)
0.152410	36.7	9.000	N	11.1	19.2	55.9
0.167702	35.5	9.000	N	10.9	19.6	55.1
0.173134	34.4	9.000	N	10.9	20.4	54.8
0.193566	34.0	9.000	N	10.7	19.9	53.9
0.468757	30.0	9.000	N	9.9	16.5	46.5
0.480097	31.3	9.000	N	9.9	15.0	46.3

FCC §15.209, §15.205, §15.247(a) - SPURIOUS EMISSIONS

Applicable Standard

FCC §15.247 (d); §15.209; §15.205

EUT Setup

Below 1GHz:

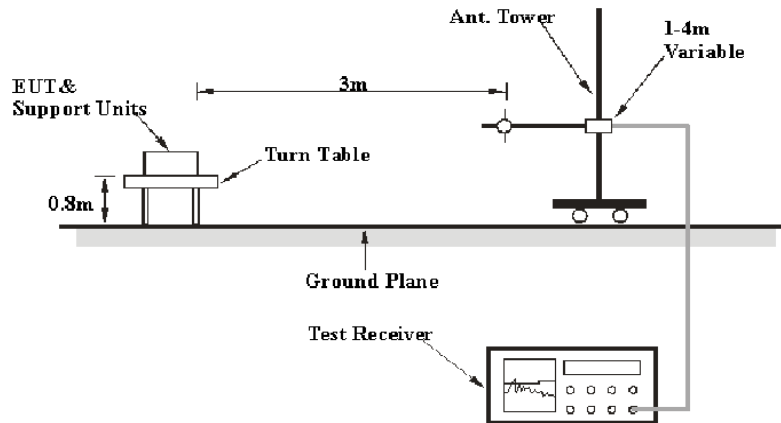

Above 1GHz:

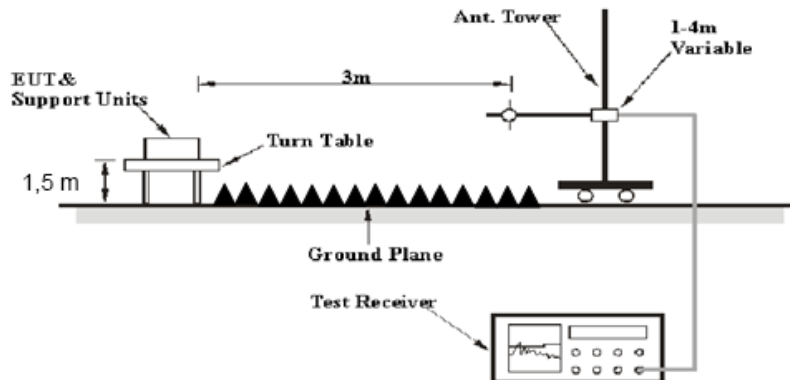

The radiated emission below 1GHz tests were performed in the 3 meters chamber A, above 1GHz tests were performed in the 3 meters chamber B, using the setup accordance with the ANSI C63.10-2013. The specification used was the FCC 15.209, and FCC 15.247 limits.

The external I/O cables were draped along the test table and formed a bundle 30 to 40 cm long in the middle.

The spacing between the peripherals was 10 cm.

EMI Test Receiver & Spectrum Analyzer Setup

The system was investigated from 30 MHz to 25 GHz.

During the radiated emission test, the EMI test receiver & Spectrum Analyzer Setup were set with the following configurations:

30MHz-1000MHz:

Measurement	RBW	Video B/W	IF B/W
QP	120 kHz	300 kHz	120kHz

1GHz- 25GHz:

Measurement	Duty cycle	RBW	Video B/W
PK	Any	1MHz	3 MHz
AV	>98%	1MHz	10 Hz
	<98%	1MHz	1/T

Note: T is minimum transmission duration

If the maximized peak measured value complies with under the QP/Average limit more than 6dB, then it is unnecessary to perform an QP/Average measurement.

Test Procedure

Maximizing procedure was performed on the highest emissions to ensure that the EUT complied with all installation combinations.

Data was recorded in Quasi-peak detection mode for frequency range of 30 MHz-1 GHz, peak and Average detection modes for frequencies above 1 GHz.

Corrected Amplitude & Margin Calculation

The Corrected Amplitude is calculated by adding the Antenna Factor and Cable Loss, and subtracting the Amplifier Gain from the Meter Reading. The basic equation is as follows:

$$\text{Corrected Amplitude} = \text{Meter Reading} + \text{Antenna Factor} + \text{Cable Loss} - \text{Amplifier Gain}$$

The “**Margin**” column of the following data tables indicates the degree of compliance with the applicable limit. For example, a margin of 7dB means the emission is 7dB below the limit. The equation for margin calculation is as follows:

$$\text{Margin} = \text{Limit} - \text{Corrected Amplitude}$$

Test Equipment List and Details

Manufacturer	Description	Model	Serial Number	Calibration Date	Calibration Due Date
R&S	EMI Test Receiver	ESR3	102453	2019-06-26	2020-06-26
Farad	Test Software	EZ-EMC	V1.1.4.2	N/A	N/A
Sunol Sciences	Antenna	JB3	A060611-1	2017-11-10	2020-11-10
Unknown	Coaxial Cable	C-NJNJ-50	C-0400-01	2018-09-05	2019-09-05
Unknown	Coaxial Cable	C-NJNJ-50	C-0075-01	2018-09-05	2019-09-05
Unknown	Coaxial Cable	C-NJNJ-50	C-1400-01	2019-05-06	2020-05-06
HP	Amplifier	8447D	2727A05902	2018-09-05	2019-09-05
Agilent	Spectrum Analyzer	E4440A	SG43360054	2019-05-09	2020-05-09
ETS-Lindgren	Horn Antenna	3115	000 527 35	2018-10-12	2021-10-12
Ducommun Technologies	Horn Antenna	ARH-4223-02	1007726-01 1304	2016-11-18	2019-11-18
Unknown	Coaxial Cable	C-SJSJ-50	C-0800-01	2018-09-05	2019-09-05
Unknown	Coaxial Cable	C-2.4J2.4J-50	C-0700-02	2019-06-27	2020-06-27
MITEQ	Amplifier	AFS42-00101800- 25-S-42	2001271	2018-09-05	2019-09-05
Quinstar	Amplifier	QLW-18405536-JO	15964001001	2019-06-27	2020-06-27
E-Microwave	Band-stop Filters	OBSF-2400-2483.5- S	OE01601525	2019-06-16	2020-06-16
Micro-tronics	High Pass Filter	HPM50111	S/N-G217	2019-06-16	2020-06-16

* **Statement of Traceability:** Bay Area Compliance Laboratories Corp. (Dongguan) attests that all calibrations have been performed, traceable to National Primary Standards and International System of Units (SI).

Test Data**Environmental Conditions**

Test Items	Radiation Below 1GHz	Radiation Above 1GHz
Temperature:	27.0 °C	27.0 °C
Relative Humidity:	50%	50%
ATM Pressure:	100.2 kPa	100.2 kPa
Tester:	Tyler Pan	Lucy Lu
Test Date:	2019-08-03	2019-08-03

Test Mode: Transmitting

Test Result: Compliance. Please refer to the following table and plots.

1) 30MHz-1GHz (Low Channel was the worst):

Horizontal:

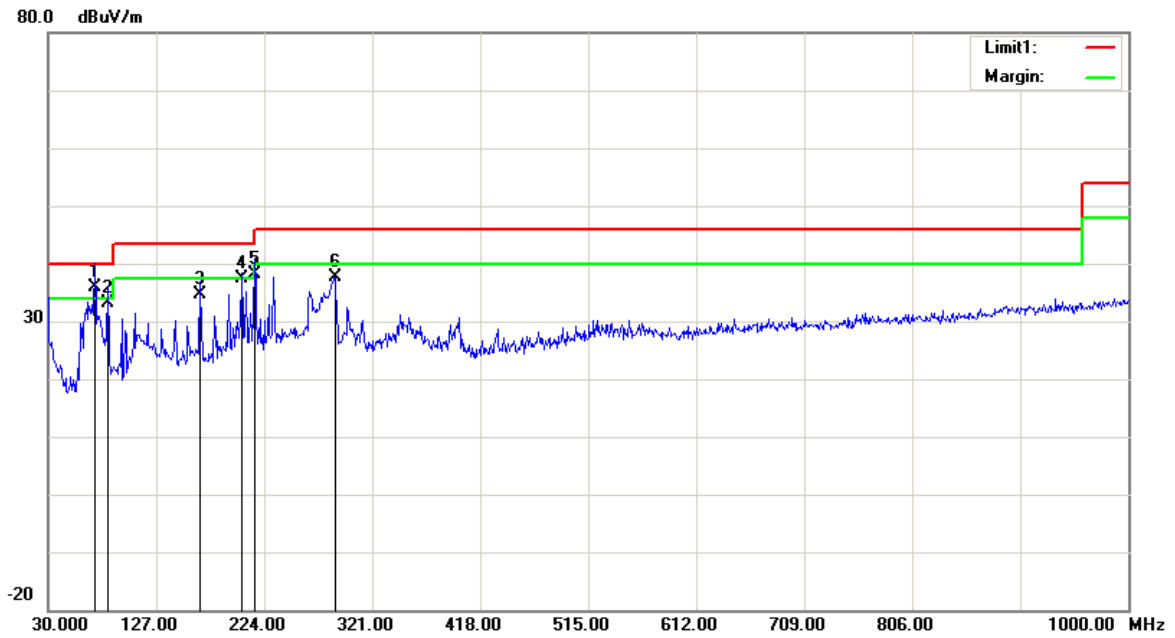

Frequency (MHz)	Receiver Reading (dBuV)	Detector	Correction Factor (dB/m)	Cord. Amp. (dBuV/m)	Limit (dBuV/m)	Margin (dB)
71.7100	46.87	QP	-11.06	35.81	40.00	4.19
83.3500	44.39	QP	-11.34	33.05	40.00	6.95
165.8000	40.96	QP	-6.21	34.75	43.50	8.75
203.6300	43.58	QP	-6.29	37.29	43.50	6.21
215.2700	45.25	QP	-7.20	38.05	43.50	5.45
288.0200	41.73	peak	-4.03	37.70	46.00	8.30

Vertical:

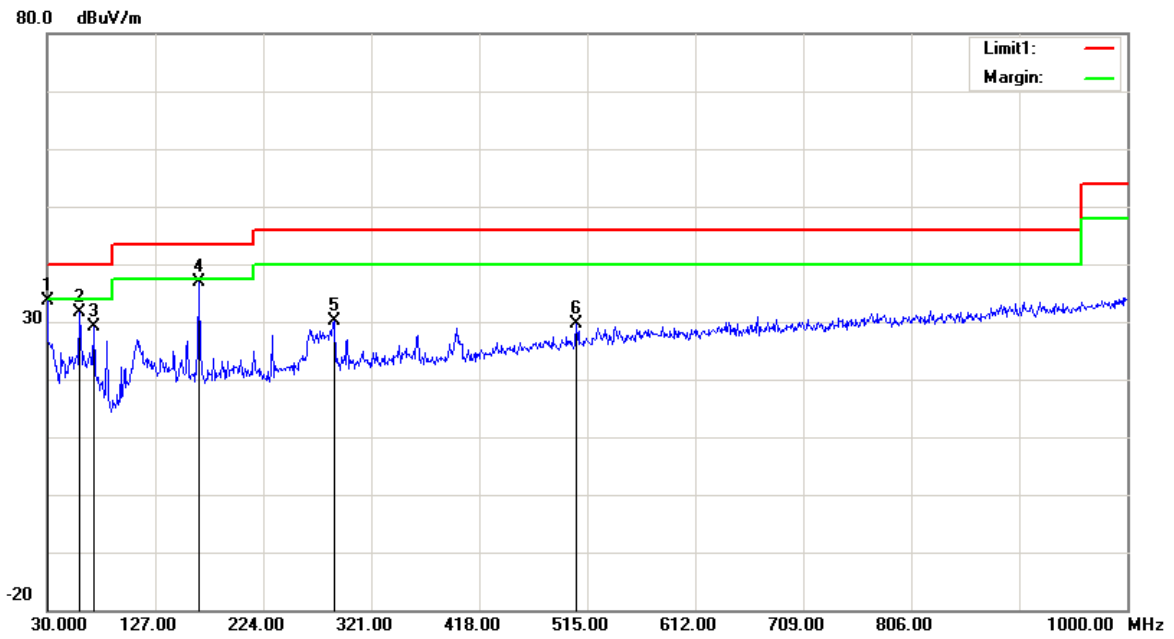

Frequency (MHz)	Receiver Reading (dBuV)	Detector	Correction Factor (dB/m)	Cord. Amp. (dBuV/m)	Limit (dBuV/m)	Margin (dB)
30.0000	32.02	peak	1.72	33.74	40.00	6.26
59.1000	43.71	peak	-12.18	31.53	40.00	8.47
71.7100	40.24	peak	-11.06	29.18	40.00	10.82
165.8000	43.00	peak	-6.21	36.79	43.50	6.71
288.0200	34.19	peak	-4.03	30.16	46.00	15.84
505.3000	29.91	peak	-0.27	29.64	46.00	16.36

2) 1-25GHz:

Frequency (MHz)	Receiver		Rx Antenna		Cable loss (dB)	Amplifier Gain (dB)	Corrected Amplitude (dB μ V/m)	Limit (dB μ V/m)	Margin (dB)
	Reading (dB μ V)	Detector (PK/QP/AV)	Polar (H/V)	Factor (dB/m)					
Low Channel: 2402 MHz									
2402.00	67.79	PK	H	28.10	1.80	0.00	97.69	N/A	N/A
2402.00	67.42	AV	H	28.10	1.80	0.00	97.32	N/A	N/A
2402.00	60.24	PK	V	28.10	1.80	0.00	90.14	N/A	N/A
2402.00	59.69	AV	V	28.10	1.80	0.00	89.59	N/A	N/A
2390.00	26.54	PK	H	28.08	1.80	0.00	56.42	74.00	17.58
2390.00	13.54	AV	H	28.08	1.80	0.00	43.42	54.00	10.58
4804.00	54.58	PK	H	32.91	3.17	37.20	53.46	74.00	20.54
4804.00	50.77	AV	H	32.91	3.17	37.20	49.65	54.00	4.35
7206.00	44.54	PK	H	35.74	4.82	37.23	47.87	74.00	26.13
7206.00	32.11	AV	H	35.74	4.82	37.23	35.44	54.00	18.56
Middle Channel: 2440 MHz									
2440.00	68.12	PK	H	28.18	1.82	0.00	98.12	N/A	N/A
2440.00	67.58	AV	H	28.18	1.82	0.00	97.58	N/A	N/A
2440.00	60.38	PK	V	28.18	1.82	0.00	90.38	N/A	N/A
2440.00	59.76	AV	V	28.18	1.82	0.00	89.76	N/A	N/A
4880.00	55.35	PK	H	33.06	3.27	37.21	54.47	74.00	19.53
4880.00	51.69	AV	H	33.06	3.27	37.21	50.81	54.00	3.19
7320.00	44.77	PK	H	36.03	4.62	37.37	48.05	74.00	25.95
7320.00	32.25	AV	H	36.03	4.62	37.37	35.53	54.00	18.47
High Channel: 2480 MHz									
2480.00	69.35	PK	H	28.26	1.84	0.00	99.45	N/A	N/A
2480.00	68.77	AV	H	28.26	1.84	0.00	98.87	N/A	N/A
2480.00	61.35	PK	V	28.26	1.84	0.00	91.45	N/A	N/A
2480.00	60.87	AV	V	28.26	1.84	0.00	90.97	N/A	N/A
2483.50	27.54	PK	H	28.27	1.84	0.00	57.65	74.00	16.35
2483.50	14.25	AV	H	28.27	1.84	0.00	44.36	54.00	9.64
4960.00	56.09	PK	H	33.22	3.23	37.25	55.29	74.00	18.71
4960.00	53.51	AV	H	33.22	3.23	37.25	52.71	54.00	1.29
7440.00	45.54	PK	H	36.34	4.41	37.52	48.77	74.00	25.23
7440.00	32.21	AV	H	36.34	4.41	37.52	35.44	54.00	18.56

Worst plots (High Channel) Horizontal

Fundamental
Test with Band
Rejection Filter

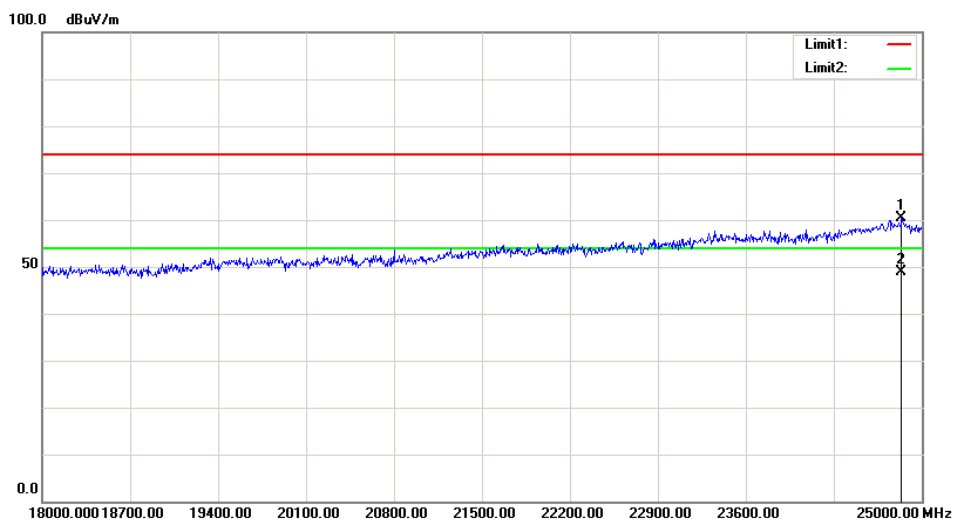
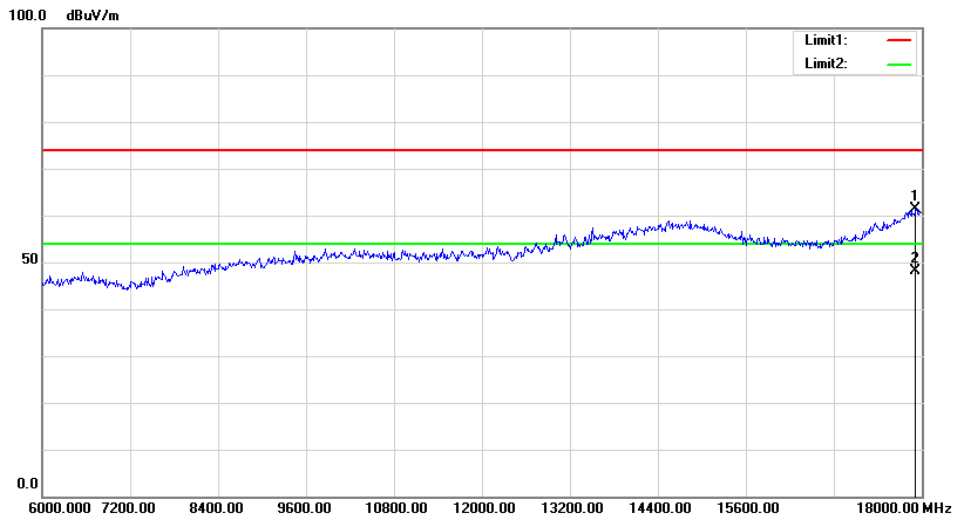
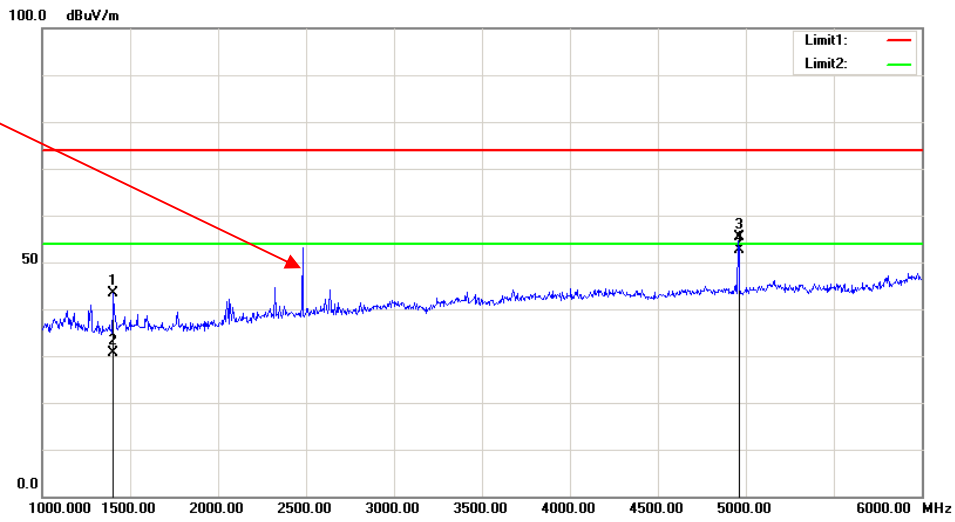

Vertical

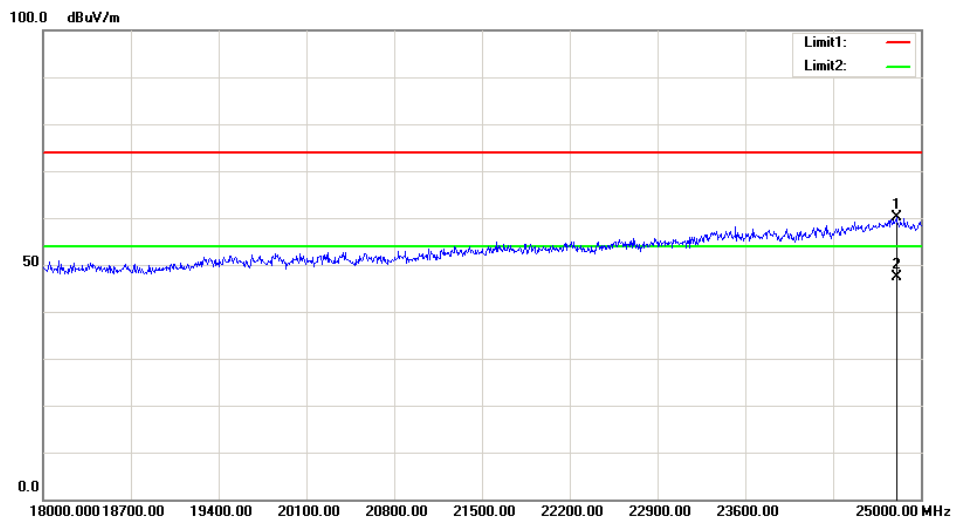
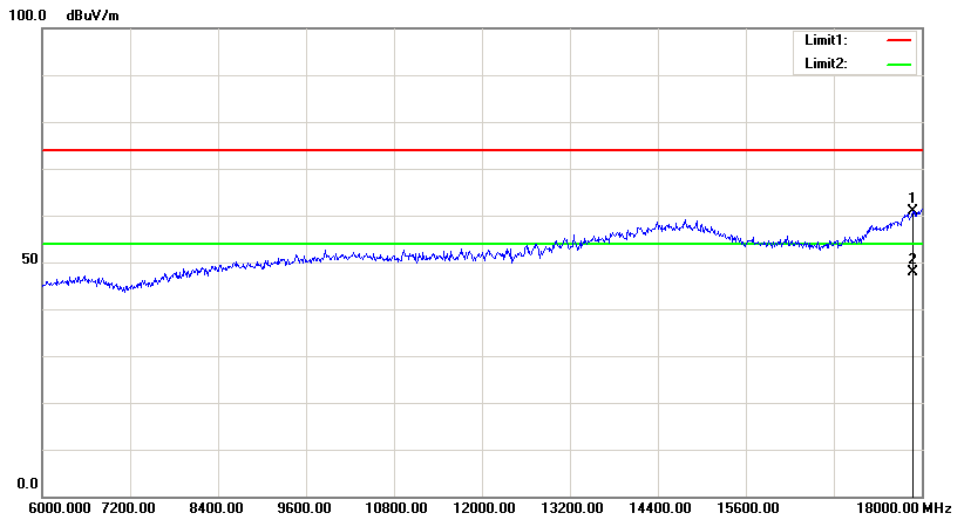
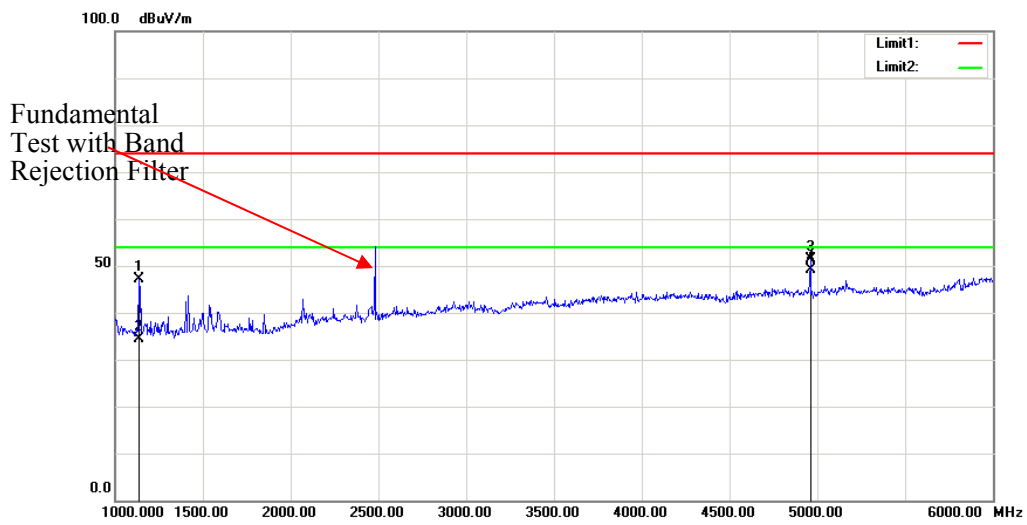

FCC §15.247(a) (2) –6 dB EMISSION BANDWIDTH

Applicable Standard

According to FCC §15.247(a) (2)

Systems using digital modulation techniques may operate in the 902–928 MHz, 2400–2483.5 MHz, and 5725–5850 MHz bands. The minimum 6 dB bandwidth shall be at least 500 kHz.

Test Procedure

- a) Set RBW = 100 kHz.
- b) Set the video bandwidth (VBW) $\geq 3 \times$ RBW.
- c) Detector = Peak.
- d) Trace mode = max hold.
- e) Sweep = auto couple.
- f) Allow the trace to stabilize.
- g) Measure the maximum width of the emission that is constrained by the frequencies associated with the two outermost amplitude points (upper and lower frequencies) that are attenuated by 6 dB relative to the maximum level measured in the fundamental emission.

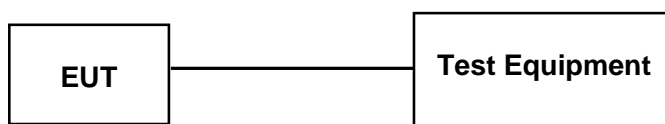

Test Equipment List and Details

Manufacturer	Description	Model	Serial Number	Calibration Date	Calibration Due Date
R&S	Spectrum Analyzer	FSP 38	100478	2019-05-09	2020-05-09
Unknown	Coaxial Cable	C-SJ00-0010	C0010/06	Each time	N/A

* **Statement of Traceability:** Bay Area Compliance Laboratories Corp. (Dongguan) attests that all calibrations have been performed, traceable to National Primary Standards and International System of Units (SI).

Test Data

Environmental Conditions

Temperature:	25.1 °C
Relative Humidity:	62 %
ATM Pressure:	100.3 kPa
Tester:	Elena Lei
Test Date:	2019-07-31

Test Mode: Transmitting

Test Result: Compliance. Please refer to the following table and plots.

Channel	Frequency (MHz)	6 dB Emission Bandwidth (MHz)	Limit (MHz)
Low	2402	0.708	≥0.5
Middle	2440	0.704	≥0.5
High	2480	0.708	≥0.5

Low Channel

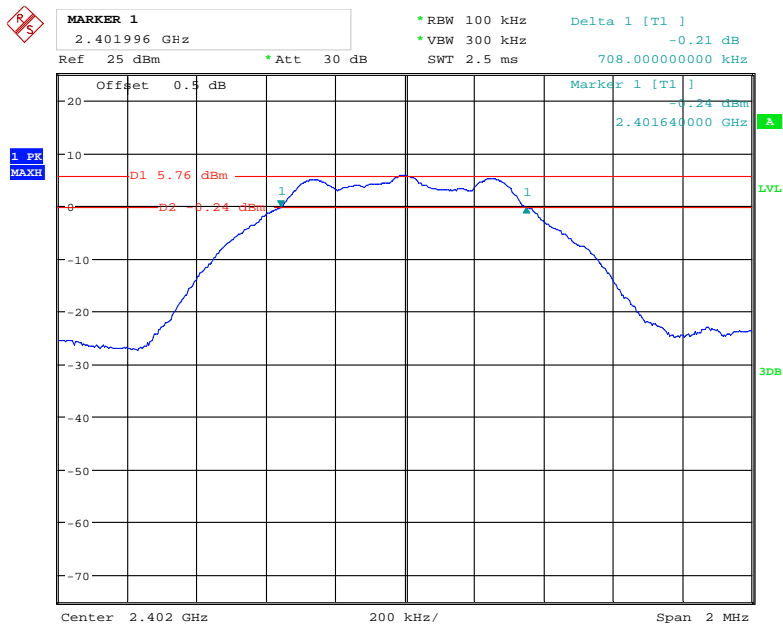

Date: 31.JUL.2019 11:29:46

Middle Channel

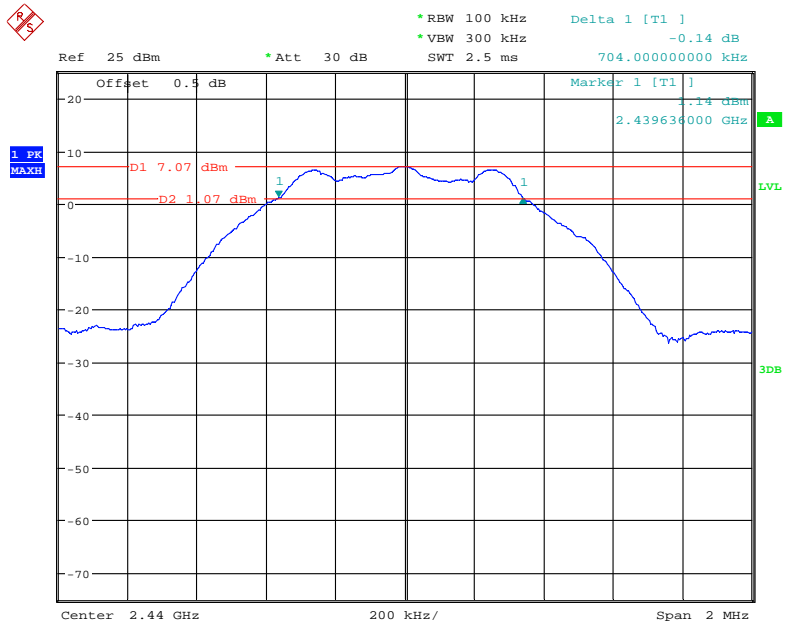

Date: 31.JUL.2019 11:32:56

High Channel

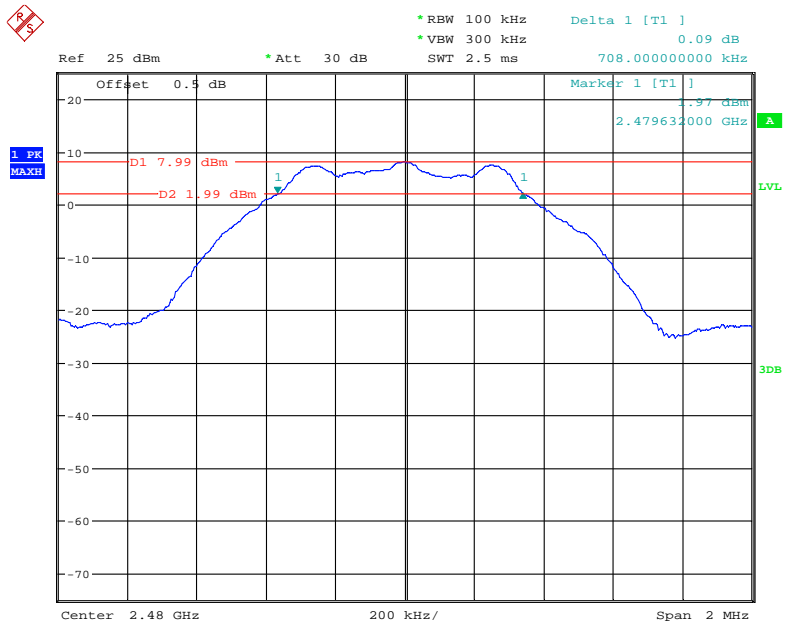

Date: 31.JUL.2019 11:31:27

FCC §15.247(b) (3) - MAXIMUM PEAK CONDUCTED OUTPUT POWER

Applicable Standard

According to FCC §15.247(b) (3), for systems using digital modulation in the 902-928 MHz, 2400-2483.5 MHz, and 5725-5850 MHz bands: 1 Watt. As an alternative to a peak power measurement, compliance with the one Watt limit can be based on a measurement of the maximum conducted output power. Maximum Conducted Output Power is defined as the total transmit power delivered to all antennas and antenna elements averaged across all symbols in the signaling alphabet when the transmitter is operating at its maximum power control level. Power must be summed across all antennas and antenna elements. The average must not include any time intervals during which the transmitter is off or is transmitting at a reduced power level. If multiple modes of operation are possible (e.g., alternative modulation methods), the maximum conducted output power is the highest total transmit power occurring in any mode.

Test Procedure

1. Place the EUT on a bench and set it in transmitting mode.
2. Remove the antenna from the EUT and then connect a low loss RF cable from the antenna port to test equipment.
3. Add a correction factor to the display.

Test Equipment List and Details

Manufacturer	Description	Model	Serial Number	Calibration Date	Calibration Due Date
Unknown	Coaxial Cable	C-SJ00-0010	C0010/06	Each time	N/A
Agilent	USB Wideband Power Sensor	U2021XA	MY5425009	2019-05-09	2020-05-09

* **Statement of Traceability:** Bay Area Compliance Laboratories Corp. (Dongguan) attests that all calibrations have been performed, traceable to National Primary Standards and International System of Units (SI).

Test Data**Environmental Conditions**

Temperature:	25.1 °C
Relative Humidity:	62 %
ATM Pressure:	100.3 kPa
Tester:	Elena Lei
Test Date:	2019-07-31

Test Mode: Transmitting

Test Result: Compliance. Please refer to the following table.

Channel	Frequency (MHz)	Max Peak Conducted Output Power (dBm)	Limit (dBm)
Low	2402	6.11	30
Middle	2440	7.41	30
High	2480	8.34	30

FCC §15.247(d) – 100 kHz BANDWIDTH OF FREQUENCY BAND EDGE

Applicable Standard

According to FCC§15.247(d):In any 100 kHz bandwidth outside the frequency band in which the spread spectrum or digitally modulated intentional radiator is operating, the radio frequency power that is produced by the intentional radiator shall be at least 20 dB below that in the 100 kHz bandwidth within the band that contains the highest level of the desired power, based on either an RF conducted or a radiated measurement, provided the transmitter demonstrates compliance with the peak conducted power limits. If the transmitter complies with the conducted power limits based on the use of RMS averaging over a time interval, as permitted under paragraph (b)(3) of this section, the attenuation required under this paragraph shall be 30 dB instead of 20 dB. Attenuation below the general limits specified in §15.209(a) is not required. In addition, radiated emissions which fall in the restricted bands, as defined in §15.205(a), must also comply with the radiated emission limits specified in §15.209(a) (see §15.205(c)).

Test Procedure

1. Check the calibration of the measuring instrument using either an internal calibrator or a known signal from an external generator.
2. Position the EUT without connection to measurement instrument. Turn on the EUT and connect its antenna terminal to measurement instrument via a low loss cable. Then set it to any one measured frequency within its operating range, and make sure the instrument is operated in its linear range.
3. Set RBW to 100 kHz and VBW of spectrum analyzer to 300 kHz with a convenient frequency span including 100 kHz bandwidth from band edge.
4. Measure the highest amplitude appearing on spectral display and set it as a reference level. Plot the graph with marking the highest point and edge frequency.
5. Repeat above procedures until all measured frequencies were complete.

Test Equipment List and Details

Manufacturer	Description	Model	Serial Number	Calibration Date	Calibration Due Date
R&S	Spectrum Analyzer	FSP 38	100478	2019-05-09	2020-05-09
Unknown	Coaxial Cable	C-SJ00-0010	C0010/06	Each time	N/A

* **Statement of Traceability:** Bay Area Compliance Laboratories Corp. (Dongguan) attests that all calibrations have been performed, traceable to National Primary Standards and International System of Units (SI).

Test Data

Environmental Conditions

Temperature:	25.1 °C
Relative Humidity:	62 %
ATM Pressure:	100.3 kPa
Tester:	Elena Lei
Test Date:	2019-07-31

Test mode: Transmitting
 Test Result: Compliance. Please refer to following plots.

Band Edge, Left Side

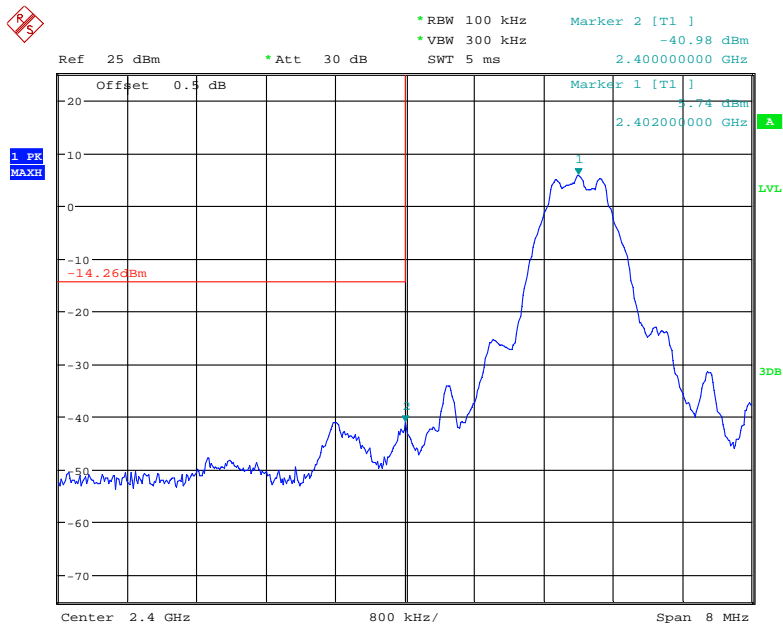

Date: 31.JUL.2019 11:30:52

Band Edge, Right Side

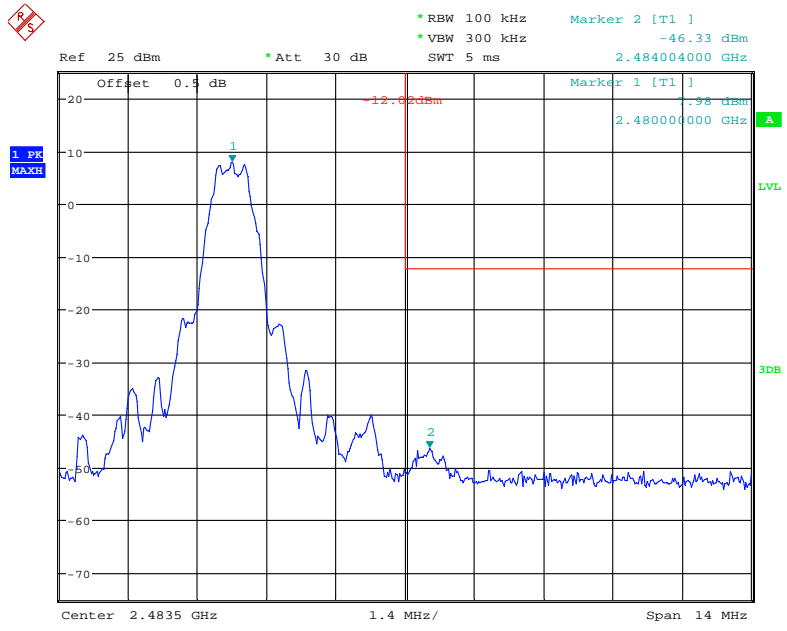

Date: 31.JUL.2019 11:32:27

FCC §15.247(e) - POWER SPECTRAL DENSITY

Applicable Standard

According to FCC§15.247(e):For digitally modulated systems, the power spectral density conducted from the intentional radiator to the antenna shall not be greater than 8 dBm in any 3 kHz band during any time interval of continuous transmission. This power spectral density shall be determined in accordance with the provisions of paragraph (b) of this section. The same method of determining the conducted output power shall be used to determine the power spectral density.

Test Procedure

1. Check the calibration of the measuring instrument using either an internal calibrator or a known signal from an external generator.
2. Position the EUT was set without connection to measurement instrument. Turn on the EUT and connect its antenna terminal to measurement instrument via a low loss cable. Then set it to any one measured frequency within its operating range, and make sure the instrument is operated in its linear range.
3. Set the RBW = 3 kHz, VBW = 10 kHz, Set the span to 1.5 times the DTS bandwidth.
4. Use the peak marker function to determine the maximum amplitude level.

Test Equipment List and Details

Manufacturer	Description	Model	Serial Number	Calibration Date	Calibration Due Date
R&S	Spectrum Analyzer	FSP 38	100478	2019-05-09	2020-05-09
Unknown	Coaxial Cable	C-SJ00-0010	C0010/06	Each time	N/A

* **Statement of Traceability:** Bay Area Compliance Laboratories Corp. (Dongguan) attests that all calibrations have been performed, traceable to National Primary Standards and International System of Units (SI).

Test Data

Environmental Conditions

Temperature:	25.1 °C
Relative Humidity:	62 %
ATM Pressure:	100.3 kPa
Tester:	Elena Lei
Test Date:	2019-07-31

Test Mode: Transmitting

Test Result: Compliance. Please refer to the following table and plots

Channel	Frequency (MHz)	Power Spectral Density (dBm/3kHz)	Limit (dBm/3kHz)
Low	2402	-9.59	≤8
Middle	2440	-8.34	≤8
High	2480	-7.46	≤8

Power Spectral Density, Low Channel

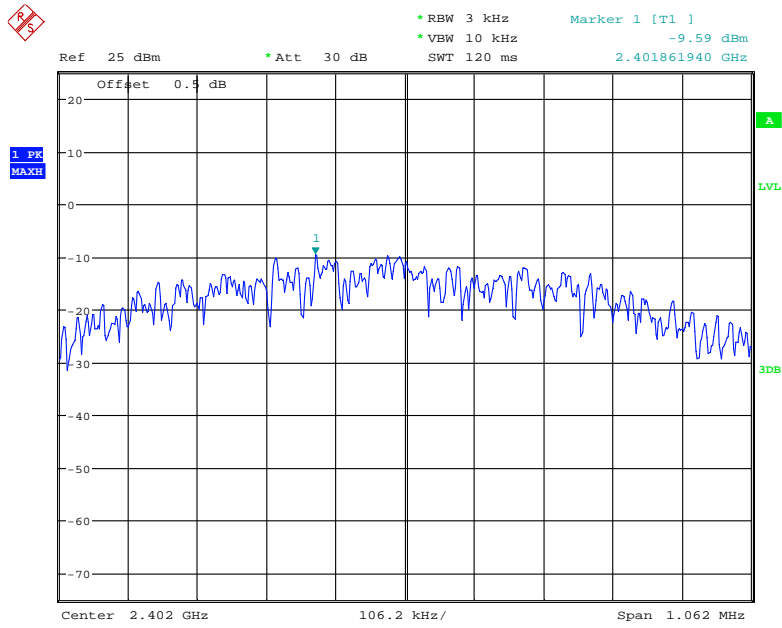

Date: 31.JUL.2019 11:30:29

Power Spectral Density, Middle Channel

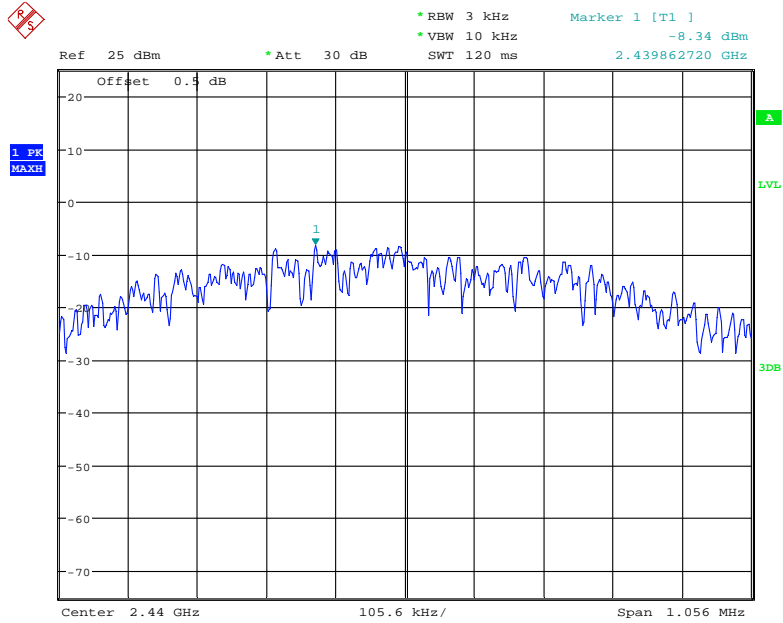

Date: 31.JUL.2019 11:33:33

Power Spectral Density, High Channel

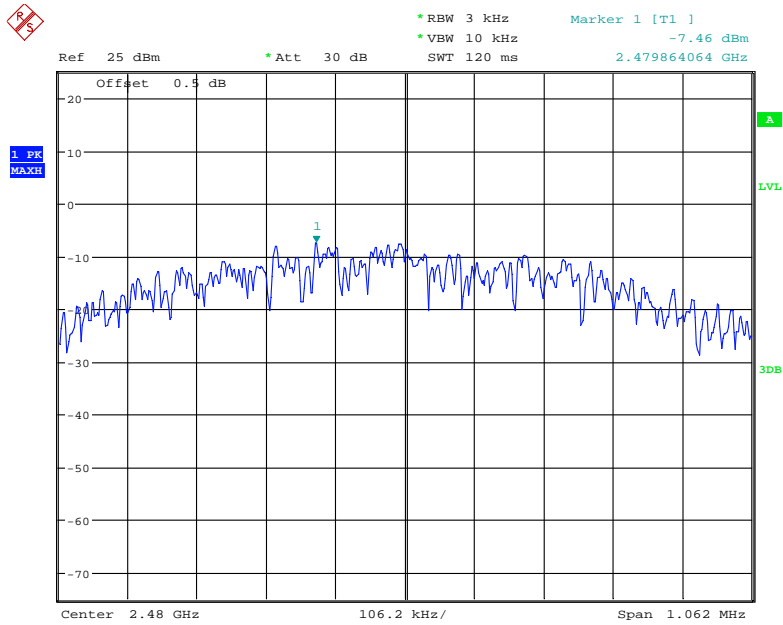

Date: 31.JUL.2019 11:32:04

***** END OF REPORT *****