

WIRELESS RECEIVER TRANSMITTER

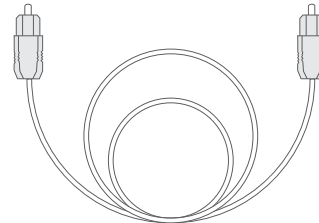
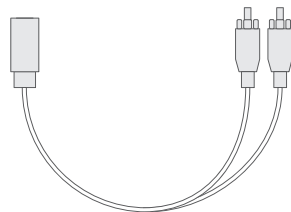
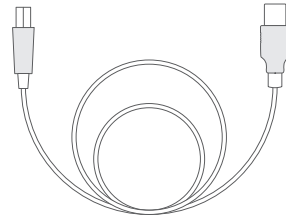
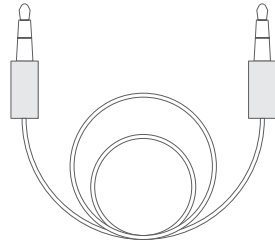
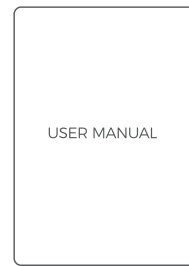

Specifications

Bluetooth Solution: CSR8675

Product Model: BH258A

Bluetooth Range: 50feet

Bluetooth Protocol: A2DP / AVRCP

Battery Capacity: li-ion 400 mAH

Working Current: **25-35 mA**

Working Voltage: DC 3.3V-4.2V

Frequency Range: 2.402 GHz~2.480GHz

Codecs: AAC / SBC / aptx™ / aptx™low latency / aptx™ HD

Connection Method: Digital Optical TOSLINK and 3.5mm Aux

Product Diagram

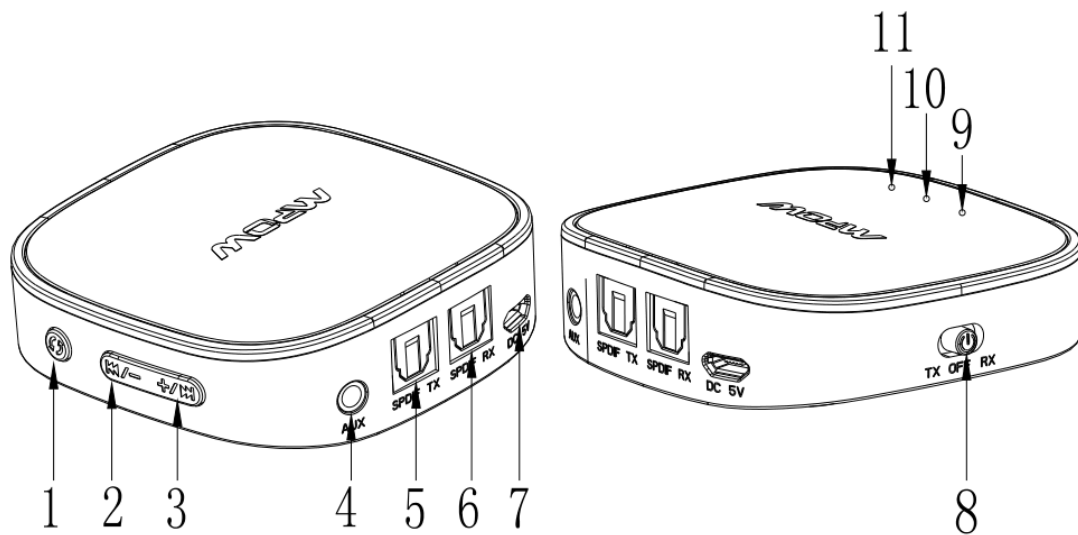

Diagram

1. Bluetooth function Button: Short press to enter pairing mode, long press for 3s to interrupt connection, long press for 3s to clear the pairing list
2. Previous Track (short press) / Volume Down (long press): only available for RX
3. Next Track (short press) / Volume Up (long press): only available for RX
4. AUX Port (AUX Stereo Input / Output Port)
5. OPTICAL TX: optical input port (TX: Input from TV)
6. OPTICAL RX: optical output port (RX: Output to Speaker)
7. Micro USB Charging Port
8. TX-OFF-RX Switch
9. ⚡ Power Indicator Light
10. BT1: NO.1 Bluetooth Pairing Indicator Light
11. BT2: NO.2 Bluetooth Pairing Indicator Light

Low Latency Function Instructions

Both Bluetooth RX mode and Bluetooth TX mode can support APTX HD/APTX LL / APTX.

Tips: If you want to use **BH258A's** APTX HD/APTX LL / APTX function:

TX Transmit Mode: Your Bluetooth headphone or Bluetooth speaker etc. should support APTX HD/APTX LL / APTX.

RX Receive Mode: Your Bluetooth-enabled smartphone etc. should support APTX HD/APTX LL / APTX.

If you want to experience APTX HD/APTX LL / APTX function with two devices connected to BH258A, both devices should support APTX HD/APTX LL / APTX.

1. TX-OFF-RX Switch

Convert via the "TX-OFF-RX" switch:

TX (Green indicator): Turn the switch to "TX". BH258A powers on and enters Bluetooth TX mode:

Power Indicator Light ⚡ stays green and BT1 flashes green quickly.

RX (Blue indicator): Turn the switch to "RX". BH258A powers on and enters Bluetooth RX mode:

Power Indicator Light ⚡ stays Blue and BT1 flashes blue quickly.

OFF: Turn the switch to OFF. BH258A powers off with all the indicator lights out.

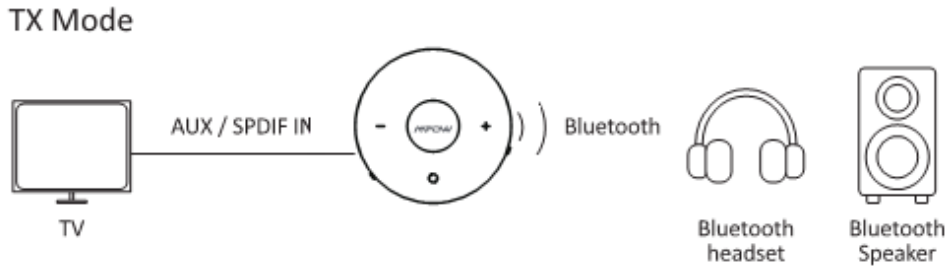

2. Transmit Mode

To enter Bluetooth Transmit mode, turn the “TX-OFF-RX” switch to the “TX” position. Connect BH258A to a non-Bluetooth multimedia device (such as TV, PC) via a 3.5 mm audio cable or optical cable. Then, the audio source from a multimedia device (such as TV, PC) can be transmitted to a Bluetooth headphone or Bluetooth speaker via BH258A’s Bluetooth transmission.

2.1 Connection to the First Bluetooth Headphone

1. For the first use, please pair BH258A to a Bluetooth headphone or Bluetooth speaker after 3.5 mm audio or optical cable connected.
2. After BH258A powers on, it enters pairing mode automatically (or to enter pairing mode by short pressing the “BT” button) with the BT1 indicator light flashing green quickly. (The BT2 indicator light will not light on.)
3. Turn on your Bluetooth headphone or Bluetooth speaker etc., ensure the distance is within 1 meter. It may take 5 - 30 seconds to complete the automatic connection.
4. When the connection is complete, the BT1 indicator lights for different codecs can be shown as follows:
 - A: The BT1 green indicator light stays on (SBC transmission).
 - B: The BT1 green indicator light keeps breathing (APTX or APTX LL or APTX HD transmission).
5. Then, you can enjoy music or TV program via your Bluetooth headphone or Bluetooth speaker.

2.2 Connection to Two Bluetooth Headphones

1. After completing the connection to the first headphone, short press the “BT” button on BH258A. BT2 indicator light flashes green quickly, and BH258A will enter pairing mode. The first connected device won’t be affected and can function normally.
2. Turn on the second Bluetooth headphone or Bluetooth speaker etc. Ensure the distance is within 1 meter. It may take 5-30 s to complete the automatic connection between BH258A and your Bluetooth headphone or Bluetooth speaker.
3. After completing the connection to the second headphone, the corresponding indicator lights for different codecs can be shown as follows:
 - A: The BT1 and BT2 green indicator lights will stay on (SBC transmission: if either headphone just supports SBC).
 - B: The BT1 and BT2 green indicator lights will keep breathing (APTX transmission: both headphones support APTX, APTX LL or APTX HD).
4. Then, BH258A is paired with two Bluetooth headphones or two Bluetooth speakers

simultaneously.

2.3 Disconnect the Current Connection

When BH258A is connected to one or two Bluetooth headphones or Bluetooth speakers, long press the “” button for 3 seconds to disconnect the current devices. Then, it enters pairing mode with the BT1 green indicator light flashing quickly.

Note: It's recommended to turn off the current headphone paired with BH258A when you need to pair a new one with it.

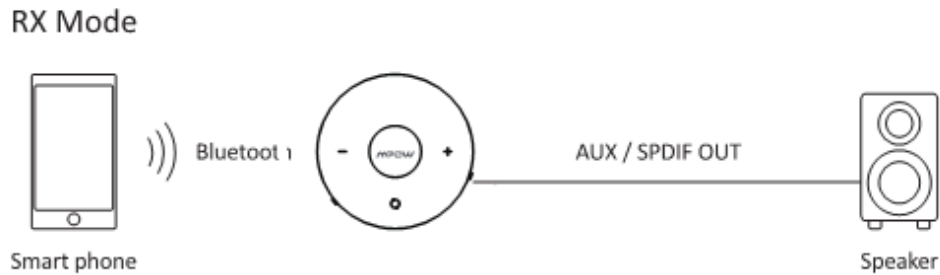

3. Receive Mode

To enter Bluetooth Receive mode, turn the “TX-OFF-RX” switch to “RX” position. Connect BH258A to a non-Bluetooth speaker, car stereo or headphone etc. via a 3.5 mm audio cable. Then, pair BH258A to a Bluetooth-enable smartphone etc. via Bluetooth. The music from your phone will be transmitted to a speaker, car stereo or headphone etc.

3.1 Connection to One Smartphone

1. For the first use, please pair BH258A to a smartphone or other smart devices after 3.5mm audio or optical cable connected.
2. BH258A will enter pairing mode directly with BT1 blue indicator light flashing quickly after it powers on (or enter pairing mode by short pressing the “” button).
3. Enable Bluetooth on your smartphone, search “BH258A” and click to connect. When the connection is complete, the corresponding indicator lights for different codecs can be shown as follows:
 - A: The BT1 blue indicator light stays on (AAC or SBC transmission).
 - B: The BT1 blue indicator light keeps breathing (APTX or APTX LL or APTX HD transmission)
4. Enter the code “0000” if needed.

3.2 Connection to Two Smartphones

1. After completing the connection to the first smartphone, short press the “” button to enter Pairing mode with BT2 blue indicator light flashing quickly (the first smartphone can still work normally).
2. Enable Bluetooth on the second smartphone, search “BH258A” and click to connect.
3. When the connection to the second smartphone is complete, the corresponding indicator lights for different codecs can be shown as follows:
 - A: The BT1 and BT2 blue indicator lights will stay on (SBC or AAC transmission: if either smartphone doesn't support APTX).
 - B: The BT1 and BT2 blue indicator lights will keep breathing (APTX, APTX LL or APTX HD transmission: both smartphones support APTX , APTX LL or APTX HD).

Note: If you want to change the music source from the first smartphone to the second one. Pause the first smartphone, then you can play music on the second smartphone after 5 seconds.

3.3 Disconnect the Current Connection

When BH258A is connected to one or two smartphone, long press the “” button for 3 seconds to disconnect the current devices. Then, it enters pairing mode with the BT1 blue indicator light flashing quickly.

Note: If you need to connect BH258A to a new one, please disable Bluetooth on the paired smartphone.

3.4 Play Music

Next Track: Short press the “” button.

Previous Track: Short press the “” button.

Volume Up: Long press the “+” button.

Volume Down: Long press the “-” button.

4. Bluetooth Automatic Reconnection

1. Bluetooth connection will be disconnected, when the distance away from BH258A exceeds the Bluetooth range or BH258A powers off.

2. RX Reconnection: When the distance away from BH258A is within the Bluetooth range in 10 min or BH258A powers on again, BH258A will enter reconnection mode: the blue indicator light flashes slowly (RX). Then, the two devices paired before the disconnection will be reconnected with BH258A.

3. TX Reconnection:

When the distance away from BH258A is within the Bluetooth range with the green indicator light flashing quickly (TX), BH258A will pair with your Bluetooth headphone.

When BH258A powers on again, it will enter reconnection mode: the green indicator light flashes slowly (RX). Then, the two devices paired before the disconnection will be reconnected with BH258A.

4. BH258A will automatically enter pairing mode when the reconnection can't be complete after BH258A powers on. Also, you can short press the “” button to enter pairing mode manually within reconnection mode.

Note: In TX mode, if the Bluetooth headphone (or Bluetooth speaker) 's pairing list has already been cleared, please clear the pairing list on BH258A simultaneously to complete the connection.

5. Clear Bluetooth Pairing List

In power-on state, to clear the pairing list paired before and enter pairing mode, long press the “+” and “-” buttons simultaneously for 3 seconds until the three indicator lights flash for 1s simultaneously (The pairing list can't be cleared in power-off state).

Note:

In Bluetooth receive mode, please clear pairing list on your smartphone simultaneously to reconnect quickly.

BH258A will clear pairing list by itself when you turn the switch between TX and RX.

6. Low Power Prompt

When the battery is in low power, BH258A's indicator light will flash red quickly. If the power is too low, it will automatically power off.

7.Charging

When BH258A is in low power or can't power on, you can charge it via a DC 5 V USB charging cable. The red indicator light stays on during the charging process and goes off when the charging is complete.

8. Automatic Power-saving Function

- 1.If BH258A hasn't been connected to any devices, it will automatically enter standby mode with 3 indicator lights off after 10 minutes to save power; Short press any button to activate pairing state.
- 2.In Bluetooth connection state, if it exceeds the effective Bluetooth range, it will disconnect and automatically enter standby mode after 10 minutes to save power. Short press any button to activate pairing state.
- 3.After BH258A completes the connection in 10 min, 3 indicator lights will go off to save power. Short press any button to activate indicator light.

Considerations

1. If BH258A cannot be paired with two devices, please reboot BH258A and try pairing again.
2. It's recommended to use headphones with same chips when pairing to two headphones to prevent from intermittent music, silent sound or disconnection etc.
3. In Bluetooth transmit mode, BH258A can be paired with a Bluetooth headphone and Bluetooth speaker. BH258A can't be paired with smartphone or other similar devices.
4. For a better music quality, it's recommended to select headphones of a same model when pairing BH258A to two headphones.
5. To complete the Bluetooth pairing, it's recommended to use BH258A in the place where there are few obstructions or other Bluetooth devices using.
6. If the pairing fails, please clear the pairing list on BH258A and smartphones etc. and try pairing again. Meanwhile, check whether BH258A is in Bluetooth pairing mode. Also, you'd better turn off other Bluetooth devices.
7. In RX mode, BH258A cannot support hands-free calling because it has no mic function.

FCC WARNING

Any Changes or modifications not expressly approved by the party responsible for compliance could void the user's authority to operate the equipment.

This device complies with part 15 of the FCC Rules. Operation is subject to the following two conditions: (1) This device may not cause harmful interference, and (2) this device must accept any interference received, including interference that may cause undesired operation.

Note: This equipment has been tested and found to comply with the limits for a Class B digital device, pursuant to part 15 of the FCC Rules. These limits are designed to provide reasonable protection against harmful interference in a residential installation. This equipment generates uses and can radiate radio frequency energy and, if not installed and used in accordance with the instructions, may cause harmful interference to radio communications. However, there is no guarantee that interference will not occur in a particular installation. If this equipment does cause harmful interference to radio or television reception, which can be determined by turning the equipment off and on, the user is encouraged to try to correct the interference by one or

more of the following measures:

- Reorient or relocate the receiving antenna.
- Increase the separation between the equipment and receiver.
- Connect the equipment into an outlet on a circuit different from that to which the receiver is connected.
- Consult the dealer or an experienced radio/TV technician for help.

FCC Radiation Exposure Statement:

This equipment complies with FCC radiation exposure limits set forth for an uncontrolled environment. This transmitter must not be co-located or operating in conjunction with any other antenna or transmitter.