

# Power Point Inc Limited

## TEST REPORT

**SCOPE OF WORK**

EMC TESTING-RCM-M1509S-A

**REPORT NUMBER**

170209058GZU-001

**ISSUE DATE**

16-April-2019

**[REVISED DATE]**

[-----]

**PAGES**

32

**DOCUMENT CONTROL NUMBER**

FCC Part 15.249-c

© 2017 INTERTEK



## TEST REPORT

Telephone: 86-20-8213 9688

Facsimile: 86-20-3205 7538

[www.intertek.com](http://www.intertek.com)

Applicant Name & Address : Power Point Inc Limited  
Xiangzhou Qianshan Lixi Cun Di Yi Gongye Qu 348 Dong 5 Ceng 1,  
Zhuhai, 519000, China

Manufacturing Site : Same as applicant

Intertek Report No: 170209058GZU-001

FCC ID: 2AMGX-M1509SA

## Test standards

**47 CFR PART 15 Subpart C: 2017 section 15.249**

## Sample Description

Product : Coffee Maker

Model No. : RCM-M1509S-A

Electrical Rating : AC 120V/60Hz, 1000W

**Serial No.** : Not Labeled

Date Received : 09 February 2017

Date Test : 10 February 2017-15 March 2019

Conducted

Prepared and Checked By

Approved By:

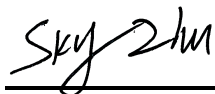

Sky Zhu

Project Engineer

Intertek Guangzhou



Helen Ma

Team Leader

Intertek Guangzhou

---

This report is for the exclusive use of Intertek's Client and is provided pursuant to the agreement between Intertek and its Client. Intertek's responsibility and liability are limited to the terms and conditions of the agreement. Intertek assumes no liability to any party, other than to the Client in accordance with the agreement, for any loss, expense or damage occasioned by the use of this report. Only the Client is authorized to permit copying or distribution of this report and then only in its entirety. Any use of the Intertek name or one of its marks for the sale or advertisement of the tested material, product or service must first be approved in writing by Intertek. The observations and test results in this report are relevant only to the sample tested. This report by itself does not imply that the material, product, or service is or has ever been under an Intertek certification program.

**TEST REPORT**

**CONTENT**

**TESTREPORT..... 1**

**CONTENT..... 3**

**1.0 TEST RESULT SUMMARY..... 4**

**2.0 GENERAL DESCRIPTION ..... 5**

    2.1 PRODUCT DESCRIPTION.....5

    2.2 RELATED SUBMITTAL(S) GRANTS .....6

    2.3 TEST METHODOLOGY .....6

    2.4 TEST FACILITY .....6

**3.0 SYSTEM TEST CONFIGURATION ..... 6**

    3.1 JUSTIFICATION .....6

    3.2 EUT EXERCISING SOFTWARE.....7

    3.3 SPECIAL ACCESSORIES .....7

    3.4 MEASUREMENT UNCERTAINTY .....8

    3.5 EQUIPMENT MODIFICATION .....8

    3.6 SUPPORT EQUIPMENT LIST AND DESCRIPTION.....9

**4.0 MEASUREMENT RESULTS ..... 10**

    4.1 ANTENNA REQUIREMENT ..... 10

    4.2 OCCUPIED BANDWIDTH ..... 11

    4.3 RADIATED EMISSION..... 14

    4.4 BAND EDGES REQUIREMENT ..... 26

    4.5 CONDUCTED EMISSIONS AT MAINS TERMINALS ..... 29

**5.0 TEST EQUIPMENT LIST..... 32**

## TEST REPORT

### 1.0 TEST RESULT SUMMARY

Test Item	Test Requirement	Test Method	Result
Antenna Requirement	FCC PART 15 C Section 15.203	FCC PART 15 C Section 15.203	PASS
Occupied Bandwidth	FCC PART 15 C section 15.215(c)	ANSI C63.10: Clause 6.9	PASS
Radiated Emission	FCC PART 15 C section 15.249 (a), (d)	ANSI C63.10: Clause 6.4, 6.5 & 6.6	PASS
Band Edges Measurement	FCC PART 15 C section 15.249 (d)	ANSI C63.10: Clause 6.10	PASS
Conducted Emissions at Mains Terminals	FCC PART 15 C section 15.207	ANSI C63.10: Clause 6.2	PASS

**Remark:**

N/A: not applicable. Refer to the relative section for the details.

EUT: In this whole report EUT means Equipment Under Test.

Tx: In this whole report Tx (or tx) means Transmitter.

Rx: In this whole report Rx (or rx) means Receiver.

RF: In this whole report RF means Radio Frequency.

ANSI C63.10: the detail version is ANSI C63.10:2013 in the whole report.

## TEST REPORT

### 2.0 General Description

#### 2.1 Product Description

Operating Frequency: 2402 MHz – 2480MHz  
 Type of Modulation: GFSK  
 Number of Channels: 40 Channels  
 Channel Separation: 2 MHz  
 Antenna Type: Integral  
 Antenna Gain: 2 dBi  
 Speciality: Bluetooth 4.1 with BLE (Bluetooth Low Energy)  
 Function: Utilized APP controls the Multicooker  
 Power Supply: AC 120V,60Hz  
 Power cord: 1.2 m x 3 wires unshielded AC supply cable

EUT modulation and data packet during test:

The EUT has been tested on the Modulation of GFSK with 1 Mbps data rate.

EUT channels and frequencies list:

Test frequencies are lowest channel 0: 2402 MHz, middle channel 19: 2440 MHz and highest channel 39: 2480 MHz.

Channel	Frequency (MHz)	Channel	Frequency (MHz)	Channel	Frequency (MHz)
0	2402	14	2430	28	2458
1	2404	15	2432	29	2460
2	2406	16	2434	30	2462
3	2408	17	2436	31	2464
4	2410	18	2438	32	2466
5	2412	19	2440	33	2468
6	2414	20	2442	34	2470
7	2416	21	2444	35	2472
8	2418	22	2446	36	2474
9	2420	23	2448	37	2476
10	2422	24	2450	38	2478
11	2424	25	2452	39	2480
12	2426	26	2454	/	/
13	2428	27	2456	/	/

## TEST REPORT

### 2.2 Related Submittal(s) Grants

This is an application for certification of:  
DXX - Part 15 Low Power Communication Device Transmitter.

Remaining portions are subject to the following procedures:

1. Receiver portion of BLE: exempt from technical requirement of this Part.

### 2.3 Test Methodology

Both AC mains line-conducted and radiated emission measurements were performed according to the procedures in ANSI C63.10. Radiated emission measurement was performed in semi-anechoic chamber and conducted emission measurement was performed in shield room. For radiated emission measurement, preliminary scans and final tests were performed in the semi-anechoic chamber to determine the worst case modes. All radiated tests were performed at an antenna to EUT distance of 3 meters, unless stated otherwise.

### 2.4 Test Facility

All tests were performed at:

Room102/104, No 203, KeZhu Road, Science City, GETDD Guangzhou, China

Except Conducted Emissions was performed at:

Block E, No.7-2 Guang Dong Software Science Park, Caipin Road, Guangzhou Science City, GETDD Guangzhou, China

A2LA Certificate Number 0078.10

Intertek Testing Services Shenzhen Ltd. Guangzhou Branch is accredited by A2LA and Listed in FCC website. FCC accredited test labs may perform both Certification testing under Parts 15 and 18 and Declaration of Conformity testing.

## 3.0 System Test Configuration

### 3.1 Justification

For emissions testing, the equipment under test (EUT) setup to transmit continuously to simplify the measurement methodology. Care was taken to ensure proper power supply voltages during testing. During testing, AC power line was manipulated to produce worst case emissions. It was powered by AC 120V/60Hz supply.

## TEST REPORT

The signal is maximized through rotation. The antenna height and polarization are varied during the search for maximum signal level. The antenna height is varied from 1 to 4 meters. Radiated emissions are taken at three meters unless the signal level is too low for measurement at that distance. If necessary, a pre-amplifier is used and/or the test is conducted at a closer distance.

All readings are extrapolated back to the equivalent three-meter reading using inverse scaling with distance. The spurious emissions more than 20 dB below the permissible value are not reported.

For an intentional radiator, the spectrum shall be investigated from the lowest radio frequency signal generated in the device, without going below 9 kHz, up to at least the frequency shown in the following table:

Frequency range of radiated emission measurements

Lowest frequency generated in the device	Upper frequency range of measurement
9 kHz to below 10 GHz	10th harmonic of highest fundamental frequency or to 40 GHz, whichever is lower
At or above 10 GHz to below 30 GHz	5th harmonic of highest fundamental frequency or to 100 GHz, whichever is lower
At or above 30 GHz	5th harmonic of highest fundamental frequency or to 200 GHz, whichever is lower, unless otherwise specified

Number of fundamental frequencies to be tested in EUT transmit band

Frequency range in which device operates	Number of frequencies	Location in frequency range of operation
1 MHz or less	1	Middle
1 MHz to 10 MHz	2	1 near top and 1 near bottom
More than 10 MHz	3	1 near top, 1 near middle and 1 near bottom

### 3.2 EUT Exercising Software

None

### 3.3 Special Accessories

No special accessories used.

## TEST REPORT

### 3.4 Measurement Uncertainty

No.	Item	Measurement Uncertainty
1	20 dB Bandwidth	2.3%
	6dB Bandwidth	
	99% Bandwidth	
2	Carrier Frequencies Separated	2.3%
3	Dwell Time	1.2%
4	Maximum Peak Conducted Output Power	1.5dB
5	Peak Power Spectral Density	1.5dB
6	Out of Band Conducted Emissions	1.5dB
7	Band edges measurement	1.5dB
8	Radiated Emissions	4.7 dB (25 MHz-1 GHz)
		4.8 dB (1 GHz-18 GHz)
		5.21dB (18GZH-26GHz)
9	Conducted Emissions at Mains Terminals	2.58dB
10	Temperature	0.5 °C
11	Humidity	0.4 %
12	Time	1.2%

The measurement uncertainty describes the overall uncertainty of the given measured value during the operation of the EUT.

Measurement uncertainty is calculated in accordance with ETSI TR 100 028-2001.

The measurement uncertainty is given with a confidence of 95%, k=2.

When determining of the test conclusion, the Measurement Uncertainty of test has been considered.

Uncertainty and Compliance – Unless the standard specifically states that measured values are to be extended by the measurement uncertainty in determining compliance, all compliance determinations are based on the actual measured value

### 3.5 Equipment Modification

Any modifications installed previous to testing by Power Point Inc Limited will be incorporated in each production model sold / leased in the United States.

No modifications were installed by Intertek Testing Services Shenzhen Ltd. Guangzhou Branch.



## TEST REPORT

### 3.6 Support Equipment List and Description

The applicant made a special engineer sample can adjust the lowest, middle, the highest frequency using the key on the sample.

## TEST REPORT

### 4.0 Measurement Results

#### 4.1 Antenna Requirement

Standard requirement:

15.203 requirement:

For intentional device. According to 15.203 an intentional radiator shall be designed to Ensure that no antenna other than that furnished by the responsible party shall be used with the device.

EUT Antenna

The antenna is an integral antenna and no consideration of replacement. The best case gain of the antenna is 2 dBi.

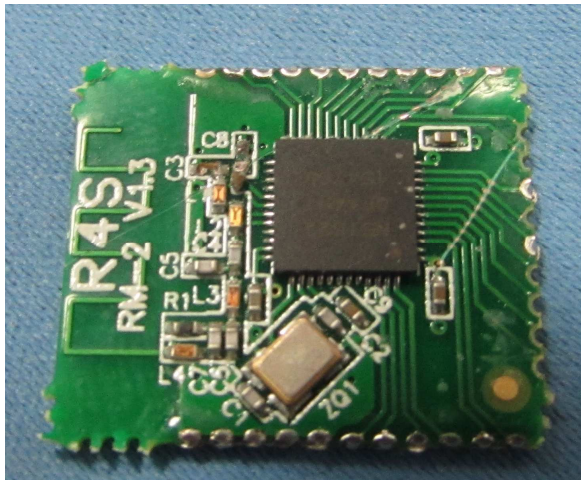

## TEST REPORT

### 4.2 Occupied Bandwidth

Test Requirement: FCC PART 15 C section 15.215(c)  
(c) Intentional radiators operating under the alternative provisions to the general emission limits, as contained in §§ 15.217 through 15.257 and in subpart E of this part, must be designed to ensure that the 20 dB bandwidth of the emission, or whatever bandwidth may otherwise be specified in the specific rule section under which the equipment operates, is contained within the frequency band designated in the rule section under which the equipment is operated

Test Method: ANSI C63.10: Clause 6.9

Test Status: Pre-Scan has been conducted to determine the worst-case mode from all possible combinations between available modulations, data rates and antenna ports (if EUT with antenna diversity architecture). The highest, middle and the lowest channels were selected for the final test as listed below.

Test Configuration:

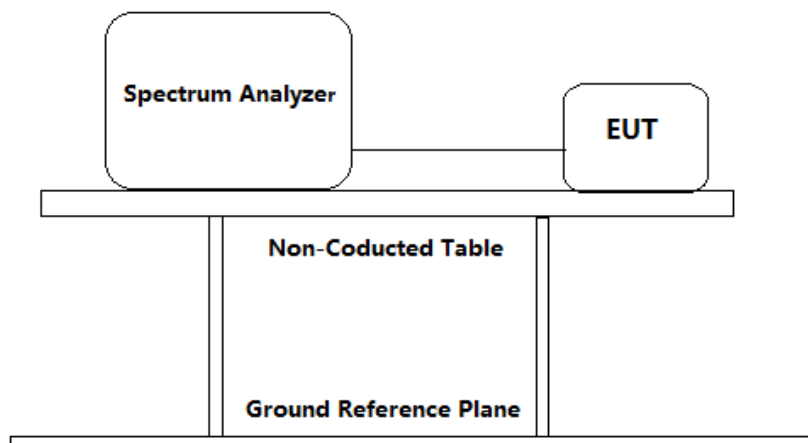

Test Procedure:

The transmitter was operated at its maximum carrier power measured under normal test conditions.

- The instrument center frequency was set to the nominal EUT channel center frequency. The frequency span for the spectrum analyzer was between 1.5 times and 5.0 times the OBW(20 dB Bandwidth).
- The nominal IF filter bandwidth (3 dB RBW) was in the range of 1% to 5% of the OBW, and VBW was approximately three times the RBW.
- Set the reference level of the instrument as required, keeping the signal from exceeding the maximum input mixer level for linear operation. In general, the peak of the spectral envelope was more than  $[10 \log (OBW/RBW)]$  below the reference level.

## TEST REPORT

- d) Step a) through step c) might require iteration to adjust within the specified range.
- e) The dynamic range of the instrument at the selected RBW was more than 10 dB below the target “-20 dB down” requirement; that is, if the requirement calls for measuring the -20 dB OBW, the instrument noise floor at the selected RBW was at least 30 dB below the reference value.
- f) Peak detection and max hold mode (until the trace stabilizes) was used.
- g) Used the 20dB bandwidth function of the instrument and reported the measured bandwidth.
- h) The occupied bandwidth was reported by providing plot(s) of the measuring instrument display; the plot axes and the scale units per division was clearly labeled. Tabular data was reported in addition to the plot(s).

### Used Test Equipment List

Spectrum Analyzer. Refer to Clause 5 Test Equipment List for details.

20 dB bandwidth:

Channel No.	Frequency (MHz)	Measured 20dB bandwidth (MHz)	Limit (MHz)	Result
0	2402	1.115	2400 to 2483.5	Pass
19	2440	1.107		Pass
39	2480	1.179		Pass

### Result plot as follows:

Lowest Channel(2.402 GHz):

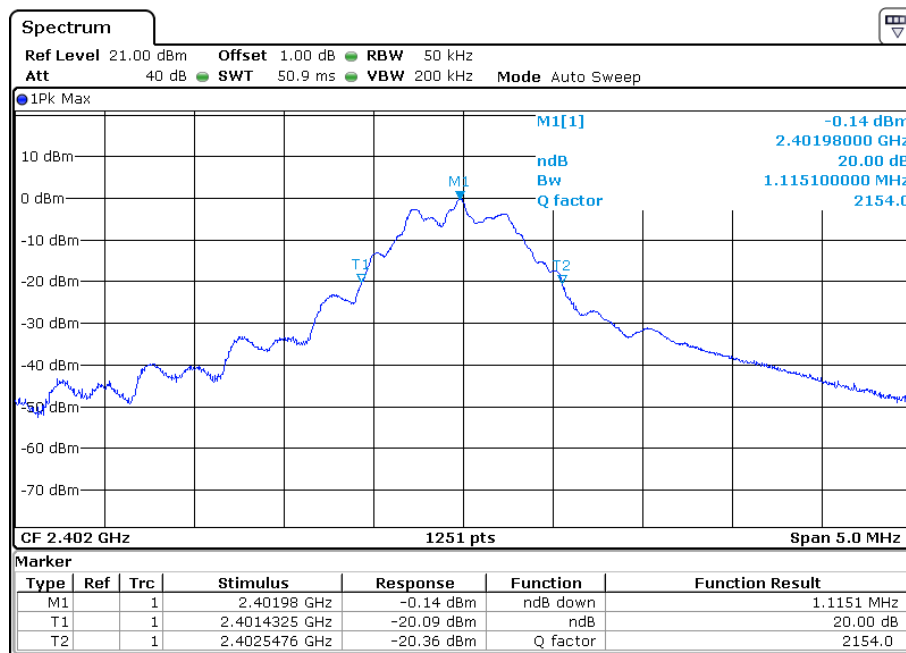

**TEST REPORT**

Middle Channel(2.440 GHz):

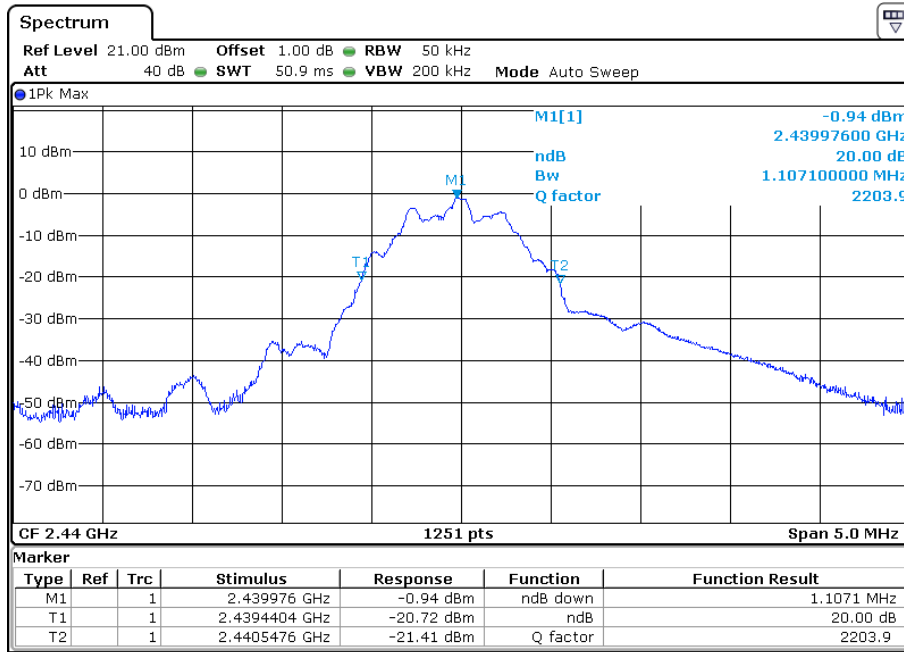

Highest Channel(2.480 GHz):

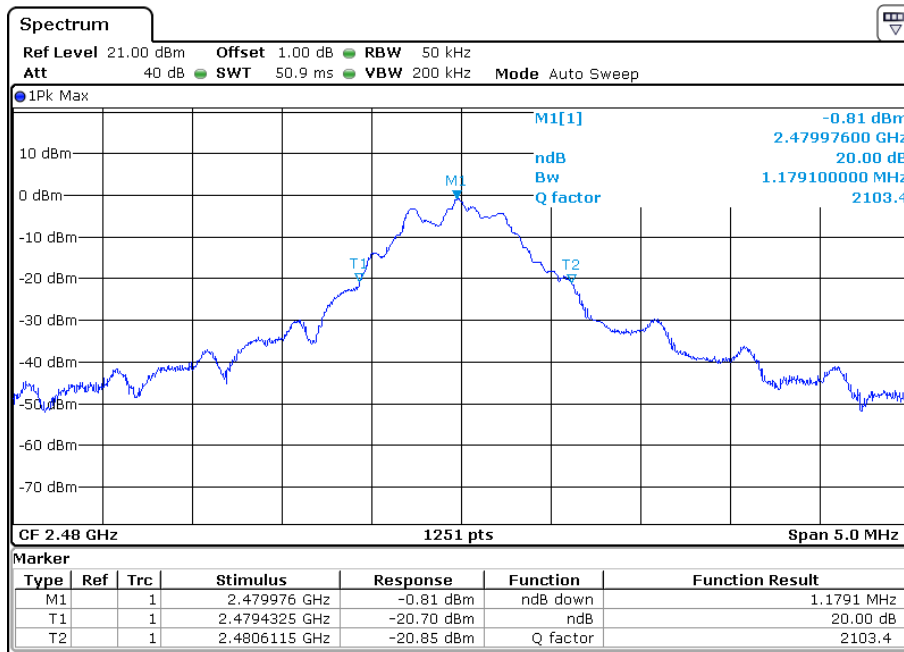

**TEST REPORT**

**4.3 Radiated Emission**

Test Requirement:

FCC PART 15 C section 15.249 (a), (d)

(a) Except as provided in paragraph (b) of this section, the field strength of emissions from intentional radiators operated within these frequency bands shall comply with the following:

Fundamental Frequency (MHz)	Field Strength of Fundamental (dBμV/m @ 3m)	Field Strength of Harmonics (dBμV/m @ 3m)
902 to 928	94.0	54.0
2400 to 2483.5	94.0	54.0
5725 to 5875	94.0	54.0

Note: The limits shown in the above table are based on measurements using an average detector, except for the fundamental emission in the frequency band 902-928 MHz, which is based on measurements using a CISPR quasi-peak detector.

(d) Emissions radiated outside of the specified frequency bands, except for harmonics, shall be attenuated by at least 50 dB below the level of the fundamental or to the general radiated emission limits in § 15.209, whichever is the lesser attenuation.

Test Method:

ANSI C63.10: Clause 6.4, 6.5 and 6.6

Test Status:

Pre-Scan has been conducted to determine the worst-case mode from all possible combinations between available modulations, data rates and antenna ports (if EUT with antenna diversity architecture). The lowest, middle and the highest channels were selected for the final test as listed below.

Test site:

Measurement Distance: 3m (Semi-Anechoic Chamber)

Limit:

The field strength of radiated emission outside of the specified frequency bands, except for harmonics at a distance of 3 meters shall not exceed the following values:

Frequency (MHz)	Field Strength (dBμV/m @ 3m)
30-88	40.0
88-216	43.5
216-960	46.0
Above 960	54.0

Detector:

For Peak and Quasi-Peak value:

200 Hz for 9 kHz to 150 kHz

9 kHz for 150 kHz to 30 MHz

120 kHz for 30 MHz to 1GHz

RBW = 2 MHz for  $f \geq 1$  GHz

## TEST REPORT

VBW  $\geq$  RBW  
Sweep = auto  
Detector function = peak for  $f \geq 1$  GHz, QP for  $f < 1$  GHz  
Trace = max hold

For AV value:  
RBW = 2 MHz for  $f \geq 1$  GHz  
VBW=10 Hz  
Detector function: peak  
Sweep = auto  
Trace = max hold.

Field Strength  
Calculation:

The field strength is calculated by adding the reading on the Spectrum Analyzer to the factors associated with preamplifiers (if any), antennas, cables, pulse desensitization and average factors (when specified limit is in average and measurements are made with peak detectors). A sample calculation is included below:

$$FS = RA + AF + CF - AG + PD + AV$$

$$FS = RA + \text{Correct Factor} + AV$$

FS = Field Strength in dB $\mu$ V/m

RA = Receiver Amplitude (including preamplifier) in dB $\mu$ V

AF = Antenna Factor in dB

CF = Cable Attenuation Factor in dB

AG = Amplifier Gain in dB

PD = Pulse Desensitization in dB

AV = Average Factor in -dB

Correct Factor = AF + CF - AG + PD

Where:

In the radiated emission table which follows, the reading shown on the data table may reflect the preamplifier gain. An example of the calculations, where the reading does not reflect the preamplifier gain, follows:

$$FS = RA + AF + CF - AG + PD + AV$$

Assume a receiver reading of 62.0 dB $\mu$ V is obtained. The antenna factor of 7.4 dB and cable factor of 1.6 dB is added. The amplifier gain of 29 dB is subtracted. The pulse desensitization factor of the spectrum analyzer was 0 dB, and the resultant average factor was -10 dB. The net field strength for comparison to the appropriate emission limit is 32 dB $\mu$ V/m.

$$RA = 62.0 \text{ dB}\mu\text{V}$$

$$AF = 7.4 \text{ dB}$$

$$CF = 1.6 \text{ dB}$$

$$AG = 29.0 \text{ dB}$$

$$PD = 0 \text{ dB}$$

$$AV = -10 \text{ dB}$$

$$\text{Correct Factor} = 7.4 + 1.6 - 29.0 + 0 = -20 \text{ dB}$$

$$FS = 62 + (-20) + (-10) = 32 \text{ dB}\mu\text{V/m}$$

**TEST REPORT**

Section 15.205 Restricted bands of operation.

MHz	MHz	MHz	GHz
0.090 - 0.110	16.42 - 16.423	399.9 - 410	4.5 - 5.15
10.495 - 0.505	16.69475 - 16.69525	608 - 614	5.35 - 5.46
2.1735 - 2.1905	16.80425 - 16.80475	960 - 1240	7.25 - 7.75
4.125 - 4.128	25.5 - 25.67	1300 - 1427	8.025 - 8.5
4.17725 - 4.17775	37.5 - 38.25	1435 - 1626.5	9.0 - 9.2
4.20725 - 4.20775	73 - 74.6	1645.5 - 1646.5	9.3 - 9.5
6.215 - 6.218	74.8 - 75.2	1660 - 1710	10.6 - 12.7
6.26775 - 6.26825	108 - 121.94	1718.8 - 1722.2	13.25 - 13.4
6.31175 - 6.31225	123 - 138	2200 - 2300	14.47 - 14.5
8.291 - 8.294	149.9 - 150.05	2310 - 2390	15.35 - 16.2
8.362 - 8.366	156.52475 -	2483.5 - 2500	17.7 - 21.4
8.37625 - 8.38675	156.52525	2655 - 2900	22.01 - 23.12
8.41425 - 8.41475	156.7 - 156.9	3260 - 3267	23.6 - 24.0
12.29 - 12.293	162.0125 - 167.17	3332 - 3339	31.2 - 31.8
12.51975 - 12.52025	167.72 - 173.2	3345.8 - 3358	36.43 - 36.5
12.57675 - 12.57725	240 - 285	3600 - 4400	
13.36 - 13.41	322 - 335.4		

Test Configuration:

- 1) 9 kHz to 30 MHz emissions:

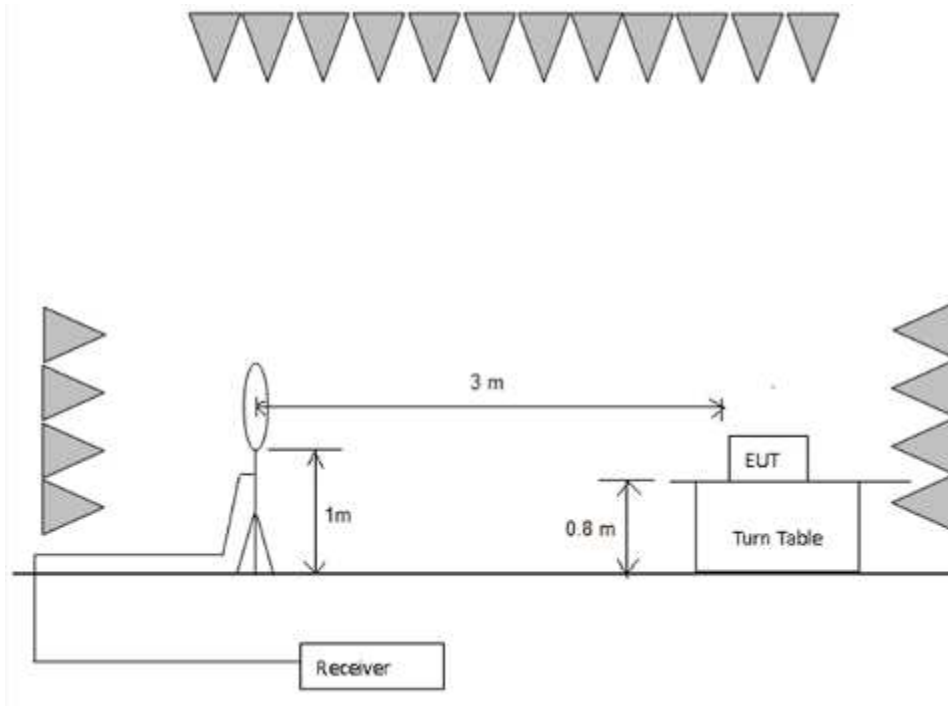



**TEST REPORT**

2) 30 MHz to 1 GHz emissions:

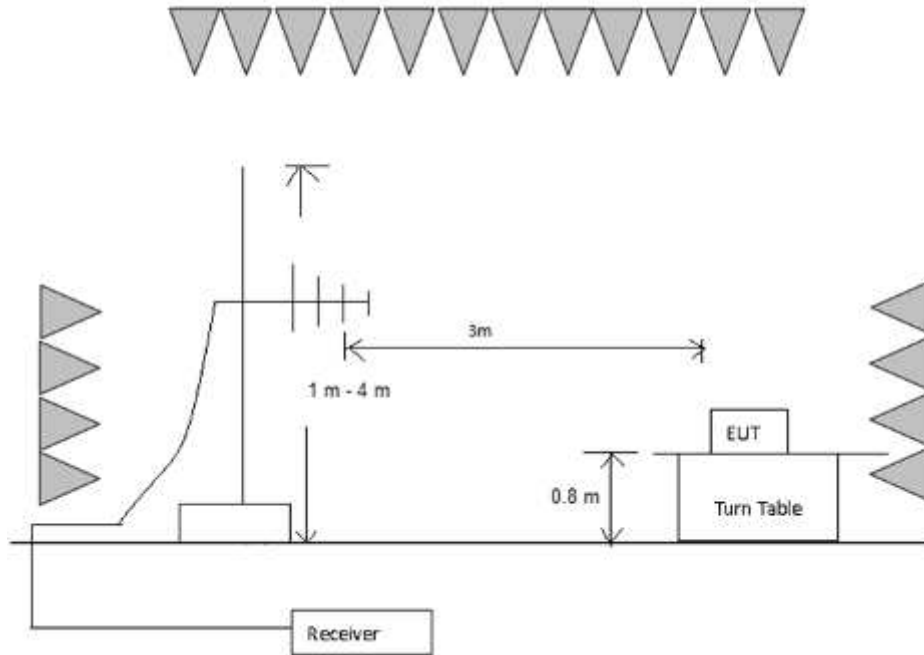

3) 1 GHz to 40 GHz emissions:

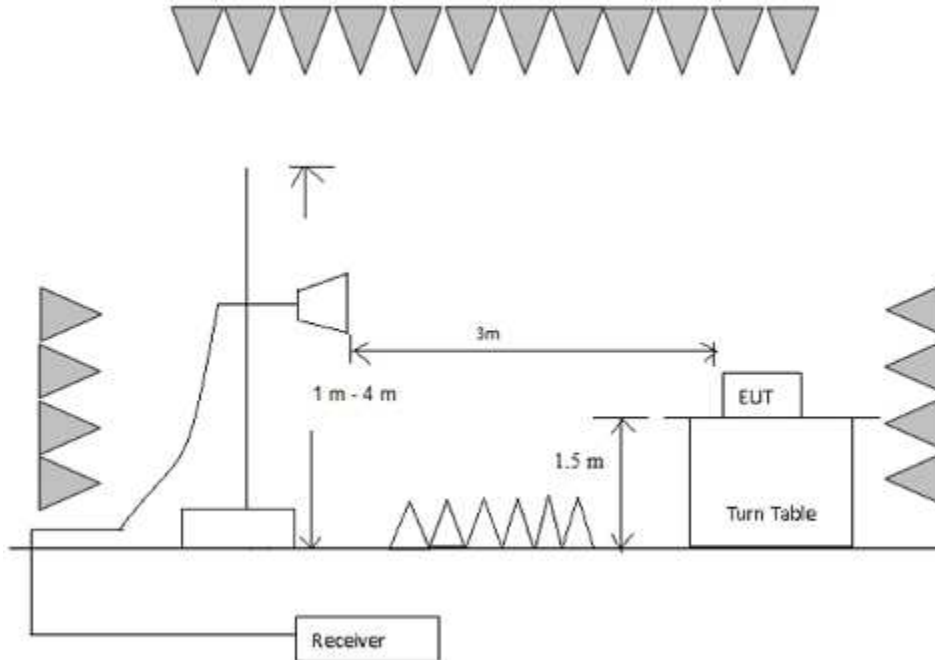

## TEST REPORT

### Test Procedure:

#### 1) 9 kHz to 30 MHz emissions:

For testing performed with the loop antenna. The centre of the loop was positioned 1 m above the ground and positioned with its plane vertical at the special distance from the EUT. During testing the loop was rotated about its vertical axis for maximum response at each azimuth and also investigated with the loop positioned in the horizontal plane.

#### 2) 30 MHz to 1 GHz emissions:

For testing performed with the bi-log type antenna. The measurement is performed with the EUT rotated 360°, the antenna height scanned between 1m and 4m, and the antenna rotated to repeat the measurement for both the horizontal and vertical antenna polarizations.

#### 3) 1 GHz to 25 GHz emissions:

Test site with RF absorbing material covering the ground plane that met the site validation criterion called out in CISPR 16-1-4:2007 was used to perform radiated emission test above 1 GHz.

For testing performed with the horn antenna. The measurement is performed with the EUT rotated 360°, the antenna height scanned between 1m and 4m, and the antenna rotated to repeat the measurement for both the horizontal and vertical antenna polarizations.

#### 4) The receiver was scanned from 9 kHz to 25 GHz. When an emission was found, the table was rotated to produce the maximum signal strength. An initial pre-scan was performed for in peak detection mode using the receiver. The EUT was measured for both the Horizontal and Vertical polarities and performed a pre-test three orthogonal planes. For intentional radiators, measurements of the variation of the input power or the radiated signal level of the fundamental frequency component of the emission, as appropriate, shall be performed with the supply voltage varied between 85% and 115% of the nominal rated supply voltage. The worst case emissions were reported.

### Used Test Equipment List:

3m Semi-Anechoic Chamber, EMI Test Receiver (9 kHz~7 GHz), Signal and Spectrum Analyzer (10 Hz~40 GHz), Loop antenna (9 kHz-30 MHz). TRILOG Super Broadband test Antenna(30 MHz-3 GHz) (RX), Double-Ridged Waveguide Horn Antenna (800 MHz-18 GHz)(RX) and High Frequency Antenna & preamplifier(18 GHz~26.5 GHz) (RX). Refer to Clause 5 Test Equipment List for details.

### 9 kHz~30 MHz Field Strength of Unwanted Emissions. Quasi-Peak Measurement

The measurements with active loop antenna were greater than 20dB below the limit, so the test data were not recorded in the test report.

**TEST REPORT**

**Radiated Emissions (Below 1GHz)**

Operation Frequency: 2402MHz

Horizontal

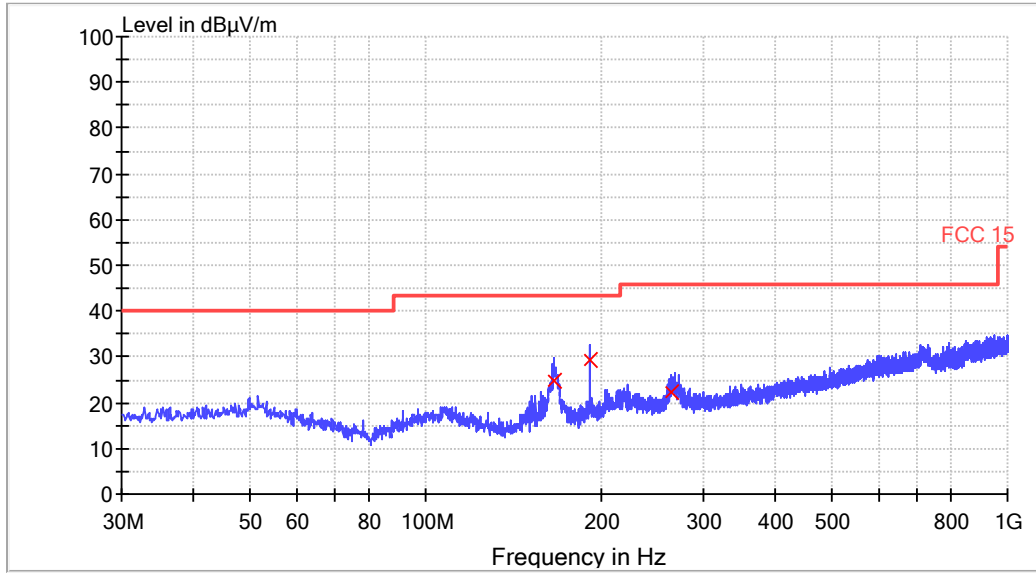

**QP**

Frequency (MHz)	Quasi Peak (dBµV/m)	Bandwidth (kHz)	Pol	Corr. (dB)	Margin - QPK (dB)	Limit - QPK (dBµV/m)
166.520000	24.6	120.000	H	9.6	18.9	43.5
192.000000	29.2	120.000	H	11.5	14.3	43.5
265.000000	22.5	120.000	H	14.0	23.6	46.0

**TEST REPORT**

Vertical

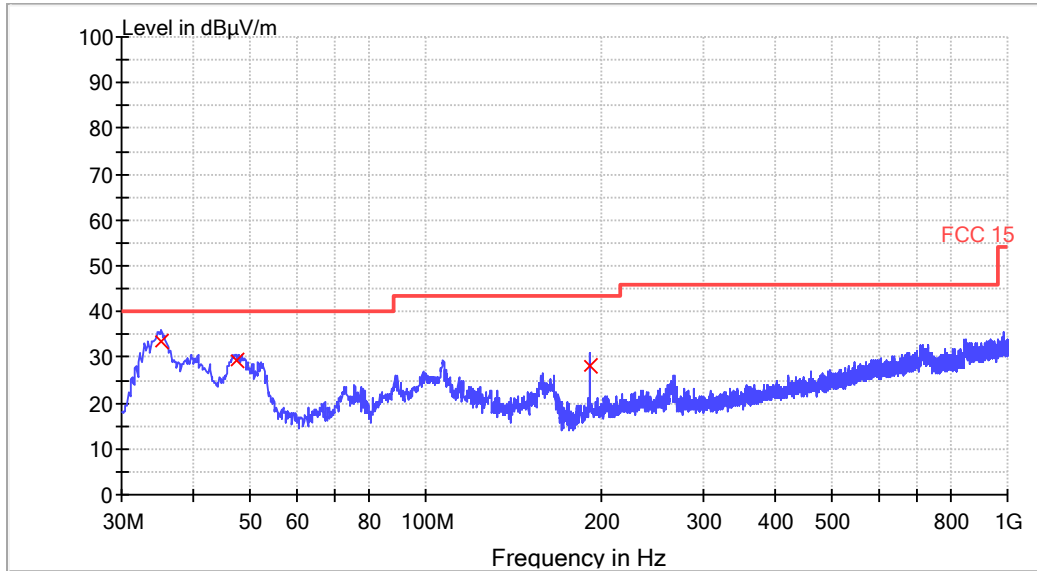

**QP**

Frequency (MHz)	Quasi Peak (dBµV/m)	Bandwidth (kHz)	Pol	Corr. (dB)	Margin - QPK (dB)	Limit - QPK (dBµV/m)
35.200000	33.7	120.000	V	11.9	6.4	40.0
47.200000	29.3	120.000	V	14.3	10.8	40.0
192.000000	28.1	120.000	V	11.5	15.4	43.5

1. Corr. (dB) = Antenna Factor (dB) + Cable Loss (dB)
2. Quasi Peak (dBµV/m) = Corr. (dB) + Read Level (dBµV)
3. Margin (dB) = Limit QPK (dBµV/m) – Quasi Peak (dBµV/m)

**TEST REPORT**

Operation Frequency: 2440MHz  
Horizontal

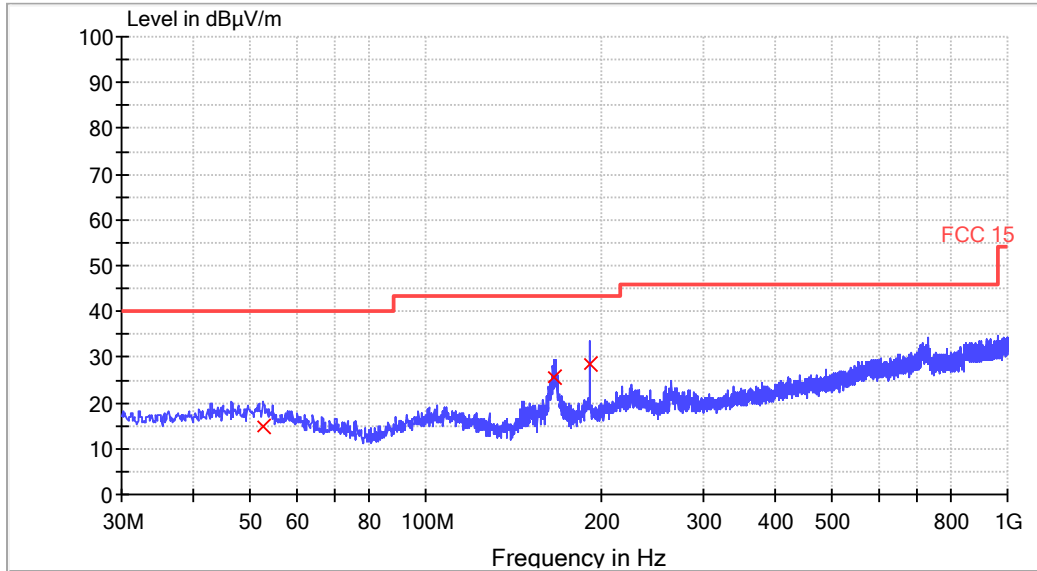

**QP**

Frequency (MHz)	Quasi Peak (dBµV/m)	Bandwidth (kHz)	Pol	Corr. (dB)	Margin - QPK (dB)	Limit - QPK (dBµV/m)
54.200000	16.7	120.000	V	11.9	23.3	40.0
177.600000	26.8	120.000	V	14.3	16.7	43.5
192.000000	28.1	120.000	V	11.5	15.4	43.5

**TEST REPORT**

Vertical

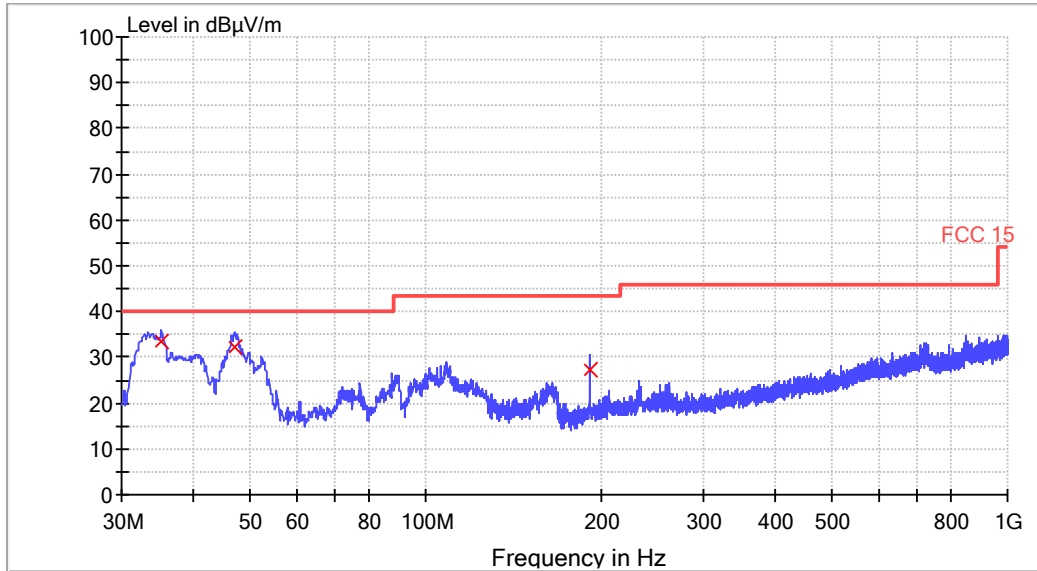

**QP**

Frequency (MHz)	Quasi Peak (dBµV/m)	Bandwidth (kHz)	Pol	Corr. (dB)	Margin - QPK (dB)	Limit - QPK (dBµV/m)
35.200000	34.5	120.000	V	11.9	5.5	40.0
47.200000	23.8	120.000	V	14.3	16.2	40.0
192.000000	27.9	120.000	V	11.5	15.6	43.5

1. Corr. (dB) = Antenna Factor (dB) + Cable Loss (dB)
2. Quasi Peak (dBµV/m) = Corr. (dB) + Read Level (dBµV)
3. Margin (dB) = Limit QPK (dBµV/m) – Quasi Peak (dBµV/m)

## TEST REPORT

Operation Frequency: 2480MHz

Horizontal

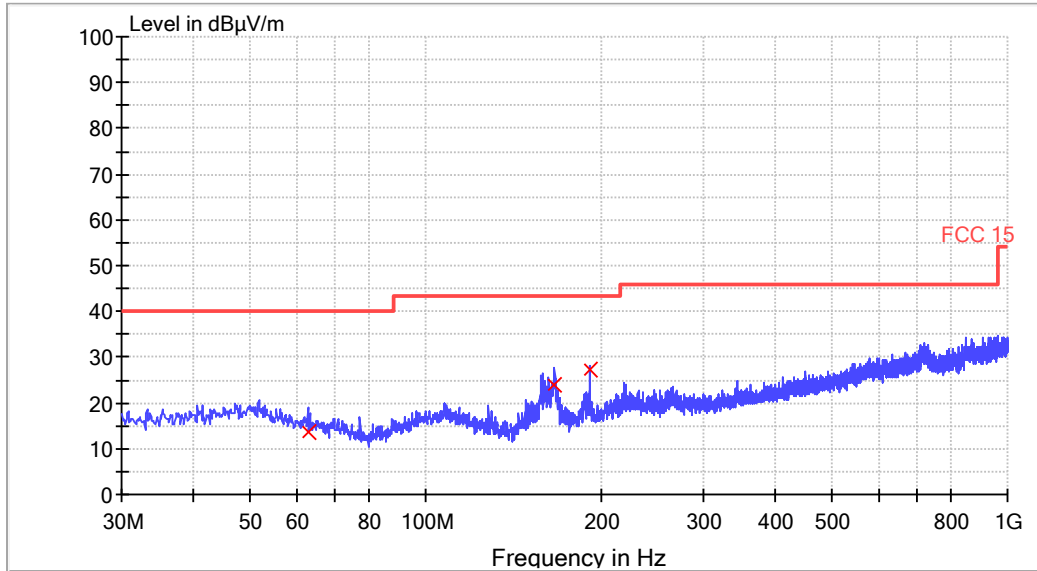

## QP

Frequency (MHz)	Quasi Peak (dBµV/m)	Bandwidth (kHz)	Pol	Corr. (dB)	Margin - QPK (dB)	Limit - QPK (dBµV/m)
62.200000	14.7	120.000	V	11.9	25.3	40.0
177.600000	25.6	120.000	V	14.3	17.9	43.5
192.000000	27.1	120.000	V	11.5	16.4	43.5

**TEST REPORT**

Vertical

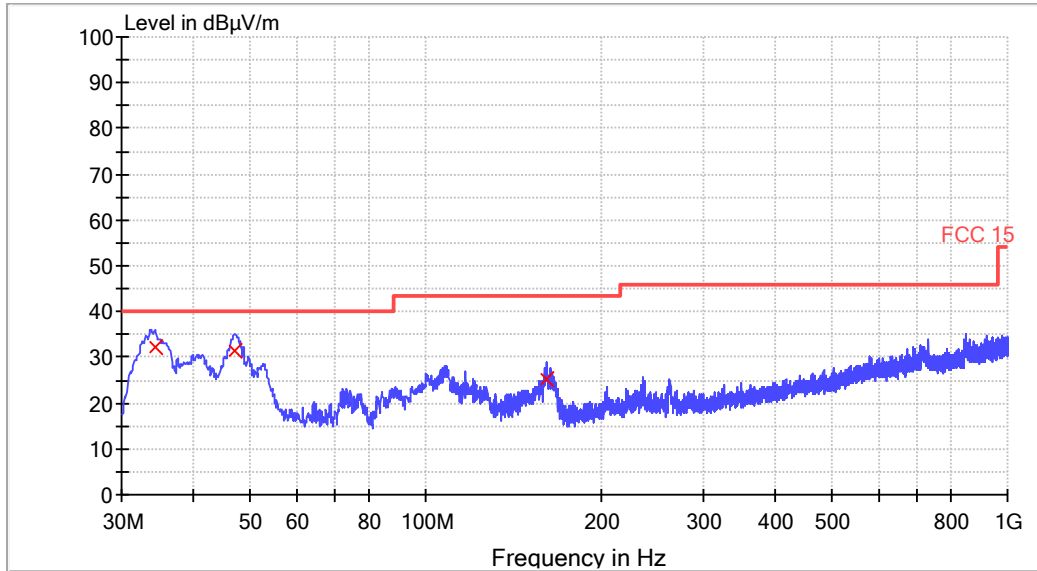

**QP**

Frequency (MHz)	Quasi Peak (dBµV/m)	Bandwidth (kHz)	Pol	Corr. (dB)	Margin - QPK (dB)	Limit - QPK (dBµV/m)
35.200000	33.6	120.000	V	11.9	6.4	40.0
47.200000	31.3	120.000	V	14.3	8.7	40.0
187.400000	24.3	120.000	V	11.5	19.2	43.5

1. Corr. (dB) = Antenna Factor (dB) + Cable Loss (dB)
2. Quasi Peak (dBµV/m) = Corr. (dB) + Read Level (dBµV)
3. Margin (dB) = Limit QPK (dBµV/m) – Quasi Peak (dBµV/m)



**TEST REPORT**

**Radiated Emissions (Above 1GHz)**

**Operation Frequency: 2402MHz:**

Polarization	Frequency (MHz)	PK Net at 3m (dBµV/m)	AV Net at 3m (dBµV/m)	Correction Factor (dB)	PK Limit at 3m (dBµV/m)	PK Margin (dB)	AV Limit at 3m (dBµV/m)	AV Margin (dB)
Horizontal	2401.968	88.7	--	-7.3	114.0	-25.3	94.0	--
Horizontal	1122.186	35.3	--	-13.9	74.0	-38.7	54.0	--
Horizontal	4803.750	53.9	--	-0.5	74.0	-20.1	54.0	--
Horizontal	9608.375	52.7	--	6.3	74.0	-21.3	54.0	--
Vertical	2401.612	91.4	--	-7.3	114.0	-22.6	94.0	--
Vertical	1121.125	33.0	--	-13.9	74.0	-41.0	54.0	--
Vertical	4803.600	55.2	51.6	-0.5	74.0	-18.8	54.0	-2.4
Vertical	9607.800	52.5	--	5.5	74.0	-21.5	54.0	--

**Operation Frequency: 2440MHz:**

Polarization	Frequency (MHz)	PK Net at 3m (dBµV/m)	AV Net at 3m (dBµV/m)	Correction Factor (dB)	PK Limit at 3m (dBµV/m)	PK Margin (dB)	AV Limit at 3m (dBµV/m)	AV Margin (dB)
Horizontal	2440.200	89.4	--	-7.2	114.0	-24.6	94.0	--
Horizontal	4880.258	50.1	--	-0.5	74.0	-23.9	54.0	--
Horizontal	7320.281	47.5	--	3.8	74.0	-26.5	54.0	--
Horizontal	9759.578	57.5	51.4	6.8	74.0	-16.5	54.0	-2.6
Vertical	2440.207	90.2	--	-7.3	114.0	-23.8	94.0	--
Vertical	1122.718	36.7	--	-13.9	74.0	-37.3	54.0	--
Vertical	4880.795	52.5	--	-0.5	74.0	-21.5	54.0	--
Vertical	9759.781	56.4	52.2	6.8	74.0	-17.6	54.0	-1.8

**Operation Frequency: 2480MHz:**

Polarization	Frequency (MHz)	PK Net at 3m (dBµV/m)	AV Net at 3m (dBµV/m)	Correction Factor (dB)	PK Limit at 3m (dBµV/m)	PK Margin (dB)	AV Limit at 3m (dBµV/m)	AV Margin (dB)
Horizontal	2479.531	89.1	--	-7.1	114.0	-24.9	94.0	--
Horizontal	4960.000	43.2	--	-0.5	74.0	-30.8	54.0	--
Horizontal	7439.812	54.1	48.9	4.2	74.0	-19.9	54.0	-5.1
Horizontal	9919.687	53.2	--	7.3	74.0	-20.8	54.0	--
Vertical	2479.531	89.9	--	-7.3	114.0	-24.1	94.0	--
Vertical	4959.937	52.1	--	-0.5	74.0	-21.9	54.0	--
Vertical	7440.735	50.7	--	4.2	74.0	-23.3	54.0	--
Vertical	9920.000	53.1	--	7.3	74.0	-20.9	54.0	--

- Notes:
1. AT frequencies equal to or less than 1000MHz, quasi-peak detector was used, above 1000MHz, Peak detector was used.
  2. All measurements were made at 3 meter.
  3. Negative value in the margin column shows emission below limit.
  4. Horn antenna is used for the emission over 1000MHz.
  5. When Peak emission level was below AV limit, the AV emission level did not be recorded.

## TEST REPORT

### 4.4 Band Edges Requirement

Test Requirement: FCC PART 15 C section 15.249 (d)  
(d) Emissions radiated outside of the specified frequency bands, except for harmonics, shall be attenuated by at least 50 dB below the level of the fundamental or to the general radiated emission limits in § 15.209, whichever is the lesser attenuation.

Frequency Band: 2400 MHz to 2483.5 MHz  
Test Method: ANSI C63.10: Clause 6.10  
Test Status: Pre-Scan has been conducted to determine the worst-case mode from all possible combinations between available modulations, data rates and antenna ports (if EUT with antenna diversity architecture). The lowest, middle and the highest channels were selected for the final test as listed below.

Test Configuration:

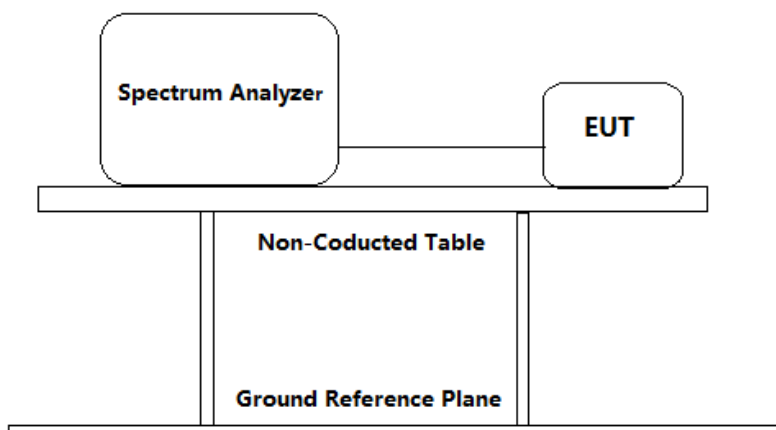

Used Test Equipment List:  
3m Semi-Anechoic Chamber, EMI Test Receiver (9 kHz~7 GHz), Signal and Spectrum Analyzer (10 Hz~40 GHz), Loop antenna (9 kHz-30 MHz). TRILOG Super Broadband test Antenna(30 MHz-3 GHz) (RX), Double-Ridged Waveguide Horn Antenna (800 MHz-18 GHz)(RX) and High Frequency Antenna & preamplifier(18 GHz~26.5 GHz) (RX). Refer to Clause 5 Test Equipment List for details.

**TEST REPORT**

Test result with plots as follows:

Lowest channel (2.402 GHz):

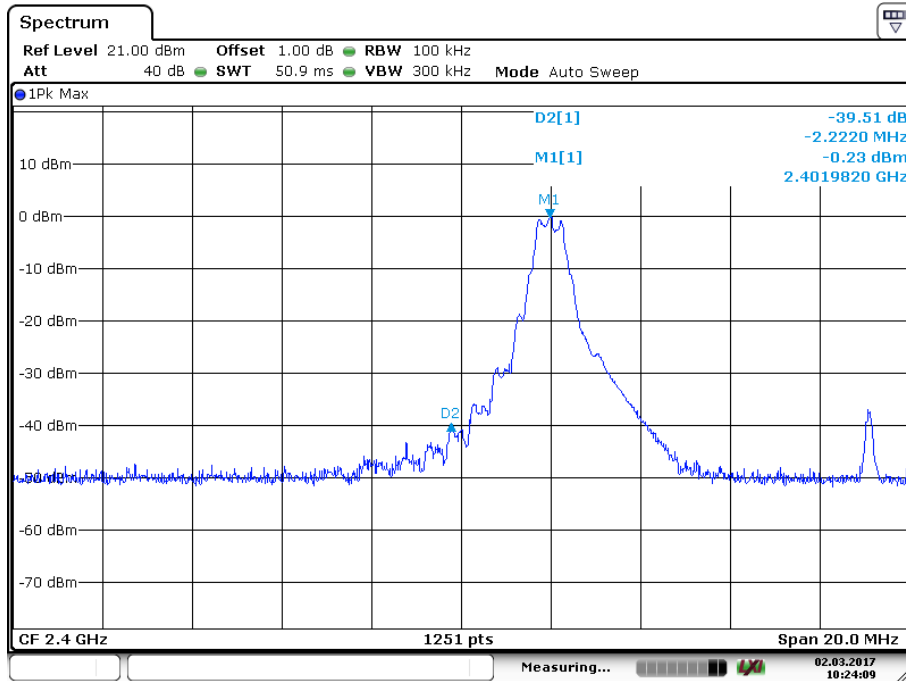

Highest Channel (2.480 GHz):

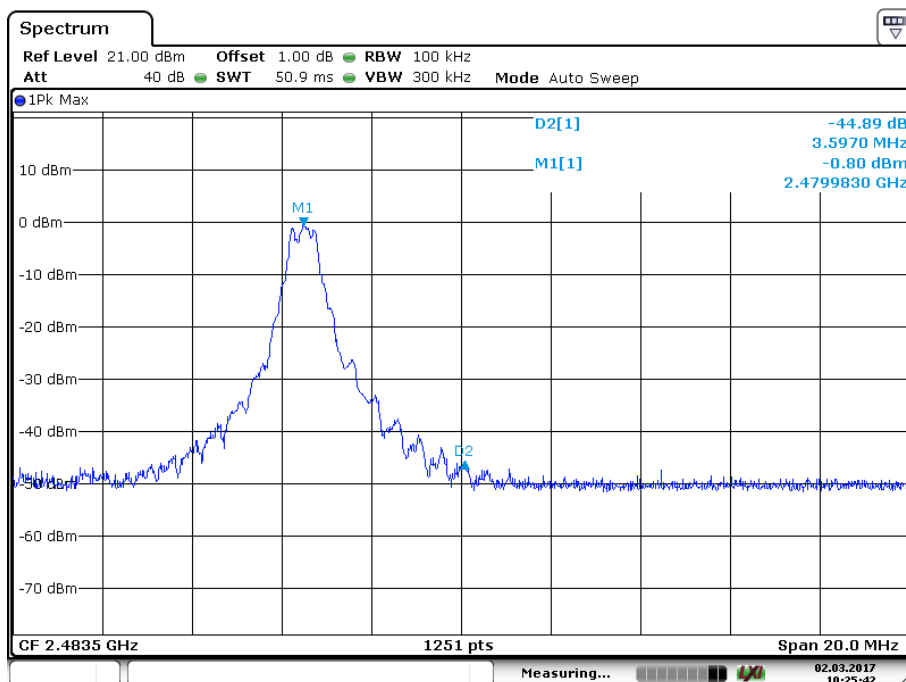

## TEST REPORT

### Peak Measurement

Band-edge compliance is determined by applying marker-delta method, i.e (Band-edge Plot).

(i) Lower band-edge:

Peak Resultant field strength

=Fundamental emissions (peak value) – delta from the band-edge plot

= 91.4dB $\mu$ v/m – 39.5dB

= 51.9dB $\mu$ v/m

(ii) Upper band-edge:

Peak Resultant field strength

=Fundamental emissions (peak value) – delta from the band-edge plot

= 89.9dB $\mu$ v/m – 44.9dB

= 45.0dB $\mu$ v/m

The Peak resultant field strength meets the general radiated emission AV limit 54dB $\mu$ v/m in 15.209, so it complies with the requirement.

## TEST REPORT

### 4.5 Conducted Emissions at Mains Terminals

Test Configuration:

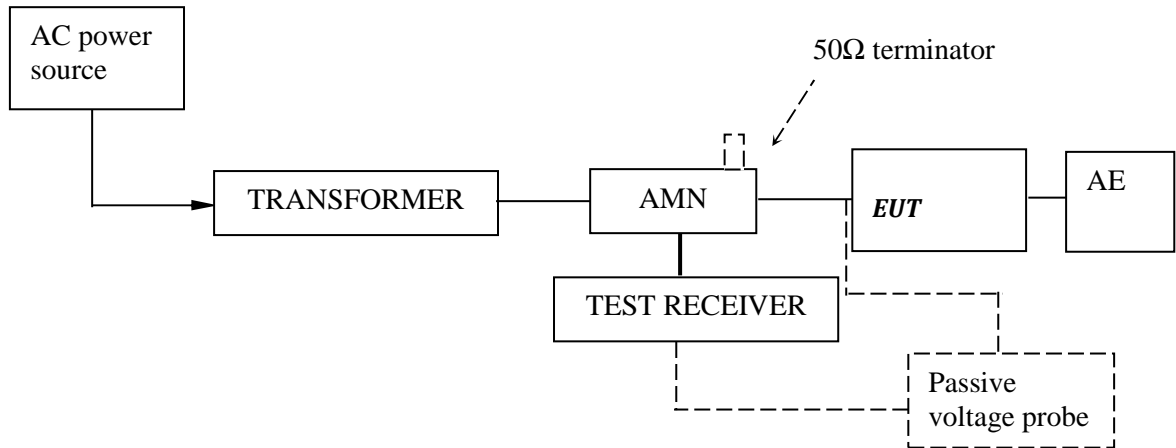

Test Setup and Procedure:

Test was performed according to ANSI C63.10 Clause 6.2. The EUT was set to achieve the maximum emission level. The mains terminal disturbance voltage was measured with the EUT in a shielded room. The EUT was connected to AC power source through an Artificial Mains Network which provides a 50Ω linear impedance. Artificial hand is used if appropriate (for handheld apparatus). The load/control terminal disturbance voltage was measured with passive voltage probe if appropriate.

The table-top EUT was placed on a 0.8m high non-metallic table above earthed ground plane (Ground Reference Plane). And for floor standing EUT, was placed on a 0.1m high non-metallic supported on GRP. The EUT keeps a distance of at least 0.8m from any other of the metallic surface. The Artificial Mains Network is situated at a distance of 0.8m from the EUT.

During the test, mains lead of EUT excess 0.8m was folded back and forth parallel to the lead so as to form a horizontal bundle with a length between 0.3m and 0.4m

The bandwidth of test receiver was set at 9 kHz. The frequency range from 150 kHz to 30MHz was checked.

Pre-test in the three channels: 2402MHz, 2440MHz and 2480MHz and found the conducted emission on 2440MHz was the worst case, so below test data was for 2440MHz.

**TEST REPORT**

Test Data and Curve

At main terminal: Pass

Tested Wire: Live

Operation Mode: transmitting on 2440MHz



RBW 9 kHz  
MT 1 s  
PREAMP OFF

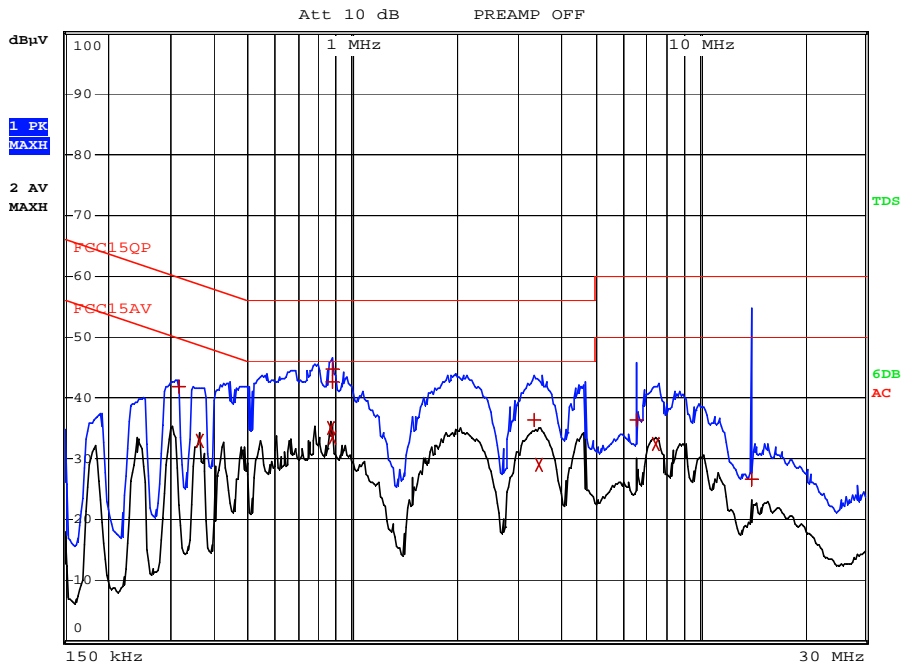

EDIT PEAK LIST (Final Measurement Results)				
TRACE	FREQUENCY	LEVEL dBμV	DELTA	LIMIT dB
Trace1:	FCC15QP			
Trace2:	FCC15AV			
Trace3:	---			
2 Average	866 kHz	34.93 L1	-11.06	
1 Quasi Peak	874 kHz	44.65 L1	-11.34	
2 Average	878 kHz	33.53 L1	-12.47	
1 Quasi Peak	878 kHz	42.62 L1	-13.38	
2 Average	362 kHz	32.97 L1	-15.70	
2 Average	3.438 MHz	29.01 L1	-16.98	
2 Average	7.486 MHz	32.30 L1	-17.69	
1 Quasi Peak	314 kHz	41.81 L1	-18.05	
1 Quasi Peak	3.35 MHz	36.37 L1	-19.62	
1 Quasi Peak	6.562 MHz	36.35 L1	-23.64	
1 Quasi Peak	14.158 MHz	26.76 L1	-33.23	

**TEST REPORT**

Tested Wire: Neutral

Operation Mode: transmitting on 2440MHz

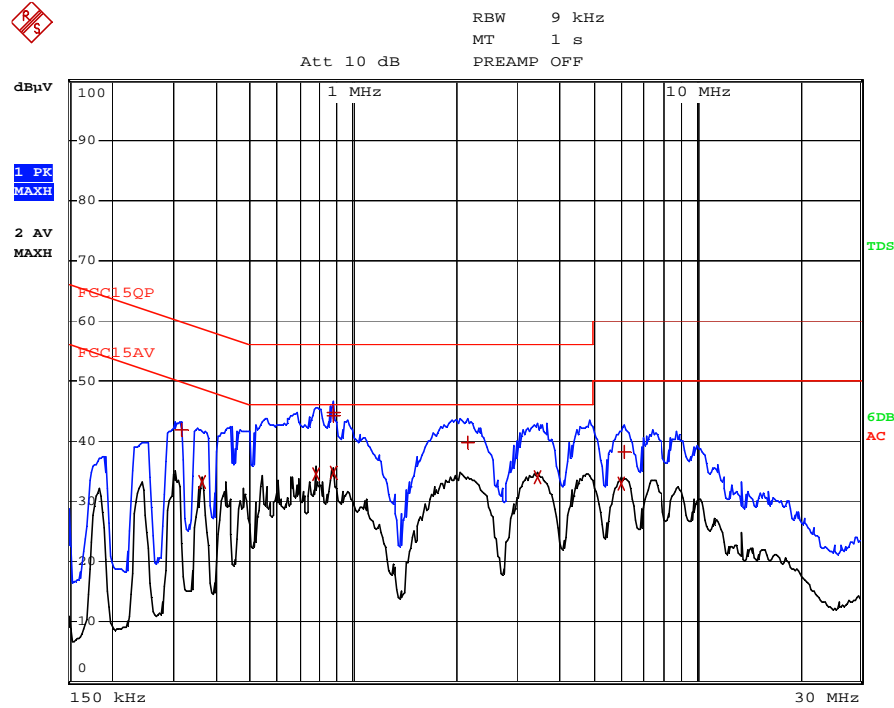

EDIT PEAK LIST (Final Measurement Results)				
Trace1:		FCC15QP		
Trace2:		FCC15AV		
Trace3:		---		
TRACE	FREQUENCY	LEVEL	dBµV	DELTA LIMIT
2 Average	878 kHz	34.68	L1	-11.31
1 Quasi Peak	874 kHz	44.62	L1	-11.38
2 Average	782 kHz	34.41	L1	-11.58
1 Quasi Peak	878 kHz	44.25	L1	-11.74
2 Average	3.45 MHz	33.88	L1	-12.11
2 Average	362 kHz	33.08	L1	-15.60
1 Quasi Peak	2.166 MHz	39.89	L1	-16.10
2 Average	6.062 MHz	32.91	L1	-17.08
1 Quasi Peak	314 kHz	41.93	L1	-17.93
1 Quasi Peak	6.202 MHz	38.26	L1	-21.73

## TEST REPORT

### 5.0 Test Equipment List

#### Radiated Emission/Radio

Equipment No.	Equipment	Model	Manufacturer	Cal. Due date (YYYY-MM-DD)	Calibration Interval
EM030-04	3m Semi-Anechoic Chamber	9×6×6 m <sup>3</sup>	ETS• LINDGREN	4/9/2020	1Y
EM031-02	EMI Test Receiver (9 kHz~7 GHz)	R&S ESR7	R&S	2/28/2020	1Y
EM031-03	Signal and Spectrum Analyzer (10 Hz~40 GHz)	R&S FSV40	R&S	9/9/2019	1Y
EM011-04	Loop antenna (9 kHz-30 MHz)	HFH2-Z2	R&S	6/14/2019	1Y
EM061-03	TRILOG Super Broadband test Antenna (30 MHz-1.5 GHz) (TX)	VULB 9161	SCHWARZBEC K	6/4/2019	1Y
EM033-01	TRILOG Super Broadband test Antenna(30 MHz-3 GHz) (RX)	VULB 9163	SCHWARZBEC K	9/20/2019	1Y
EM033-02	Bouble-Ridged Waveguide Horn Antenna (800 MHz-18 GHz)(RX)	R&S HF907	R&S	6/14/2019	1Y
EM033-03	High Frequency Antenna & preamplifier(18 GHz~26.5 GHz) (RX)	R&S SCU-26	R&S	5/4/2019	1Y
EM033-04	High Frequency Antenna & preamplifier (26 GHz-40 GHz)	R&S SCU-40	R&S	5/4/2019	1Y
EM031-02-01	Coaxial cable(9 kHz-1 GHz)	N/A	R&S	4/9/2020	1Y
EM033-02-02	Coaxial cable(1 GHz-18 GHz)	N/A	R&S	4/9/2020	1Y
EM033-04-02	Coaxial cable(18 GHz~40 GHz)	N/A	R&S	5/1/2019	1Y
EM031-01	Signal Generator (9 kHz~6 GHz)	SMB100A	R&S	7/18/2019	1Y
EM085-02	Signal Generator (10MHz-40GHz)	68369B	Wiltron	7/19/2019	1Y
EM040-01	Band Reject/Notch Filter	WRHFV	Wainwright	N/A	1Y
EM040-02	Band Reject/Notch Filter	WRCGV	Wainwright	N/A	1Y
EM040-03	Band Reject/Notch Filter	WRCGV	Wainwright	N/A	1Y
EM022-03	2.45 GHz Filter	BRM50702	Micro-Tronics	5/21/2019	1Y
SA016-16	Programmable Temperature & Humidity Test Chamber	MHU-800LJ	TERCHY	10/10/2019	1Y
SA016-22	Climatic Test Chamber	C7-1500	Vötsch	11/1/2019	1Y
SA012-74	Digital Multimeter	FLUKE175	FLUKE	10/10/2019	1Y
EM010-01	Regulated DC Power supply	PAB-3003A	GUANHUA	N/A	1Y
SA040-22	Regulated DC Power supply	IT6721	ITECH	9/9/2019	1Y
EM084-06	Audio Analyzer	8903B	HP	4/13/2019	1Y
EM045-01-01	EMC32 software (RE/RS)	V10.01.00	R&S	N/A	N/A
EM045-01-09	EMC32 software (328/893)	V9.26.01	R&S	N/A	N/A

#### Conducted emission at the mains terminals

Equipment No.	Equipment	Model	Manufacturer	Cal. Due date (YYYY-MM-DD)	Calibration Interval
EM080-05	EMI receiver	ESCI	R&S	7/18/2019	1Y
EM006-05	LISN	ENV216	R&S	6/6/2019	1Y
EM006-06	LISN	ENV216	R&S	9/9/2019	1Y
EM006-06-01	Coaxial cable	/	R&S	4/7/2020	1Y
EM004-04	EMC shield Room	8m×3m×3m	Zhongyu	1/13/2020	1Y

\*\*\*\*\*End of the test report\*\*\*\*\*