

## Industrial Internet Innovation Center (Shanghai) Co.,Ltd.

### SAR TEST REPORT

<b>PRODUCT</b>	Intraoral Scanner
<b>BRAND</b>	SHINING 3D
<b>MODEL</b>	Aoralscan 3 Wireless
<b>APPLICANT</b>	Shining 3D Tech Co., Ltd.
<b>ISSUE DATE</b>	February 27, 2023
<b>STANDARD(S)</b>	ANSI/IEEE C95.1-1992, IEEE std 1528-2013

Prepared by: Chen Jintao

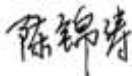

Reviewed by: Yan Hang

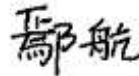

Approved by: Zhang Min



**CAUTION:**

*This report shall not be reproduced except in full without the written permission of the test laboratory and shall not be quoted out of context.*

## CONTENTS

<b>1</b>	<b>SUMMARY OF TEST REPORT</b>	<b>4</b>
1.1	TEST STANDARD (S)	4
1.2	REFERENCE DOCUMENTS	4
1.3	SUMMARY OF TEST RESULTS	5
<b>2</b>	<b>GENERAL INFORMATION OF THE LABORATORY</b>	<b>6</b>
2.1	TESTING LABORATORY	6
2.2	LABORATORY ENVIRONMENTAL REQUIREMENTS	6
2.3	PROJECT INFORMATION	6
<b>3</b>	<b>GENERAL INFORMATION OF THE CUSTOMER</b>	<b>7</b>
3.1	APPLICANT	7
3.2	MANUFACTURER	7
<b>4</b>	<b>GENERAL INFORMATION OF THE PRODUCT</b>	<b>8</b>
4.1	PRODUCT DESCRIPTION FOR EQUIPMENT UNDER TEST (EUT)	8
4.2	DESCRIPTION FOR AUXILIARY EQUIPMENT (AE)	8
<b>5</b>	<b>TEST CONFIGURATION INFORMATION</b>	<b>9</b>
5.1	TEST EQUIPMENTS UTILIZED	9
5.2	MEASUREMENT UNCERTAINTY	9
5.3	EUT CONNECTION DIAGRAM OF TEST SYSTEM	10
<b>6</b>	<b>SPECIFIC ABSORPTION RATE(SAR)</b>	<b>11</b>
6.1	INTRODUCTION	11
6.2	SAR DEFINITION	11
<b>7</b>	<b>SAR MEASUREMENT SYSTEM INTRODUCTION</b>	<b>12</b>
7.1	MEASUREMENT SET-UP	12
7.2	E-FIELD PROBE SYSTEM	13
7.3	E-FIELD PROBE CALIBRATION	14
7.4	OTHER TEST EQUIPMENT	15
<b>8</b>	<b>TEST POSITION IN RELATION TO THE PHANTOM</b>	<b>18</b>
8.1	GENERAL CONSIDERATIONS	18
8.2	BODY-WORN DEVICE	19
8.3	DESKTOP DEVICE	20
<b>9</b>	<b>TISSUE SIMULATING LIQUIDS</b>	<b>21</b>
9.1	EQUIVALENT TISSUES COMPOSITION	21
9.2	LIQUID DEPTH	23
9.3	DIELECTRIC PERFORMANCE OF TSL	24

<b>10</b>	<b>SYSTEM CHECK</b>	<b>25</b>
10.1	SYSTEM CHECK	25
10.2	SYSTEM SETUP	25
10.3	SYSTEM CHECK RESULT	26
<b>11</b>	<b>MEASUREMENT PROCEDURES</b>	<b>27</b>
11.1	TEST STEPS	27
11.2	SPATIAL PEAK SAR EVALUATION	28
11.3	GENERAL MEASUREMENT PROCEDURE	29
11.4	GSM/GPRS MEASUREMENT PROCEDURES	30
11.5	WCDMA MEASUREMENT PROCEDURES	30
11.6	LTE MEASUREMENT PROCEDURE	31
11.7	BLUETOOTH & WI-FI MEASUREMENT PROCEDURES	33
11.8	AREA SCAN BASED 1G SAR	34
<b>12</b>	<b>SIMULTANEOUS TRANSMISSION SAR CONSIDERATIONS</b>	<b>35</b>
12.1	REFERENCE DOCUMENT	35
12.2	ANTENNA SEPARATION DISTANCES	35
12.3	SAR MEASUREMENT POSITIONS	36
12.4	LOW POWER TRANSMITTERS SAR CONSIDERATION	36
12.5	SIMULTANEOUS TRANSMISSION ANALYSIS	37
<b>13</b>	<b>CONDUCTED OUTPUT POWER</b>	<b>38</b>
13.1	WI-FI MEASUREMENT RESULT	38
<b>14</b>	<b>TEST RESULTS</b>	<b>47</b>
14.1	STANDALONE SAR TEST RESULT	47
14.2	SAR MEASUREMENT VARIABILITY	51
<b>ANNEX A: MEASUREMENT DATA</b>		<b>52</b>
A.1	SAR GRAPH RESULTS	52
A.2	SYSTEM CHECK GRAPH RESULTS	68
<b>ANNEX B: CALIBRATION CERTIFICATE</b>		<b>75</b>
<b>ANNEX C: REVISED HISTORY</b>		<b>97</b>
<b>ANNEX D: ACCREDITATION CERTIFICATE</b>		<b>98</b>

## 1 Summary of Test Report

### 1.1 Test Standard (s)

No.	Test Standard(s)	Title	Version
1	ANSI/IEEE C95.1	IEEE Standard for Safety Levels with Respect to Human Exposure to Radio Frequency Electromagnetic Fields, 3 kHz to 300 GHz.	1992
2	IEEE Std 1528	Recommended Practice for Determining the Peak Spatial-Average Specific Absorption Rate (SAR) in the Human Body Due to Wireless Communications Devices: Experimental Techniques.	2013

### 1.2 Reference Documents

No.	Reference Document(s)	Title	Version
1	KDB447498	General RF Exposure Guidance	D01 v06
2	KDB865664	SAR Measurement 100 MHz to 6 GHz	D01 v01r04
3	KDB865664	RF Exposure Reporting	D02 v01r02
4	KDB248227	802.11 Wi-Fi SAR	D01 v02r02

### 1.3 Summary of Test Results

1.3.1 The maximum results of Specific Absorption Rate (SAR) in standalone mode are as follows.

Band	Reported SAR 1g(W/Kg)		Detailed Results
	Head(0mm)	Body(0mm)	
Wi-Fi 5G U-NII-1	0.509	0.813	See section 14.1
Wi-Fi 5G U-NII-2A	0.570	0.798	See section 14.1
Wi-Fi 5G U-NII-2C	0.598	1.393	See section 14.1
Wi-Fi 5G U-NII-3	0.595	1.279	See section 14.1

NOTE1:The Cra 3W manufactured by Shining 3D Tech Co., Ltd. is a new product for testing.

NOTE2:The product supports both Wi-Fi SISO and MIMO modes. Since the maximum output power in MIMO mode is always less than or equal to the sum of the maximum output power in SISO mode, it is more conservative to add the reported SAR of the SISO modes of the two antennas as the SAR values of the MIMO mode.

NOTE3:An inquiry for the product has been submitted to the FCC Office of Engineering and Technology (OET) Laboratory Division, the tracking number is 545989.

NOTE4:Industrial Internet Innovation Center (Shanghai) Co., Ltd. has verified that the compliance of the tested device specified in section 4 of this test report is successfully evaluated according to the procedure and test methods as defined in type certification requirement listed in section 1 of this test report.

## 2 General Information of The Laboratory

### 2.1 Testing Laboratory

Lab Name	Industrial Internet Innovation Center (Shanghai) Co.,Ltd.
Address	Building 4, No. 766, Jingang Road, Pudong, Shanghai, China
Telephone	021-68866880
FCC Registration No.	958356
FCC Designation No.	CN1177

### 2.2 Laboratory Environmental Requirements

Temperature	18°C~25°C
Relative Humidity	25%RH~75%RH

### 2.3 Project Information

Project Manager	Xu Yuting
Test Date	February 25, 2023 to February 27, 2023

### 3 General Information of The Customer

#### 3.1 Applicant

Company	Shining 3D Tech Co., Ltd.
Address	No. 1398 Xiangbin Road, Wenyan, Xiaoshan, Hangzhou, Zhejiang
Telephone	N/A

#### 3.2 Manufacturer

Company	Shining 3D Tech Co., Ltd.
Address	No. 1398 Xiangbin Road, Wenyan, Xiaoshan, Hangzhou, Zhejiang

## 4 General Information of The Product

### 4.1 Product Description for Equipment under Test (EUT)

Product	Intraoral Scanner
Model	Cra 3W
Date of Receipt	January 30, 2023
EUT ID*	S01
SN/IMEI	N/A
Supported Radio Technology and Bands	Wi-Fi 802.11a/n20/n40/ac20/ac40/ac80/ax20/ax40/ax80
Tx Frequency	5180-5240 MHz (U-NII-1) 5260-5320 MHz (U-NII-2A) 5500-5720 MHz (U-NII-2C) 5745-5825 MHz (U-NII-3)
Hardware Version	V1.0
Software Version	V1.0
FCC ID	2AMG4-AOS3W
Dimension	224.49mm×46mm×40mm
NOTE: EUT ID is the internal identification code of the laboratory.	

### 4.2 Description for Auxiliary Equipment (AE)

AE ID*	Description	Model	SN/Remark
CA01	Power adapter	UES36LCP1-120300SPA	UE210511WXYF1RI
EA01	Cradle	N/A	N/A
UA01	Transmission line	N/A	N/A
EB01	USB cable	N/A	N/A
NOTE: AE ID is the internal identification code of the laboratory.			



## 5 Test Configuration Information

### 5.1 Test Equipments Utilized

No.	Name	Model	S/N	Manufacturer	Cal. Date	Cal. Interval
1	Network analyzer	N5242A	MY51221755	Agilent	Oct.17, 2022	1 Year
2	Power meter	NRX	103851	R&S	Aug.22, 2022	1 Year
3	Power sensor	NRP18S-10	101841	R&S	Aug.22, 2022	1 Year
4	Power sensor	NRP18S-10	101842	R&S	Aug.22, 2022	1 Year
5	Signal Generator	E8247C	MY43000157	Agilent	Aug.22, 2022	1 Year
6	Amplifier	NTWPA-07605	22039018	RFLIGHT	Aug.22, 2022	1 Year
7	DAE	DAE4	1244	SPEAG	Mar.9, 2022	1 Year
8	E-field Probe	EX3DV4	7633	SPEAG	Mar.31, 2022	1 Year
9	Dipole Validation Kit	D5GHzV2	1172	SPEAG	Mar.15, 2022	1 Year

### 5.2 Measurement Uncertainty

Item	Uncertainty
SAR	$U_{SAR(1g)}=22.08\%$ , $U_{SAR(10g)}=21.82\%$
NOTE: This uncertainty represents an expanded uncertainty expressed at approximately the 95% confidence level using a coverage factor of k=2.	



## 6 Specific Absorption Rate(SAR)

### 6.1 Introduction

SAR is related to the rate at which energy is absorbed per unit mass in an object exposed to a radio field. The SAR distribution in a biological body is complicated and is usually carried out by experimental techniques or numerical modeling. The standard recommends limits for two tiers of groups, occupational/ controlled and general population/uncontrolled, based on a person's awareness and ability to exercise control over his or her exposure. In general, occupational/controlled exposure limits are higher than the limits for general population/uncontrolled.

### 6.2 SAR Definition

The SAR definition is the time derivative (rate) of the incremental energy ( $dW$ ) absorbed by (dissipated in) an incremental mass ( $dm$ ) contained in a volume element ( $dv$ ) of a given density ( $\rho$ ). The equation description is as below:

$$SAR = \frac{d}{dt} \left( \frac{dW}{dm} \right) = \frac{d}{dt} \left( \frac{dW}{\rho dv} \right)$$

SAR is expressed in units of Watts per kilogram (W/kg)

SAR measurement can be either related to the temperature elevation in tissue by:

$$SAR = c \left( \frac{\delta T}{\delta t} \right)$$

Where:  $C$  is the specific heat capacity,  $\delta T$  is the temperature rise and  $\delta t$  is the exposure duration, or related to the electrical field in the tissue by:

$$SAR = \frac{\sigma |E|^2}{\rho}$$

Where:

$\sigma$  is the conductivity of the tissue

$\rho$  is the mass density of tissue, which is normally set to  $1\text{g/cm}^3$

$E$  is the RMS electrical field strength

However for evaluating SAR of low power transmitter, electrical field measurement is typically applied.

## 7 SAR Measurement System Introduction

### 7.1 Measurement Set-up

The DASY5 system for performing compliance tests is illustrated above graphically. This system consists of the following items:

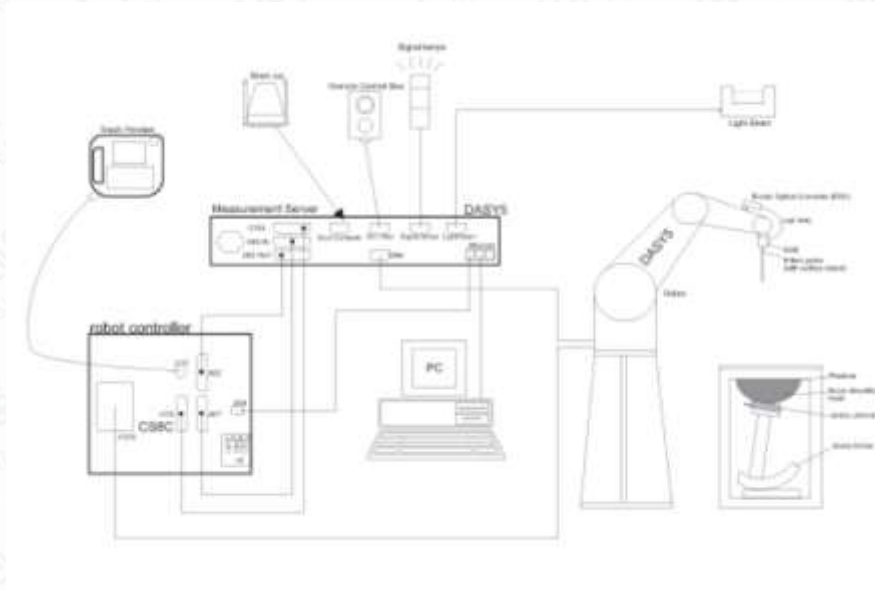

Figures 7.1-1 SAR Measurement Set-up

- A standard high precision 6-axis robot (Stäubli TX=RX family) with controller, teach pendant and software. An arm extension for accommodating the data acquisition electronics (DAE).
- An isotropic field probe optimized and calibrated for the targeted measurement.
- A data acquisition electronics (DAE) which performs the signal amplification, signal multiplexing, AD conversion, offset measurements, mechanical surface detection, collision detection, etc. The unit is battery powered with standard or rechargeable batteries. The signal is optically transmitted to the EOC.
- The Electro-optical converter (EOC) performs the conversion from optical to electrical signals for the digital communication to the DAE. To use optical surface detection, a special version of the EOC is required. The EOC signal is transmitted to the measurement server.
- The function of the measurement server is to perform the time critical tasks such as signal filtering, control of the robot operation and fast movement interrupts.
- The Light Beam used is for probe alignment. This improves the (absolute) accuracy of the probe positioning.
- A computer running WinXP and the DASY software.
- Remote control and teach pendant as well as additional circuitry for robot safety such as warning lamps, etc.

The phantom, the device holder and other accessories according to the targeted measurement.

## 7.2 E-field Probe System

The SAR measurements were conducted with the dosimetric probe designed in the classical triangular configuration and optimized for dosimetric evaluation. The probe is constructed using the thick film technique; with printed resistive lines on ceramic substrates. The probe is equipped with an optical multi-fiber line ending at the front of the probe tip. It is connected to the EOC box on the robot arm and provides an automatic detection of the phantom surface. Half of the fibers are connected to a pulsed infrared transmitter, the other half to a synchronized receiver. As the probe approaches the surface, the reflection from the surface produces a coupling from the transmitting to the receiving fibers. This reflection increases first during the approach, reaches maximum and then decreases. If the probe is flatly touching the surface, the coupling is zero. The distance of the coupling maximum to the surface is independent of the surface reflectivity and largely independent of the surface to probe angle. The DASY software reads the reflection during a software approach and looks for the maximum using 2nd order curve fitting. The approach is stopped at reaching the maximum.



Probe Specifications		
Model	EX3DV4	
Frequency Range	4 MHz – 10 GHz	
Calibration	In head simulating tissue at frequency from 650MHz to 5900MHz	
Linearity	±0.2 dB (30 MHz – 10 GHz)	
Dynamic Range	10 μW/g – >100 mW/g	
Probe Length	337 mm	
Probe Tip Length	20 mm	
Body Diameter	12 mm	
Tip Diameter	2.5 mm	
Tip-Center	1 mm	
Application	High precision dosimetric measurements in any exposure scenario (e.g., very strong gradient fields); the only probe that enables compliance testing for frequencies up to 6 GHz with precision of better than 30%.	

Figure 7.2-1 Detail of Probe

Figure 7.2-2 E-field Probe

### 7.3 E-field Probe Calibration

Each E-Probe/Probe Amplifier combination has unique calibration parameters. A TEM cell calibration procedure is conducted to determine the proper amplifier settings to enter in the probe parameters. The amplifier settings are determined for a given frequency by subjecting the probe to a known E-field density (1 mW/cm<sup>2</sup>) using an RF Signal generator, TEM cell, and RF Power Meter.

The free space E-field from amplified probe outputs is determined in a test chamber. This calibration can be performed in a TEM cell if the frequency is below 1 GHz and in a waveguide or other methodologies above 1 GHz for free space. For the free space calibration, the probe is placed in the volumetric center of the cavity and at the proper orientation with the field. The probe is then rotated 360 degrees until the three channels show the maximum reading. The power density readings equates to 1 mW/cm<sup>2</sup>.

E-field temperature correlation calibration is performed in a flat phantom filled with the appropriate simulated brain tissue. The E-field in the medium correlates with the temperature rise in the dielectric medium. For temperature correlation calibration a RF transparent thermistor-based temperature probe is used in conjunction with the E-field probe.

$$SAR = C \frac{\Delta T}{\Delta t}$$

Where:

$\Delta t$  = Exposure time (30 seconds),

C = Heat capacity of tissue (brain or muscle),

$\Delta T$  = Temperature increase due to RF exposure.

$$SAR = \frac{|E|^2 \cdot \sigma}{\rho}$$

Where:

$\sigma$  = Simulated tissue conductivity,

$\rho$  = Tissue density (kg/m<sup>3</sup>).

## 7.4 Other Test Equipment

### 7.4.1 Data Acquisition Electronics (DAE)

The data acquisition electronics consist of a highly sensitive electrometer-grade preamplifier with auto-zeroing, a channel and gain-switching multiplexer, a fast 16 bit AD-converter and a command decoder with a control logic unit. Transmission to the measurement server is accomplished through an optical downlink for data and status information, as well as an optical uplink for commands and the clock.

The mechanical probe mounting device includes two different sensor systems for frontal and sideways probe contacts. They are used for mechanical surface detection and probe collision detection. The input impedance of the DAE is 200M Ohm; the inputs are symmetrical and floating. Common mode rejection is above 80dB.



Figure 7.4.1-1: DAE

### 7.4.2 Robot

The SPEAG DASY system uses the high precision robots (DASY5: TX90) type from Stäubli SA (France).

For the 6-axis controller system, the robot controller version from Stäubli is used. The Stäubli robot series have many features that are important for our application

- High precision (repeatability 0.02mm)
- High reliability (industrial design)
- Low maintenance costs (virtually maintenance free due to direct drive gears; no belt drives)
- Jerk-free straight movements (brushless synchronal motors; no stepper motors)
- Low ELF interference (motor control fields shielded via the closed metallic construction shields)



Figure 7.4.2-1: DASY5

### 7.4.3 Measurement Server

The DASY5 measurement server is based on a PC/104 CPU board with a 400 MHz intel ULV Celeron, 128 MB chipdisk and 128 MB RAM. The necessary circuits for communication with either the DAE4 (or DAE3) electronics box as well as the 16 bit AD converter system for optical detection and digital I/O interface are contained on the DASY5 I/O board, which is directly connected to the PC/104 bus of the CPU board.



Figure 7.4.3-1 Server for DASY5

The measurement server performs all real-time data evaluation of field measurements and surface detection, controls robot movements and handles safety operation. The PC operating system cannot interfere with these time critical processes. All connections are supervised by a watchdog, and disconnection of any of the cables to the measurement server will automatically disarm the robot and disable all program-controlled robot movements. Furthermore, the measurement server is equipped with an expansion port which is reserved for future applications. Please note that this expansion port does not have a standardized pinout, and therefore only devices provided by SPEAG can be connected. Devices from any other supplier could seriously damage the measurement server.

### 7.4.4 Device Holder for Phantom

The SAR in the phantom is approximately inversely proportional to the square of the distance between the source and the liquid surface. For a source at 5mm distance, a positioning uncertainty of  $\pm 0.5\text{mm}$  would produce a SAR uncertainty of  $\pm 20\%$ . Accurate device positioning is therefore crucial for accurate and repeatable measurements. The positions in which the devices must be measured are defined by the standards.

The DASY device holder is designed to cope with the different positions given in the standard. It has two scales for device rotation (with respect to the body axis) and device inclination (with respect to the line between the ear reference points). The rotation centers for both scales is the ear reference point (ERP). Thus the device needs no repositioning when changing the angles.



Figure 7.4.4-1: Device Holder

The DASY device holder is constructed of low-loss POM material having the following dielectric parameters: relative permittivity  $\epsilon = 3$  and loss tangent  $\delta = 0.02$ . The amount of dielectric material has been reduced in the closest vicinity of the device, since measurements have suggested that the influence of the clamp on the test results could thus be lowered.



The extension is lightweight and made of POM, acrylic glass and foam. It fits easily on the upper part of the Mounting Device in place of the phone positioner. The extension is fully compatible with the Twin-SAM and ELI phantoms.

The DASY device holder is constructed of low-loss POM material having the following dielectric parameters: relative permittivity  $\epsilon = 3$  and loss tangent  $\delta = 0.02$ . The amount of dielectric material has been reduced in the closest vicinity of the device, since measurements have suggested that the influence of the clamp on the test results could thus be lowered.



Figure 7.4.4-2: Laptop Extension Kit

7.4.5 Phantom

The SAM Twin Phantom V4.0 is constructed of a fiberglass shell integrated in a table. The shape of the shell is based on data from an anatomical study designed to represent the 90th percentile of the population. The phantom enables the dissymmetric evaluation of SAR for both left and right handed handset usage, as well as body-worn usage using the flat phantom region. Reference markings on the Phantom allow the complete setup of all predefined phantom positions and measurement grids by manually teaching three points in the robot. The shell phantom has a 2mm shell thickness (except the ear region where shell thickness increases to 6 mm).

Shell Thickness	2 ± 0.2 mm
Available	Special
Filling Volume	Approx. 25 liters
Dimensions	810 mm x 1000 mm x 500 mm (H x L x W)

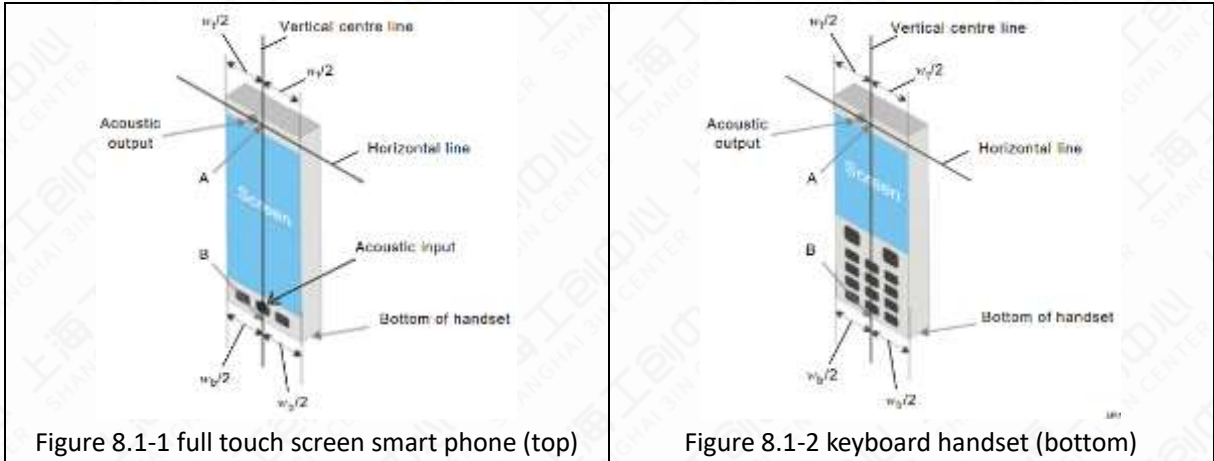

Figure 7.4.5-1: SAM Twin Phantom

## 8 Test Position in Relation to the Phantom

### 8.1 General considerations

This standard specifies two handset test positions against the head phantom – the “cheek” position and the “tilt” position.



$w_t$	Width of the handset at the level of the acoustic output
$w_b$	Width of the bottom of the handset
A	Midpoint of the width $w_t$ of the DUT at the level of the acoustic output
B	Midpoint of the width $w_b$ of the bottom of the handset

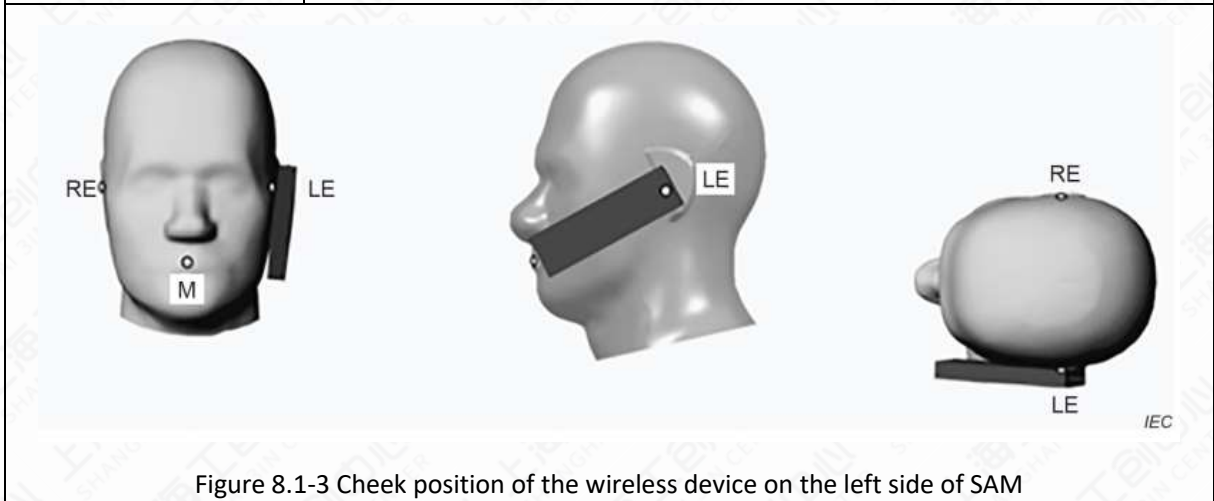

Figure 8.1-3 Cheek position of the wireless device on the left side of SAM

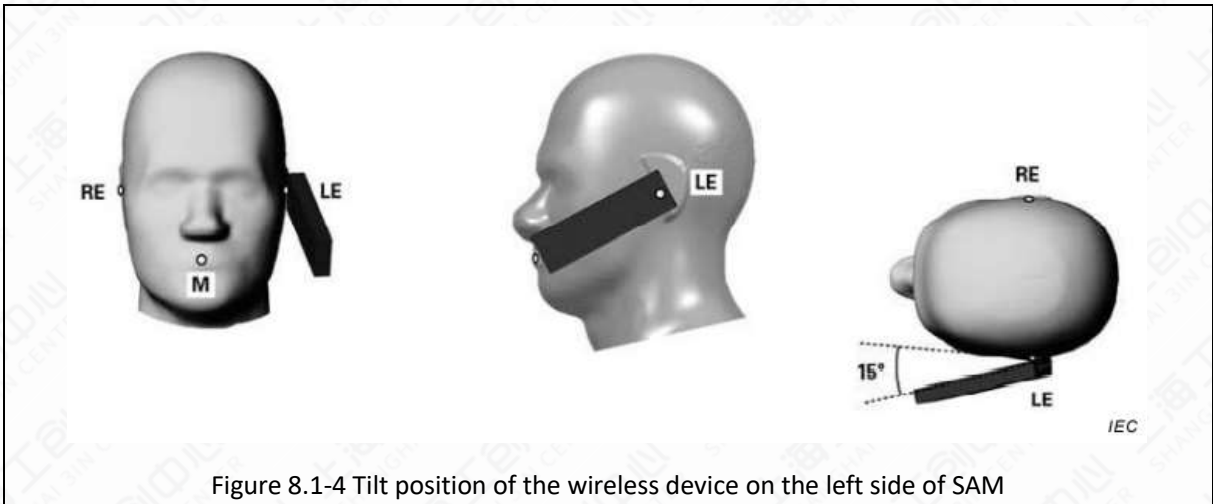

Figure 8.1-4 Tilt position of the wireless device on the left side of SAM

## 8.2 Body-worn device

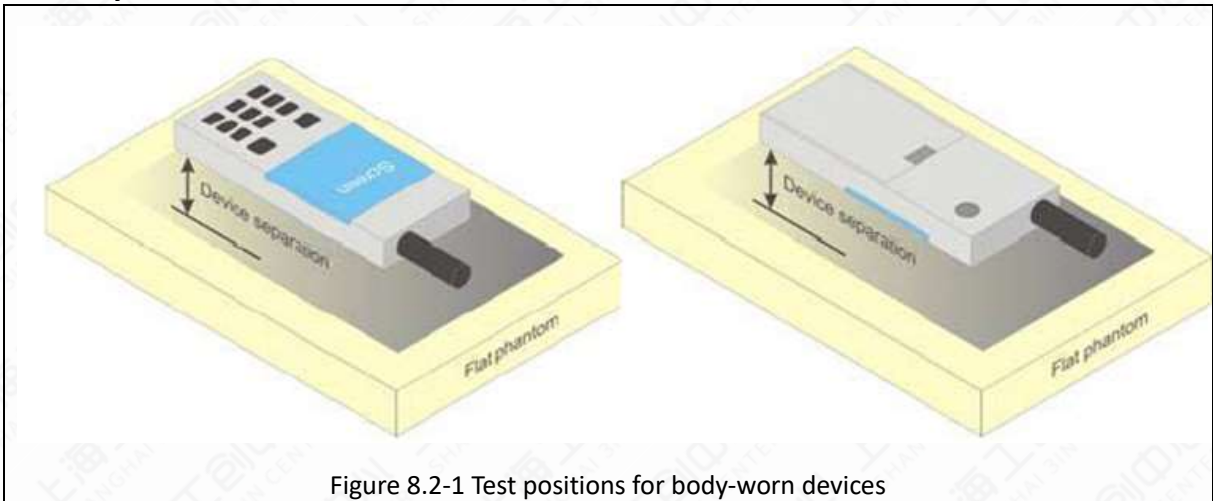

Figure 8.2-1 Test positions for body-worn devices

A typical example of a body-worn device is a mobile phone, wireless enabled PDA (personal digital assistant) or other battery operated wireless device with the ability to transmit while mounted on a person's body using a carry accessory approved by the wireless device manufacturer.

### 8.3 Desktop device

<p>A typical example of a desktop device is a wireless enabled desktop computer placed on a table or desk when used.</p>
<p>The DUT shall be positioned at the distance and in the orientation to the phantom that corresponds to the intended use as specified by the manufacturer in the user instructions. For devices that employ an external antenna with variable positions.</p>
<p>Tests shall be performed for all antenna positions specified.</p>
<p>Picture 8-6 shows positions for desktop device SAR tests. If the intended use is not specified, the device shall be tested directly against the flat</p>

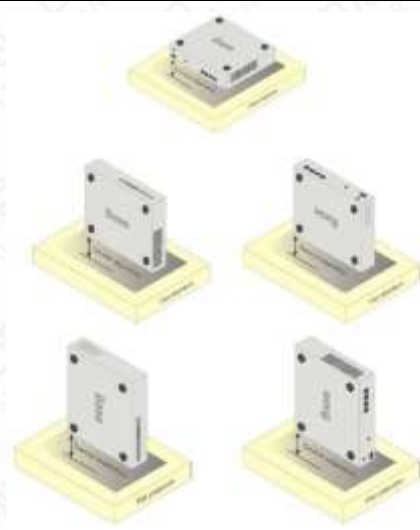

Figure 8.3-1 Test positions for desktop devices

## 9 Tissue Simulating Liquids

### 9.1 Equivalent Tissues Composition

The liquid used for the frequency range of 650-6000 MHz consisted of water, sugar, salt, preventol, glycol monobutyl and Cellulose. The liquid has been previously proven to be suited for worst-case. The Table 9.1 shows the detail solution. It's satisfying the latest tissue dielectric parameters requirements proposed by the IEEE Std 1528.

Table 9.1-1: Composition of the Head Tissue Equivalent Matter

Frequency (MHz)	835	900	1800	1950	2300	2450	2600	5800
<b>Ingredients (% by weight)</b>								
Water	41.45	40.92	55.242	54.89	56.34	58.79	58.79	65.53
Sugar	56.0	56.5	/	/	/	/	/	
Salt	1.45	1.48	0.306	0.18	0.14	0.06	0.06	
Preventol	0.1	0.1	/	/	/	/	/	
Cellulose	1.0	1.0	/	/	/	/	/	
GlycolMonobutyl	/	/	44.452	44.93	43.52	41.15	41.15	
Diethyenglycol momohexylether	/	/	/	/	/	/	/	17.24
Triton X-100	/	/	/	/	/	/	/	17.23
Dielectric Parameters Target Value	$\epsilon=41.5$ $\sigma=0.90$	$\epsilon=41.5$ $\sigma=0.97$	$\epsilon=40.0$ $\sigma=1.40$	$\epsilon=40.0$ $\sigma=1.40$	$\epsilon=39.5$ $\sigma=1.67$	$\epsilon=39.2$ $\sigma=1.80$	$\epsilon=39.0$ $\sigma=1.96$	$\epsilon=35.3$ $\sigma=5.27$

Table 9.1-2: Targets for tissue simulating liquid

Frequency (MHz)	Liquid Type	Conductivity ( $\sigma$ )	$\pm 5\%$ Range	Permittivity ( $\epsilon$ )	$\pm 5\%$ Range
750	Head	0.89	0.846~0.934	41.9	39.805~43.995
835	Head	0.90	0.855~0.945	41.5	39.425~43.575
900	Head	0.97	0.922~1.018	41.5	39.425~43.575
1450	Head	1.20	1.140~1.260	40.5	38.475~42.525
1750	Head	1.37	1.302~1.438	40.1	38.095~42.105
1800	Head	1.40	1.330~1.470	40.0	38.000~42.000
1900	Head	1.40	1.330~1.470	40.0	38.000~42.000
2000	Head	1.40	1.330~1.470	40.0	38.000~42.000
2100	Head	1.49	1.416~1.564	39.8	37.810~41.790
2300	Head	1.67	1.587~1.753	39.5	37.525~41.475
2450	Head	1.80	1.710~1.890	39.2	37.240~41.160
2600	Head	1.96	1.862~2.058	39.0	37.050~40.950
3000	Head	2.40	2.280~2.520	38.5	36.575~40.425
3500	Head	2.91	2.765~3.055	37.9	36.005~39.795
4000	Head	3.43	3.259~3.601	37.4	35.530~39.270
4500	Head	3.94	3.743~4.137	36.8	34.960~38.640
5000	Head	4.45	4.228~4.672	36.2	34.390~38.010
5200	Head	4.66	4.427~4.893	36.0	34.200~37.800
5400	Head	4.86	4.617~5.103	35.8	34.010~37.590
5600	Head	5.07	4.817~5.323	35.5	33.725~37.275
5800	Head	5.27	5.007~5.533	35.3	33.535~37.065
6000	Head	5.48	5.206~5.754	35.1	33.345~36.855

NOTE: For dielectric properties of head tissue-equivalent liquid at other frequencies within the frequency range, a linear interpolation method shall be used.

## 9.2 Liquid depth

The Measurements were performed in the flat section of the TWIN SAM or ELI phantom, shell thickness:  $2.0 \pm 0.2 \text{ mm}$  (bottom Plate) filled with Body or Head simulating Liquid.

The depth of tissue-equivalent liquid in a phantom must be  $\geq 15.0 \text{ cm}$  with  $\leq \pm 0.5 \text{ cm}$  variation for SAR measurements  $\leq 3 \text{ GHz}$  and  $\geq 10.0 \text{ cm}$  with  $\leq \pm 0.5 \text{ cm}$  variation for measurements  $> 3 \text{ GHz}$ .

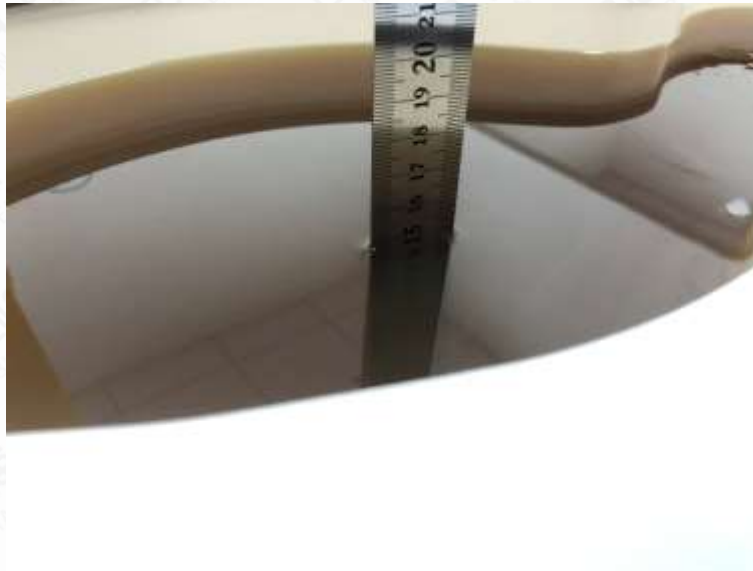

Picture 9.2-1 Liquid depth in the Flat Phantom for SAR measurements  $\leq 3 \text{ GHz}$

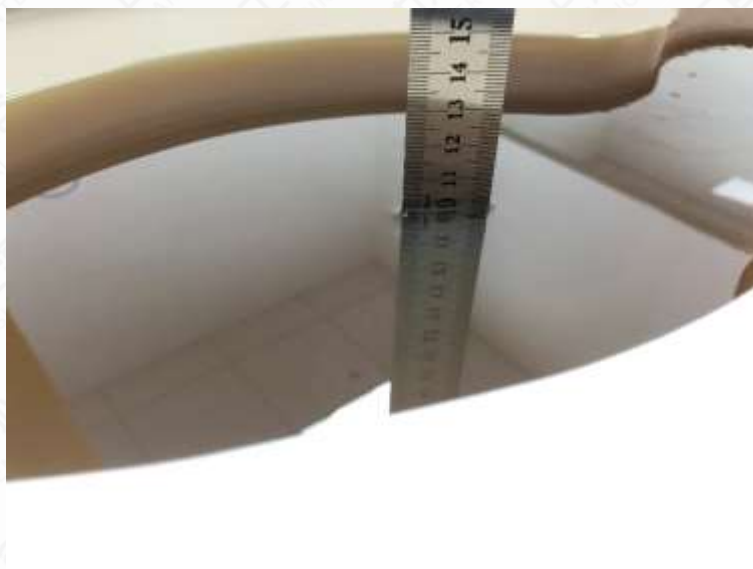

Picture 9.2-2 Liquid depth in the Flat Phantom for SAR measurements  $> 3 \text{ GHz}$

### 9.3 Dielectric Performance of TSL

Table 9.3-1: Dielectric Performance of Head Tissue Simulating Liquid

Tissue Simulating Liquid								
Frequency (MHz)	Head(Standard)		Temperature	Date	Test Result		Deviation (%)	
	Permittivity $\epsilon$	Conductivity $\sigma$			Permittivity $\epsilon$	Conductivity $\sigma$	Permittivity $\epsilon$	Conductivity $\sigma$
5200	36.00	4.66	20.2°C	February 25, 2023	36.123	4.710	0.34%	1.07%
5300	35.90	4.76	20.2°C	February 25, 2023	35.926	4.823	0.07%	1.32%
5300	35.90	4.76	20.0°C	February 26, 2023	34.905	4.758	-2.77%	-0.04%
5600	35.50	5.07	20.0°C	February 26, 2023	34.322	5.069	-3.32%	-0.02%
5600	35.50	5.07	20.3°C	February 27, 2023	34.938	5.152	-1.58%	1.62%
5800	35.30	5.27	20.0°C	February 26, 2023	33.918	5.284	-3.92%	0.27%
5800	35.30	5.27	20.3°C	February 27, 2023	34.541	5.392	-2.15%	2.31%



## 10 System Check

### 10.1 System Check

Each DASY system is equipped with one or more system validation kits. These units, together with the predefined measurement procedures within the DASY software, enable the user to conduct the system performance check and system validation. System validation kit includes a dipole, tripod holder to fix it underneath the flat phantom and a corresponding distance holder.

### 10.2 System Setup

In the simplified setup for system evaluation, the DUT is replaced by a calibrated dipole and the power source is replaced by a continuous wave that comes from a signal generator. The calibrated dipole must be placed beneath the flat phantom section of the SAM twin phantom with the correct distance holder. The distance holder should touch the phantom surface with a light pressure at the reference marking and be oriented parallel to the long side of the phantom. The equipment setup is shown below:

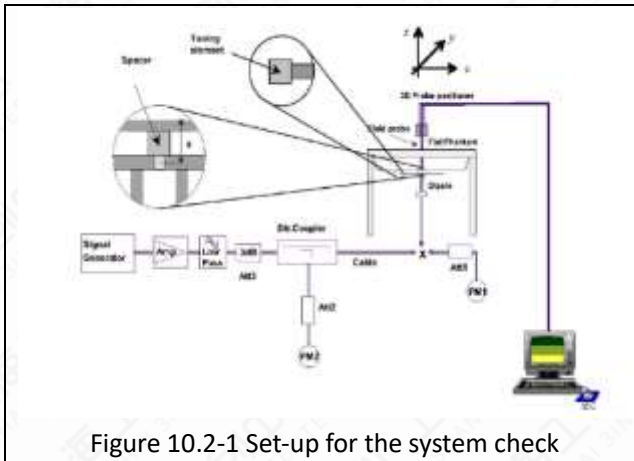

Figure 10.2-1 Set-up for the system check

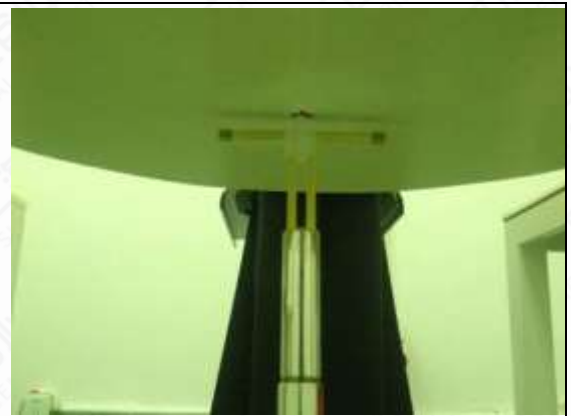

Figure 10.2-2. Setup for Dipole

### 10.3 System Check Result

Table 10.3-1: System Check Result of SAR

SAR System Check								
Frequency (MHz)	Target Value (w/kg)		Temperature	Date	Test Result (w/kg)		Deviation (%)	
	10g	1g			10g	1g	10g	1g
5200	21.80	75.70	21.3°C	February 25, 2023	21.70	75.60	-0.46%	-0.13%
5300	22.60	78.70	21.3°C	February 25, 2023	23.40	80.60	3.54%	2.41%
5300	22.60	78.70	21.0°C	February 26, 2023	22.80	78.70	0.88%	0.00%
5600	22.80	80.00	21.0°C	February 26, 2023	23.20	82.00	1.75%	2.50%
5600	22.80	80.00	21.5°C	February 27, 2023	23.60	83.40	3.51%	4.25%
5800	21.50	76.70	21.0°C	February 26, 2023	22.30	78.50	3.72%	2.35%
5800	21.50	76.70	21.5°C	February 27, 2023	21.70	77.00	0.93%	0.39%

NOTE: The system verifies that the measured input power level is equivalent to 250mW for 0.6GHz to 3GHz and above 3GHz is equivalent to 100mW, and the measured results are compared with the target value by converting to 1W.

## 11 Measurement Procedures

### 11.1 Test Steps

According to the SAR test standard, the recommended procedure for assessing the peak spatial-average SAR value consists of the following steps:

#### (a) Power reference measurement

The reference and drift jobs are useful for monitoring the power drift of the device under test in the batch process. Both jobs measure the electric field strength at a specified reference position, at a selectable distance from the phantom surface. The reference position can be either the selected section's grid reference point or a user point in this section. The reference job projects the selected point onto the phantom surface, orients the probe perpendicularly to the surface, and approaches the surface using the selected detection method.

#### (b) Area scan

The area scan is used as a fast scan in two dimensions to find the area of high field values, before doing a finer measurement around the hot spot. The sophisticated interpolation routines implemented in DASY software can find the maximum locations even in relatively coarse grids. The scan area is defined by an editable grid. This grid is anchored at the grid reference point of the selected section in the phantom. When the area scan's property sheet is brought up, grid was at to 15mm \* 15mm and can be edited by users.

#### (c) Zoom scan

Zoom scans are used to assess the peak spatial SAR values within a cubic averaging volume containing 1g and 10g of simulated tissue. The default zoom scan measures 5 \* 5 \* 7 points within a cube whose base faces are centered around the maximum found in a preceding area scan job within the same procedure. If the preceding Area Scan job indicates more than one maximum, the number of Zoom Scans has to be enlarged accordingly.

#### (d) Power drift measurement

The drift job measures the field at the same location as the most recent reference job within the same procedure, and with the same setting. The drift measurement gives the field difference in dB from the reading conducted within the last reference measurement. Several drift measurements are possible for one reference measurement. This allows a user to monitor the power drift of the device under within a batch process. In the properties of the drift job, the user can specify a limit for the drift and have DASY software stop the measurements if this limit is exceeded. This ensures that the power drift during one measurement is within 5%.

The SAR measurement procedures for each of test conditions are as follows:

- (a) Make EUT to transmit it maximum output power
- (b) Measure conducted output power through RF cable
- (c) Place the EUT in the specific position of phantom
- (d) Measure SAR results for Middle channel or the highest power channel on each testing position
- (e) Measure SAR results for other channels in worst SAR testing position if the reported SAR of highest power channel is larger than 0.8 W/kg
- (f) Record the SAR value

## 11.2 Spatial Peak SAR Evaluation

The procedure for spatial peak SAR evaluation has been implemented according to the IEEE Std 1528 standard. It can be conducted for 1g and 10g.

The DASY system allows evaluations that combine measured data and robot positions, such as:

### (a) Maximum Search

During a maximum search, global and local maximum searches are automatically performed in 2D after each Area Scan measurement with at least 6 measurement points. It is based on the evaluation of the local SAR gradient calculated by the Quadratic Shepard's method. The algorithm will find the global maximum and all local maxima within -2dB of the global maxima for all SAR distributions.

### (b) Extrapolation

Extrapolation routines are used to obtain SAR values between the lowest measurement points and the inner phantom surface. The extrapolation distance is determined by the surface detection distance and the probe sensor offset. Several measurements at different distances are necessary for the extrapolation.

Extrapolation routines require at least 10 measurement points in 3D space. They are used in the Cube Scan to obtain SAR values between the lowest measurement points and the inner phantom surface. The routine uses the modified Quadratic Shepard's method for extrapolation. For a grid using 5\*5\*5 measurement points with 5mm resolution amounting to 343 measurement points, the uncertainty of the extrapolation routines is less than 1% for 1g and 10 cubes.

### (c) Boundary effect

For measurements in the immediate vicinity of a phantom surface, the field coupling effects between the probe and the boundary influence the probe characteristics. Boundary effect errors of different dosi-metric probe types have been analyzed by measurements and using a numerical probe model. As expected, both methods showed an enhanced sensitivity in the immediate vicinity of the boundary. The effect strongly depends on the probe dimensions and disappears with increasing distance from the boundary. The sensitivity can be approximately given as:

$$S \approx S_0 + S_b * \exp\left(-\frac{z}{a}\right) * \cos\left(\pi \frac{z}{\lambda}\right)$$

Since the decay of the boundary effect dominates for small probe ( $a \ll \lambda$ ), the cos-term can be omitted. Factors  $S_b$  (parameter Alpha in the DASY software) and  $a$  (parameter Delta in the DASY software) and assessed during probe calibration and used for numerical compensation of the boundary effect. Several simulations and measurements have confirmed that the compensation is valid for different field and boundary configurations.

This simple compensation procedure can largely reduce the probe uncertainty near boundaries. It works well as long as:

- The boundary curvature is small
- The probe axis is angled less than 30° to the boundary normal
- The distance between probe and boundary is larger than 25% of the probe diameter
- The probe is symmetric (all sensors have the same offset from the probe tip)

Since all of these requirements are fulfilled in a DASY system, the correction of the probe boundary effect in the vicinity of the phantom surface is performed in a fully automated manner via the

measurement data extraction during post processing.

### 11.3 General Measurement Procedure

The area and zoom scan resolutions specified in the table below must be applied to the SAR measurements and fully documented in SAR reports to qualify for TCB approval. Probe boundary effect error compensation is required for measurements with the probe tip closer than half a probe tip diameter to the phantom surface. Both the probe tip diameter and sensor offset distance must satisfy measurement protocols; to ensure probe boundary effect errors are minimized and the higher fields closest to the phantom surface can be correctly measured and extrapolated to the phantom surface for computing 1-g SAR. Tolerances of the post-processing algorithms must be verified by the test laboratory for the scan resolutions used in the SAR measurements, according to the reference distribution functions specified in IEEE Std 1528-2013. The results should be documented as part of the system validation records and may be requested to support test results when all the measurement parameters in the following table are not satisfied.

Table 11.3-1: Test Resolution Requirement

Items		≤3GHz	>3GHz	
Maximum Distance		5mm ±1mm	$\frac{1}{2} * \delta * \ln(2)$ mm ±0.5mm	
Maximum probe angle		30±1°	20±1°	
Maximum Area Scan spatial resolution: $\Delta x_{Area}$ , $\Delta y_{Area}$		≤2GHz: ≤15mm	3-4GHz: ≤12mm	
		2-3GHz: ≤12mm	4-6GHz: ≤10mm	
		when the x or y dimension of the device , in the measurement plane orientation, is smaller than the above, the measurement resolution must be ≤ the corresponding x or y dimension of the device with at least one measurement point on the device		
Maximum Zoom Scan spatial resolution: $\Delta x_{Zoom}$ , $\Delta y_{Zoom}$		≤2GHz: ≤8mm	3-4GHz: ≤5mm	
		2-3GHz: ≤5mm	4-6GHz: ≤4mm	
maximum zoom scan spatial resolution, normal to phantom surface	uniform grid: $\Delta z_{Zoom}(n)$	≤5mm	3-4GHz: ≤4mm 4-5GHz: ≤3mm 5-6GHz: ≤2mm	
	graded grid	$\Delta z_{Zoom}(1)$ : between 1 <sup>st</sup> two points closest to phantom surface	≤4mm	3-4GHz: ≤3mm 4-5GHz: ≤2.5mm 5-6GHz: ≤2mm
		$\Delta z_{Zoom}(n > 1)$ between subsequent points	≤1.5*	
minimum zoom scan volume	x, y, z	≥30mm	3-4GHz: ≥28mm 4-5GHz: ≥25mm 5-6GHz: ≥22mm	

**Notes:**

$\delta$  is the penetration depth of a plane-wave at normal incidence to the tissue medium in IEEE Std 1528-2013.

When Zoom Scan is required and reported SAR from the Area Scan based 1-g SAR estimation procedure of KDB publication 447498 is  $\leq 1.4$  W/kg,  $\leq 8$ mm for 2GHz-3GHz,  $\leq 7$ mm for 3GHz-4GHz,  $\leq 5$ mm for 4GHz-6GHz Zoom Scan resolution may be applied.

### 11.4 GSM/GPRS Measurement Procedures

GSM/GPRS/EDGE modes is determined by the source-based time-averaged output power including tune-up tolerance. The mode with highest specified time-averaged output power should be tested for SAR compliance in the applicable exposure conditions. For modes with the same specified maximum output power and tolerance, the higher number time-slot configuration should be tested. Other configurations of GSM/GPRS/EDGE are considered as secondary modes. The 3G SAR test reduction procedure is applied, when the maximum output power and tune-up tolerance specified for production units in a secondary mode is  $\leq \frac{1}{4}$  dB higher than the primary mode, SAR measurement is not required for the secondary mode.

### 11.5 WCDMA Measurement Procedures

The following procedures are applicable to WCDMA handsets operating under 3GPP Release99, Release 5 and Release 6. The default test configuration is to measure SAR with an established radio link between the DUT and a communication test set using a 12.2kbps RMC (reference measurement channel) configured in Test Loop Mode 1. SAR is selectively confirmed for other physical channel configurations (DPCCH & DPDCH), HSDPA and HSPA (HSUPA/HSDPA) modes according to output power, exposure conditions and device operating capabilities. Both uplink and downlink should be configured with the same RMC or AMR, when required. SAR for Release 5 HSDPA and Release 6 HSPA are measured using the applicable FRC (fixed reference channel) and E-DCH reference channel configurations. Maximum output power is verified according to applicable versions of 3GPP TS 34.121 and SAR must be measured according to these maximum output conditions. When Maximum Power Reduction (MPR) is not implemented according to Cubic Metric (CM) requirements for Release 6 HSPA, the following procedures do not apply.

Table 11.5-1: HSDPA setting for Release 5

Sub-test	$\beta_c$	$\beta_d$	$\beta_d$ (SF)	$\beta_c / \beta_d$	$\beta_{hs}$	CM (dB)	MPR (dB)
1	2/15	15/15	64	2/15	4/15	1.5	0.5
2	12/15	15/15	64	12/15	24/25	2.0	1
3	15/15	8/15	64	15/8	30/15	2.0	1
4	15/15	4/15	64	15/4	30/15	2.0	1

Table 11.5-2: HSUPA setting for Release 6

Sub-test	$\beta_c$	$\beta_d$	$\beta_d$ (SF)	$\beta_c / \beta_d$	$\beta_{hs}$	$\beta_{ec}$	$\beta_{ed}$	$\beta_{ed}$ (SF)	$\beta_{ed}$ (codes)	CM (dB)	MPR (dB)	AG Index	E-TFCI

1	11/15	15/15	64	11/15	22/15	209/225	1039/225	4	1	2.0	1.0	20	75
2	6/15	15/15	64	6/15	12/15	12/15	12/15	4	1	3.0	2.0	12	67
3	15/15	9/15	64	15/9	30/15	30/15	$\beta_{ed1},47/15$ $\beta_{ed2},47/15$	4	2	3.0	2.0	15	92
4	2/15	15/15	64	2/15	4/15	4/15	56/75	4	1	2.0	1.0	17	71
5	15/15	15/15	64	15/15	24/15	30/15	134/15	4	1	2.0	1.0	21	81

### 11.6 LTE Measurement Procedure

SAR tests for LTE are performed with a base station simulator. Closed loop power control was used so the UE transmits with maximum output power during SAR testing.

- (a) KDB 941225 D05, start with the largest channel bandwidth and measure SAR for QPSK with 1 RB allocation, using the RB offset and required test channel combination with the highest maximum output power for RB offsets at the upper edge, middle and lower edge of each required test channel.
- (b) 50% RB allocation for QPSK SAR testing follows 1RB QPSK allocation procedure.
- (c) For QPSK with 100% RB allocation, SAR is not required when the highest maximum output power for 100 % RB allocation is less than the highest maximum output power in 50% and 1 RB allocations and the highest reported SAR for 1 RB and 50% RB allocation are  $\leq 0.8$  W/kg. Otherwise, SAR is measured for the highest output power channel; and if the reported SAR is  $> 1.45$  W/kg, the remaining required test channels must also be tested.
- (d) 16QAM/64QAM output power for each RB allocation configuration is  $>$  not  $\frac{1}{2}$ dB higher than the same configuration in QPSK and the reported SAR for the QPSK configuration is  $\leq 1.45$  W/kg; 16QAM/64QAM SAR testing is not required.
- (e) Smaller bandwidth output power for each RB allocation configuration is  $>$  not  $\frac{1}{2}$ dB higher than the same configuration in the largest supported bandwidth, and the reported SAR for the largest supported bandwidth is  $\leq 1.45$  W/kg; smaller bandwidth SAR testing is not required.
- (f) For LTE Band 12/26 the maximum bandwidth does not support three non-overlapping channels, when a device supports overlapping channel assignment in a channel bandwidth configuration, the middle channel of the group of overlapping channels should be selected for testing.
- (g) LTE band 17/2/5/38/4 SAR test was covered by Band 12/25/26/41/66; according to TCB workshop, SAR test for overlapping LTE bands can be reduced if
  - The maximum output power, including tolerance, for the smaller band is  $\leq$  the larger band to qualify for the SAR test exclusion.
  - The channel bandwidth and other operating parameters for the smaller band are fully supported by the larger band.

### 11.6.1 LTE Carrier Aggregation Conducted Power (Downlink)

Uplink maximum output power measurement with downlink carrier aggregation active should be measured, using the highest output channel measured without downlink carrier aggregation, to confirm that uplink maximum output power with downlink carrier aggregation active remains within the specified tune-up tolerance limits and not more than ¼ dB higher than the maximum output measured without downlink carrier aggregation active.

### 11.6.2 LTE Carrier Aggregation Conducted Power (Uplink)

UL CA shall be tested based on the worst-case SAR configuration determined from non-CA SAR testing result. The channel BW, channel number, RB allocation, etc. would be selected to allow contiguous CA of PCC and SCC. Uplink output power for UL CA is the total power measured across the PCC and SCC.

UL CA power measurements were performed for each antennas at with QPSK modulation based on the worst-case standalone SAR.

The UL CA mode power measurements represent the total power across both carriers. Measurements were made for all supported PCC bandwidths using the channel/RB combination resulting in the highest standalone output power at the least MPR (0 dB). SCCs were set to use configurations similar to the PCC to establish conservative or worst case equivalent SAR test conditions (highest maximum power with MPR of 0 dB).

The standalone power measurement is the power for the PCC in the non-CA mode (i.e. single carrier power). In all cases the UL CA power is less than or equal to the standalone power.

### 11.6.3 LTE TDD Considerations

Time-Division Duplex (TDD) systems, SAR must be tested using a fixed periodic duty factor according to the highest transmission duty factor implemented for the device and supported by the defined 3GPP LTE TDD configurations.

SAR was tested with the highest transmission duty factor (63.33%) using Uplink-downlink configuration 0 and Special sub-frame configuration 7.

Table 11.6.3-1 Calculated Duty Cycle for LTE TDD

Uplink-Downlink Configuration		Sub-frame Number										Calculated
Config	Periodicity	1	2	3	4	5	6	7	8	9	10	Duty Cycle (%)
0	5 ms	D	S	U	U	U	D	S	U	U	U	63.33
1	5 ms	D	S	U	U	D	D	S	U	U	D	43.33
2	5 ms	D	S	U	D	D	D	S	U	D	D	23.33
3	10 ms	D	S	U	U	U	D	D	D	D	D	31.67
4	10 ms	D	S	U	U	D	D	D	D	D	D	21.67
5	10 ms	D	S	U	D	D	D	D	D	D	D	11.67



6	5 ms	D	S	U	U	U	D	S	U	U	D	53.33
---	------	---	---	---	---	---	---	---	---	---	---	-------

Example for Calculated Duty Cycle for Uplink-Downlink Configuration 0:

$$\text{Calculated Duty Cycle} = (5120 \times T_s \times 2 + 6 \text{ ms}) / 10\text{ms} = 63.33\%$$

Where

$$T_s = 1/(15000 \times 2048) \text{ seconds}$$

### 11.7 Bluetooth & Wi-Fi Measurement Procedures

Normal network operating configurations are not suitable for measuring the SAR of IEEE 802.11 transmitters in general. Unpredictable fluctuations in network traffic and antenna diversity conditions can introduce undesirable variations in SAR results. The SAR for these devices should be measured using chipset based test mode software to ensure that the results are consistent and reliable.

Chipset based test mode software is hardware dependent and generally varies among manufacturers. The device operating parameters established in a test mode for SAR measurements must be identical to those programmed in production units, including output power levels, amplifier gain settings and other RF performance tuning parameters. The test frequencies should correspond to actual channel frequencies defined for domestic use. SAR for devices with switched diversity should be measured with only one antenna transmitting at a time during each SAR measurement, according to a fixed modulation and data rate. The same data pattern should be used for all measurements.

### 11.8 Area Scan Based 1g SAR

According to the KDB447498 D01, a first class of fast SAR techniques is based on a modified measurement procedure and post processing algorithms. In practice, these methods require a special software, for example DASYS2 form SPEAG.

When the implementation is based the specific polynomial fit algorithm as presented at the 29th Bio-electromagnetics Society meeting (2007) and the estimated 1-g SAR is  $\leq 1.2$  W/kg, a zoom scan measurement is not required provided it is also not needed for any other purpose; for example, if the peak SAR location required for simultaneous transmission SAR test exclusion can be determined accurately by the SAR system or manually to discriminate between distinctive peaks and scattered noisy SAR distributions from area scans.

There must not be any warning or alert messages due to various measurement concerns identified by the SAR system; for example, noise in measurements, peaks too close to scan boundary, peaks are too sharp, spatial resolution and uncertainty issues etc. When all the SAR results for each exposure condition in a frequency band and wireless mode are based on estimated 1-g SAR, the 1-g SAR for the highest SAR configuration must be determined by a zoom scan.

The approach is based on the area scan measurement applying a frequency dependent attenuation parameter. This attenuation parameter was empirically determined by analyzing a large number of phones. The MOTOROLA FAST SAR was developed and validated by the MOTOROLA Research Group in Ft. Lauderdale.

In the initial study, an approximation algorithm based on Linear fit was developed. The accuracy of the algorithm has been demonstrated across a broad frequency range (136-2450 MHz) and for both 1-g and 10-g averaged SAR using a sample of 264 SAR measurements from 55 wireless handsets. For the sample size studied, the root-mean-squared errors of the algorithm are 1.2% and 5.8% for 1- and 10-g averaged SAR, respectively. The paper describing the algorithm in detail is expected to be published in August 2004 within the Special Issue of Transactions on MTT.

In the second step, the same research group optimized the fitting algorithm to an Polynomial fit whereby the frequency validity was extended to cover the range 30MHz-6000MHz. Details of this study can be found in the BEMS 2007 Proceedings.

## 12 Simultaneous Transmission SAR Considerations

### 12.1 Reference Document

The following procedures adopted from “FCC SAR Considerations for Cell Phones with Multiple Transmitters” are applicable to handsets with built-in unlicensed transmitters such as IEEE 802.11 a/b/g/n/ac/ax and Bluetooth devices which may simultaneously transmit with the licensed transmitter.

### 12.2 Antenna Separation Distances

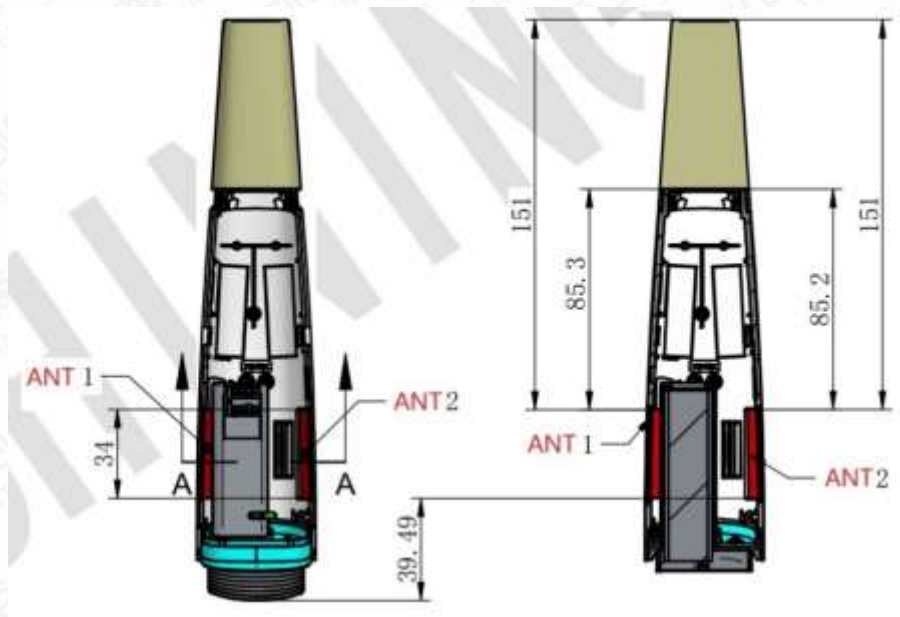

Figure 12.2-1 Antenna Locations(Front View)

### 12.3 SAR Measurement Positions

The edges with less than 2.5 cm distance to the antennas need to be tested for SAR.

Table 12.3-1: SAR measurement Positions

Antenna	Mode	Front	Back	Left	Right	Top	Bottom
ANT1	Body SAR	Yes	Yes	Yes	Yes	No	No
ANT2							
ANT1	Head SAR	Yes	Yes	Yes	Yes	Yes	No
ANT2							

### 12.4 Low Power Transmitters SAR Consideration

Standalone 1-g head or body SAR evaluation by measurement or numerical simulation for low power transmitters is not required when the corresponding SAR Exclusion Threshold condition, listed below, is satisfied.

The 1-g SAR test exclusion threshold for 100 MHz to 6 GHz at test separation distances  $\leq 50$  mm are determined by:

$$\frac{(\text{max. power of channel, including tune – up tolerance, mW})}{(\text{min. test separation distance, mm})} \times \sqrt{\text{Frequency(GHz)}} \leq 3.0$$

Where:

- Frequency (GHz) is the RF channel transmit frequency in GHz
- Power and distance are rounded to the nearest mW and mm before calculation
- The result is rounded to one decimal place for comparison

According to the KDB447498 appendix A, the SAR test exclusion threshold for 2450MHz at 5mm test separation distances is 10mW. That means the transmitters with tune-up power below 10mW are excluded for SAR measurement.

## 12.5 Simultaneous Transmission Analysis

KDB 447498 D01 General RF Exposure Guidance introduces a new formula for calculating the SPLSR (SAR to Peak Location Ratio) between pairs of simultaneously transmitting antennas:

$$\text{SPLSR} = \sqrt{(\text{SAR1} + \text{SAR2})^3 / R_i}$$

Where:

- SAR1 is the highest measured or estimated SAR for the first of a pair of simultaneous transmitting antennas, in a specific test operating mode and exposure condition.
- SAR2 is the highest measured or estimated SAR for the second of a pair of simultaneous transmitting antennas, in the same test operating mode and exposure condition as the first.
- $R_i$  is the separation distance between the pair of simultaneous transmitting antennas. When the SAR is measured, for both antennas in the pair, it is determined by the actual x, y and z coordinates in the 1-g SAR for each SAR peak location, based on the extrapolated and interpolated result in the zoom scan measurement, using the formula of

$$(x_1 - x_2)^2 + (y_1 - y_2)^2 + (z_1 - z_2)^2$$

In order for a pair of simultaneous transmitting antennas with the sum of 1-g SAR > 1.6 W/kg to qualify for exemption from Simultaneous Transmission SAR measurements, it has to satisfy the condition of:

$$\sqrt{(\text{SAR1} + \text{SAR2})^3 / R_i} < 0.04$$

### 13 Conducted Output Power

#### 13.1 Wi-Fi Measurement result

Table 13.1-1: The average conducted power for Wi-Fi 5G ANT1

ANT1			Wi-Fi 5G conducted power(dBm)	
Mode	BW	Channel/Frequency(MHz)	Tune up	Output Power
802.11a	20M	36/5180	4.50	3.99
		40/5200	4.50	3.40
		48/5240	4.50	3.41
		52/5260	4.50	3.56
		60/5300	4.50	3.73
		64/5320	4.50	3.66
		100/5500	6.00	5.62
		120/5600	5.50	4.44
		140/5700	4.50	3.72
		149/5745	6.00	5.10
		157/5785	5.50	4.46
		165/5825	5.50	4.31
802.11n	20M	36/5180	4.50	2.61
		40/5200	3.50	1.89
		48/5240	3.00	2.20
		52/5260	3.00	1.12
		60/5300	2.00	1.47
		64/5320	3.00	1.53
		100/5500	5.00	3.33
		120/5600	5.00	3.15
		140/5700	4.00	3.81
		149/5745	4.50	3.65
		157/5785	4.00	2.97
		165/5825	4.00	2.53
	40M	38/5190	2.50	0.87
		46/5230	1.00	0.16
		54/5270	2.50	1.93

		62/5310	2.00	0.31
		102/5510	4.50	2.71
		118/5590	4.50	2.66
		134/5670	4.50	2.81
		151/5755	2.50	0.84
		159/5795	2.00	0.27
802.11ac	20M	36/5180	4.50	4.41
		40/5200	4.50	3.60
		48/5240	4.50	3.87
		52/5260	4.00	2.57
		60/5300	3.50	3.10
		64/5320	3.50	3.24
		100/5500	6.00	5.18
		120/5600	5.50	5.21
		140/5700	4.50	4.15
		149/5745	5.50	5.38
		157/5785	5.00	4.62
		165/5825	5.00	4.49
	40M	38/5190	4.00	3.41
		46/5230	4.00	3.19
		54/5270	3.00	2.09
		62/5310	3.00	2.45
		102/5510	6.00	5.45
		118/5590	5.50	3.92
		134/5670	4.50	4.19
		151/5755	4.50	3.80
		159/5795	4.00	3.37
	80M	42/5210	1.50	-0.15
		58/5290	1.50	-0.33
		106/5530	4.00	2.34
		122/5610	4.00	2.15
		138/5690	3.50	1.98
		155/5775	2.50	0.70

802.11ax	20M	36/5180	4.50	4.31
		40/5200	4.50	3.59
		48/5240	4.50	3.86
		52/5260	4.00	2.76
		60/5300	3.50	3.00
		64/5320	4.00	3.27
		100/5500	6.00	5.17
		120/5600	5.50	4.92
		140/5700	4.50	4.32
		149/5745	5.50	5.22
		157/5785	5.00	4.54
		165/5825	5.00	4.11
	40M	38/5190	4.00	3.32
		46/5230	4.00	2.91
		54/5270	3.00	2.38
		62/5310	3.50	2.55
		102/5510	5.50	5.15
		118/5590	5.50	5.09
		134/5670	5.50	5.13
		151/5755	4.50	3.66
	159/5795	3.50	2.63	
	80M	42/5210	2.00	0.40
		58/5290	1.50	0.02
		106/5530	4.50	2.73
		122/5610	4.50	2.58
		138/5690	4.00	2.66
		155/5775	2.00	0.76

Table 13.1-2: The average conducted power for Wi-Fi 5G ANT2

ANT2			Wi-Fi 5G conducted power(dBm)	
Mode	BW	Channel/Frequency(MHz)	Tune up	Output Power
802.11a	20M	36/5180	5.00	4.10
		40/5200	3.00	2.21



		48/5240	3.00	2.17
		52/5260	4.50	3.44
		60/5300	4.50	3.32
		64/5320	4.50	3.37
		100/5500	7.50	6.92
		120/5600	6.00	5.44
		140/5700	4.00	3.61
		149/5745	3.00	1.89
		157/5785	2.00	0.86
		165/5825	3.00	1.49
802.11n	20M	36/5180	2.50	0.99
		40/5200	2.50	0.79
		48/5240	4.00	3.23
		52/5260	3.50	1.73
		60/5300	3.00	2.17
		64/5320	4.00	2.14
		100/5500	6.00	4.09
		120/5600	5.00	3.31
		140/5700	2.50	1.76
		149/5745	1.50	0.76
		157/5785	1.00	-0.55
		165/5825	1.00	-0.34
	40M	38/5190	1.50	-0.09
		46/5230	1.00	-0.78
		54/5270	2.50	1.51
		62/5310	2.00	0.43
		102/5510	4.00	2.44
		118/5590	4.00	2.36
		134/5670	3.50	1.61
		151/5755	1.00	-1.90
	159/5795	1.00	-1.39	
	802.11ac	20M	36/5180	3.50
40/5200			3.00	2.40

		48/5240	3.00	2.33
		52/5260	4.00	3.09
		60/5300	4.00	3.73
		64/5320	4.00	3.20
		100/5500	7.00	5.56
		120/5600	6.00	4.91
		140/5700	4.00	3.31
		149/5745	3.00	2.09
		157/5785	2.00	0.94
		165/5825	2.00	1.14
	40M	38/5190	3.00	2.40
		46/5230	3.00	2.38
		54/5270	4.00	2.71
		62/5310	4.00	3.20
		102/5510	6.00	5.23
		118/5590	6.00	5.12
		134/5670	4.00	3.16
		151/5755	2.00	1.74
	80M	159/5795	2.00	1.14
		42/5210	0.50	-1.31
		58/5290	1.50	-0.07
		106/5530	3.50	1.51
		122/5610	3.00	1.40
		138/5690	3.00	1.07
802.11ax	20M	155/5775	0.00	-1.66
		36/5180	4.00	2.69
		40/5200	3.00	2.64
		48/5240	3.00	2.23
		52/5260	4.00	3.40
		60/5300	4.00	3.75
		64/5320	4.00	3.78
		100/5500	7.00	5.78
120/5600	6.00	5.01		

		140/5700	4.00	3.17
		149/5745	3.00	1.77
		157/5785	2.00	0.72
		165/5825	2.00	1.41
	40M	38/5190	3.00	2.18
		46/5230	3.00	1.96
		54/5270	4.00	2.96
		62/5310	4.00	3.33
		102/5510	5.50	4.81
		118/5590	5.50	4.61
		134/5670	4.00	3.80
		151/5755	2.00	1.13
	80M	159/5795	1.50	0.52
		42/5210	1.00	-1.01
		58/5290	1.50	0.22
		106/5530	3.50	1.90
		122/5610	3.50	1.71
		138/5690	3.00	1.29
		155/5775	0.50	-1.32

Table 13.1-3: The average conducted power for Wi-Fi 5G MIMO

MIMO			Wi-Fi 5G conducted power(dBm)	
Mode	BW	Channel/Frequency(MHz)	Tune up	Output Power
802.11a	20M	36/5180	6.50	5.97
		40/5200	6.50	6.11
		48/5240	5.00	4.53
		52/5260	6.50	5.89
		60/5300	5.00	4.28
		64/5320	6.50	6.11
		100/5500	8.50	8.33
		120/5600	7.50	7.15
		140/5700	7.00	6.16
		149/5745	6.50	6.34

		157/5785	6.00	5.43	
		165/5825	6.00	5.06	
802.11n	20M	36/5180	6.50	6.19	
		40/5200	6.00	5.18	
		48/5240	5.50	4.91	
		52/5260	6.00	5.61	
		60/5300	5.50	5.04	
		64/5320	6.50	5.91	
		100/5500	8.50	8.42	
		120/5600	8.00	7.45	
		140/5700	6.00	5.85	
		149/5745	6.00	5.95	
	157/5785	5.50	5.30		
	165/5825	5.50	5.15		
		40M	38/5190	5.00	5.22
			46/5230	4.00	3.82
			54/5270	5.50	5.31
			62/5310	4.50	4.31
	102/5510		7.00	6.95	
	118/5590		7.00	6.66	
802.11ac	20M	36/5180	7.00	6.70	
		40/5200	6.50	5.62	
		48/5240	5.50	5.24	
		52/5260	7.00	6.65	
		60/5300	5.50	5.34	
		64/5320	6.50	6.22	
		100/5500	9.50	9.06	
		120/5600	8.50	7.15	
		140/5700	7.00	6.70	
				149/5745	6.50

		157/5785	6.00	5.41	
		165/5825	6.00	5.27	
	40M	38/5190	6.50	5.83	
		46/5230	6.00	5.20	
		54/5270	6.50	6.24	
		62/5310	5.50	5.10	
		102/5510	9.00	8.65	
		118/5590	8.50	8.45	
		134/5670	7.00	5.96	
		151/5755	5.50	5.03	
		159/5795	5.50	5.01	
		80M	42/5210	4.00	3.36
	58/5290		4.50	4.11	
	106/5530		6.50	6.21	
	122/5610		6.50	5.78	
	138/5690		6.00	5.31	
155/5775	4.00		3.41		
802.11ax	20M	36/5180	7.00	6.97	
		40/5200	6.50	6.48	
		48/5240	6.00	5.44	
		52/5260	7.00	6.95	
		60/5300	6.00	5.63	
		64/5320	7.00	6.52	
		100/5500	9.50	8.71	
		120/5600	8.50	8.30	
		140/5700	7.00	5.93	
		149/5745	7.00	6.52	
		157/5785	6.50	5.56	
		165/5825	6.00	5.23	
		40M	38/5190	6.50	6.45
			46/5230	5.50	4.91
	54/5270		6.50	5.77	
	62/5310		5.50	4.71	

		102/5510	8.50	8.15
		118/5590	8.50	8.06
		134/5670	7.50	6.43
		151/5755	5.50	5.03
		159/5795	5.50	5.02
	80M	42/5210	4.50	3.74
		58/5290	4.50	4.26
		106/5530	7.00	6.41
		122/5610	7.00	5.54
		138/5690	6.50	5.68
		155/5775	4.00	3.73

## 14 Test Results

### 14.1 Standalone SAR Test Result

#### 14.1.1 Limit/Criterion

At frequencies between 100 kHz and 6 GHz, the MPE (Maximum Permissible Exposure) in population/uncontrolled environments for electromagnetic field strengths may be exceeded if

- (a) The exposure conditions can be shown by appropriate techniques to produce SARs below 0.08W/kg, as averaged over the whole body, and spatial peak SAR values not exceeding 1.6 W/kg, as averaged over any 1g of tissue (defined as a tissue volume in the shape of a cube), except for the hands, wrists, feet, and ankles where the spatial peak SAR shall not exceed 4 W/kg, as averaged over any 10g of tissue (defined as a tissue volume in the shape of a cube); and
- (b) The induced currents in the body confirm with the MPE in table 2, Part B in ANSI/IEEE C95.1-1992.

## 14.1.2 Test Results

Table 14.1.2-1: SAR Values for Wi-Fi 5G U-NII-1 ANT1

Test Position	Cover Type	Mode	BW(MHz)	Duty Cycle(%)	Channel	Frequency (MHz)	Measured power (dBm)	Tune-up (dBm)	Power Drift (dB)	Limit of 1gSAR 1.6 W/kg (mW/g)			Figure No.
										Measured SAR1g	Scaling Factor	Report SAR1g	
Head SAR (0mm)													
Front Side	Standard	802.11a	20	74.82%	36	5180	3.99	4.50	0.00	0.000	1.12	0.000	/
Back Side	Standard	802.11a	20	74.82%	36	5180	3.99	4.50	0.00	0.000	1.12	0.000	/
Left Side	Standard	802.11a	20	74.82%	36	5180	3.99	4.50	0.00	0.224	1.12	0.337	A.1-1
Right Side	Standard	802.11a	20	74.82%	36	5180	3.99	4.50	0.00	0.000	1.12	0.000	/
Top Side	Standard	802.11a	20	74.82%	36	5180	3.99	4.50	0.00	0.000	1.12	0.000	/
Body SAR (0mm)													
Front Side	Standard	802.11a	20	74.82%	36	5180	3.99	4.50	0.00	0.000	1.12	0.000	/
Back Side	Standard	802.11a	20	74.82%	36	5180	3.99	4.50	0.00	0.000	1.12	0.000	/
Left Side	Standard	802.11a	20	74.82%	36	5180	3.99	4.50	0.00	0.429	1.12	0.645	A.1-2
Right Side	Standard	802.11a	20	74.82%	36	5180	3.99	4.50	0.00	0.000	1.12	0.000	/

Table 14.1.2-2: SAR Values for Wi-Fi 5G U-NII-1 ANT2

Test Position	Cover Type	Mode	BW(MHz)	Duty Cycle(%)	Channel	Frequency (MHz)	Measured power (dBm)	Tune-up (dBm)	Power Drift (dB)	Limit of 1gSAR 1.6 W/kg (mW/g)			Figure No.
										Measured SAR1g	Scaling Factor	Report SAR1g	
Head SAR (0mm)													
Front Side	Standard	802.11a	20	74.87%	36	5180	4.10	5.00	0.00	0.000	1.23	0.000	/
Back Side	Standard	802.11a	20	74.87%	36	5180	4.10	5.00	0.00	0.000	1.23	0.000	/
Left Side	Standard	802.11a	20	74.87%	36	5180	4.10	5.00	0.00	0.000	1.23	0.000	/
Right Side	Standard	802.11a	20	74.87%	36	5180	4.10	5.00	0.00	0.310	1.23	0.509	A.1-3
Top Side	Standard	802.11a	20	74.87%	36	5180	4.10	5.00	0.00	0.000	1.23	0.000	/
Body SAR (0mm)													
Front Side	Standard	802.11a	20	74.87%	36	5180	4.10	5.00	0.00	0.000	1.23	0.000	/
Back Side	Standard	802.11a	20	74.87%	36	5180	4.10	5.00	0.00	0.000	1.23	0.000	/
Left Side	Standard	802.11a	20	74.87%	36	5180	4.10	5.00	0.00	0.000	1.23	0.000	/
Right Side	Standard	802.11a	20	74.87%	36	5180	4.10	5.00	0.00	0.495	1.23	0.813	A.1-4
Right Side	Standard	802.11a	20	74.89%	40	5200	2.21	3.00	0.00	0.434	1.20	0.695	/
Right Side	Standard	802.11a	20	74.87%	48	5240	2.17	3.00	0.00	0.321	1.21	0.519	/

Table 14.1.2-3: SAR Values for Wi-Fi 5G U-NII-2A ANT1

Test Position	Cover Type	Mode	BW(MHz)	Duty Cycle(%)	Channel	Frequency (MHz)	Measured power (dBm)	Tune-up (dBm)	Power Drift (dB)	Limit of 1gSAR 1.6 W/kg (mW/g)			Figure No.
										Measured SAR1g	Scaling Factor	Report SAR1g	
Head SAR (0mm)													
Front Side	Standard	802.11a	20	74.91%	60	5300	3.73	4.50	0.00	0.000	1.19	0.000	/
Back Side	Standard	802.11a	20	74.91%	60	5300	3.73	4.50	0.00	0.000	1.19	0.000	/
Left Side	Standard	802.11a	20	74.91%	60	5300	3.73	4.50	0.00	0.211	1.19	0.336	A.1-5
Right Side	Standard	802.11a	20	74.91%	60	5300	3.73	4.50	0.00	0.000	1.19	0.000	/
Top Side	Standard	802.11a	20	74.91%	60	5300	3.73	4.50	0.00	0.000	1.19	0.000	/
Body SAR (0mm)													
Front Side	Standard	802.11a	20	74.91%	60	5300	3.73	4.50	0.00	0.000	1.19	0.000	/
Back Side	Standard	802.11a	20	74.91%	60	5300	3.73	4.50	0.00	0.000	1.19	0.000	/
Left Side	Standard	802.11a	20	74.91%	60	5300	3.73	4.50	0.00	0.380	1.19	0.606	A.1-6
Right Side	Standard	802.11a	20	74.91%	60	5300	3.73	4.50	0.00	0.000	1.19	0.000	/



Table 14.1.2-4: SAR Values for Wi-Fi 5G U-NII-2A ANT2

Test Position	Cover Type	Mode	BW(MHz)	Duty Cycle(%)	Channel	Frequency (MHz)	Measured power (dBm)	Tune-up (dBm)	Power Drift (dB)	Limit of 1gSAR 1.6 W/kg (mW/g)			Figure No.
										Measured SAR1g	Scaling Factor	Report SAR1g	
<b>Head SAR (0mm)</b>													
Front Side	Standard	802.11a	20	74.84%	52	5260	3.44	4.50	0.00	0.000	1.28	0.000	/
Back Side	Standard	802.11a	20	74.84%	52	5260	3.44	4.50	0.00	0.000	1.28	0.000	/
Left Side	Standard	802.11a	20	74.84%	52	5260	3.44	4.50	0.00	0.000	1.28	0.000	/
Right Side	Standard	802.11a	20	74.84%	52	5260	3.44	4.50	0.00	0.334	1.28	0.570	A.1-7
Top Side	Standard	802.11a	20	74.84%	52	5260	3.44	4.50	0.00	0.000	1.28	0.000	/
<b>Body SAR (0mm)</b>													
Front Side	Standard	802.11a	20	74.84%	52	5260	3.44	4.50	0.00	0.000	1.28	0.000	/
Back Side	Standard	802.11a	20	74.84%	52	5260	3.44	4.50	0.00	0.000	1.28	0.000	/
Left Side	Standard	802.11a	20	74.84%	52	5260	3.44	4.50	0.00	0.000	1.28	0.000	/
Right Side	Standard	802.11a	20	74.84%	52	5260	3.44	4.50	0.00	0.468	1.28	0.798	A.1-8

Table 14.1.2-5: SAR Values for Wi-Fi 5G U-NII-2C ANT1

Test Position	Cover Type	Mode	BW(MHz)	Duty Cycle(%)	Channel	Frequency (MHz)	Measured power (dBm)	Tune-up (dBm)	Power Drift (dB)	Limit of 1gSAR 1.6 W/kg (mW/g)			Figure No.
										Measured SAR1g	Scaling Factor	Report SAR1g	
<b>Head SAR (0mm)</b>													
Front Side	Standard	802.11a	20	74.91%	100	5500	5.62	6.00	0.00	0.000	1.09	0.000	/
Back Side	Standard	802.11a	20	74.91%	100	5500	5.62	6.00	0.00	0.000	1.09	0.000	/
Left Side	Standard	802.11a	20	74.91%	100	5500	5.62	6.00	0.00	0.379	1.09	0.552	A.1-9
Right Side	Standard	802.11a	20	74.91%	100	5500	5.62	6.00	0.00	0.000	1.09	0.000	/
Top Side	Standard	802.11a	20	74.91%	100	5500	5.62	6.00	0.00	0.000	1.09	0.000	/
<b>Body SAR (0mm)</b>													
Front Side	Standard	802.11a	20	74.91%	100	5500	5.62	6.00	0.00	0.00	1.09	0.000	/
Back Side	Standard	802.11a	20	74.91%	100	5500	5.62	6.00	0.00	0.00	1.09	0.000	/
Left Side	Standard	802.11a	20	74.91%	100	5500	5.62	6.00	0.00	0.705	1.09	1.027	/
Right Side	Standard	802.11a	20	74.91%	100	5500	5.62	6.00	0.00	0.00	1.09	0.000	/
Left Side	Standard	802.11a	20	74.84%	120	5600	4.44	5.50	-0.10	0.751	1.28	1.281	/
Left Side	Standard	802.11a	20	74.87%	140	5700	3.72	4.50	0.00	0.764	1.20	1.221	A.1-10

Table 14.1.2-6: SAR Values for Wi-Fi 5G U-NII-2C ANT2

Test Position	Cover Type	Mode	BW(MHz)	Duty Cycle(%)	Channel	Frequency (MHz)	Measured power (dBm)	Tune-up (dBm)	Power Drift (dB)	Limit of 1gSAR 1.6 W/kg (mW/g)			Figure No.
										Measured SAR1g	Scaling Factor	Report SAR1g	
<b>Head SAR (0mm)</b>													
Front Side	Standard	802.11a	20	74.98%	100	5500	6.92	7.50	0.00	0.000	1.14	0.000	/
Back Side	Standard	802.11a	20	74.98%	100	5500	6.92	7.50	0.00	0.000	1.14	0.000	/
Left Side	Standard	802.11a	20	74.98%	100	5500	6.92	7.50	0.00	0.000	1.14	0.000	/
Right Side	Standard	802.11a	20	74.98%	100	5500	6.92	7.50	-0.12	0.392	1.14	0.598	A.1-11
Top Side	Standard	802.11a	20	74.98%	100	5500	6.92	7.50	0.00	0.000	1.14	0.000	/
<b>Body SAR (0mm)</b>													
Front Side	Standard	802.11a	20	74.98%	100	5500	6.92	7.50	0.00	0.000	1.14	0.000	/
Back Side	Standard	802.11a	20	74.98%	100	5500	6.92	7.50	0.00	0.000	1.14	0.000	/
Left Side	Standard	802.11a	20	74.98%	100	5500	6.92	7.50	0.00	0.000	1.14	0.000	/
Right Side	Standard	802.11a	20	74.98%	100	5500	6.92	7.50	0.00	0.914	1.14	1.393	/
Right Side	Standard	802.11a	20	84.85%	120	5600	5.44	6.00	0.00	0.948	1.14	1.271	A.1-12
Right Side	Standard	802.11a	20	74.87%	140	5700	3.61	4.00	0.00	0.781	1.09	1.141	/
<b>repeat</b>													
Right Side	Standard	802.11a	20	84.85%	120	5600	5.44	6.00	0.00	0.904	1.14	1.212	/

Table 14.1.2-7: SAR Values for Wi-Fi 5G U-NII-3 ANT1

Test Position	Cover Type	Mode	BW(MHz)	Duty Cycle(%)	Channel	Frequency (MHz)	Measured power (dBm)	Tune-up (dBm)	Power Drift (dB)	Limit of 1gSAR 1.6 W/kg (mW/g)			Figure No.
										Measured SAR1g	Scaling Factor	Report SAR1g	
Head SAR (0mm)													
Front Side	Standard	802.11a	20	74.88%	149	5745	5.10	5.50	0.00	0.000	1.10	0.000	/
Back Side	Standard	802.11a	20	74.88%	149	5745	5.10	5.50	0.00	0.000	1.10	0.000	/
Left Side	Standard	802.11a	20	74.88%	149	5745	5.10	5.50	0.00	0.406	1.10	0.595	A.1-13
Right Side	Standard	802.11a	20	74.88%	149	5745	5.10	5.50	0.00	0.000	1.10	0.000	/
Top Side	Standard	802.11a	20	74.88%	149	5745	5.10	5.50	0.00	0.000	1.10	0.000	/
Body SAR (0mm)													
Front Side	Standard	802.11a	20	74.88%	149	5745	5.10	5.50	0.00	0.000	1.10	0.000	/
Back Side	Standard	802.11a	20	74.88%	149	5745	5.10	5.50	0.00	0.000	1.10	0.000	/
Left Side	Standard	802.11a	20	74.88%	149	5745	5.10	5.50	0.00	0.866	1.10	1.268	A.1-14
Right Side	Standard	802.11a	20	74.88%	149	5745	5.10	5.50	0.00	0.000	1.10	0.000	/
Left Side	Standard	802.11a	20	74.90%	157	5785	4.46	5.50	0.00	0.754	1.27	1.279	/
Left Side	Standard	802.11a	20	74.86%	165	5825	4.31	5.00	0.00	0.814	1.17	1.275	/
repeat													
Left Side	Standard	802.11a	20	74.88%	149	5745	5.10	5.50	0.00	0.821	1.10	1.202	/

Table 14.1.2-8: SAR Values for Wi-Fi 5G U-NII-3 ANT2

Test Position	Cover Type	Mode	BW(MHz)	Duty Cycle(%)	Channel	Frequency (MHz)	Measured power (dBm)	Tune-up (dBm)	Power Drift (dB)	Limit of 1gSAR 1.6 W/kg (mW/g)			Figure No.
										Measured SAR1g	Scaling Factor	Report SAR1g	
Head SAR (0mm)													
Front Side	Standard	802.11a	20	74.81%	149	5745	1.89	3.00	0.00	0.000	1.29	0.000	/
Back Side	Standard	802.11a	20	74.81%	149	5745	1.89	3.00	0.00	0.000	1.29	0.000	/
Left Side	Standard	802.11a	20	74.81%	149	5745	1.89	3.00	0.00	0.000	1.29	0.000	/
Right Side	Standard	802.11a	20	74.81%	149	5745	1.89	3.00	0.00	0.245	1.29	0.423	A.1-15
Top Side	Standard	802.11a	20	74.81%	149	5745	1.89	3.00	0.00	0.000	1.29	0.000	/
Body SAR (0mm)													
Front Side	Standard	802.11a	20	74.81%	149	5745	1.89	3.00	0.00	0.000	1.29	0.000	/
Back Side	Standard	802.11a	20	74.81%	149	5745	1.89	3.00	0.00	0.000	1.29	0.000	/
Left Side	Standard	802.11a	20	74.81%	149	5745	1.89	3.00	0.00	0.000	1.29	0.000	/
Right Side	Standard	802.11a	20	74.81%	149	5745	1.89	3.00	0.00	0.471	1.29	0.813	A.1-16
Right Side	Standard	802.11a	20	74.85%	157	5785	0.86	2.00	0.00	0.390	1.30	0.677	/
Right Side	Standard	802.11a	20	74.80%	165	5825	1.49	3.00	0.00	0.337	1.42	0.638	/

Table 14.1.2-9: SAR Values for Wi-Fi 5G MIMO

Position\Report SAR <sub>1g</sub>		ANT1					ANT2					MIMO MAX. SAR <sub>1g</sub>
		Wi-Fi5G U-NII-1	Wi-Fi5G U-NII-2A	Wi-Fi5G U-NII-2C	Wi-Fi5G U-NII-3	MAX.	Wi-Fi5G U-NII-1	Wi-Fi5G U-NII-2A	Wi-Fi5G U-NII-2C	Wi-Fi5G U-NII-3	MAX.	
Head SAR (0mm)	Front Side	0.000	0.000	0.000	0.000	0.000	0.000	0.000	0.000	0.000	0.000	0.000
	Back Side	0.000	0.000	0.000	0.000	0.000	0.000	0.000	0.000	0.000	0.000	0.000
	Left Side	0.337	0.336	0.552	0.595	0.595	0.000	0.000	0.000	0.000	0.000	0.595
	Right Side	0.000	0.000	0.000	0.000	0.000	0.509	0.570	0.598	0.423	0.598	0.598
	Top Side	0.000	0.000	0.000	0.000	0.000	0.000	0.000	0.000	0.000	0.000	0.000
Body SAR (0mm)	Front Side	0.000	0.000	0.000	0.000	0.000	0.000	0.000	0.000	0.000	0.000	0.000
	Back Side	0.000	0.000	0.000	0.000	0.000	0.000	0.000	0.000	0.000	0.000	0.000
	Left Side	0.645	0.606	1.281	1.279	1.281	0.000	0.000	0.000	0.000	0.000	1.281
	Right Side	0.000	0.000	0.000	0.000	0.000	0.813	0.798	1.393	0.813	1.393	1.393

## 14.2 SAR Measurement Variability

SAR measurement variability must be assessed for each frequency band, which is determined by the SAR probe calibration point and tissue-equivalent medium used for the device measurements. When both head and body tissue-equivalent media are required for SAR measurements in a frequency band, the variability measurement procedures should be applied to the tissue medium with the highest measured SAR, using the highest measured SAR configuration for that tissue-equivalent medium.

The following procedures are applied to determine if repeated measurements are required.

- (a) Repeated measurement is not required when the original highest measured SAR is  $< 0.80$  W/kg; steps(b) through (d) do not apply.
- (b) When the original highest measured SAR is  $\geq 0.80$  W/kg, repeat that measurement once.
- (c) Perform a second repeated measurement only if the ratio of largest to smallest SAR for the original and first repeated measurements is  $> 1.20$  or when the original or repeated measurement is  $\geq 1.45$ W/kg ( $\sim 10\%$  from the 1-g SAR limit).
- (d) Perform a third repeated measurement only if the original, first or second repeated measurement is  $\geq 1.5$  W/kg and the ratio of largest to smallest SAR for the original, first and second repeated measurements is  $> 1.20$ .

Table 14.3-1: SAR Measurement Variability (1g)

Frequency		Configuration	Test Position	Original SAR (W/kg)	First Repeated SAR (W/kg)	The Ratio
MHz	Ch.					
5600	120	802.11a	Body:Right Side 0mm	0.948	0.904	1.049
5745	149	802.11a	Body:Left Side 0mm	0.866	0.821	1.055

Note: According to the KDB 865664 D01 repeated measurement is not required when the original highest measured SAR is  $< 0.8$  W/kg.

## Annex A: Measurement Data

### A.1 SAR Graph Results

#### Wi-Fi 5G U-NII-1 11a ANT1 Left Mode Low 0mm Head

Date/Time: 2023/2/25

Electronics: DAE4 Sn1244

Medium parameters used:  $f = 5180$  MHz;  $\sigma = 4.687$  S/m;  $\epsilon_r = 36.163$ ;  $\rho = 1000$  kg/m<sup>3</sup>

Ambient Temperature: 21.4°C      Liquid Temperature: 20.2°C

Communication System: 5GHz U-NII-1 5GHz;      Frequency: 5180 MHz; Duty Cycle: 1:1

Probe: EX3DV4 - SN7633ConvF(5.7, 5.7, 5.7) @ 5180 MHz

#### Wi-Fi 5G U-NII-1 11a ANT1 Left Mode Low 0mm Head/Area Scan (7x19x1):

Measurement grid:  $dx=10$ mm,  $dy=10$ mm

Maximum value of SAR (measured) = 0.497 W/kg

#### Wi-Fi 5G U-NII-1 11a ANT1 Left Mode Low 0mm Head/Zoom Scan (7x7x7)/Cube 0:

Measurement grid:  $dx=4$ mm,  $dy=4$ mm,  $dz=2$ mm

Reference Value = 0 V/m; Power Drift = 0.00 dB

Peak SAR (extrapolated) = 1.11 W/kg

SAR(1 g) = 0.224 W/kg; SAR(10 g) = 0.052 W/kg

Maximum of SAR (measured) = 0.596 W/kg

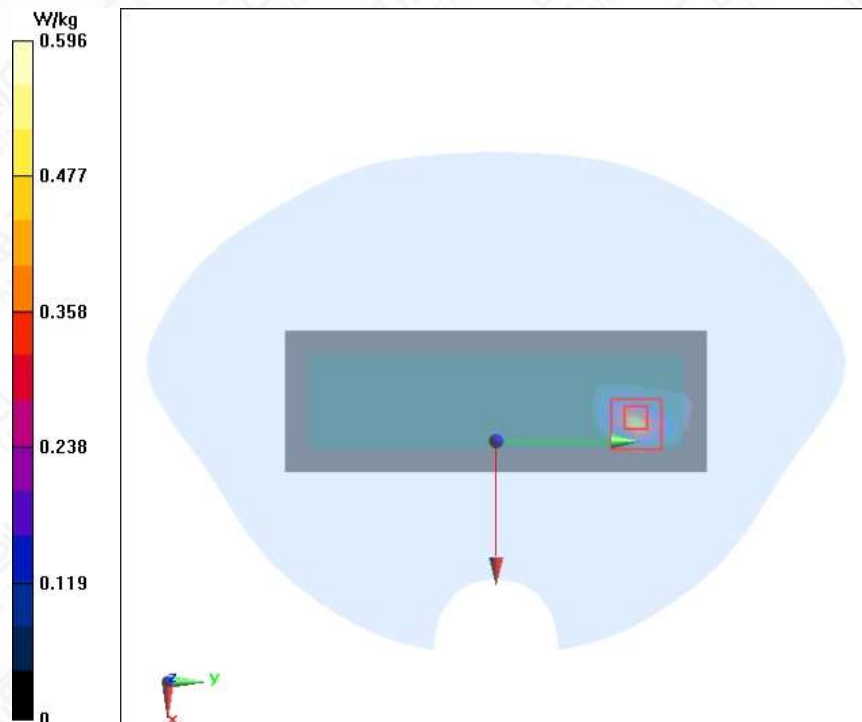

Figure A.1-1 Wi-Fi 5G U-NII-1 11a ANT1 Left Mode Low 0mm Head

**Wi-Fi 5G U-NII-1 11a ANT1 Left Mode Low 0mm Body**

Date/Time: 2023/2/25

Electronics: DAE4 Sn1244

 Medium parameters used:  $f = 5180 \text{ MHz}$ ;  $\sigma = 4.687 \text{ S/m}$ ;  $\epsilon_r = 36.163$ ;  $\rho = 1000 \text{ kg/m}^3$ 

 Ambient Temperature:  $21.4^\circ\text{C}$       Liquid Temperature:  $20.2^\circ\text{C}$ 

Communication System: 5GHz U-NII-1 5GHz;      Frequency: 5180 MHz; Duty Cycle: 1:1

Probe: EX3DV4 - SN7633ConvF(5.7, 5.7, 5.7) @ 5180 MHz

**Wi-Fi 5G U-NII-1 11a ANT1 Left Mode Low 0mm Body/Area Scan (7x19x1):**

 Measurement grid:  $dx=10\text{mm}$ ,  $dy=10\text{mm}$ 

Maximum value of SAR (measured) = 0.909 W/kg

**Wi-Fi 5G U-NII-1 11a ANT1 Left Mode Low 0mm Body/Zoom Scan (7x7x7)/Cube 0:**

 Measurement grid:  $dx=4\text{mm}$ ,  $dy=4\text{mm}$ ,  $dz=2\text{mm}$ 

Reference Value = 0 V/m; Power Drift = 0.00 dB

Peak SAR (extrapolated) = 3.34 W/kg

SAR(1 g) = 0.429 W/kg; SAR(10 g) = 0.0863 W/kg

Maximum of SAR (measured) = 1.15 W/kg

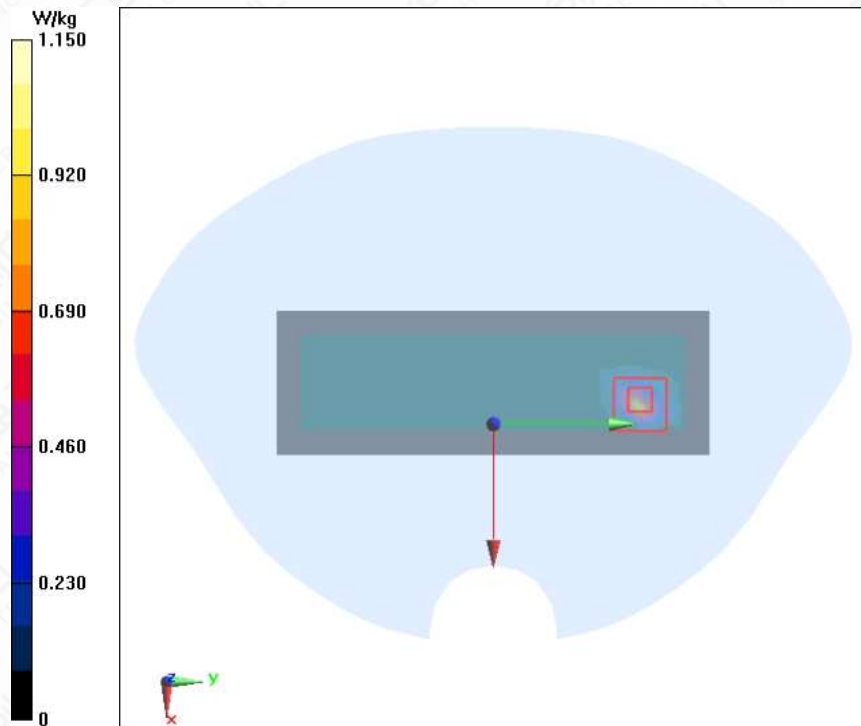

Figure A.1-2 Wi-Fi 5G U-NII-1 11a ANT1 Left Mode Low 0mm Body

**Wi-Fi 5G U-NII-1 11a ANT2 Right Mode Low 0mm Head**

Date/Time: 2023/2/25

Electronics: DAE4 Sn1244

 Medium parameters used:  $f = 5180 \text{ MHz}$ ;  $\sigma = 4.687 \text{ S/m}$ ;  $\epsilon_r = 36.163$ ;  $\rho = 1000 \text{ kg/m}^3$ 

 Ambient Temperature:  $21.4^\circ\text{C}$       Liquid Temperature:  $20.4^\circ\text{C}$ 

Communication System: 5GHz U-NII-1 5GHz;      Frequency: 5180 MHz; Duty Cycle: 1:1

Probe: EX3DV4 - SN7633ConvF(5.7, 5.7, 5.7) @ 5180 MHz

**Wi-Fi 5G U-NII-1 11a ANT2 Right Mode Low 0mm Head/Area Scan (7x19x1):**

 Measurement grid:  $dx=10\text{mm}$ ,  $dy=10\text{mm}$ 

Maximum value of SAR (measured) = 0.581 W/kg

**Wi-Fi 5G U-NII-1 11a ANT2 Right Mode Low 0mm Head/Zoom Scan (7x7x7)/Cube 0:**

 Measurement grid:  $dx=4\text{mm}$ ,  $dy=4\text{mm}$ ,  $dz=2\text{mm}$ 

Reference Value = 0 V/m; Power Drift = 0.00 dB

Peak SAR (extrapolated) = 1.04 W/kg

SAR(1 g) = 0.31 W/kg; SAR(10 g) = 0.0829 W/kg

Maximum of SAR (measured) = 0.790 W/kg

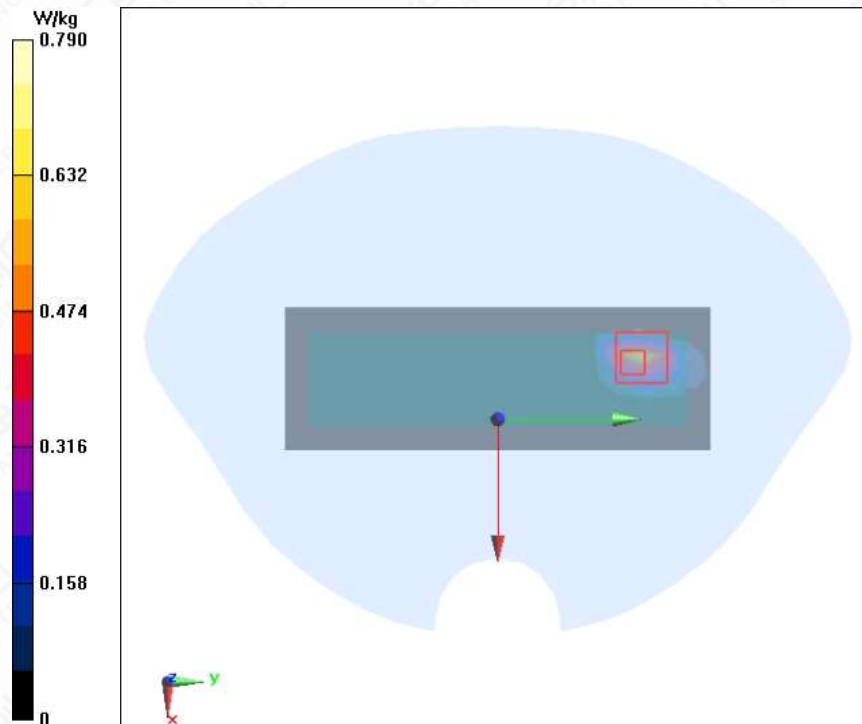

Figure A.1-3 Wi-Fi 5G U-NII-1 11a ANT2 Right Mode Low 0mm Head

**Wi-Fi 5G U-NII-1 11a ANT2 Right Mode Low 0mm Body**

Date/Time: 2023/2/25

Electronics: DAE4 Sn1244

 Medium parameters used:  $f = 5180 \text{ MHz}$ ;  $\sigma = 4.687 \text{ S/m}$ ;  $\epsilon_r = 36.163$ ;  $\rho = 1000 \text{ kg/m}^3$ 

 Ambient Temperature:  $21.3^\circ\text{C}$       Liquid Temperature:  $20.2^\circ\text{C}$ 

Communication System: 5GHz U-NII-1 5GHz;      Frequency: 5180 MHz; Duty Cycle: 1:1

Probe: EX3DV4 - SN7633ConvF(5.7, 5.7, 5.7) @ 5180 MHz

**Wi-Fi 5G U-NII-1 11a ANT2 Right Mode Low 0mm Body/Area Scan (7x19x1):**

 Measurement grid:  $dx=10\text{mm}$ ,  $dy=10\text{mm}$ 

Maximum value of SAR (measured) = 0.864 W/kg

**Wi-Fi 5G U-NII-1 11a ANT2 Right Mode Low 0mm Body/Zoom Scan (7x7x7)/Cube 0:**

 Measurement grid:  $dx=4\text{mm}$ ,  $dy=4\text{mm}$ ,  $dz=2\text{mm}$ 

Reference Value = 0 V/m; Power Drift = 0.00 dB

Peak SAR (extrapolated) = 1.88 W/kg

SAR(1 g) = 0.495 W/kg; SAR(10 g) = 0.111 W/kg

Maximum of SAR (measured) = 1.38 W/kg

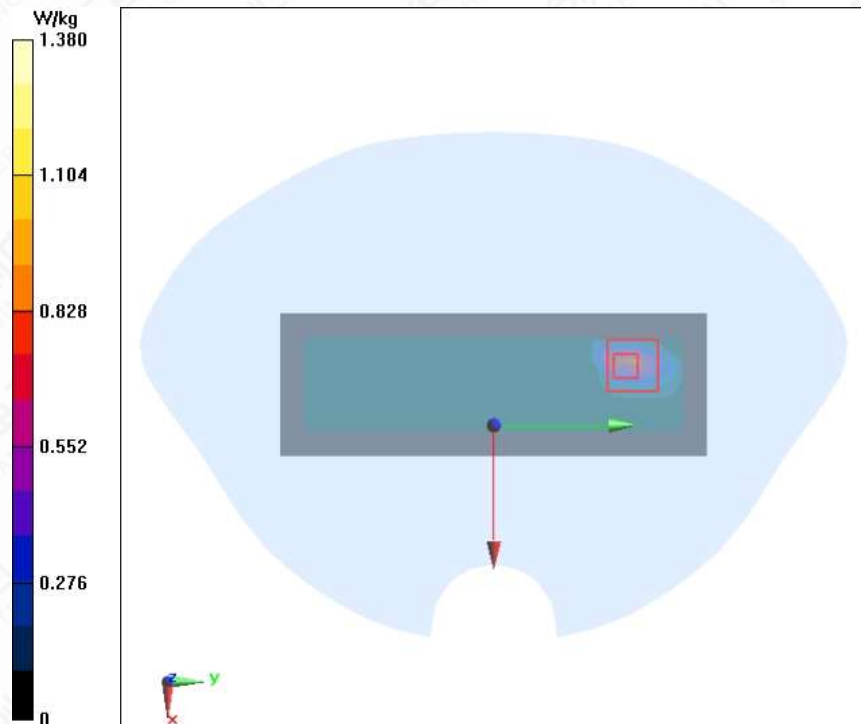

Figure A.1-4 Wi-Fi 5G U-NII-1 11a ANT2 Right Mode Low 0mm Body

**Wi-Fi 5G U-NII-2A 11a ANT1 Left Mode Middle 0mm Head**

Date/Time: 2023/2/25

Electronics: DAE4 Sn1244

Medium parameters used:  $f = 5300 \text{ MHz}$ ;  $\sigma = 4.823 \text{ S/m}$ ;  $\epsilon_r = 35.926$ ;  $\rho = 1000 \text{ kg/m}^3$

Ambient Temperature:  $21.3^\circ\text{C}$       Liquid Temperature:  $20.2^\circ\text{C}$

Communication System: 5GHz U-NII-2A 5GHz;      Frequency:  $5300 \text{ MHz}$ ; Duty Cycle: 1:1

Probe: EX3DV4 - SN7633ConvF(5.7, 5.7, 5.7) @  $5300 \text{ MHz}$

**Wi-Fi 5G U-NII-2A 11a ANT1 Left Mode Middle 0mm Head/Area Scan (7x19x1):**

Measurement grid:  $dx=10\text{mm}$ ,  $dy=10\text{mm}$

Maximum value of SAR (measured) =  $0.400 \text{ W/kg}$

**Wi-Fi 5G U-NII-2A 11a ANT1 Left Mode Middle 0mm Head/Zoom Scan (7x7x7)/Cube 0:**

Measurement grid:  $dx=4\text{mm}$ ,  $dy=4\text{mm}$ ,  $dz=2\text{mm}$

Reference Value =  $0 \text{ V/m}$ ; Power Drift =  $0.00 \text{ dB}$

Peak SAR (extrapolated) =  $1.55 \text{ W/kg}$

SAR(1 g) =  $0.211 \text{ W/kg}$ ; SAR(10 g) =  $0.046 \text{ W/kg}$

Maximum of SAR (measured) =  $0.515 \text{ W/kg}$

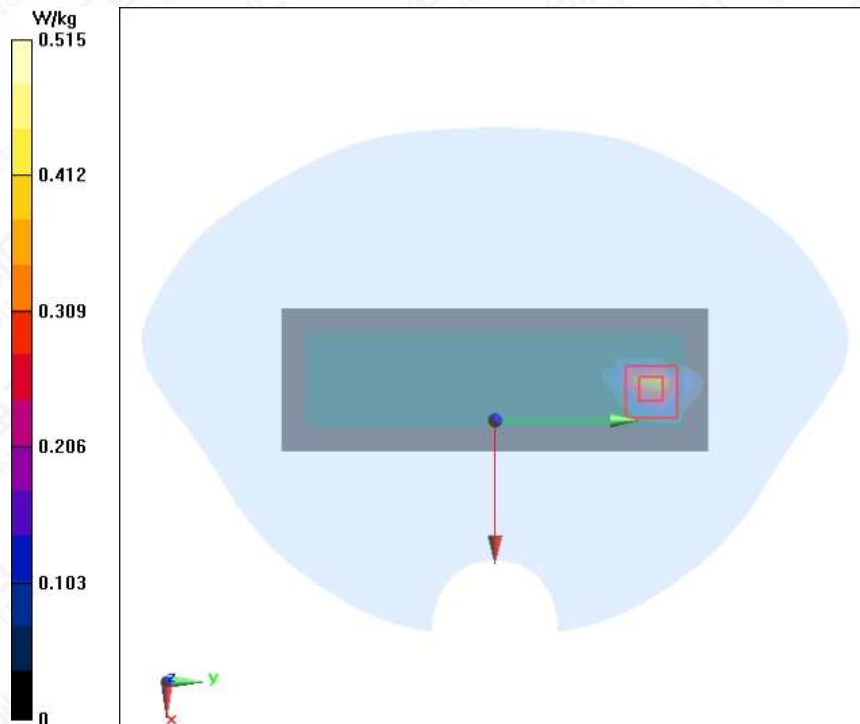

Figure A.1-5 Wi-Fi 5G U-NII-2A 11a ANT1 Left Mode Middle 0mm Head



**Wi-Fi 5G U-NII-2A 11a ANT1 Left Mode Middle 0mm Body**

Date/Time: 2023/2/26

Electronics: DAE4 Sn1244

Medium parameters used:  $f = 5300 \text{ MHz}$ ;  $\sigma = 4.823 \text{ S/m}$ ;  $\epsilon_r = 34.926$ ;  $\rho = 1000 \text{ kg/m}^3$

Ambient Temperature:  $21.1^\circ\text{C}$       Liquid Temperature:  $20.0^\circ\text{C}$

Communication System: 5GHz U-NII-2A 5GHz;    Frequency:  $5300 \text{ MHz}$ ; Duty Cycle: 1:1

Probe: EX3DV4 - SN7633ConvF(5.7, 5.7, 5.7) @  $5300 \text{ MHz}$

**Wi-Fi 5G U-NII-2A 11a ANT1 Left Mode Middle 0mm Body/Area Scan (7x19x1):**

Measurement grid:  $dx=10\text{mm}$ ,  $dy=10\text{mm}$

Maximum value of SAR (measured) =  $0.750 \text{ W/kg}$

**Wi-Fi 5G U-NII-2A 11a ANT1 Left Mode Middle 0mm Body/Zoom Scan (7x7x7)/Cube 0:**

Measurement grid:  $dx=4\text{mm}$ ,  $dy=4\text{mm}$ ,  $dz=2\text{mm}$

Reference Value =  $0 \text{ V/m}$ ; Power Drift =  $0.00 \text{ dB}$

Peak SAR (extrapolated) =  $2.08 \text{ W/kg}$

SAR(1 g) =  $0.38 \text{ W/kg}$ ; SAR(10 g) =  $0.0764 \text{ W/kg}$

Maximum of SAR (measured) =  $0.925 \text{ W/kg}$

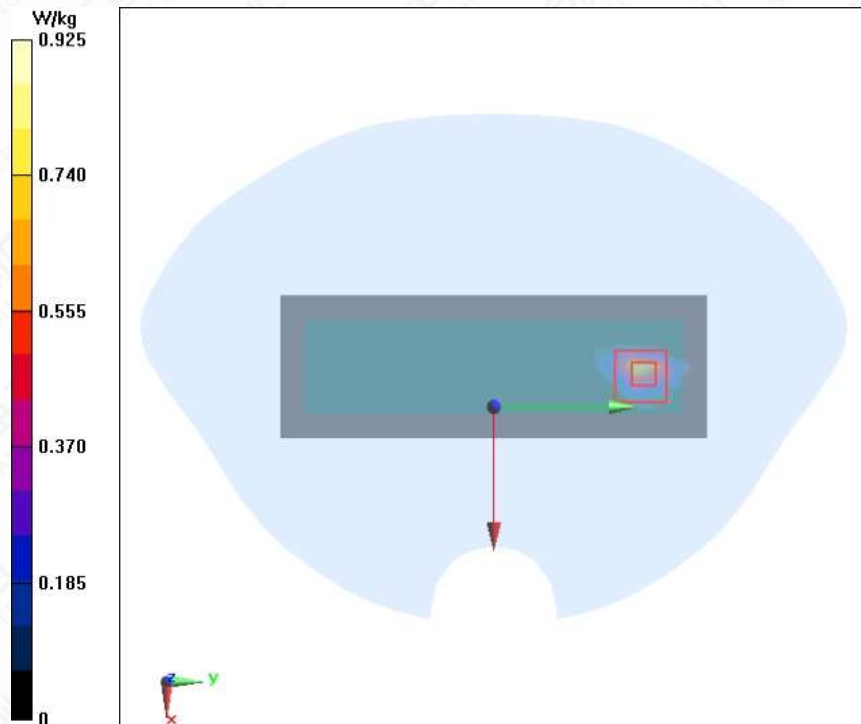

Figure A.1-6 Wi-Fi 5G U-NII-2A 11a ANT1 Left Mode Middle 0mm Body

**Wi-Fi 5G U-NII-2A 11a ANT2 Right Mode Low 0mm Head**

Date/Time: 2023/2/25

Electronics: DAE4 Sn1244

Medium parameters used:  $f = 5260$  MHz;  $\sigma = 4.78$  S/m;  $\epsilon_r = 36.008$ ;  $\rho = 1000$  kg/m<sup>3</sup>

Ambient Temperature: 21.3°C Liquid Temperature: 20.2°C

Communication System: 5GHz U-NII-2A 5GHz; Frequency: 5260 MHz; Duty Cycle: 1:1

Probe: EX3DV4 - SN7633ConvF(5.7, 5.7, 5.7) @ 5260 MHz

**Wi-Fi 5G U-NII-2A 11a ANT2 Right Mode Low 0mm Head/Area Scan (7x19x1):**

Measurement grid: dx=10mm, dy=10mm

Maximum value of SAR (measured) = 0.629 W/kg

**Wi-Fi 5G U-NII-2A 11a ANT2 Right Mode Low 0mm Head/Zoom Scan (7x7x7)/Cube 0:**

Measurement grid: dx=4mm, dy=4mm, dz=2mm

Reference Value = 0 V/m; Power Drift = 0.00 dB

Peak SAR (extrapolated) = 1.23 W/kg

SAR(1 g) = 0.334 W/kg; SAR(10 g) = 0.0833 W/kg

Maximum of SAR (measured) = 0.900 W/kg

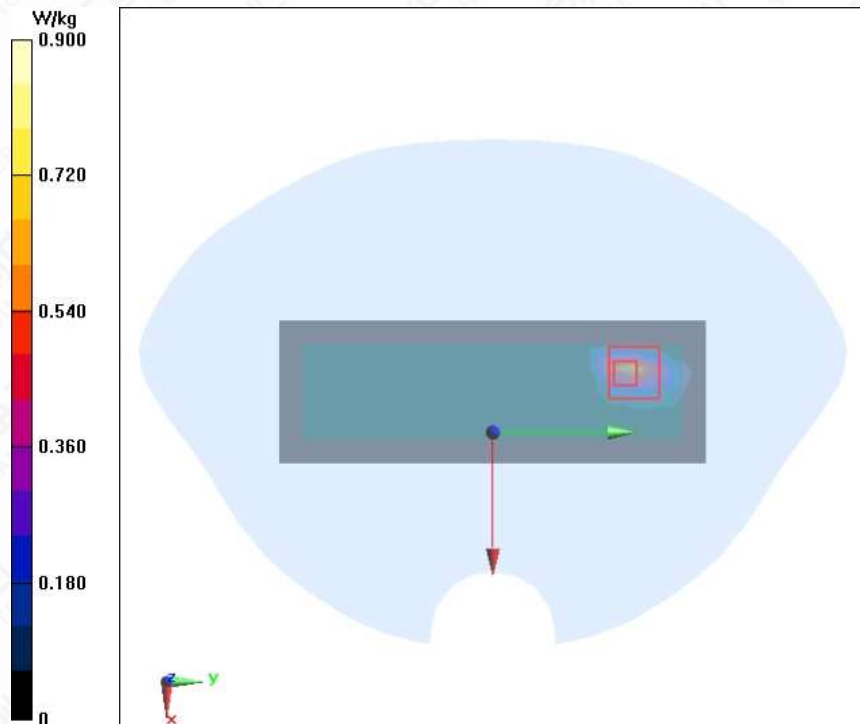

Figure A.1-7 Wi-Fi 5G U-NII-2A 11a ANT2 Right Mode Low 0mm Head

**Wi-Fi 5G U-NII-2A 11a ANT2 Right Mode Low 0mm Body**

Date/Time: 2023/2/25

Electronics: DAE4 Sn1244

 Medium parameters used:  $f = 5260$  MHz;  $\sigma = 4.78$  S/m;  $\epsilon_r = 36.008$ ;  $\rho = 1000$  kg/m<sup>3</sup>

Ambient Temperature: 21.3°C      Liquid Temperature: 20.2°C

Communication System: 5GHz U-NII-2A 5GHz;      Frequency: 5260 MHz; Duty Cycle: 1:1

Probe: EX3DV4 - SN7633ConvF(5.7, 5.7, 5.7) @ 5260 MHz

**Wi-Fi 5G U-NII-2A 11a ANT2 Right Mode Low 0mm Body/Area Scan (7x19x1):**

Measurement grid: dx=10mm, dy=10mm

Maximum value of SAR (measured) = 0.959 W/kg

**Wi-Fi 5G U-NII-2A 11a ANT2 Right Mode Low 0mm Body/Zoom Scan (7x7x7)/Cube 0:**

Measurement grid: dx=4mm, dy=4mm, dz=2mm

Reference Value = 0 V/m; Power Drift = 0.00 dB

Peak SAR (extrapolated) = 1.85 W/kg

SAR(1 g) = 0.468 W/kg; SAR(10 g) = 0.102 W/kg

Maximum of SAR (measured) = 1.26 W/kg

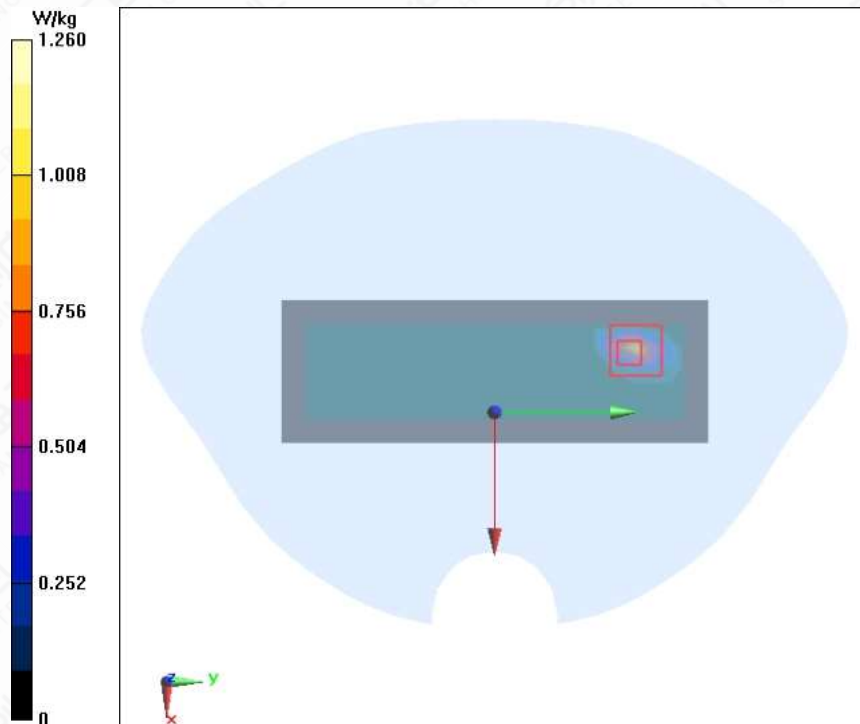

Figure A.1-8 Wi-Fi 5G U-NII-2A 11a ANT2 Right Mode Low 0mm Body

**Wi-Fi 5G U-NII-2C 11a ANT1 Left Mode Low 0mm Head**

Date/Time: 2023/2/27

Electronics: DAE4 Sn1244

Medium parameters used:  $f = 5500 \text{ MHz}$ ;  $\sigma = 5.03 \text{ S/m}$ ;  $\epsilon_r = 35.143$ ;  $\rho = 1000 \text{ kg/m}^3$

Ambient Temperature:  $21.4^\circ\text{C}$       Liquid Temperature:  $20.2^\circ\text{C}$

Communication System: 5GHz U-NII-2C 5GHz;      Frequency: 5500 MHz; Duty Cycle: 1:1

Probe: EX3DV4 - SN7633ConvF(5.13, 5.13, 5.13) @ 5500 MHz

**Wi-Fi 5G U-NII-2C 11a ANT1 Left Mode Low 0mm Head/Area Scan (5x13x1):**

Measurement grid:  $dx=10\text{mm}$ ,  $dy=10\text{mm}$

Maximum value of SAR (measured) =  $0.823 \text{ W/kg}$

**Wi-Fi 5G U-NII-2C 11a ANT1 Left Mode Low 0mm Head/Zoom Scan (7x7x7)/Cube 0:**

Measurement grid:  $dx=4\text{mm}$ ,  $dy=4\text{mm}$ ,  $dz=2\text{mm}$

Reference Value =  $0 \text{ V/m}$ ; Power Drift =  $0.00 \text{ dB}$

Peak SAR (extrapolated) =  $1.90 \text{ W/kg}$

SAR(1 g) =  $0.379 \text{ W/kg}$ ; SAR(10 g) =  $0.091 \text{ W/kg}$

Maximum of SAR (measured) =  $0.940 \text{ W/kg}$

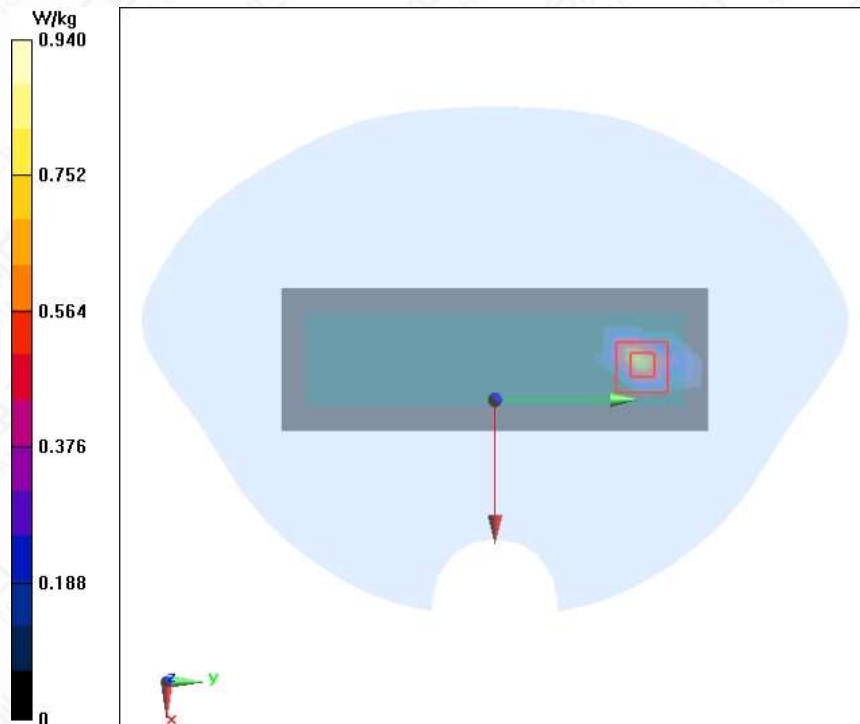

Figure A.1-9 Wi-Fi 5G U-NII-2C 11a ANT1 Left Mode Low 0mm Head

**Wi-Fi 5G U-NII-2C 11a ANT1 Left Mode Low 0mm Body**

Date/Time: 2023/2/27

Electronics: DAE4 Sn1244

 Medium parameters used:  $f = 5700 \text{ MHz}$ ;  $\sigma = 5.272 \text{ S/m}$ ;  $\epsilon_r = 34.731$ ;  $\rho = 1000 \text{ kg/m}^3$ 

 Ambient Temperature:  $21.4^\circ\text{C}$       Liquid Temperature:  $20.2^\circ\text{C}$ 

Communication System: 5GHz U-NII-2C 5GHz;      Frequency: 5700 MHz; Duty Cycle: 1:1

Probe: EX3DV4 - SN7633ConvF(5.13, 5.13, 5.13) @ 5700 MHz

**Wi-Fi 5G U-NII-2C 11a ANT1 Left Mode Low 0mm Body/Area Scan (7x19x1):**

 Measurement grid:  $dx=10\text{mm}$ ,  $dy=10\text{mm}$ 

Maximum value of SAR (measured) = 1.72 W/kg

**Wi-Fi 5G U-NII-2C 11a ANT1 Left Mode Low 0mm Body/Zoom Scan (7x7x7)/Cube 0:**

 Measurement grid:  $dx=4\text{mm}$ ,  $dy=4\text{mm}$ ,  $dz=2\text{mm}$ 

Reference Value = 0 V/m; Power Drift = 0.00 dB

Peak SAR (extrapolated) = 3.80 W/kg

SAR(1 g) = 0.764 W/kg; SAR(10 g) = 0.176 W/kg

Maximum of SAR (measured) = 2.15 W/kg

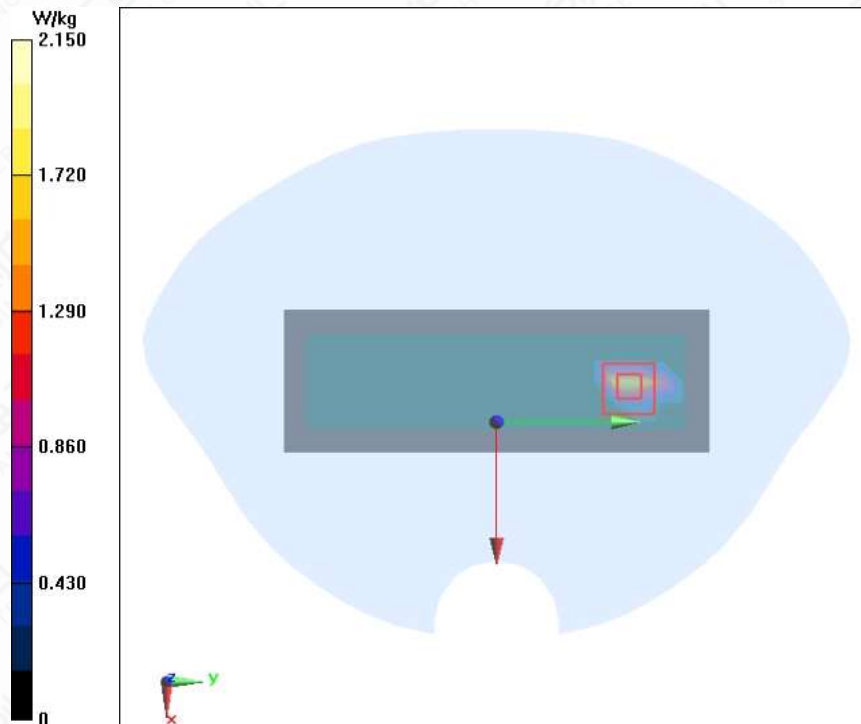

Figure A.1-10 Wi-Fi 5G U-NII-2C 11a ANT1 Left Mode Low 0mm Body

**Wi-Fi 5G U-NII-2C 11a ANT2 Right Mode Low 0mm Head**

Date/Time: 2023/2/26

Electronics: DAE4 Sn1244

Medium parameters used:  $f = 5500 \text{ MHz}$ ;  $\sigma = 4.965 \text{ S/m}$ ;  $\epsilon_r = 34.524$ ;  $\rho = 1000 \text{ kg/m}^3$

Ambient Temperature:  $21.1^\circ\text{C}$       Liquid Temperature:  $20.1^\circ\text{C}$

Communication System: 5GHz U-NII-2C 5GHz;      Frequency: 5500 MHz; Duty Cycle: 1:1

Probe: EX3DV4 - SN7633ConvF(5.13, 5.13, 5.13) @ 5500 MHz

**Wi-Fi 5G U-NII-2C 11a ANT2 Right Mode Low 0mm Head/Area Scan (7x19x1):**

Measurement grid:  $dx=10\text{mm}$ ,  $dy=10\text{mm}$

Maximum value of SAR (measured) = 0.713 W/kg

**Wi-Fi 5G U-NII-2C 11a ANT2 Right Mode Low 0mm Head/Zoom Scan (7x7x7)/Cube 0:**

Measurement grid:  $dx=4\text{mm}$ ,  $dy=4\text{mm}$ ,  $dz=2\text{mm}$

Reference Value = 2.530 V/m; Power Drift = -0.12 dB

Peak SAR (extrapolated) = 1.87 W/kg

SAR(1 g) = 0.392 W/kg; SAR(10 g) = 0.107 W/kg

Maximum of SAR (measured) = 1.05 W/kg

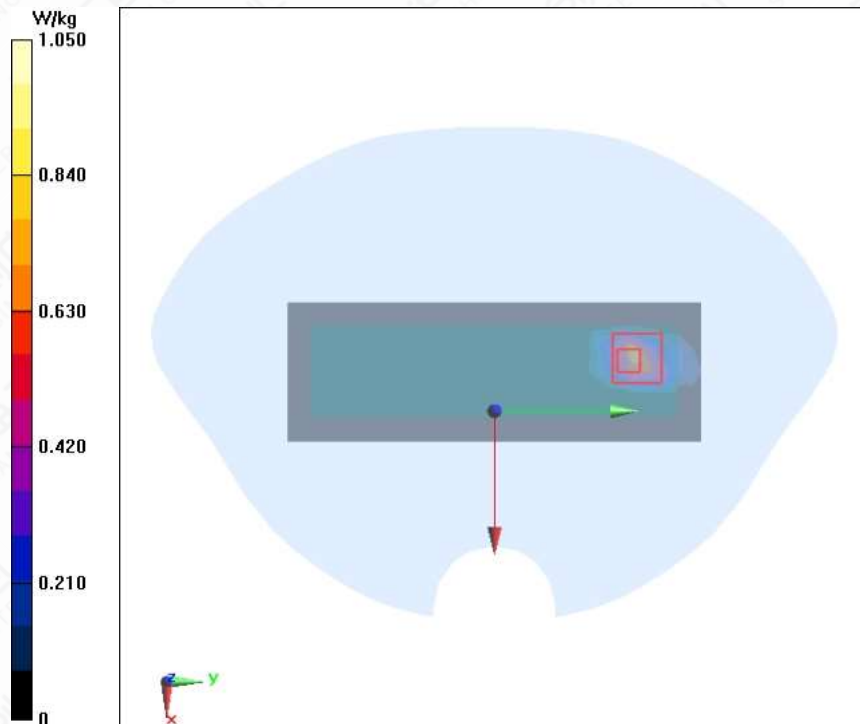

Figure A.1-11 Wi-Fi 5G U-NII-2C 11a ANT2 Right Mode Low 0mm Head

**Wi-Fi 5G U-NII-2C 11a ANT2 Right Mode Low 0mm Body**

Date/Time: 2023/2/26

Electronics: DAE4 Sn1244

Medium parameters used:  $f = 5600$  MHz;  $\sigma = 5.069$  S/m;  $\epsilon_r = 34.322$ ;  $\rho = 1000$  kg/m<sup>3</sup>

Ambient Temperature: 21.1°C Liquid Temperature: 20.1°C

Communication System: 5GHz U-NII-2C 5GHz; Frequency: 5600 MHz; Duty Cycle: 1:1

Probe: EX3DV4 - SN7633ConvF(5.13, 5.13, 5.13) @ 5600 MHz

**Wi-Fi 5G U-NII-2C 11a ANT2 Right Mode Low 0mm Body/Area Scan (7x19x1):**

Measurement grid: dx=10mm, dy=10mm

Maximum value of SAR (measured) = 1.47 W/kg

**Wi-Fi 5G U-NII-2C 11a ANT2 Right Mode Low 0mm Body/Zoom Scan (7x7x7)/Cube 0:**

Measurement grid: dx=4mm, dy=4mm, dz=2mm

Reference Value = 0 V/m; Power Drift = 0.00 dB

Peak SAR (extrapolated) = 5.09 W/kg

SAR(1 g) = 0.948 W/kg; SAR(10 g) = 0.200 W/kg

Maximum of SAR (measured) = 3.00 W/kg

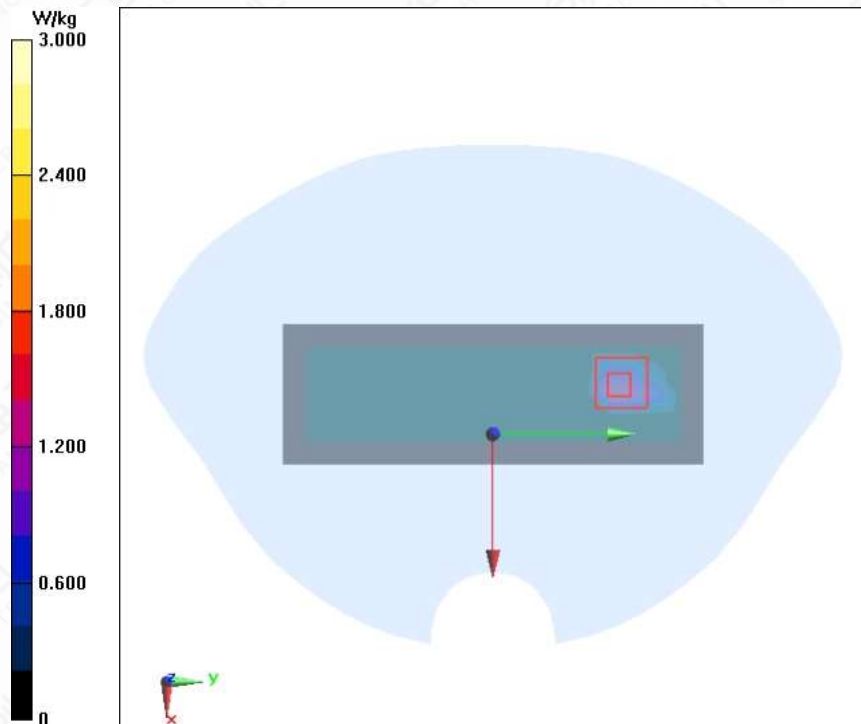

Figure A.1-12 Wi-Fi 5G U-NII-2C 11a ANT2 Right Mode Low 0mm Body

**Wi-Fi 5G U-NII-3 11a ANT1 Left Mode Low 0mm Head**

Date/Time: 2023/2/26

Electronics: DAE4 Sn1244

 Medium parameters used:  $f = 5745 \text{ MHz}$ ;  $\sigma = 5.237 \text{ S/m}$ ;  $\epsilon_r = 34.052$ ;  $\rho = 1000 \text{ kg/m}^3$ 

 Ambient Temperature:  $21.1^\circ\text{C}$       Liquid Temperature:  $20.0^\circ\text{C}$ 

Communication System: 5GHz U-NII-3 5GHz;      Frequency: 5745 MHz; Duty Cycle: 1:1

Probe: EX3DV4 - SN7633ConvF(5.17, 5.17, 5.17) @ 5745 MHz

**Wi-Fi 5G U-NII-3 11a ANT1 Left Mode Low 0mm Head/Area Scan (7x19x1):**

 Measurement grid:  $dx=10\text{mm}$ ,  $dy=10\text{mm}$ 

Maximum value of SAR (measured) = 1.01 W/kg

**Wi-Fi 5G U-NII-3 11a ANT1 Left Mode Low 0mm Head/Zoom Scan (7x7x7)/Cube 0:**

 Measurement grid:  $dx=4\text{mm}$ ,  $dy=4\text{mm}$ ,  $dz=2\text{mm}$ 

Reference Value = 0 V/m; Power Drift = 0.00 dB

Peak SAR (extrapolated) = 1.92 W/kg

SAR(1 g) = 0.406 W/kg; SAR(10 g) = 0.099 W/kg

Maximum of SAR (measured) = 1.03 W/kg

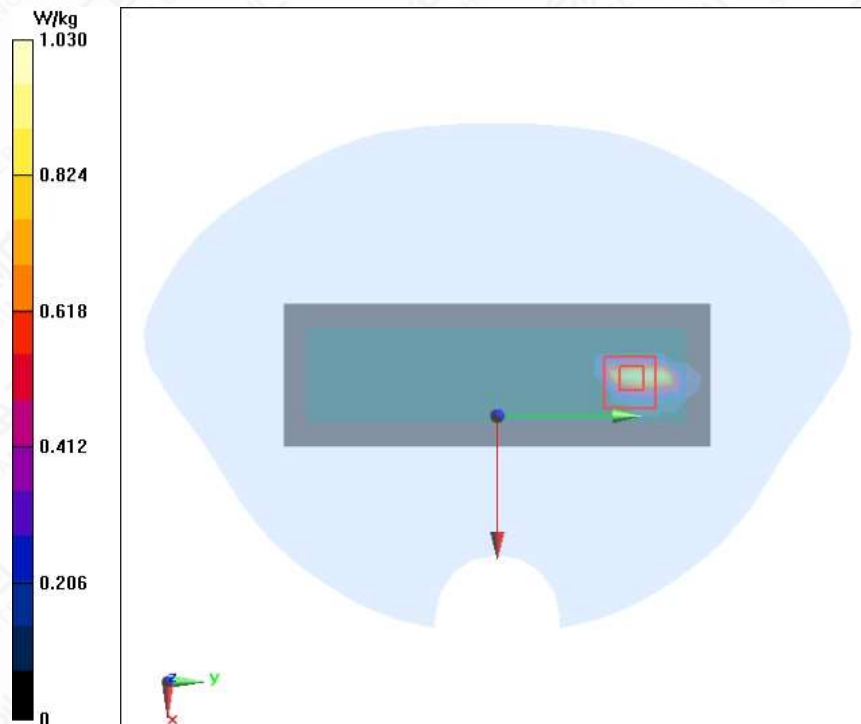

Figure A.1-13 Wi-Fi 5G U-NII-3 11a ANT1 Left Mode Low 0mm Head



**Wi-Fi 5G U-NII-3 11a ANT1 Left Mode Low 0mm Body**

Date/Time: 2023/2/26

Electronics: DAE4 Sn1244

 Medium parameters used:  $f = 5745 \text{ MHz}$ ;  $\sigma = 5.237 \text{ S/m}$ ;  $\epsilon_r = 34.052$ ;  $\rho = 1000 \text{ kg/m}^3$ 

 Ambient Temperature:  $21.2^\circ\text{C}$       Liquid Temperature:  $20.3^\circ\text{C}$ 

Communication System: 5GHz U-NII-3 5GHz;      Frequency: 5745 MHz; Duty Cycle: 1:1

Probe: EX3DV4 - SN7633ConvF(5.17, 5.17, 5.17) @ 5745 MHz

**Wi-Fi 5G U-NII-3 11a ANT1 Left Mode Low 0mm Body/Area Scan (7x13x1):**

 Measurement grid:  $dx=10\text{mm}$ ,  $dy=10\text{mm}$ 

Maximum value of SAR (measured) = 1.83 W/kg

**Wi-Fi 5G U-NII-3 11a ANT1 Left Mode Low 0mm Body/Zoom Scan (7x7x7)/Cube 0:**

 Measurement grid:  $dx=4\text{mm}$ ,  $dy=4\text{mm}$ ,  $dz=2\text{mm}$ 

Reference Value = 0 V/m; Power Drift = 0.00 dB

Peak SAR (extrapolated) = 4.50 W/kg

SAR(1 g) = 0.866 W/kg; SAR(10 g) = 0.196 W/kg

Maximum of SAR (measured) = 2.53 W/kg

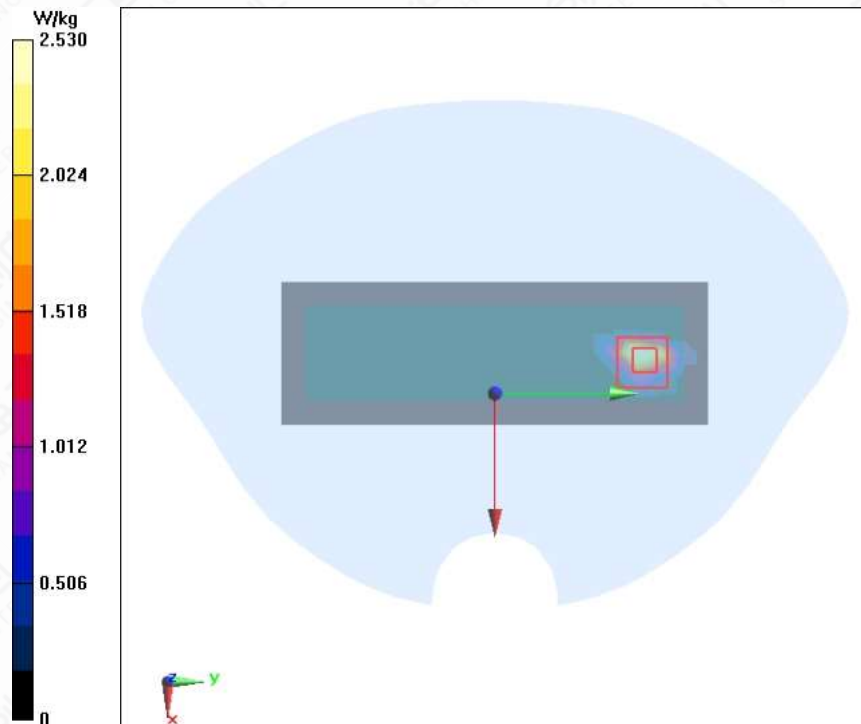

Figure A.1-14 Wi-Fi 5G U-NII-3 11a ANT1 Left Mode Low 0mm Body

**Wi-Fi 5G U-NII-3 11a ANT2 Right Mode High 0mm Head**

Date/Time: 2023/2/27

Electronics: DAE4 Sn1244

Medium parameters used:  $f = 5745 \text{ MHz}$ ;  $\sigma = 5.326 \text{ S/m}$ ;  $\epsilon_r = 34.642$ ;  $\rho = 1000 \text{ kg/m}^3$

Ambient Temperature:  $21.4^\circ\text{C}$       Liquid Temperature:  $20.2^\circ\text{C}$

Communication System: 5GHz U-NII-3 5GHz;      Frequency:  $5745 \text{ MHz}$ ; Duty Cycle: 1:1

Probe: EX3DV4 - SN7633ConvF(5.17, 5.17, 5.17) @  $5745 \text{ MHz}$

**Wi-Fi 5G U-NII-3 11a ANT2 Right Mode High 0mm Head/Area Scan (7x19x1):**

Measurement grid:  $dx=10\text{mm}$ ,  $dy=10\text{mm}$

Maximum value of SAR (measured) =  $0.623 \text{ W/kg}$

**Wi-Fi 5G U-NII-3 11a ANT2 Right Mode High 0mm Head/Zoom Scan (7x7x7)/Cube 0:**

Measurement grid:  $dx=4\text{mm}$ ,  $dy=4\text{mm}$ ,  $dz=2\text{mm}$

Reference Value =  $0 \text{ V/m}$ ; Power Drift =  $0.00 \text{ dB}$

Peak SAR (extrapolated) =  $1.93 \text{ W/kg}$

SAR(1 g) =  $0.245 \text{ W/kg}$ ; SAR(10 g) =  $0.0528 \text{ W/kg}$

Maximum of SAR (measured) =  $0.681 \text{ W/kg}$

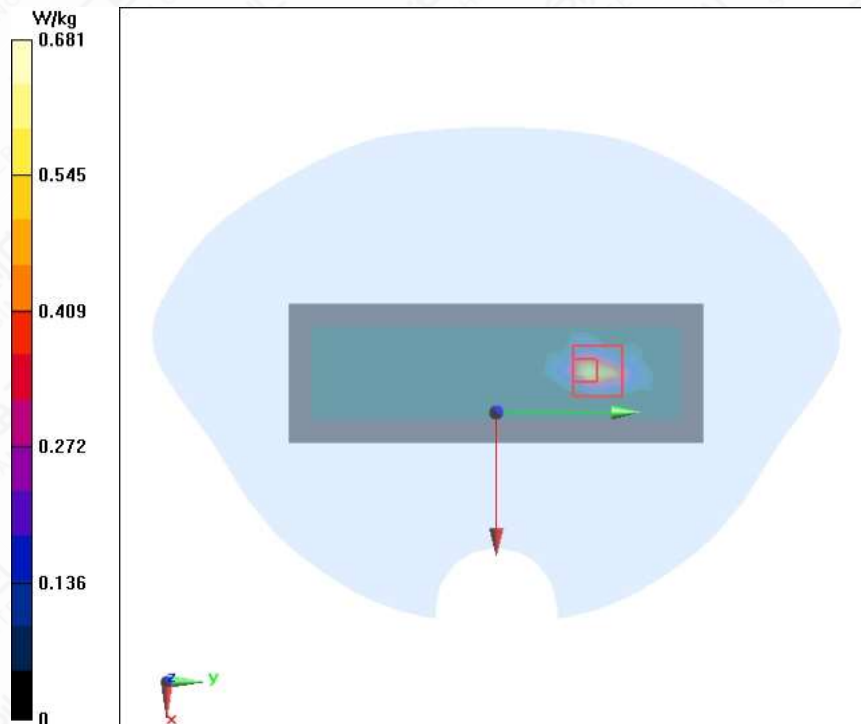

Figure A.1-15 Wi-Fi 5G U-NII-3 11a ANT2 Right Mode High 0mm Head

**Wi-Fi 5G U-NII-3 11a ANT2 Right Mode Low 0mm Body**

Date/Time: 2023/2/27

Electronics: DAE4 Sn1244

Medium parameters used:  $f = 5745 \text{ MHz}$ ;  $\sigma = 5.326 \text{ S/m}$ ;  $\epsilon_r = 34.642$ ;  $\rho = 1000 \text{ kg/m}^3$

Ambient Temperature:  $21.4^\circ\text{C}$       Liquid Temperature:  $20.2^\circ\text{C}$

Communication System: 5GHz U-NII-3 5GHz;      Frequency:  $5745 \text{ MHz}$ ; Duty Cycle: 1:1

Probe: EX3DV4 - SN7633ConvF(5.17, 5.17, 5.17) @  $5745 \text{ MHz}$

**Wi-Fi 5G U-NII-3 11a ANT2 Right Mode Low 0mm Body/Area Scan (7x19x1):**

Measurement grid:  $dx=10\text{mm}$ ,  $dy=10\text{mm}$

Maximum value of SAR (measured) =  $1.51 \text{ W/kg}$

**Wi-Fi 5G U-NII-3 11a ANT2 Right Mode Low 0mm Body/Zoom Scan (7x7x7)/Cube 0:**

Measurement grid:  $dx=4\text{mm}$ ,  $dy=4\text{mm}$ ,  $dz=2\text{mm}$

Reference Value =  $0 \text{ V/m}$ ; Power Drift =  $0.00 \text{ dB}$

Peak SAR (extrapolated) =  $2.70 \text{ W/kg}$

SAR(1 g) =  $0.471 \text{ W/kg}$ ; SAR(10 g) =  $0.0851 \text{ W/kg}$

Maximum of SAR (measured) =  $1.39 \text{ W/kg}$

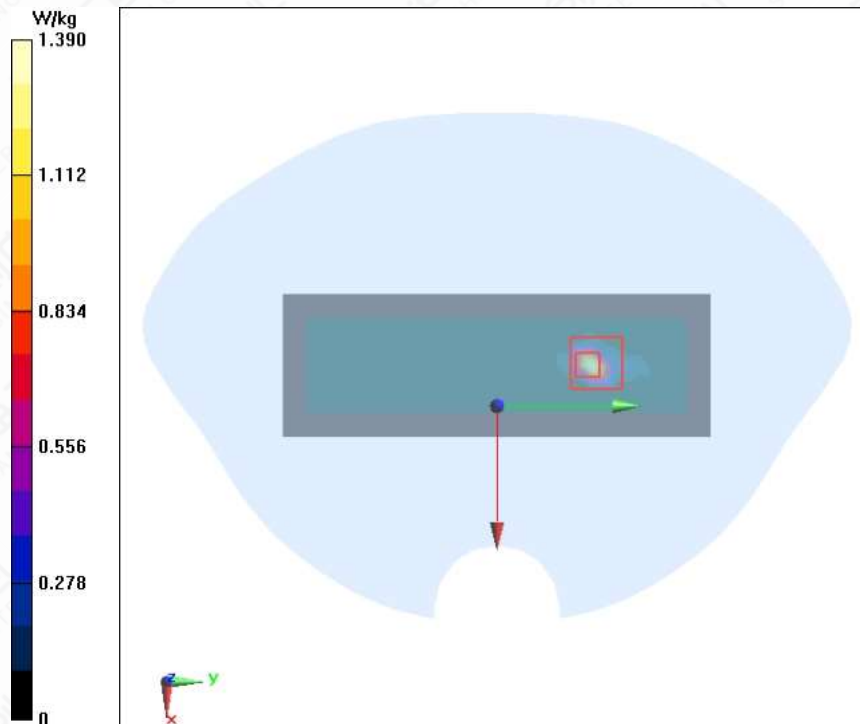

Figure A.1-16 Wi-Fi 5G U-NII-3 11a ANT2 Right Mode Low 0mm Body

## A.2 System Check Graph Results

### System Check Head 5200MHz

Date/Time: 2023/2/25

Electronics: DAE4 Sn1244

Medium parameters used:  $f = 5200 \text{ MHz}$ ;  $\sigma = 4.71 \text{ S/m}$ ;  $\epsilon_r = 36.123$ ;  $\rho = 1000 \text{ kg/m}^3$

Ambient Temperature:  $21.3^\circ\text{C}$       Liquid Temperature:  $20.2^\circ\text{C}$

Communication System: CW 5GHz;    Frequency: 5200 MHz; Duty Cycle: 1:1

Probe: EX3DV4 - SN7633ConvF(5.7, 5.7, 5.7) @ 5200 MHz

### System Check Head 5200MHz/Area Scan (10x10x1):

Measurement grid:  $dx=10\text{mm}$ ,  $dy=10\text{mm}$

Maximum value of SAR (measured) = 14.1 W/kg

### System Check Head 5200MHz/Zoom Scan (7x7x7)/Cube 0:

Measurement grid:  $dx=4\text{mm}$ ,  $dy=4\text{mm}$ ,  $dz=2\text{mm}$

Reference Value = 62.58 V/m; Power Drift = 0.04 dB

Peak SAR (extrapolated) = 30.4 W/kg

SAR(1 g) = 7.56 W/kg; SAR(10 g) = 2.17 W/kg

Maximum of SAR (measured) = 18.9 W/kg

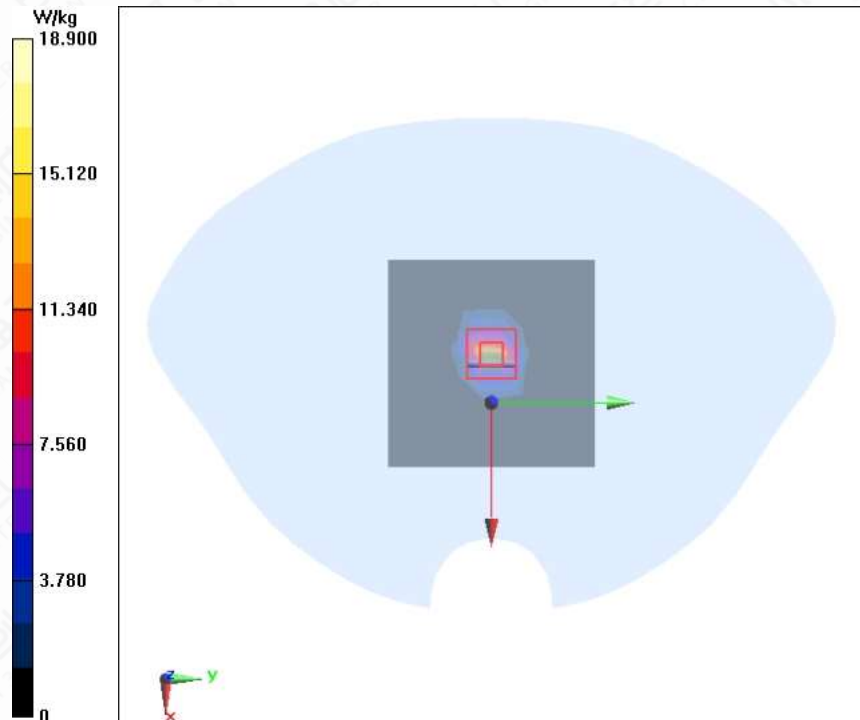

Figure A.2-1 System Check Head 5200MHz

**System Check Head 5300MHz**

Date/Time: 2023/2/25

Electronics: DAE4 Sn1244

Medium parameters used:  $f = 5300 \text{ MHz}$ ;  $\sigma = 4.823 \text{ S/m}$ ;  $\epsilon_r = 35.926$ ;  $\rho = 1000 \text{ kg/m}^3$

Ambient Temperature:  $21.3^\circ\text{C}$       Liquid Temperature:  $20.1^\circ\text{C}$

Communication System: CW 5GHz;    Frequency: 5300 MHz; Duty Cycle: 1:1

Probe: EX3DV4 - SN7633ConvF(5.7, 5.7, 5.7) @ 5300 MHz

**System Check Head 5300MHz/Area Scan (8x8x1):**

Measurement grid:  $dx=10\text{mm}$ ,  $dy=10\text{mm}$

Maximum value of SAR (measured) =  $19.8 \text{ W/kg}$

**System Check Head 5300MHz/Zoom Scan (4x4x1.4mm, graded), dist=1.4mm (7x7x7)/Cube 0:**

Measurement grid:  $dx=4\text{mm}$ ,  $dy=4\text{mm}$ ,  $dz=2\text{mm}$

Reference Value =  $64.92 \text{ V/m}$ ; Power Drift =  $0.02 \text{ dB}$

Peak SAR (extrapolated) =  $29.8 \text{ W/kg}$

SAR(1 g) =  $8.06 \text{ W/kg}$ ; SAR(10 g) =  $2.34 \text{ W/kg}$

Maximum of SAR (measured) =  $19.8 \text{ W/kg}$

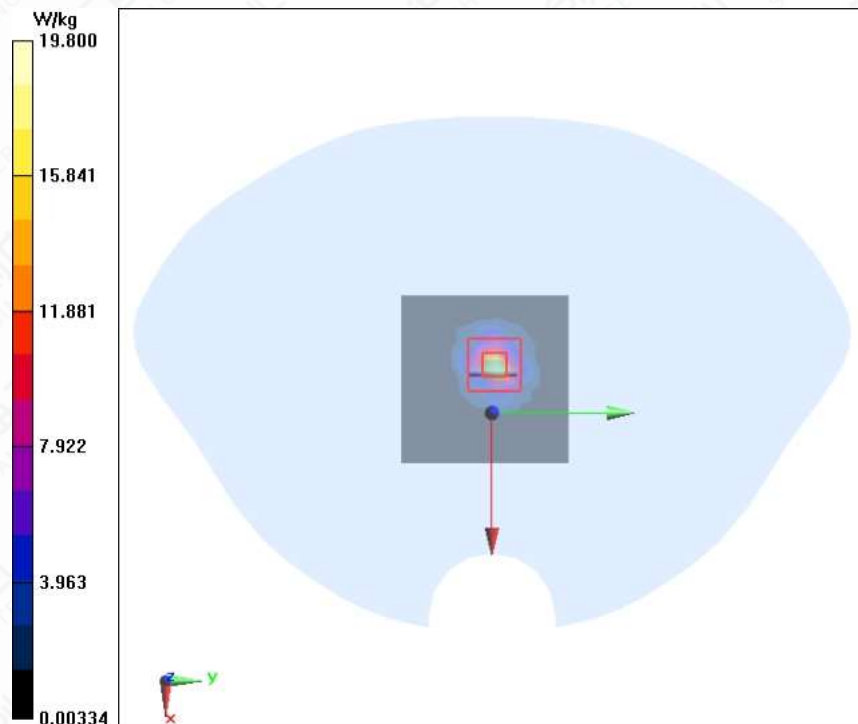

Figure A.2-2 System Check Head 5300MHz

**System Check Head 5300MHz**

Date/Time: 2023/2/26

Electronics: DAE4 Sn1244

Medium parameters used:  $f = 5300 \text{ MHz}$ ;  $\sigma = 4.758 \text{ S/m}$ ;  $\epsilon_r = 34.905$ ;  $\rho = 1000 \text{ kg/m}^3$

Ambient Temperature:  $21.0^\circ\text{C}$       Liquid Temperature:  $20.0^\circ\text{C}$

Communication System: CW 5GHz;    Frequency: 5300 MHz; Duty Cycle: 1:1

Probe: EX3DV4 - SN7633ConvF(5.7, 5.7, 5.7) @ 5300 MHz

**System Check Head 5300MHz/Area Scan (8x8x1):**

Measurement grid:  $dx=10\text{mm}$ ,  $dy=10\text{mm}$

Maximum value of SAR (measured) = 19.5 W/kg

**System Check Head 5300MHz/Zoom Scan (4x4x1.4mm, graded), dist=1.4mm (7x7x7)/Cube 0:**

Measurement grid:  $dx=4\text{mm}$ ,  $dy=4\text{mm}$ ,  $dz=2\text{mm}$

Reference Value = 64.63 V/m; Power Drift = 0.02 dB

Peak SAR (extrapolated) = 29.5 W/kg

SAR(1 g) = 7.87 W/kg; SAR(10 g) = 2.28 W/kg

Maximum of SAR (measured) = 19.4 W/kg

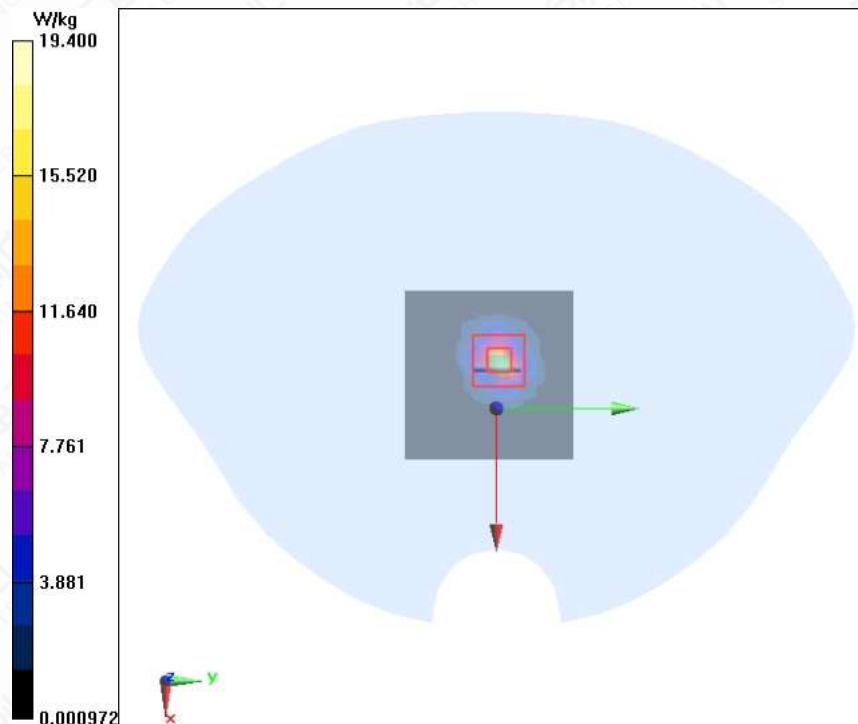

Figure A.2-3 System Check Head 5300MHz

**System Check Head 5600MHz**

Date/Time: 2023/2/26

Electronics: DAE4 Sn1244

Medium parameters used:  $f = 5600 \text{ MHz}$ ;  $\sigma = 5.069 \text{ S/m}$ ;  $\epsilon_r = 34.322$ ;  $\rho = 1000 \text{ kg/m}^3$

Ambient Temperature:  $21.0^\circ\text{C}$       Liquid Temperature:  $20.0^\circ\text{C}$

Communication System: CW 5GHz;    Frequency: 5600 MHz; Duty Cycle: 1:1

Probe: EX3DV4 - SN7633ConvF(5.13, 5.13, 5.13) @ 5600 MHz

**System Check Head 5600MHz/Area Scan (10x10x1):**

Measurement grid:  $dx=10\text{mm}$ ,  $dy=10\text{mm}$

Maximum value of SAR (measured) =  $15.7 \text{ W/kg}$

**System Check Head 5600MHz/Zoom Scan (7x7x7)/Cube 0:**

Measurement grid:  $dx=4\text{mm}$ ,  $dy=4\text{mm}$ ,  $dz=2\text{mm}$

Reference Value =  $66.99 \text{ V/m}$ ; Power Drift =  $0.03 \text{ dB}$

Peak SAR (extrapolated) =  $37.6 \text{ W/kg}$

SAR(1 g) =  $8.2 \text{ W/kg}$ ; SAR(10 g) =  $2.32 \text{ W/kg}$

Maximum of SAR (measured) =  $21.6 \text{ W/kg}$

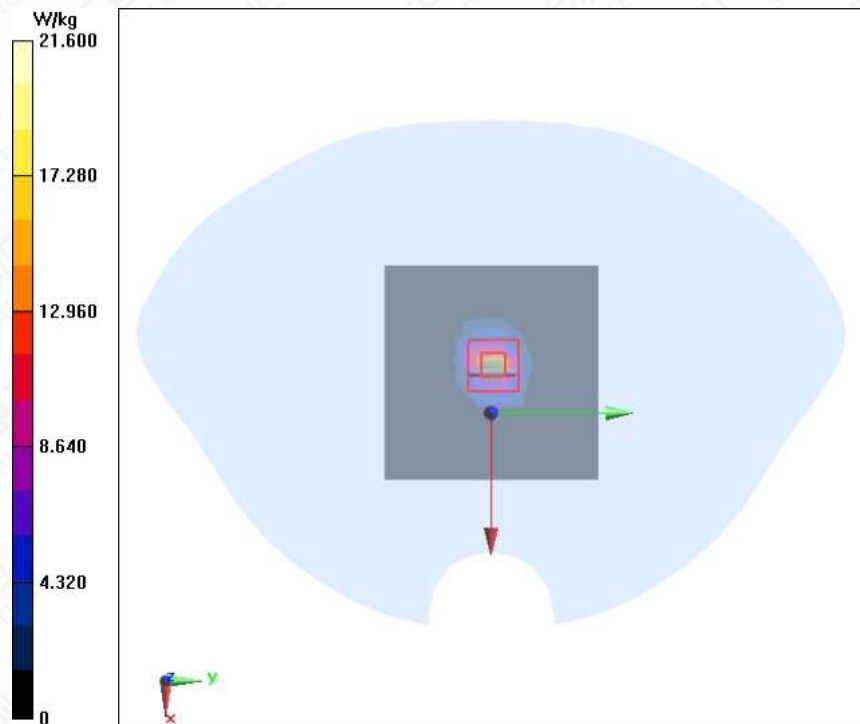

Figure A.2-4 System Check Head 5600MHz

**System Check Head 5600MHz**

Date/Time: 2023/2/27

Electronics: DAE4 Sn1244

Medium parameters used:  $f = 5600 \text{ MHz}$ ;  $\sigma = 5.153 \text{ S/m}$ ;  $\epsilon_r = 34.938$ ;  $\rho = 1000 \text{ kg/m}^3$

Ambient Temperature:  $21.5^\circ\text{C}$       Liquid Temperature:  $20.3^\circ\text{C}$

Communication System: CW 5GHz;    Frequency: 5600 MHz; Duty Cycle: 1:1

Probe: EX3DV4 - SN7633ConvF(5.13, 5.13, 5.13) @ 5600 MHz

**System Check Head 5600MHz/Area Scan (10x10x1):**

Measurement grid:  $dx=10\text{mm}$ ,  $dy=10\text{mm}$

Maximum value of SAR (measured) =  $16.0 \text{ W/kg}$

**System Check Head 5600MHz/Zoom Scan (7x7x7)/Cube 0:**

Measurement grid:  $dx=4\text{mm}$ ,  $dy=4\text{mm}$ ,  $dz=2\text{mm}$

Reference Value =  $66.99 \text{ V/m}$ ; Power Drift =  $0.03 \text{ dB}$

Peak SAR (extrapolated) =  $38.2 \text{ W/kg}$

SAR(1 g) =  $8.34 \text{ W/kg}$ ; SAR(10 g) =  $2.36 \text{ W/kg}$

Maximum of SAR (measured) =  $21.9 \text{ W/kg}$

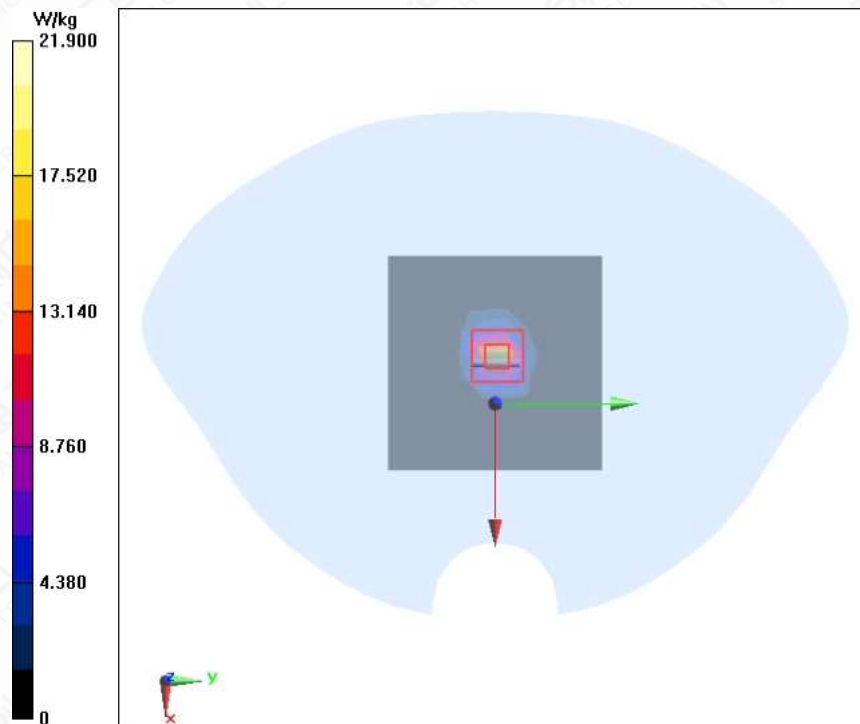

Figure A.2-5 System Check Head 5600MHz



**System Check Head 5800MHz**

Date/Time: 2023/2/26

Electronics: DAE4 Sn1244

Medium parameters used:  $f = 5800 \text{ MHz}$ ;  $\sigma = 5.284 \text{ S/m}$ ;  $\epsilon_r = 33.918$ ;  $\rho = 1000 \text{ kg/m}^3$

Ambient Temperature:  $21.1^\circ\text{C}$       Liquid Temperature:  $20.2^\circ\text{C}$

Communication System: CW 5GHz;    Frequency: 5800 MHz; Duty Cycle: 1:1

Probe: EX3DV4 - SN7633ConvF(5.17, 5.17, 5.17) @ 5800 MHz

**System Check Head 5800MHz/Area Scan (10x10x1):**

Measurement grid:  $dx=10\text{mm}$ ,  $dy=10\text{mm}$

Maximum value of SAR (measured) =  $18.0 \text{ W/kg}$

**System Check Head 5800MHz/Zoom Scan (4x4x1.4mm, graded), dist=1.4mm (7x7x7)/Cube 0:**

Measurement grid:  $dx=4\text{mm}$ ,  $dy=4\text{mm}$ ,  $dz=2\text{mm}$

Reference Value =  $59.12 \text{ V/m}$ ; Power Drift =  $0.04 \text{ dB}$

Peak SAR (extrapolated) =  $35.6 \text{ W/kg}$

SAR(1 g) =  $7.85 \text{ W/kg}$ ; SAR(10 g) =  $2.23 \text{ W/kg}$

Maximum of SAR (measured) =  $21.0 \text{ W/kg}$

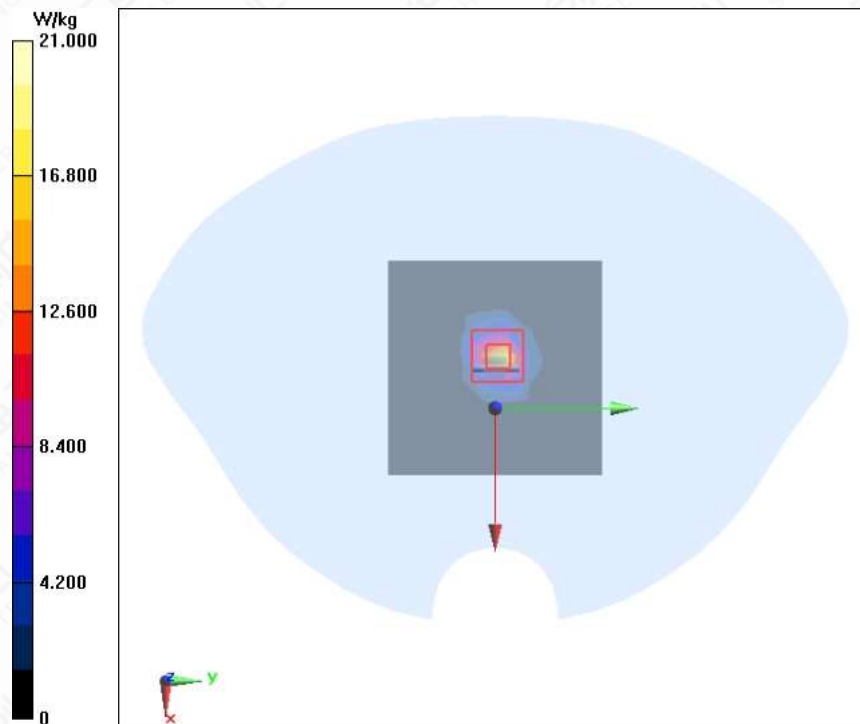

Figure A.2-6 System Check Head 5800MHz

**System Check Head 5800MHz**

Date/Time: 2023/2/27

Electronics: DAE4 Sn1244

Medium parameters used:  $f = 5800 \text{ MHz}$ ;  $\sigma = 5.392 \text{ S/m}$ ;  $\epsilon_r = 34.541$ ;  $\rho = 1000 \text{ kg/m}^3$

Ambient Temperature:  $21.5^\circ\text{C}$       Liquid Temperature:  $20.3^\circ\text{C}$

Communication System: CW 5GHz;    Frequency: 5800 MHz; Duty Cycle: 1:1

Probe: EX3DV4 - SN7633ConvF(5.17, 5.17, 5.17) @ 5800 MHz

**System Check Head 5800MHz/Area Scan (10x10x1):**

Measurement grid:  $dx=10\text{mm}$ ,  $dy=10\text{mm}$

Maximum value of SAR (measured) =  $15.0 \text{ W/kg}$

**System Check Head 5800MHz/Zoom Scan (4x4x1.4mm, graded), dist=1.4mm (7x7x7)/Cube 0:**

Measurement grid:  $dx=4\text{mm}$ ,  $dy=4\text{mm}$ ,  $dz=2\text{mm}$

Reference Value =  $63.11 \text{ V/m}$ ; Power Drift =  $0.04 \text{ dB}$

Peak SAR (extrapolated) =  $34.8 \text{ W/kg}$

SAR(1 g) =  $7.7 \text{ W/kg}$ ; SAR(10 g) =  $2.17 \text{ W/kg}$

Maximum value of SAR (measured) =  $20.7 \text{ W/kg}$

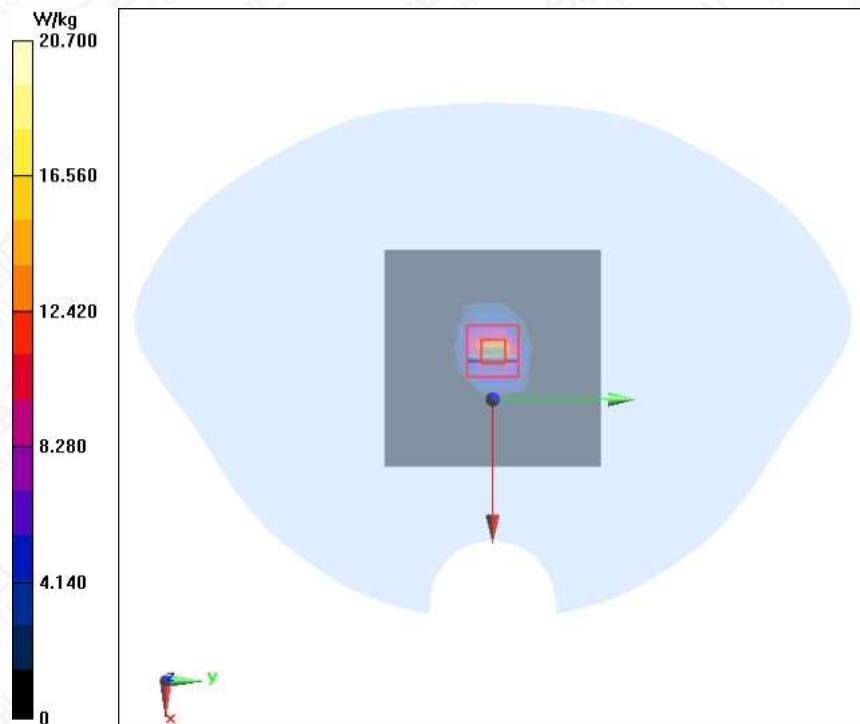

Figure A.2-7 System Check Head 5800MHz

## Annex B: Calibration Certificate



In Collaboration with  
**TTL s p e a g**  
CALIBRATION LABORATORY

Add: No.52 HuaYuanBei Road, Haidian District, Beijing, 100191, China  
 Tel: +86-10-62304633-2512 Fax: +86-10-62304633-2504  
 E-mail: entl@chinattl.com Http://www.chinattl.cn



中国认可  
国际互认  
校准  
CALIBRATION  
CNAS L0570

Client : **3in** Certificate No: **Z22-60063**

### CALIBRATION CERTIFICATE

Object: **DAE4 - SN: 1244**

Calibration Procedure(s): **FF-Z11-002-01  
Calibration Procedure for the Data Acquisition Electronics (DAEx)**

Calibration date: **March 09, 2022**

This calibration Certificate documents the traceability to national standards, which realize the physical units of measurements(SI). The measurements and the uncertainties with confidence probability are given on the following pages and are part of the certificate.

All calibrations have been conducted in the closed laboratory facility: environment temperature(22±3)°C and humidity<70%.

Calibration Equipment used (M&TE critical for calibration)

Primary Standards	ID #	Cal Date(Calibrated by, Certificate No.)	Scheduled Calibration
Process Calibrator 753	1971018	15-Jun-21 (CTTL, No.J21X04465)	Jun-22

	Name	Function	Signature
Calibrated by:	Yu Zongying	SAR Test Engineer	
Reviewed by:	Lin Hao	SAR Test Engineer	
Approved by:	Qi Dianyuan	SAR Project Leader	

Issued: March 11, 2022

This calibration certificate shall not be reproduced except in full without written approval of the laboratory.

Certificate No: Z22-60063
Page 1 of 3



In Collaboration with  
**s p e a g**  
CALIBRATION LABORATORY



Add: No.52 HuaYuanBei Road, Haidian District, Beijing, 100191, China  
Tel: +86-10-62304633-2512 Fax: +86-10-62304633-2504  
E-mail: cctl@chinattl.com Http://www.chinattl.cn

**Glossary:**

DAE data acquisition electronics  
Connector angle information used in DASYS system to align probe sensor X to the robot coordinate system.

**Methods Applied and Interpretation of Parameters:**

- *DC Voltage Measurement:* Calibration Factor assessed for use in DASYS system by comparison with a calibrated instrument traceable to national standards. The figure given corresponds to the full scale range of the voltmeter in the respective range.
- *Connector angle:* The angle of the connector is assessed measuring the angle mechanically by a tool inserted. Uncertainty is not required.
- The report provide only calibration results for DAE, it does not contain other performance test results.



Add: No.52 HuaYuanBei Road, Haidian District, Beijing, 100191, China  
 Tel: +86-10-62304633-2512 Fax: +86-10-62304633-2504  
 E-mail: cti@chinattl.com Http://www.chinattl.cn

**DC Voltage Measurement**

A/D - Converter Resolution nominal

High Range: 1LSB = 6.1μV, full range = -100...+300 mV

Low Range: 1LSB = 61nV, full range = -1.....+3mV

DASY measurement parameters: Auto Zero Time: 3 sec; Measuring time: 3 sec

Calibration Factors	X	Y	Z
High Range	403.832 ± 0.15% (k=2)	403.556 ± 0.15% (k=2)	404.475 ± 0.15% (k=2)
Low Range	3.95285 ± 0.7% (k=2)	3.96059 ± 0.7% (k=2)	3.97877 ± 0.7% (k=2)

**Connector Angle**

Connector Angle to be used in DASY system	23.5° ± 1°
---	------------



In Collaboration with  
**TTL Speag**  
 CALIBRATION LABORATORY  
 Add: No.52 HuaYuanBei Road, Haidian District, Beijing, 100191, China  
 Tel: +86-10-62304633-2512 Fax: +86-10-62304633-2504  
 E-mail: cttl@chinattl.com Http://www.chinattl.cn



中国认可  
 国际互认  
**CAICT**  
 CALIBRATION  
 CNAS L0570

 Client **3in**

 Certificate No: **Z22-60064**
**CALIBRATION CERTIFICATE**

 Object **EX3DV4 - SN : 7633**

 Calibration Procedure(s) **FF-Z11-004-02  
 Calibration Procedures for Dosimetric E-field Probes**



 Calibration date: **March 31, 2022**

This calibration Certificate documents the traceability to national standards, which realize the physical units of measurements(SI). The measurements and the uncertainties with confidence probability are given on the following pages and are part of the certificate.

All calibrations have been conducted in the closed laboratory facility; environment temperature(22±3)°C and humidity<70%.

**Calibration Equipment used (M&TE critical for calibration)**

Primary Standards	ID #	Cal Date(Calibrated by, Certificate No.)	Scheduled Calibration
Power Meter NRP2	101919	15-Jun-21(CTTL, No.J21X04466)	Jun-22
Power sensor NRP-Z91	101547	15-Jun-21(CTTL, No.J21X04466)	Jun-22
Power sensor NRP-Z91	101548	15-Jun-21(CTTL, No.J21X04466)	Jun-22
Reference 10dBAttenuator	18N50W-10dB	20-Jan-21(CTTL, No.J21X00486)	Jan-23
Reference 20dBAttenuator	18N50W-20dB	20-Jan-21(CTTL, No.J21X00485)	Jan-23
Reference Probe EX3DV4	SN 7307	26-May-21(SPEAG, No EX3-7307_May21)	May-22
Reference Probe EX3DV4	SN 7464	26-Jan-22(SPEAG, No EX3-7464_Jan22)	Jan-23
DAE4	SN 1555	20-Aug-21(SPEAG, No DAE4-1555_Aug21/2)	Aug-22
Secondary Standards	ID #	Cal Date(Calibrated by, Certificate No.)	Scheduled Calibration
SignalGenerator MG3700A	6201052605	16-Jun-21(CTTL, No.J21X04467)	Jun-22
Network Analyzer E5071C	MY46110673	14-Jan-22(CTTL, No.J22X00406)	Jan-23

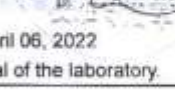
	Name	Function	Signature
Calibrated by:	Yu Zongying	SAR Test Engineer	
Reviewed by:	Lin Hao	SAR Test Engineer	
Approved by:	Qi Dianyuan	SAR Project Leader	

Issued: April 06, 2022

This calibration certificate shall not be reproduced except in full without written approval of the laboratory.

Certificate No: Z22-60064

Page 1 of 9



In Collaboration with  
**s p e a g**  
 CALIBRATION LABORATORY



Add: No.52 HuaYuanBei Road, Haidian District, Beijing, 100191, China  
 Tel: +86-10-62304633-2512 Fax: +86-10-62304633-2504  
 E-mail: ctrl@chinattl.com [Http://www.chinattl.cn](http://www.chinattl.cn)

**Glossary:**

TSL	tissue simulating liquid
NORM <sub>x,y,z</sub>	sensitivity in free space
ConvF	sensitivity in TSL / NORM <sub>x,y,z</sub>
DCP	diode compression point
CF	crest factor (1/duty_cycle) of the RF signal
A,B,C,D	modulation dependent linearization parameters
Polarization $\Phi$	$\Phi$ rotation around probe axis
Polarization $\theta$	$\theta$ rotation around an axis that is in the plane normal to probe axis (at measurement center), $\theta=0$ is normal to probe axis

Connector Angle information used in DASY system to align probe sensor X to the robot coordinate system

**Calibration is Performed According to the Following Standards:**

- IEEE Std 1528-2013, "IEEE Recommended Practice for Determining the Peak Spatial-Averaged Specific Absorption Rate (SAR) in the Human Head from Wireless Communications Devices: Measurement Techniques", June 2013
- IEC 62209-1, "Measurement procedure for the assessment of Specific Absorption Rate (SAR) from hand-held and body-mounted devices used next to the ear (frequency range of 300 MHz to 6 GHz)", July 2016
- IEC 62209-2, "Procedure to determine the Specific Absorption Rate (SAR) for wireless communication devices used in close proximity to the human body (frequency range of 30 MHz to 6 GHz)", March 2010
- KDB 865664, "SAR Measurement Requirements for 100 MHz to 6 GHz"

**Methods Applied and Interpretation of Parameters:**

- NORM<sub>x,y,z</sub>:** Assessed for E-field polarization  $\theta=0$  (fs900MHz in TEM-cell;  $f>1800$ MHz: waveguide). NORM<sub>x,y,z</sub> are only intermediate values, i.e., the uncertainties of NORM<sub>x,y,z</sub> does not effect the  $E^2$ -field uncertainty inside TSL (see below ConvF).
- NORM(f)<sub>x,y,z</sub> = NORM<sub>x,y,z</sub>\* frequency\_response** (see Frequency Response Chart). This linearization is implemented in DASY4 software versions later than 4.2. The uncertainty of the frequency response is included in the stated uncertainty of ConvF.
- DCP<sub>x,y,z</sub>:** DCP are numerical linearization parameters assessed based on the data of power sweep (no uncertainty required). DCP does not depend on frequency nor media.
- PAR:** PAR is the Peak to Average Ratio that is not calibrated but determined based on the signal characteristics.
- A<sub>x,y,z</sub>, B<sub>x,y,z</sub>, C<sub>x,y,z</sub>, VR<sub>x,y,z</sub>:** A,B,C are numerical linearization parameters assessed based on the data of power sweep for specific modulation signal. The parameters do not depend on frequency nor media. VR is the maximum calibration range expressed in RMS voltage across the diode.
- ConvF and Boundary Effect Parameters:** Assessed in flat phantom using E-field (or Temperature Transfer Standard for fs800MHz) and inside waveguide using analytical field distributions based on power measurements for  $f>800$ MHz. The same setups are used for assessment of the parameters applied for boundary compensation (alpha, depth) of which typical uncertainty valued are given. These parameters are used in DASY4 software to improve probe accuracy close to the boundary. The sensitivity in TSL corresponds to NORM<sub>x,y,z</sub>\* ConvF whereby the uncertainty corresponds to that given for ConvF. A frequency dependent ConvF is used in DASY version 4.4 and higher which allows extending the validity from  $\pm 50$ MHz to  $\pm 100$ MHz.
- Spherical isotropy (3D deviation from isotropy):** in a field of low gradients realized using a flat phantom exposed by a patch antenna.
- Sensor Offset:** The sensor offset corresponds to the offset of virtual measurement center from the probe tip (on probe axis). No tolerance required.
- Connector Angle:** The angle is assessed using the information gained by determining the NORM<sub>x</sub> (no uncertainty required).

Certificate No:Z22-60064

Page 2 of 9



Add: No.52 HuaYuanHei Road, Haidian District, Beijing, 100191, China  
 Tel: +86-10-62304633-2512 Fax: +86-10-62304633-2504  
 E-mail: [ettl@chinattl.com](mailto:ettl@chinattl.com) [Http://www.chinattl.cn](http://www.chinattl.cn)

## DASY/EASY – Parameters of Probe: EX3DV4 – SN:7633

### Basic Calibration Parameters

	Sensor X	Sensor Y	Sensor Z	Unc (k=2)
Norm( $\mu\text{V}/(\text{V}/\text{m})^2$ ) <sup>A</sup>	0.66	0.65	0.68	±10.0%
DCP(mV) <sup>B</sup>	111.2	112.3	113.8	

### Modulation Calibration Parameters

UID	Communication System Name		A dB	B dB· $\mu\text{V}$	C	D dB	VR mV	Unc <sup>E</sup> (k=2)
0	CW	X	0.0	0.0	1.0	0.00	214.3	±2.2%
		Y	0.0	0.0	1.0		212.4	
		Z	0.0	0.0	1.0		221.3	

The reported uncertainty of measurement is stated as the standard uncertainty of Measurement multiplied by the coverage factor  $k=2$ , which for a normal distribution Corresponds to a coverage probability of approximately 95%.

<sup>A</sup> The uncertainties of Norm X, Y, Z do not affect the  $E^2$ -field uncertainty inside TSL (see Page 4).

<sup>B</sup> Numerical linearization parameter; uncertainty not required.

<sup>E</sup> Uncertainty is determined using the max. deviation from linear response applying rectangular distribution and is expressed for the square of the field value.





Add: No.52 HuaYuanBei Road, Haidian District, Beijing, 100191, China  
 Tel: +86-10-62304633-2512 Fax: +86-10-62304633-2504  
 E-mail: cttl@chinattl.com [Http://www.chinattl.cn](http://www.chinattl.cn)

## DASY/EASY – Parameters of Probe: EX3DV4 – SN:7633

### Calibration Parameter Determined in Head Tissue Simulating Media

f [MHz] <sup>c</sup>	Relative Permittivity <sup>f</sup>	Conductivity (S/m) <sup>f</sup>	ConvF X	ConvF Y	ConvF Z	Alpha <sup>g</sup>	Depth <sup>g</sup> (mm)	Unct. (k=2)
750	41.9	0.89	10.90	10.90	10.90	0.14	1.44	±12.1%
835	41.5	0.90	10.55	10.55	10.55	0.13	1.59	±12.1%
900	41.5	0.97	10.53	10.53	10.53	0.15	1.38	±12.1%
1750	40.1	1.37	8.90	8.90	8.90	0.30	0.86	±12.1%
1900	40.0	1.40	8.60	8.60	8.60	0.26	0.98	±12.1%
2000	40.0	1.40	8.63	8.63	8.63	0.23	1.08	±12.1%
2300	39.5	1.67	8.20	8.20	8.20	0.55	0.72	±12.1%
2450	39.2	1.80	7.96	7.96	7.96	0.58	0.71	±12.1%
2600	39.0	1.96	7.73	7.73	7.73	0.65	0.67	±12.1%
3300	38.2	2.71	7.42	7.42	7.42	0.41	0.98	±13.3%
3500	37.9	2.91	7.20	7.20	7.20	0.41	0.95	±13.3%
3700	37.7	3.12	6.83	6.83	6.83	0.44	1.01	±13.3%
3900	37.5	3.32	6.85	6.85	6.85	0.36	1.33	±13.3%
4100	37.2	3.53	6.73	6.73	6.73	0.40	1.15	±13.3%
4200	37.1	3.63	6.65	6.65	6.65	0.35	1.35	±13.3%
4400	36.9	3.84	6.55	6.55	6.55	0.35	1.35	±13.3%
4600	36.7	4.04	6.41	6.41	6.41	0.45	1.25	±13.3%
4800	36.4	4.25	6.37	6.37	6.37	0.40	1.40	±13.3%
4950	36.3	4.40	6.06	6.06	6.06	0.40	1.40	±13.3%
5250	35.9	4.71	5.70	5.70	5.70	0.50	1.20	±13.3%
5600	35.5	5.07	5.13	5.13	5.13	0.50	1.30	±13.3%
5750	35.4	5.22	5.17	5.17	5.17	0.50	1.30	±13.3%

<sup>c</sup> Frequency validity above 300 MHz of ±100MHz only applies for DASY v4.4 and higher (Page 2), else it is restricted to ±50MHz. The uncertainty is the RSS of ConvF uncertainty at calibration frequency and the uncertainty for the indicated frequency band. Frequency validity below 300 MHz is ± 10, 25, 40, 50 and 70 MHz for ConvF assessments at 30, 64, 128, 150 and 220 MHz respectively. Above 5 GHz frequency validity can be extended to ± 110 MHz.

<sup>f</sup> At frequency below 3 GHz, the validity of tissue parameters ( $\epsilon$  and  $\sigma$ ) can be relaxed to ±10% if liquid compensation formula is applied to measured SAR values. At frequencies above 3 GHz, the validity of tissue parameters ( $\epsilon$  and  $\sigma$ ) is restricted to ±5%. The uncertainty is the RSS of the ConvF uncertainty for indicated target tissue parameters.

<sup>g</sup> Alpha/Depth are determined during calibration. SPEAG warrants that the remaining deviation due to the boundary effect after compensation is always less than ± 1% for frequencies below 3 GHz and below ± 2% for the frequencies between 3-6 GHz at any distance larger than half the probe tip diameter from the boundary.

Certificate No:Z22-60064

Page 4 of 9



Add: No.52 HuaYanBei Road, Haidian District, Beijing, 100191, China  
Tel: +86-10-62304633-2512 Fax: +86-10-62304633-2504  
E-mail: ctri@chinattl.com [Http://www.chinattl.cn](http://www.chinattl.cn)

### Frequency Response of E-Field (TEM-Cell: ifi110 EXX, Waveguide: R22)

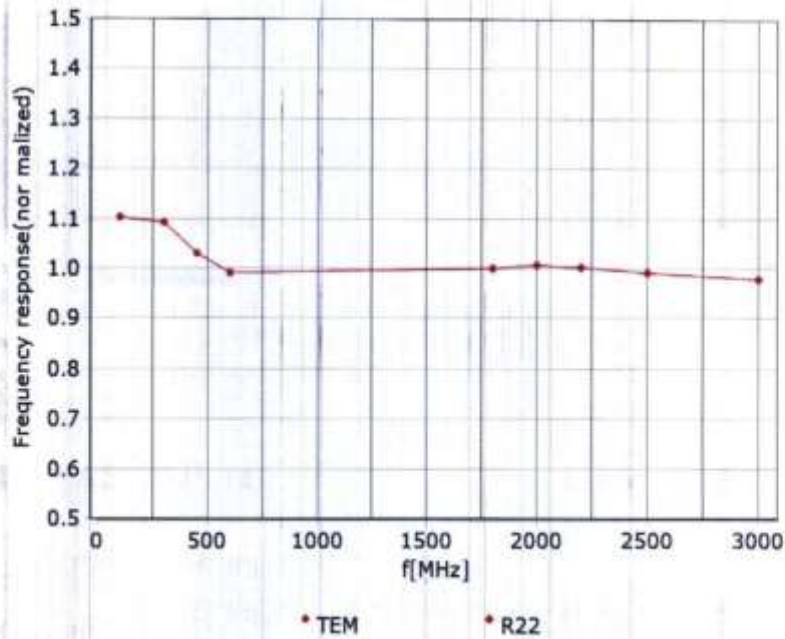

Uncertainty of Frequency Response of E-field:  $\pm 7.4\%$  ( $k=2$ )



Add: No.52 HuaYuanBei Road, Haidian District, Beijing, 100191, China  
Tel: +86-10-62304633-2512 Fax: +86-10-62304633-2504  
E-mail: ctri@chinattl.com [Http://www.chinattl.cn](http://www.chinattl.cn)

**Receiving Pattern ( $\Phi$ ),  $\theta=0^\circ$**

**f=600 MHz, TEM**

**f=1800 MHz, R22**

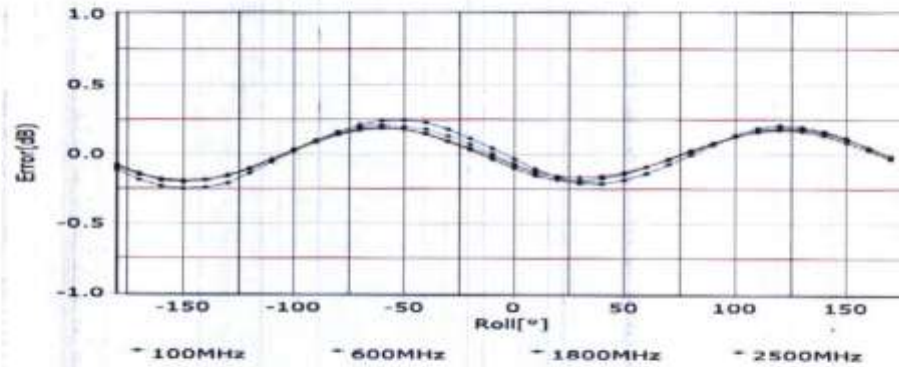
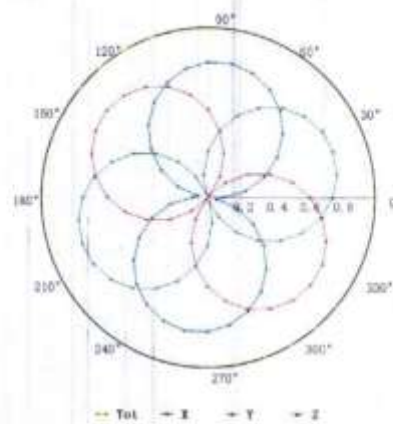
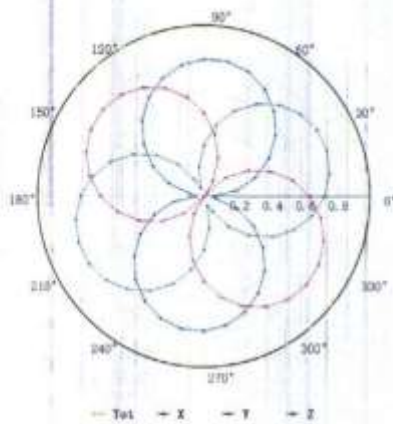

Uncertainty of Axial Isotropy Assessment:  $\pm 1.2\%$  ( $k=2$ )



Add: No.52 HuaYuanBei Road, Haidian District, Beijing, 100191, China  
 Tel: +86-10-62304633-2512 Fax: +86-10-62304633-2504  
 E-mail: ettj@chinantl.com <http://www.chinantl.cn>

**Dynamic Range f(SAR<sub>head</sub>)  
 (TEM cell, f = 900 MHz)**

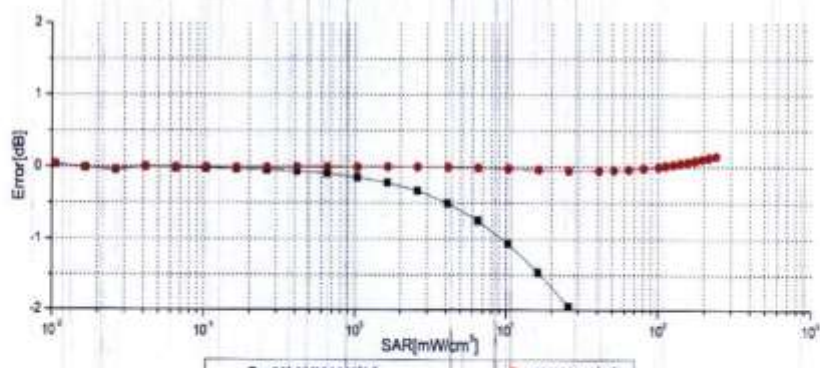
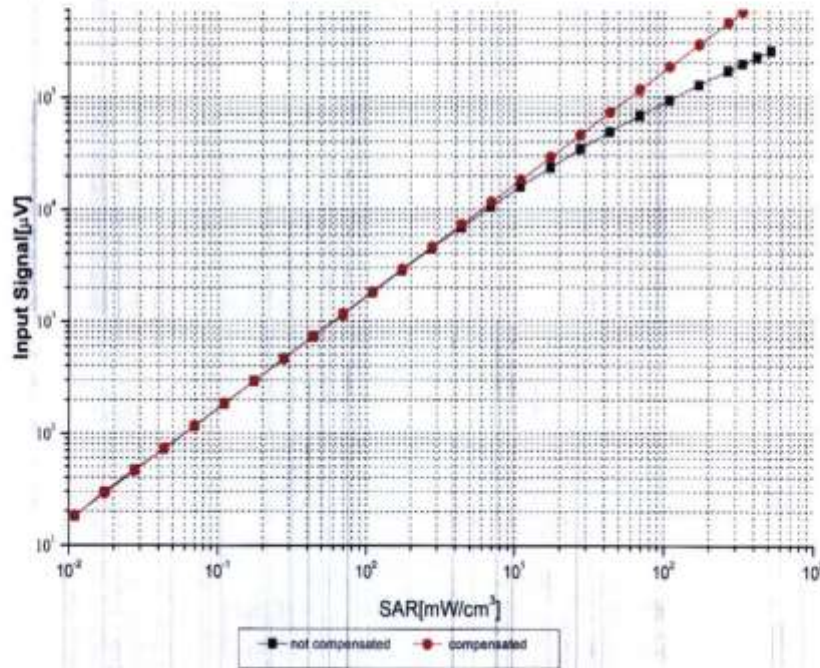

**Uncertainty of Linearity Assessment: ±0.9% (k=2)**

Certificate No:Z22-60064

Page 7 of 9



Add: No.52 HuaYuanBei Road, Haidian District, Beijing, 100191, China  
Tel: +86-10-62304633-2512 Fax: +86-10-62304633-2504  
E-mail: [ctl@chinatl.com](mailto:ctl@chinatl.com) [Http://www.chinatl.cn](http://www.chinatl.cn)

### Conversion Factor Assessment

f=750 MHz,WGLS R9(H\_convF)

f=1750 MHz,WGLS R22(H\_convF)

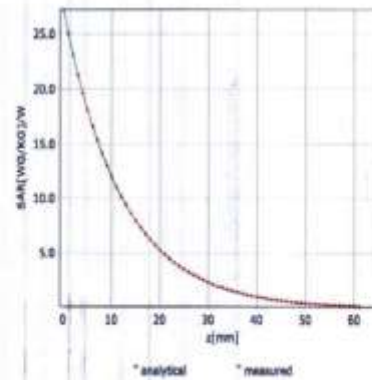
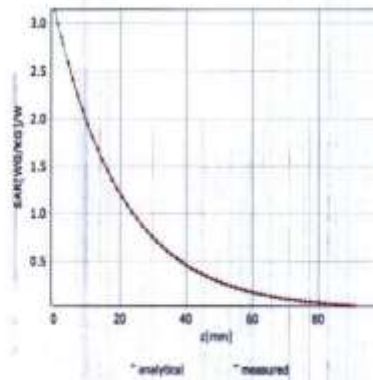

### Deviation from Isotropy in Liquid

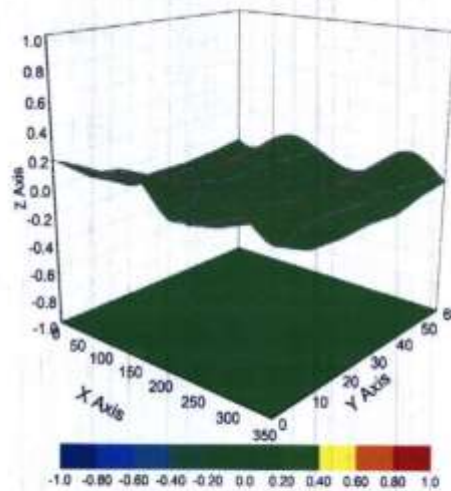

Uncertainty of Spherical Isotropy Assessment:  $\pm 3.2\%$  (k=2)

Certificate No:Z22-60064

Page 8 of 9



Add: No.52 HuaYuanBei Road, Haidian District, Beijing, 100191, China  
 Tel: +86-10-62304633-2512 Fax: +86-10-62304633-2504  
 E-mail: cttl@chinantl.com [Http://www.chinantl.cn](http://www.chinantl.cn)



### DASY/EASY – Parameters of Probe: EX3DV4 – SN:7633

#### Other Probe Parameters

Sensor Arrangement	Triangular
Connector Angle (°)	26.4
Mechanical Surface Detection Mode	enabled
Optical Surface Detection Mode	disable
Probe Overall Length	337mm
Probe Body Diameter	10mm
Tip Length	9mm
Tip Diameter	2.5mm
Probe Tip to Sensor X Calibration Point	1mm
Probe Tip to Sensor Y Calibration Point	1mm
Probe Tip to Sensor Z Calibration Point	1mm
Recommended Measurement Distance from Surface	1.4mm



Add: No.52 HuaYuanBei Road, Haidian District, Beijing, 100191  
 Tel: +86-10-62304633-2512 Fax: +86-10-62304633-2504  
 E-mail: cti@chinatti.com http://www.chinatti.cn



中国认可  
 国际互认  
 校准  
 CALIBRATION  
 CNAS L0578

 Client **3in**

 Certificate No: **Z22-60065**
**CALIBRATION CERTIFICATE**

 Object **D5GHzV2 - SN: 1172**

 Calibration Procedure(s) **FF-Z11-003-01  
Calibration Procedures for dipole validation kits**



 Calibration date: **March 15, 2022**

This calibration Certificate documents the traceability to national standards, which realize the physical units of measurements (SI). The measurements and the uncertainties with confidence probability are given on the following pages and are part of the certificate

All calibrations have been conducted in the closed laboratory facility: environment temperature (22±3)°C and humidity<70%.

Calibration Equipment used (M&amp;TE critical for calibration)

Primary Standards	ID #	Cal Date (Calibrated by, Certificate No.)	Scheduled Calibration
Power Meter NRP2	106277	24-Sep-21 (CTTL, No.J21X08326)	Sep-22
Power sensor NRP8S	104291	24-Sep-21 (CTTL, No.J21X08326)	Sep-22
Reference Probe EX3DV4	SN 7307	26-May-21(SPEAG, No. EX3-7307_May21)	May-22
DAE4	SN 1556	12-Jan-22(CTTL-SPEAG, No. Z22-60007)	Jan-23
Secondary Standards	ID #	Cal Date (Calibrated by, Certificate No.)	Scheduled Calibration
Signal Generator E4438C	MY49071430	13-Jan-22 (CTTL, No. J22X00409)	Jan-23
Network Analyzer E5071C	MY46110673	14-Jan-22 (CTTL, No. J22X00406)	Jan-23

	Name	Function	Signature
Calibrated by:	Zhao Jing	SAR Test Engineer	
Reviewed by:	Lin Hao	SAR Test Engineer	
Approved by:	Qi Dianyuan	SAR Project Leader	

Issued: March 19, 2022

This calibration certificate shall not be reproduced except in full without written approval of the laboratory.

Certificate No: Z22-60065

Page 1 of 10



Address: No.52 HuaYuanBei Road, Haidian District, Beijing, 100191, China  
Tel: +86-10-62304633-2079 Fax: +86-10-62304633-2504  
E-mail: ettl@chinattl.com http://www.chinattl.cn

**Glossary:**

TSL	tissue simulating liquid
ConvF	sensitivity in TSL / NORMx,y,z
N/A	not applicable or not measured

**Calibration is Performed According to the Following Standards:**

- IEC/IEEE 62209-1528, "Measurement Procedure for The Assessment of Specific Absorption Rate of Human Exposure to Radio Frequency Fields from Hand-held and Body-mounted Wireless Communication Devices- Part 1528: Human Models, Instrumentation and Procedures (Frequency range of 4 MHz to 10 GHz)", October 2020
- KDB 865664, "SAR Measurement Requirements for 100 MHz to 6 GHz"

**Additional Documentation:**

- DASY4/5 System Handbook

**Methods Applied and Interpretation of Parameters:**

- Measurement Conditions:** Further details are available from the Validation Report at the end of the certificate. All figures stated in the certificate are valid at the frequency indicated.
- Antenna Parameters with TSL:** The dipole is mounted with the spacer to position its feed point exactly below the center marking of the flat phantom section, with the arms oriented parallel to the body axis.
- Feed Point Impedance and Return Loss:** These parameters are measured with the dipole positioned under the liquid filled phantom. The impedance stated is transformed from the measurement at the SMA connector to the feed point. The Return Loss ensures low reflected power. No uncertainty required.
- Electrical Delay:** One-way delay between the SMA connector and the antenna feed point. No uncertainty required.
- SAR measured:** SAR measured at the stated antenna input power.
- SAR normalized:** SAR as measured, normalized to an input power of 1 W at the antenna connector.
- SAR for nominal TSL parameters:** The measured TSL parameters are used to calculate the nominal SAR result.

The reported uncertainty of measurement is stated as the standard uncertainty of Measurement multiplied by the coverage factor  $k=2$ , which for a normal distribution Corresponds to a coverage probability of approximately 95%.





Add: No.52 HuaYuanBei Road, Haidian District, Beijing, 100191, China  
 Tel: +86-10-62304633-2079 Fax: +86-10-62304633-2504  
 E-mail: ttl@chinattl.com http://www.chinattl.cn

**Measurement Conditions**

DASY system configuration, as far as not given on page 1.

DASY Version	DASY62	52.10.4
Extrapolation	Advanced Extrapolation	
Phantom	Triple Flat Phantom 5.1C	
Distance Dipole Center - TSL	10 mm	with Spacer
Zoom Scan Resolution	dx, dy = 4 mm, dz = 1.4 mm	Graded Ratio = 1.4 (Z direction)
Frequency	5200 MHz ± 1 MHz 5300 MHz ± 1 MHz 5500 MHz ± 1 MHz 5600 MHz ± 1 MHz 5800 MHz ± 1 MHz	

**Head TSL parameters at 5200MHz**

The following parameters and calculations were applied.

	Temperature	Permittivity	Conductivity
Nominal Head TSL parameters	22.0 °C	36.0	4.66 mho/m
Measured Head TSL parameters	(22.0 ± 0.2) °C	35.9 ± 6 %	4.64 mho/m ± 6 %
Head TSL temperature change during test	<1.0 °C	---	---

**SAR result with Head TSL at 5200MHz**

SAR averaged over 1 cm <sup>3</sup> (1 g) of Head TSL	Condition	
SAR measured	250 mW input power	7.58 W/kg
SAR for nominal Head TSL parameters	normalized to 1W	<b>75.7 W/kg ± 24.4 % (k=2)</b>
SAR averaged over 10 cm <sup>3</sup> (10 g) of Head TSL	Condition	
SAR measured	250 mW input power	2.18 W/kg
SAR for nominal Head TSL parameters	normalized to 1W	<b>21.8 W/kg ± 24.2 % (k=2)</b>



Add: No.52 HuaYunBei Road, Haidian District, Beijing, 100191, China  
 Tel: +86-10-62304633-2079 Fax: +86-10-62304633-2504  
 E-mail: cti@chinatl.com http://www.chinatl.cn

**Head TSL parameters at 5300MHz**

The following parameters and calculations were applied.

	Temperature	Permittivity	Conductivity
Nominal Head TSL parameters	22.0 °C	35.9	4.76 mho/m
Measured Head TSL parameters	(22.0 ± 0.2) °C	35.7 ± 6 %	4.75 mho/m ± 6 %
Head TSL temperature change during test	<1.0 °C	---	---

**SAR result with Head TSL at 5300MHz**

SAR averaged over 1 cm <sup>3</sup> (1 g) of Head TSL	Condition	
SAR measured	100 mW input power	7.88 W/kg
SAR for nominal Head TSL parameters	normalized to 1W	<b>78.7 W/kg ± 24.4 % (k=2)</b>
SAR averaged over 10 cm <sup>3</sup> (10 g) of Head TSL	Condition	
SAR measured	100 mW input power	2.28 W/kg
SAR for nominal Head TSL parameters	normalized to 1W	<b>22.6 W/kg ± 24.2 % (k=2)</b>

**Head TSL parameters at 5500MHz**

The following parameters and calculations were applied.

	Temperature	Permittivity	Conductivity
Nominal Head TSL parameters	22.0 °C	35.6	4.96 mho/m
Measured Head TSL parameters	(22.0 ± 0.2) °C	35.3 ± 6 %	4.96 mho/m ± 6 %
Head TSL temperature change during test	<1.0 °C	---	---

**SAR result with Head TSL at 5500MHz**

SAR averaged over 1 cm <sup>3</sup> (1 g) of Head TSL	Condition	
SAR measured	100 mW input power	8.23 W/kg
SAR for nominal Head TSL parameters	normalized to 1W	<b>82.2 W/kg ± 24.4 % (k=2)</b>
SAR averaged over 10 cm <sup>3</sup> (10 g) of Head TSL	Condition	
SAR measured	100 mW input power	2.33 W/kg
SAR for nominal Head TSL parameters	normalized to 1W	<b>23.3 W/kg ± 24.2 % (k=2)</b>



Add: No.52 HuaYuanBei Road, Haidian District, Beijing, 100191, China  
 Tel: +86-10-62304633-2079 Fax: +86-10-62304633-2504  
 E-mail: cni@chinaatl.com http://www.chinaatl.cn

**Head TSL parameters at 5600MHz**

The following parameters and calculations were applied.

	Temperature	Permittivity	Conductivity
<b>Nominal Head TSL parameters</b>	22.0 °C	35.5	5.07 mho/m
<b>Measured Head TSL parameters</b>	(22.0 ± 0.2) °C	35.2 ± 6 %	5.07 mho/m ± 6 %
<b>Head TSL temperature change during test</b>	<1.0 °C	---	---

**SAR result with Head TSL at 5600MHz**

SAR averaged over 1 cm <sup>3</sup> (1 g) of Head TSL	Condition	
SAR measured	100 mW input power	8.02 W/kg
SAR for nominal Head TSL parameters	normalized to 1W	<b>80.0 W/kg ± 24.4 % (k=2)</b>
SAR averaged over 10 cm <sup>3</sup> (10 g) of Head TSL	Condition	
SAR measured	100 mW input power	2.29 W/kg
SAR for nominal Head TSL parameters	normalized to 1W	<b>22.8 W/kg ± 24.2 % (k=2)</b>

**Head TSL parameters at 5800MHz**

The following parameters and calculations were applied.

	Temperature	Permittivity	Conductivity
<b>Nominal Head TSL parameters</b>	22.0 °C	35.3	5.27 mho/m
<b>Measured Head TSL parameters</b>	(22.0 ± 0.2) °C	34.9 ± 6 %	5.26 mho/m ± 6 %
<b>Head TSL temperature change during test</b>	<1.0 °C	---	---

**SAR result with Head TSL at 5800MHz**

SAR averaged over 1 cm <sup>3</sup> (1 g) of Head TSL	Condition	
SAR measured	100 mW input power	7.69 W/kg
SAR for nominal Head TSL parameters	normalized to 1W	<b>76.7 W/kg ± 24.4 % (k=2)</b>
SAR averaged over 10 cm <sup>3</sup> (10 g) of Head TSL	Condition	
SAR measured	100 mW input power	2.16 W/kg
SAR for nominal Head TSL parameters	normalized to 1W	<b>21.5 W/kg ± 24.2 % (k=2)</b>



Add: No.52 HuaYuanBei Road, Haidian District, Beijing, 100191, China  
 Tel: +86-10-62304633-2079 Fax: +86-10-62304633-2504  
 E-mail: cti@chinattl.com http://www.chinattl.cn

**Appendix (Additional assessments outside the scope of CNAS L0570)**
**Antenna Parameters with Head TSL at 5200MHz**

Impedance, transformed to feed point	49.3Ω- 8.81jΩ
Return Loss	- 21.0dB

**Antenna Parameters with Head TSL at 5300MHz**

Impedance, transformed to feed point	49.7Ω- 6.44jΩ
Return Loss	- 23.8dB

**Antenna Parameters with Head TSL at 5500MHz**

Impedance, transformed to feed point	52.9Ω- 5.05jΩ
Return Loss	- 24.9dB

**Antenna Parameters with Head TSL at 5600MHz**

Impedance, transformed to feed point	56.2Ω- 3.42jΩ
Return Loss	- 23.5dB

**Antenna Parameters with Head TSL at 5800MHz**

Impedance, transformed to feed point	56.3Ω- 5.84jΩ
Return Loss	- 21.8dB



Add: No.52 HuaYuanBei Road, Haidian District, Beijing, 100191, China  
 Tel: +86-10-62304633-2079 Fax: +86-10-62304633-2504  
 E-mail: ttl@chinatl.com http://www.chinatl.com

**General Antenna Parameters and Design**

Electrical Delay (one direction)	1.111 ns
----------------------------------	----------

After long term use with 100W radiated power, only a slight warming of the dipole near the feed-point can be measured.

The dipole is made of standard semirigid coaxial cable. The center conductor of the feeding line is directly connected to the second arm of the dipole. The antenna is therefore short-circuited for DC-signals. On some of the dipoles, small end caps are added to the dipole arms in order to improve matching when loaded according to the position as explained in the "Measurement Conditions" paragraph. The SAR data are not affected by this change. The overall dipole length is still according to the Standard.  
 No excessive force must be applied to the dipole arms, because they might bend or the soldered connections near the feed-point may be damaged.

**Additional EUT Data**

Manufactured by	SPEAG
-----------------	-------



Add: No.52 HuaYuanBei Road, Haidian District, Beijing, 100191, China  
 Tel: +86-10-62304633-2079 Fax: +86-10-62304633-2504  
 E-mail: ttl@chinattl.com http://www.chinattl.cn

**DASY5 Validation Report for Head TSL**

Date: 2022-03-15

Test Laboratory: CTTL, Beijing, China

**DUT: Dipole 5GHz; Type: D5GHzV2; Serial: D5GHzV2 - SN: 1172**

Communication System: CW; Frequency: 5200 MHz, Frequency: 5300 MHz,  
 Frequency: 5500 MHz, Frequency: 5600 MHz, Frequency: 5800 MHz, Duty Cycle: 1:1  
 Medium parameters used: f = 5200 MHz;  $\sigma = 4.64$  S/m;  $\epsilon_r = 35.88$ ;  $\rho = 1000$  kg/m<sup>3</sup>  
 Medium parameters used: f = 5300 MHz;  $\sigma = 4.745$  S/m;  $\epsilon_r = 35.68$ ;  $\rho = 1000$  kg/m<sup>3</sup>  
 Medium parameters used: f = 5500 MHz;  $\sigma = 4.955$  S/m;  $\epsilon_r = 35.32$ ;  $\rho = 1000$  kg/m<sup>3</sup>  
 Medium parameters used: f = 5600 MHz;  $\sigma = 5.067$  S/m;  $\epsilon_r = 35.17$ ;  $\rho = 1000$  kg/m<sup>3</sup>  
 Medium parameters used: f = 5800 MHz;  $\sigma = 5.264$  S/m;  $\epsilon_r = 34.9$ ;  $\rho = 1000$  kg/m<sup>3</sup>  
 Phantom section: Right Section

Measurement Standard: DASY5 (IEEE/IEC/ANSI C63.19-2007)

**DASY5 Configuration:**

- Probe: EX3DV4 - SN7307; ConvF(5.77, 5.77, 5.77) @ 5200 MHz; ConvF(5.6, 5.6, 5.6) @ 5300 MHz; ConvF(5.25, 5.25, 5.25) @ 5500 MHz; ConvF(5.1, 5.1, 5.1) @ 5600 MHz; ConvF(5, 5, 5) @ 5800 MHz; Calibrated: 2021-05-26
- Sensor-Surface: 1.4mm (Mechanical Surface Detection)
- Electronics: DAE4 Sn1556; Calibrated: 2022-01-12
- Phantom: MFP\_V5.1C (20deg probe tilt); Type: QD 000 P51 Cx; Serial: 1062
- DASY52 52.10.4(1535); SEMCAD X 14.6.14(7501)

**Dipole Calibration /Pin=100mW, d=10mm, f=5200 MHz/Zoom Scan,**  
**dist=1.4mm (8x8x7)/Cube 0:** Measurement grid: dx=4mm, dy=4mm, dz=1.4mm  
 Reference Value = 62.58 V/m; Power Drift = -0.01 dB  
 Peak SAR (extrapolated) = 29.1 W/kg  
**SAR(1 g) = 7.58 W/kg; SAR(10 g) = 2.18 W/kg**  
 Smallest distance from peaks to all points 3 dB below = 7.2 mm  
 Ratio of SAR at M2 to SAR at M1 = 66.7%  
 Maximum value of SAR (measured) = 17.3 W/kg

**Dipole Calibration /Pin=100mW, d=10mm, f=5300 MHz/Zoom Scan,**  
**dist=1.4mm (8x8x7)/Cube 0:** Measurement grid: dx=4mm, dy=4mm, dz=1.4mm  
 Reference Value = 63.71 V/m; Power Drift = 0.04 dB  
 Peak SAR (extrapolated) = 31.3 W/kg  
**SAR(1 g) = 7.88 W/kg; SAR(10 g) = 2.26 W/kg**  
 Smallest distance from peaks to all points 3 dB below = 7.2 mm  
 Ratio of SAR at M2 to SAR at M1 = 65.7%  
 Maximum value of SAR (measured) = 18.4 W/kg

Certificate No: Z22-60065

Page 8 of 10



Add: No.52 HuaYuanBei Road, Haidian District, Beijing, 100191, China  
 Tel: +86-10-62304633-2079 Fax: +86-10-62304633-2504  
 E-mail: ttl@chinattl.com http://www.chinattl.cn

**Dipole Calibration /Pin=100mW, d=10mm, f=5500 MHz/Zoom Scan,**  
**dist=1.4mm (8x8x7)/Cube 0:** Measurement grid: dx=4mm, dy=4mm, dz=1.4mm  
 Reference Value = 64.62 V/m; Power Drift = 0.01 dB  
 Peak SAR (extrapolated) = 34.7 W/kg  
**SAR(1 g) = 8.23 W/kg; SAR(10 g) = 2.33 W/kg**  
 Smallest distance from peaks to all points 3 dB below = 7.2 mm  
 Ratio of SAR at M2 to SAR at M1 = 63.9%  
 Maximum value of SAR (measured) = 19.6 W/kg

**Dipole Calibration /Pin=100mW, d=10mm, f=5600 MHz/Zoom Scan,**  
**dist=1.4mm (8x8x7)/Cube 0:** Measurement grid: dx=4mm, dy=4mm, dz=1.4mm  
 Reference Value = 68.14 V/m; Power Drift = -0.05 dB  
 Peak SAR (extrapolated) = 33.8 W/kg  
**SAR(1 g) = 8.02 W/kg; SAR(10 g) = 2.29 W/kg**  
 Smallest distance from peaks to all points 3 dB below = 7.2 mm  
 Ratio of SAR at M2 to SAR at M1 = 63.4%  
 Maximum value of SAR (measured) = 19.4 W/kg

**Dipole Calibration /Pin=100mW, d=10mm, f=5800 MHz/Zoom Scan,**  
**dist=1.4mm (8x8x7)/Cube 0:** Measurement grid: dx=4mm, dy=4mm, dz=1.4mm  
 Reference Value = 61.10 V/m; Power Drift = 0.04 dB  
 Peak SAR (extrapolated) = 35.1 W/kg  
**SAR(1 g) = 7.69 W/kg; SAR(10 g) = 2.16 W/kg**  
 Smallest distance from peaks to all points 3 dB below = 7.2 mm  
 Ratio of SAR at M2 to SAR at M1 = 61.4%  
 Maximum value of SAR (measured) = 18.8 W/kg

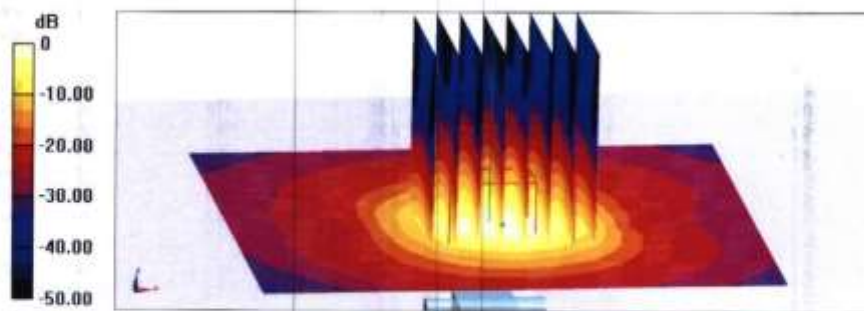

0 dB = 18.8 W/kg = 12.74 dBW/kg



In Collaboration with  
**Speag**  
**CALIBRATION LABORATORY**  
 Add: No.52 HuaYunBei Road, Haidian District, Beijing, 100191, China  
 Tel: +86-10-62304633-2079 Fax: +86-10-62304633-2504  
 E-mail: ctf@chinattl.com http://www.chinattl.cn



**Impedance Measurement Plot for Head TSL**

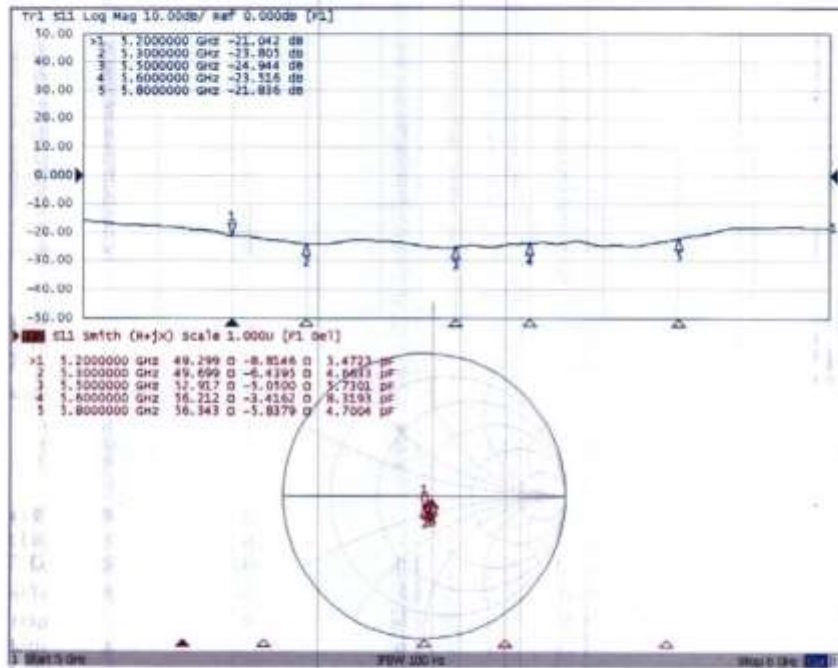



## Annex C: Revised History

Version	Revised Content
V00	Initial

Annex D: Accreditation Certificate



END OF REPORT