



Test Results

Original

Mode	Modulation	Sub-carrier spacing (KHz)	Channel/Frequency (MHz)	Peak-to-Average Power Ratio (PAPR)			Limit (dB)	Conclusion
				Peak(dBm)	Avg(dBm)	PAPR(dB)		
Band 4 Standalone	BPSK	3.75	20175/1732.5	21.82	18.00	3.82	≤13	PASS
	QPSK	3.75	20175/1732.5	21.38	17.95	3.43	≤13	PASS
	BPSK	15	20175/1732.5	21.59	15.12	6.47	≤13	PASS
	QPSK	15	20175/1732.5	21.53	15.09	6.44	≤13	PASS
Mode	Modulation	Sub-carrier spacing (KHz)	Channel/Frequency (MHz)	Peak-to-Average Power Ratio (PAPR)			Limit (dB)	Conclusion
Band 12 Standalone	BPSK	3.75	23095/707.5	22.12	18.35	3.77	≤13	PASS
	QPSK	3.75	23095/707.5	21.67	18.33	3.34	≤13	PASS
	BPSK	15	23095/707.5	21.98	15.51	6.47	≤13	PASS
	QPSK	15	23095/707.5	21.93	15.55	6.38	≤13	PASS
Mode	Modulation	Sub-carrier spacing (KHz)	Channel/Frequency (MHz)	Peak-to-Average Power Ratio (PAPR)			Limit (dB)	Conclusion
Band 13 Standalone	BPSK	3.75	23230/782	22.29	18.49	3.80	≤13	PASS
	QPSK	3.75	23230/782	21.90	18.50	3.40	≤13	PASS
	BPSK	15	23230/782	22.28	15.92	6.36	≤13	PASS
	QPSK	15	23230/782	22.23	15.86	6.37	≤13	PASS
Mode	Modulation	Sub-carrier spacing (KHz)	Channel/Frequency (MHz)	Peak-to-Average Power Ratio (PAPR)			Limit (dB)	Conclusion
Band 66 Standalone	BPSK	3.75	132322/1745	21.67	17.83	3.84	≤13	PASS
	QPSK	3.75	132322/1745	21.22	17.79	3.43	≤13	PASS
	BPSK	15	132322/1745	21.48	15.03	6.45	≤13	PASS
	QPSK	15	132322/1745	21.42	15.00	6.42	≤13	PASS
Mode	Modulation	Sub-carrier spacing (KHz)	Channel/Frequency (MHz)	Peak-to-Average Power Ratio (PAPR)			Limit (dB)	Conclusion
Band 71 Standalone	BPSK	3.75	133297/680.5	21.89	18.14	3.75	≤13	PASS
	QPSK	3.75	133297/680.5	21.42	18.09	3.33	≤13	PASS
	BPSK	15	133297/680.5	21.85	15.44	6.41	≤13	PASS
	QPSK	15	133297/680.5	21.78	15.47	6.31	≤13	PASS
Mode	Modulation	Sub-carrier spacing (KHz)	Channel/Frequency (MHz)	Peak-to-Average Power Ratio (PAPR)			Limit (dB)	Conclusion
Band 85 Standalone	BPSK	3.75	134092/707	22.22	18.46	3.76	≤13	PASS
	QPSK	3.75	134092/707	21.76	18.44	3.32	≤13	PASS
	BPSK	15	134092/707	22.08	15.66	6.42	≤13	PASS



	QPSK	15	134092/707	22.02	15.66	6.36	≤13	PASS
--	------	----	------------	-------	-------	------	-----	------

5.6 Frequency Stability

Ambient condition

Temperature	Relative humidity	Pressure
23°C ~25°C	45%~50%	101.5kPa

Method of Measurement

Frequency Stability (Temperature Variation)

The temperature inside the climate chamber is varied from -40°C to +85°C in 10°C step size.

(1)With all power removed, the temperature was decreased to -10°C and permitted to stabilize for three hours.

(2)Measure the carrier frequency with the test equipment in a “call mode”. These measurements should be made within 1 minute of powering up the mobile station, to prevent significant self warming.

(3) Repeat the above measurements at 10°C increments from -40°C to +85°C. Allow at least 1.5 hours at each temperature, un-powered, before making measurements.

Frequency Stability (Voltage Variation)

The frequency stability shall be measured with variation of primary supply voltage as follows:

(1) Vary primary supply voltage from 85 to 115 percent of the nominal value for other than hand carried battery equipment.

(2) For hand carried, battery powered equipment, reduce primary supply voltage to the battery-operating end point which shall be specified by the manufacturer.

This transceiver is specified to operate with an input voltage of between 2.6 V and 4.8V, with a nominal voltage of 3.3V.

Test setup

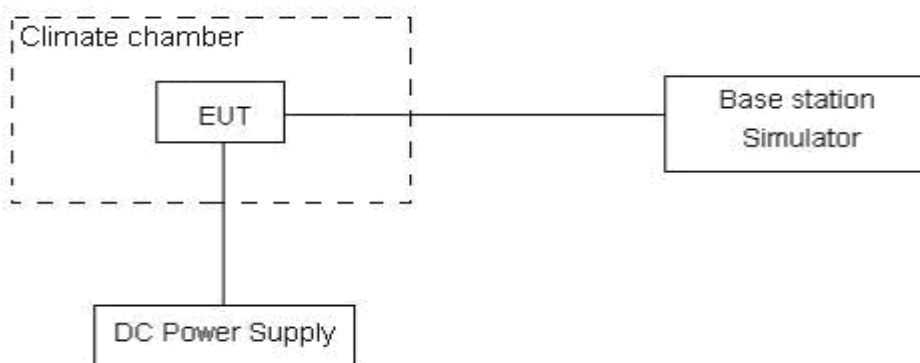

Limits

The frequency stability shall be sufficient to ensure that the fundamental emissions stay within the authorized bands of operation.

Measurement Uncertainty

The assessed measurement uncertainty to ensure 99.75% confidence level for the normal distribution is with the coverage factor $k = 3, U=0.01\text{ppm}$.



Test Result

Original

NB-IOT Band 4						
Condition		Freq.Error (Hz)	Freq.Error (Hz)	Frequency Stability (ppm)	Frequency Stability (ppm)	Verdict
Sub-carrier spacing (KHz)	3.75					
Temperature	Voltage	BPSK	QPSK	BPSK	QPSK	
Normal (25°C)	Normal	10.24	16.50	0.00545	0.00877	PASS
Extreme (85°C)		13.81	16.91	0.00734	0.00899	PASS
Extreme (80°C)		7.05	1.66	0.00375	0.00088	PASS
Extreme (70°C)		16.06	7.92	0.00854	0.00421	PASS
Extreme (60°C)		7.65	9.87	0.00407	0.00525	PASS
Extreme (50°C)		12.50	15.75	0.00665	0.00838	PASS
Extreme (40°C)		6.46	2.29	0.00344	0.00122	PASS
Extreme (30°C)		16.48	11.49	0.00877	0.00611	PASS
Extreme (20°C)		15.92	7.44	0.00847	0.00396	PASS
Extreme (10°C)		17.91	17.17	0.00953	0.00913	PASS
Extreme (0°C)		16.27	8.42	0.00865	0.00448	PASS
Extreme (-10°C)		7.80	15.01	0.00415	0.00798	PASS
Extreme (-20°C)		4.13	16.43	0.00220	0.00874	PASS
Extreme (-30°C)		11.11	12.78	0.00591	0.00680	PASS
Extreme (-40°C)		6.10	7.99	0.00324	0.00425	PASS
25°C	LV	14.10	4.04	0.00750	0.00215	PASS
	HV	6.05	15.86	0.00322	0.00844	PASS
Condition		Freq.Error (Hz)	Freq.Error (Hz)	Frequency Stability (ppm)	Frequency Stability (ppm)	Verdict
Sub-carrier spacing (KHz)	15					
Temperature	Voltage	BPSK	QPSK	BPSK	QPSK	
Normal (25°C)	Normal	11.69	16.81	0.00622	0.00894	PASS
Extreme (85°C)		12.91	7.88	0.00687	0.00419	PASS
Extreme (80°C)		7.50	5.30	0.00399	0.00282	PASS
Extreme (70°C)		6.40	15.39	0.00341	0.00819	PASS
Extreme (60°C)		15.93	2.53	0.00847	0.00135	PASS
Extreme (50°C)		11.54	3.01	0.00614	0.00160	PASS
Extreme (40°C)		16.41	16.97	0.00873	0.00903	PASS
Extreme (30°C)		14.11	9.27	0.00751	0.00493	PASS
Extreme (20°C)		16.84	13.57	0.00896	0.00722	PASS
Extreme (10°C)		13.43	16.47	0.00715	0.00876	PASS
Extreme (0°C)		9.68	7.93	0.00515	0.00422	PASS
Extreme (-10°C)		9.28	16.30	0.00494	0.00867	PASS



Extreme (-20°C)		3.93	3.25	0.00209	0.00173	PASS
Extreme (-30°C)		14.67	7.51	0.00781	0.00400	PASS
Extreme (-40°C)		17.01	11.26	0.00905	0.00599	PASS
25°C	LV	3.63	2.15	0.00193	0.00115	PASS
	HV	1.60	15.30	0.00085	0.00814	PASS

NB-IOT Band 12						
Condition		Freq.Error (Hz)	Freq.Error (Hz)	Frequency Stability (ppm)	Frequency Stability (ppm)	Verdict
Sub-carrier spacing (KHz)	3.75					
Temperature	Voltage	BPSK	QPSK	BPSK	QPSK	
Normal (25°C)	Normal	4.73	8.61	0.00252	0.00458	PASS
Extreme (85°C)		3.19	12.54	0.00170	0.00667	PASS
Extreme (80°C)		4.95	8.22	0.00263	0.00437	PASS
Extreme (70°C)		8.21	5.97	0.00437	0.00318	PASS
Extreme (60°C)		15.45	6.48	0.00822	0.00344	PASS
Extreme (50°C)		11.23	3.94	0.00597	0.00210	PASS
Extreme (40°C)		11.06	12.02	0.00589	0.00639	PASS
Extreme (30°C)		15.78	4.28	0.00839	0.00227	PASS
Extreme (20°C)		3.74	17.72	0.00199	0.00943	PASS
Extreme (10°C)		10.53	3.71	0.00560	0.00197	PASS
Extreme (0°C)		11.09	3.85	0.00590	0.00205	PASS
Extreme (-10°C)		15.68	17.29	0.00834	0.00920	PASS
Extreme (-20°C)		2.62	7.46	0.00139	0.00397	PASS
Extreme (-30°C)		11.84	16.70	0.00630	0.00888	PASS
Extreme (-40°C)		15.41	11.13	0.00819	0.00592	PASS
25°C	LV	6.43	13.11	0.00342	0.00697	PASS
	HV	2.92	16.32	0.00155	0.00868	PASS
Condition		Freq.Error (Hz)	Freq.Error (Hz)	Frequency Stability (ppm)	Frequency Stability (ppm)	Verdict
Sub-carrier spacing (KHz)	15					
Temperature	Voltage	BPSK	QPSK	BPSK	QPSK	
Normal (25°C)	Normal	9.46	12.58	0.00503	0.00669	PASS
Extreme (85°C)		4.40	5.25	0.00234	0.00279	PASS
Extreme (80°C)		7.05	8.02	0.00375	0.00427	PASS
Extreme (70°C)		8.51	8.48	0.00452	0.00451	PASS
Extreme (60°C)		8.13	15.34	0.00432	0.00816	PASS
Extreme (50°C)		3.37	7.00	0.00180	0.00373	PASS
Extreme (40°C)		13.58	2.69	0.00722	0.00143	PASS
Extreme (30°C)		15.04	11.28	0.00800	0.00600	PASS



Extreme (20°C)		1.66	1.48	0.00088	0.00079	PASS
Extreme (10°C)		1.85	12.83	0.00098	0.00682	PASS
Extreme (0°C)		17.30	13.76	0.00920	0.00732	PASS
Extreme (-10°C)		11.21	15.92	0.00596	0.00847	PASS
Extreme (-20°C)		17.60	5.27	0.00936	0.00280	PASS
Extreme (-30°C)		12.30	14.74	0.00654	0.00784	PASS
Extreme (-40°C)		8.35	2.30	0.00444	0.00122	PASS
25°C	LV	17.07	10.44	0.00908	0.00555	PASS
	HV	5.33	1.65	0.00283	0.00088	PASS

NB-IOT Band 13									
Condition		Sub-carrier spacing (KHz)	Voltage	Freq.Error (Hz)	Freq.Error (Hz)	Frequency Stability (ppm)	Frequency Stability (ppm)	Verdict	
				BPSK	QPSK	BPSK	QPSK		
Normal (25°C)	Normal	3.75	Voltage	11.42	11.78	0.00607	0.00627	PASS	
				Extreme (85°C)	1.99	2.13	0.00106	0.00113	PASS
				Extreme (80°C)	5.48	2.64	0.00292	0.00140	PASS
				Extreme (70°C)	4.93	1.98	0.00262	0.00105	PASS
				Extreme (60°C)	6.44	17.42	0.00343	0.00927	PASS
				Extreme (50°C)	7.99	1.08	0.00425	0.00057	PASS
				Extreme (40°C)	9.24	14.47	0.00491	0.00770	PASS
				Extreme (30°C)	12.93	5.78	0.00688	0.00307	PASS
				Extreme (20°C)	15.55	13.20	0.00827	0.00702	PASS
				Extreme (10°C)	16.32	11.45	0.00868	0.00609	PASS
				Extreme (0°C)	15.83	5.48	0.00842	0.00291	PASS
				Extreme (-10°C)	11.63	9.19	0.00618	0.00489	PASS
				Extreme (-20°C)	6.91	6.98	0.00367	0.00371	PASS
				Extreme (-30°C)	10.91	3.08	0.00580	0.00164	PASS
				Extreme (-40°C)	8.29	1.22	0.00441	0.00065	PASS
				25°C	LV	15.10	3.92	0.00803	0.00208
HV	17.41	3.16	0.00926		0.00168	PASS			
Condition		Sub-carrier spacing (KHz)	Voltage	Freq.Error (Hz)	Freq.Error (Hz)	Frequency Stability (ppm)	Frequency Stability (ppm)	Verdict	
				BPSK	QPSK	BPSK	QPSK		
Normal (25°C)	Normal	15	Voltage	3.01	11.42	0.00160	0.00607	PASS	
				Extreme (85°C)	2.49	3.89	0.00132	0.00207	PASS
				Extreme (80°C)	16.99	5.11	0.00904	0.00272	PASS
				Extreme (70°C)	2.35	1.27	0.00125	0.00068	PASS



Extreme (60°C)		11.24	15.57	0.00598	0.00828	PASS
Extreme (50°C)		8.69	13.55	0.00462	0.00721	PASS
Extreme (40°C)		8.92	9.02	0.00475	0.00480	PASS
Extreme (30°C)		1.07	3.13	0.00057	0.00166	PASS
Extreme (20°C)		4.89	12.15	0.00260	0.00646	PASS
Extreme (10°C)		17.44	14.67	0.00928	0.00780	PASS
Extreme (0°C)		13.40	16.99	0.00713	0.00904	PASS
Extreme (-10°C)		8.40	7.32	0.00447	0.00389	PASS
Extreme (-20°C)		6.30	3.26	0.00335	0.00174	PASS
Extreme (-30°C)		5.87	3.87	0.00312	0.00206	PASS
Extreme (-40°C)		4.90	6.88	0.00260	0.00366	PASS
25°C	LV	8.64	4.89	0.00459	0.00260	PASS
	HV	12.69	14.68	0.00675	0.00781	PASS

NB-IOT Band 66						
Condition		Freq.Error (Hz)	Freq.Error (Hz)	Frequency Stability (ppm)	Frequency Stability (ppm)	Verdict
Sub-carrier spacing (KHz)	3.75					
Temperature	Voltage	BPSK	QPSK	BPSK	QPSK	
Normal (25°C)	Normal	2.70	16.22	0.00143	0.00863	PASS
Extreme (85°C)		5.94	14.44	0.00316	0.00768	PASS
Extreme (80°C)		1.04	9.52	0.00055	0.00506	PASS
Extreme (70°C)		9.13	12.61	0.00485	0.00671	PASS
Extreme (60°C)		14.12	5.87	0.00751	0.00312	PASS
Extreme (50°C)		14.28	11.30	0.00759	0.00601	PASS
Extreme (40°C)		16.51	12.13	0.00878	0.00645	PASS
Extreme (30°C)		1.69	5.43	0.00090	0.00289	PASS
Extreme (20°C)		10.35	1.87	0.00551	0.00100	PASS
Extreme (10°C)		10.51	2.47	0.00559	0.00131	PASS
Extreme (0°C)		11.91	13.20	0.00633	0.00702	PASS
Extreme (-10°C)		7.74	12.45	0.00412	0.00662	PASS
Extreme (-20°C)		11.52	12.69	0.00613	0.00675	PASS
Extreme (-30°C)		1.21	1.14	0.00064	0.00061	PASS
Extreme (-40°C)		17.37	8.35	0.00924	0.00444	PASS
25°C	LV	12.53	9.42	0.00667	0.00501	PASS
	HV	17.46	2.77	0.00929	0.00147	PASS
Condition		Freq.Error (Hz)	Freq.Error (Hz)	Frequency Stability (ppm)	Frequency Stability (ppm)	Verdict
Sub-carrier spacing (KHz)	15					
Temperature	Voltage	BPSK	QPSK	BPSK	QPSK	



Normal (25°C)	Normal	3.03	17.57	0.00161	0.00935	PASS
Extreme (85°C)		15.12	6.18	0.00804	0.00329	PASS
Extreme (80°C)		14.31	7.70	0.00761	0.00410	PASS
Extreme (70°C)		17.65	9.88	0.00939	0.00526	PASS
Extreme (60°C)		14.30	6.82	0.00761	0.00363	PASS
Extreme (50°C)		10.04	11.23	0.00534	0.00598	PASS
Extreme (40°C)		13.31	8.34	0.00708	0.00443	PASS
Extreme (30°C)		7.11	14.30	0.00378	0.00761	PASS
Extreme (20°C)		14.22	5.60	0.00756	0.00298	PASS
Extreme (10°C)		12.13	3.52	0.00645	0.00187	PASS
Extreme (0°C)		12.47	1.34	0.00663	0.00071	PASS
Extreme (-10°C)		11.76	6.63	0.00626	0.00353	PASS
Extreme (-20°C)		8.91	4.69	0.00474	0.00249	PASS
Extreme (-30°C)		3.38	15.92	0.00180	0.00847	PASS
Extreme (-40°C)		8.07	1.23	0.00429	0.00065	PASS
25°C	LV	1.45	16.60	0.00077	0.00883	PASS
	HV	5.78	4.63	0.00307	0.00246	PASS

NB-IOT Band 71								
Condition		Sub-carrier spacing (KHz)	Voltage	Freq.Error (Hz)	Freq.Error (Hz)	Frequency Stability (ppm)	Frequency Stability (ppm)	Verdict
				BPSK	QPSK	BPSK	QPSK	
Normal	3.75	Voltage	Normal	7.21	16.55	0.00384	0.00880	PASS
				2.14	15.00	0.00114	0.00798	PASS
				9.01	11.90	0.00479	0.00633	PASS
				2.74	17.69	0.00146	0.00941	PASS
				14.23	15.84	0.00757	0.00843	PASS
				16.49	11.26	0.00877	0.00599	PASS
				14.93	16.19	0.00794	0.00861	PASS
				7.87	14.75	0.00419	0.00785	PASS
				4.50	4.53	0.00239	0.00241	PASS
				2.48	16.60	0.00132	0.00883	PASS
				12.19	16.91	0.00648	0.00900	PASS
				17.37	13.06	0.00924	0.00695	PASS
				17.79	3.48	0.00947	0.00185	PASS
				6.29	14.18	0.00335	0.00754	PASS
				7.00	17.11	0.00372	0.00910	PASS
25°C	3.75	Voltage	Normal	7.62	2.84	0.00405	0.00151	PASS
				17.52	17.63	0.00932	0.00938	PASS
Condition				Freq.Error	Freq.Error	Frequency	Frequency	Verdict



Sub-carrier spacing (KHz)	15	(Hz)	(Hz)	Stability (ppm)	Stability (ppm)	
		BPSK	QPSK	BPSK	QPSK	
Temperature	Voltage	BPSK	QPSK	BPSK	QPSK	
Normal (25°C)	Normal	1.89	14.85	0.00100	0.00790	PASS
Extreme (85°C)		4.81	2.90	0.00256	0.00154	PASS
Extreme (80°C)		2.39	12.55	0.00127	0.00668	PASS
Extreme (70°C)		1.07	12.14	0.00057	0.00646	PASS
Extreme (60°C)		14.03	6.34	0.00746	0.00337	PASS
Extreme (50°C)		13.86	11.63	0.00737	0.00619	PASS
Extreme (40°C)		3.94	12.03	0.00210	0.00640	PASS
Extreme (30°C)		14.09	10.72	0.00749	0.00570	PASS
Extreme (20°C)		17.20	16.30	0.00915	0.00867	PASS
Extreme (10°C)		17.63	8.67	0.00938	0.00461	PASS
Extreme (0°C)		10.56	6.22	0.00562	0.00331	PASS
Extreme (-10°C)		16.36	8.27	0.00870	0.00440	PASS
Extreme (-20°C)		12.02	6.87	0.00639	0.00365	PASS
Extreme (-30°C)		16.38	14.12	0.00871	0.00751	PASS
Extreme (-40°C)		15.55	15.83	0.00827	0.00842	PASS
25°C	LV	10.53	13.73	0.00560	0.00730	PASS
	HV	9.22	11.17	0.00491	0.00594	PASS

NB-IOT Band 85						
Condition		Freq.Error (Hz)	Freq.Error (Hz)	Frequency Stability (ppm)	Frequency Stability (ppm)	Verdict
Sub-carrier spacing (KHz)	3.75					
Temperature	Voltage	BPSK	QPSK	BPSK	QPSK	
Normal (25°C)	Normal	10.16	16.01	0.00540	0.00852	PASS
Extreme (85°C)		15.72	16.55	0.00836	0.00880	PASS
Extreme (80°C)		14.75	11.37	0.00784	0.00605	PASS
Extreme (70°C)		8.24	14.97	0.00438	0.00796	PASS
Extreme (60°C)		14.84	17.05	0.00789	0.00907	PASS
Extreme (50°C)		4.37	5.43	0.00232	0.00289	PASS
Extreme (40°C)		16.61	7.20	0.00884	0.00383	PASS
Extreme (30°C)		6.03	16.89	0.00321	0.00898	PASS
Extreme (20°C)		4.73	17.32	0.00251	0.00921	PASS
Extreme (10°C)		2.45	5.91	0.00130	0.00314	PASS
Extreme (0°C)		4.07	5.03	0.00217	0.00268	PASS
Extreme (-10°C)		16.43	8.43	0.00874	0.00448	PASS
Extreme (-20°C)		6.05	13.86	0.00322	0.00737	PASS
Extreme (-30°C)		15.20	5.40	0.00809	0.00287	PASS



Extreme (-40°C)		13.40	12.79	0.00713	0.00680	PASS
25°C	LV	17.59	17.13	0.00936	0.00911	PASS
	HV	16.66	4.70	0.00886	0.00250	PASS
Condition		Freq.Error (Hz)	Freq.Error (Hz)	Frequency Stability (ppm)	Frequency Stability (ppm)	Verdict
Sub-carrier spacing (KHz)	15					
Temperature	Voltage	BPSK	QPSK	BPSK	QPSK	
Normal (25°C)	Normal	1.84	15.27	0.00098	0.00812	
Extreme (85°C)		9.55	2.49	0.00508	0.00132	PASS
Extreme (80°C)		14.24	7.54	0.00758	0.00401	PASS
Extreme (70°C)		4.94	15.26	0.00263	0.00811	PASS
Extreme (60°C)		17.07	14.30	0.00908	0.00761	PASS
Extreme (50°C)		11.80	14.69	0.00628	0.00781	PASS
Extreme (40°C)		13.12	8.82	0.00698	0.00469	PASS
Extreme (30°C)		8.74	16.02	0.00465	0.00852	PASS
Extreme (20°C)		9.04	17.51	0.00481	0.00931	PASS
Extreme (10°C)		10.61	14.59	0.00564	0.00776	PASS
Extreme (0°C)		4.61	3.40	0.00245	0.00181	PASS
Extreme (-10°C)		3.59	2.56	0.00191	0.00136	PASS
Extreme (-20°C)		2.06	3.73	0.00109	0.00198	PASS
Extreme (-30°C)		1.88	15.31	0.00100	0.00815	PASS
Extreme (-40°C)	6.16	12.31	0.00327	0.00655	PASS	
25°C	LV	8.01	2.26	0.00426	0.00120	PASS
	HV	10.36	4.93	0.00551	0.00262	PASS

5.7 Spurious Emissions at Antenna Terminals

Ambient condition

Temperature	Relative humidity	Pressure
23°C ~25°C	45%~50%	101.5kPa

Method of Measurement

The EUT was connected to Spectrum Analyzer and Base Station Simulator via power Splitter. The measurement is carried out using a spectrum analyzer. The spectrum analyzer scans from 9kHz to the 10th harmonic of the carrier. The peak detector is used.

RBW is set to 100kHz, VBW is set to 300kHz for 30MHz~1GHz (NB-IOT Band 4/13/66)

RBW is set to 1MHz, VBW is set to 3MHz for above 1GHz (NB-IOT Band 4/13/66)

RBW is set to 1MHz, VBW is set to 3MHz (NB-IOT Band 12/71/85)

Sweep is set to ATUO.

Of those disturbances below (limit – 20 dB), the mark is not required for the EUT.

The modulation mode and RB allocation refer to section 5.1, using the maximum output power configuration.

Test setup

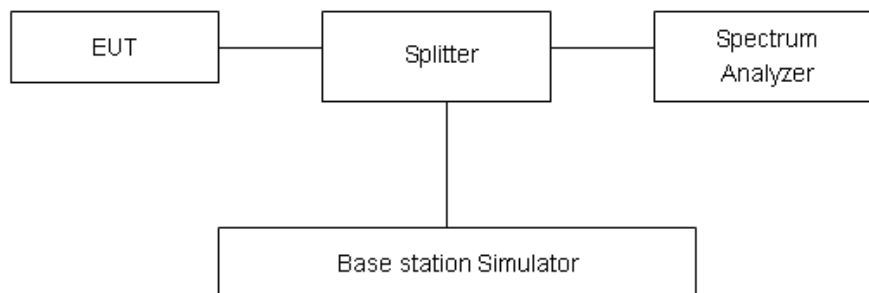

Limits

Rule Part 27.53(h) specifies that “for operations in the 1695-1710 MHz, 1710-1755 MHz, 1755-1780 MHz, 1915-1920 MHz, 1995-2000 MHz, 2000-2020 MHz, 2110-2155 MHz, 2155-2180 MHz, and 2180-2200 bands, the power of any emission outside a licensee's frequency block shall be attenuated below the transmitter power (P) in watts by at least $43 + 10 \log_{10} (P)$ dB..”

Rule Part 27.53 (g) For operations in the 600 MHz band and the 698-746 MHz band, the power of any emission outside a licensee's frequency band(s) of operation shall be attenuated below the transmitter power (P) within the licensed band(s) of operation, measured in watts, by at least $43 + 10 \log (P)$ dB. Compliance with this provision is based on the use of measurement instrumentation employing a resolution bandwidth of 100 kilohertz or greater. However, in the 100 kilohertz bands immediately outside and adjacent to a licensee's frequency block, a resolution bandwidth of at least 30 kHz may be employed.



Rule Part 27.53(f) For operations in the 746-758 MHz, 775-788 MHz, and 805-806 MHz bands, emissions in the band 1559-1610 MHz shall be limited to -70 dBW/MHz equivalent isotropically radiated power (EIRP) for wideband signals, and -80 dBW EIRP for discrete emissions of less than 700 Hz bandwidth. For the purpose of equipment authorization, a transmitter shall be tested with an antenna that is representative of the type that will be used with the equipment in normal operation.

Part 27.53(c) For operations in the 746-758 MHz band and the 776-788 MHz band, the power of any emission outside the licensee's frequency band(s) of operation shall be attenuated below the transmitter power (P) within the licensed band(s) of operation, measured in watts, in accordance with the following:

- (1) On any frequency outside the 746-758 MHz band, the power of any emission shall be attenuated outside the band below the transmitter power (P) by at least $43 + 10 \log (P)$ dB;
- (2) On any frequency outside the 776-788 MHz band, the power of any emission shall be attenuated outside the band below the transmitter power (P) by at least $43 + 10 \log (P)$ dB;
- (3) On all frequencies between 763-775 MHz and 793-805 MHz, by a factor not less than $76 + 10 \log (P)$ dB in a 6.25 kHz band segment, for base and fixed stations;
- (4) On all frequencies between 763-775 MHz and 793-805 MHz, by a factor not less than $65 + 10 \log (P)$ dB in a 6.25 kHz band segment, for mobile and portable stations;
- (5) Compliance with the provisions of paragraphs (c)(1) and (c)(2) of this section is based on the use of measurement instrumentation employing a resolution bandwidth of 100 kHz or greater. However, in the 100 kHz bands immediately outside and adjacent to the frequency block, a resolution bandwidth of at least 30 kHz may be employed;

Part 27.53(h)/(g) Limit		-13 dBm
Part 27.53(f) Limit	Limit out of the band 1559-1610 MHz	-13 dBm
	Limit in the band 1559-1610 MHz	-40 dBm

Measurement Uncertainty

The assessed measurement uncertainty to ensure 99.75% confidence level for the normal distribution is with the coverage factor $k = 1.96$.

Frequency	Uncertainty
9kHz-1GHz	0.684 dB
1GHz-27GHz	1.407 dB



Test Result

Sweep the whole frequency band through the range from 9kHz to the 10th harmonic of the carrier, the emissions more than 20 dB below the limit are not reported.

The signal beyond the limit is carrier.

Original

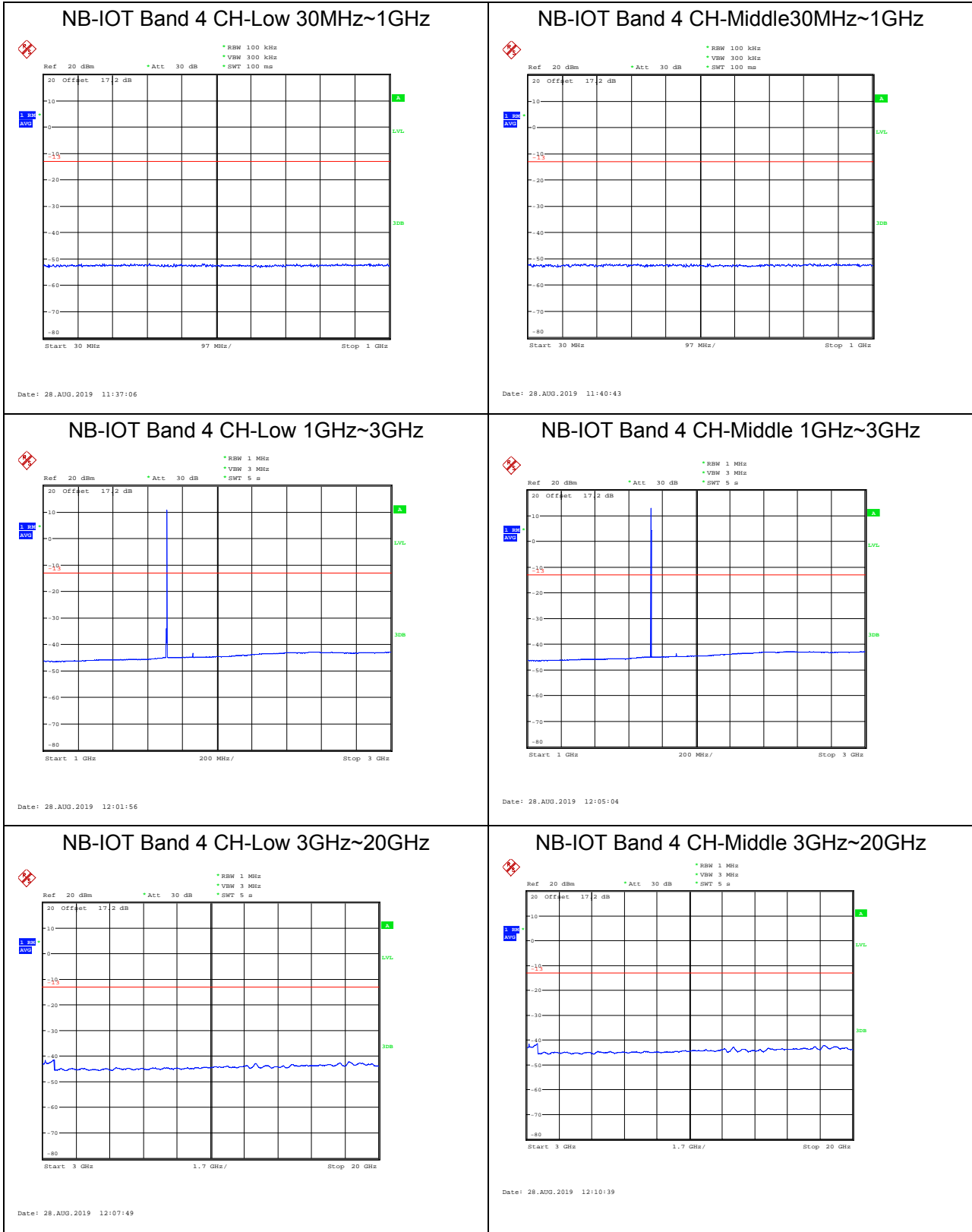

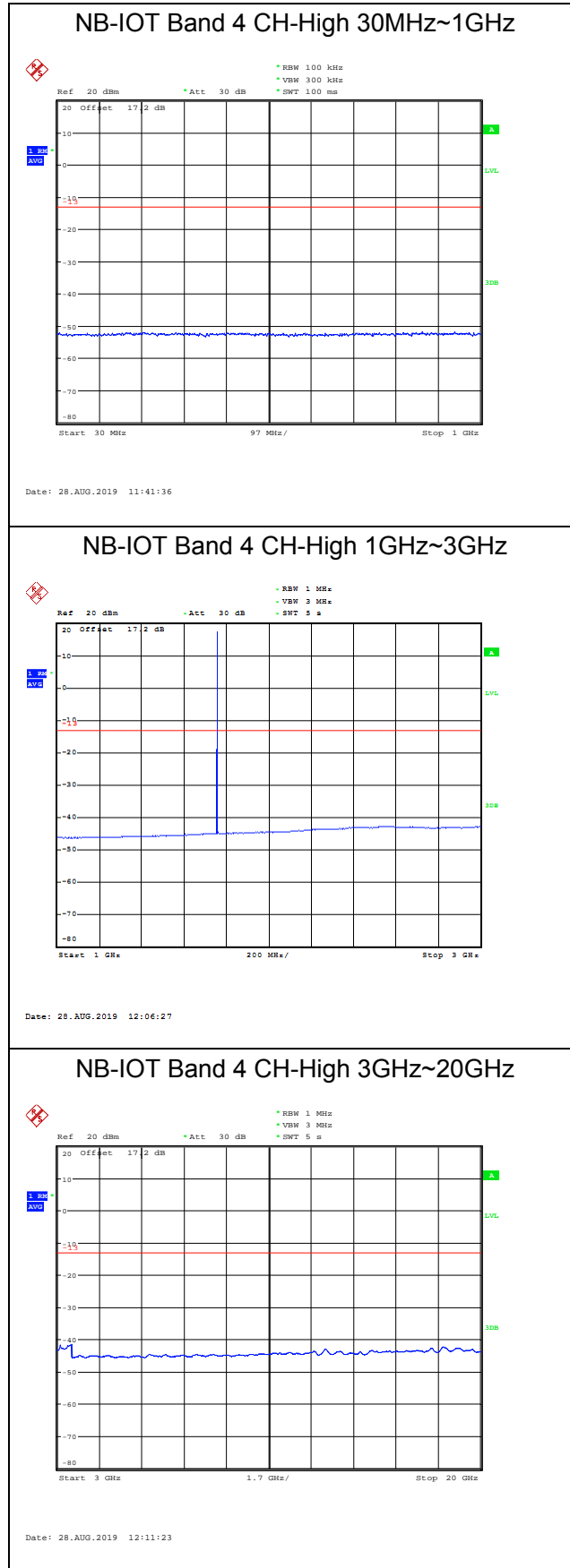



NB-IOT Band 12 CH-Low 30MHz-1GHz

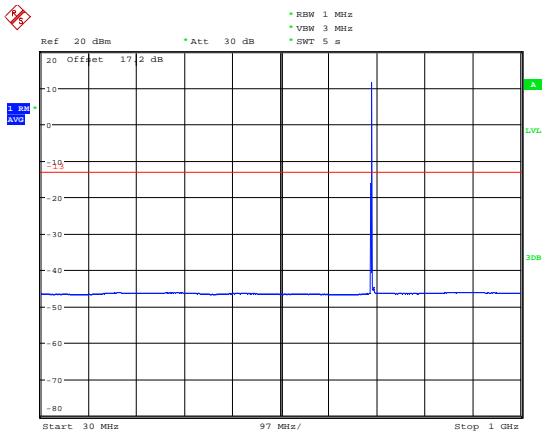

Date: 28.AUG.2019 12:35:00

NB-IOT Band 12 CH-Low 1GHz-9GHz

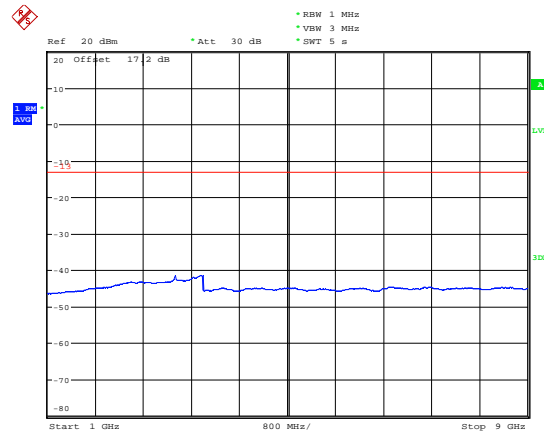

Date: 28.AUG.2019 12:45:03

NB-IOT Band 12 CH-Middle 30MHz-1GHz

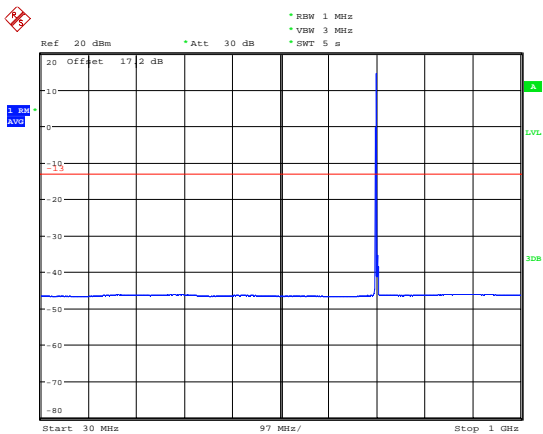

Date: 28.AUG.2019 12:38:10

NB-IOT Band 12 CH-Middle 1GHz-9GHz

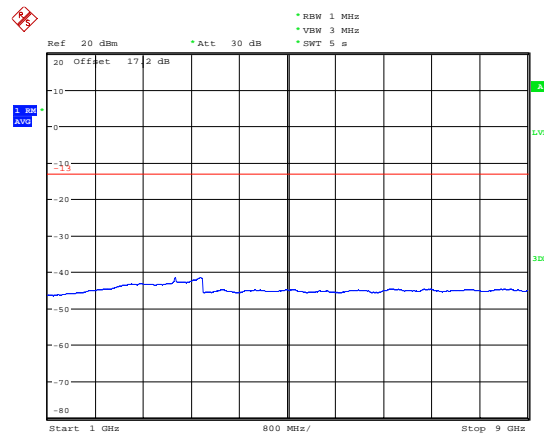

Date: 28.AUG.2019 12:49:06

NB-IOT Band 12 CH-High 30MHz-1GHz

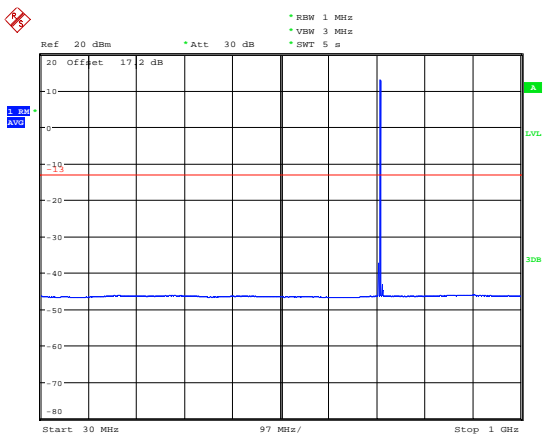

Date: 28.AUG.2019 12:40:33

NB-IOT Band 12 CH-High 1GHz-9GHz

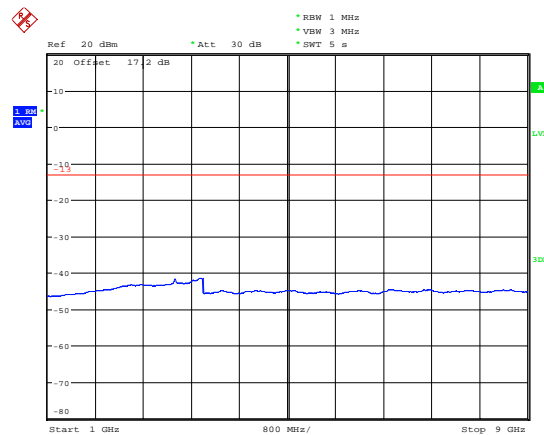

Date: 28.AUG.2019 12:50:48



NB-IOT Band 13 CH-Low 30MHz-1GHz

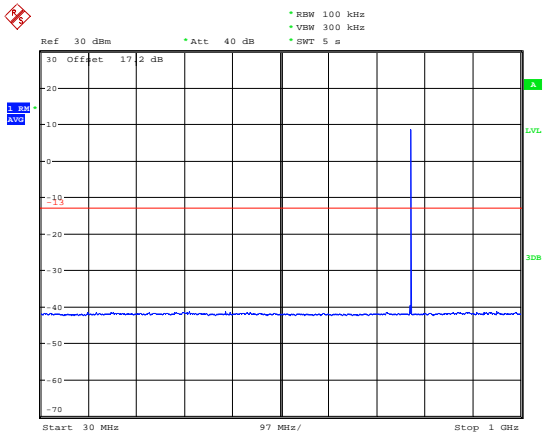

Date: 28.OCT.2019 19:45:00

NB-IOT Band 13 CH-Low 1GHz-9GHz

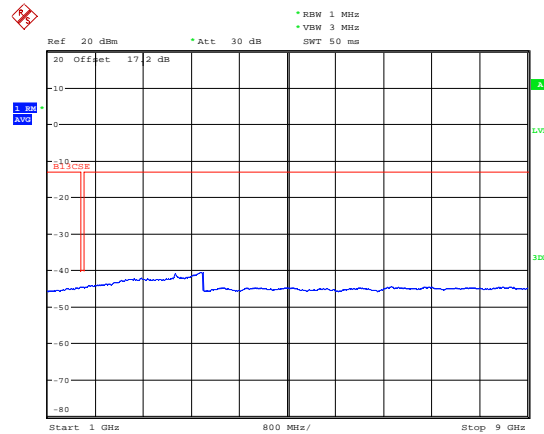

Date: 28.OCT.2019 21:01:46

NB-IOT Band 13 CH-Middle 30MHz-1GHz

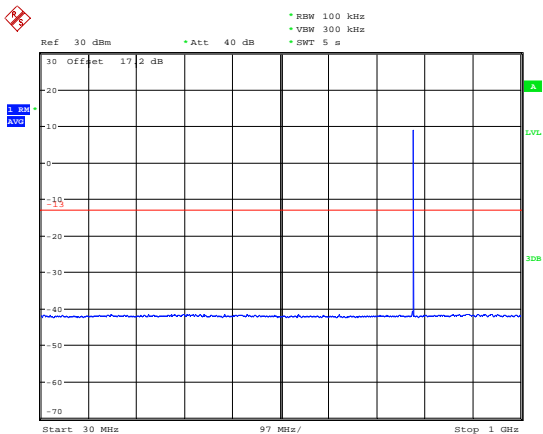

Date: 28.OCT.2019 19:46:53

NB-IOT Band 13 CH-Middle 1GHz-9GHz

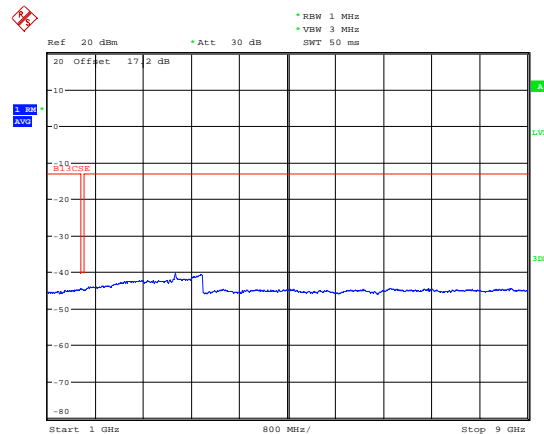

Date: 28.OCT.2019 21:03:01

NB-IOT Band 13 CH-High 30MHz-1GHz

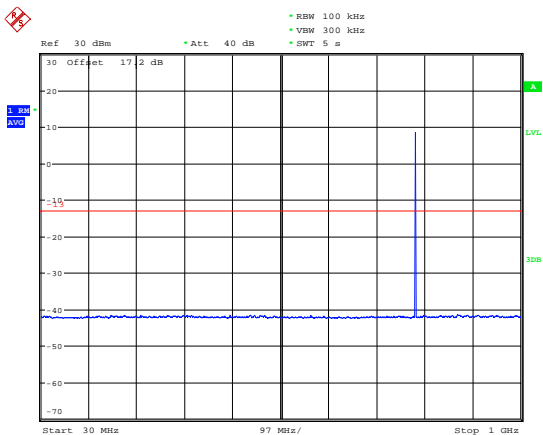

Date: 28.OCT.2019 19:48:41

NB-IOT Band 13 CH-High 1GHz-9GHz

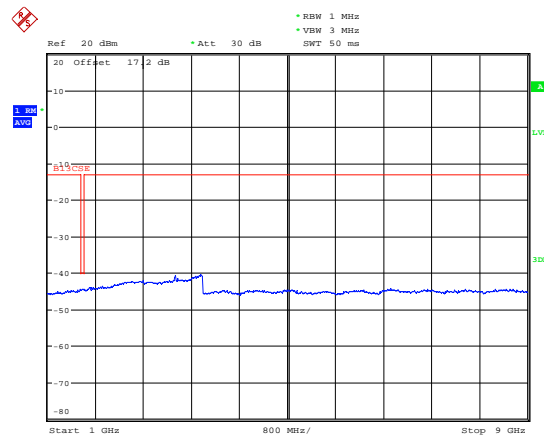

Date: 28.OCT.2019 21:03:42



NB-IOT Band 66 CH-Low 30MHz~1GHz

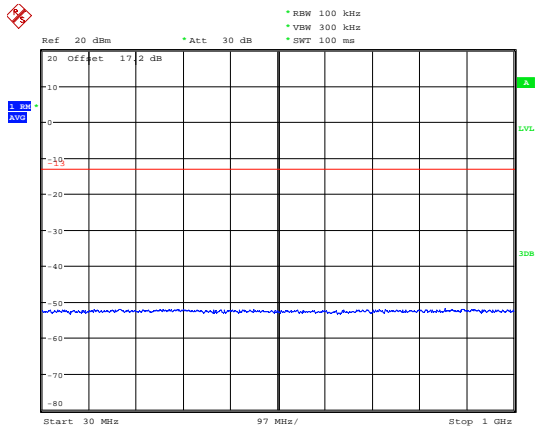

Date: 28.AUG.2019 11:53:58

NB-IOT Band 66 CH-Middle 30MHz~1GHz

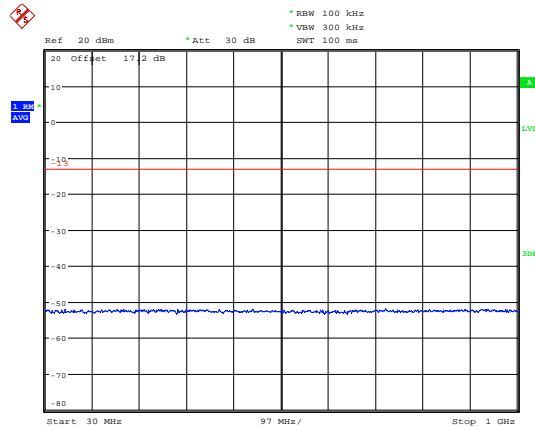

Date: 28.AUG.2019 11:59:29

NB-IOT Band 66 CH-Low 1GHz~3GHz

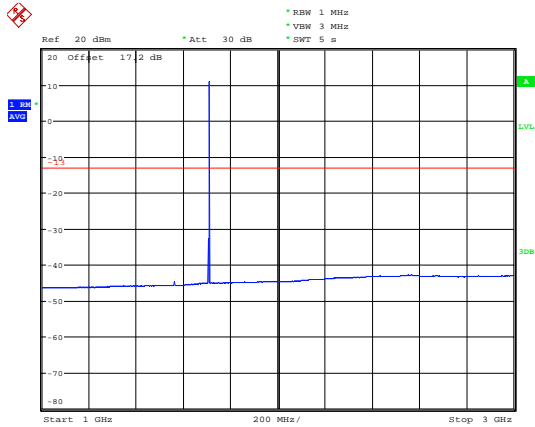

Date: 28.AUG.2019 15:59:44

NB-IOT Band 66 CH-Middle 1GHz~3GHz

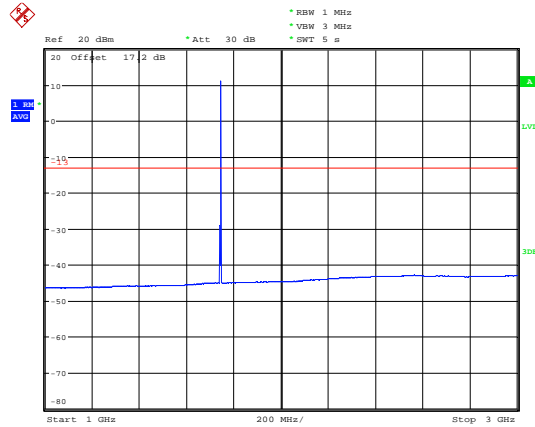

Date: 28.AUG.2019 16:01:53

NB-IOT Band 66 CH-Low 3GHz~20GHz

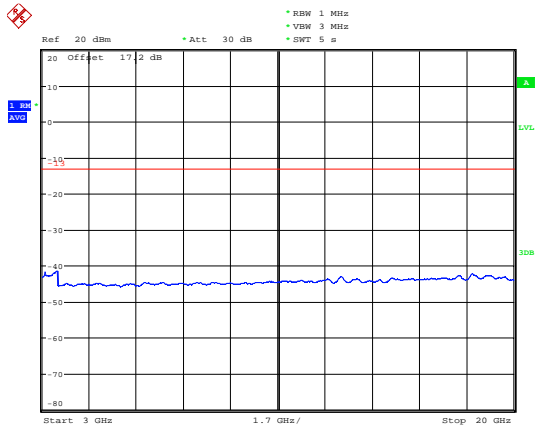

Date: 28.AUG.2019 16:04:47

NB-IOT Band 66 CH-Middle 3GHz~20GHz

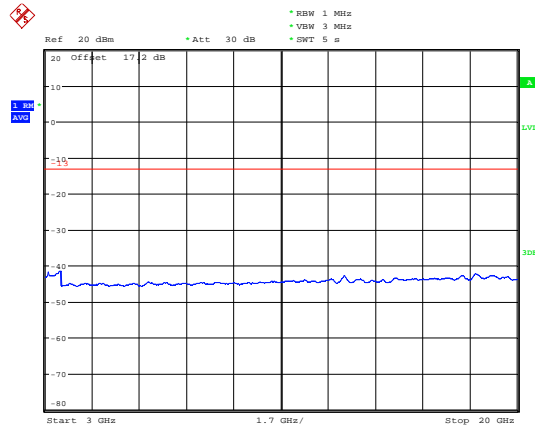

Date: 28.AUG.2019 16:08:07



NB-IOT Band 66 CH-High 30MHz~1GHz

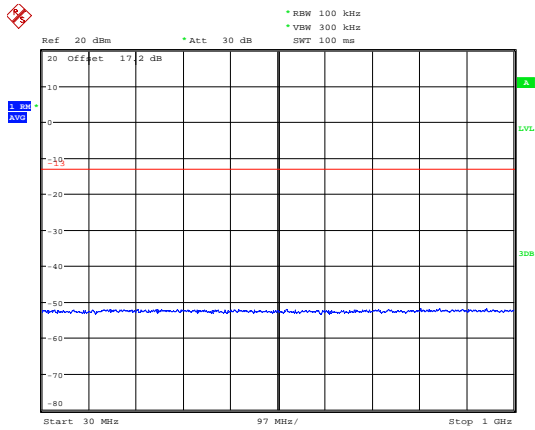

Date: 28.AUG.2019 11:58:44

NB-IOT Band 66 CH-High 1GHz~3GHz

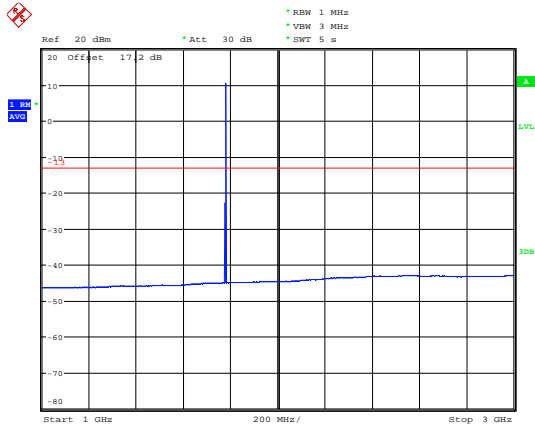

Date: 28.AUG.2019 16:03:53

NB-IOT Band 66 CH-High 3GHz~20GHz

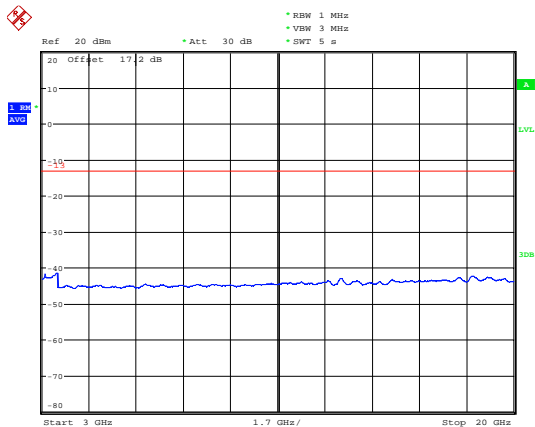

Date: 28.AUG.2019 16:08:49



NB-IOT Band 71 CH-Low 30MHz-1GHz

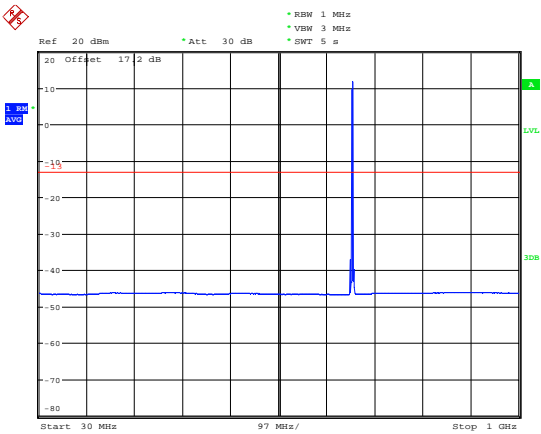

Date: 28.AUG.2019 16:12:57

NB-IOT Band 71 CH-Low 1GHz-9GHz

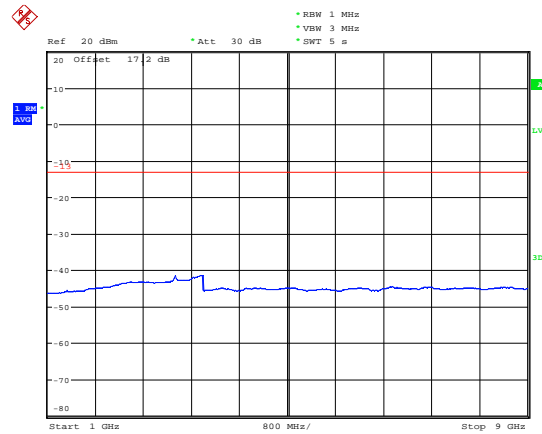

Date: 28.AUG.2019 16:17:20

NB-IOT Band 71 CH-Middle 30MHz-1GHz

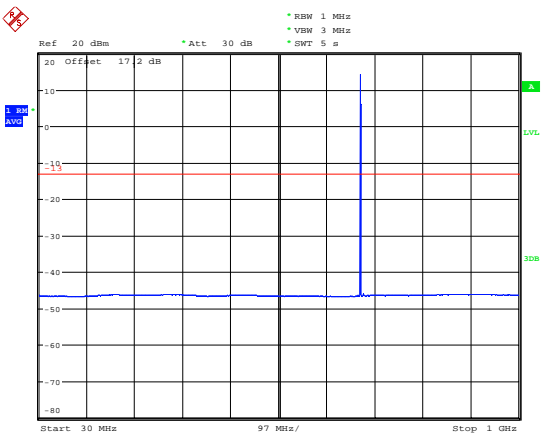

Date: 28.AUG.2019 16:14:45

NB-IOT Band 71 CH-Middle 1GHz-9GHz

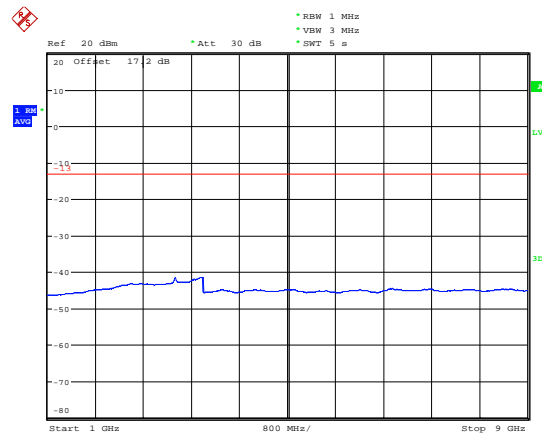

Date: 28.AUG.2019 16:18:50

NB-IOT Band 71 CH-High 30MHz-1GHz

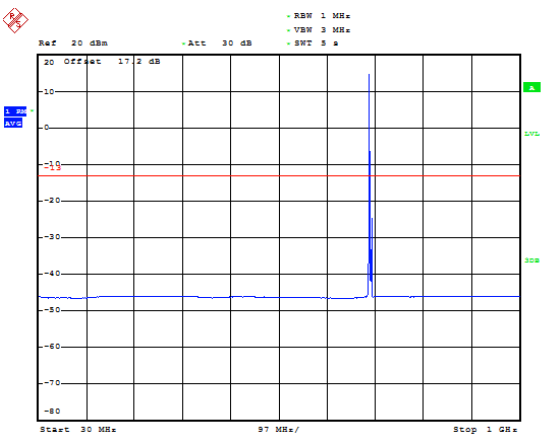

Date: 28.AUG.2019 16:19:50

NB-IOT Band 71 CH-High 1GHz-9GHz

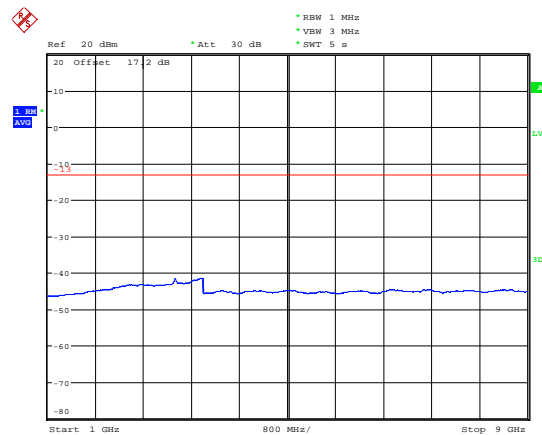

Date: 28.AUG.2019 16:20:00



NB-IOT Band 85 CH-Low 30MHz-1GHz

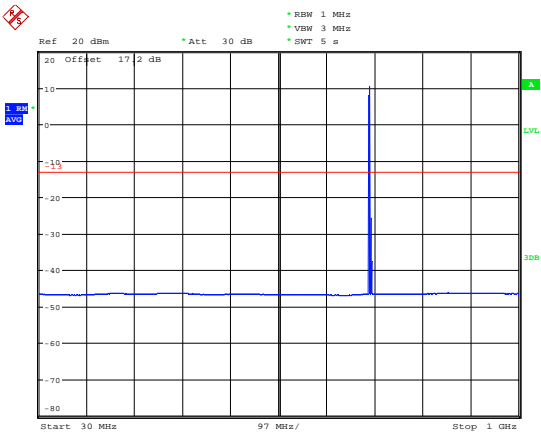

Date: 29.AUG.2019 11:00:34

NB-IOT Band 85 CH-Low 1GHz-9GHz

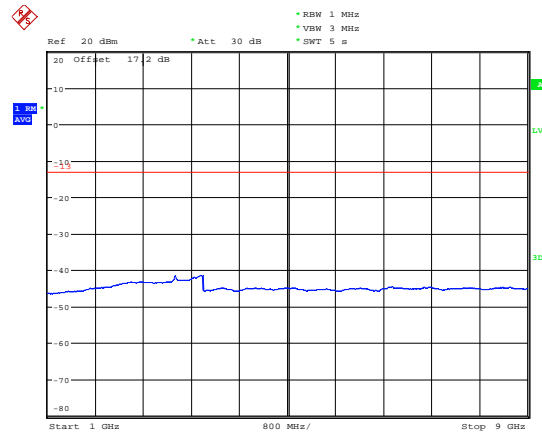

Date: 28.AUG.2019 17:01:58

NB-IOT Band 85 CH-Middle 30MHz-1GHz

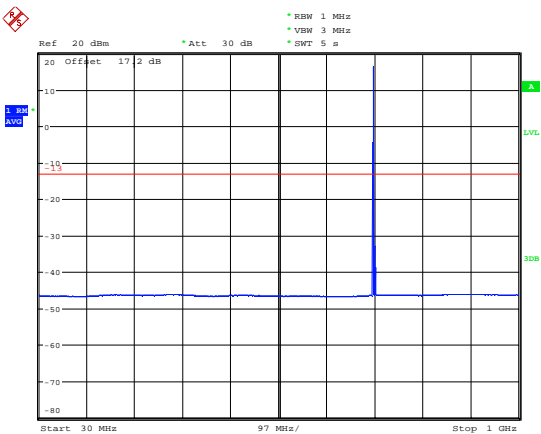

Date: 28.AUG.2019 16:57:53

NB-IOT Band 85 CH-Middle 1GHz-9GHz

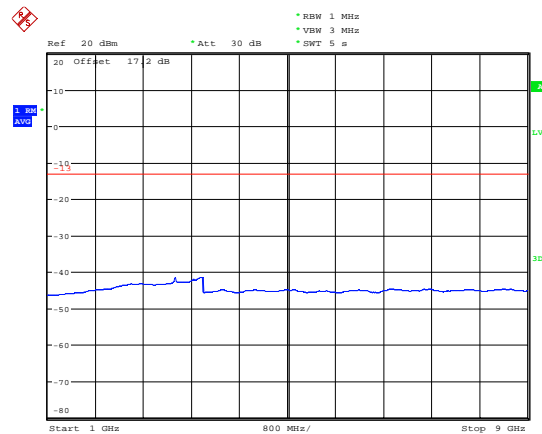

Date: 28.AUG.2019 17:06:19

NB-IOT Band 85 CH-High 30MHz-1GHz

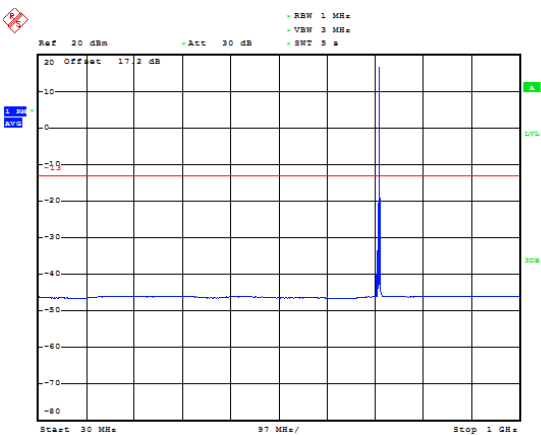

Date: 28.AUG.2019 16:58:58

NB-IOT Band 85 CH-High 1GHz-9GHz

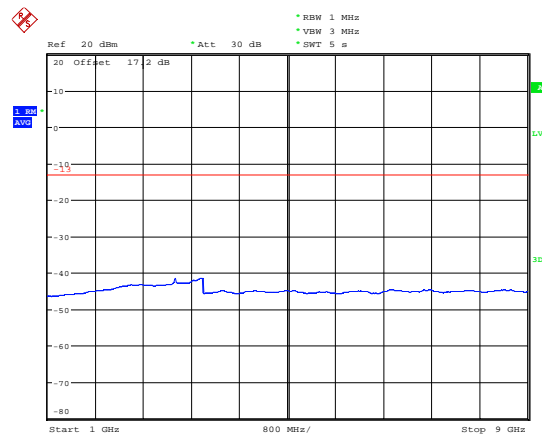

Date: 28.AUG.2019 17:06:28

5.8 Radiates Spurious Emission

Ambient condition

Temperature	Relative humidity	Pressure
23°C ~25°C	45%~50%	101.5kPa

Method of Measurement

1. The testing follows FCC KDB 971168D01v03r01 Section 5.8 and ANSI C63.26 (2015).
2. Below 1GHz:The EUT is placed on a turntable 0.8 meters above the ground in the chamber, 3 meter away from the antenna. The maximal emission value is acquired by adjusting the antenna height, polarisation and turntable azimuth. Normally, the height range of antenna is 1 m to 4 m, the azimuth range of turntable is 0° to 360°, and the receive antenna has two polarizations Vertical (V) and Horizontal (H). Above 1GHz:(Note: the FCC's permission to use 1.5m as an alternative per TCBC Conf call of Dec. 2, 2014.)The EUT is placed on a turntable 1.5 meters above the ground in the chamber, 3 meter away from the antenna. The maximal emission value is acquired by adjusting the antenna height, polarisation and turntable azimuth. Normally, the height range of antenna is 1 m to 4 m, the azimuth range of turntable is 0° to 360°, and the receive antenna has two polarizations Vertical (V) and Horizontal (H).
3. A loop antenna, A log-periodic antenna or horn antenna shall be substituted in place of the EUT. The log-periodic antenna will be driven by a signal generator and the level will be adjusted till the same power value on the spectrum analyzer or receiver. The level of the spurious emissions can be calculated through the level of the signal generator, cable loss, the gain of the substitution antenna and the reading of the spectrum analyzer or receiver.
4. The EUT is then put into continuously transmitting mode at its maximum power level during the test. Set Test Receiver or Spectrum RBW=200Hz, VBW=600Hz for 9kHz-150kHz, RBW=10kHz, VBW=30kHz-30MHz, RBW=100kHz, VBW=300kHz for 30MHz to 1GHz and RBW=1MHz, VBW=3MHz for above 1GHz And the maximum value of the receiver should be recorded as (Pr).
5. The EUT shall be replaced by a substitution antenna. In the chamber, a substitution antenna for the frequency band of interest is placed at the reference point of the chamber. An RF Signal source for the frequency band of interest is connected to the substitution antenna with a cable that has been constructed to not interfere with the radiation pattern of the antenna. A power (P_{Mea}) is applied to the input of the substitution antenna, and adjust the level of the signal generator output until the value of the receiver reach the previously recorded (Pr). The power of signal source (P_{Mea}) is recorded. The test should be performed by rotating the test item and adjusting the receiving antenna polarization.
6. An amplifier should be connected to the Signal Source output port. And the cable should be connect between the Amplifier and the Substitution Antenna. The cable loss (P_{cl}), the Substitution Antenna Gain (G_a) and the Amplifier Gain (P_{Ag}) should be recorded after test.
7. The measurement results are obtained as described below:
Power(EIRP)=P_{Mea}- P_{Ag} - P_{cl} + G_a
The measurement results are amend as described below:
Power(EIRP)=P_{Mea}- P_{cl} + G_a
8. This value is EIRP since the measurement is calibrated using an antenna of known gain (2.15 dBi)

and known input power. ERP can be calculated from EIRP by subtracting the gain of the dipole, $ERP = EIRP - 2.15\text{dBi}$.

The modulation mode and RB allocation refer to section 5.1, using the maximum output power configuration.

Test setup

9KHz~ 30MHz

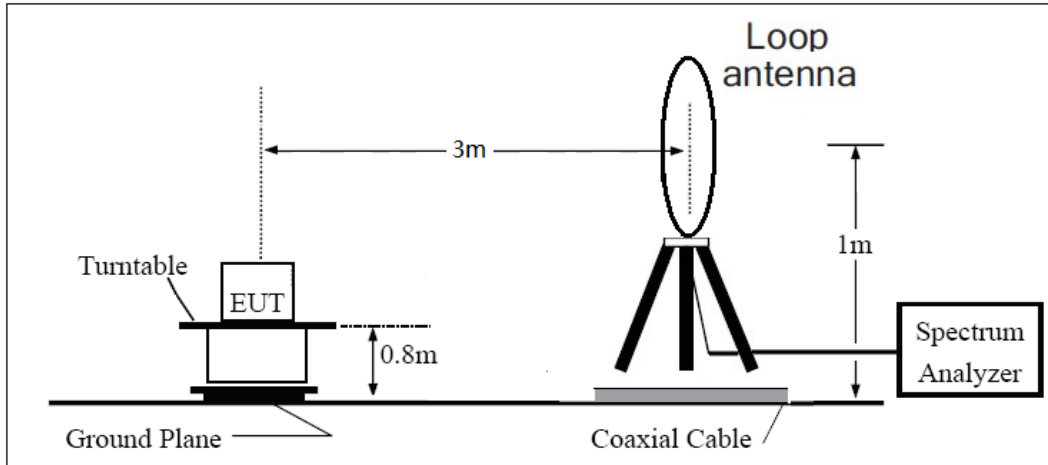

30MHz~ 1GHz

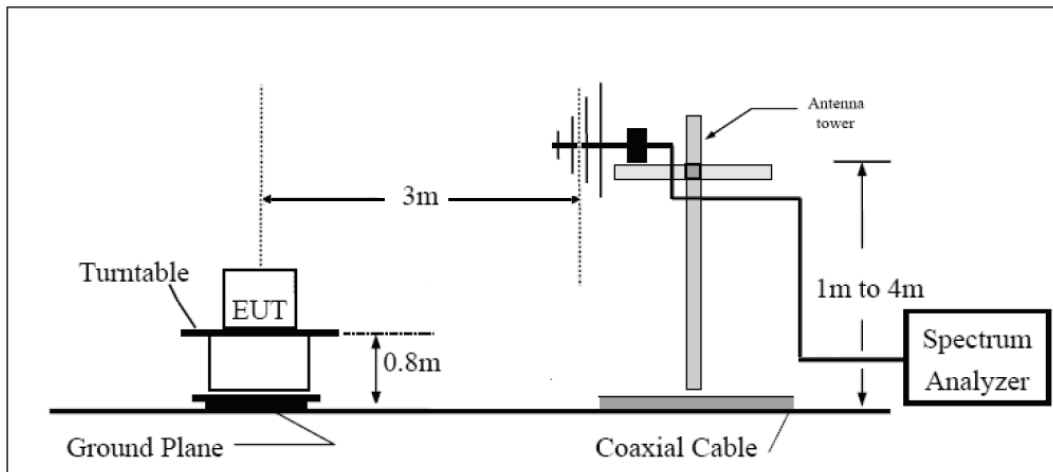

Above 1GHz

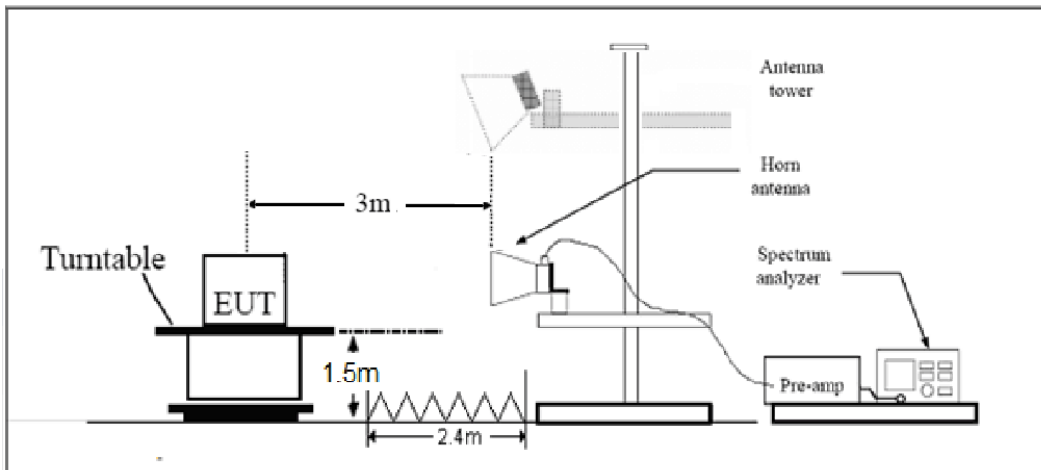

Note: Area side:2.4mX3.6m

Limits

Rule Part 27.53(h) specifies that “for operations in the 1695-1710 MHz, 1710-1755 MHz, 1755-1780 MHz, 1915-1920 MHz, 1995-2000 MHz, 2000-2020 MHz, 2110-2155 MHz, 2155-2180 MHz, and 2180-2200 bands, the power of any emission outside a licensee's frequency block shall be attenuated below the transmitter power (P) in watts by at least $43 + 10 \log_{10} (P)$ dB.”

Rule Part 27.53 (g) For operations in the 600 MHz band and the 698-746 MHz band, the power of any emission outside a licensee's frequency band(s) of operation shall be attenuated below the transmitter power (P) within the licensed band(s) of operation, measured in watts, by at least $43 + 10 \log (P)$ dB. Compliance with this provision is based on the use of measurement instrumentation employing a resolution bandwidth of 100 kilohertz or greater. However, in the 100 kilohertz bands immediately outside and adjacent to a licensee's frequency block, a resolution bandwidth of at least 30 kHz may be employed.

Rule Part 27.53(f) For operations in the 746-758 MHz, 775-788 MHz, and 805-806 MHz bands, emissions in the band 1559-1610 MHz shall be limited to -70 dBW/MHz equivalent isotropically radiated power (EIRP) for wideband signals, and -80 dBW EIRP for discrete emissions of less than 700 Hz bandwidth. For the purpose of equipment authorization, a transmitter shall be tested with an antenna that is representative of the type that will be used with the equipment in normal operation.

Rule Part 27.53 (c) For operations in the 746-758 MHz band and the 776-788 MHz band, the power of any emission outside the licensee's frequency band(s) of operation shall be attenuated below the transmitter power (P) within the licensed band(s) of operation, measured in watts, in accordance with the following:

- (1) On any frequency outside the 746-758 MHz band, the power of any emission shall be attenuated outside the band below the transmitter power (P) by at least $43 + 10 \log (P)$ dB;
- (2) On any frequency outside the 776-788 MHz band, the power of any emission shall be attenuated outside the band below the transmitter power (P) by at least $43 + 10 \log (P)$ dB;
- (3) On all frequencies between 763-775 MHz and 793-805 MHz, by a factor not less than $76 + 10 \log (P)$ dB in a 6.25 kHz band segment, for base and fixed stations;
- (4) On all frequencies between 763-775 MHz and 793-805 MHz, by a factor not less than $65 + 10 \log (P)$ dB in a 6.25 kHz band segment, for mobile and portable stations;
- (5) Compliance with the provisions of paragraphs (c)(1) and (c)(2) of this section is based on the use of measurement instrumentation employing a resolution bandwidth of 100 kHz or greater. However, in the 100 kHz bands immediately outside and adjacent to the frequency block, a resolution bandwidth of at least 30 kHz may be employed;

Part 27.53(a)/(h)/(g) Limit		-13 dBm
Part 27.53(f) Limit	Limit out of the band 1559-1610 MHz	-13 dBm
	Limit in the band 1559-1610 MHz	-40 dBm



Measurement Uncertainty

The assessed measurement uncertainty to ensure 95% confidence level for the normal distribution is with the coverage factor $k = \pm 1.96$, $U = \pm 3.55$ dB.

**Test Result**

Sweep the whole frequency band through the range from 9kHz to the 10th harmonic of the carrier, the emissions below the noise floor will not be recorded in the report.

Original

NB-IOT Band 4 CH-Low

Harmonic	Frequency (MHz)	SG (dBm)	Cable Loss (dB)	Gain (dBi)	Antenna Polarization	EIRP Level (dBm)	Limit (dBm)	Margin (dB)	Azimuth (deg)
2	3420	-65.08	2.6	10.15	Horizontal	-57.53	-13.00	44.53	135
3	5130	-63.53	2.4	11.35	Horizontal	-54.58	-13.00	41.58	180
4	6840	-59.40	4.5	10.85	Horizontal	-53.05	-13.00	40.05	315
5	8550	-57.11	5.1	11.35	Horizontal	-50.86	-13.00	37.86	135
6	10260	-54.23	5.3	11.95	Horizontal	-47.58	-13.00	34.58	225
7	11970	-54.17	5.5	13.55	Horizontal	-46.12	-13.00	33.12	90
8	13680	-51.84	6.3	13.75	Horizontal	-44.39	-13.00	31.39	135
9	15390	-53.29	6.7	13.85	Horizontal	-46.14	-13.00	33.14	45
10	17100	-51.57	6.8	14.25	Horizontal	-44.12	-13.00	31.12	180

Note: 1. The other Spurious RF Radiated emissions level is no more than noise floor.
2. The worst emission was found in the antenna is Horizontal position.

NB-IOT Band 4 CH-Middle

Harmonic	Frequency (MHz)	SG (dBm)	Cable Loss (dB)	Gain (dBi)	Antenna Polarization	EIRP Level (dBm)	Limit (dBm)	Margin (dB)	Azimuth (deg)
2	3461	-56.96	2.6	10.75	Horizontal	-48.81	-13.00	35.81	135
3	5191.5	-58.68	2.4	11.05	Horizontal	-50.03	-13.00	37.03	180
4	6922	-58.89	4.5	11.15	Horizontal	-52.24	-13.00	39.24	315
5	8652.5	-51.97	5.1	11.35	Horizontal	-45.72	-13.00	32.72	135
6	10383	-49.92	5.3	11.95	Horizontal	-43.27	-13.00	30.27	225
7	12113.5	-49.60	5.5	13.55	Horizontal	-41.55	-13.00	28.55	90
8	13844	-49.44	6.3	13.75	Horizontal	-41.99	-13.00	28.99	135
9	15574.5	-49.78	6.7	13.85	Horizontal	-42.63	-13.00	29.63	45
10	17305	-47.96	6.8	14.25	Horizontal	-40.51	-13.00	27.51	180



Note: 1.The other Spurious RF Radiated emissions level is no more than noise floor.
2. The worst emission was found in the antenna is Horizontal position.

NB-IOT Band 4 CH-High

Harmonic	Frequency (MHz)	SG (dBm)	Cable Loss (dB)	Gain (dBi)	Antenna Polarization	EIRP Level (dBm)	Limit (dBm)	Margin (dB)	Azimuth (deg)
2	3509.8	-58.37	2.6	10.15	Horizontal	-50.82	-13.00	37.82	135
3	5264.7	-64.44	2.4	11.05	Horizontal	-55.79	-13.00	42.79	180
4	7019.6	-59.61	4.5	11.15	Horizontal	-52.96	-13.00	39.96	315
5	8774.5	-56.19	5.1	11.35	Horizontal	-49.94	-13.00	36.94	135
6	10529.4	-54.89	5.3	11.95	Horizontal	-48.24	-13.00	35.24	225
7	12284.3	-54.10	5.5	13.55	Horizontal	-46.05	-13.00	33.05	90
8	14039.2	-52.01	6.3	13.75	Horizontal	-44.56	-13.00	31.56	135
9	15794.1	-53.21	6.7	13.85	Horizontal	-46.06	-13.00	33.06	45
10	17549	-51.92	6.8	14.25	Horizontal	-44.47	-13.00	31.47	180

Note: 1.The other Spurious RF Radiated emissions level is no more than noise floor.
2. The worst emission was found in the antenna is Horizontal position.

NB-IOT Band 12 CH-Low

Harmonic	Frequency (MHz)	SG (dBm)	Cable Loss (dB)	Gain (dBi)	Antenna Polarization	ERP Level (dBm)	Limit (dBm)	Margin (dB)	Azimuth (deg)
2	1398.2	-46.83	2.00	10.15	Horizontal	-40.83	-13.00	27.83	315
3	2097.3	-57.48	2.50	11.35	Horizontal	-50.78	-13.00	37.78	90
4	2796.4	-60.67	4.20	10.85	Horizontal	-56.17	-13.00	43.17	45
5	3495.5	-57.47	5.20	11.35	Horizontal	-53.47	-13.00	40.47	135
6	4194.6	-59.28	5.50	11.95	Horizontal	-54.98	-13.00	41.98	180
7	4893.7	-60.86	5.70	13.55	Horizontal	-55.16	-13.00	42.16	45
8	5592.8	-59.80	6.30	13.75	Horizontal	-54.50	-13.00	41.50	225
9	6291.9	-57.80	6.80	13.85	Horizontal	-52.90	-13.00	39.90	180
10	6991.0	-56.68	6.90	14.25	Horizontal	-51.48	-13.00	38.48	180

Note: 1.The other Spurious RF Radiated emissions level is no more than noise floor.
2. The worst emission was found in the antenna is Horizontal position.

NB-IOT Band 12 CH-Middle

Harmonic	Frequency (MHz)	SG (dBm)	Cable Loss (dB)	Gain (dBi)	Antenna Polarization	ERP Level (dBm)	Limit (dBm)	Margin (dB)	Azimuth (deg)
2	1415.0	-59.85	2.00	10.75	Horizontal	-53.25	-13.00	40.25	270
3	2122.5	-60.08	2.51	11.05	Horizontal	-53.69	-13.00	40.69	315
4	2830.0	-63.66	4.20	11.15	Horizontal	-58.86	-13.00	45.86	180
5	3537.5	-60.07	5.20	11.15	Horizontal	-56.27	-13.00	43.27	90
6	4245.0	-61.54	5.50	11.95	Horizontal	-57.24	-13.00	44.24	45
7	4952.5	-61.53	5.70	13.55	Horizontal	-55.83	-13.00	42.83	90
8	5660.0	-60.89	6.30	13.75	Horizontal	-55.59	-13.00	42.59	135
9	6367.5	-58.44	6.80	13.85	Horizontal	-53.54	-13.00	40.54	180
10	7075.0	-55.41	6.90	14.25	Horizontal	-50.21	-13.00	37.21	315

Note: 1.The other Spurious RF Radiated emissions level is no more than noise floor.
 2. The worst emission was found in the antenna is Horizontal position.

NB-IOT Band 12 CH-High

Harmonic	Frequency (MHz)	SG (dBm)	Cable Loss (dB)	Gain (dBi)	Antenna Polarization	ERP Level (dBm)	Limit (dBm)	Margin (dB)	Azimuth (deg)
2	1431.8	-55.19	2.00	10.15	Horizontal	-49.19	-13.00	36.19	90
3	2147.7	-50.65	2.51	11.05	Horizontal	-44.26	-13.00	31.26	45
4	2863.6	-64.17	4.20	11.15	Horizontal	-59.37	-13.00	46.37	90
5	3579.5	-60.53	5.20	11.15	Horizontal	-56.73	-13.00	43.73	135
6	4295.4	-60.92	5.50	11.95	Horizontal	-56.62	-13.00	43.62	225
7	5011.3	-60.94	5.70	13.55	Horizontal	-55.24	-13.00	42.24	90
8	5727.2	-61.17	6.30	13.75	Horizontal	-55.87	-13.00	42.87	135
9	6443.1	-58.78	6.80	13.85	Horizontal	-53.88	-13.00	40.88	45
10	7159.0	-55.89	6.90	14.25	Horizontal	-50.69	-13.00	37.69	225

Note: 1.The other Spurious RF Radiated emissions level is no more than noise floor.
 2. The worst emission was found in the antenna is Horizontal position.



NB-IOT Band 13 CH-Low

Harmonic	Frequency (MHz)	SG (dBm)	Cable Loss (dB)	Gain (dBi)	Antenna Polarization	ERP Level (dBm)	Limit (dBm)	Margin (dB)	Azimuth (deg)
2	1554.2	-58.73	2.00	10.15	Horizontal	-52.73	-13.00	39.73	45
3	2331.3	-46.36	2.50	11.35	Horizontal	-39.66	-13.00	26.66	315
4	3108.4	-57.30	4.20	10.85	Horizontal	-52.80	-13.00	39.80	180
5	3885.5	-60.00	5.20	11.35	Horizontal	-56.00	-13.00	43.00	90
6	4662.6	-59.99	5.50	11.95	Horizontal	-55.69	-13.00	42.69	45
7	5439.7	-60.97	5.70	13.55	Horizontal	-55.27	-13.00	42.27	90
8	6216.8	-59.12	6.30	13.75	Horizontal	-53.82	-13.00	40.82	135
9	6993.9	-56.12	6.80	13.85	Horizontal	-51.22	-13.00	38.22	180
10	7771.0	-54.63	6.90	14.25	Horizontal	-49.43	-13.00	36.43	45

Note: 1.The other Spurious RF Radiated emissions level is no more than noise floor.
2. The worst emission was found in the antenna is Horizontal position.

NB-IOT Band 13CH-Middle

Harmonic	Frequency (MHz)	SG (dBm)	Cable Loss (dB)	Gain (dBi)	Antenna Polarization	ERP Level (dBm)	Limit (dBm)	Margin (dB)	Azimuth (deg)
2	1564.0	-60.47	2.00	10.75	Horizontal	-53.87	-40.00	13.87	90
3	2346.0	-48.12	2.51	11.05	Horizontal	-41.73	-13.00	28.73	45
4	3128.0	-58.76	4.20	11.15	Horizontal	-53.96	-13.00	40.96	225
5	3910.0	-59.13	5.20	11.15	Horizontal	-55.33	-13.00	42.33	180
6	4692.0	-59.96	5.50	11.95	Horizontal	-55.66	-13.00	42.66	180
7	5474.0	-59.97	5.70	13.55	Horizontal	-54.27	-13.00	41.27	90
8	6256.0	-58.99	6.30	13.75	Horizontal	-53.69	-13.00	40.69	45
9	7038.0	-54.87	6.80	13.85	Horizontal	-49.97	-13.00	36.97	90
10	7820.0	-54.71	6.90	14.25	Horizontal	-49.51	-13.00	36.51	135

Note: 1.The other Spurious RF Radiated emissions level is no more than noise floor.
2. The worst emission was found in the antenna is Horizontal position.



NB-IOT Band 13 CH-High

Harmonic	Frequency (MHz)	SG (dBm)	Cable Loss (dB)	Gain (dBi)	Antenna Polarization	ERP Level (dBm)	Limit (dBm)	Margin (dB)	Azimuth (deg)
2	1573.8	-62.98	2.00	10.15	Horizontal	-56.98	-40.00	16.98	270
3	2360.7	-48.46	2.51	11.05	Horizontal	-42.07	-13.00	29.07	315
4	3147.6	-59.64	4.20	11.15	Horizontal	-54.84	-13.00	41.84	180
5	3934.5	-59.95	5.20	11.15	Horizontal	-56.15	-13.00	43.15	315
6	4721.4	-59.81	5.50	11.95	Horizontal	-55.51	-13.00	42.51	135
7	5508.3	-59.78	5.70	13.55	Horizontal	-54.08	-13.00	41.08	225
8	6295.2	-56.75	6.30	13.75	Horizontal	-51.45	-13.00	38.45	90
9	7082.1	-54.91	6.80	13.85	Horizontal	-50.01	-13.00	37.01	135
10	7869.0	-54.22	6.90	14.25	Horizontal	-49.02	-13.00	36.02	45

Note: 1.The other Spurious RF Radiated emissions level is no more than noise floor.

2. The worst emission was found in the antenna is Horizontal position.

NB-IOT Band 66 CH-Low

Harmonic	Frequency (MHz)	SG (dBm)	Cable Loss (dB)	Gain (dBi)	Antenna Polarization	EIRP Level (dBm)	Limit (dBm)	Margin (dB)	Azimuth (deg)
2	3420.2	-54.76	2.6	10.15	Horizontal	-47.21	-13.00	34.21	45
3	5130.3	-61.68	2.4	11.35	Horizontal	-52.73	-13.00	39.73	315
4	6840.4	-58.21	4.5	10.85	Horizontal	-51.86	-13.00	38.86	90
5	8550.5	-56.02	5.1	11.35	Horizontal	-49.77	-13.00	36.77	45
6	10260.6	-52.31	5.3	11.95	Horizontal	-45.66	-13.00	32.66	270
7	11970.7	-53.22	5.5	13.55	Horizontal	-45.17	-13.00	32.17	315
8	13680.8	-52.74	6.3	13.75	Horizontal	-45.29	-13.00	32.29	180
9	15390.9	-53.72	6.7	13.85	Horizontal	-46.57	-13.00	33.57	90
10	17101	-50.64	6.8	14.25	Horizontal	-43.19	-13.00	30.19	45

Note: 1.The other Spurious RF Radiated emissions level is no more than noise floor.

2. The worst emission was found in the antenna is Horizontal position.



NB-IOT Band 66 CH-Middle

Harmonic	Frequency (MHz)	SG (dBm)	Cable Loss (dB)	Gain (dBi)	Antenna Polarization	EIRP Level (dBm)	Limit (dBm)	Margin (dB)	Azimuth (deg)
2	3490	-58.18	2.6	10.75	Horizontal	-50.03	-13.00	37.03	135
3	5235	-63.07	2.4	11.05	Horizontal	-54.42	-13.00	41.42	180
4	6980	-59.02	4.5	11.15	Horizontal	-52.37	-13.00	39.37	45
5	8725	-56.67	5.1	11.35	Horizontal	-50.42	-13.00	37.42	225
6	10470	-54.11	5.3	11.95	Horizontal	-47.46	-13.00	34.46	180
7	12215	-54.86	5.5	13.55	Horizontal	-46.81	-13.00	33.81	180
8	13960	-51.21	6.3	13.75	Horizontal	-43.76	-13.00	30.76	90
9	15705	-53.14	6.7	13.85	Horizontal	-45.99	-13.00	32.99	45
10	17450	-52.45	6.8	14.25	Horizontal	-45.00	-13.00	32.00	90

Note: 1.The other Spurious RF Radiated emissions level is no more than noise floor.

2. The worst emission was found in the antenna is Horizontal position.

NB-IOT Band 66 CH-High

Harmonic	Frequency (MHz)	SG (dBm)	Cable Loss (dB)	Gain (dBi)	Antenna Polarization	EIRP Level (dBm)	Limit (dBm)	Margin (dB)	Azimuth (deg)
2	3559.8	-58.95	2.6	10.15	Horizontal	-51.40	-13.00	38.40	135
3	5339.7	-64.34	2.4	11.05	Horizontal	-55.69	-13.00	42.69	180
4	7119.6	-56.77	4.5	11.15	Horizontal	-50.12	-13.00	37.12	315
5	8899.5	-55.43	5.1	11.35	Horizontal	-49.18	-13.00	36.18	135
6	10679.4	-53.28	5.3	11.95	Horizontal	-46.63	-13.00	33.63	225
7	12459.3	-53.55	5.5	13.55	Horizontal	-45.50	-13.00	32.50	90
8	14239.2	-52.63	6.3	13.75	Horizontal	-45.18	-13.00	32.18	135
9	16019.1	-52.93	6.7	13.85	Horizontal	-45.78	-13.00	32.78	45
10	17799	-50.77	6.8	14.25	Horizontal	-43.32	-13.00	30.32	180

Note: 1.The other Spurious RF Radiated emissions level is no more than noise floor.

2. The worst emission was found in the antenna is Horizontal position.



NB-IOT Band 71 CH-Low

Harmonic	Frequency (MHz)	SG (dBm)	Cable Loss (dB)	Gain (dBi)	Antenna Polarization	ERP Level (dBm)	Limit (dBm)	Margin (dB)	Azimuth (deg)
2	1331.0	-45.99	2.00	10.15	Horizontal	-39.99	-13.00	26.99	0
3	1996.5	-44.36	2.50	11.35	Horizontal	-37.66	-13.00	24.66	45
4	2662.0	-56.41	4.20	10.85	Horizontal	-51.91	-13.00	38.91	135
5	3327.5	-54.49	5.20	11.35	Horizontal	-50.49	-13.00	37.49	270
6	3993.0	-53.07	5.50	11.95	Horizontal	-48.77	-13.00	35.77	315
7	4658.5	-53.21	5.70	13.55	Horizontal	-47.51	-13.00	34.51	270
8	5324.0	-52.15	6.30	13.75	Horizontal	-46.85	-13.00	33.85	45
9	5989.5	-51.75	6.80	13.85	Horizontal	-46.85	-13.00	33.85	270
10	6655.0	-50.00	6.90	14.25	Horizontal	-44.80	-13.00	31.80	0

Note: 1.The other Spurious RF Radiated emissions level is no more than noise floor.
2. The worst emission was found in the antenna is Horizontal position.

NB-IOT Band 71 CH-Middle

Harmonic	Frequency (MHz)	SG (dBm)	Cable Loss (dB)	Gain (dBi)	Antenna Polarization	ERP Level (dBm)	Limit (dBm)	Margin (dB)	Azimuth (deg)
2	1361.0	-47.70	2.00	10.75	Horizontal	-41.10	-13.00	28.10	90
3	2041.5	-46.24	2.51	11.05	Horizontal	-39.85	-13.00	26.85	180
4	2722.0	-60.49	4.20	11.15	Horizontal	-55.69	-13.00	42.69	270
5	3402.5	-61.89	5.20	11.15	Horizontal	-58.09	-13.00	45.09	0
6	4083.0	-60.20	5.50	11.95	Horizontal	-55.90	-13.00	42.90	135
7	4763.5	-60.82	5.70	13.55	Horizontal	-55.12	-13.00	42.12	90
8	5444.0	-60.24	6.30	13.75	Horizontal	-54.94	-13.00	41.94	45
9	6124.5	-59.77	6.80	13.85	Horizontal	-54.87	-13.00	41.87	180
10	6805.0	-56.01	6.90	14.25	Horizontal	-50.81	-13.00	37.81	90

Note: 1.The other Spurious RF Radiated emissions level is no more than noise floor.
2. The worst emission was found in the antenna is Horizontal position.



NB-IOT Band 71 CH-High

Harmonic	Frequency (MHz)	SG (dBm)	Cable Loss (dB)	Gain (dBi)	Antenna Polarization	ERP Level (dBm)	Limit (dBm)	Margin (dB)	Azimuth (deg)
2	1391.0	-45.06	2.00	10.15	Horizontal	-39.06	-13.00	26.06	45
3	2086.5	-54.72	2.51	11.05	Horizontal	-48.33	-13.00	35.33	9
4	2782.0	-56.11	4.20	11.15	Horizontal	-51.31	-13.00	38.31	180
5	3477.5	-56.09	5.20	11.15	Horizontal	-52.29	-13.00	39.29	45
6	4173.0	-59.62	5.50	11.95	Horizontal	-55.32	-13.00	42.32	0
7	4868.5	-60.91	5.70	13.55	Horizontal	-55.21	-13.00	42.21	180
8	5564.0	-60.75	6.30	13.75	Horizontal	-55.45	-13.00	42.45	135
9	6259.5	-59.31	6.80	13.85	Horizontal	-54.41	-13.00	41.41	270
10	6955.0	-56.81	6.90	14.25	Horizontal	-51.61	-13.00	38.61	0

Note: 1.The other Spurious RF Radiated emissions level is no more than noise floor.
2. The worst emission was found in the antenna is Horizontal position.

NB-IOT Band 85 CH-Low

Harmonic	Frequency (MHz)	SG (dBm)	Cable Loss (dB)	Gain (dBi)	Antenna Polarization	ERP Level (dBm)	Limit (dBm)	Margin (dB)	Azimuth (deg)
2	1396.2	-47.06	2.00	10.15	Horizontal	-41.06	-13.00	28.06	135
3	2094.3	-53.77	2.50	11.35	Horizontal	-47.07	-13.00	34.07	12
4	2792.4	-57.67	4.20	10.85	Horizontal	-53.17	-13.00	40.17	0
5	3490.5	-56.56	5.20	11.35	Horizontal	-52.56	-13.00	39.56	0
6	4188.6	-60.32	5.50	11.95	Horizontal	-56.02	-13.00	43.02	135
7	4886.7	-65.64	5.70	13.55	Horizontal	-59.94	-13.00	46.94	270
8	5584.8	-60.83	6.30	13.75	Horizontal	-55.53	-13.00	42.53	0
9	6282.9	-58.74	6.80	13.85	Horizontal	-53.84	-13.00	40.84	180
10	6981.0	-56.60	6.90	14.25	Horizontal	-51.40	-13.00	38.40	45

Note: 1.The other Spurious RF Radiated emissions level is no more than noise floor.
2. The worst emission was found in the antenna is Horizontal position.

NB-IOT Band 85 CH-Middle

Harmonic	Frequency (MHz)	SG (dBm)	Cable Loss (dB)	Gain (dBi)	Antenna Polarization	ERP Level (dBm)	Limit (dBm)	Margin (dB)	Azimuth (deg)
2	1411.8	-44.92	2.00	10.75	Horizontal	-38.32	-13.00	25.32	180
3	2117.7	-49.68	2.51	11.05	Horizontal	-43.29	-13.00	30.29	270
4	2823.6	-58.43	4.20	11.15	Horizontal	-53.63	-13.00	40.63	45
5	3529.5	-58.99	5.20	11.15	Horizontal	-55.19	-13.00	42.19	90
6	4235.4	-60.50	5.50	11.95	Horizontal	-56.20	-13.00	43.20	135
7	4941.3	-61.26	5.70	13.55	Horizontal	-55.56	-13.00	42.56	270
8	5647.2	-60.37	6.30	13.75	Horizontal	-55.07	-13.00	42.07	315
9	6353.1	-59.22	6.80	13.85	Horizontal	-54.32	-13.00	41.32	180
10	7059.0	-56.89	6.90	14.25	Horizontal	-51.69	-13.00	38.69	45

Note: 1.The other Spurious RF Radiated emissions level is no more than noise floor.
 2. The worst emission was found in the antenna is Horizontal position.

NB-IOT Band 85 CH-High

Harmonic	Frequency (MHz)	SG (dBm)	Cable Loss (dB)	Gain (dBi)	Antenna Polarization	ERP Level (dBm)	Limit (dBm)	Margin (dB)	Azimuth (deg)
2	1431.8	-52.66	2.00	10.15	Horizontal	-46.66	-13.00	33.66	90
3	2147.7	-49.92	2.51	11.05	Horizontal	-43.53	-13.00	30.53	180
4	2863.6	-60.60	4.20	11.15	Horizontal	-55.80	-13.00	42.80	45
5	3579.5	-58.53	5.20	11.15	Horizontal	-54.73	-13.00	41.73	0
6	4295.4	-60.14	5.50	11.95	Horizontal	-55.84	-13.00	42.84	90
7	5011.3	-60.78	5.70	13.55	Horizontal	-55.08	-13.00	42.08	45
8	5727.2	-60.60	6.30	13.75	Horizontal	-55.30	-13.00	42.30	45
9	6443.1	-60.05	6.80	13.85	Horizontal	-55.15	-13.00	42.15	135
10	7159.0	-55.57	6.90	14.25	Horizontal	-50.37	-13.00	37.37	315

Note: 1.The other Spurious RF Radiated emissions level is no more than noise floor.
 2. The worst emission was found in the antenna is Horizontal position.



Variant

NB-IOT Band 13 CH-Low

Harmonic	Frequency (MHz)	SG (dBm)	Cable Loss (dB)	Gain (dBi)	Antenna Polarization	ERP Level (dBm)	Limit (dBm)	Margin (dB)	Azimuth (deg)
2	1554.0	-59.16	2.00	10.15	Horizontal	-53.16	-40.00	13.16	180
3	2331.3	-46.90	2.50	11.35	Horizontal	-40.20	-13.00	27.20	315
4	3108.4	-52.00	4.20	10.85	Horizontal	-47.50	-13.00	34.50	225
5	3885.5	-54.68	5.20	11.35	Horizontal	-50.68	-13.00	37.68	0
6	4662.6	-52.48	5.50	11.95	Horizontal	-48.18	-13.00	35.18	45
7	5439.7	-54.67	5.70	13.55	Horizontal	-48.97	-13.00	35.97	270
8	6216.8	-53.88	6.30	13.75	Horizontal	-48.58	-13.00	35.58	90
9	6993.9	-56.86	6.80	13.85	Horizontal	-51.96	-13.00	38.96	135
10	7771.0	-53.26	6.90	14.25	Horizontal	-48.06	-13.00	35.06	0

Note: 1.The other Spurious RF Radiated emissions level is no more than noise floor.
2. The worst emission was found in the antenna is Horizontal position.

NB-IOT Band 13 CH-Middle

Harmonic	Frequency (MHz)	SG (dBm)	Cable Loss (dB)	Gain (dBi)	Antenna Polarization	ERP Level (dBm)	Limit (dBm)	Margin (dB)	Azimuth (deg)
2	1564.0	-53.86	2.00	10.75	Horizontal	-47.26	-40.00	7.26	45
3	2346.0	-49.20	2.51	11.05	Horizontal	-42.81	-13.00	29.81	135
4	3128.0	-48.94	4.20	11.15	Horizontal	-44.14	-13.00	31.14	135
5	3910.0	-54.36	5.20	11.15	Horizontal	-50.56	-13.00	37.56	180
6	4692.0	-54.53	5.50	11.95	Horizontal	-50.23	-13.00	37.23	90
7	5474.0	-55.07	5.70	13.55	Horizontal	-49.37	-13.00	36.37	225
8	6256.0	-54.95	6.30	13.75	Horizontal	-49.65	-13.00	36.65	180
9	7038.0	-55.63	6.80	13.85	Horizontal	-50.73	-13.00	37.73	45
10	7820.0	-53.80	6.90	14.25	Horizontal	-48.60	-13.00	35.60	180

Note: 1.The other Spurious RF Radiated emissions level is no more than noise floor.
2. The worst emission was found in the antenna is Horizontal position.



NB-IOT Band 13 CH-High

Harmonic	Frequency (MHz)	SG (dBm)	Cable Loss (dB)	Gain (dBi)	Antenna Polarization	ERP Level (dBm)	Limit (dBm)	Margin (dB)	Azimuth (deg)
2	1573.8	-52.85	2.00	10.15	Horizontal	-46.85	-40.00	6.85	90
3	2360.7	-52.24	2.51	11.05	Horizontal	-45.85	-13.00	32.85	225
4	3147.6	-52.19	4.20	11.15	Horizontal	-47.39	-13.00	34.39	270
5	3934.5	-54.83	5.20	11.15	Horizontal	-51.03	-13.00	38.03	90
6	4721.4	-53.07	5.50	11.95	Horizontal	-48.77	-13.00	35.77	135
7	5508.3	-55.46	5.70	13.55	Horizontal	-49.76	-13.00	36.76	270
8	6295.2	-54.95	6.30	13.75	Horizontal	-49.65	-13.00	36.65	180
9	7082.1	-57.57	6.80	13.85	Horizontal	-52.67	-13.00	39.67	0
10	7869.0	-52.26	6.90	14.25	Horizontal	-47.06	-13.00	34.06	90

Note: 1.The other Spurious RF Radiated emissions level is no more than noise floor.

2. The worst emission was found in the antenna is Horizontal position.



6 Main Test Instruments

Name	Manufacturer	Type	Serial Number	Calibration Date	Expiration Date
Base Station Simulator	R&S	CMW500	113824	2019-05-19	2020-05-18
Power Splitter	Hua Xiang	SHX-GF2-2-13	10120101	/	/
Spectrum Analyzer	Key sight	N9010A	MY50210259	2019-05-19	2020-05-18
Signal Analyzer	R&S	FSV30	100815	2018-12-16	2019-12-15
Signal Analyzer	R&S	FSV30	100815	2019-12-15	2020-12-14
Loop Antenna	SCHWARZBECK	FMZB1519	1519-047	2017-09-26	2019-09-25
Loop Antenna	SCHWARZBECK	FMZB1519	1519-047	2019-09-25	2021-09-24
Trilog Antenna	SCHWARZBECK	VUBL 9163	9163-201	2017-11-18	2019-11-17
Trilog Antenna	SCHWARZBECK	VUBL 9163	9163-201	2019-11-17	2021-11-16
Horn Antenna	R&S	HF907	100126	2018-07-07	2020-07-06
Horn Antenna	ETS-Lindgren	3160-09	00102643	2018-06-20	2020-06-19
Horn Antenna	STEATITE	QSH-SL-26-40-K-15	16779	2017-07-20	2020-07-19
Signal generator	R&S	SMB 100A	102594	2019-05-19	2020-05-18
Climatic Chamber	ESPEC	SU-242	93000506	2017-12-17	2020-12-16
Preampfier	R&S	SCU18	102327	2019-05-19	2020-05-18
MOB COMMS DC SUPPLY	Keysight	66319D	MY43004105	2019-05-19	2020-05-18
RF Cable	Agilent	SMA 15cm	0001	2019-06-14	2020-06-13
Software	R&S	EMC32	9.26.0	/	/
Wireless Test Set	StarPoint	SP8315	SP8315-1202	2019-05-19	2020-05-18
Wireless Test Set	StarPoint	SP8315	SP8315-1203	2019-05-19	2020-05-18

*****END OF REPORT *****