



RF TEST REPORT

Applicant Quectel Wireless Solutions Co., Ltd
FCC ID XMR2020BG95M2
Product LTE Cat M1 & Cat NB2 Module
Brand Quectel
Marketing Quectel BG95-M2
Model BG95-M2
Report No. R1907A0448-R2V2
Issue Date May 13, 2020

TA Technology (Shanghai) Co., Ltd. tested the above equipment in accordance with the requirements in **FCC CFR47 Part 2 (2019)/ FCC CFR 47 Part 24E (2019)**. The test results show that the equipment tested is capable of demonstrating compliance with the requirements as documented in this report.

Performed by: Peng Tao

Approved by: Kai Xu

TA Technology (Shanghai) Co., Ltd.

No.145, Jintang Rd, Tangzhen Industry Park, Pudong Shanghai, China

TEL: +86-021-50791141/2/3

FAX: +86-021-50791141/2/3-8000



TABLE OF CONTENT

1. Test Laboratory	4
1.1. Notes of the test report.....	4
1.2. Test facility.....	4
1.3. Testing Location	5
2. General Description of Equipment under Test.....	6
3. Applied Standards.....	7
4. Test Configuration.....	8
5. Test Case Results.....	9
5.1. RF Power Output.....	9
5.2. Effective Isotropic Radiated Power	12
5.3. Occupied Bandwidth	17
5.4. Band Edge Compliance.....	23
5.5. Peak-to-Average Power Ratio (PAPR)	40
5.6. Frequency Stability	42
5.7. Spurious Emissions at Antenna Terminals	46
5.8. Radiates Spurious Emission	65
6. Main Test Instruments	72

Summary of measurement results

No.	Test Case	Clause in FCC rules	Verdict
1	RF power output	2.1046	PASS
2	Effective Isotropic Radiated power	24.232(c)	PASS
3	Occupied Bandwidth	2.1049	PASS
4	Band Edge Compliance	2.1051 /24.238(a)	Refer to the Original
5	Peak-to-Average Power Ratio	24.232/KDB 971168 D01(5.7)	Refer to the Original
6	Frequency Stability	2.1055 / 24.235	Refer to the Original
7	Spurious Emissions at Antenna Terminals	2.1051 / 24.238(a)	Refer to the Original
8	Radiates Spurious Emission	2.1053 / 24.238(a)	Only tested the worst channel of Original LTE B2
<p>Note: PASS: The EUT complies with the essential requirements in the standard. FAIL: The EUT does not comply with the essential requirements in the standard.</p>			
<p>Date of Testing: August 20, 2019 ~ September 5, 2019 & December 25, 2019 ~ February 28, 2020</p>			

Note: This revised report (Report No.: R1907A0448-R2V2) supersedes and replaces the previously issued report (Report No.: R1907A0448-R2V1). Please discard or destroy the previously issued report and dispose of it accordingly.

BG95-M2 (Report No.: R1907A0448-R2V2) is a variant model of BG95-M3 (Report No.: R1907A0446-R2). Test values partial duplicated from original for variant. There is only tested RF power output, Effective Radiated Power, Occupied Bandwidth and Radiates Spurious Emission for variant in this report. For Radiates Spurious Emission, only the worst channel of original LTE B2 is tested. The detailed product change description please refers to the Statement letter_BG95-M3&BG95-M2.



1. Test Laboratory

1.1. Notes of the test report

This report shall not be reproduced in full or partial, without the written approval of **TA technology (shanghai) co., Ltd.** The results documented in this report apply only to the tested sample, under the conditions and modes of operation as described herein. Measurement Uncertainties were not taken into account and are published for informational purposes only. This report is written to support regulatory compliance of the applicable standards stated above.

1.2. Test facility

FCC (Designation number: CN1179, Test Firm Registration Number: 446626)

TA Technology (Shanghai) Co., Ltd. has been listed on the US Federal Communications Commission list of test facilities recognized to perform electromagnetic emissions measurements.

A2LA (Certificate Number: 3857.01)

TA Technology (Shanghai) Co., Ltd. has been listed by American Association for Laboratory Accreditation to perform electromagnetic emission measurement.



1.3. Testing Location

Company: TA Technology (Shanghai) Co., Ltd.
Address: No.145, Jintang Rd, Tangzhen Industry Park, Pudong
City: Shanghai
Post code: 201201
Country: P. R. China
Contact: Xu Kai
Telephone: +86-021-50791141/2/3
Fax: +86-021-50791141/2/3-8000
Website: <http://www.ta-shanghai.com>
E-mail: xukai@ta-shanghai.com

2. General Description of Equipment under Test

Client Information

Applicant	Quectel Wireless Solutions Co., Ltd
Applicant address	Building 5, Shanghai Business Park Phase III (Area B), No.1016 Tianlin Road, Minhang District, Shanghai, China 200233
Manufacturer	Quectel Wireless Solutions Co., Ltd
Manufacturer address	Building 5, Shanghai Business Park Phase III (Area B), No.1016 Tianlin Road, Minhang District, Shanghai, China 200233

General information

EUT Description			
Model	BG95-M2		
IMEI	863859040012143		
Hardware Version	R2.1		
Software Version	BG95M2LAR02A04		
Power Supply	External power supply		
Antenna Type	The EUT don't have standard Antenna, The Antenna used for testing in this report is the after-market accessory (Dipole Antenna)		
Antenna Gain	LTE Band 2:1.6dBi LTE Band 25:1.7dBi		
Test Mode(s)	LTE Band 2/25;		
Test Modulation	(LTE)QPSK,16QAM		
LTE Category	M1		
Maximum E.I.R.P	LTE Band 2:	21.97dBm	
	LTE Band 25:	22.16dBm	
Rated Power Supply Voltage	3.3V		
Extreme Voltage	Minimum: 2.6V Maximum: 4.8V		
Extreme Temperature	Lowest: -40°C Highest: +85°C		
Operating Frequency Range(s)	Band	Tx (MHz)	Rx (MHz)
	LTE Band 2	1850 ~ 1910	1930 ~ 1990
	LTE Band 25	1850 ~ 1915	1930 ~ 1995
Note: 1. The information of the EUT is declared by the manufacturer.			



3. Applied Standards

According to the specifications of the manufacturer, it must comply with the requirements of the following standards:

FCC CFR47 Part 2 (2019)

FCC CFR 47 Part 24E (2019)

ANSI C63.26 (2015)

KDB 971168 D01 Power Meas License Digital Systems v03r01

4. Test Configuration

Radiated measurements are performed by rotating the EUT in three different orthogonal test planes. EUT stand-up position (Z axis), lie-down position (X, Y axis). Receiver antenna polarization (horizontal and vertical), the worst emission was found in position (X axis, horizontal polarization) and the worst case was recorded.

All mode and data rates and positions and RB size and modulations were investigated.

Subsequently, only the worst case emissions are reported.

The following testing in LTE is set based on the maximum RF Output Power.

Test modes are chosen to be reported as the worst case configuration below for LTE Band 2/25:

Test items	Modes	Bandwidth (MHz)						Modulation		RB			Test Channel		
		1.4	3	5	10	15	20	QPSK	16QAM	1	50%	100%	L	M	H
RF power output	LTE 2	O	O	O	O	O	O	O	O	O	O	O	O	O	O
	LTE 25	O	O	O	O	O	O	O	O	O	O	O	O	O	O
Effective Isotropic Radiated power	LTE 2	O	O	O	O	O	O	O	O	O	O	O	O	O	O
	LTE 25	O	O	O	O	O	O	O	O	O	O	O	O	O	O
Occupied Bandwidth	LTE 2	O	O	O	O	O	O	O	O	-	-	O	-	O	-
	LTE 25	O	O	O	O	O	O	O	O	-	-	O	-	O	-
Band Edge Compliance	LTE 2	O	O	O	O	O	O	O	O	O	-	O	O	-	O
	LTE 25	O	O	O	O	O	O	O	O	O	-	O	O	-	O
Peak-to-Average Power Ratio	LTE 2	O	O	O	O	O	O	O	O	-	-	O	-	O	-
	LTE 25	O	O	O	O	O	O	O	O	-	-	O	-	O	-
Frequency Stability	LTE 2	O	O	O	O	O	O	O	O	O	O	O	O	O	O
	LTE 25	O	O	O	O	O	O	O	O	O	O	O	O	O	O
Conducted Spurious Emissions	LTE 2	O	O	O	O	O	O	O	-	O	-	-	O	O	O
	LTE 25	O	O	O	O	O	O	O	-	O	-	-	O	O	O
Radiates Spurious Emission	LTE 2	O	-	O	-	-	O	O	-	O	-	-	O	O	O
	LTE 25	O	-	O	-	-	O	O	-	O	-	-	O	O	O
Note	1. The mark "O" means that this configuration is chosen for testing. 2. The mark "-" means that this configuration is not testing.														

5. Test Case Results

5.1.RF Power Output

Ambient condition

Temperature	Relative humidity	Pressure
23°C ~25°C	45%~50%	101.5kPa

Methods of Measurement

During the process of the testing, The EUT is controlled by the Base Station Simulator to ensure max power transmission and proper modulation.

Test Setup

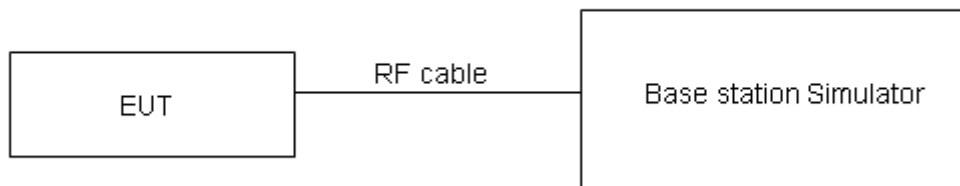

The loss between RF output port of the EUT and the input port of the tester has been taken into consideration.

Limits

No specific RF power output requirements in part 2.1046.

Measurement Uncertainty

The assessed measurement uncertainty to ensure 95% confidence level for the normal distribution is with the coverage factor $k = 2$, $U = 0.4$ dB.

**Test Results****Variant**

LTE Band 2	Channel/ Frequency(MHz)	Index	RB# RBstart	Conducted Power (dBm)	
				QPSK	16QAM
1.4MHz	18607/1850.7	0	1#0	20.08	18.92
		0	6#0	18.11	17.98
	18900/1880	0	1#0	20.08	19.41
		0	6#0	18.12	17.98
	19193/1909.3	0	1#5	19.91	19.01
		0	6#0	17.91	18.08
3MHz	18615/1851.5	0	1#0	20.22	18.88
		0	6#0	17.99	18.25
	18900/1880	0	1#0	20.18	18.84
		0	6#0	17.96	18.24
	19185/1908.5	1	1#5	19.85	18.59
		1	6#0	17.81	18.08
5MHz	18625/1852.5	0	1#0	20.17	19.85
		0	6#0	18.98	19.09
	18900/1880	0	1#0	20.15	19.81
		0	6#0	19.04	19.15
	19175/1907.5	0	1#5	19.75	19.54
		3	6#0	18.76	19.05
10MHz	18650/1855	3	1#0	20.18	19.75
		0	4#0	20.11	20.34
	18900/1880	0	1#0	19.94	20.37
		0	4#0	19.98	20.21
	19150/1905	4	1#5	19.76	19.45
		7	4#2	19.88	20.11
15MHz	18675/1857.5	3	1#0	20.13	19.85
		0	6#0	19.94	19.68
	18900/1880	0	1#0	20.06	19.81
		0	6#0	19.93	20.11
	19125/1902.5	8	1#5	19.83	19.57
		11	6#0	19.89	20.07
20MHz	18700/1860	3	1#0	20.09	19.92
		0	6#0	19.92	20.13
	18900/1880	0	1#0	20.03	19.75
		0	6#0	19.89	20.08
	19100/1900	12	1#5	19.85	19.54
		15	6#0	19.89	20.12



LTE Band 25	Channel/ Frequency(MHz)	Index	RB# RBstart	Conducted Power (dBm)	
				QPSK	16QAM
1.4MHz	26047/1850.7	0	1#0	19.83	19.21
		0	6#0	17.72	17.53
	26365/1882.5	0	1#0	20.46	19.02
		0	6#0	17.76	18.15
	26683/1914.3	0	1#5	20.30	18.79
		0	6#0	17.85	18.24
3MHz	26055/1851.5	0	1#0	20.03	18.73
		0	6#0	17.61	17.97
	26365/1882.5	0	1#0	20.22	18.96
		0	6#0	17.78	18.16
	26675/1913.5	1	1#5	20.07	18.74
		1	6#0	17.75	18.12
5MHz	26065/1852.5	0	1#0	19.92	19.63
		0	6#0	18.75	18.94
	26365/1882.5	0	1#0	20.12	19.68
		0	6#0	18.97	19.13
	26665/1912.5	0	1#5	20.14	19.81
		3	6#0	18.92	19.12
10MHz	26090/1855	3	1#0	19.94	19.62
		0	4#0	18.81	19.98
	26365/1882.5	0	1#0	20.16	19.87
		0	4#0	18.99	20.06
	26640/1910	4	1#5	20.02	19.68
		7	4#2	20.05	20.29
15MHz	26115/1857.5	3	1#0	19.94	19.65
		0	6#0	19.83	19.93
	26365/1882.5	0	1#0	20.19	19.74
		0	6#0	19.99	20.02
	26615/1907.5	8	1#5	19.97	19.67
		11	6#0	20.07	20.18
20MHz	26140/1860	3	1#0	19.88	19.61
		0	6#0	19.83	20.01
	26365/1882.5	0	1#0	20.09	19.78
		0	6#0	20.02	20.12
	26590/1905	12	1#5	19.94	19.66
		15	6#0	20.01	20.19

5.2. Effective Isotropic Radiated Power

Ambient condition

Temperature	Relative humidity	Pressure
23°C ~25°C	45%~50%	101.5kPa

Methods of Measurement

The testing follows FCC KDB 971168 v03r01 Section 5.8 and ANSI C63.26 (2015).

- a) Connect the equipment as illustrated. Mount the equipment with the manufacturer specified antenna in a vertical orientation on a manufacturer specified mounting surface located on a non-conducting rotating platform of a RF anechoic chamber (preferred) or a standard radiation site.
- b) Key the transmitter, then rotate the EUT 360° azimuthally and record spectrum analyzer power level (LVL) measurements at angular increments that are sufficiently small to permit resolution of all peaks. If a standard radiation test site is used, raise and lower the test antenna to obtain a maximum reading at each angular increment. (Note: several batteries may be needed to offset the effect of battery voltage droop, which should not exceed 5% of the manufactured specified battery voltage during transmission).
- c) Replace the transmitter under test with a vertically polarized half-wave dipole (or an antenna whose gain is known relative to an ideal half-wave dipole). The center of the antenna should be at the same location as the center of the antenna under test.
- d) Connect the antenna to a signal generator with a known output power and record the path loss (in dB) as LOSS. If a standard radiation test site is used, raise and lower the test antenna to obtain a maximum reading. $LOSS = \text{Generator Output Power (dBm)} - \text{Analyzer reading (dBm)}$
- e) Determine the effective radiated output power at each angular position from the readings in steps b) and d) using the following equation: $ERP \text{ (dBm)} = \text{LVL (dBm)} + \text{LOSS (dB)}$
- f) The maximum ERP is the maximum value determined in the preceding step.
- g) When calculating ERP, in addition to knowing the antenna radiation and matching characteristics, it is necessary to know the loss values of all elements (e.g. transmission line attenuation, mismatches, filters, combiners) interposed between the point where transmitter output power is measured, and the point where power is applied to the antenna. ERP can then be calculated as follows:
 $EIRP \text{ (dBm)} = \text{Output Power (dBm)} - \text{Losses (dB)} + \text{Antenna Gain (dBi)}$
where: dBd refers to gain relative to an ideal dipole.
 $EIRP \text{ (dBm)} = ERP \text{ (dBm)} + 2.15 \text{ (dB)}$

The RB allocation refers to section 5.1, using the maximum output power configuration.

Test setup

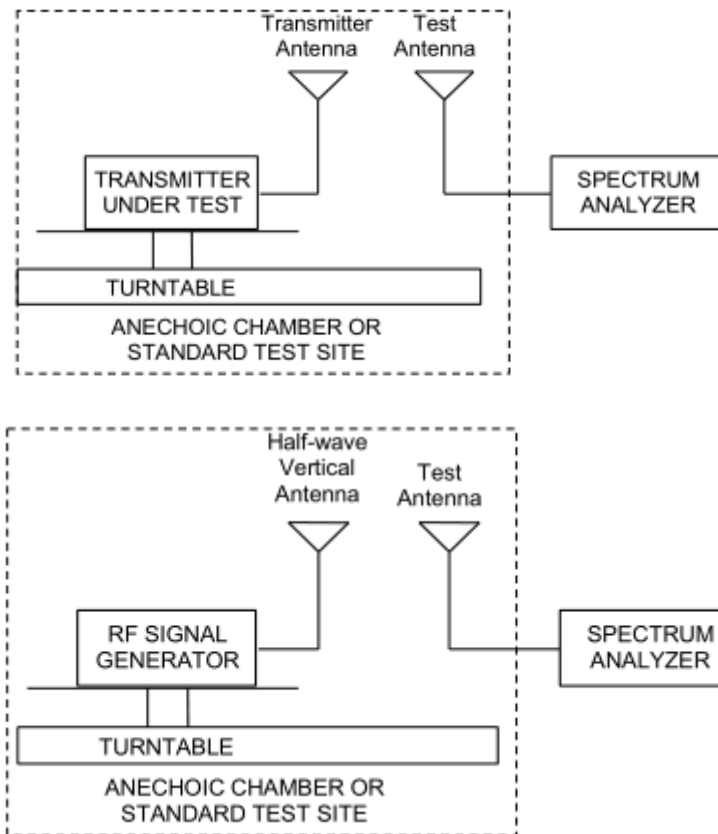

Limits

Rule Part 24.232(c) Mobile and portable stations are limited to 2 watts EIRP.

Rule Part 24.232(e) Peak transmit power must be measured over any interval of continuous transmission using instrumentation calibrated in terms of an rms-equivalent voltage.

Limit	$\leq 2\text{ W}$ (33 dBm)
-------	----------------------------

Measurement Uncertainty

The assessed measurement uncertainty to ensure 95% confidence level for the normal distribution is with the coverage factor $k = 2$, $U = 1.19\text{ dB}$

**Test Results:**

The measurement is performed for both of horizontal and vertical antenna Polarization, and only the data of worst mode is recorded in this report.

Variant

LTE Band 2							
Band2	Channel/ Frequency(MHz)	Index	RB# RBstart	EIRP(dBm)		Limit (dBm)	Conclusion
				QPSK	16QAM		
1.4MHz	18607/1850.7	0	1#0	21.68	20.52	33	Pass
		0	6#0	19.71	19.58	33	Pass
	18900/1880	0	1#0	21.68	21.01	33	Pass
		0	6#0	19.72	19.58	33	Pass
	19193/1909.3	0	1#5	21.51	20.61	33	Pass
		0	6#0	19.51	19.68	33	Pass
3MHz	18615/1851.5	0	1#0	21.82	20.48	33	Pass
		0	6#0	19.59	19.85	33	Pass
	18900/1880	0	1#0	21.78	20.44	33	Pass
		0	6#0	19.56	19.84	33	Pass
	19185/1908.5	1	1#5	21.45	20.19	33	Pass
		1	6#0	19.41	19.68	33	Pass
5MHz	18625/1852.5	0	1#0	21.77	21.45	33	Pass
		0	6#0	20.58	20.69	33	Pass
	18900/1880	0	1#0	21.75	21.41	33	Pass
		0	6#0	20.64	20.75	33	Pass
	19175/1907.5	0	1#5	21.35	21.14	33	Pass
		3	6#0	20.36	20.65	33	Pass
10MHz	18650/1855	3	1#0	21.78	21.35	33	Pass
		0	4#0	21.71	21.94	33	Pass
	18900/1880	0	1#0	21.54	21.97	33	Pass
		0	4#0	21.58	21.81	33	Pass
	19150/1905	4	1#5	21.36	21.05	33	Pass
		7	4#2	21.48	21.71	33	Pass
15MHz	18675/1857.5	3	1#0	21.73	21.45	33	Pass
		0	6#0	21.54	21.28	33	Pass
	18900/1880	0	1#0	21.66	21.41	33	Pass
		0	6#0	21.53	21.71	33	Pass
	19125/1902.5	8	1#5	21.43	21.17	33	Pass
		11	6#0	21.49	21.67	33	Pass
20MHz	18700/1860	3	1#0	21.69	21.52	33	Pass
		0	6#0	21.52	21.73	33	Pass
	18900/1880	0	1#0	21.63	21.35	33	Pass



19100/1900	0	6#0	21.49	21.68	33	Pass
	12	1#5	21.45	21.14	33	Pass
	15	6#0	21.49	21.72	33	Pass

LTE Band 25							
Band25	Channel/ Frequency(MHz)	Index	RB# RBstart	EIRP(dBm)		Limit (dBm)	Conclusion
				QPSK	16QAM		
1.4MHz	26047/1850.7	0	1#0	21.53	20.91	33	Pass
		0	6#0	19.42	19.23	33	Pass
	26365/1882.5	0	1#0	22.16	20.72	33	Pass
		0	6#0	19.46	19.85	33	Pass
	26683/1914.3	0	1#5	22.00	20.49	33	Pass
		0	6#0	19.55	19.94	33	Pass
3MHz	26055/1851.5	0	1#0	21.73	20.43	33	Pass
		0	6#0	19.31	19.67	33	Pass
	26365/1882.5	0	1#0	21.92	20.66	33	Pass
		0	6#0	19.48	19.86	33	Pass
	26675/1913.5	1	1#5	21.77	20.44	33	Pass
		1	6#0	19.45	19.82	33	Pass
5MHz	26065/1852.5	0	1#0	21.62	21.33	33	Pass
		0	6#0	20.45	20.64	33	Pass
	26365/1882.5	0	1#0	21.82	21.38	33	Pass
		0	6#0	20.67	20.83	33	Pass
	26665/1912.5	0	1#5	21.84	21.51	33	Pass
		3	6#0	20.62	20.82	33	Pass
10MHz	26090/1855	3	1#0	21.64	21.32	33	Pass
		0	4#0	20.51	21.68	33	Pass
	26365/1882.5	0	1#0	21.86	21.57	33	Pass
		0	4#0	20.69	21.76	33	Pass
	26640/1910	4	1#5	21.72	21.38	33	Pass
		7	4#2	21.75	21.99	33	Pass
15MHz	26115/1857.5	3	1#0	21.64	21.35	33	Pass
		0	6#0	21.53	21.63	33	Pass
	26365/1882.5	0	1#0	21.89	21.44	33	Pass
		0	6#0	21.69	21.72	33	Pass
	26615/1907.5	8	1#5	21.67	21.37	33	Pass
		11	6#0	21.77	21.88	33	Pass
20MHz	26140/1860	3	1#0	21.58	21.31	33	Pass
		0	6#0	21.53	21.71	33	Pass
	26365/1882.5	0	1#0	21.79	21.48	33	Pass
		0	6#0	21.72	21.82	33	Pass



26590/1905	12	1#5	21.64	21.36	33	Pass
	15	6#0	21.71	21.89	33	Pass

5.3.Occupied Bandwidth

Ambient condition

Temperature	Relative humidity	Pressure
23°C ~25°C	45%~50%	101.5kPa

Method of Measurement

The EUT was connected to Spectrum Analyzer and Base Station Simulator via power Splitter. The occupied bandwidth is measured using spectrum analyzer.

RBW is set to 51kHz, VBW is set to 160kHz for LTE Band 2/25

99% power and -26dBc occupied bandwidths are recorded. Spectrum analyzer plots are included on the following pages.

Test Setup

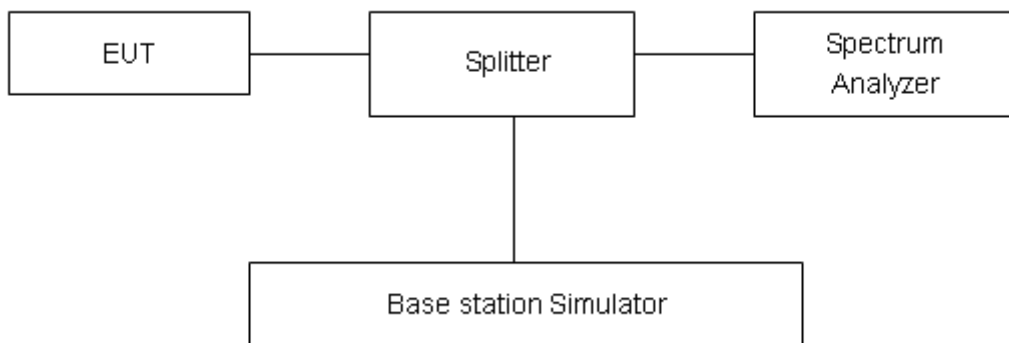

Limits

No specific occupied bandwidth requirements in part 2.1049.

Measurement Uncertainty

The assessed measurement uncertainty to ensure 95% confidence level for the normal distribution is with the coverage factor $k = 2$, $U = 624\text{Hz}$.

Test Result

Variant

Mode	Bandwidth	Modulation	Channel/ Frequency(MHz)	RB	Index	Bandwidth(MHz)	
						99% Power	-26dBc
Band2	1.4MHz	QPSK	18900/1880	6#0	0	1.1083	1.366
		16QAM	18900/1880	6#0	0	0.9431	1.165
	3MHz	QPSK	18900/1880	6#0	0	1.1101	1.332
		16QAM	18900/1880	6#0	0	0.9497	1.226
	5MHz	QPSK	18900/1880	6#0	0	1.1095	1.328
		16QAM	18900/1880	6#0	0	0.9544	1.191
	10MHz	QPSK	18900/1880	6#0	0	1.1207	1.328
		16QAM	18900/1880	6#0	0	0.961	1.203
	15MHz	QPSK	18900/1880	6#0	0	1.1263	1.357
		16QAM	18900/1880	6#0	0	0.9637	1.267
	20MHz	QPSK	18900/1880	6#0	0	1.1322	1.386
		16QAM	18900/1880	6#0	0	0.9673	1.241

Mode	Bandwidth	Modulation	Channel/ Frequency(MHz)	RB	Index	Bandwidth(MHz)	
						99% Power	-26dBc
Band25	1.4MHz	QPSK	26365/1882.5	6#0	0	1.1071	1.342
		16QAM	26365/1882.5	6#0	0	0.9431	1.155
	3MHz	QPSK	26365/1882.5	6#0	0	1.1119	1.381
		16QAM	26365/1882.5	6#0	0	0.9516	1.174
	5MHz	QPSK	26365/1882.5	6#0	0	1.1107	1.333
		16QAM	26365/1882.5	6#0	0	0.9512	1.219
	10MHz	QPSK	26365/1882.5	6#0	0	1.1137	1.334
		16QAM	26365/1882.5	6#0	0	0.9642	1.219
	15MHz	QPSK	26365/1882.5	6#0	0	1.1246	1.346
		16QAM	26365/1882.5	6#0	0	0.957	1.265
	20MHz	QPSK	26365/1882.5	6#0	0	1.127	1.355
		16QAM	26365/1882.5	6#0	0	0.9593	1.183

Variant

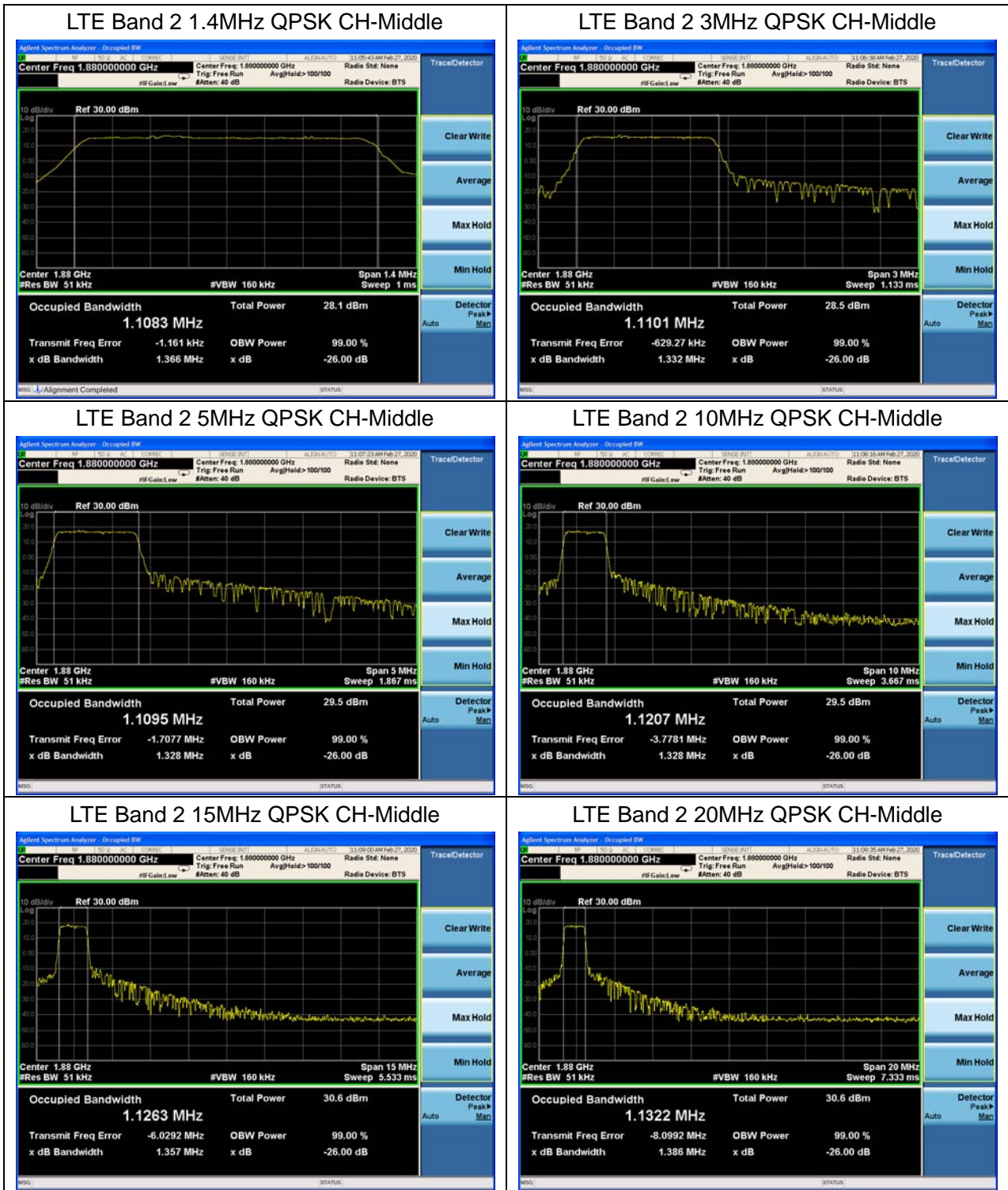

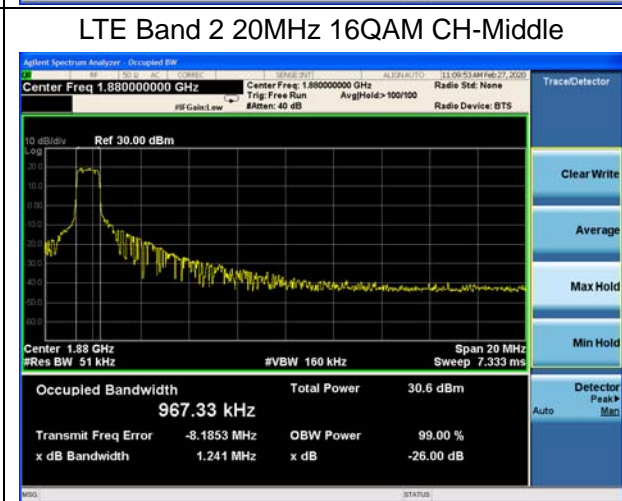
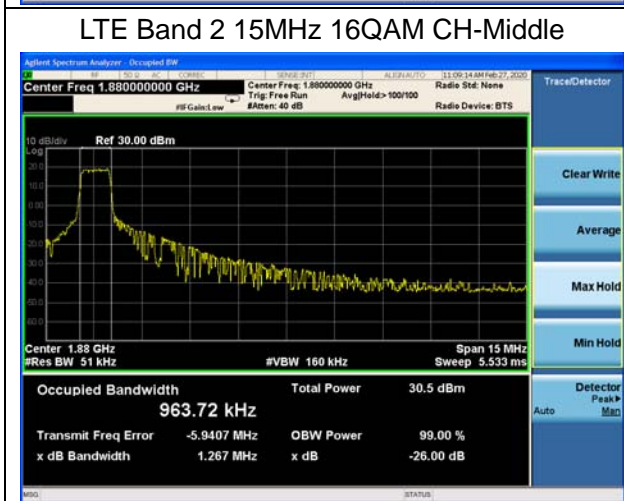
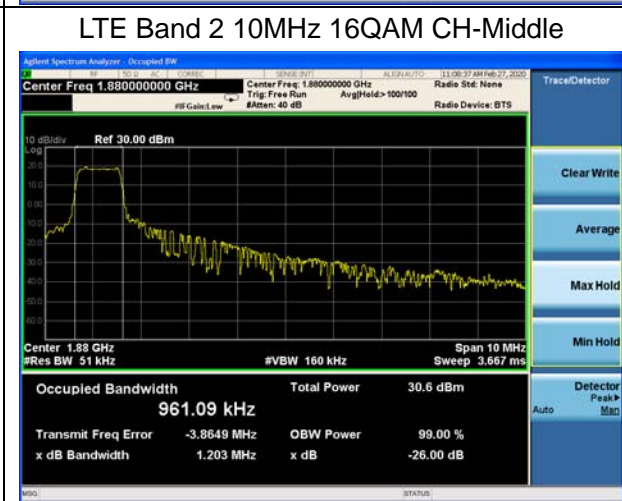
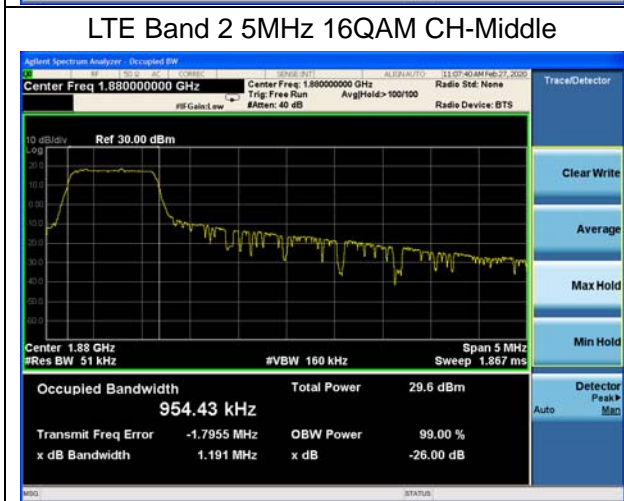
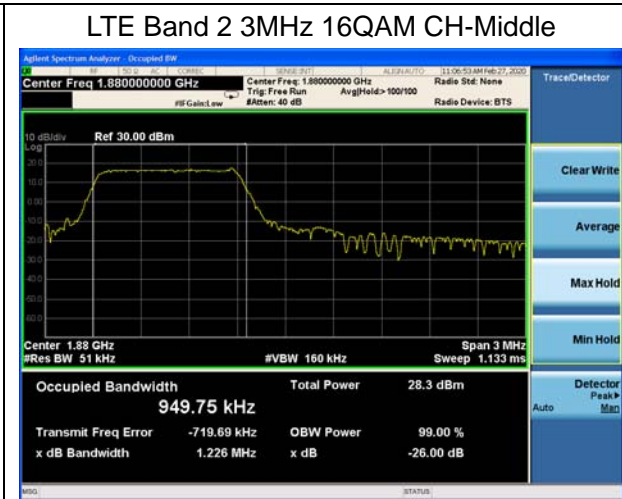

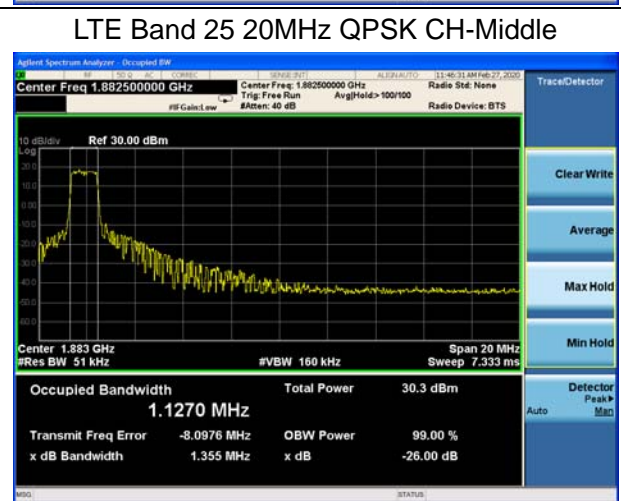
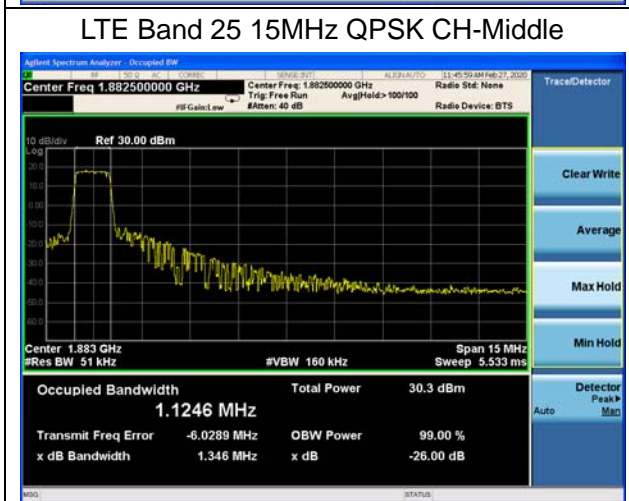
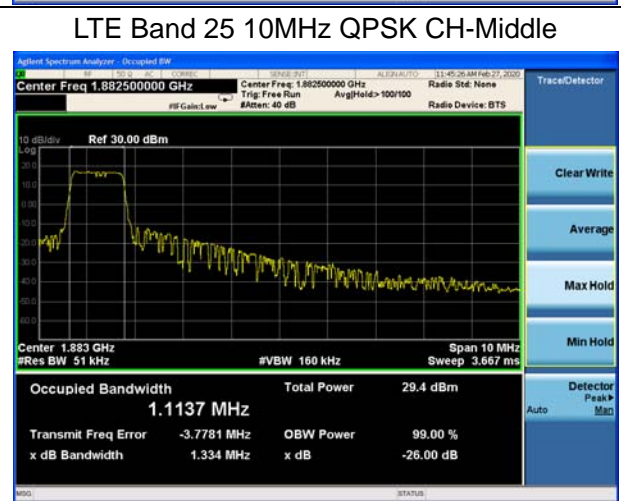
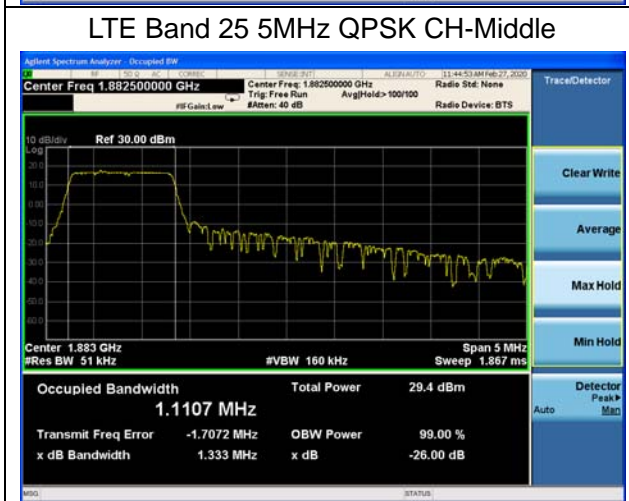
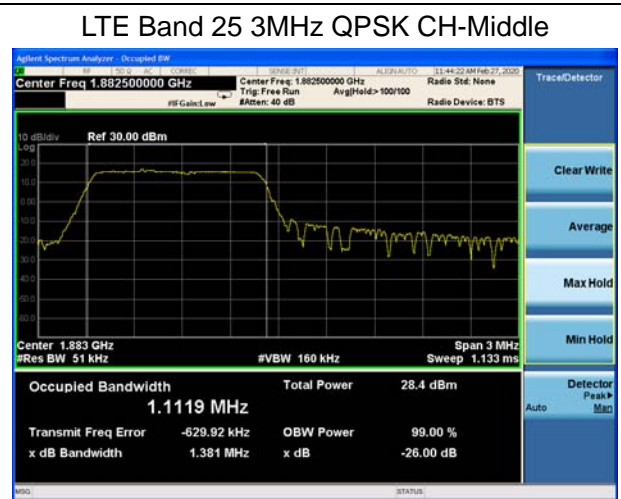
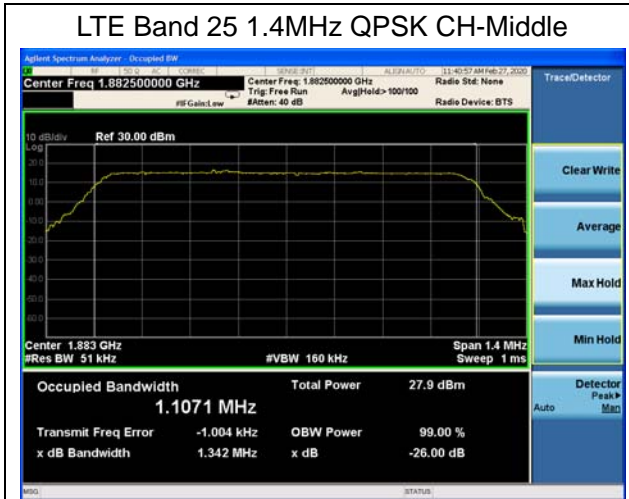

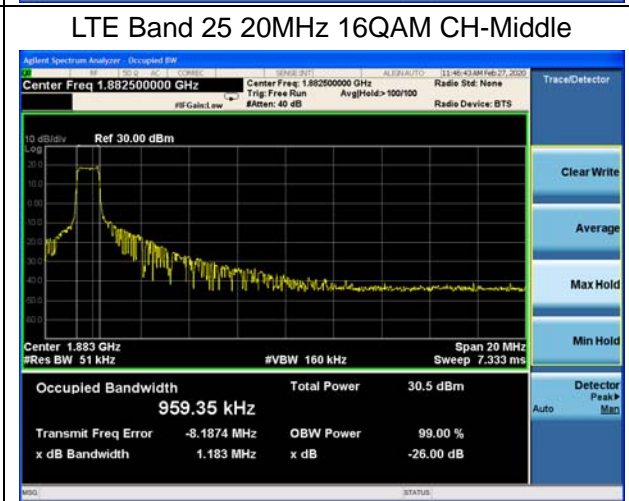
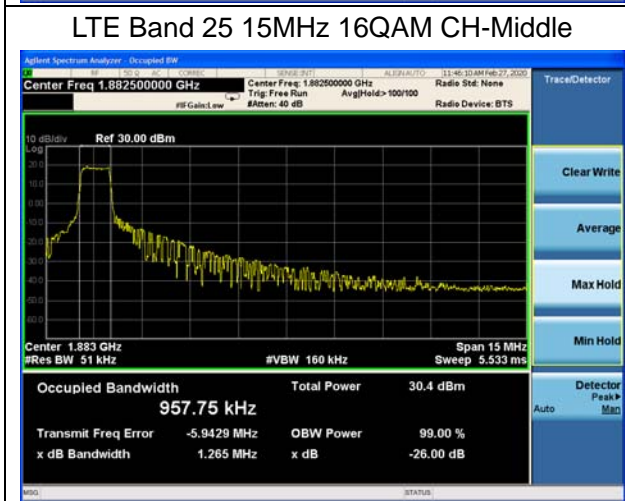
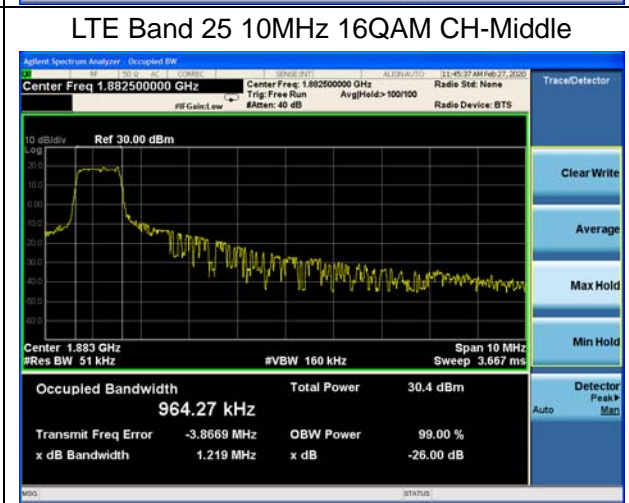
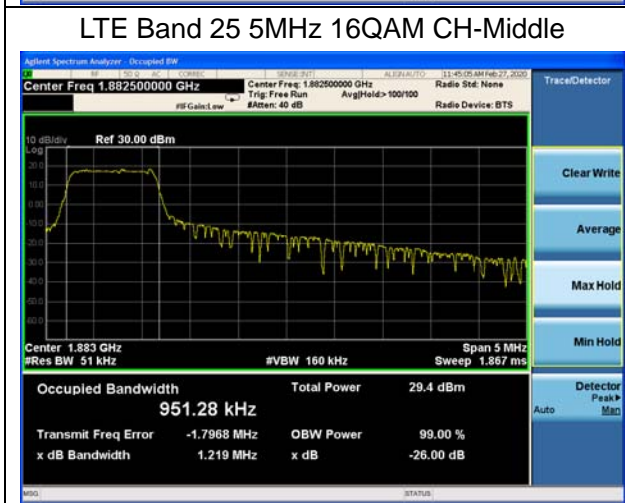
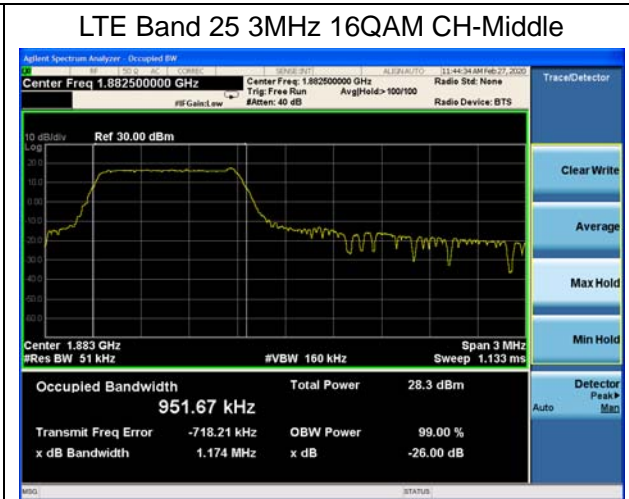
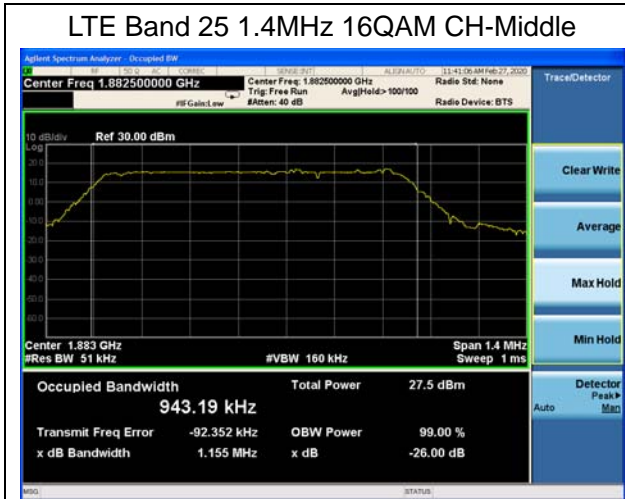

5.4. Band Edge Compliance

Ambient condition

Temperature	Relative humidity	Pressure
23°C ~25°C	45%~50%	101.5kPa

Method of Measurement

The EUT was connected to Spectrum Analyzer and Base Station Simulator via power Splitter. The band edge of the lowest and highest channels were measured. The Average detector is used and RBW is set to 51kHz, VBW is set to 160kHz for LTE Band 2/25
Spectrum analyzer plots are included on the following pages.

Test Setup

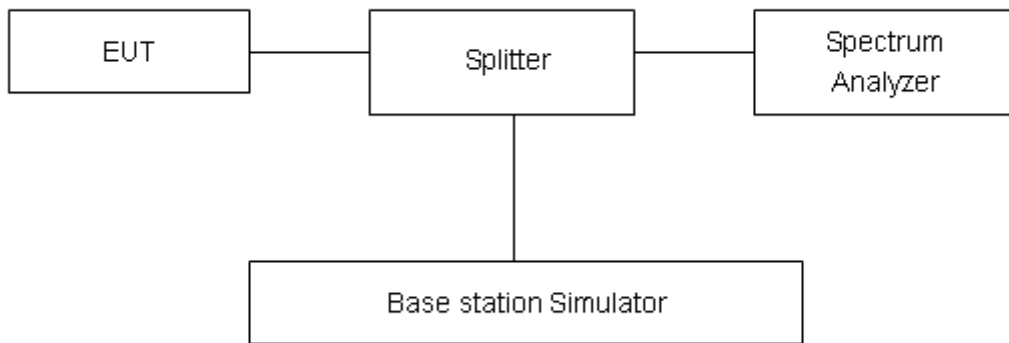

Limits

Rule Part 24.238(a) specifies that “on any frequency outside a licensee’s frequency block, the power of any emission shall be attenuated below the transmitter power (P) by at least 43 + 10 log10 (P) dB.”

Limit	-13 dBm
-------	---------

Measurement Uncertainty

The assessed measurement uncertainty to ensure 95% confidence level for the normal distribution is with the coverage factor $k = 1.96$, $U=0.684\text{dB}$.



Test Result:

Original

LTE Band 2 1.4MHz QPSK 1RB CH-Low

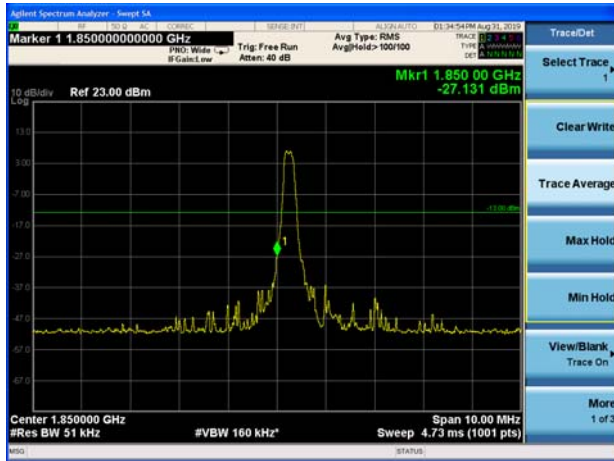

LTE Band 2 1.4MHz QPSK 1RB CH-High

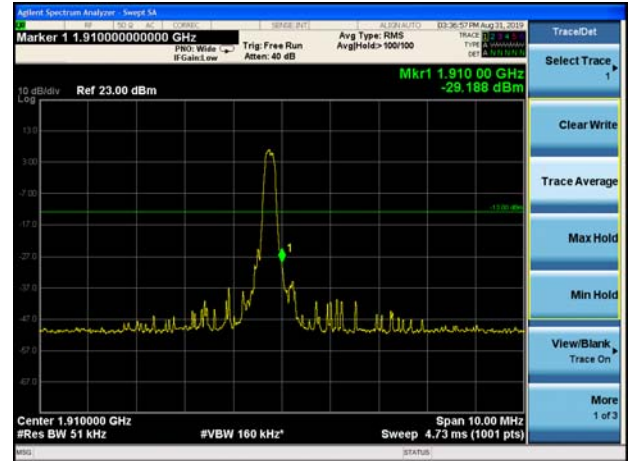

LTE Band 2 1.4MHz QPSK 100%RB CH-Low



LTE Band 2 1.4MHz QPSK 100%RB CH-High

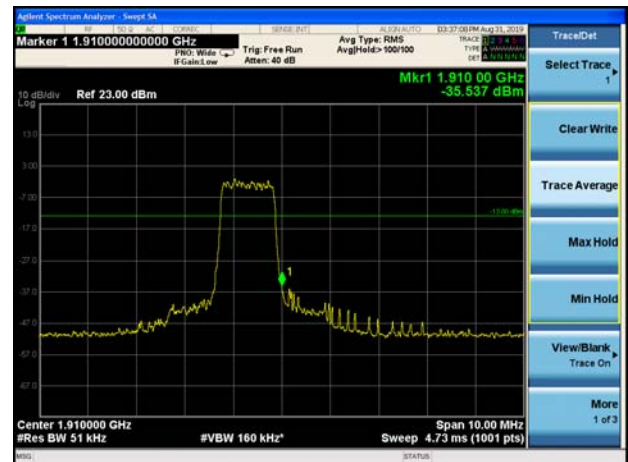

LTE Band 2 3MHz QPSK 1RB CH-Low

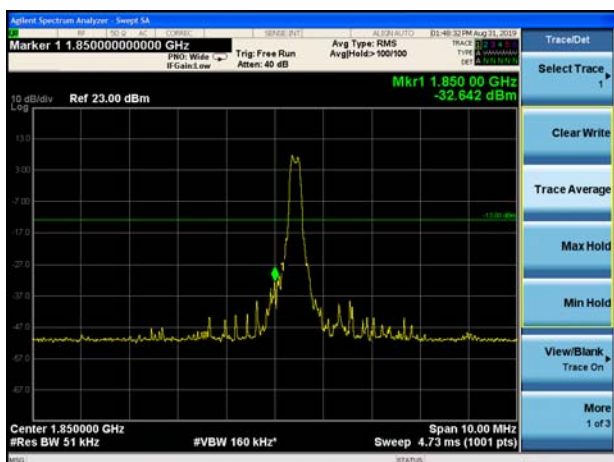

LTE Band 2 3MHz QPSK 1RB CH-High

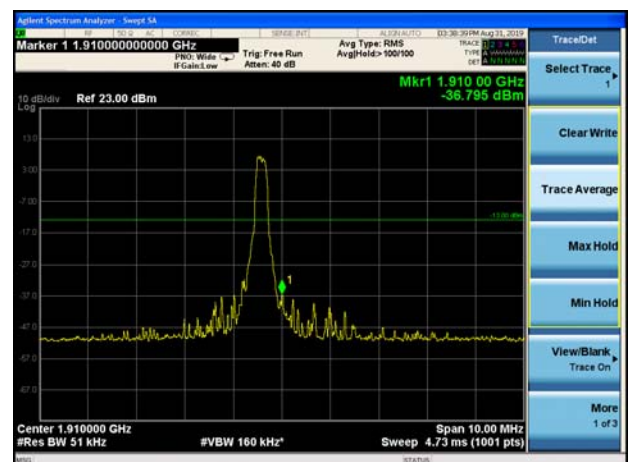

LTE Band 2 3MHz QPSK 100%RB CH-Low

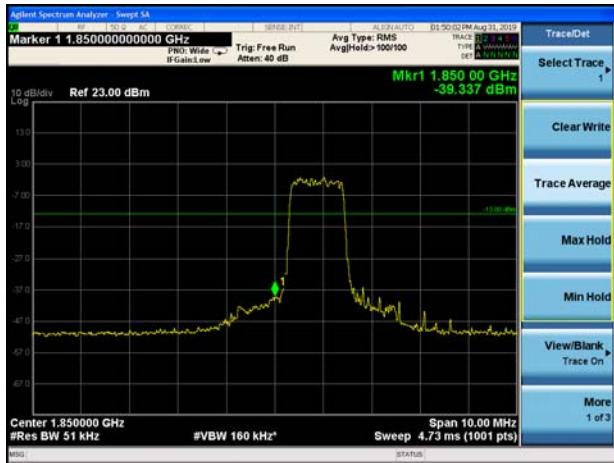

LTE Band 2 3MHz QPSK 100%RB CH-High



LTE Band 2 5MHz QPSK 1RB CH-Low

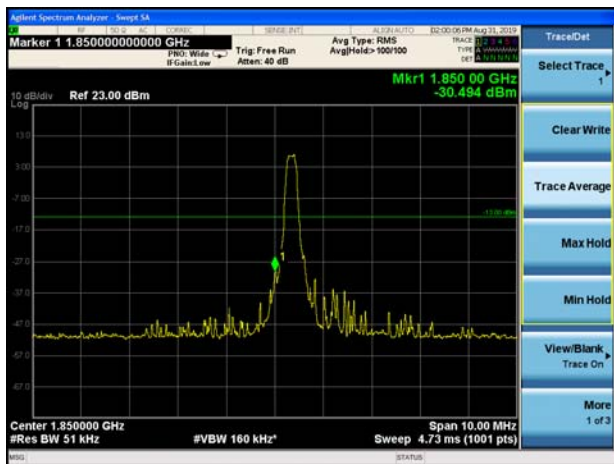

LTE Band 2 5MHz QPSK 1RB CH-High

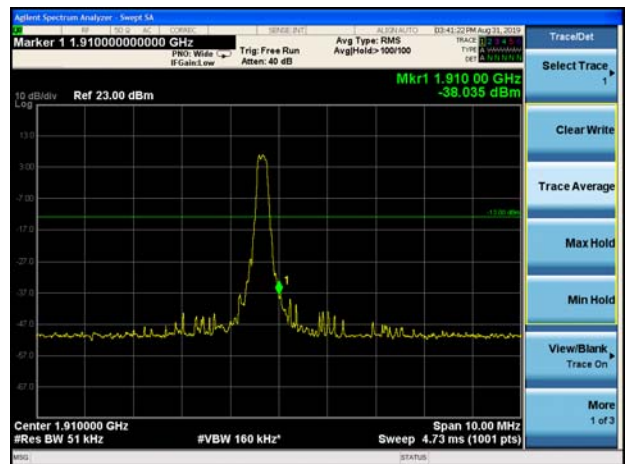

LTE Band 2 5MHz QPSK 100%RB CH-Low



LTE Band 2 5MHz QPSK 100%RB CH-High

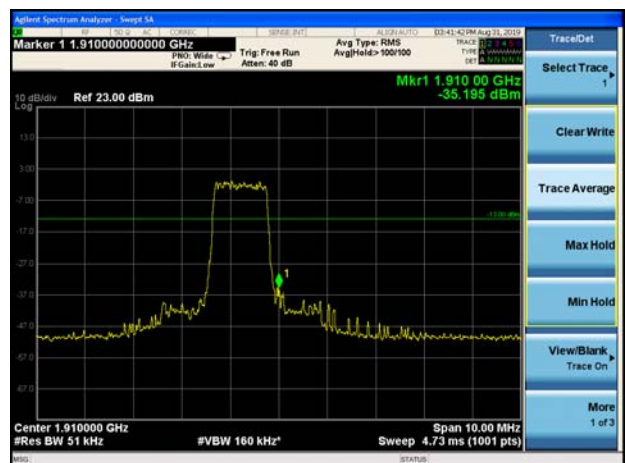



LTE Band 2 10MHz QPSK 1RB CH-Low

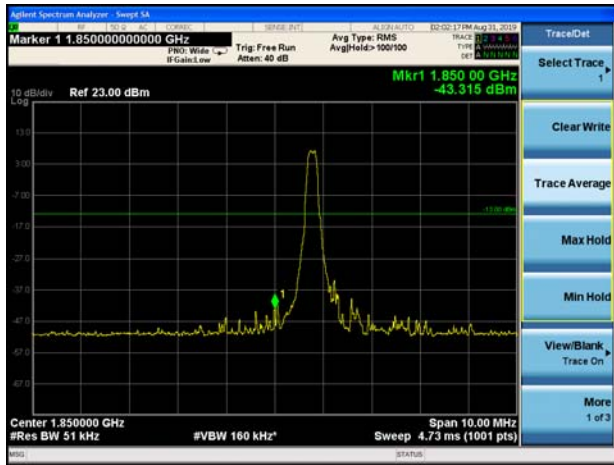

LTE Band 2 10MHz QPSK 1RB CH-High

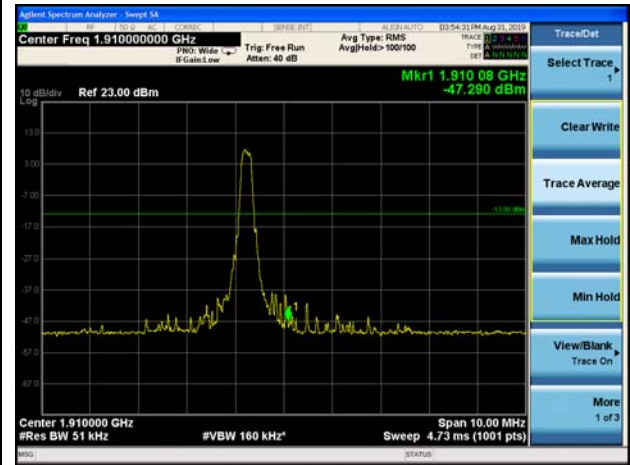

LTE Band 2 10MHz QPSK 100%RB CH-Low

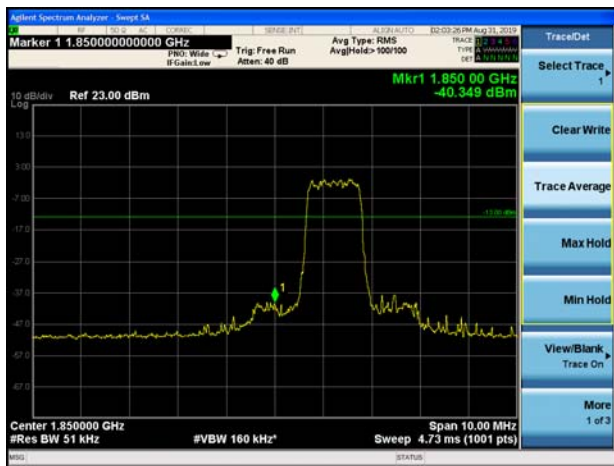

LTE Band 2 10MHz QPSK 100%RB CH-High



LTE Band 2 15MHz QPSK 1RB CH-Low

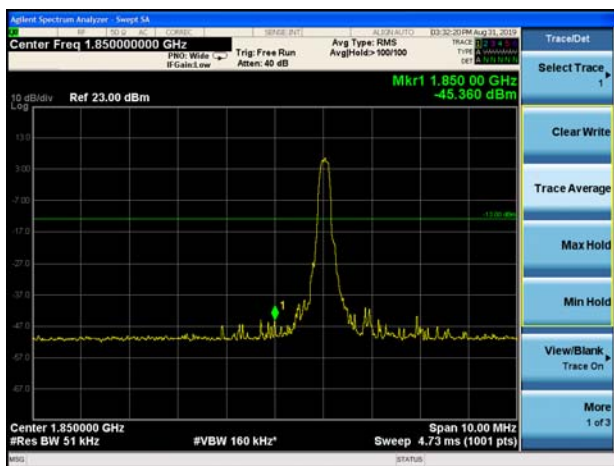

LTE Band 2 15MHz QPSK 1RB CH-High

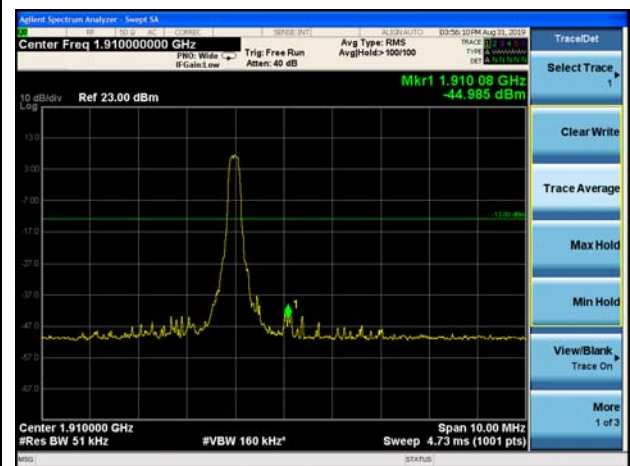

LTE Band 2 15MHz QPSK 100%RB CH-Low



LTE Band 2 15MHz QPSK 100%RB CH-High



LTE Band 2 20MHz QPSK 1RB CH-Low

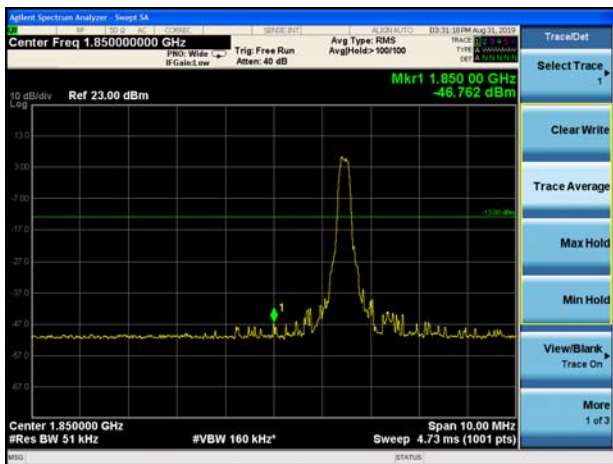

LTE Band 2 20MHz QPSK 1RB CH-High

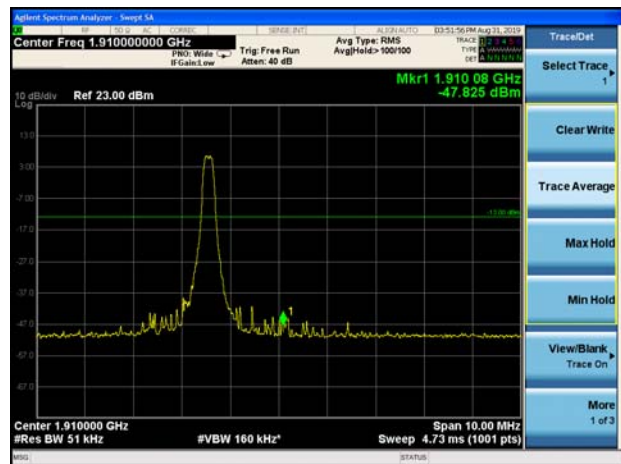

LTE Band 2 20MHz QPSK 100%RB CH-Low

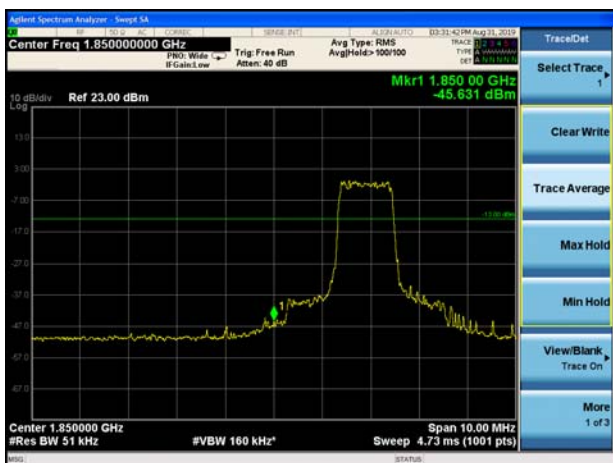

LTE Band 2 20MHz QPSK 100%RB CH-High

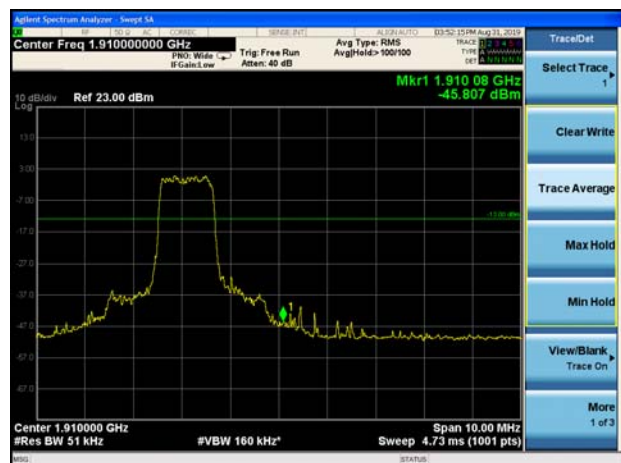



LTE Band 2 1.4MHz 16QAM 1RB CH-Low

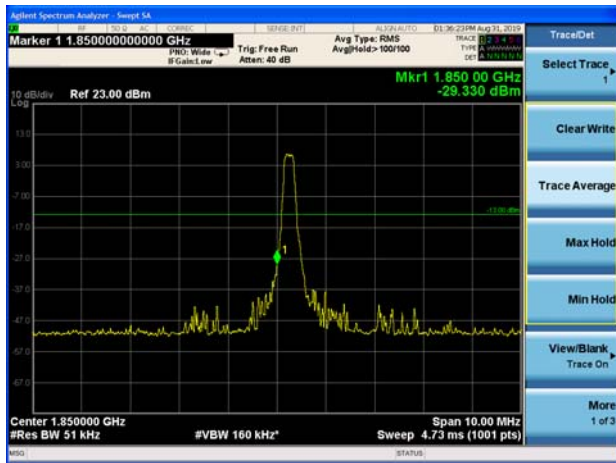

LTE Band 2 1.4MHz 16QAM 1RB CH-High

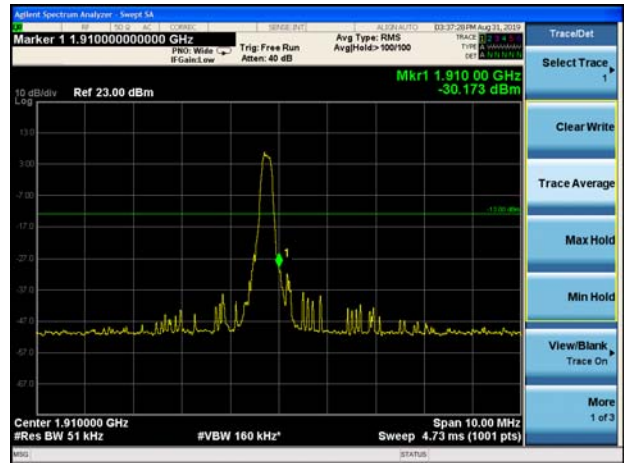

LTE Band 2 1.4MHz 16QAM 100%RB CH-Low



LTE Band 2 1.4MHz 16QAM 100%RB CH-High

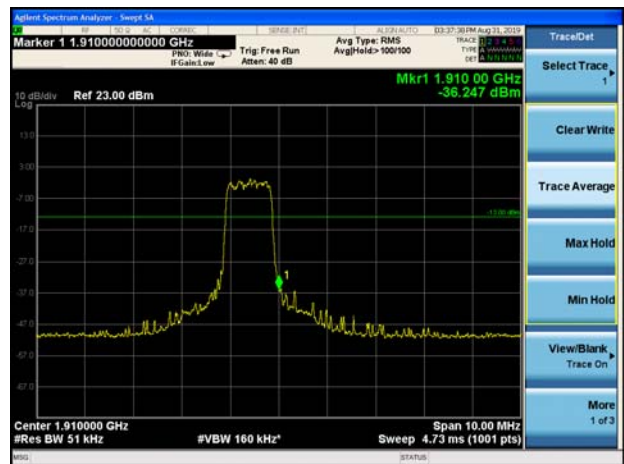

LTE Band 2 3MHz 16QAM 1RB CH-Low

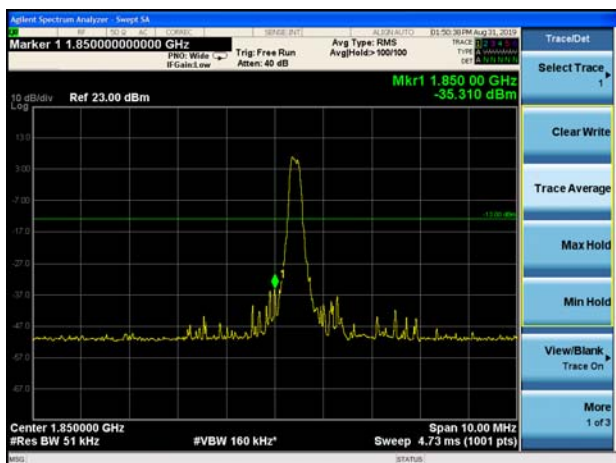

LTE Band 2 3MHz 16QAM 1RB CH-High

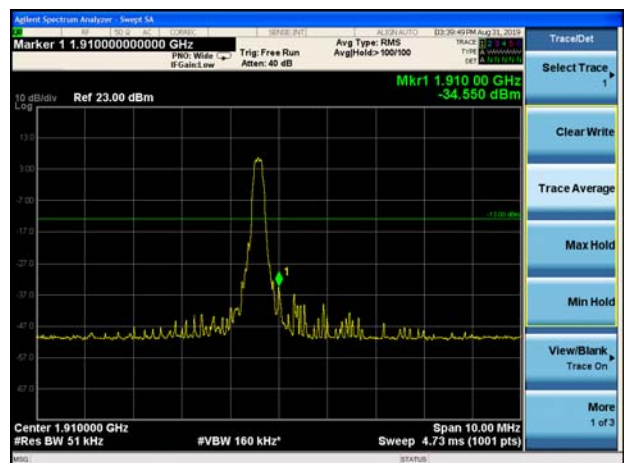



LTE Band 2 3MHz 16QAM 100%RB CH-Low

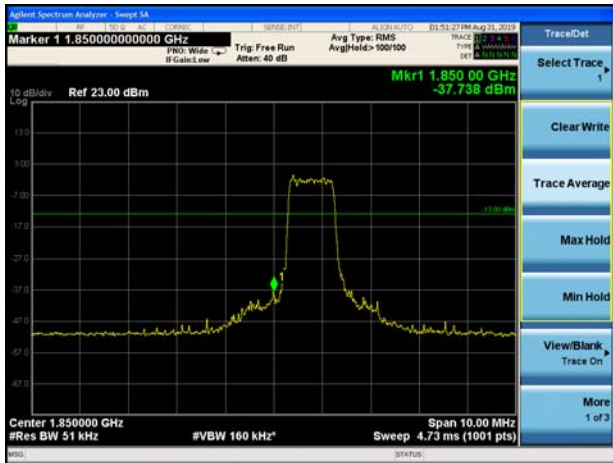

LTE Band 2 3MHz 16QAM 100%RB CH-High

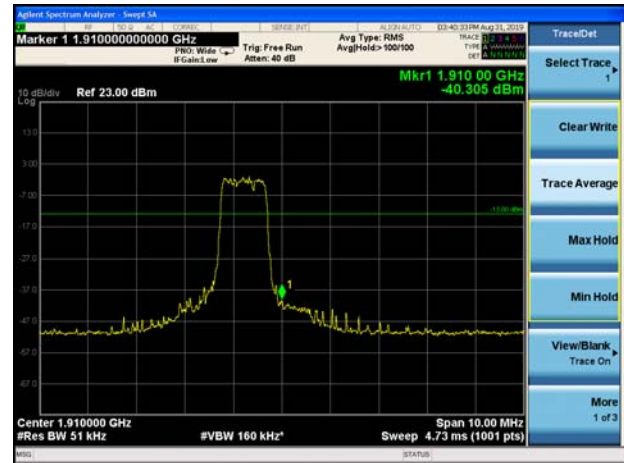

LTE Band 2 5MHz 16QAM 1RB CH-Low

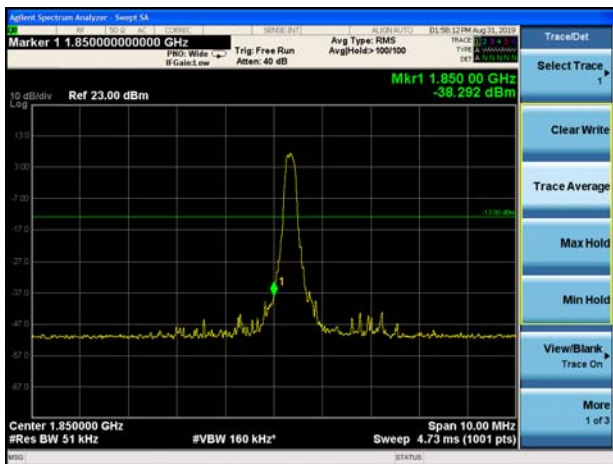

LTE Band 2 5MHz 16QAM 1RB CH-High

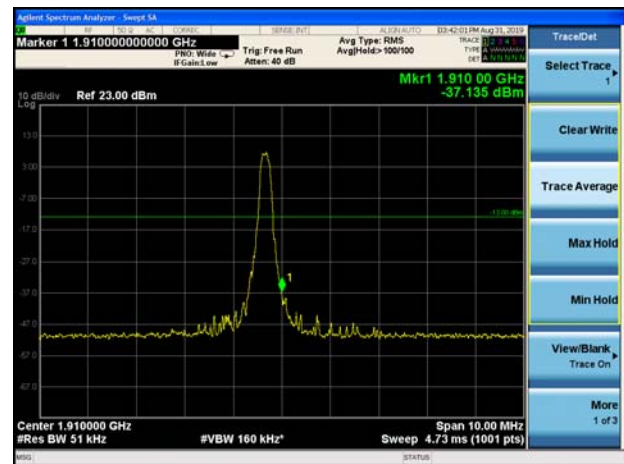

LTE Band 2 5MHz 16QAM 100%RB CH-Low

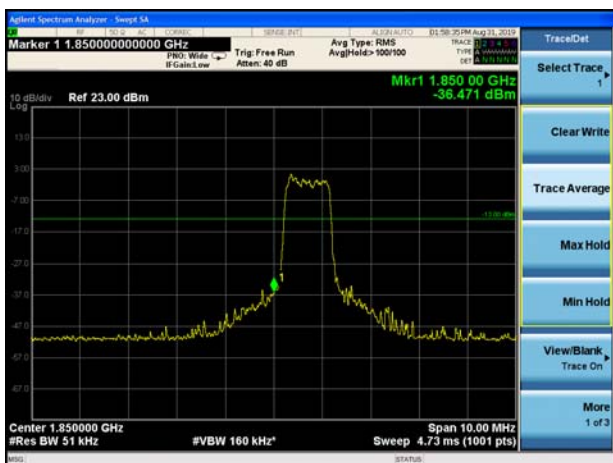

LTE Band 2 5MHz 16QAM 100%RB CH-High

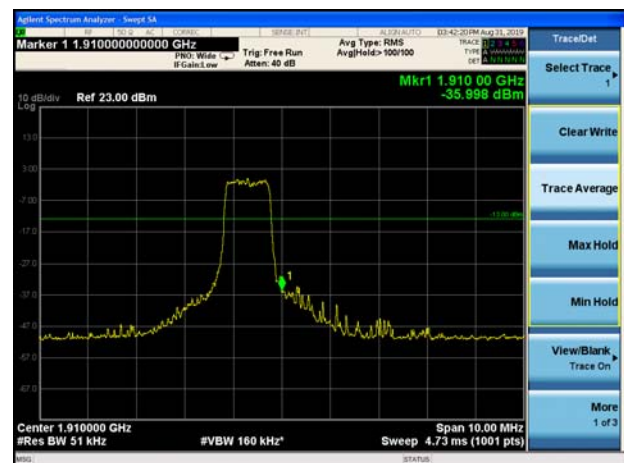



LTE Band 2 10MHz 16QAM 1RB CH-Low

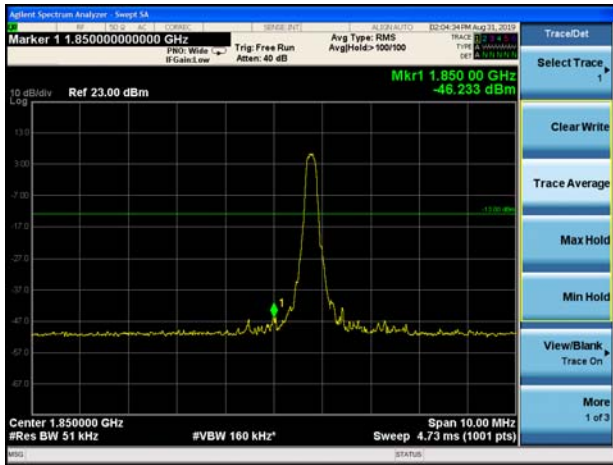

LTE Band 2 10MHz 16QAM 1RB CH-High

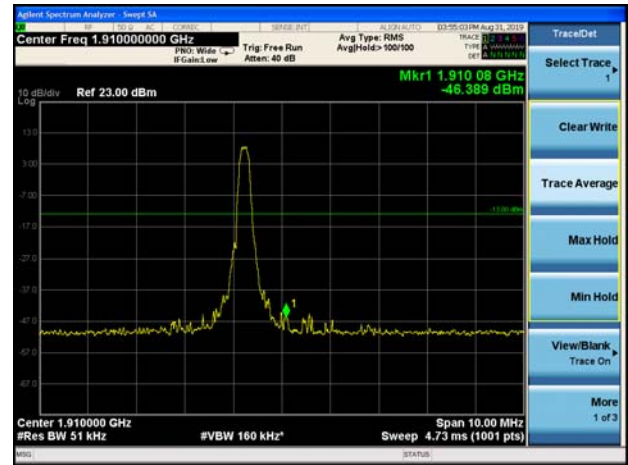

LTE Band 2 10MHz 16QAM 100%RB CH-Low

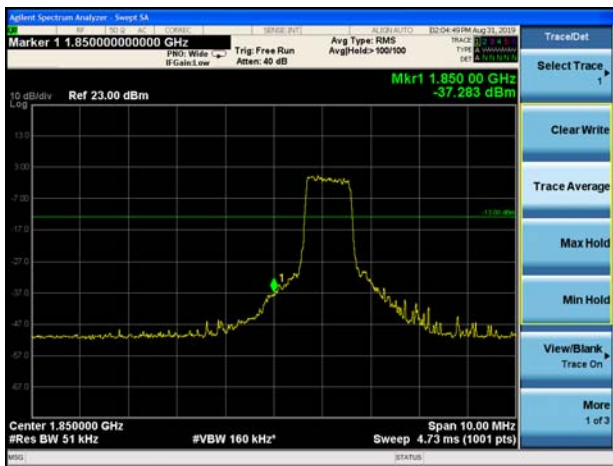

LTE Band 2 10MHz 16QAM 100%RB CH-High

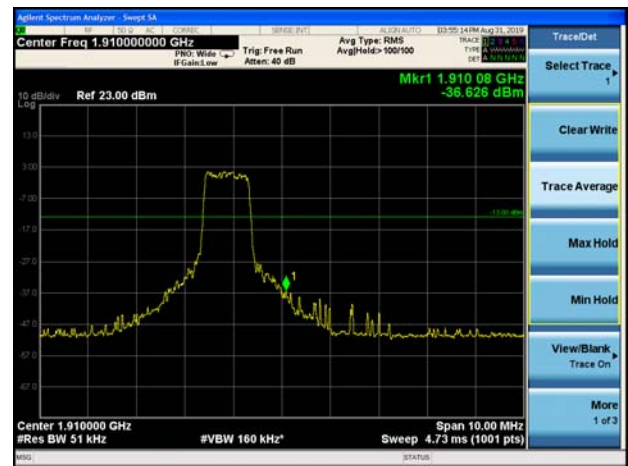

LTE Band 2 15MHz 16QAM 1RB CH-Low

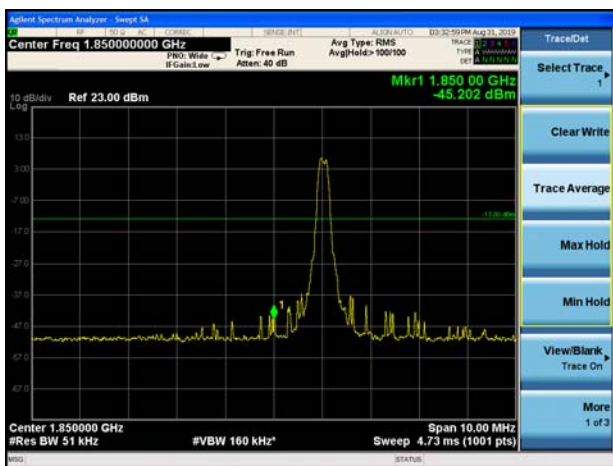

LTE Band 2 15MHz 16QAM 1RB CH-High

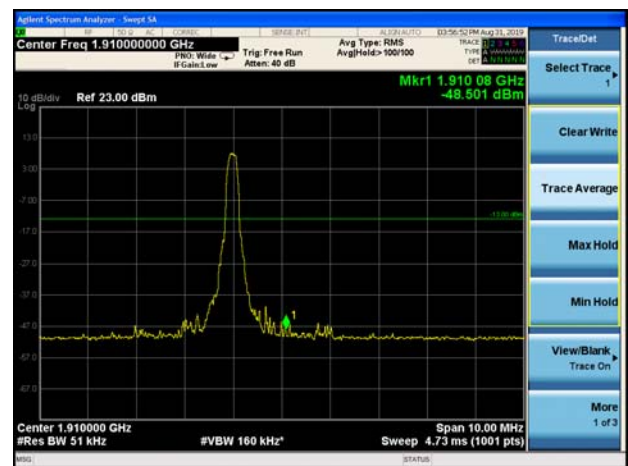



LTE Band 2 15MHz 16QAM 100%RB CH-Low

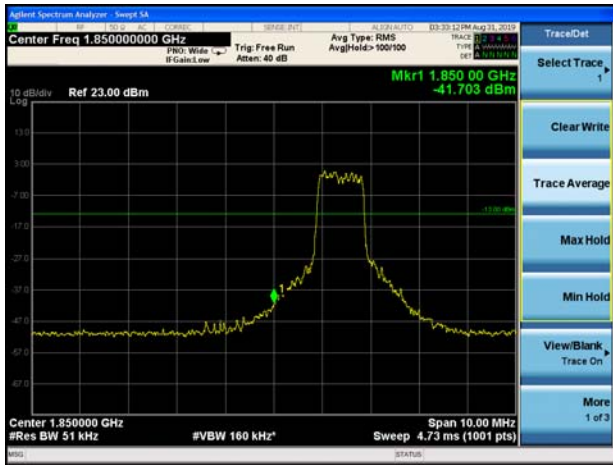

LTE Band 2 15MHz 16QAM 100%RB CH-High

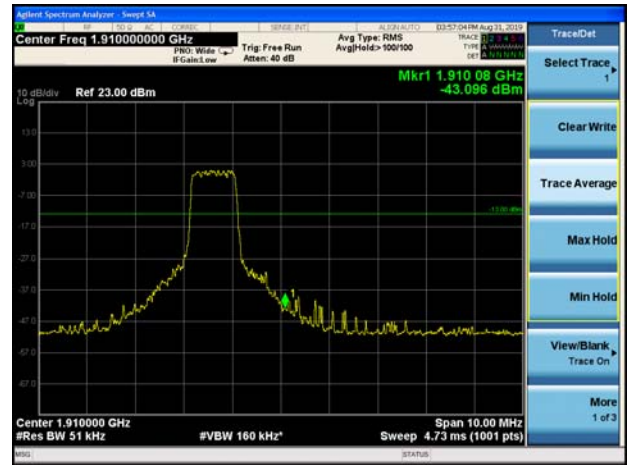

LTE Band 2 20MHz 16QAM 1RB CH-Low

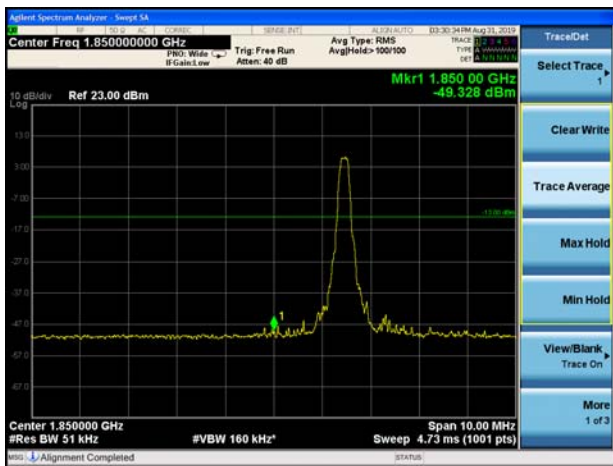

LTE Band 2 20MHz 16QAM 1RB CH-High

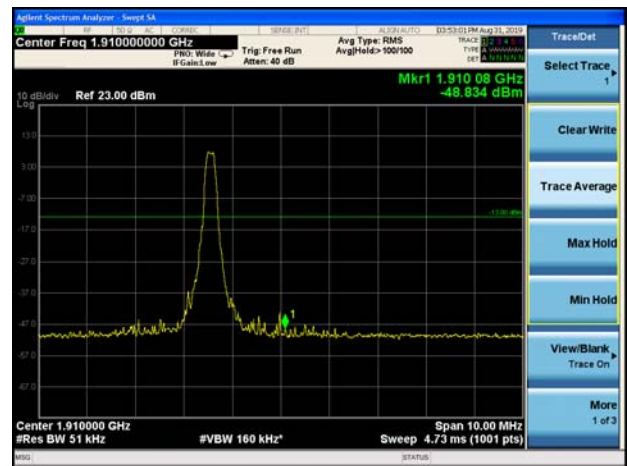

LTE Band 2 20MHz 16QAM 100%RB CH-Low

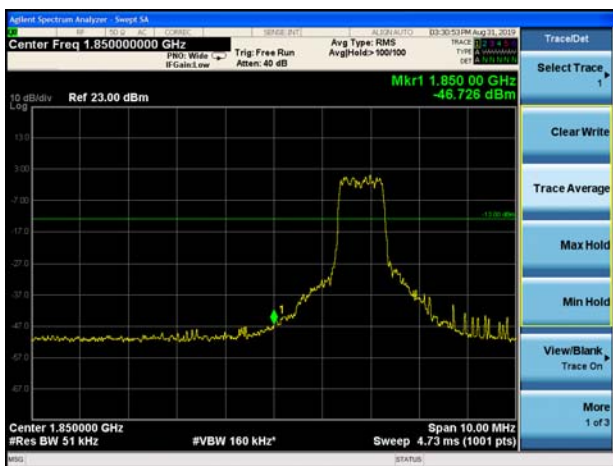

LTE Band 2 20MHz 16QAM 100%RB CH-High

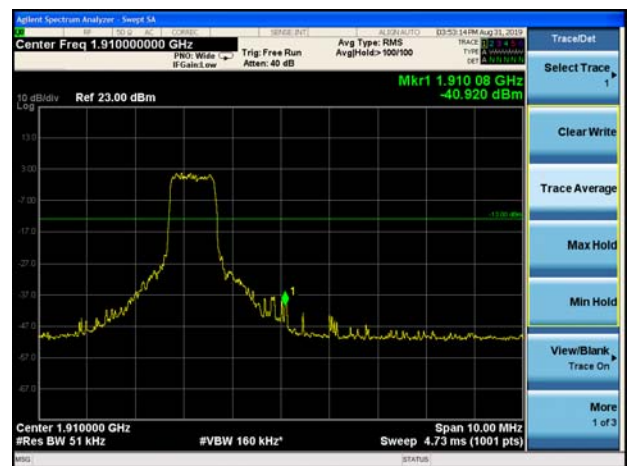

LTE Band 25 1.4MHz QPSK 1RB CH-Low

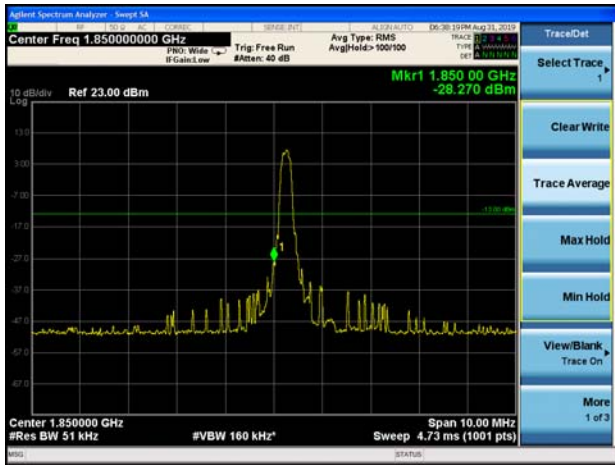

LTE Band 25 1.4MHz QPSK 1RB CH-High

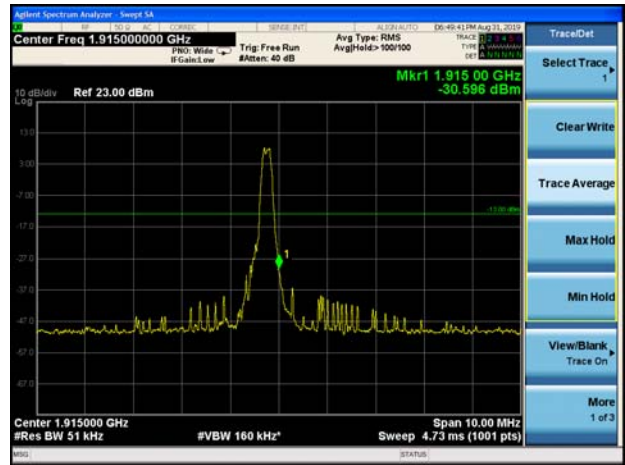

LTE Band 25 1.4MHz QPSK 100%RB CH-Low



LTE Band 25 1.4MHz QPSK 100%RB CH-High



LTE Band 25 3MHz QPSK 1RB CH-Low

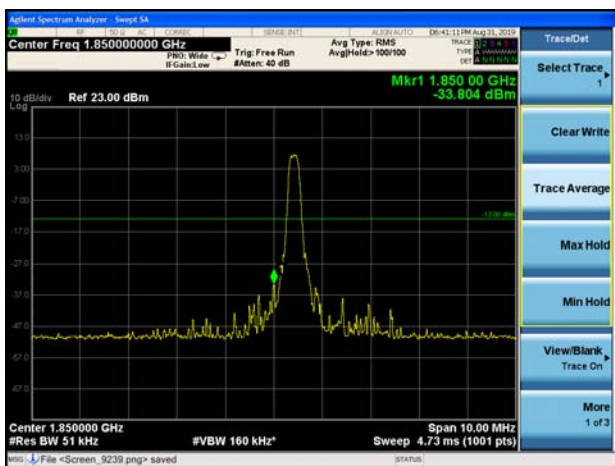

LTE Band 25 3MHz QPSK 1RB CH-High

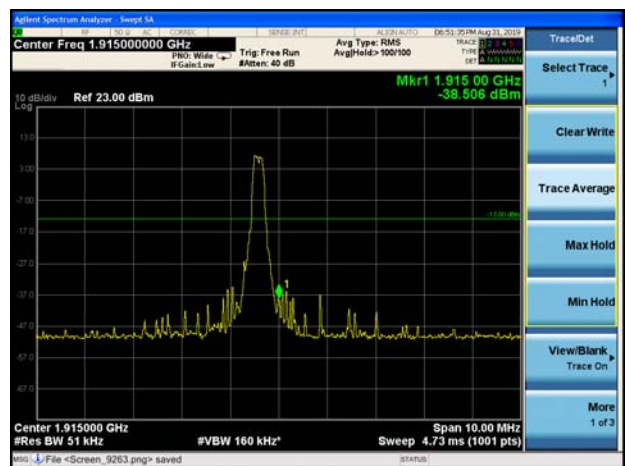

LTE Band 25 3MHz QPSK 100%RB CH-Low

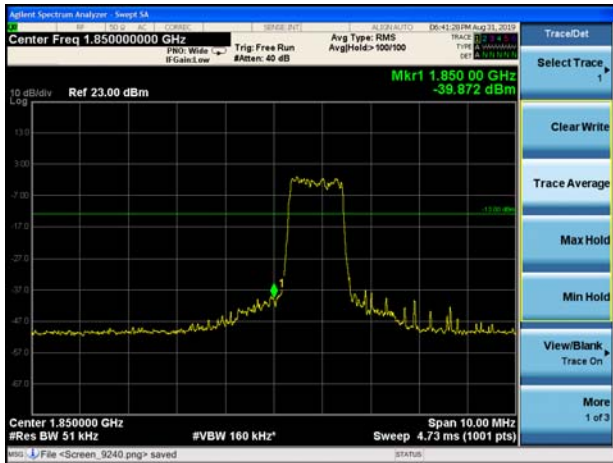

LTE Band 25 3MHz QPSK 100%RB CH-High

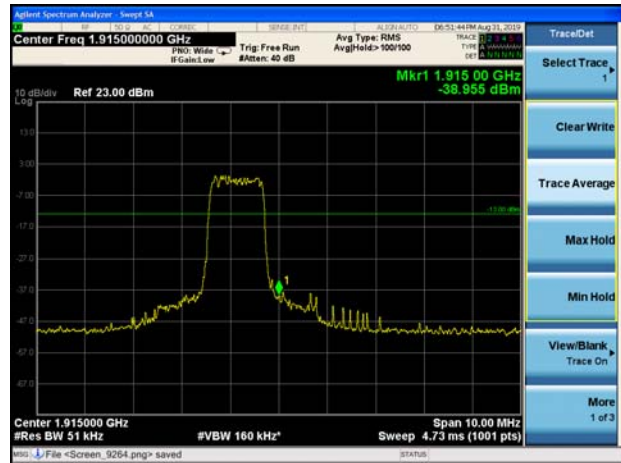

LTE Band 25 5MHz QPSK 1RB CH-Low

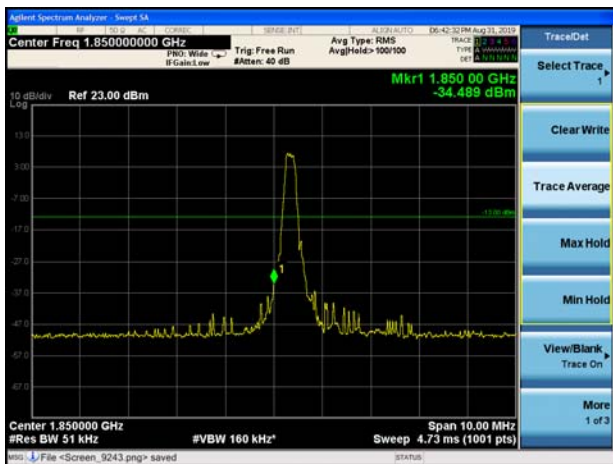

LTE Band 25 5MHz QPSK 1RB CH-High

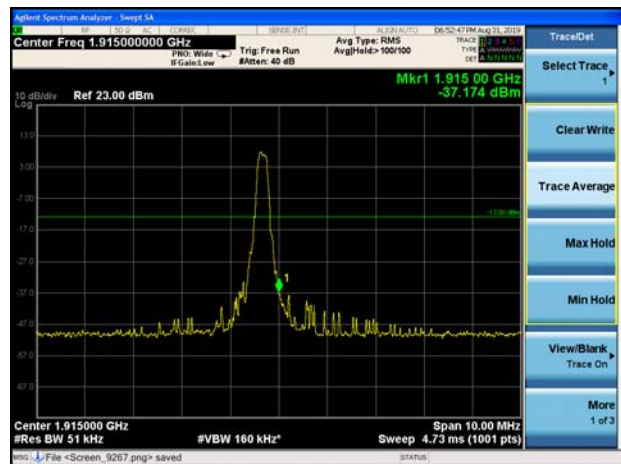

LTE Band 25 5MHz QPSK 100%RB CH-Low



LTE Band 25 5MHz QPSK 100%RB CH-High

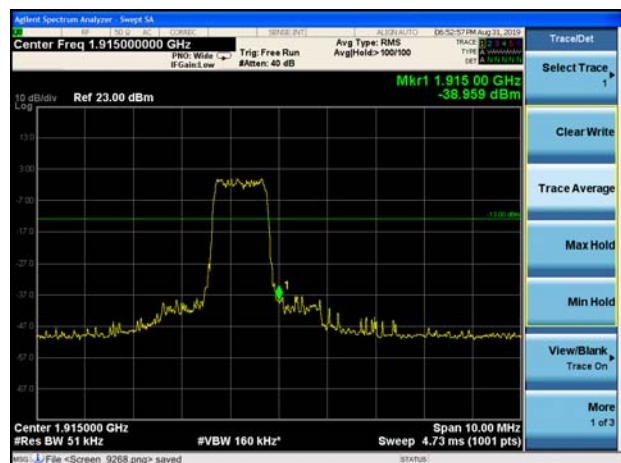

LTE Band 25 10MHz QPSK 1RB CH-Low

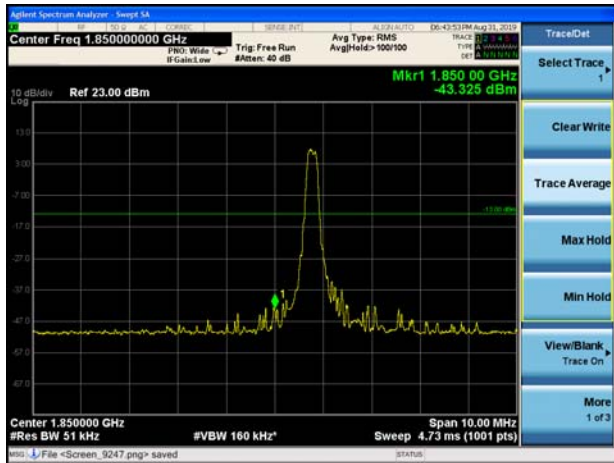

LTE Band 25 10MHz QPSK 1RB CH-High

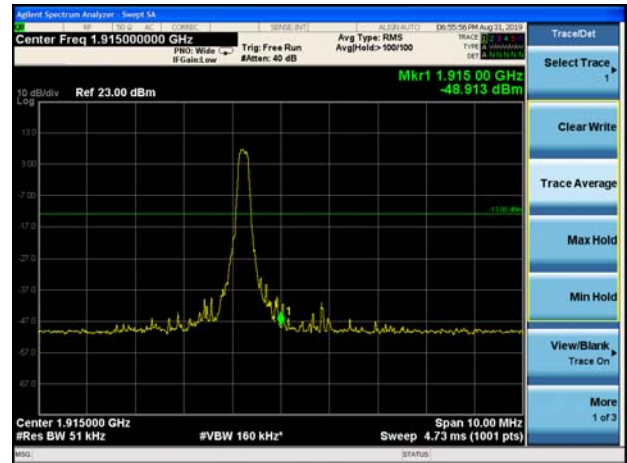

LTE Band 25 10MHz QPSK 100%RB CH-Low



LTE Band 25 10MHz QPSK 100%RB CH-High

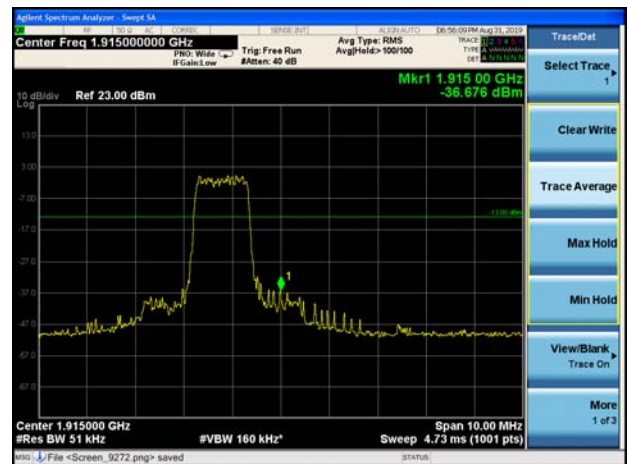

LTE Band 25 15MHz QPSK 1RB CH-Low

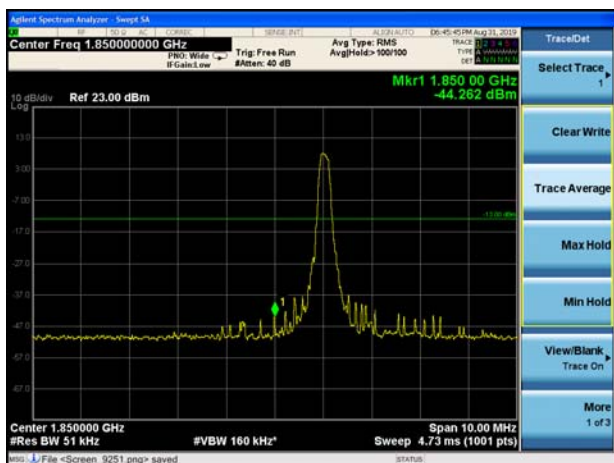

LTE Band 25 15MHz QPSK 1RB CH-High

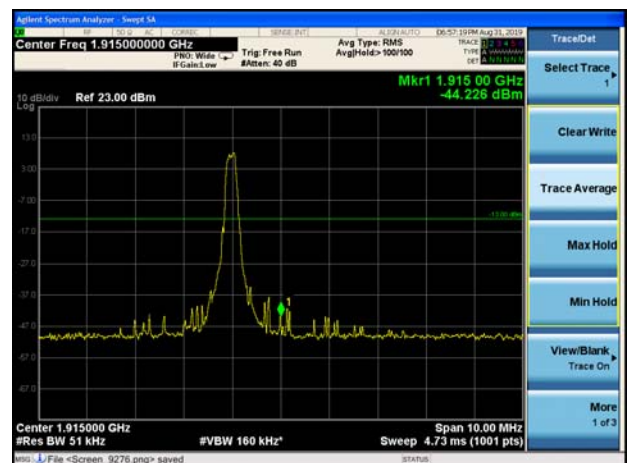



LTE Band 25 15MHz QPSK 100%RB CH-Low

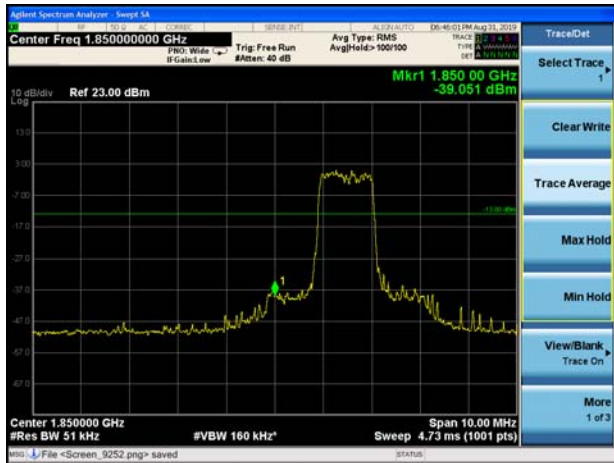

LTE Band 25 15MHz QPSK 100%RB CH-High



LTE Band 25 20MHz QPSK 1RB CH-Low

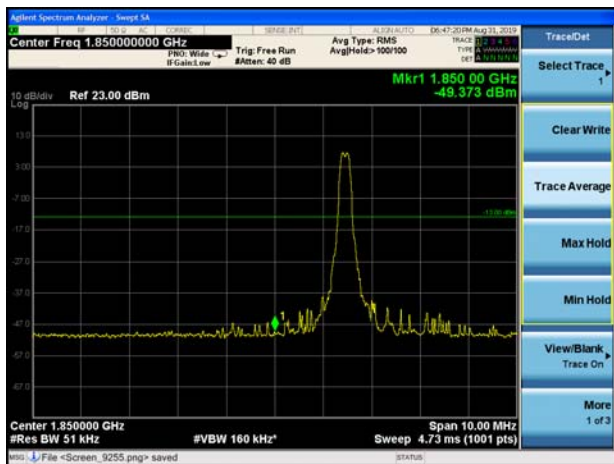

LTE Band 25 20MHz QPSK 1RB CH-High

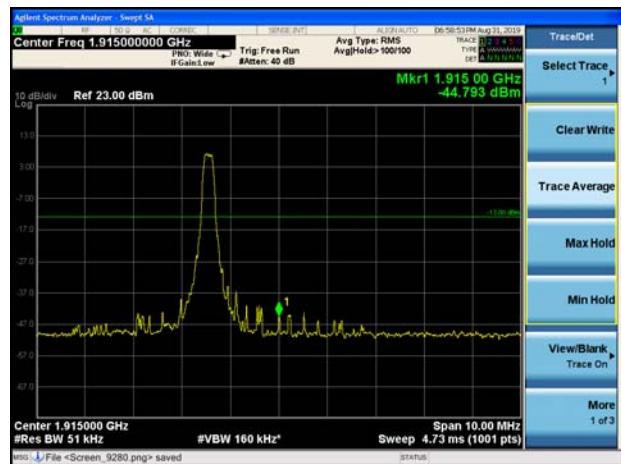

LTE Band 25 20MHz QPSK 100%RB CH-Low



LTE Band 25 20MHz QPSK 100%RB CH-High



LTE Band 25 1.4MHz 16QAM 1RB CH-Low

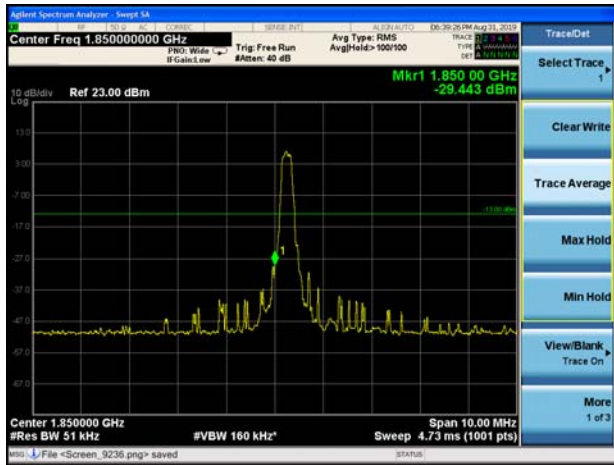

LTE Band 25 1.4MHz 16QAM 1RB CH-High

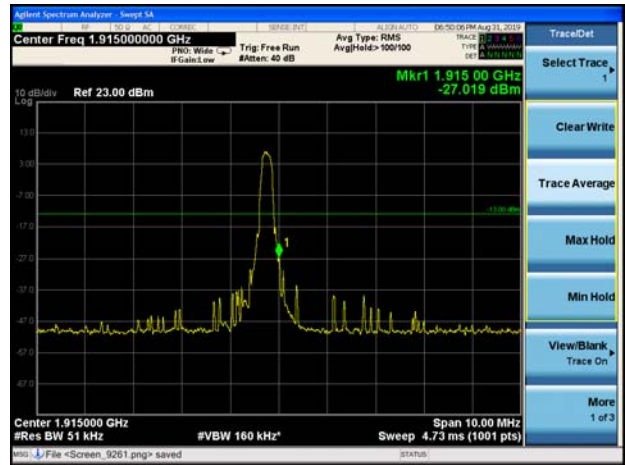

LTE Band 25 1.4MHz 16QAM 100%RB CH-Low

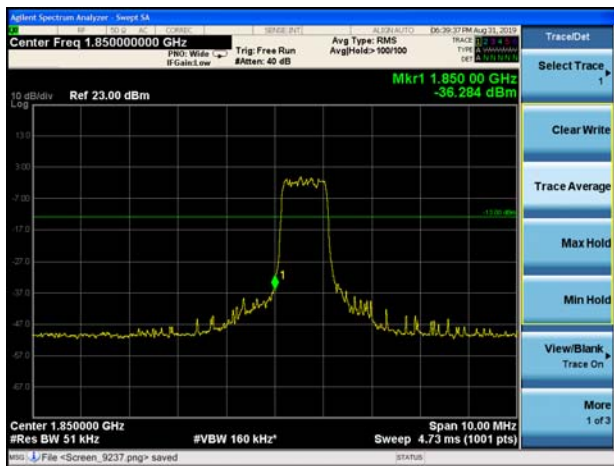

LTE Band 25 1.4MHz 16QAM 100%RB CH-High

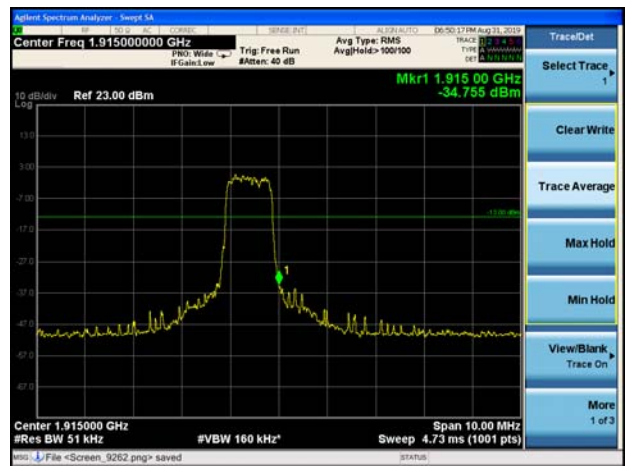

LTE Band 25 3MHz 16QAM 1RB CH-Low

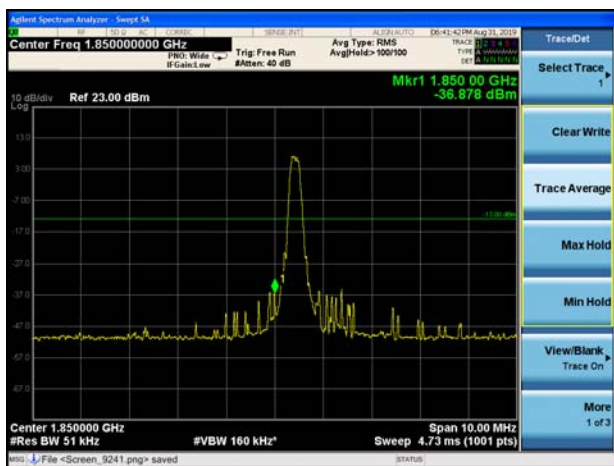

LTE Band 25 3MHz 16QAM 1RB CH-High

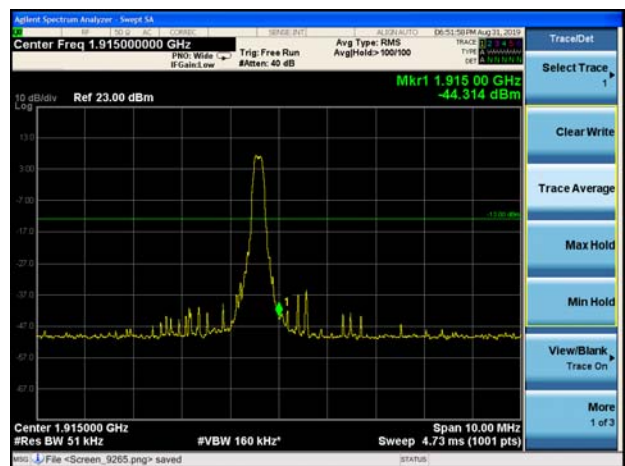

LTE Band 25 3MHz 16QAM 100%RB CH-Low

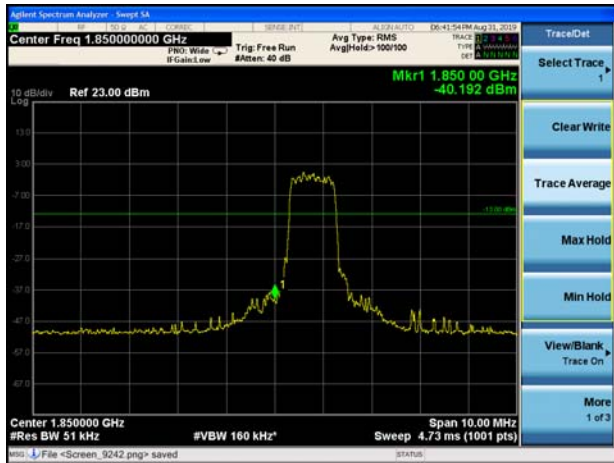

LTE Band 25 3MHz 16QAM 100%RB CH-High

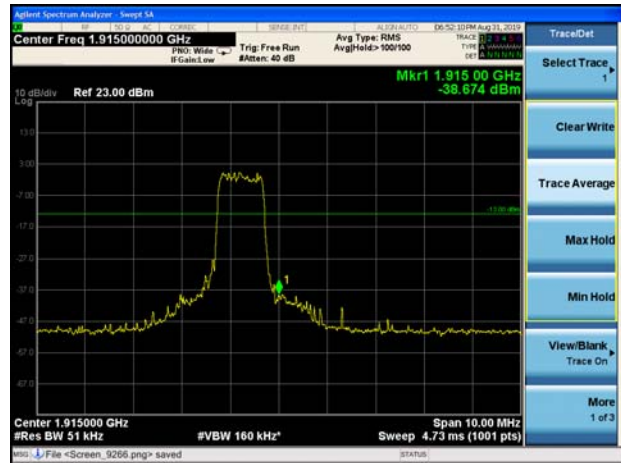

LTE Band 25 5MHz 16QAM 1RB CH-Low

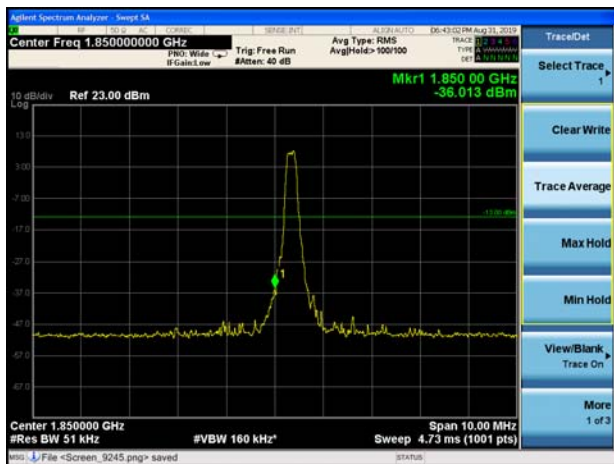

LTE Band 25 5MHz 16QAM 1RB CH-High

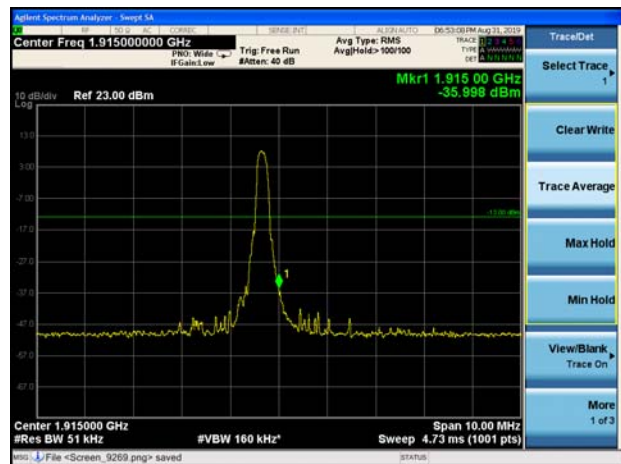

LTE Band 25 5MHz 16QAM 100%RB CH-Low

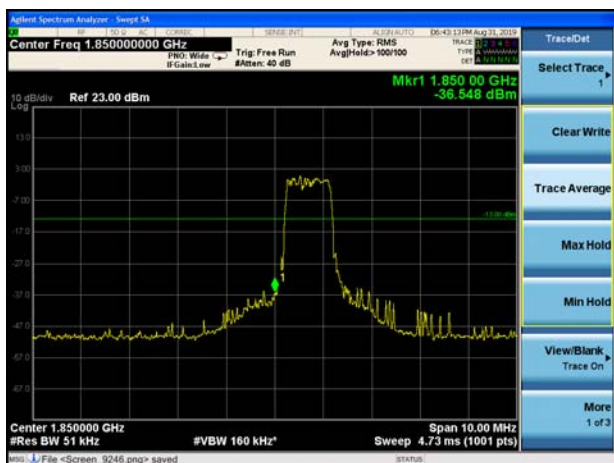

LTE Band 25 5MHz 16QAM 100%RB CH-High

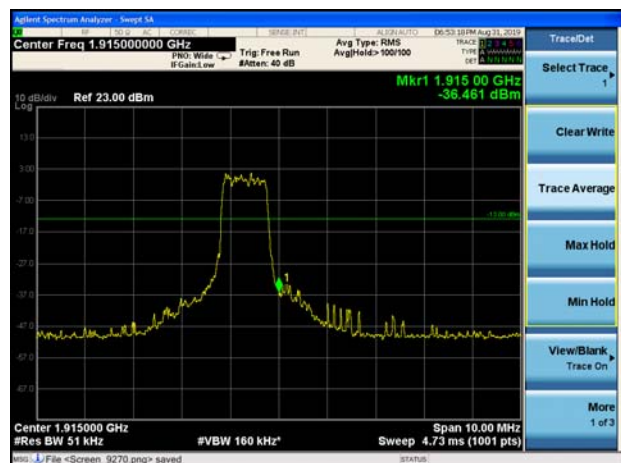

LTE Band 25 10MHz 16QAM 1RB CH-Low

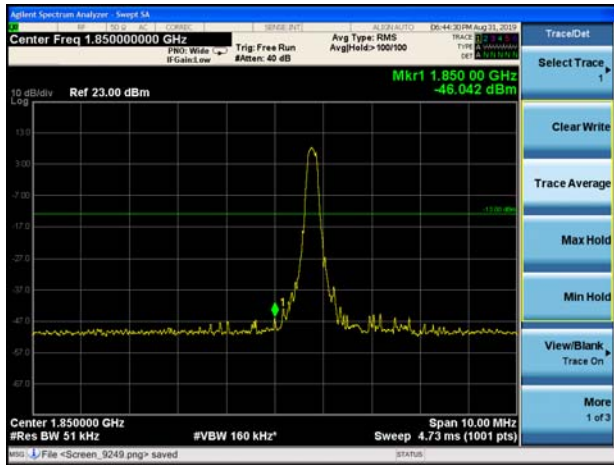

LTE Band 25 10MHz 16QAM 1RB CH-High

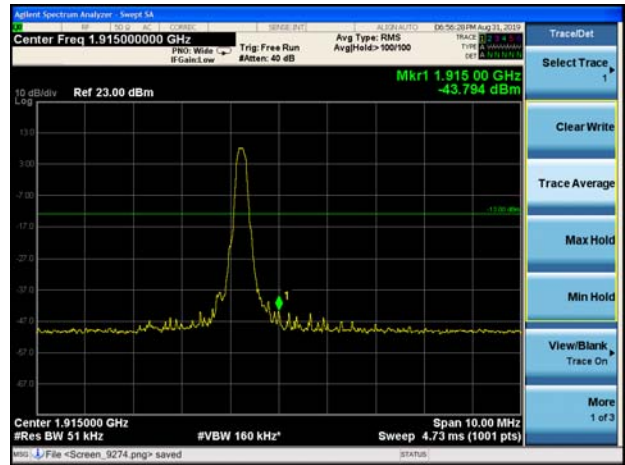

LTE Band 25 10MHz 16QAM 100%RB CH-Low

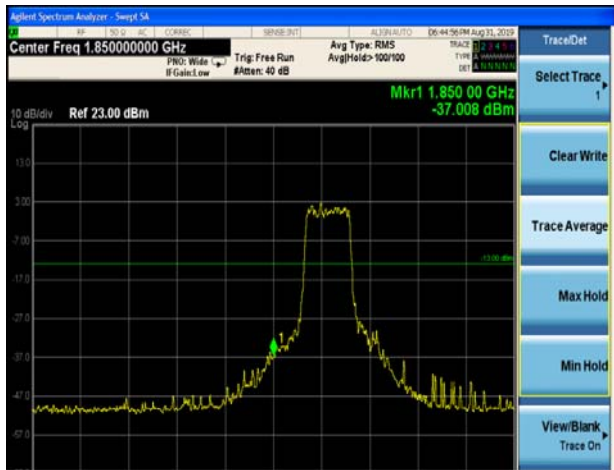

LTE Band 25 10MHz 16QAM 100%RB CH-High

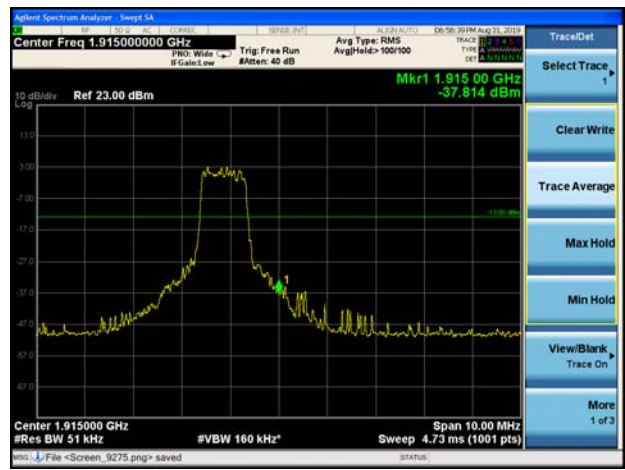

LTE Band 25 15MHz 16QAM 1RB CH-Low

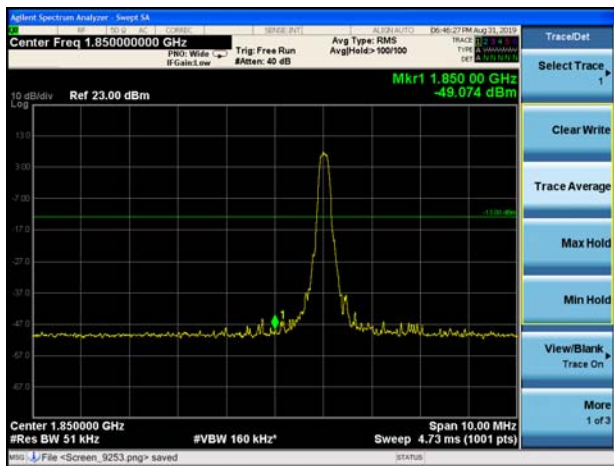

LTE Band 25 15MHz 16QAM 1RB CH-High

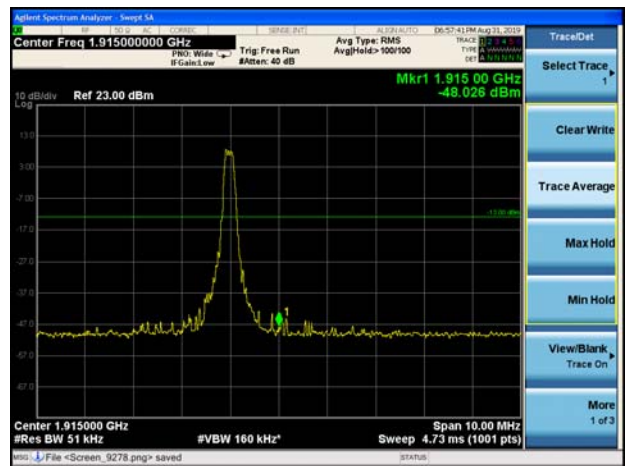

LTE Band 25 15MHz 16QAM 100%RB CH-Low

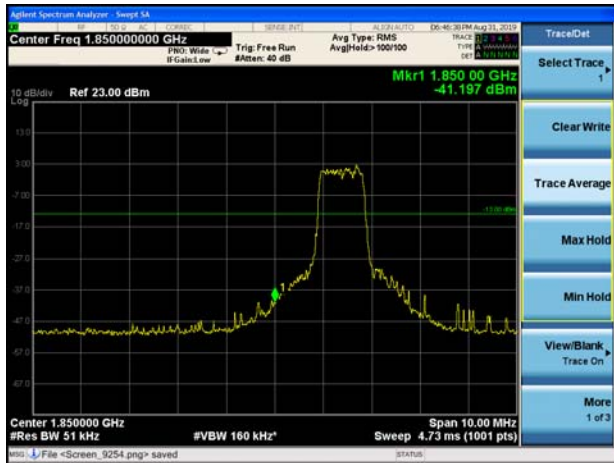

LTE Band 25 15MHz 16QAM 100%RB CH-High

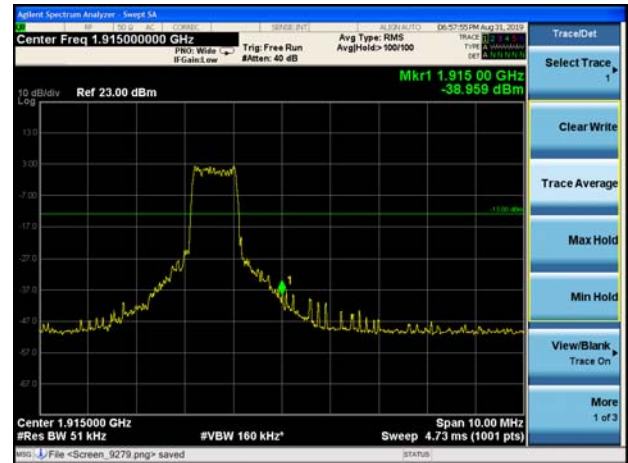

LTE Band 25 20MHz 16QAM 1RB CH-Low

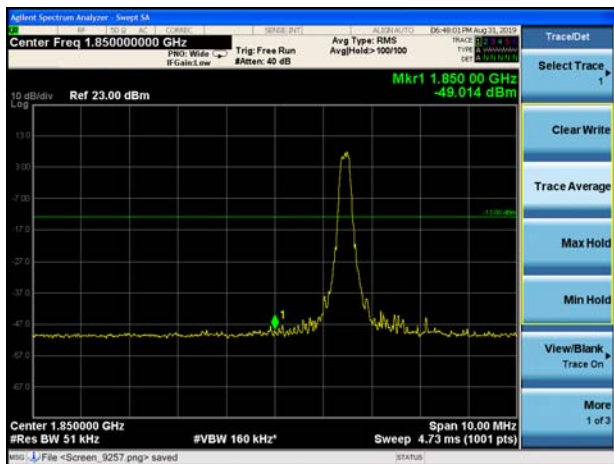

LTE Band 25 20MHz 16QAM 1RB CH-High

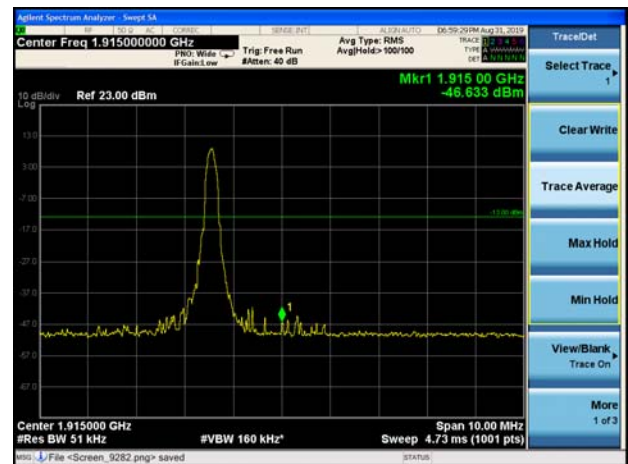

LTE Band 25 20MHz 16QAM 100%RB CH-Low

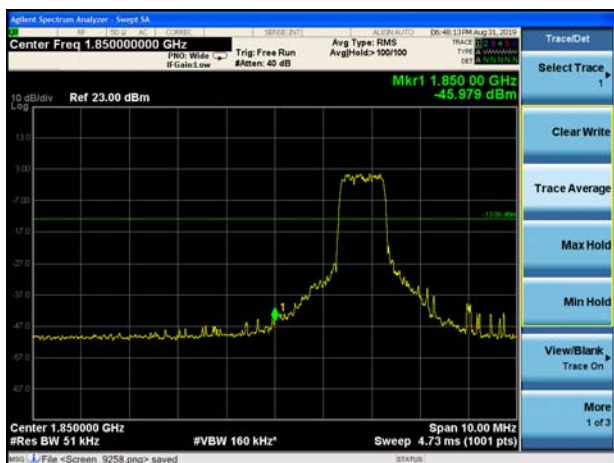

LTE Band 25 20MHz 16QAM 100%RB CH-High

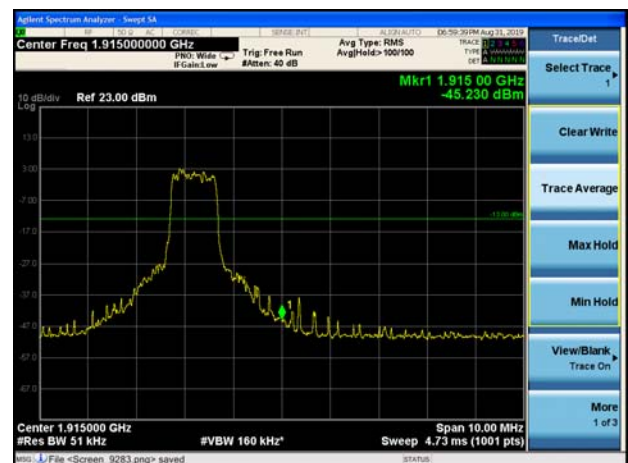

5.5. Peak-to-Average Power Ratio (PAPR)

Ambient condition

Temperature	Relative humidity	Pressure
23°C ~25°C	45%~50%	101.5kPa

Methods of Measurement

Measure the total peak power and record as PPk. And measure the total average power and record as PAvg. Both the peak and average power levels must be expressed in the same logarithmic units (e.g., dBm). Determine the PAPR from:

$$PAPR (dB) = PPk (dBm) - PAvg (dBm).$$

Test Setup

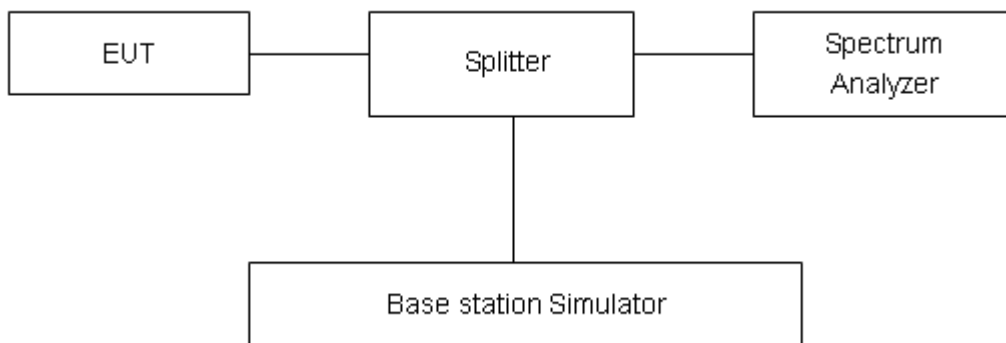

Limits

In measuring transmissions in this band using an average power technique, the peak-to-average ratio (PAR) of the transmission may not exceed 13 dB in 24.232(d).

Measurement Uncertainty

The assessed measurement uncertainty to ensure 95% confidence level for the normal distribution is with the coverage factor $k = 2$, $U = 0.4$ dB.

Test Results
Original

Mode	Bandwidth	Modulation	Channel/ Frequency(MHz)	Peak-to-Average Power Ratio (PAPR)		
				Peak(dBm)	Avg(dBm)	PAPR(dB)
Band2	1.4MHz	QPSK	18900/1880	23.36	13.73	9.63
		16QAM	18900/1880	23.92	13.75	10.17
	3MHz	QPSK	18900/1880	23.26	13.74	9.52
		16QAM	18900/1880	23.88	13.03	10.85
	5MHz	QPSK	18900/1880	24.05	14.56	9.49
		16QAM	18900/1880	24.62	14.54	10.08
	10MHz	QPSK	18900/1880	23.99	14.37	9.62
		16QAM	18900/1880	25.06	16.22	8.84
	15MHz	QPSK	18900/1880	24.59	15.69	8.90
		16QAM	18900/1880	24.99	15.36	9.63
	20MHz	QPSK	18900/1880	24.60	15.11	9.49
		16QAM	18900/1880	25.02	16.11	8.91

Mode	Bandwidth	Modulation	Channel/ Frequency(MHz)	Peak-to-Average Power Ratio (PAPR)		
				Peak(dBm)	Avg(dBm)	PAPR(dB)
Ban25	1.4MHz	QPSK	26365/1882.5	23.50	13.88	9.62
		16QAM	26365/1882.5	24.03	13.62	10.41
	3MHz	QPSK	26365/1882.5	23.24	11.62	11.62
		16QAM	26365/1882.5	23.97	11.71	12.26
	5MHz	QPSK	26365/1882.5	24.06	14.27	9.79
		16QAM	26365/1882.5	24.62	14.80	9.82
	10MHz	QPSK	26365/1882.5	23.99	14.60	9.39
		16QAM	26365/1882.5	24.95	15.52	9.43
	15MHz	QPSK	26365/1882.5	24.56	14.95	9.61
		16QAM	26365/1882.5	24.96	15.05	9.91
	20MHz	QPSK	26365/1882.5	24.43	15.57	8.86
		16QAM	26365/1882.5	24.84	15.30	9.54

5.6. Frequency Stability

Ambient condition

Temperature	Relative humidity	Pressure
23°C ~25°C	45%~50%	101.5kPa

Method of Measurement

Frequency Stability (Temperature Variation)

The temperature inside the climate chamber is varied from -40°C to +85°C in 10°C step size,

(1) With all power removed, the temperature was decreased to 0°C and permitted to stabilize for three hours.

(2) Measure the carrier frequency with the test equipment in a “call mode”. These measurements should be made within 1 minute of powering up the mobile station, to prevent significant self warming.

(3) Repeat the above measurements at 10°C increments from -40°C to +85°C. Allow at least 1.5 hours at each temperature, un-powered, before making measurements.

Frequency Stability (Voltage Variation)

The frequency stability shall be measured with variation of primary supply voltage as follows:

(1) Vary primary supply voltage from 85 to 115 percent of the nominal value for other than hand carried battery equipment.

(2) For hand carried, battery powered equipment, reduce primary supply voltage to the battery-operating end point which shall be specified by the manufacturer.

This transceiver is specified to operate with an input voltage of between 2.6 V and 4.8 V, with a nominal voltage of 3.3V.

Test setup

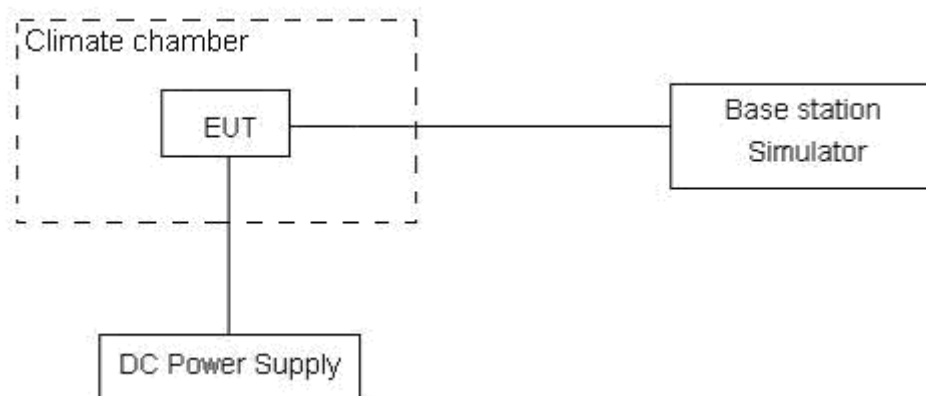

**Limits**

The frequency stability shall be sufficient to ensure that the fundamental emission stays within the authorized frequency block

Measurement Uncertainty

The assessed measurement uncertainty to ensure 99.75% confidence level for the normal distribution is with the coverage factor $k = 3$, $U = 0.01\text{ppm}$.

Test Result

Original

LTE Band 2						
Condition		Freq.Error (Hz)	Freq.Error (Hz)	Frequency Stability (ppm)	Frequency Stability (ppm)	Verdict
BANDWIDTH	20MHz	16QAM	QPSK	16QAM	QPSK	
Temperature	Voltage					
Normal (25°C)	Normal	8.75	1.16	0.00465	0.00062	PASS
Extreme (85°C)		3.01	2.15	0.00160	0.00114	PASS
Extreme (80°C)		5.60	17.72	0.00298	0.00942	PASS
Extreme (70°C)		1.21	15.85	0.00064	0.00843	PASS
Extreme (60°C)		13.32	2.66	0.00708	0.00141	PASS
Extreme (50°C)		17.90	13.21	0.00952	0.00703	PASS
Extreme (40°C)		17.38	10.04	0.00924	0.00534	PASS
Extreme (30°C)		6.20	1.75	0.00330	0.00093	PASS
Extreme (20°C)		16.72	12.64	0.00889	0.00672	PASS
Extreme (10°C)		5.22	1.40	0.00278	0.00074	PASS
Extreme (0°C)		14.28	11.08	0.00760	0.00589	PASS
Extreme (-10°C)		7.16	2.02	0.00381	0.00107	PASS
Extreme (-20°C)		2.20	11.62	0.00117	0.00618	PASS
Extreme (-30°C)		5.59	3.38	0.00297	0.00180	PASS
Extreme (-40°C)		2.24	15.61	0.00119	0.00830	PASS
25°C	LV	1.99	14.97	0.00106	0.00796	PASS
	HV	5.45	10.06	0.00290	0.00535	PASS

LTE Band 25						
Condition		Freq.Error (Hz)	Freq.Error (Hz)	Frequency Stability (ppm)	Frequency Stability (ppm)	Verdict
BANDWIDTH	20MHz	16QAM	QPSK	16QAM	QPSK	
Temperature	Voltage					
Normal (25°C)	Normal	12.24	9.82	0.00651	0.00522	PASS
Extreme (85°C)		9.78	1.98	0.00520	0.00105	PASS
Extreme (80°C)		6.14	11.34	0.00326	0.00603	PASS
Extreme (70°C)		1.72	8.51	0.00091	0.00453	PASS
Extreme (60°C)		5.32	2.65	0.00283	0.00141	PASS
Extreme (50°C)		15.72	13.77	0.00836	0.00732	PASS
Extreme (40°C)		1.48	17.95	0.00079	0.00955	PASS
Extreme (30°C)		1.00	1.18	0.00053	0.00063	PASS
Extreme (20°C)		4.05	15.02	0.00215	0.00799	PASS
Extreme (10°C)		15.05	1.07	0.00800	0.00057	PASS



Extreme (0°C)		4.29	6.01	0.00228	0.00320	PASS
Extreme (-10°C)		1.80	11.80	0.00096	0.00628	PASS
Extreme (-20°C)		11.65	6.45	0.00620	0.00343	PASS
Extreme (-30°C)		5.29	11.53	0.00282	0.00613	PASS
Extreme (-40°C)		9.61	15.16	0.00511	0.00806	PASS
25°C	LV	8.93	8.97	0.00475	0.00477	PASS
	HV	3.20	1.90	0.00170	0.00101	PASS

5.7. Spurious Emissions at Antenna Terminals

Ambient condition

Temperature	Relative humidity	Pressure
23°C ~25°C	45%~50%	101.5kPa

Method of Measurement

The EUT was connected to Spectrum Analyzer and Base Station Simulator via power Splitter. The measurement is carried out using a spectrum analyzer. The spectrum analyzer scans from 9kHz to the 10th harmonic of the carrier. The peak detector is used.

RBW is set to 100kHz, VBW is set to 300kHz for 30MHz~1GHz

RBW is set to 1MHz, VBW is set to 3MHz for above 1GHz, Sweep is set to ATUO.

The modulation mode and RB allocation refer to section 5.1, using the maximum output power configuration.

Test setup

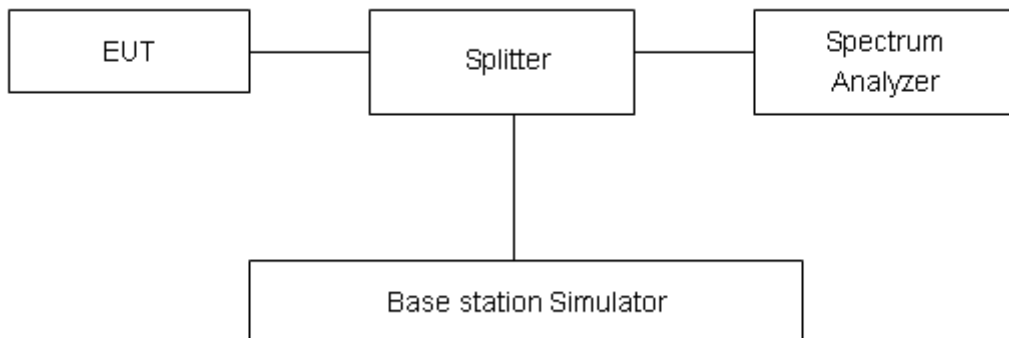

Limits

Rule Part 24.238(a) specifies that “on any frequency outside a licensee's frequency block, the power of any emission shall be attenuated below the transmitter power (P) by at least 43 + 10 log₁₀ (P) dB.”

Limit	-13 dBm
-------	---------

Measurement Uncertainty

The assessed measurement uncertainty to ensure 99.75% confidence level for the normal distribution is with the coverage factor $k = 1.96$.

Frequency	Uncertainty
9kHz-1GHz	0.684 dB
1GHz-20GHz	1.407 dB



Test Result

Sweep the whole frequency band through the range from 9kHz to the 10th harmonic of the carrier, the emissions more than 20 dB below the limit are not reported.

The signal beyond the limit is carrier.

Original

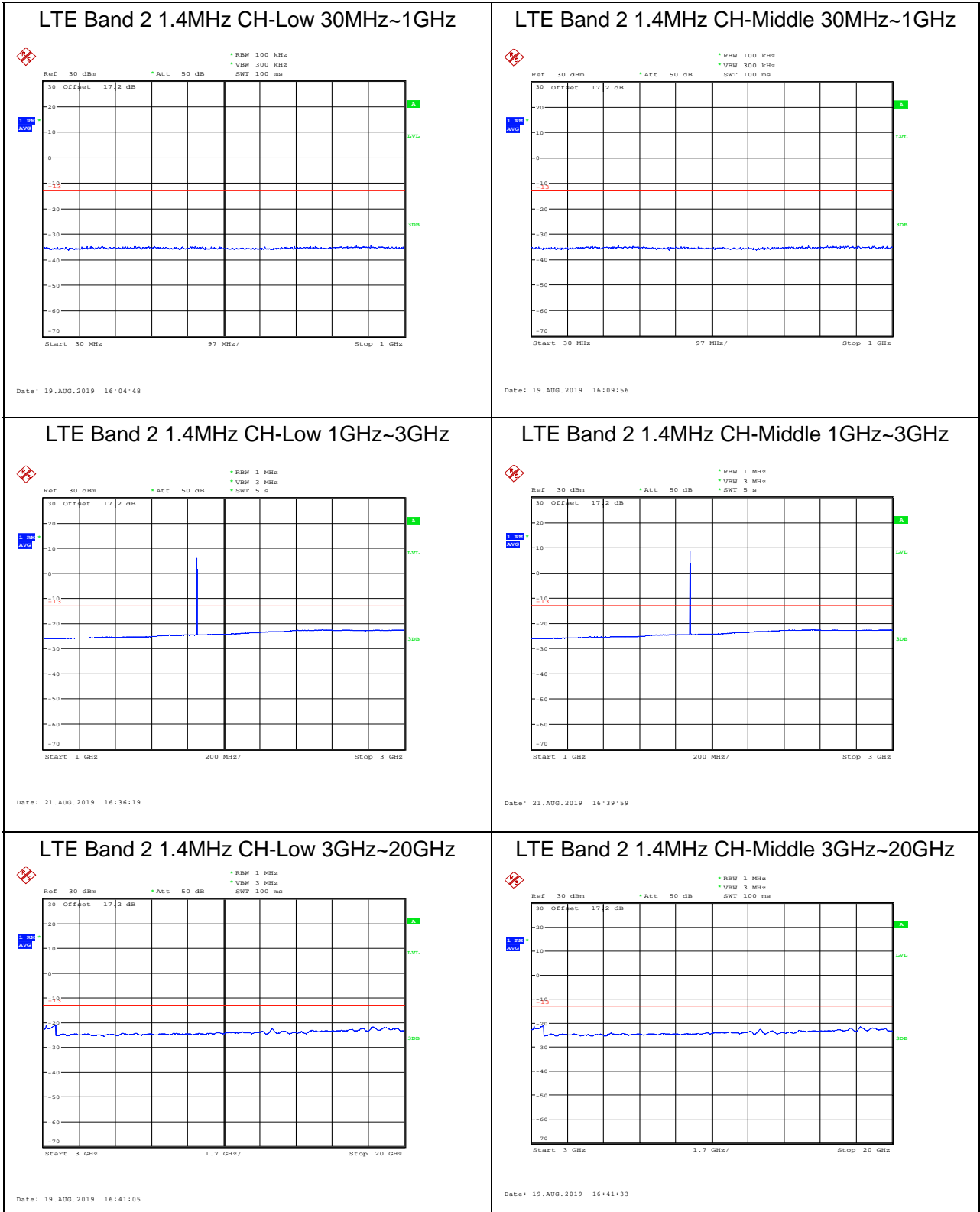



LTE Band 2 1.4MHz CH-High 30MHz~1GHz

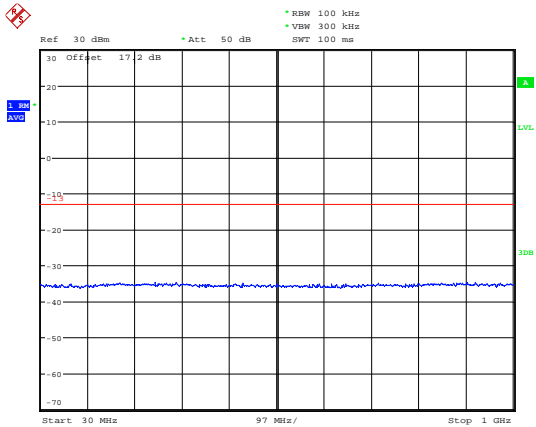

Date: 19.AUG.2019 16:19:28

LTE Band 2 3MHz CH-Low 30MHz~1GHz

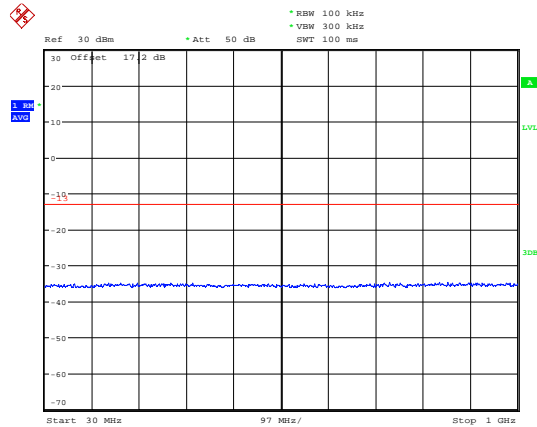

Date: 19.AUG.2019 16:19:54

LTE Band 2 1.4MHz CH-High 1GHz~3GHz

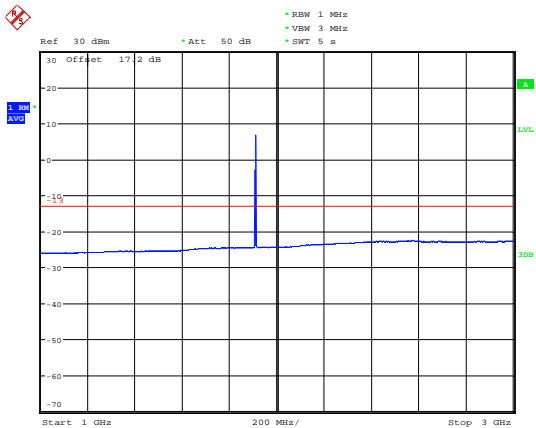

Date: 21.AUG.2019 16:41:47

LTE Band 2 3MHz CH-Low 1GHz~3GHz

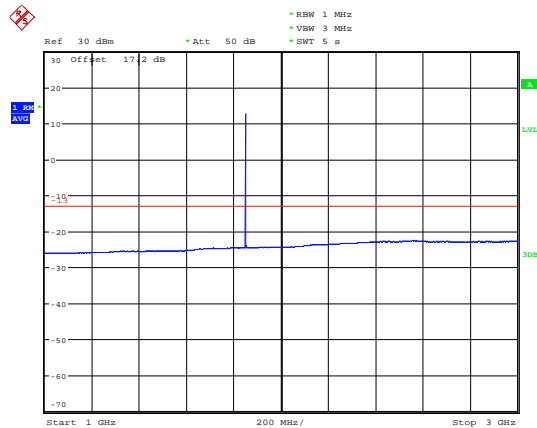

Date: 21.AUG.2019 16:43:25

LTE Band 2 1.4MHz CH-High 3GHz~20GHz

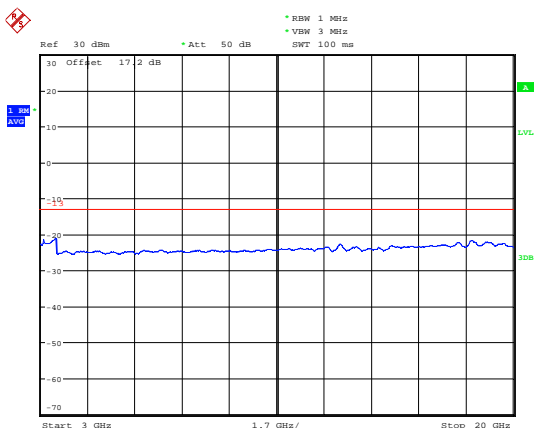

Date: 19.AUG.2019 16:43:12

LTE Band 2 3MHz CH-Low 3GHz~20GHz

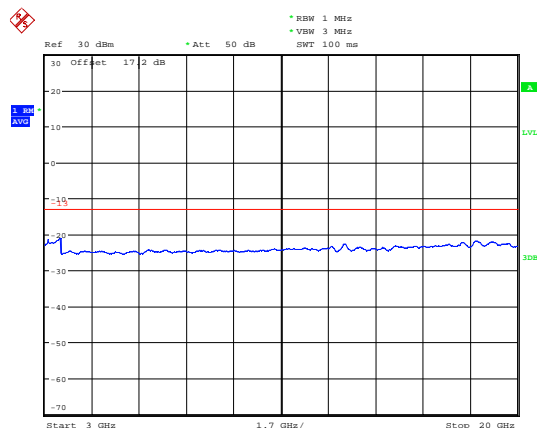

Date: 19.AUG.2019 16:44:25



LTE Band 2 3MHz CH-Middle 30MHz~1GHz

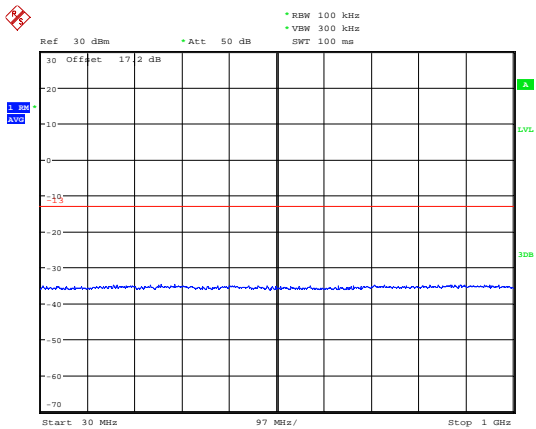

Date: 19.AUG.2019 16:20:15

LTE Band 2 3MHz CH-High 30MHz~1GHz

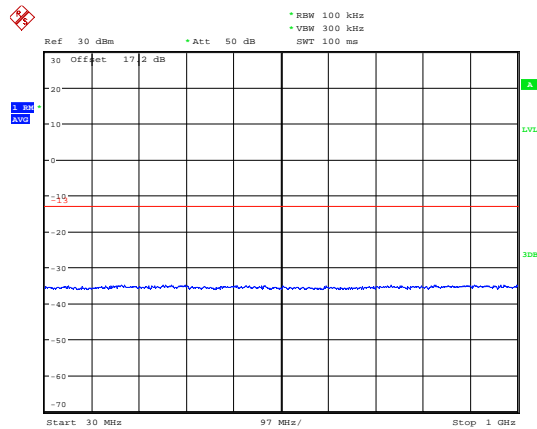

Date: 19.AUG.2019 16:21:21

LTE Band 2 3MHz CH-Middle 1GHz~3GHz

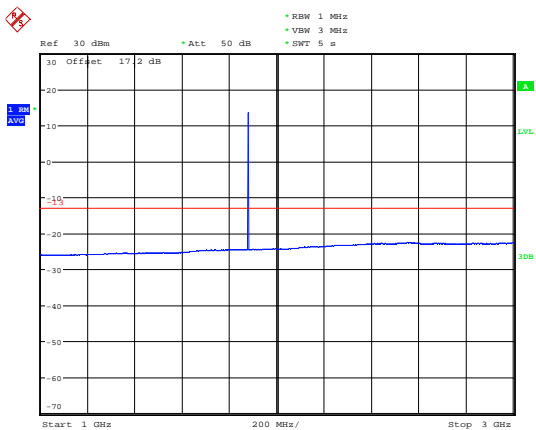

Date: 21.AUG.2019 16:45:19

LTE Band 2 3MHz CH-High 1GHz~3GHz

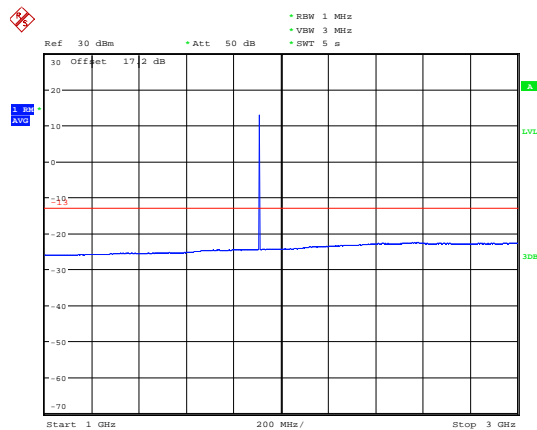

Date: 21.AUG.2019 16:47:27

LTE Band 2 3MHz CH-Middle 3GHz~20GHz

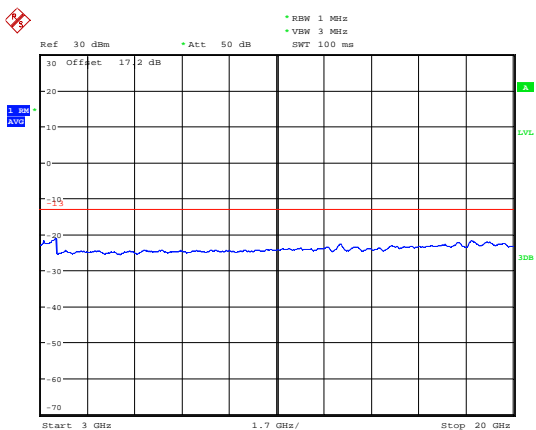

Date: 19.AUG.2019 16:44:44

LTE Band 2 3MHz CH-High 3GHz~20GHz

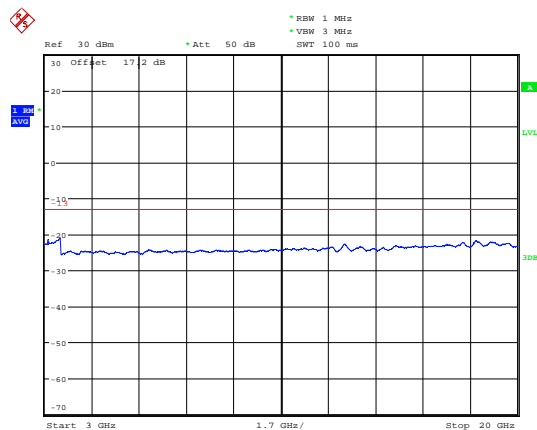

Date: 19.AUG.2019 16:45:46



LTE Band 2 5MHz CH-Low 30MHz~1GHz

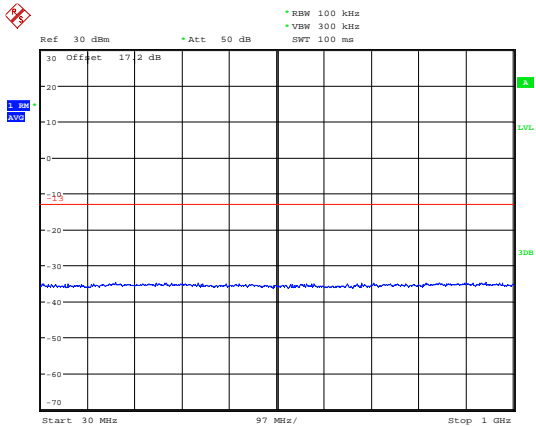

Date: 19.AUG.2019 16:21:32

LTE Band 2 5MHz CH-Middle 30MHz~1GHz

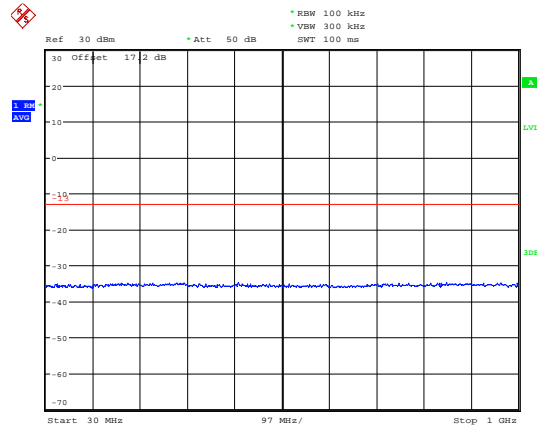

Date: 19.AUG.2019 16:23:29

LTE Band 2 5MHz CH-Low 1GHz~3GHz

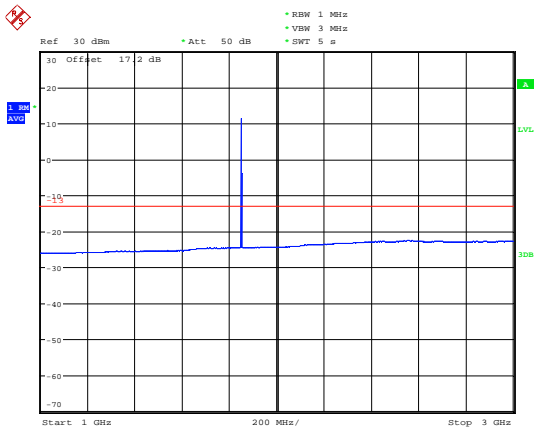

Date: 21.AUG.2019 16:49:07

LTE Band 2 5MHz CH-Middle 1GHz~3GHz

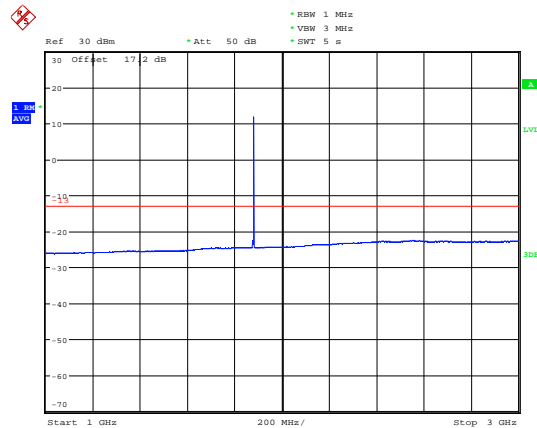

Date: 21.AUG.2019 16:50:31

LTE Band 2 5MHz CH-Low 3GHz~20GHz

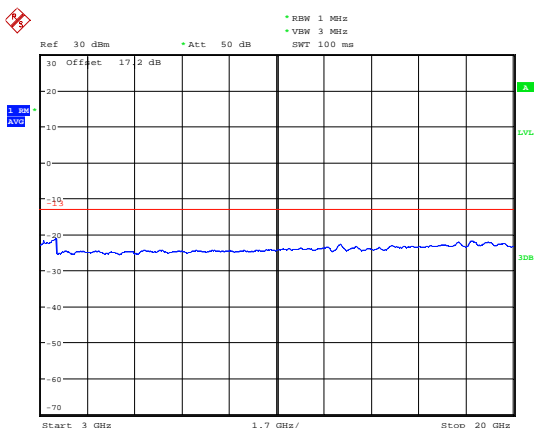

Date: 19.AUG.2019 16:46:58

LTE Band 2 5MHz CH-Middle 3GHz~20GHz

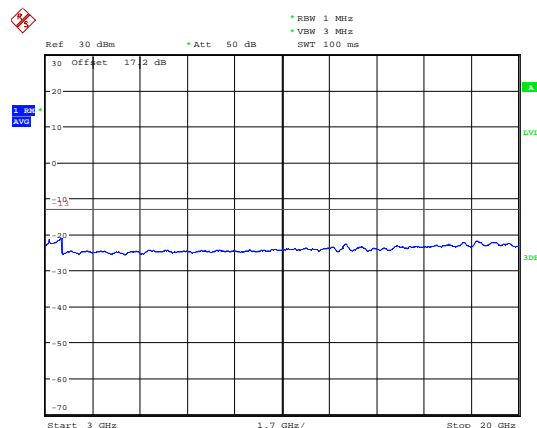

Date: 19.AUG.2019 16:48:15



LTE Band 2 5MHz CH-High 30MHz~1GHz

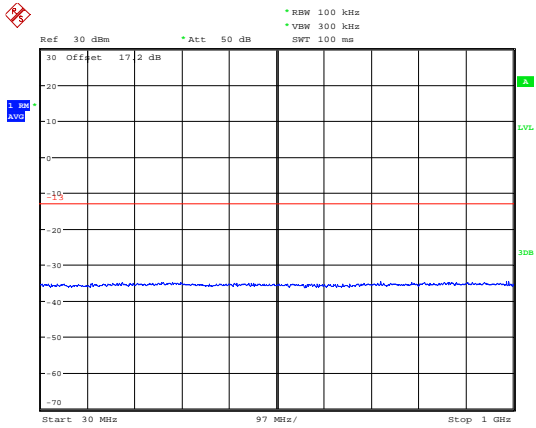

Date: 19.AUG.2019 16:13:20

LTE Band 2 10MHz CH-Low 30MHz~1GHz

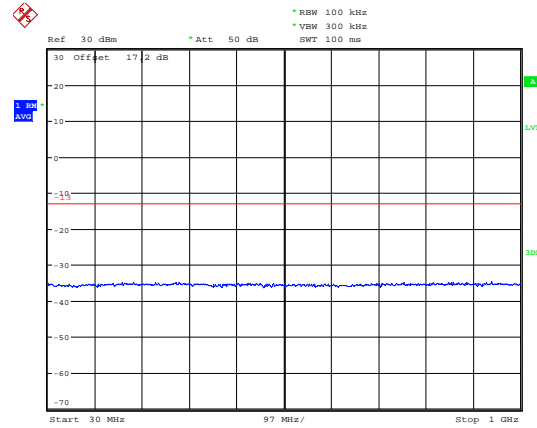

Date: 19.AUG.2019 16:24:02

LTE Band 2 5MHz CH-High 1GHz~3GHz

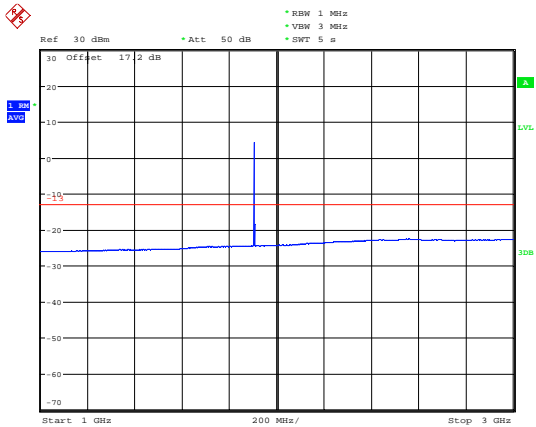

Date: 21.AUG.2019 16:52:57

LTE Band 2 10MHz CH-Low 1GHz~3GHz

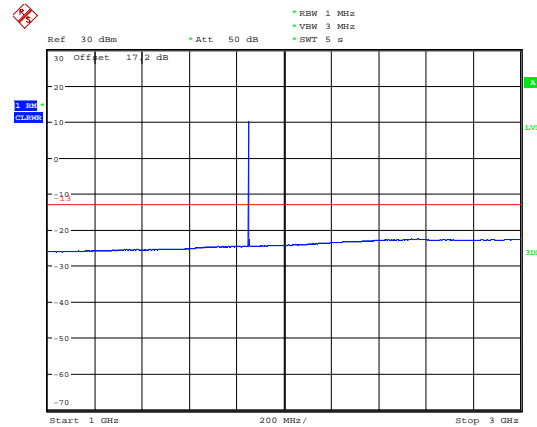

Date: 21.AUG.2019 16:54:46

LTE Band 2 5MHz CH-High 3GHz~20GHz

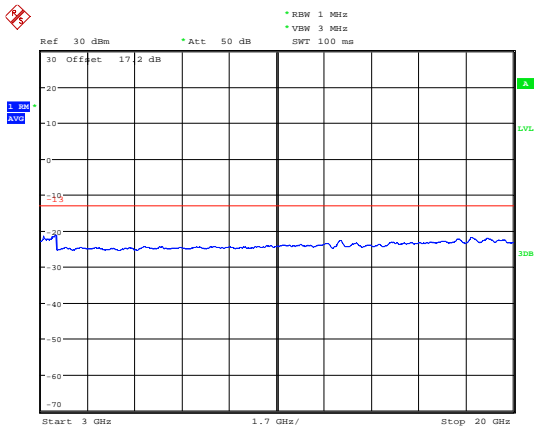

Date: 19.AUG.2019 16:48:33

LTE Band 2 10MHz CH-Low 3GHz~20GHz

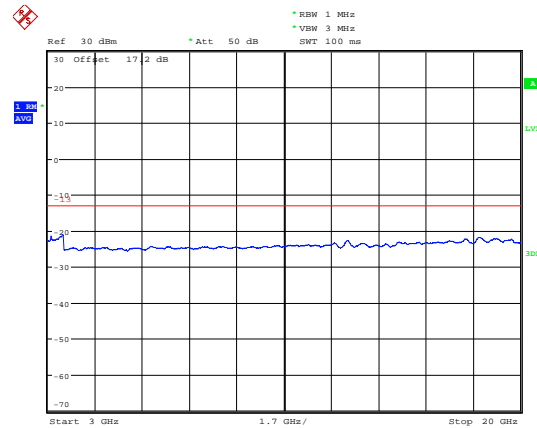

Date: 19.AUG.2019 16:48:51



LTE Band 2 10MHz CH-Middle 30MHz~1GHz

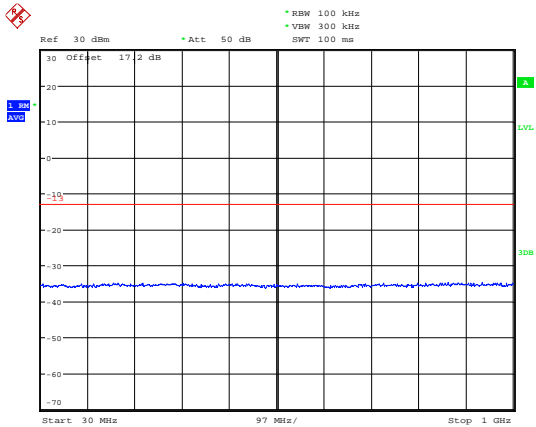

Date: 19.AUG.2019 16:24:38

LTE Band 2 10MHz CH-High 30MHz~1GHz

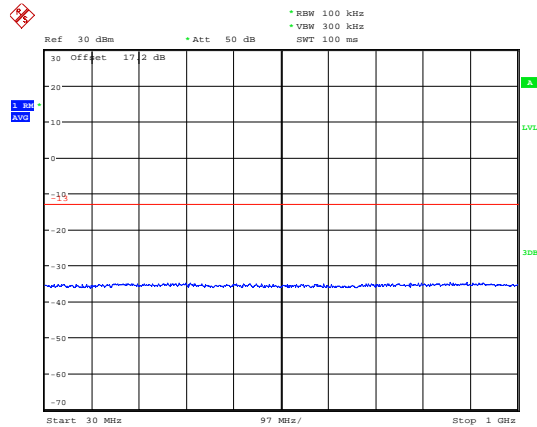

Date: 19.AUG.2019 16:25:34

LTE Band 2 10MHz CH-Middle 1GHz~3GHz

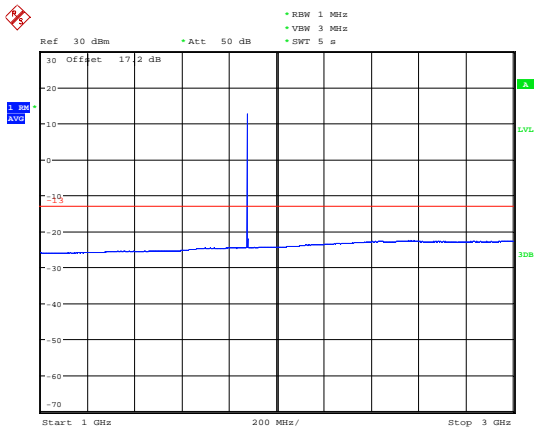

Date: 21.AUG.2019 16:56:52

LTE Band 2 10MHz CH-High 1GHz~3GHz

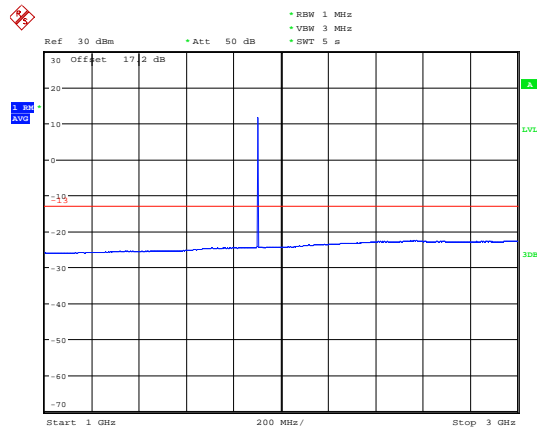

Date: 21.AUG.2019 16:58:22

LTE Band 2 10MHz CH-Middle 3GHz~20GHz

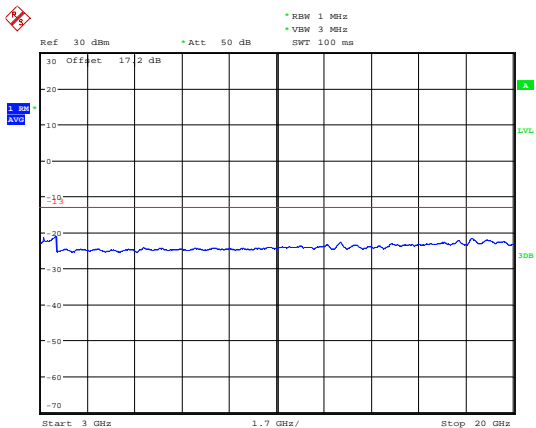

Date: 19.AUG.2019 16:50:49

LTE Band 2 10MHz CH-High 3GHz~20GHz

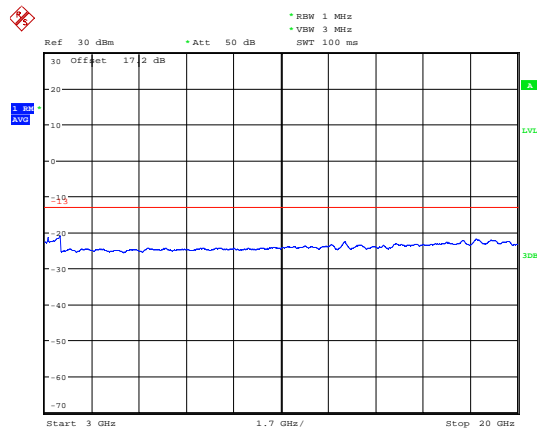

Date: 19.AUG.2019 16:52:43



LTE Band 2 15MHz CH-Low 30MHz~1GHz

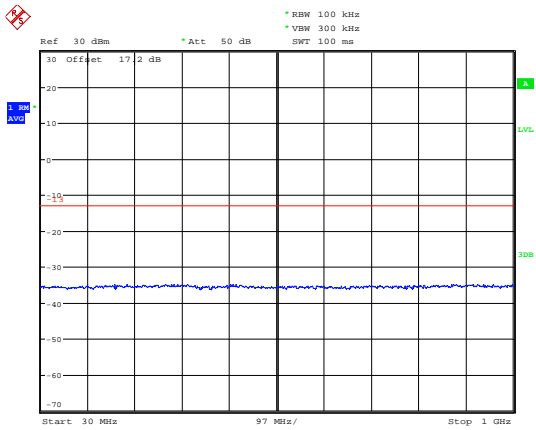

Date: 19.AUG.2019 16:18:44

LTE Band 2 15MHz CH-Middle 30MHz~1GHz

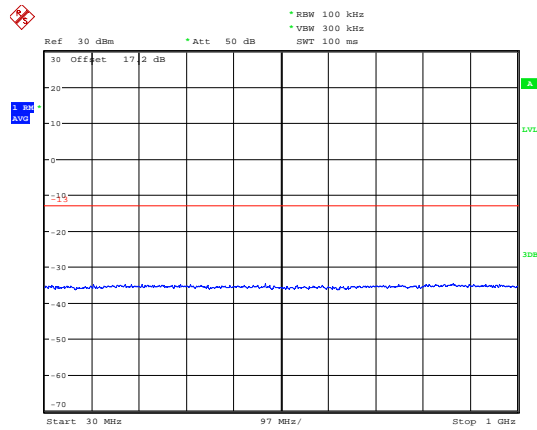

Date: 19.AUG.2019 16:27:13

LTE Band 2 15MHz CH-Low 1GHz~3GHz

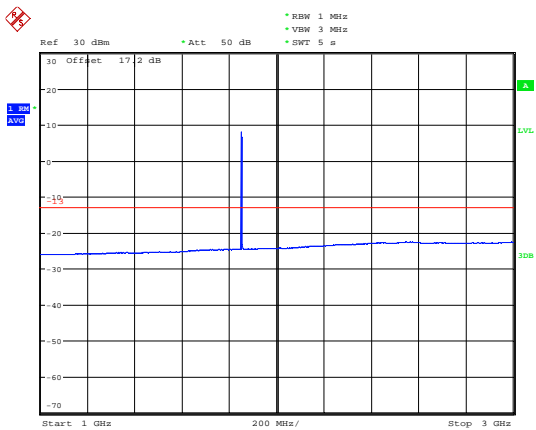

Date: 21.AUG.2019 17:08:15

LTE Band 2 15MHz CH-Middle 1GHz~3GHz

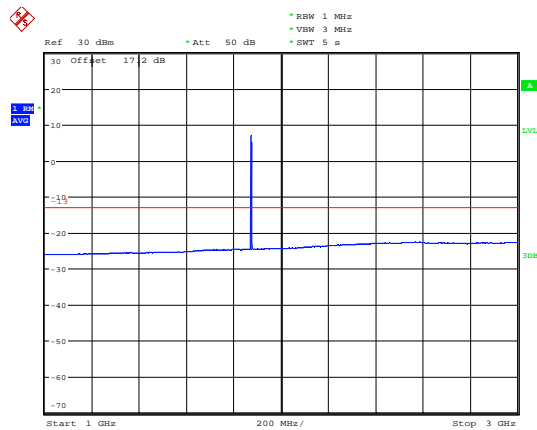

Date: 21.AUG.2019 17:06:35

LTE Band 2 15MHz CH-Low 3GHz~20GHz

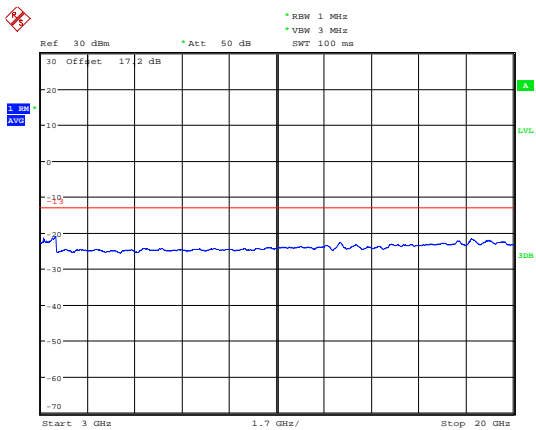

Date: 19.AUG.2019 16:53:27

LTE Band 2 15MHz CH-Middle 3GHz~20GHz

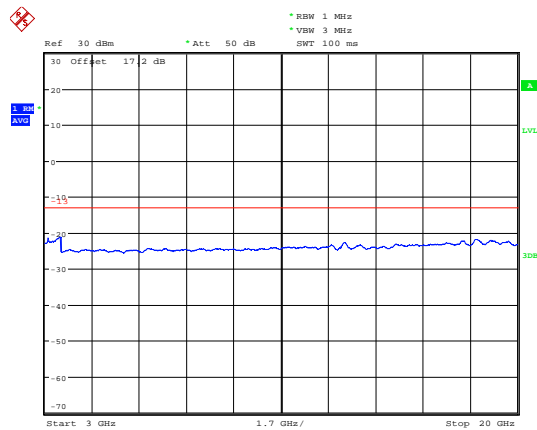

Date: 19.AUG.2019 16:53:59



LTE Band 2 15MHz CH-High 30MHz~1GHz

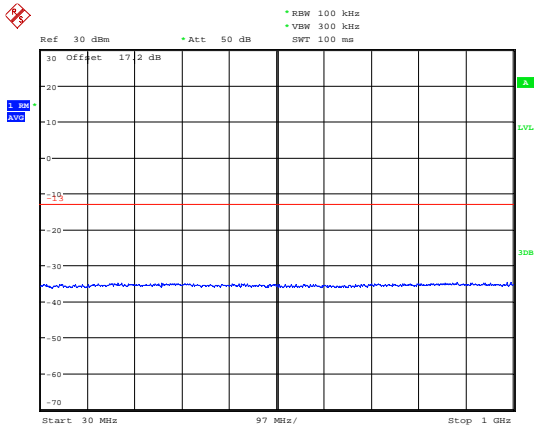

Date: 19.AUG.2019 16:30:50

LTE Band 2 20MHz CH-Low 30MHz~1GHz

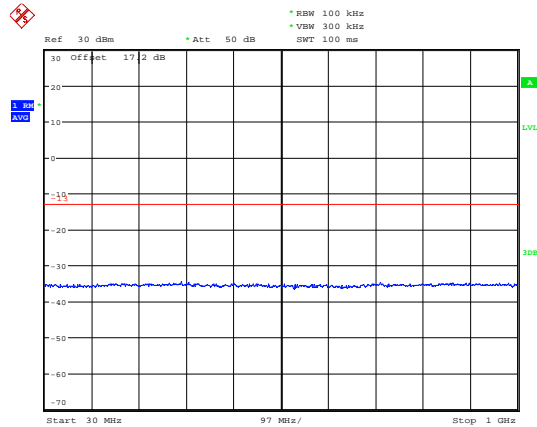

Date: 19.AUG.2019 16:31:39

LTE Band 2 15MHz CH-High 1GHz~3GHz

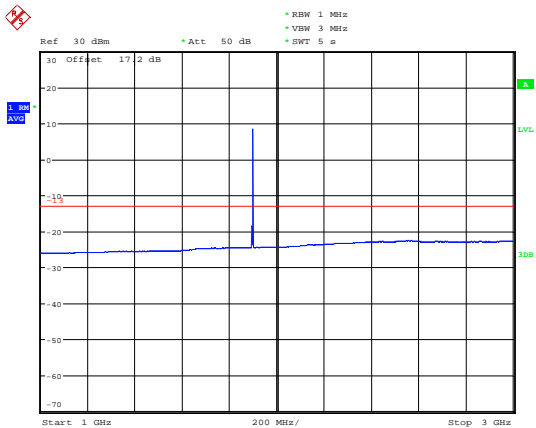

Date: 21.AUG.2019 17:04:42

LTE Band 2 20MHz CH-Low 1GHz~3GHz

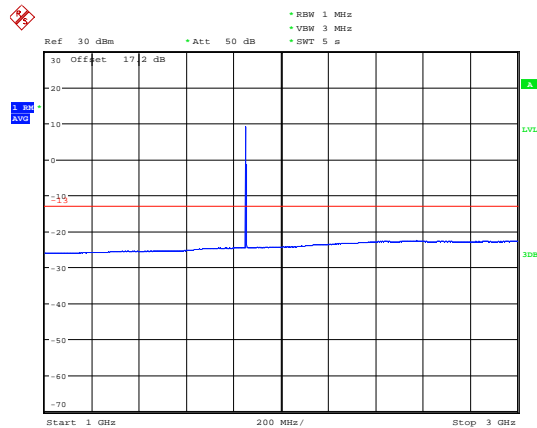

Date: 21.AUG.2019 17:09:44

LTE Band 2 15MHz CH-High 3GHz~20GHz

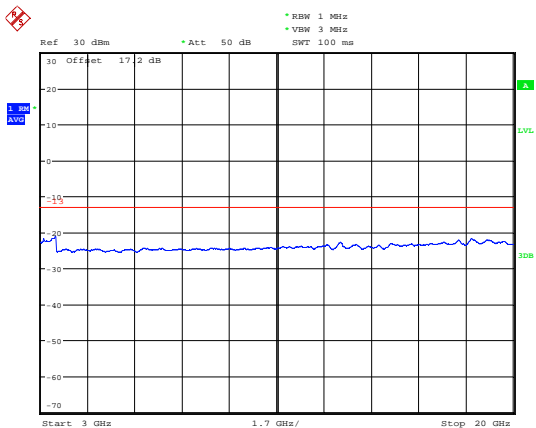

Date: 19.AUG.2019 16:56:26

LTE Band 2 20MHz CH-Low 3GHz~20GHz

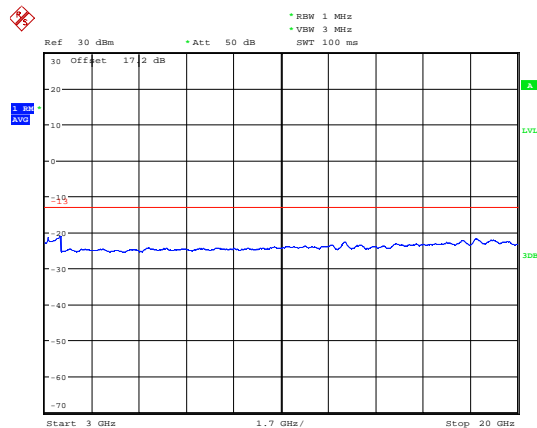

Date: 19.AUG.2019 16:57:45



LTE Band 2 20MHz CH-Middle 30MHz~1GHz

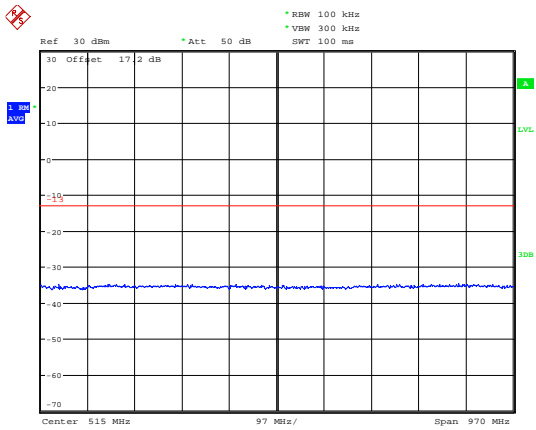

Date: 19.AUG.2019 16:16:43

LTE Band 2 20MHz CH-High 30MHz~1GHz

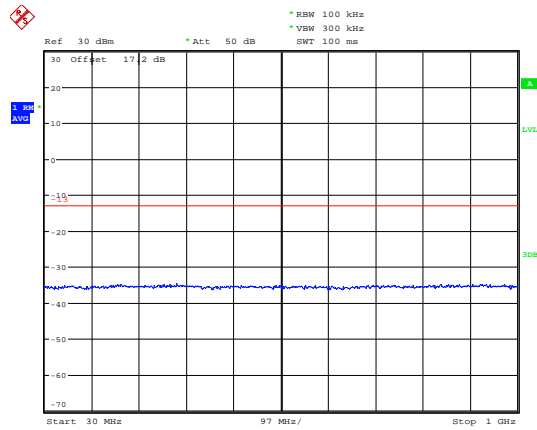

Date: 19.AUG.2019 16:31:56

LTE Band 2 20MHz CH-Middle 1GHz~3GHz

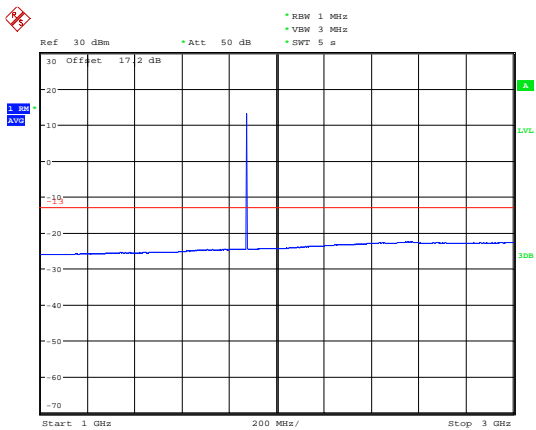

Date: 21.AUG.2019 17:11:31

LTE Band 2 20MHz CH-High 1GHz~3GHz

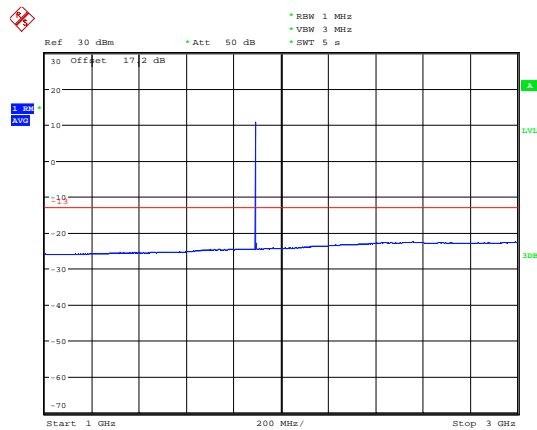

Date: 21.AUG.2019 17:13:48

LTE Band 2 20MHz CH-Middle 3GHz~20GHz

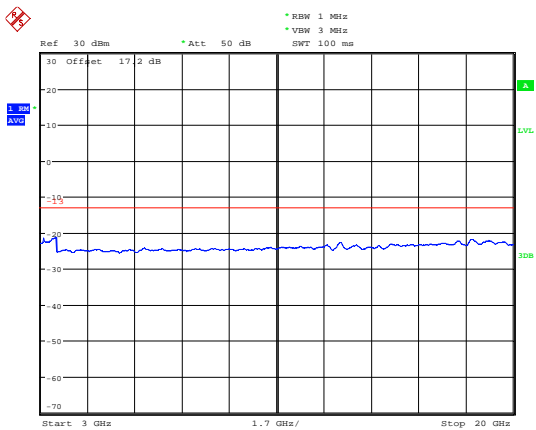

Date: 19.AUG.2019 16:58:02

LTE Band 2 20MHz CH-High 3GHz~20GHz

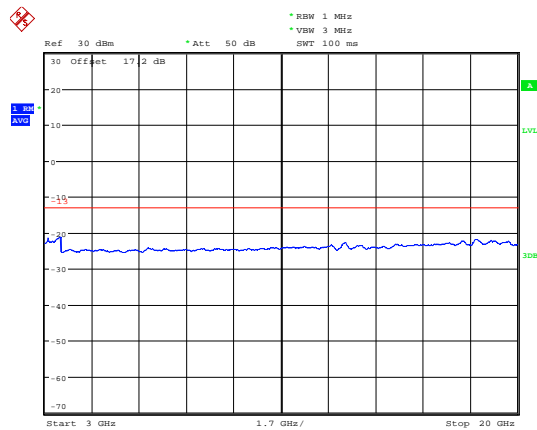

Date: 19.AUG.2019 16:58:46



LTE Band 25 1.4MHz CH-Low 30MHz~1GHz

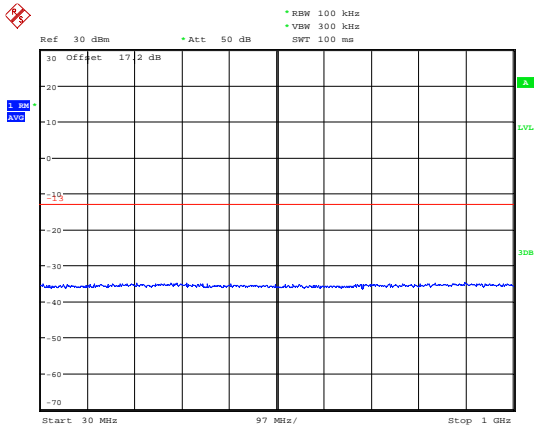

Date: 26.AUG.2019 10:53:54

LTE Band 25 1.4MHz CH-Middle 30MHz~1GHz

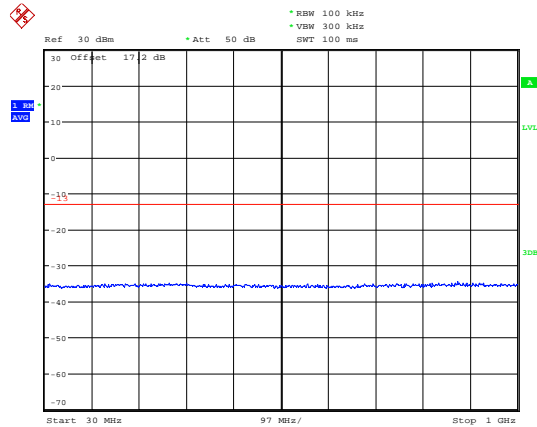

Date: 26.AUG.2019 10:54:17

LTE Band 25 1.4MHz CH-Low 1GHz~3GHz

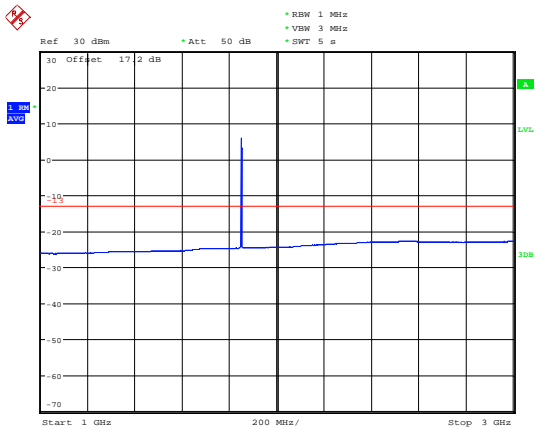

Date: 26.AUG.2019 11:05:00

LTE Band 25 1.4MHz CH-Middle 1GHz~3GHz

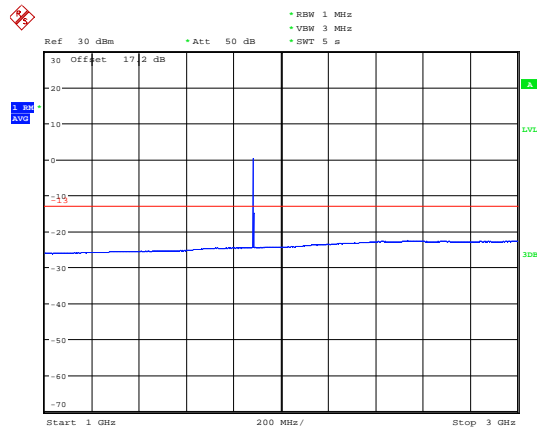

Date: 21.AUG.2019 17:56:23

LTE Band 25 1.4MHz CH-Low 3GHz~20GHz

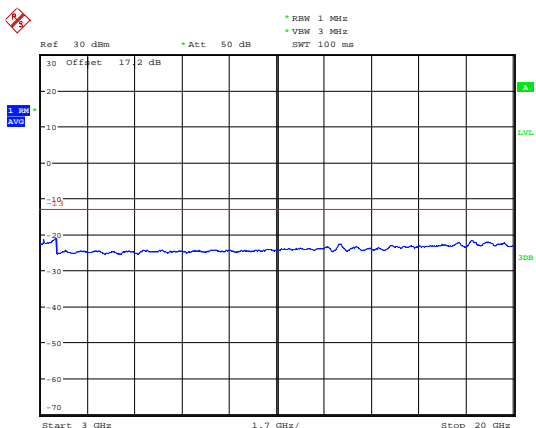

Date: 19.AUG.2019 20:50:21

LTE Band 25 1.4MHz CH-Middle 3GHz~20GHz

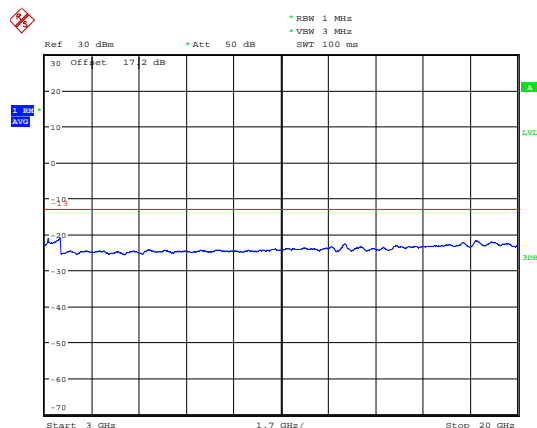

Date: 19.AUG.2019 20:50:32

LTE Band 25 1.4MHz CH-High 30MHz~1GHz

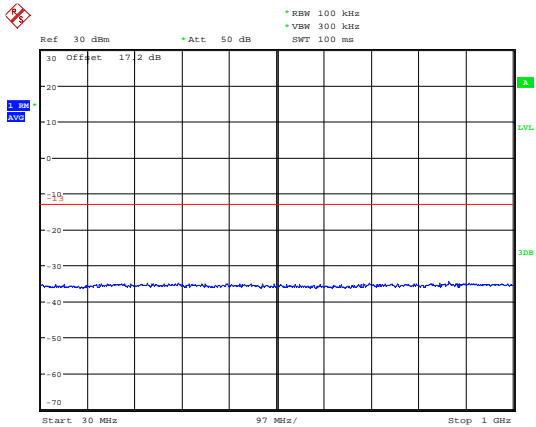

Date: 26.AUG.2019 10:54:46

LTE Band 25 3MHz CH-Low 30MHz~1GHz

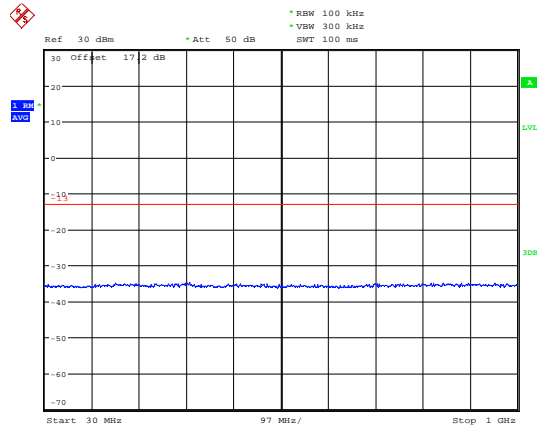

Date: 26.AUG.2019 10:55:23

LTE Band 25 1.4MHz CH-High 1GHz~3GHz

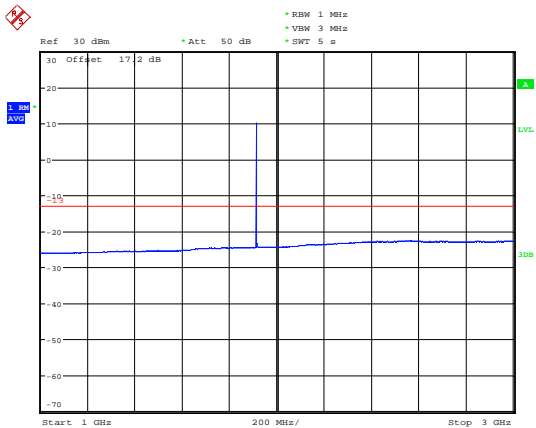

Date: 21.AUG.2019 17:57:57

LTE Band 25 3MHz CH-Low 1GHz~3GHz

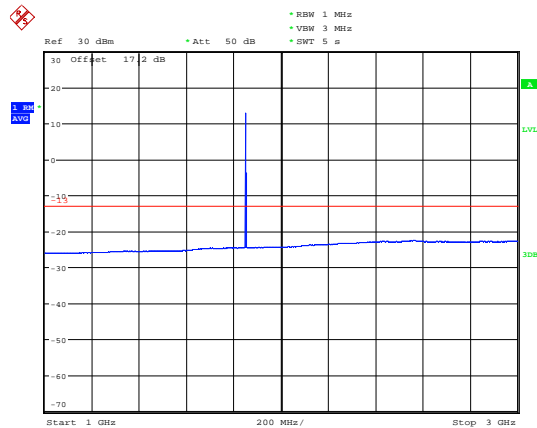

Date: 21.AUG.2019 18:00:04

LTE Band 25 1.4MHz CH-High 3GHz~20GHz

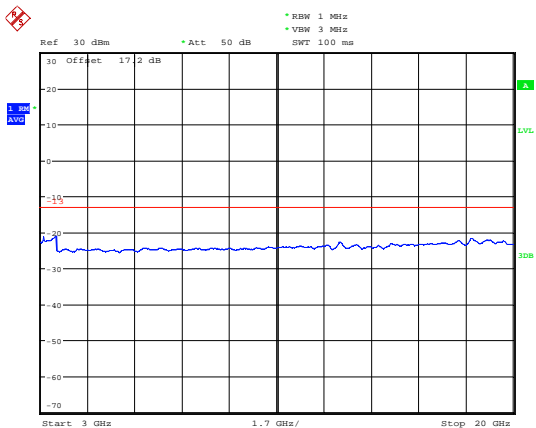

Date: 19.AUG.2019 20:51:00

LTE Band 25 3MHz CH-Low 3GHz~20GHz

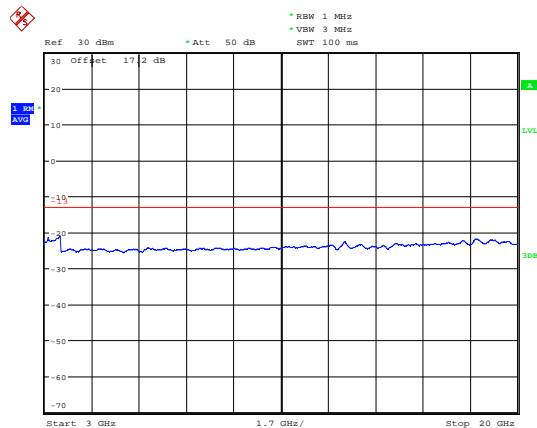

Date: 19.AUG.2019 20:51:13



LTE Band 25 3MHz CH-Middle 30MHz~1GHz

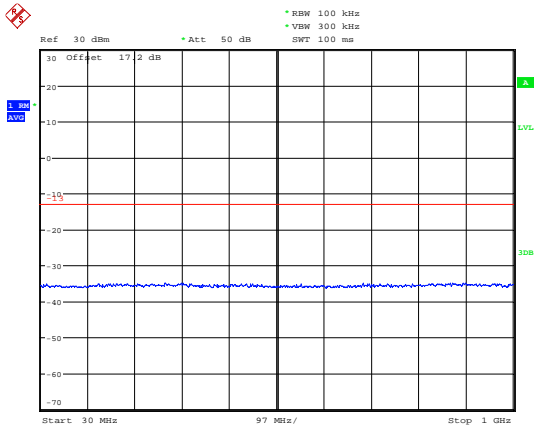

Date: 26.AUG.2019 10:55:48

LTE Band 25 3MHz CH-High 30MHz~1GHz

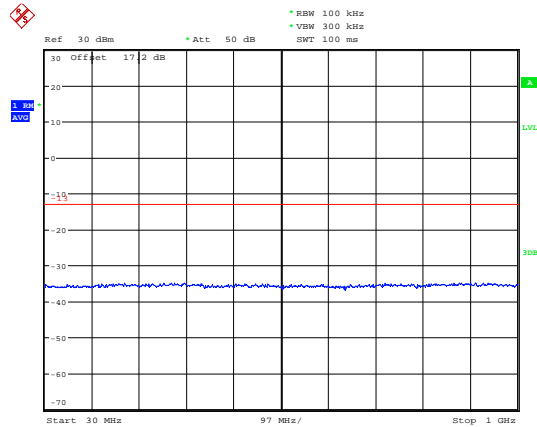

Date: 26.AUG.2019 10:56:57

LTE Band 25 3MHz CH-Middle 1GHz~3GHz

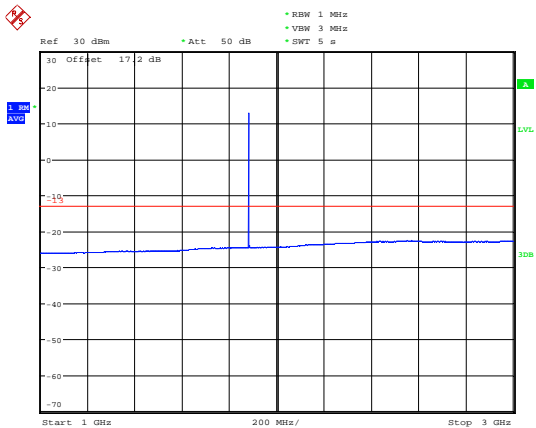

Date: 21.AUG.2019 18:01:50

LTE Band 25 3MHz CH-High 1GHz~3GHz

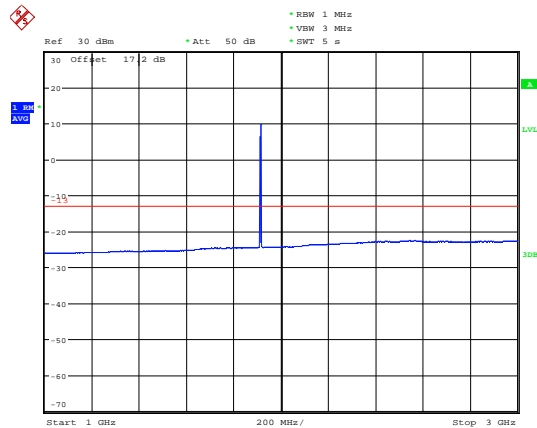

Date: 21.AUG.2019 18:03:11

LTE Band 25 3MHz CH-Middle 3GHz~20GHz

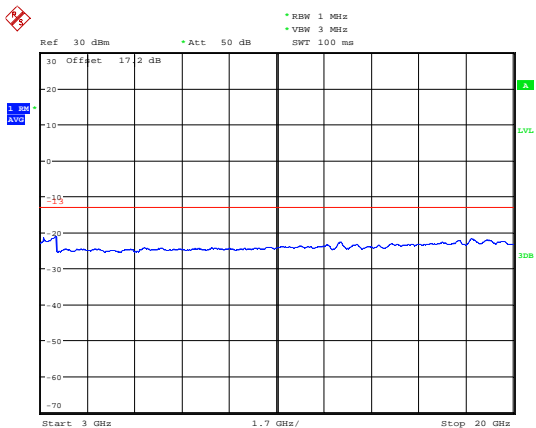

Date: 19.AUG.2019 20:51:28

LTE Band 25 3MHz CH-High 3GHz~20GHz

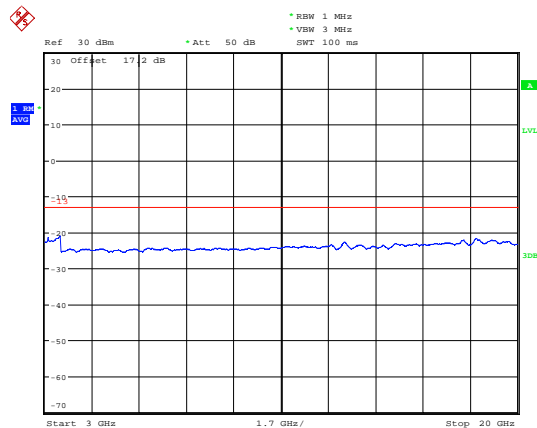

Date: 19.AUG.2019 20:51:40



LTE Band 25 5MHz CH-Low 30MHz~1GHz

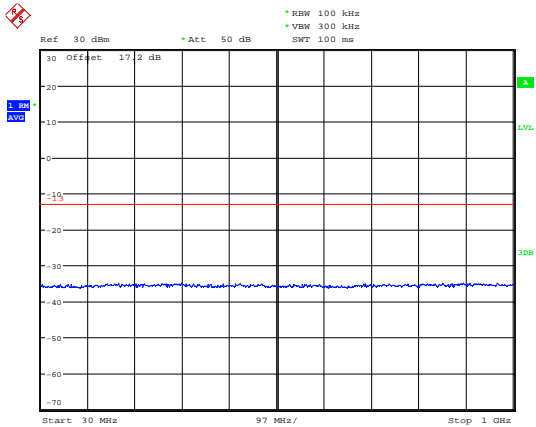

Date: 26.AUG.2019 10:57:20

LTE Band 25 5MHz CH-Middle 30MHz~1GHz

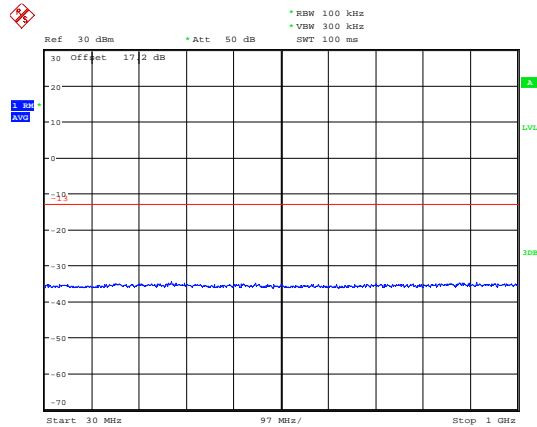

Date: 26.AUG.2019 10:57:46

LTE Band 25 5MHz CH-Low 1GHz~3GHz

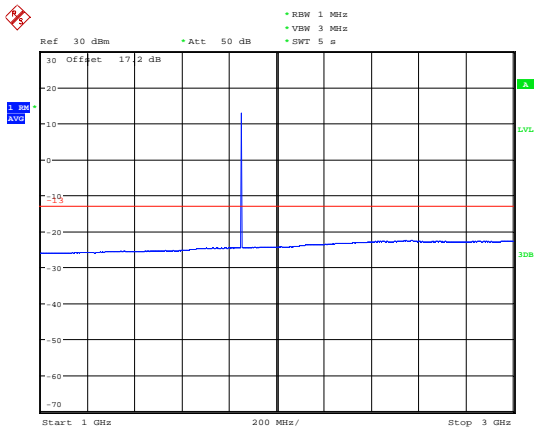

Date: 21.AUG.2019 18:04:14

LTE Band 25 5MHz CH-Middle 1GHz~3GHz

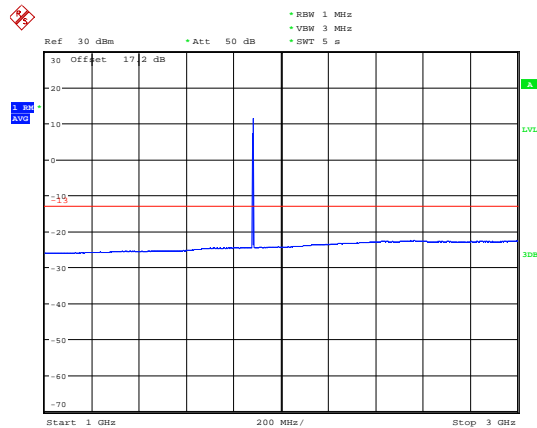

Date: 21.AUG.2019 18:05:32

LTE Band 25 5MHz CH-Low 3GHz~20GHz

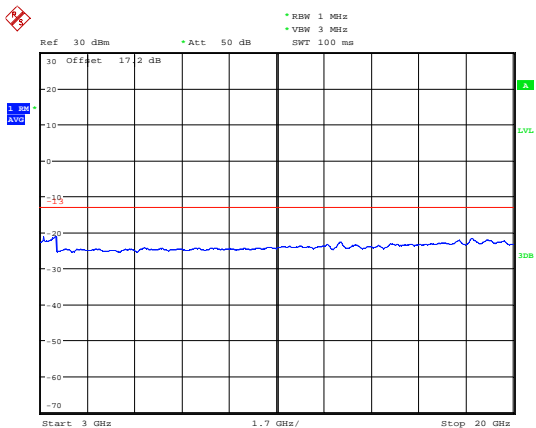

Date: 19.AUG.2019 20:51:49

LTE Band 25 5MHz CH-Middle 3GHz~20GHz

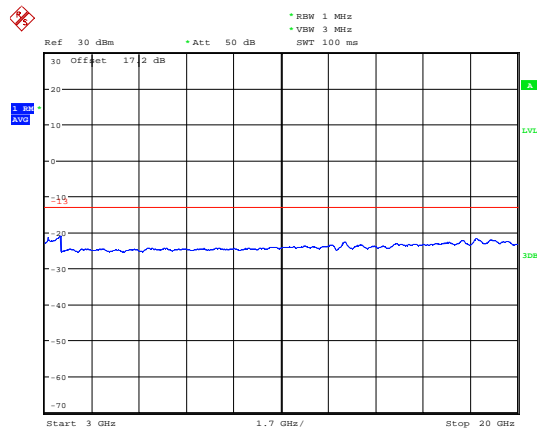

Date: 19.AUG.2019 20:52:03



LTE Band 25 5MHz CH-High 30MHz~1GHz

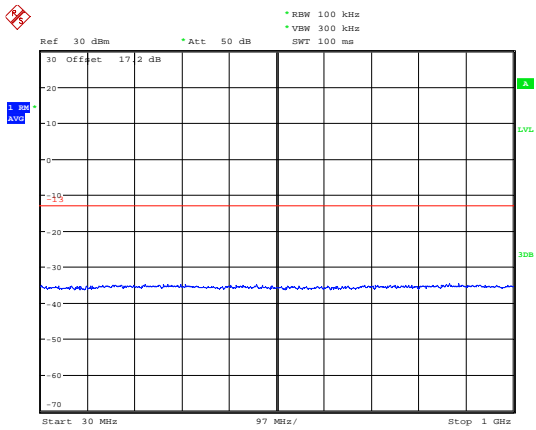

Date: 26.AUG.2019 10:58:06

LTE Band 25 10MHz CH-Low 30MHz~1GHz

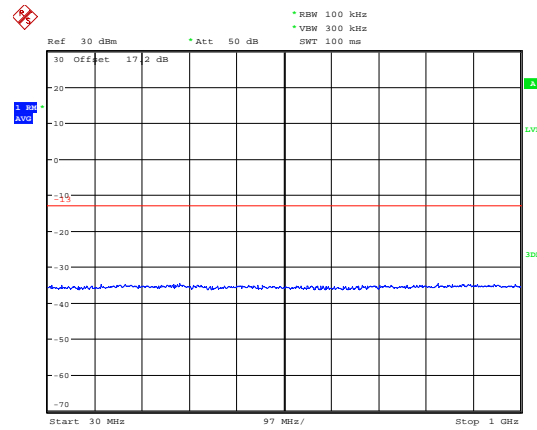

Date: 26.AUG.2019 10:58:38

LTE Band 25 5MHz CH-High 1GHz~3GHz

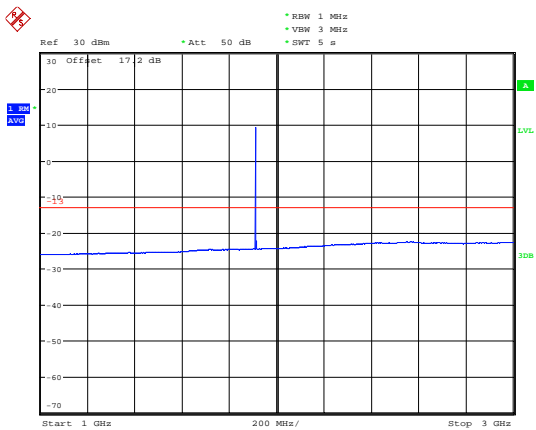

Date: 21.AUG.2019 18:07:07

LTE Band 25 10MHz CH-Low 1GHz~3GHz

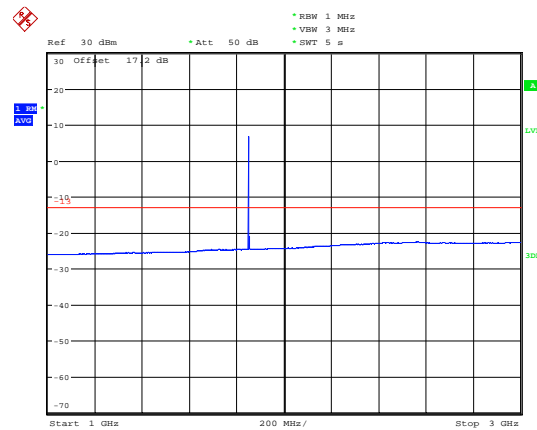

Date: 21.AUG.2019 18:07:56

LTE Band 25 5MHz CH-High 3GHz~20GHz

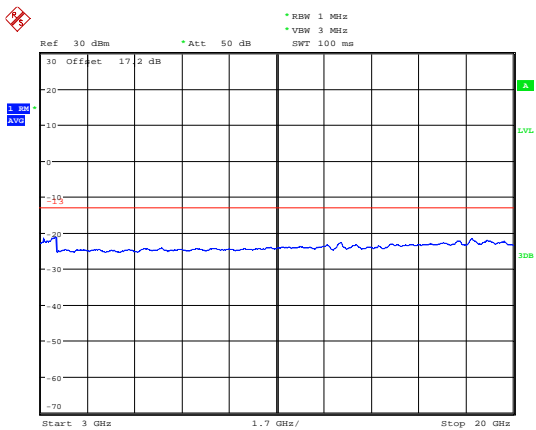

Date: 19.AUG.2019 20:52:14

LTE Band 25 10MHz CH-Low 3GHz~20GHz

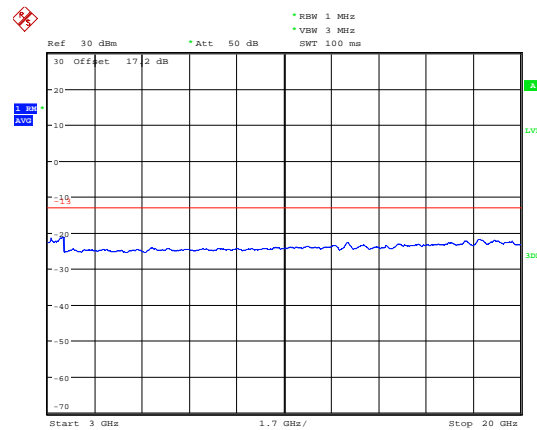

Date: 19.AUG.2019 20:52:39



LTE Band 25 10MHz CH-Middle 30MHz~1GHz

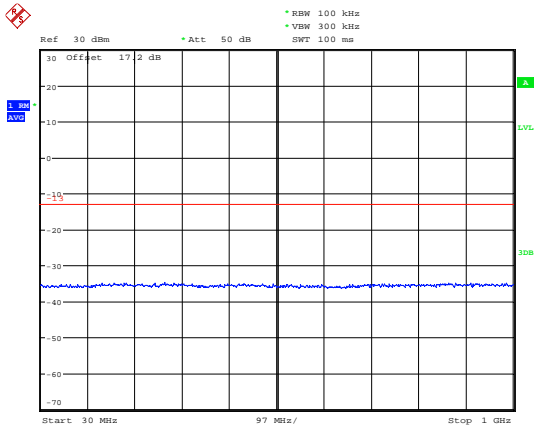

Date: 26.AUG.2019 10:59:07

LTE Band 25 10MHz CH-High 30MHz~1GHz

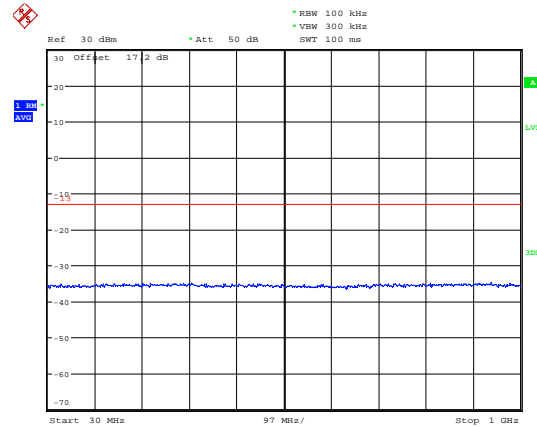

Date: 26.AUG.2019 10:59:58

LTE Band 25 10MHz CH-Middle 1GHz~3GHz

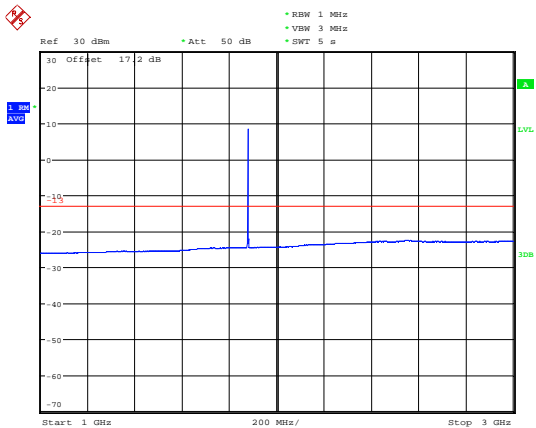

Date: 21.AUG.2019 18:09:30

LTE Band 25 10MHz CH-High 1GHz~3GHz

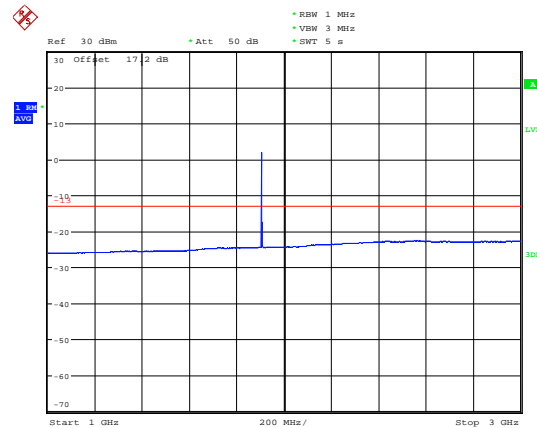

Date: 21.AUG.2019 18:10:29

LTE Band 25 10MHz CH-Middle 3GHz~20GHz

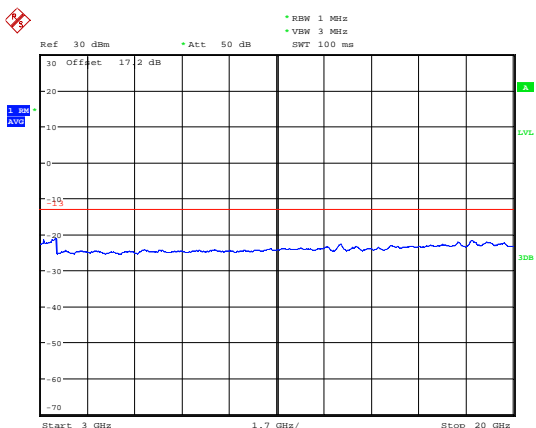

Date: 19.AUG.2019 20:53:17

LTE Band 25 10MHz CH-High 3GHz~20GHz

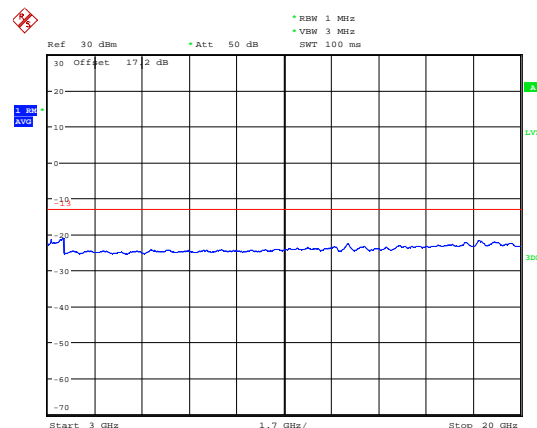

Date: 19.AUG.2019 20:53:52



LTE Band 25 15MHz CH-Low 30MHz~1GHz

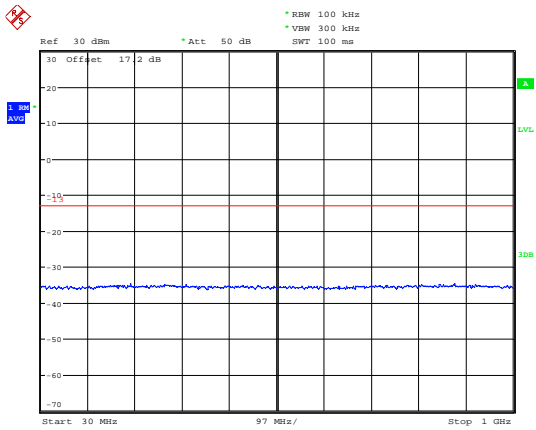

Date: 26.AUG.2019 11:00:37

LTE Band 25 15MHz CH-Middle 30MHz~1GHz

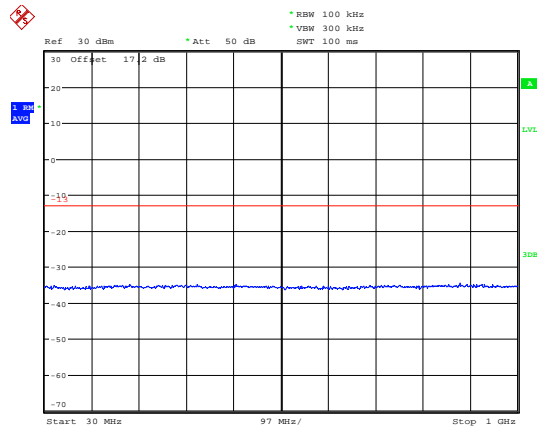

Date: 26.AUG.2019 11:00:57

LTE Band 25 15MHz CH-Low 1GHz~3GHz

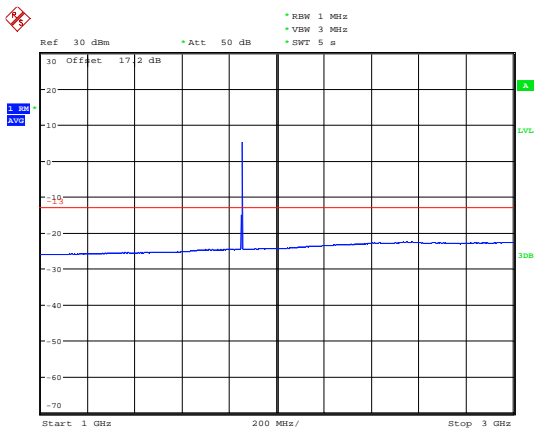

Date: 21.AUG.2019 18:11:33

LTE Band 25 15MHz CH-Middle 1GHz~3GHz

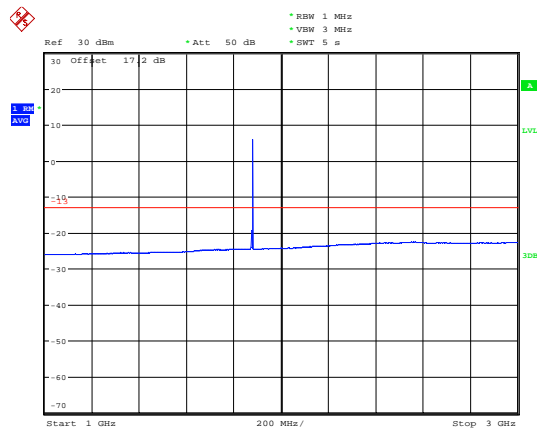

Date: 21.AUG.2019 18:12:17

LTE Band 25 15MHz CH-Low 3GHz~20GHz

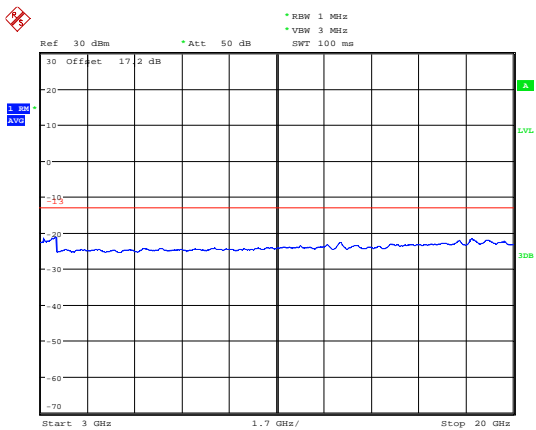

Date: 19.AUG.2019 20:54:42

LTE Band 25 15MHz CH-Middle 3GHz~20GHz

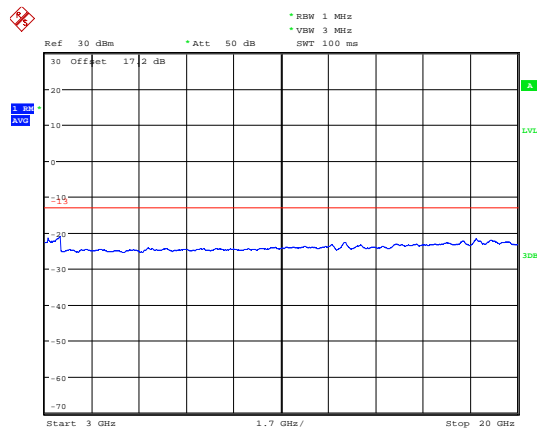

Date: 19.AUG.2019 20:55:02



LTE Band 25 15MHz CH-High 30MHz~1GHz

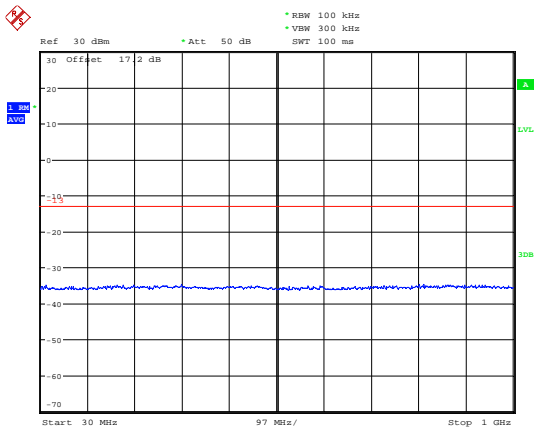

Date: 26.AUG.2019 11:01:20

LTE Band 25 20MHz CH-Low 30MHz~1GHz

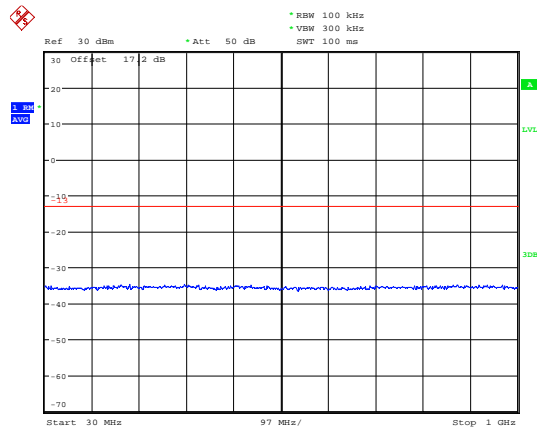

Date: 26.AUG.2019 11:01:50

LTE Band 25 15MHz CH-High 1GHz~3GHz

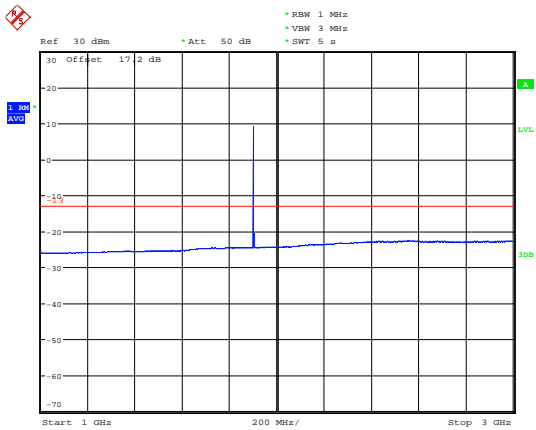

Date: 21.AUG.2019 18:13:24

LTE Band 25 20MHz CH-Low 1GHz~3GHz

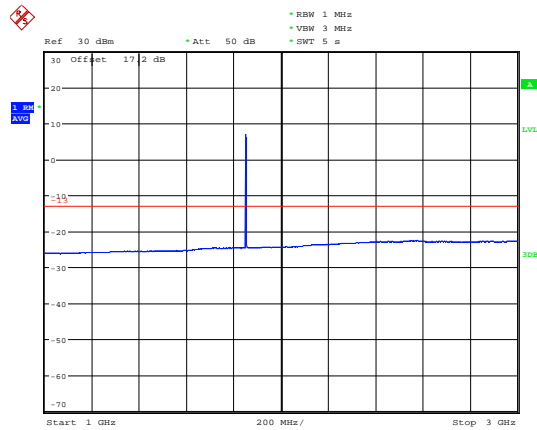

Date: 21.AUG.2019 18:16:49

LTE Band 25 15MHz CH-High 3GHz~20GHz

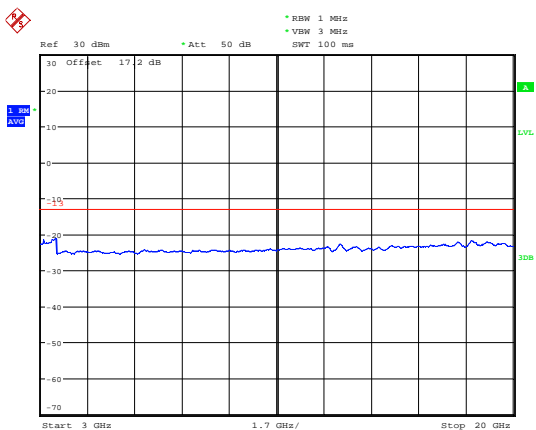

Date: 19.AUG.2019 20:55:29

LTE Band 25 20MHz CH-Low 3GHz~20GHz

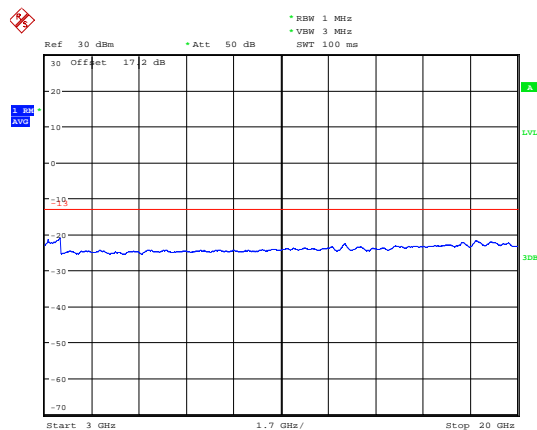

Date: 19.AUG.2019 20:55:54



LTE Band 25 20MHz CH-Middle 30MHz~1GHz

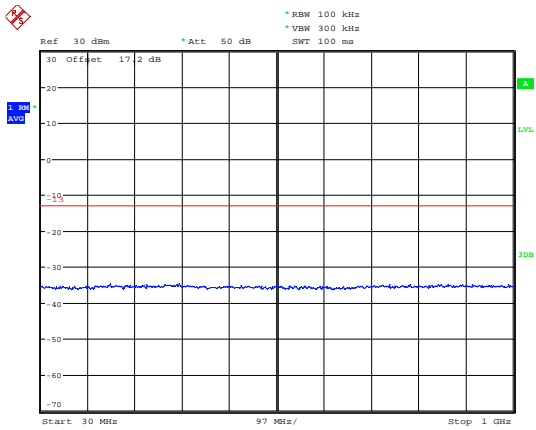

Date: 26.AUG.2019 11:02:27

LTE Band 25 20MHz CH-High 30MHz~1GHz

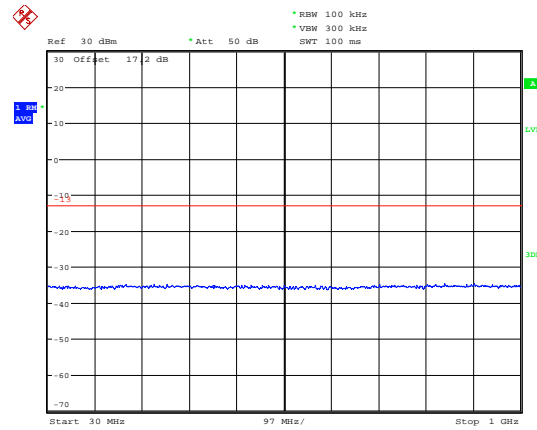

Date: 26.AUG.2019 11:02:56

LTE Band 25 20MHz CH-Middle 1GHz~3GHz

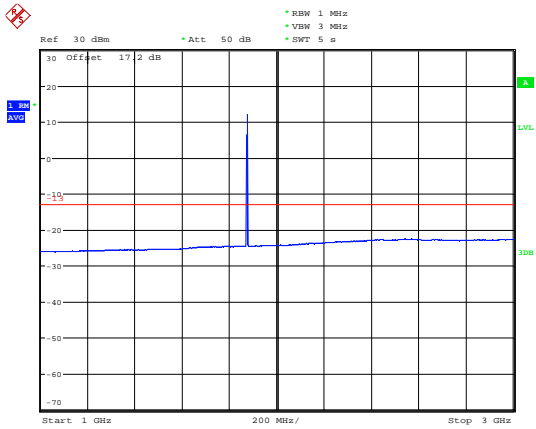

Date: 21.AUG.2019 18:17:43

LTE Band 25 20MHz CH-High 1GHz~3GHz

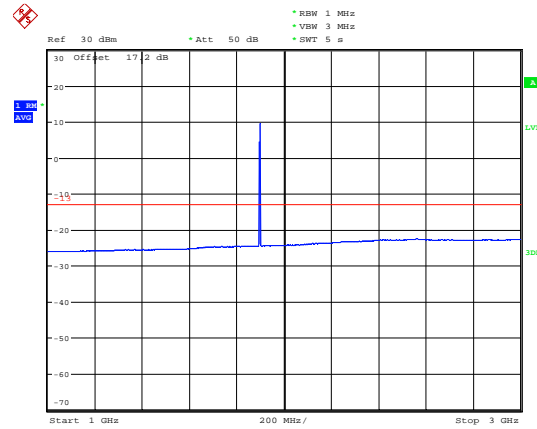

Date: 21.AUG.2019 18:18:35

LTE Band 25 20MHz CH-Middle 3GHz~20GHz

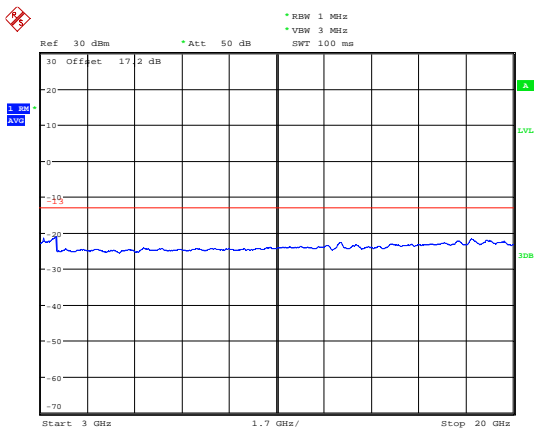

Date: 19.AUG.2019 20:56:08

LTE Band 25 20MHz CH-High 3GHz~20GHz

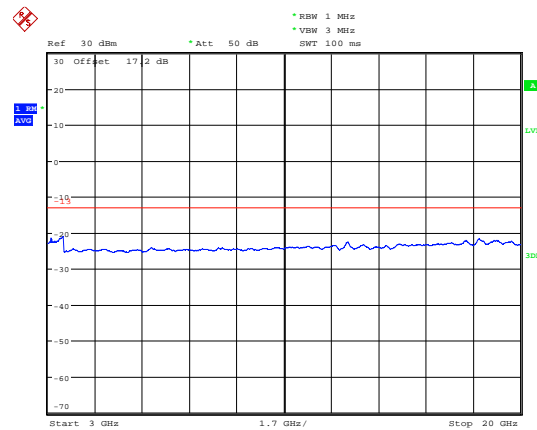

Date: 19.AUG.2019 20:56:22

5.8. Radiates Spurious Emission

Ambient condition

Temperature	Relative humidity	Pressure
23°C ~25°C	45%~50%	101.5kPa

Method of Measurement

1. The testing follows FCC KDB 971168 v03r01 Section 5.8 and ANSI C63.26 (2015).
2. Below 1GHz: The EUT is placed on a turntable 0.8 meters above the ground in the chamber, 3 meter away from the antenna. The maximal emission value is acquired by adjusting the antenna height, polarisation and turntable azimuth. Normally, the height range of antenna is 1 m to 4 m, the azimuth range of turntable is 0° to 360°, and the receive antenna has two polarizations Vertical (V) and Horizontal (H). Above 1GHz: (Note: the FCC's permission to use 1.5m as an alternative per TCBC Conf call of Dec. 2, 2014.) The EUT is placed on a turntable 1.5 meters above the ground in the chamber, 3 meter away from the antenna. The maximal emission value is acquired by adjusting the antenna height, polarisation and turntable azimuth. Normally, the height range of antenna is 1 m to 4 m, the azimuth range of turntable is 0° to 360°, and the receive antenna has two polarizations Vertical (V) and Horizontal (H).
3. A loop antenna, A log-periodic antenna or horn antenna shall be substituted in place of the EUT. The log-periodic antenna will be driven by a signal generator and the level will be adjusted till the same power value on the spectrum analyzer or receiver. The level of the spurious emissions can be calculated through the level of the signal generator, cable loss, the gain of the substitution antenna and the reading of the spectrum analyzer or receiver.
4. The EUT is then put into continuously transmitting mode at its maximum power level during the test. Set Test Receiver or Spectrum RBW=200Hz,VBW=600Hz for 9kHz150kHz , RBW=10kHz, VBW=30kHz 150kHz-30MHz , RBW=100kHz,VBW=300kHz for 30MHz to 1GHz and RBW=1MHz, VBW=3MHz for above 1GHz, And the maximum value of the receiver should be recorded as (Pr).
5. The EUT shall be replaced by a substitution antenna. In the chamber, an substitution antenna for the frequency band of interest is placed at the reference point of the chamber. An RF Signal source for the frequency band of interest is connected to the substitution antenna with a cable that has been constructed to not interfere with the radiation pattern of the antenna. A power (PMea) is applied to the input of the substitution antenna, and adjust the level of the signal generator output until the value of the receiver reach the previously recorded (Pr). The power of signal source (PMea) is recorded. The test should be performed by rotating the test item and adjusting the receiving antenna polarization.
6. A amplifier should be connected to the Signal Source output port. And the cable should be connect between the Amplifier and the Substitution Antenna. The cable loss (Pcl) ,the Substitution Antenna Gain (Ga) and the Amplifier Gain (PAg) should be recorded after test.
7. The measurement results are obtained as described below:
$$\text{Power(EIRP)} = \text{PMea} - \text{PAg} - \text{Pcl} + \text{Ga}$$

The measurement results are amend as described below:
$$\text{Power(EIRP)} = \text{PMea} - \text{Pcl} + \text{Ga}$$
8. This value is EIRP since the measurement is calibrated using an antenna of known gain (2.15 dBi)

and known input power. ERP can be calculated from EIRP by subtracting the gain of the dipole, $ERP = EIRP - 2.15\text{dBi}$.

The modulation mode and RB allocation refer to section 5.1, using the maximum output power configuration.

Test setup

9KHz ~ 30MHz

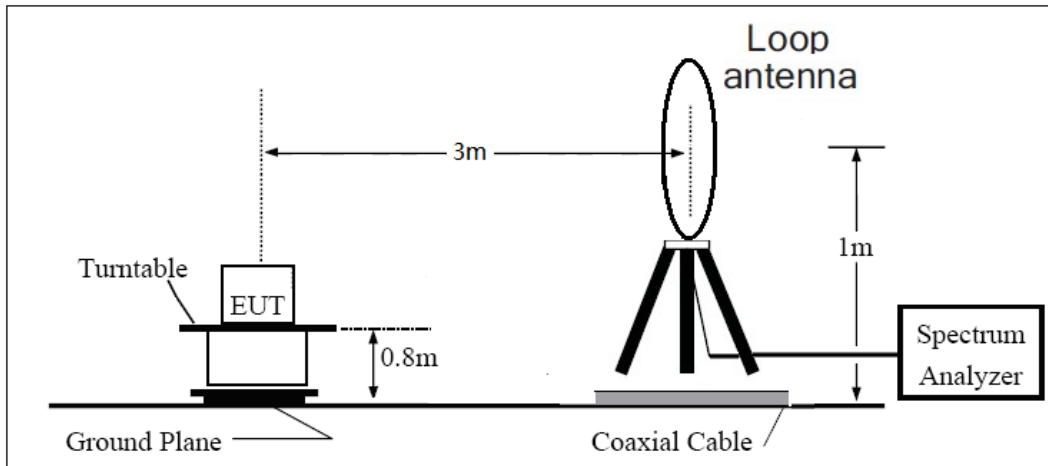

30MHz ~ 1GHz

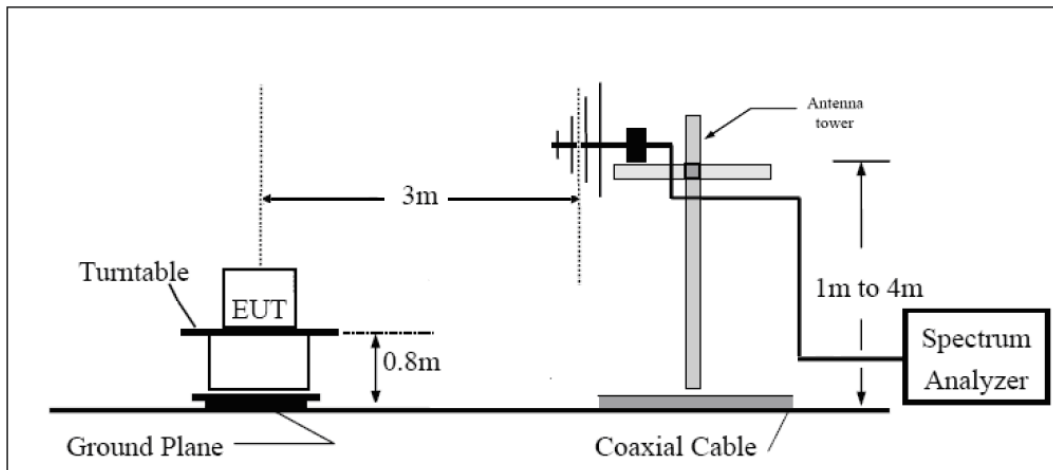

Above 1GHz

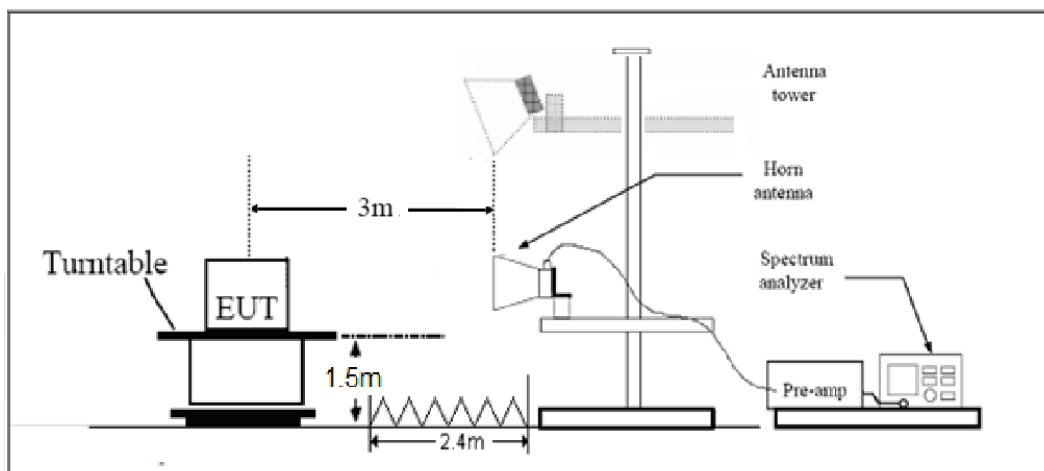



Note: Area side: 2.4mX3.6m

Limits

Rule Part 24.238(a) specifies that “on any frequency outside a licensee's frequency block, the power of any emission shall be attenuated below the transmitter power (P) by at least $43 + 10 \log_{10}(P)$ dB.”

Limit	-13 dBm
-------	---------

Measurement Uncertainty

The assessed measurement uncertainty to ensure 95% confidence level for the normal distribution is with the coverage factor $k = 1.96$, $U = 3.55$ dB.

**Test Result**

Sweep the whole frequency band through the range from 9kHz to the 10th harmonic of the carrier, the emissions below the noise floor will not be recorded in the report.

Original

LTE Band 2 1.4MHz CH-Middle

Harmonic	Frequency (MHz)	SG (dBm)	Cable Loss (dB)	Gain (dBi)	Antenna Polarization	EIRP Level (dBm)	Limit (dBm)	Margin (dB)	Azimuth (deg)
2	3759.0	-56.14	5.10	11.05	Horizontal	-50.19	-13.00	37.19	45
3	5638.9	-55.93	5.42	12.65	Horizontal	-48.70	-13.00	35.70	90
4	7520.0	-54.16	6.70	13.85	Horizontal	-47.01	-13.00	34.01	180
5	9400.0	-52.46	7.01	14.75	Horizontal	-44.72	-13.00	31.72	135
6	11280.0	-50.77	7.48	15.95	Horizontal	-42.30	-13.00	29.30	225
7	13160.0	-50.74	7.51	16.55	Horizontal	-41.70	-13.00	28.70	180
8	15040.0	-49.28	8.24	15.35	Horizontal	-42.17	-13.00	29.17	315
9	16920.0	-45.63	8.41	14.95	Horizontal	-39.09	-13.00	26.09	90
10	18800.0	-	-	-	-	-	-	-	-

Note: 1.The other Spurious RF Radiated emissions level is no more than noise floor.
2. The worst emission was found in the antenna is Horizontal position.

LTE Band 2 5MHz CH-Middle

Harmonic	Frequency (MHz)	SG (dBm)	Cable Loss (dB)	Gain (dBi)	Antenna Polarization	EIRP Level (dBm)	Limit (dBm)	Margin (dB)	Azimuth (deg)
2	3760.0	-57.27	5.10	11.05	Horizontal	-51.32	-13.00	38.32	45
3	5640.0	-55.43	5.42	12.65	Horizontal	-48.20	-13.00	35.20	90
4	7520.0	-54.15	6.70	13.85	Horizontal	-47.00	-13.00	34.00	135
5	9400.0	-51.24	7.01	14.75	Horizontal	-43.50	-13.00	30.50	225
6	11280.0	-50.47	7.48	15.95	Horizontal	-42.00	-13.00	29.00	90
7	13160.0	-50.64	7.51	16.55	Horizontal	-41.60	-13.00	28.60	315
8	15040.0	-48.61	8.24	15.35	Horizontal	-41.50	-13.00	28.50	225
9	16920.0	-46.44	8.41	14.95	Horizontal	-39.90	-13.00	26.90	315
10	18800.0	-	-	-	-	-	-	-	-

Note: 1.The other Spurious RF Radiated emissions level is no more than noise floor.
2. The worst emission was found in the antenna is Horizontal position.



LTE Band 2 20MHz CH-Middle

Harmonic	Frequency (MHz)	SG (dBm)	Cable Loss (dB)	Gain (dBi)	Antenna Polarization	EIRP Level (dBm)	Limit (dBm)	Margin (dB)	Azimuth (deg)
2	3760.0	-56.30	5.10	11.05	Horizontal	-50.35	-13.00	37.35	90
3	5640.0	-54.43	5.42	12.65	Horizontal	-47.20	-13.00	34.20	45
4	7520.0	-54.25	6.70	13.85	Horizontal	-47.10	-13.00	34.10	315
5	9400.0	-51.24	7.01	14.75	Horizontal	-43.50	-13.00	30.50	90
6	11280.0	-51.16	7.48	15.95	Horizontal	-42.69	-13.00	29.69	135
7	13160.0	-50.94	7.51	16.55	Horizontal	-41.90	-13.00	28.90	45
8	15040.0	-48.01	8.24	15.35	Horizontal	-40.90	-13.00	27.90	90
9	16920.0	-45.64	8.41	14.95	Horizontal	-39.10	-13.00	26.10	225
10	18800.0	-	-	-	-	-	-	-	-

Note: 1.The other Spurious RF Radiated emissions level is no more than noise floor.

2. The worst emission was found in the antenna is Horizontal position.

LTE Band 25 1.4MHz CH-Middle

Harmonic	Frequency (MHz)	SG (dBm)	Cable Loss (dB)	Gain (dBi)	Antenna Polarization	EIRP Level (dBm)	Limit (dBm)	Margin (dB)	Azimuth (deg)
2	3759.0	-56.61	5.10	11.05	Horizontal	-50.66	-13.00	37.66	0
3	5638.9	-56.59	5.42	12.65	Horizontal	-49.36	-13.00	36.36	135
4	7520.0	-54.33	6.70	13.85	Horizontal	-47.18	-13.00	34.18	45
5	9400.0	-52.82	7.01	14.75	Horizontal	-45.08	-13.00	32.08	0
6	11280.0	-50.74	7.48	15.95	Horizontal	-42.27	-13.00	29.27	180
7	13160.0	-50.79	7.51	16.55	Horizontal	-41.75	-13.00	28.75	135
8	15040.0	-48.43	8.24	15.35	Horizontal	-41.32	-13.00	28.32	45
9	16920.0	-45.90	8.41	14.95	Horizontal	-39.36	-13.00	26.36	270
10	18800.0	-	-	-	-	-	-	-	-

Note: 1.The other Spurious RF Radiated emissions level is no more than noise floor.

2. The worst emission was found in the antenna is Horizontal position.

LTE Band 25 5MHz CH-Middle

Harmonic	Frequency (MHz)	SG (dBm)	Cable Loss (dB)	Gain (dBi)	Antenna Polarization	EIRP Level (dBm)	Limit (dBm)	Margin (dB)	Azimuth (deg)
2	3760.0	-57.59	5.10	11.05	Horizontal	-51.64	-13.00	34.02	90
3	5640.0	-56.73	5.42	12.65	Horizontal	-49.50	-13.00	32.05	45
4	7520.0	-54.17	6.70	13.85	Horizontal	-47.02	-13.00	29.35	0
5	9400.0	-52.79	7.01	14.75	Horizontal	-45.05	-13.00	28.25	180
6	11280.0	-50.82	7.48	15.95	Horizontal	-42.35	-13.00	28.52	90
7	13160.0	-50.29	7.51	16.55	Horizontal	-41.25	-13.00	26.51	270
8	15040.0	-48.63	8.24	15.35	Horizontal	-41.52	-13.00	28.52	45
9	16920.0	-46.05	8.41	14.95	Horizontal	-39.51	-13.00	26.51	90
10	18800.0	-	-	-	-	-	-	-	-

Note: 1.The other Spurious RF Radiated emissions level is no more than noise floor.
2. The worst emission was found in the antenna is Horizontal position.

LTE Band 25 20MHz CH-Middle

Harmonic	Frequency (MHz)	SG (dBm)	Cable Loss (dB)	Gain (dBi)	Antenna Polarization	EIRP Level (dBm)	Limit (dBm)	Margin (dB)	Azimuth (deg)
2	3760.0	-57.59	5.10	11.05	Horizontal	-51.64	-13.00	34.35	270
3	5640.0	-56.54	5.42	12.65	Horizontal	-49.31	-13.00	32.33	135
4	7520.0	-54.50	6.70	13.85	Horizontal	-47.35	-13.00	29.32	315
5	9400.0	-53.07	7.01	14.75	Horizontal	-45.33	-13.00	28.00	0
6	11280.0	-50.79	7.48	15.95	Horizontal	-42.32	-13.00	28.25	90
7	13160.0	-50.04	7.51	16.55	Horizontal	-41.00	-13.00	26.00	45
8	15040.0	-48.36	8.24	15.35	Horizontal	-41.25	-13.00	28.25	180
9	16920.0	-45.54	8.41	14.95	Horizontal	-39.00	-13.00	26.00	90
10	18800.0	-	-	-	-	-	-	-	-

Note: 1.The other Spurious RF Radiated emissions level is no more than noise floor.
2. The worst emission was found in the antenna is Horizontal position.

**Variant**

LTE Band 2 1.4MHz CH-Middle

Harmonic	Frequency (MHz)	SG (dBm)	Cable Loss (dB)	Gain (dBi)	Antenna Polarization	EIRP Level (dBm)	Limit (dBm)	Margin (dB)	Azimuth (deg)
2	3759.0	-57.85	5.10	11.05	Horizontal	-51.94	-13.00	38.94	45
3	5638.9	-58.43	5.42	12.65	Horizontal	-51.20	-13.00	38.20	135
4	7520.0	-56.05	6.70	13.85	Horizontal	-48.87	-13.00	35.87	225
5	9400.0	-54.24	7.01	14.75	Horizontal	-46.48	-13.00	33.48	270
6	11280.0	-52.67	7.48	15.95	Horizontal	-44.16	-13.00	31.16	315
7	13160.0	-53.54	7.51	16.55	Horizontal	-44.52	-13.00	31.52	0
8	15040.0	-49.31	8.24	15.35	Horizontal	-42.22	-13.00	29.22	90
9	16920.0	-44.24	8.41	14.95	Horizontal	-37.72	-13.00	24.72	180
10	18800.0	-	-	-	-	-	-	-	-

Note: 1. The other Spurious RF Radiated emissions level is no more than noise floor.

2. The worst emission was found in the antenna is Horizontal position.

6. Main Test Instruments

Name	Manufacturer	Type	Serial Number	Calibration Date	Expiration Date
Base Station Simulator	R&S	CMU200	118133	2019-05-19	2020-05-18
Base Station Simulator	R&S	CMW500	113824	2019-05-19	2020-05-18
Power Splitter	Hua Xiang	SHX-GF2-2-13	10120101	/	/
Spectrum Analyzer	Key sight	N9010A	MY50210259	2019-05-19	2020-05-18
Universal Radio Communication Tester	Key sight	E5515C	MY48367192	2019-05-19	2020-05-18
Signal Analyzer	R&S	FSV30	100815	2018-12-16	2019-12-15
Signal Analyzer	R&S	FSV30	100815	2019-12-15	2020-12-14
Loop Antenna	SCHWARZBECK	FMZB1519	1519-047	2017-09-26	2019-09-25
Loop Antenna	SCHWARZBECK	FMZB1519	1519-047	2019-09-25	2021-09-24
Trilog Antenna	SCHWARZBECK	VUBL 9163	9163-201	2017-11-18	2019-11-17
Trilog Antenna	SCHWARZBECK	VUBL 9163	9163-201	2019-11-17	2021-11-16
Horn Antenna	R&S	HF907	100126	2018-07-07	2020-07-06
Horn Antenna	ETS-Lindgren	3160-09	00102643	2018-06-20	2020-06-19
Signal generator	R&S	SMB 100A	102594	2019-05-19	2020-05-18
Climatic Chamber	ESPEC	SU-242	93000506	2017-12-17	2020-12-16
Preamplifier	R&S	SCU18	102327	2019-05-19	2020-05-18
MOB COMMS DC SUPPLY	Keysight	66319D	MY43004105	2019-05-19	2020-05-18
RF Cable	Agilent	SMA 15cm	0001	2019-06-14	2020-06-13
Software	R&S	EMC32	9.26.0	/	/

*****END OF REPORT *****