

# TEST REPORT

**Applicant:** Shenzhen Ground Enterprises Co., Ltd

**Address of Applicant:** Room607, Building F, MingYueHuaDu, Gonghe Industrial Rd, Xixiang, Bao An District, Shenzhen 518102, China

**Manufacturer/ Factory:** Shenzhen Ground Enterprises Co., Ltd

**Address of Manufacturer/ Factory:** Room607, Building F, MingYueHuaDu, Gonghe Industrial Rd, Xixiang, Bao An District, Shenzhen 518102, China

**Equipment Under Test (EUT)**

Product Name: True Wireless Earphones

Model No.: EP-071, IQ-243TWS

Trade Mark: 

**FCC ID:** 2AMD8IQ-243TWS

**Applicable standards:** FCC CFR Title 47 Part 15 Subpart C Section 15.247

**Date of sample receipt:** December 21, 2022

**Date of Test:** December 22, 2022-January 06, 2023

**Date of report issued:** January 06, 2023

**Test Result :** PASS \*

\* In the configuration tested, the EUT complied with the standards specified above.

Authorized Signature:



**Robinson Luo**  
**Laboratory Manager**

This results shown in this test report refer only to the sample(s) tested, this test report cannot be reproduced, except in full, without prior written permission of the company. The report would be invalid without specific stamp of test institute and the signatures of compiler and approver.

## 2 Version

Version No.	Date	Description
00	January 06, 2023	Original

Prepared By:

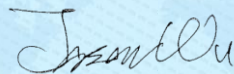

Date:

January 06, 2023

Project Engineer

Check By:



Reviewer

Date:

January 06, 2023

## 3 Contents

	Page
1 COVER PAGE.....	1
2 VERSION.....	2
3 CONTENTS .....	3
4 TEST SUMMARY .....	4
5 GENERAL INFORMATION.....	5
5.1 GENERAL DESCRIPTION OF EUT .....	5
5.2 TEST MODE .....	7
5.3 DESCRIPTION OF SUPPORT UNITS .....	7
5.4 DEVIATION FROM STANDARDS.....	7
5.5 ABNORMALITIES FROM STANDARD CONDITIONS .....	7
5.6 TEST FACILITY.....	7
5.7 TEST LOCATION .....	7
5.8 ADDITIONAL INSTRUCTIONS.....	7
6 TEST INSTRUMENTS LIST .....	8
7 TEST RESULTS AND MEASUREMENT DATA.....	10
7.1 ANTENNA REQUIREMENT .....	10
7.2 CONDUCTED EMISSIONS .....	11
7.3 CONDUCTED PEAK OUTPUT POWER .....	14
7.4 20dB EMISSION BANDWIDTH .....	15
7.5 CARRIER FREQUENCIES SEPARATION.....	16
7.6 HOPPING CHANNEL NUMBER .....	17
7.7 DWELL TIME.....	18
7.8 SPURIOUS EMISSION IN NON-RESTRICTED & RESTRICTED BANDS .....	19
7.8.1 Conducted Emission Method.....	19
7.8.2 Radiated Emission Method.....	20
8 TEST SETUP PHOTO.....	29
9 EUT CONSTRUCTIONAL DETAILS .....	29

## 4 Test Summary

Test Item	Section in CFR 47	Result
Antenna Requirement	15.203/15.247 (c)	Pass
AC Power Line Conducted Emission	15.207	Pass
Conducted Peak Output Power	15.247 (b)(1)	Pass
20dB Occupied Bandwidth	15.247 (a)(1)	Pass
Carrier Frequencies Separation	15.247 (a)(1)	Pass
Hopping Channel Number	15.247 (a)(1)(iii)	Pass
Dwell Time	15.247 (a)(1)(iii)	Pass
Radiated Emission	15.205/15.209	Pass
Band Edge	15.247(d)	Pass

*Remarks:*

1. Pass: The EUT complies with the essential requirements in the standard.
2. Test according to ANSI C63.10

### Measurement Uncertainty

Test Item	Frequency Range	Measurement Uncertainty	Notes
Radiated Emission	9kHz-30MHz	3.1dB	(1)
Radiated Emission	30MHz-200MHz	3.8039dB	(1)
Radiated Emission	200MHz-1GHz	3.9679dB	(1)
Radiated Emission	1GHz-18GHz	4.29dB	(1)
Radiated Emission	18GHz-40GHz	3.30dB	(1)
AC Power Line Conducted Emission	0.15MHz ~ 30MHz	3.44dB	(1)

Note (1): The measurement uncertainty is for coverage factor of k=2 and a level of confidence of 95%.

## 5 General Information

### 5.1 General Description of EUT

Product Name:	True Wireless Earphones
Model No.:	EP-071, IQ-243TWS
Test Model No.:	EP-071
Remark:All above models are identical in the same PCB layout, interior structure and electrical circuits. The differences are appearance color and model name for commercial purpose.	
Test sample(s) ID:	GTS202212000185-1
Sample(s) Status:	Engineer sample
S/N:	N/A
Operation Frequency:	2402MHz~2480MHz
Channel numbers:	79
Channel separation:	1MHz
Modulation type:	GFSK
Antenna Type:	Chip Antenna
Antenna gain:	1.85dBi
Power supply:	Earphone: Battery DC 3.7V, 40mAh

Operation Frequency each of channel							
Channel	Frequency	Channel	Frequency	Channel	Frequency	Channel	Frequency
1	2402MHz	21	2422MHz	41	2442MHz	61	2462MHz
2	2403MHz	22	2423MHz	42	2443MHz	62	2463MHz
3	2404MHz	23	2424MHz	43	2444MHz	63	2464MHz
4	2405MHz	24	2425MHz	44	2445MHz	64	2465MHz
5	2406MHz	25	2426MHz	45	2446MHz	65	2466MHz
6	2407MHz	26	2427MHz	46	2447MHz	66	2467MHz
7	2408MHz	27	2428MHz	47	2448MHz	67	2468MHz
8	2409MHz	28	2429MHz	48	2449MHz	68	2469MHz
9	2410MHz	29	2430MHz	49	2450MHz	69	2470MHz
10	2411MHz	30	2431MHz	50	2451MHz	70	2471MHz
11	2412MHz	31	2432MHz	51	2452MHz	71	2472MHz
12	2413MHz	32	2433MHz	52	2453MHz	72	2473MHz
13	2414MHz	33	2434MHz	53	2454MHz	73	2474MHz
14	2415MHz	34	2435MHz	54	2455MHz	74	2475MHz
15	2416MHz	35	2436MHz	55	2456MHz	75	2476MHz
16	2417MHz	36	2437MHz	56	2457MHz	76	2477MHz
17	2418MHz	37	2438MHz	57	2458MHz	77	2478MHz
18	2419MHz	38	2439MHz	58	2459MHz	78	2479MHz
19	2420MHz	39	2440MHz	59	2460MHz	79	2480MHz
20	2421MHz	40	2441MHz	60	2461MHz		

Note:

In section 15.31(m), regards to the operating frequency range over 10 MHz, the Lowest frequency, the middle frequency, and the highest frequency of channel were selected to perform the test, and the selected channel see below:

Channel	Frequency
The lowest channel	2402MHz
The middle channel	2441MHz
The Highest channel	2480MHz

## 5.2 Test mode

Transmitting mode	Keep the EUT in continuously transmitting mode.
-------------------	---

## 5.3 Description of Support Units

None.
-------

## 5.4 Deviation from Standards

None.
-------

## 5.5 Abnormalities from Standard Conditions

None.
-------

## 5.6 Test Facility

<p>The test facility is recognized, certified, or accredited by the following organizations:</p> <ul style="list-style-type: none"> <li>● <b>FCC—Registration No.: 381383</b> Designation Number: CN5029 Global United Technology Services Co., Ltd., Shenzhen EMC Laboratory has been registered and fully described in a report filed with the (FCC) Federal Communications Commission. The acceptance letter from the FCC is maintained in files.</li> <li>● <b>IC —Registration No.: 9079A</b> CAB identifier: CN0091 The 3m Semi-anechoic chamber of Global United Technology Services Co., Ltd. has been registered by Certification and Engineering Bureau of Industry Canada for radio equipment testing</li> <li>● <b>NVLAP (LAB CODE:600179-0)</b> Global United Technology Services Co., Ltd., is accredited by the National Voluntary Laboratory Accreditation Program (NVLAP).</li> </ul>
--

## 5.7 Test Location

All tests were performed at:
<p>Global United Technology Services Co., Ltd. Address: No. 123-128, Tower A, Jinyuan Business Building, No.2, Laodong Industrial Zone, Xixiang Road, Baoan District, Shenzhen, Guangdong, China 518102 Tel: 0755-27798480 Fax: 0755-27798960</p>

## 5.8 Additional Instructions

Test Software	Special test software provided by manufacturer
Power level setup	Default

## 6 Test Instruments list

Radiated Emission:						
Item	Test Equipment	Manufacturer	Model No.	Inventory No.	Cal.Date (mm-dd-yy)	Cal.Due date (mm-dd-yy)
1	3m Semi- Anechoic Chamber	ZhongYu Electron	9.2(L)*6.2(W)* 6.4(H)	GTS250	July 02, 2020	July 01, 2025
2	Control Room	ZhongYu Electron	6.2(L)*2.5(W)* 2.4(H)	GTS251	N/A	N/A
3	EMI Test Receiver	Rohde & Schwarz	ESU26	GTS203	April 22, 2022	April 21, 2023
4	BiConiLog Antenna	SCHWARZBECK MESS-ELEKTRONIK	VULB9168	GTS640	March 21, 2022	March 20, 2023
5	Double -ridged waveguide horn	SCHWARZBECK MESS-ELEKTRONIK	BBHA 9120 D	GTS208	June 12, 2022	June 11, 2023
6	Horn Antenna	ETS-LINDGREN	3160	GTS217	June 23, 2022	June 22, 2023
7	EMI Test Software	AUDIX	E3	N/A	N/A	N/A
8	Coaxial Cable	GTS	N/A	GTS213	April 22, 2022	April 21, 2023
9	Coaxial Cable	GTS	N/A	GTS211	April 22, 2022	April 21, 2023
10	Coaxial cable	GTS	N/A	GTS210	April 22, 2022	April 21, 2023
11	Coaxial Cable	GTS	N/A	GTS212	April 22, 2022	April 21, 2023
12	Amplifier(100kHz-3GHz)	HP	8347A	GTS204	April 22, 2022	April 21, 2023
13	Amplifier (18-26GHz)	Rohde & Schwarz	AFS33-18002 650-30-8P-44	GTS218	June 23, 2022	June 22, 2023
14	Band filter	Amindeon	82346	GTS219	June 23, 2022	June 22, 2023
15	Power Meter	Anritsu	ML2495A	GTS540	June 23, 2022	June 22, 2023
16	Power Sensor	Anritsu	MA2411B	GTS541	June 23, 2022	June 22, 2023
17	Wideband Radio Communication Tester	Rohde & Schwarz	CMW500	GTS575	April 22, 2022	April 21, 2023
18	Splitter	Agilent	11636B	GTS237	June 23, 2022	June 22, 2023
19	Loop Antenna	ZHINAN	ZN30900A	GTS534	Nov. 29, 2022	Nov. 28, 2023
20	Broadband Preamplifier	SCHWARZBECK	BBV9718	GTS535	April 22, 2022	April 21, 2023
21	Breitband hornantenna	SCHWARZBECK	BBHA 9170	GTS579	Oct. 16, 2022	Oct. 15, 2023
22	Amplifier	TDK	PA-02-02	GTS574	Oct. 16, 2022	Oct. 15, 2023
23	Amplifier	TDK	PA-02-03	GTS576	Oct. 16, 2022	Oct. 15, 2023
24	PSA Series Spectrum Analyzer	Rohde & Schwarz	FSP	GTS578	June 23, 2022	June 22, 2023
25	Amplifier(1GHz-26.5GHz)	HP	8449B	GTS601	April 22, 2022	April 21, 2023



Conducted Emission						
Item	Test Equipment	Manufacturer	Model No.	Inventory No.	Cal.Date (mm-dd-yy)	Cal.Due date (mm-dd-yy)
1	Shielding Room	ZhongYu Electron	7.3(L)x3.1(W)x2.9(H)	GTS252	May 14, 2022	May 13, 2025
2	EMI Test Receiver	R&S	ESCI 7	GTS552	April 24, 2022	April 23, 2023
3	Coaxial Switch	ANRITSU CORP	MP59B	GTS225	June 23, 2022	June 22, 2023
4	ENV216 2-L-V-NETZNACHB.DE	ROHDE&SCHWARZ	ENV216	GTS226	April 22, 2022	April 21, 2023
5	Coaxial Cable	GTS	N/A	GTS227	N/A	N/A
6	EMI Test Software	AUDIX	E3	N/A	N/A	N/A
7	Thermo meter	JINCHUANG	GSP-8A	GTS639	April 28, 2022	April 27, 2023
8	Absorbing clamp	Elektronik-Feinmechanik	MDS21	GTS229	April 15, 2022	April 14, 2023
9	ISN	SCHWARZBECK	NTFM 8158	GTS565	April 22, 2022	April 21, 2023
10	High voltage probe	SCHWARZBECK	TK9420	GTS537	April 22, 2022	April 21, 2023

RF Conducted Test:						
Item	Test Equipment	Manufacturer	Model No.	Serial No.	Cal.Date (mm-dd-yy)	Cal.Due date (mm-dd-yy)
1	MXA Signal Analyzer	Agilent	N9020A	GTS566	April 22, 2022	April 21, 2023
2	EMI Test Receiver	R&S	ESCI 7	GTS552	April 22, 2022	April 21, 2023
3	Spectrum Analyzer	Agilent	E4440A	GTS536	April 22, 2022	April 21, 2023
4	MXG vector Signal Generator	Agilent	N5182A	GTS567	April 22, 2022	April 21, 2023
5	ESG Analog Signal Generator	Agilent	E4428C	GTS568	April 22, 2022	April 21, 2023
6	USB RF Power Sensor	DARE	RPR3006W	GTS569	April 22, 2022	April 21, 2023
7	RF Switch Box	Shongyi	RFSW3003328	GTS571	April 22, 2022	April 21, 2023
8	Programmable Constant Temp & Humi Test Chamber	WEWON	WHTH-150L-40-880	GTS572	April 22, 2022	April 21, 2023

General used equipment:						
Item	Test Equipment	Manufacturer	Model No.	Inventory No.	Cal.Date (mm-dd-yy)	Cal.Due date (mm-dd-yy)
1	Humidity/ Temperature Indicator	KTJ	TA328	GTS243	April 25, 2022	April 24, 2023
2	Barometer	KUMAO	SF132	GTS647	July 26, 2022	July 25, 2023

## 7 Test results and Measurement Data

### 7.1 Antenna requirement

<b>Standard requirement:</b>	FCC Part15 C Section 15.203 /247(c)
<p><b>15.203 requirement:</b></p> <p>An intentional radiator shall be designed to ensure that no antenna other than that furnished by the responsible party shall be used with the device. The use of a permanently attached antenna or of an antenna that uses a unique coupling to the intentional radiator, the manufacturer may design the unit so that a broken antenna can be replaced by the user, but the use of a standard antenna jack or electrical connector is prohibited.</p> <p><b>15.247(c) (1)(i) requirement:</b></p> <p>(i) Systems operating in the 2400-2483.5 MHz band that is used exclusively for fixed. Point-to-point operations may employ transmitting antennas with directional gain greater than 6dBi provided the maximum conducted output power of the intentional radiator is reduced by 1 dB for every 3 dB that the directional gain of the antenna exceeds 6dBi.</p>	
<b>E.U.T Antenna:</b>	
The antenna is chip antenna, reference to the appendix II for details.	

## 7.2 Conducted Emissions

Test Requirement:	FCC Part15 C Section 15.207				
Test Method:	ANSI C63.10				
Test Frequency Range:	150KHz to 30MHz				
Class / Severity:	Class B				
Receiver setup:	RBW=9KHz, VBW=30KHz, Sweep time=auto				
Limit:	Frequency range (MHz)	Limit (dBuV)			
		Quasi-peak		Average	
	0.15-0.5	66 to 56*		56 to 46*	
	0.5-5	56		46	
	5-30	60		50	
* Decreases with the logarithm of the frequency.					
Test setup:	<p>Remark E.U.T: Equipment Under Test LISN: Line Impedance Stabilization Network Test table height=0.8m</p>				
Test procedure:	<ol style="list-style-type: none"> <li>1. The E.U.T and simulators are connected to the main power through a line impedance stabilization network (L.I.S.N.). This provides a 50ohm/50uH coupling impedance for the measuring equipment.</li> <li>2. The peripheral devices are also connected to the main power through a LISN that provides a 50ohm/50uH coupling impedance with 50ohm termination. (Please refer to the block diagram of the test setup and photographs).</li> <li>3. Both sides of A.C. line are checked for maximum conducted interference. In order to find the maximum emission, the relative positions of equipment and all of the interface cables must be changed according to ANSI C63.10 on conducted measurement.</li> </ol>				
Test Instruments:	Refer to section 6.0 for details				
Test mode:	Refer to section 5.2 for details				
Test environment:	Temp.:	25 °C	Humid.:	52%	Press.: 1012mbar
Test voltage:	AC 120V				
Test results:	Pass				

**Measurement data:**

Pre-scan all test modes, found worst case at GFSK 2402MHz, and so only show the test result of it  
Line:

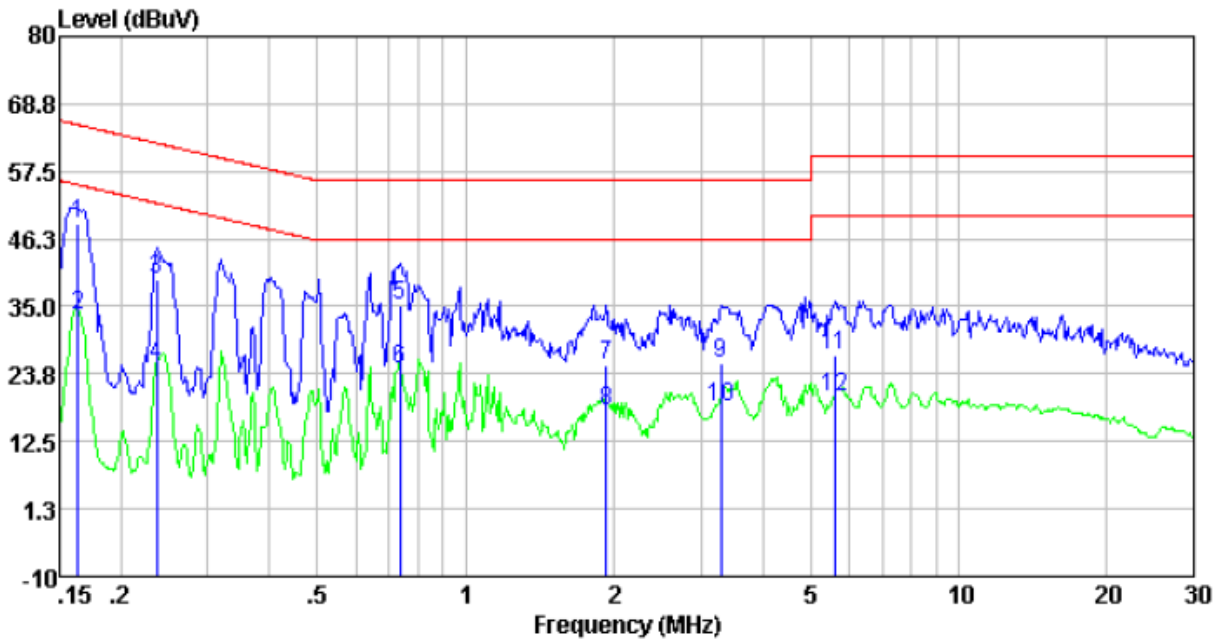

Freq	Reading level	LISN/ISN factor	Cable loss	Level	Limit level	Over limit	Remark
MHz	dBuV	dB	dB	dBuV	dBuV	dB	
0.16	38.51	10.11	0.01	48.63	65.30	-16.67	QP
0.16	23.29	10.11	0.01	33.41	55.30	-21.89	Average
0.24	29.56	10.02	0.01	39.59	62.22	-22.63	QP
0.24	15.16	10.02	0.01	25.19	52.22	-27.03	Average
0.74	25.33	9.96	0.02	35.31	56.00	-20.69	QP
0.74	14.59	9.96	0.02	24.57	46.00	-21.43	Average
1.93	15.36	9.85	0.04	25.25	56.00	-30.75	QP
1.93	7.81	9.85	0.04	17.70	46.00	-28.30	Average
3.29	15.68	9.74	0.05	25.47	56.00	-30.53	QP
3.29	8.49	9.74	0.05	18.28	46.00	-27.72	Average
5.59	17.19	9.74	0.07	27.00	60.00	-33.00	QP
5.59	9.96	9.74	0.07	19.77	50.00	-30.23	Average

Neutral:

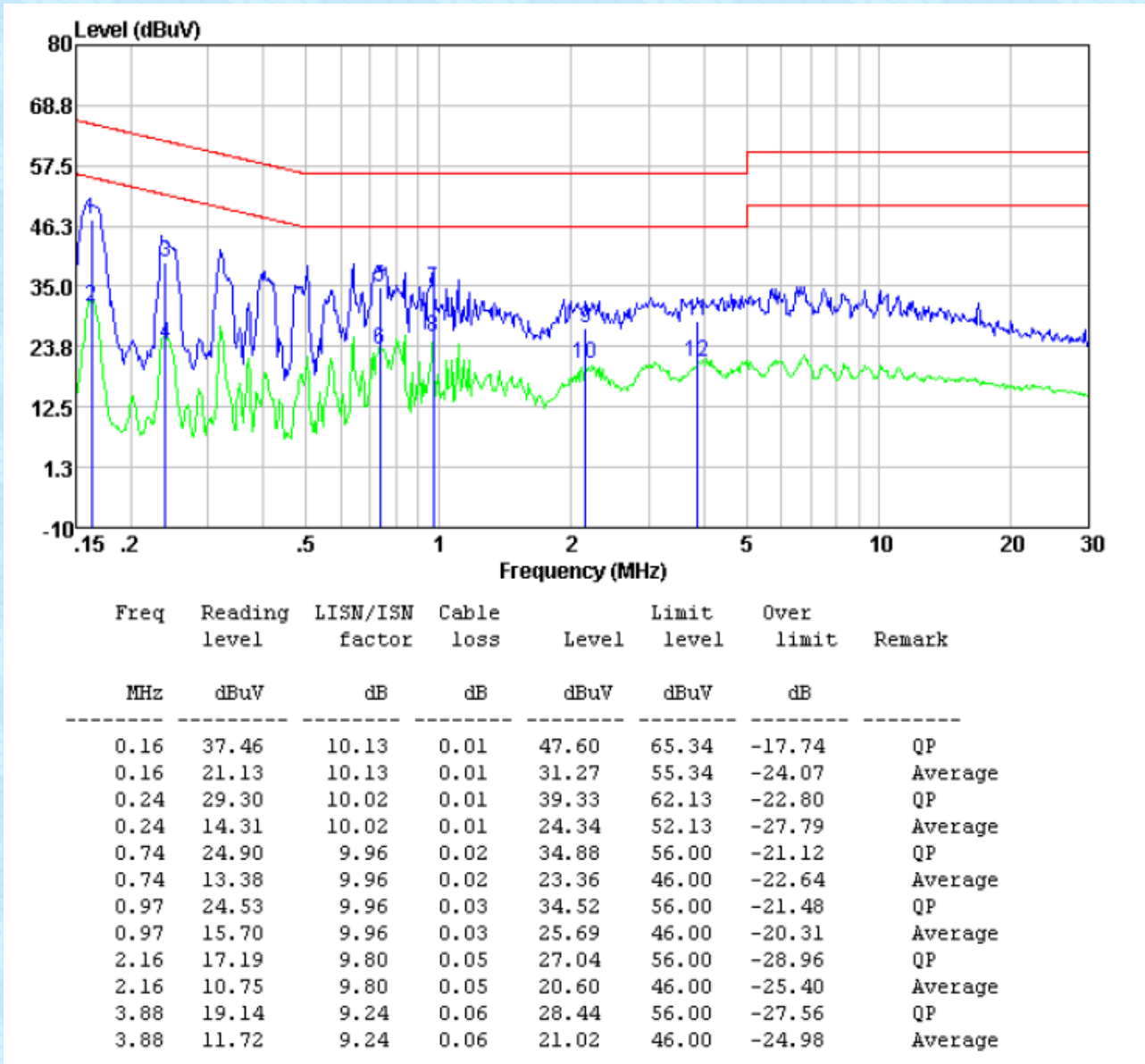

Notes:

1. An initial pre-scan was performed on the line and neutral lines with peak detector.
2. Quasi-Peak and Average measurement were performed at the frequencies with maximized peak emission.

Final Level = Receiver Read level + LISN Factor + Cable Loss

### 7.3 Conducted Peak Output Power

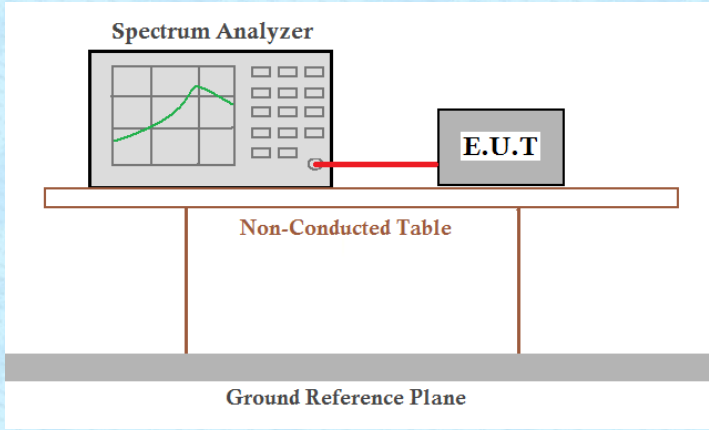
Test Requirement:	FCC Part15 C Section 15.247 (a)(1)
Test Method:	ANSI C63.10
Limit:	30dBm
Test setup:	 <p>The diagram illustrates the test setup. A Spectrum Analyzer is connected to an E.U.T. (Equipment Under Test) via a red cable. Both are placed on a Non-Conducted Table, which sits on a Ground Reference Plane.</p>
Test Instruments:	Refer to section 6.0 for details
Test mode:	Refer to section 5.2 for details
Test results:	Pass

**Measurement Data:** The detailed test data see Appendix for BT EDR.

## 7.4 20dB Emission Bandwidth

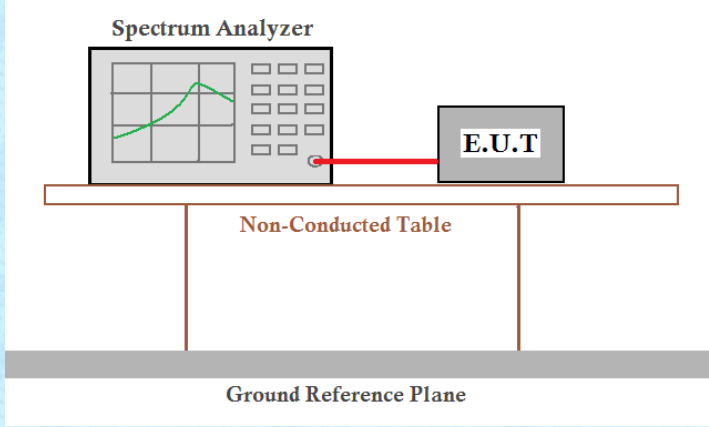
Test Requirement:	FCC Part15 C Section 15.247 (a)(1)
Test Method:	ANSI C63.10
Limit:	N/A
Test setup:	 <p>The diagram illustrates the test setup. A Spectrum Analyzer is connected to an E.U.T. (Equipment Under Test) via a red cable. Both are placed on a Non-Conducted Table, which is supported by a Ground Reference Plane.</p>
Test Instruments:	Refer to section 6.0 for details
Test mode:	Refer to section 5.2 for details
Test results:	Pass

**Measurement Data:** The detailed test data see Appendix for BT EDR.

## 7.5 Carrier Frequencies Separation

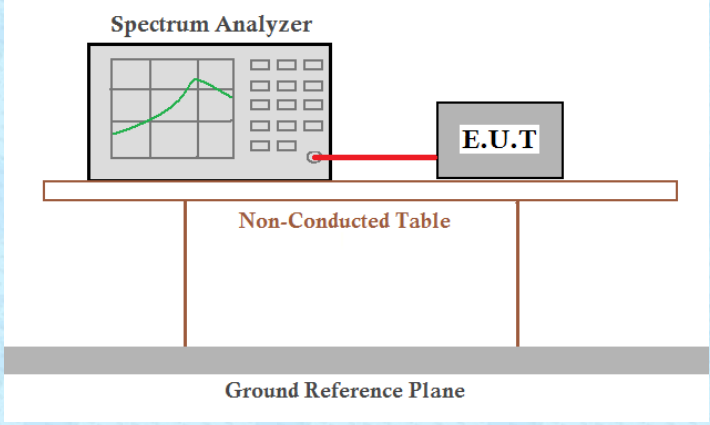
Test Requirement:	FCC Part15 C Section 15.247 (a)(1)
Test Method:	ANSI C63.10
Limit:	0.025MHz or 2/3 of the 20dB bandwidth (whichever is greater)
Test setup:	 <p>The diagram illustrates the test setup. A Spectrum Analyzer is connected to an E.U.T. (Equipment Under Test) via a red cable. Both are placed on a Non-Conducted Table, which is supported by a Ground Reference Plane.</p>
Test Instruments:	Refer to section 6.0 for details
Test mode:	Refer to section 5.2 for details
Test results:	Pass

**Measurement Data:** The detailed test data see Appendix for BT EDR.

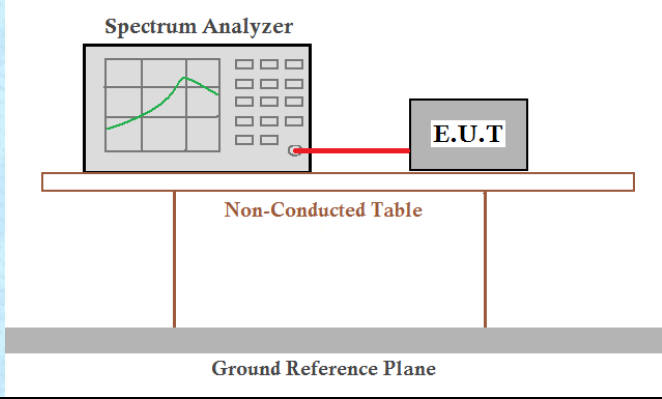

## 7.6 Hopping Channel Number

Test Requirement:	FCC Part15 C Section 15.247 (a)(1)(iii)
Test Method:	ANSI C63.10
Limit:	15 channels
Test setup:	 <p>The diagram illustrates the test setup. A Spectrum Analyzer is connected to an E.U.T. (Equipment Under Test) via a red cable. Both are placed on a Non-Conducted Table, which is supported by a Ground Reference Plane.</p>
Test Instruments:	Refer to section 6.0 for details
Test mode:	Refer to section 5.2 for details
Test results:	Pass

**Measurement Data:** The detailed test data see Appendix for BT EDR.

## 7.7 Dwell Time

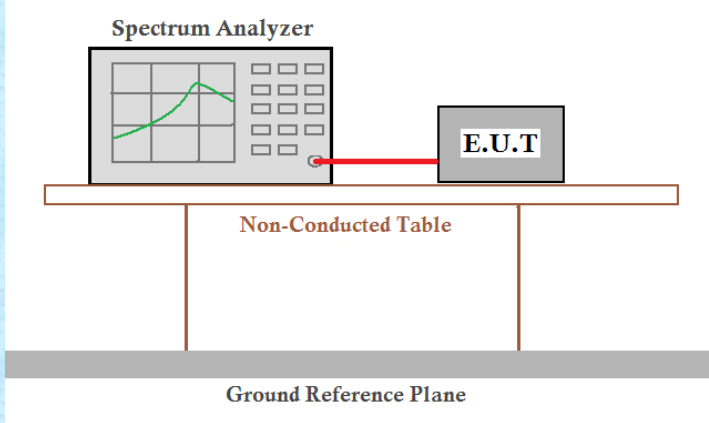
Test Requirement:	FCC Part15 C Section 15.247 (a)(1)(iii)
Test Method:	ANSI C63.10
Limit:	0.4 Second
Test setup:	 <p>The diagram illustrates the test setup. A Spectrum Analyzer is connected to an E.U.T. (Equipment Under Test) via a red cable. Both are placed on a Non-Conducted Table, which is supported by a Ground Reference Plane.</p>
Test Instruments:	Refer to section 6.0 for details
Test mode:	Refer to section 5.2 for details
Test results:	Pass

**Measurement Data:** The detailed test data see Appendix for BT EDR.

## 7.8 Spurious Emission in Non-restricted & restricted Bands

### 7.8.1 Conducted Emission Method

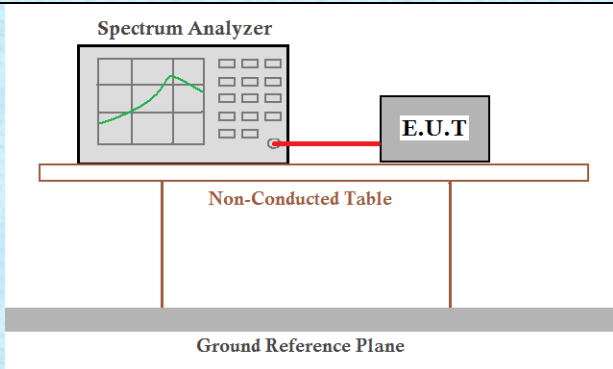
Test Requirement:	FCC Part15 C Section 15.247 (d)
Test Method:	ANSI C63.10
Receiver setup:	RBW=100kHz, VBW=300kHz, Detector=Peak
Limit:	In any 100 kHz bandwidth outside the frequency band in which the spread spectrum intentional radiator is operating, the radio frequency power that is produced by the intentional radiator shall be at least 20 dB below that in the 100 kHz bandwidth within the band that contains the highest level of the desired power, based on either an RF conducted or a radiated measurement.
Test setup:	 <p>The diagram illustrates the test setup. A Spectrum Analyzer is connected to an E.U.T. (Equipment Under Test) via a red cable. Both the Spectrum Analyzer and the E.U.T. are placed on a Non-Conducted Table. The table is supported by a Ground Reference Plane.</p>
Test Instruments:	Refer to section 6.0 for details
Test mode:	Refer to section 5.2 for details
Test results:	Pass

**Measurement Data:** The detailed test data see Appendix for BT EDR.

## 7.8.2 Radiated Emission Method

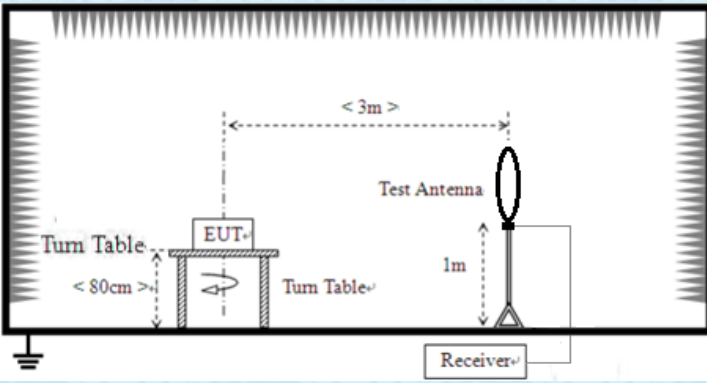
Test Requirement:	FCC Part15 C Section 15.209				
Test Method:	ANSI C63.10				
Test Frequency Range:	9kHz to 25GHz				
Test site:	Measurement Distance: 3m				
Receiver setup:	Frequency	Detector	RBW	VBW	Value
	9KHz-150KHz	Quasi-peak	200Hz	600Hz	Quasi-peak
	150KHz-30MHz	Quasi-peak	9KHz	30KHz	Quasi-peak
	30MHz-1GHz	Quasi-peak	120KHz	300KHz	Quasi-peak
	Above 1GHz	Peak	1MHz	3MHz	Peak
		Peak	1MHz	10Hz	Average
Note: For Duty cycle $\geq 98\%$ , average detector set as above For Duty cycle $< 98\%$ , average detector set as below: $VBW \geq 1 / T$					
Limit:	Frequency	Limit (uV/m)	Value	Measurement Distance	
	0.009MHz-0.490MHz	2400/F(KHz)	PK/QP/AV	300m	
	0.490MHz-1.705MHz	24000/F(KHz)	QP	30m	
	1.705MHz-30MHz	30	QP	30m	
	30MHz-88MHz	100	QP	3m	
	88MHz-216MHz	150	QP		
	216MHz-960MHz	200	QP		
	960MHz-1GHz	500	QP		
	Above 1GHz	500	Average		
		5000	Peak		
Test setup:	<p>For radiated emissions from 9kHz to 30MHz</p> 				

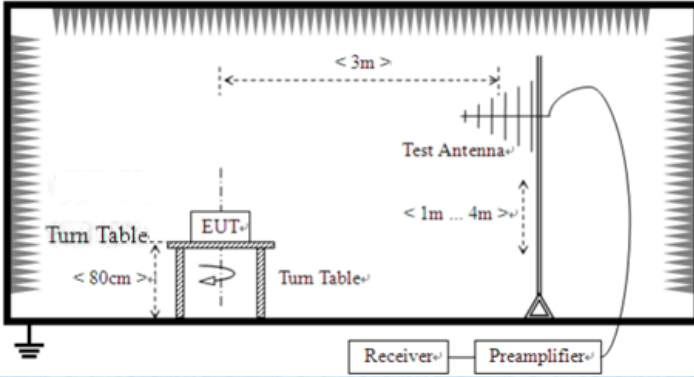
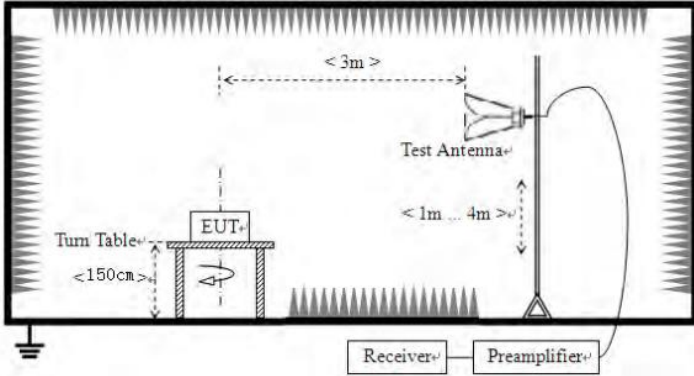
	<p>For radiated emissions from 30MHz to1GHz</p>  <p>For radiated emissions above 1GHz</p> 
<p>Test Procedure:</p>	<ol style="list-style-type: none"> <li>1. The EUT was placed on the top of a rotating table (0.8m for below 1G and 1.5m for above 1G) above the ground at a 3 meter camber. The table was rotated 360 degrees to determine the position of the highest radiation.</li> <li>2. The EUT was set 3 meters away from the interference-receiving antenna, which was mounted on the top of a variable-height antenna tower.</li> <li>3. The antenna height is varied from one meter to four meters above the ground to determine the maximum value of the field strength. Both horizontal and vertical polarizations of the antenna are set to make the measurement.</li> <li>4. For each suspected emission, the EUT was arranged to its worst case and then the antenna was tuned to heights from 1 meter to 4 meters and the rota table was turned from 0 degrees to 360 degrees to find the maximum reading.</li> <li>5. The test-receiver system was set to Peak Detect Function and Specified Bandwidth with Maximum Hold Mode.</li> <li>6. If the emission level of the EUT in peak mode was 10dB lower than the limit specified, then testing could be stopped and the peak values of the EUT would be reported. Otherwise the emissions that did not have 10dB margin would be re-tested one by one using peak, quasi-peak or average method as specified and then reported in a data sheet.</li> </ol>
<p>Test Instruments:</p>	<p>Refer to section 6.0 for details</p>
<p>Test mode:</p>	<p>Refer to section 5.2 for details</p>

Test environment:	Temp.:	25 °C	Humid.:	52%	Press.:	1012mbar
Test voltage:	DC 3.7V					
Test results:	Pass					

**Measurement data:**

*Remarks:*

1. Pre-scan all kind of the place mode (X-axis, Y-axis, Z-axis), and found the Y-axis which it is worse case.

■ **9kHz~30MHz**

The low frequency, which started from 9 kHz to 30 MHz, was pre-scanned and the result which was 20 dB lower than the limit line per 15.31(o) was not reported.

■ Below 1GHz

Pre-scan all test modes, found worst case at GFSK 2402MHz, and so only show the test result of it

Horizontal:

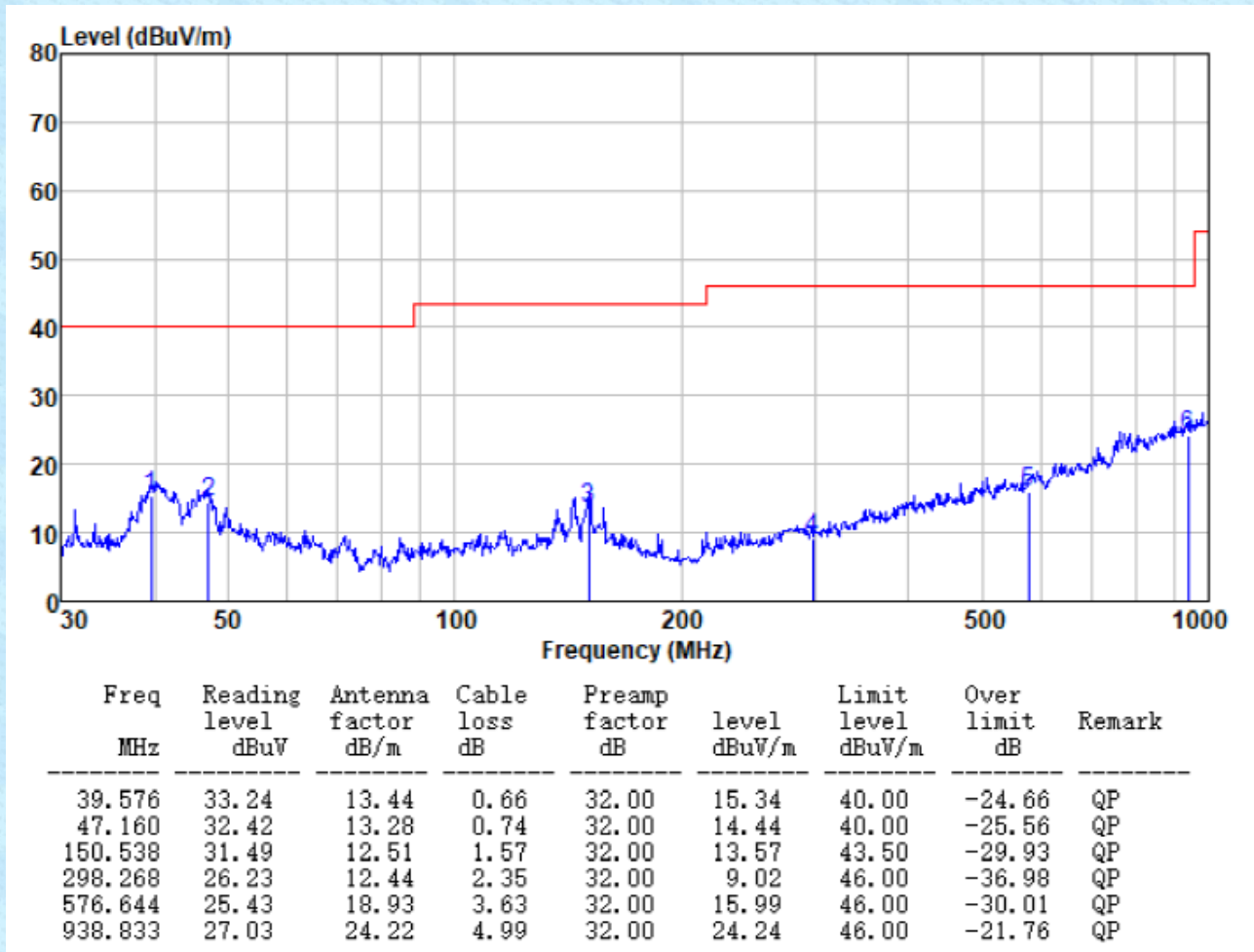

Vertical:

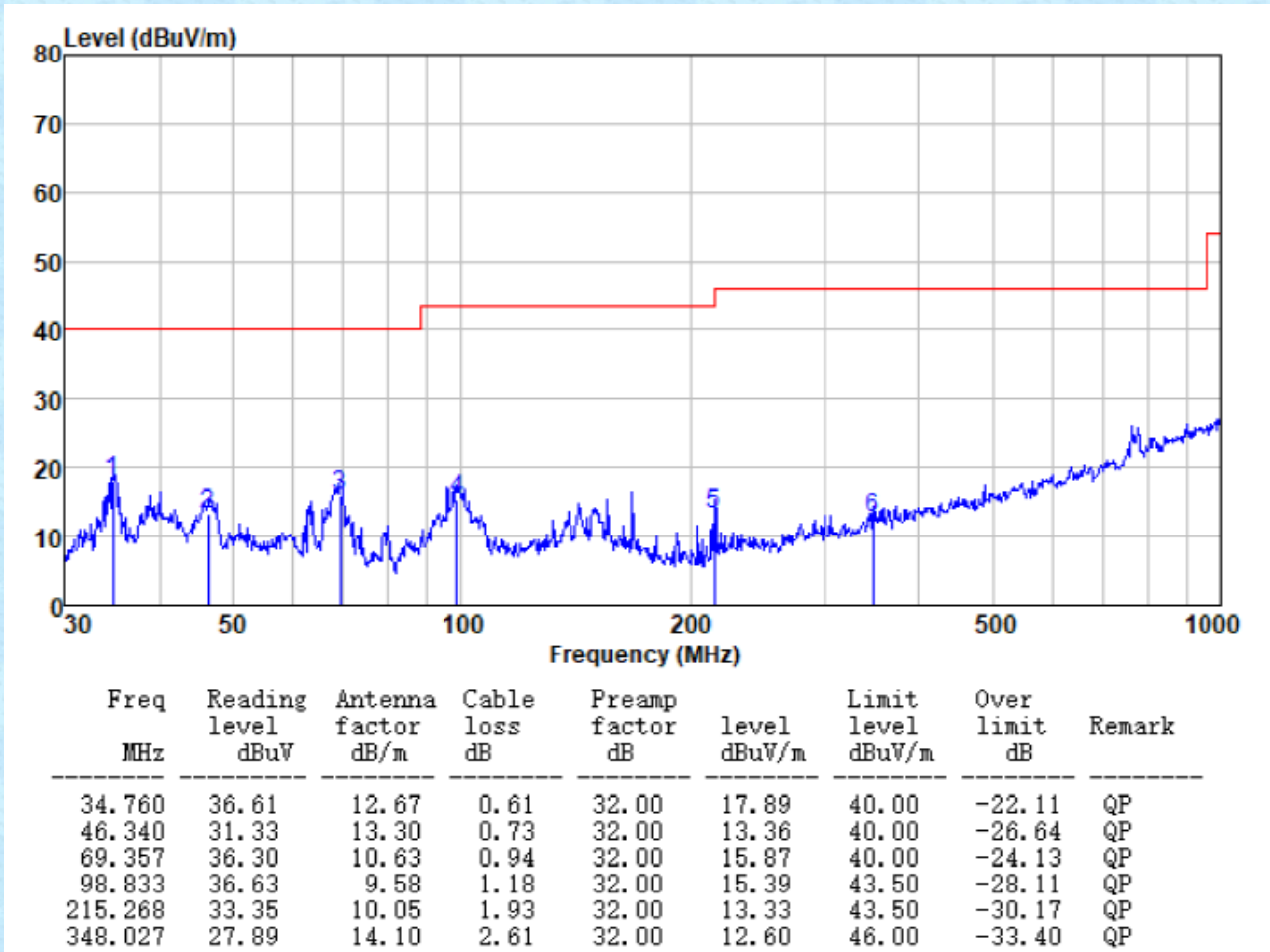



- Above 1GHz
- Unwanted Emissions in Restricted Frequency Bands

Test channel:	Lowest channel
---------------	----------------

**Peak value:**

Frequency (MHz)	Read Level (dBuV)	Antenna Factor (dB/m)	Cable Loss (dB)	Preamp Factor (dB)	Level (dBuV/m)	Limit Line (dBuV/m)	Over Limit (dB)	polarization
4804.00	34.96	31.78	8.60	32.09	43.25	74.00	-30.75	Vertical
7206.00	30.28	36.15	11.65	32.00	46.08	74.00	-27.92	Vertical
9608.00	30.09	37.95	14.14	31.62	50.56	74.00	-23.44	Vertical
4804.00	38.77	31.78	8.60	32.09	47.06	74.00	-26.94	Horizontal
7206.00	31.83	36.15	11.65	32.00	47.63	74.00	-26.37	Horizontal
9608.00	29.29	37.95	14.14	31.62	49.76	74.00	-24.24	Horizontal

**Average value:**

Frequency (MHz)	Read Level (dBuV)	Antenna Factor (dB/m)	Cable Loss (dB)	Preamp Factor (dB)	Level (dBuV/m)	Limit Line (dBuV/m)	Over Limit (dB)	polarization
4804.00	24.22	31.78	8.60	32.09	32.51	54.00	-21.49	Vertical
7206.00	19.23	36.15	11.65	32.00	35.03	54.00	-18.97	Vertical
9608.00	18.45	37.95	14.14	31.62	38.92	54.00	-15.08	Vertical
4804.00	28.19	31.78	8.60	32.09	36.48	54.00	-17.52	Horizontal
7206.00	21.25	36.15	11.65	32.00	37.05	54.00	-16.95	Horizontal
9608.00	17.99	37.95	14.14	31.62	38.46	54.00	-15.54	Horizontal

Test channel:	Middle channel
---------------	----------------

**Peak value:**

Frequency (MHz)	Read Level (dBuV)	Antenna Factor (dB/m)	Cable Loss (dB)	Preamp Factor (dB)	Level (dBuV/m)	Limit Line (dBuV/m)	Over Limit (dB)	polarization
4882.00	36.15	31.85	8.67	32.12	44.55	74.00	-29.45	Vertical
7323.00	31.07	36.37	11.72	31.89	47.27	74.00	-26.73	Vertical
9764.00	30.79	38.35	14.25	31.62	51.77	74.00	-22.23	Vertical
4882.00	40.21	31.85	8.67	32.12	48.61	74.00	-25.39	Horizontal
7323.00	32.72	36.37	11.72	31.89	48.92	74.00	-25.08	Horizontal
9764.00	30.10	38.35	14.25	31.62	51.08	74.00	-22.92	Horizontal

**Average value:**

Frequency (MHz)	Read Level (dBuV)	Antenna Factor (dB/m)	Cable Loss (dB)	Preamp Factor (dB)	Level (dBuV/m)	Limit Line (dBuV/m)	Over Limit (dB)	polarization
4882.00	25.19	31.85	8.67	32.12	33.59	54.00	-20.41	Vertical
7323.00	19.89	36.37	11.72	31.89	36.09	54.00	-17.91	Vertical
9764.00	19.04	38.35	14.25	31.62	40.02	54.00	-13.98	Vertical
4882.00	29.30	31.85	8.67	32.12	37.70	54.00	-16.30	Horizontal
7323.00	21.99	36.37	11.72	31.89	38.19	54.00	-15.81	Horizontal
9764.00	18.67	38.35	14.25	31.62	39.65	54.00	-14.35	Horizontal

Test channel:	Highest channel
---------------	-----------------

**Peak value:**

Frequency (MHz)	Read Level (dBuV)	Antenna Factor (dB/m)	Cable Loss (dB)	Preamp Factor (dB)	Level (dBuV/m)	Limit Line (dBuV/m)	Over Limit (dB)	polarization
4960.00	36.56	31.93	8.73	32.16	45.06	74.00	-28.94	Vertical
7440.00	31.34	36.59	11.79	31.78	47.94	74.00	-26.06	Vertical
9920.00	31.03	38.81	14.38	31.88	52.34	74.00	-21.66	Vertical
4960.00	40.70	31.93	8.73	32.16	49.20	74.00	-24.80	Horizontal
7440.00	33.03	36.59	11.79	31.78	49.63	74.00	-24.37	Horizontal
9920.00	30.38	38.81	14.38	31.88	51.69	74.00	-22.31	Horizontal

**Average value:**

Frequency (MHz)	Read Level (dBuV)	Antenna Factor (dB/m)	Cable Loss (dB)	Preamp Factor (dB)	Level (dBuV/m)	Limit Line (dBuV/m)	Over Limit (dB)	polarization
4960.00	25.58	31.93	8.73	32.16	34.08	54.00	-19.92	Vertical
7440.00	20.15	36.59	11.79	31.78	36.75	54.00	-17.25	Vertical
9920.00	19.27	38.81	14.38	31.88	40.58	54.00	-13.42	Vertical
4960.00	29.74	31.93	8.73	32.16	38.24	54.00	-15.76	Horizontal
7440.00	22.28	36.59	11.79	31.78	38.88	54.00	-15.12	Horizontal
9920.00	18.95	38.81	14.38	31.88	40.26	54.00	-13.74	Horizontal

*Remarks:*

1. *Final Level = Receiver Read level + Antenna Factor + Cable Loss – Preamplifier Factor*
2. *The emission levels of other frequencies are very lower than the limit and not show in test report.*

■ **Unwanted Emissions in Non-restricted Frequency Bands**

Test channel:	Lowest channel
---------------	----------------

**Peak value:**

Frequency (MHz)	Read Level (dBuV)	Antenna Factor (dB/m)	Cable Loss (dB)	Preamp Factor (dB)	Level (dBuV/m)	Limit Line (dBuV/m)	Over Limit (dB)	Polarization
2310.00	41.16	27.14	2.81	38.64	32.47	74.00	-41.53	Horizontal
2390.00	42.64	27.37	2.91	38.84	34.08	74.00	-39.92	Horizontal
2310.00	42.06	27.14	2.81	38.64	33.37	74.00	-40.63	Vertical
2390.00	43.16	27.37	2.91	38.84	34.60	74.00	-39.40	Vertical

**Average value:**

Frequency (MHz)	Read Level (dBuV)	Antenna Factor (dB/m)	Cable Loss (dB)	Preamp Factor (dB)	Level (dBuV/m)	Limit Line (dBuV/m)	Over Limit (dB)	Polarization
2310.00	32.10	27.14	2.81	38.64	23.41	54.00	-30.59	Horizontal
2390.00	33.24	27.37	2.91	38.84	24.68	54.00	-29.32	Horizontal
2310.00	32.21	27.14	2.81	38.64	23.52	54.00	-30.48	Vertical
2390.00	33.17	27.37	2.91	38.84	24.61	54.00	-29.39	Vertical

Test channel:	Highest channel
---------------	-----------------

**Peak value:**

Frequency (MHz)	Read Level (dBuV)	Antenna Factor (dB/m)	Cable Loss (dB)	Preamp Factor (dB)	Level (dBuV/m)	Limit Line (dBuV/m)	Over Limit (dB)	Polarization
2483.50	44.71	27.82	2.99	39.05	36.47	74.00	-37.53	Horizontal
2500.00	43.93	27.70	3.01	39.10	35.54	74.00	-38.46	Horizontal
2483.50	45.52	27.82	2.99	39.05	37.28	74.00	-36.72	Vertical
2500.00	44.91	27.70	3.01	39.10	36.52	74.00	-37.48	Vertical

**Average value:**

Frequency (MHz)	Read Level (dBuV)	Antenna Factor (dB/m)	Cable Loss (dB)	Preamp Factor (dB)	Level (dBuV/m)	Limit Line (dBuV/m)	Over Limit (dB)	Polarization
2483.50	36.07	27.82	2.99	39.05	27.83	54.00	-26.17	Horizontal
2500.00	34.10	27.70	3.01	39.10	25.71	54.00	-28.29	Horizontal
2483.50	37.26	27.82	2.99	39.05	29.02	54.00	-24.98	Vertical
2500.00	34.00	27.70	3.01	39.10	25.61	54.00	-28.39	Vertical

Remarks:

1. Final Level = Receiver Read level + Antenna Factor + Cable Loss – Pre-amplifier Factor
2. The emission levels of other frequencies are very lower than the limit and not show in test report.

## 8 Test Setup Photo

Reference to the **appendix I** for details.

## 9 EUT Constructional Details

Reference to the **appendix II** for details.

-----End-----