

**ELECTROMAGNETIC EMISSIONS COMPLIANCE REPORT  
INTENTIONAL RADIATOR CERTIFICATION TO  
FCC PART 15 SUBPART C REQUIREMENT**

*OF*

**FOLDABLE WIRELESS CHARGER**

**Model No.: 2733345**

**FCC ID: 2AMD8-WC133**

**Report No.: E04A23111146F01501**

**Issue Date: Dec. 14, 2023**

*Prepared for*

**Shenzhen Ground Enterprises Co., Ltd**

**Room607, Building F, MingYueHuaDu, Gonghe Industrial Rd,  
Xixiang, Bao An District, Shenzhen, China**

*Prepared by*

**Guangdong Global Testing Technology Co., Ltd.**

**Room 101-105, 203-210, Building 1, No.2, Keji 8 Road, Songshan Lake  
Park, Dongguan city, Guangdong, People' s Republic of China,  
523808**

**This report shall not be reproduced, except in full, without the written approval of  
Guangdong Global Testing Technology Co., Ltd.**

**VERIFICATION OF COMPLIANCE**

Applicant:	Shenzhen Ground Enterprises Co., Ltd Room607, Building F, MingYueHuaDu, Gonghe Industrial Rd, Xixiang, Bao An District, Shenzhen, China
Manufacturer:	Shenzhen Ground Enterprises Co., Ltd Room607, Building F, MingYueHuaDu, Gonghe Industrial Rd, Xixiang, Bao An District, Shenzhen, China
BUYER:	RADIOSHACK WORLDWIDE CORP.
Product Description:	FOLDABLE WIRELESS CHARGER
Model Number:	2733345
Series Model:	WC-133
Brand:	Ground, radioshack

**We hereby certify that:**

The above equipment was tested by Guangdong Global Testing Technology Co., Ltd. The test data, data evaluation, test procedures, and equipment configurations shown in this report were made in accordance with the procedures given in ANSI C63.10-2013 and the energy emitted by the sample EUT tested as described in this report is in compliance with conducted and radiated emission limits of FCC Rules Part 15.209(2022).

Date of Test: Dec. 01, 2023 to Dec. 14, 2023

Prepared by:   
Alan He/Editor

Reviewer & Authorized Signer:   
Shawn Wen/ General Manager



### Modified Information

Version	Summary	Revision Date	Report No.
Ver.1.0	Original Report	/	E04A23111146F01501

## Table of Contents

<b>1</b>	<b>GENERAL INFORMATION .....</b>	<b>4</b>
1.1	PRODUCT DESCRIPTION .....	4
1.2	RELATED SUBMITTAL(S) / GRANT(S).....	5
1.3	TEST METHODOLOGY .....	5
1.4	SPECIAL ACCESSORIES .....	5
1.5	EQUIPMENT MODIFICATIONS .....	5
1.6	TEST FACILITY.....	5
<b>2</b>	<b>SYSTEM TEST CONFIGURATION.....</b>	<b>6</b>
2.1	EUT CONFIGURATION .....	6
2.2	EUT EXERCISE .....	6
2.3	TEST PROCEDURE .....	6
2.4	CONFIGURATION OF TESTED SYSTEM.....	7
<b>3</b>	<b>SUMMARY OF TEST RESULTS.....</b>	<b>7</b>
<b>4</b>	<b>TEST SYSTEM UNCERTAINTY.....</b>	<b>8</b>
<b>5</b>	<b>CONDUCTED EMISSIONS TEST .....</b>	<b>9</b>
5.1	MEASUREMENT PROCEDURE .....	9
5.2	TEST SET-UP (BLOCK DIAGRAM OF CONFIGURATION).....	9
5.3	MEASUREMENT EQUIPMENT USED.....	9
5.4	CONDUCTED EMISSION LIMIT .....	9
5.5	MEASUREMENT RESULT .....	10
5.6	CONDUCTED MEASUREMENT PHOTO.....	13
<b>6</b>	<b>RADIATED EMISSION TEST.....</b>	<b>14</b>
6.1	MEASUREMENT PROCEDURE .....	14
6.2	TEST SET-UP (BLOCK DIAGRAM OF CONFIGURATION).....	14
6.3	MEASUREMENT EQUIPMENT USED.....	15
6.4	RADIATED EMISSION LIMIT .....	15
6.5	MEASUREMENT RESULT .....	17
6.6	RADIATED MEASUREMENT PHOTOS.....	23
<b>7</b>	<b>20DB BANDWIDTH .....</b>	<b>24</b>
7.1	20DB BANDWIDTH LIMIT .....	24
7.2	TEST INSTRUMENTS.....	24
7.3	TEST PROCEDURE .....	24
7.4	TEST SETUP.....	24
7.5	TEST RESULT.....	24
<b>8</b>	<b>ANTENNA APPLICATION .....</b>	<b>26</b>
8.1	ANTENNA REQUIREMENT .....	26
8.2	RESULT .....	26
	<b>APPENDIX.....</b>	<b>27</b>

## 1 General Information

### 1.1 Product Description

Characteristics	Description
Product Name	FOLDABLE WIRELESS CHARGER
Model number	2733345
Series Model	WC-133
Model Difference	Same product, different model name
Operation Mode	Wireless Charging
Rating	Input: DC 5V 2A, DC 9v 1.67A, DC 12V 1.5A Output: 15W/10W/7.5W/5W
Battery Rating	N/A
Power Supply	AC 120V
Operating Frequency	110-205KHz
Wireless Charging Power	15W/10W/7.5W/5W
Modulation Technique	ASK
Antenna Type	Coil Antenna
Sample receipt date	Dec. 07, 2023

**1.2 Related Submittal(s) / Grant(s)**

This submittal(s) (test report) is intended for FCC ID: 2AMD8-WC133 filing to comply with the FCC Part 15, Subpart C Rules.

**1.3 Test Methodology**

Both conducted and radiated testing was performed according to the procedures in ANSI C63.10 (2013). Radiated testing was performed at an antenna to EUT distance 3 meters.

**1.4 Special Accessories**

Not available for this EUT intended for grant.

**1.5 Equipment Modifications**

Not available for this EUT intended for grant.

**1.6 Test Facility**

Accreditation Certificate	<p><b>A2LA (Certificate No.: 6947.01)</b>                  Guangdong Global Testing Technology Co., Ltd.                  has been assessed and proved to be in compliance with A2LA.</p> <p><b>FCC (FCC Designation No.: CN1343)</b>                  Guangdong Global Testing Technology Co., Ltd.                  has been recognized to perform compliance testing on equipment subject to Supplier's Declaration of Conformity (SDoC) and Certification rules</p> <p><b>ISED (Company No.: 30714)</b>                  Guangdong Global Testing Technology Co., Ltd.                  has been registered and fully described in a report filed with ISED. The Company Number is 30714 and the test lab Conformity Assessment Body Identifier (CABID) is CN0148.</p>
---------------------------	--

Note: All tests measurement facilities use to collect the measurement data are located at Room 101-105, 203-210, Building 1, No.2, Keji 8 Road, Songshan Lake Park, Dongguan city, Guangdong, People’s Republic of China, 523808

## 2 System Test Configuration

### 2.1 EUT Configuration

The EUT configuration for testing is installed on RF field strength measurement to meet the Commissions requirement and operating in a manner which intends to maximize its emission characteristics in a continuous normal application.

### 2.2 EUT Exercise

The Transmitter was operated in the normal operating mode. The TX frequency was fixed which was for the purpose of the measurements.

### 2.3 Test Procedure

#### 2.3.1 Conducted Emissions

The EUT is placed on a turn table which is 0.8 m above ground plane. According to the requirements in Section 13.1.4.1 of ANSI C63.10-2013 Conducted emissions from the EUT measured in the frequency range between 0.15 MHz and 30 MHz using CISPR Quasi-Peak and average detector mode.

#### 2.3.2 Radiated Emissions

The EUT is placed on a turn table which is 0.8 m above ground plane. The turn table shall rotate 360 degrees to determine the position of maximum emission level. EUT is set 3m away from the receiving antenna which varied from 1m to 4m to find out the highest emission. And also, each emission was to be maximized by changing the polarization of receiving antenna both horizontal and vertical. In order to find out the max. emission, the fixed in a particular direction according to the requirements in Section 13.1.4.1 of ANSI C63.10-2013.

## 2.4 Configuration of Tested System

**Fig. 2-1 Configuration of Tested System**

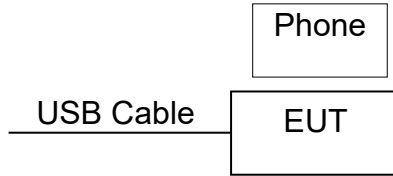

**Table 2-1 Equipment Used in Tested System**

Item	Equipment	Trade Mark	Model No.	FCC ID	Note
1.	FOLDABLE WIRELESS CHARGER	/	2733345	2AMD8-WC133	<b><i>EUT</i></b>
2.	Phone	Apple	A2176	N/A	<b><i>Support Equipment</i></b>
3.	Adapter	XIAOMI	MDY-11-EX	N/A	<b><i>Support Equipment</i></b>

**Note:**

- (1) Unless otherwise denoted as EUT in 『Remark』 column, device(s) used in tested system is a support equipment.

## 3 Summary of Test Results

FCC Rules	Description Of Test	Result
§15.207	AC Power Conducted Emission	Compliant
§15.209	Radiated Emission	Compliant
§2.1049	20dB Bandwidth	Compliant
§15.203	Antenna Requirement	Compliant



## 4 TEST SYSTEM UNCERTAINTY

The following measurement uncertainty levels have been estimated for tests performed on the apparatus:

Parameter	Uncertainty
Conducted Emissions Test	$\pm 2.0\text{dB}$
Radiated Emission Test	$\pm 2.0\text{dB}$
Temperature	$\pm 0.5^{\circ}\text{C}$
Humidity	$\pm 3\%$

Remark: The coverage Factor ( $k=2$ ), and measurement Uncertainty for a level of Confidence of 95%

## 5 Conducted Emissions Test

### 5.1 Measurement Procedure

1. The EUT was placed on a table which is 0.8m above ground plane.
2. Maximum procedure was performed on the six highest emissions to ensure EUT compliance.
3. Repeat above procedures until all frequency measured was complete.

### 5.2 Test SET-UP (Block Diagram of Configuration)

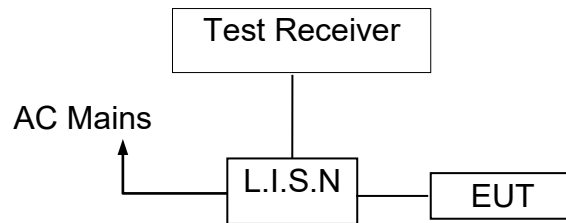

### 5.3 Measurement Equipment Used

Equipment	Manufacturer	Model No.	Serial No.	Last Cal.	Due Date
Shielded Room	CHENG YU	8m*5m*4m	N/A	2022/10/29	2025/10/28
EMI Test Receiver	Rohde & Schwarz	ESR3	102647	2023/09/18	2024/09/17
LISN/AMN	Rohde & Schwarz	ENV216	102843	2023/09/18	2024/09/17
NNLK 8129 RC	Schwarzbeck	NNLK 8129 RC	5046	2023/03/30	2024/03/29
Test Software	Farad	EZ-EMC (Ver. EMC-con-3A1 1+)	N/A	N/A	N/A

### 5.4 Conducted Emission Limit

#### Conducted Emission

Frequency(MHz)	Quasi-peak	Average
0.15-0.5	66-56	56-46
0.5-5.0	56	46
5.0-30.0	60	50

**Note:** 1. The lower limit shall apply at the transition frequencies

2. The limit decreases in line with the logarithm of the frequency in the range of 0.15 to 0.50MHz.

## 5.5 Measurement Result

Operation Mode:	TX	Test Date:	2023/12/11
Frequency Range:	0.15MHz~30MHz	Temperature:	23.5℃
Test Result:	PASS	Humidity:	51 %RH
Test By:	Reg		

**Test mode: Charging Power 15W: Output 15W**

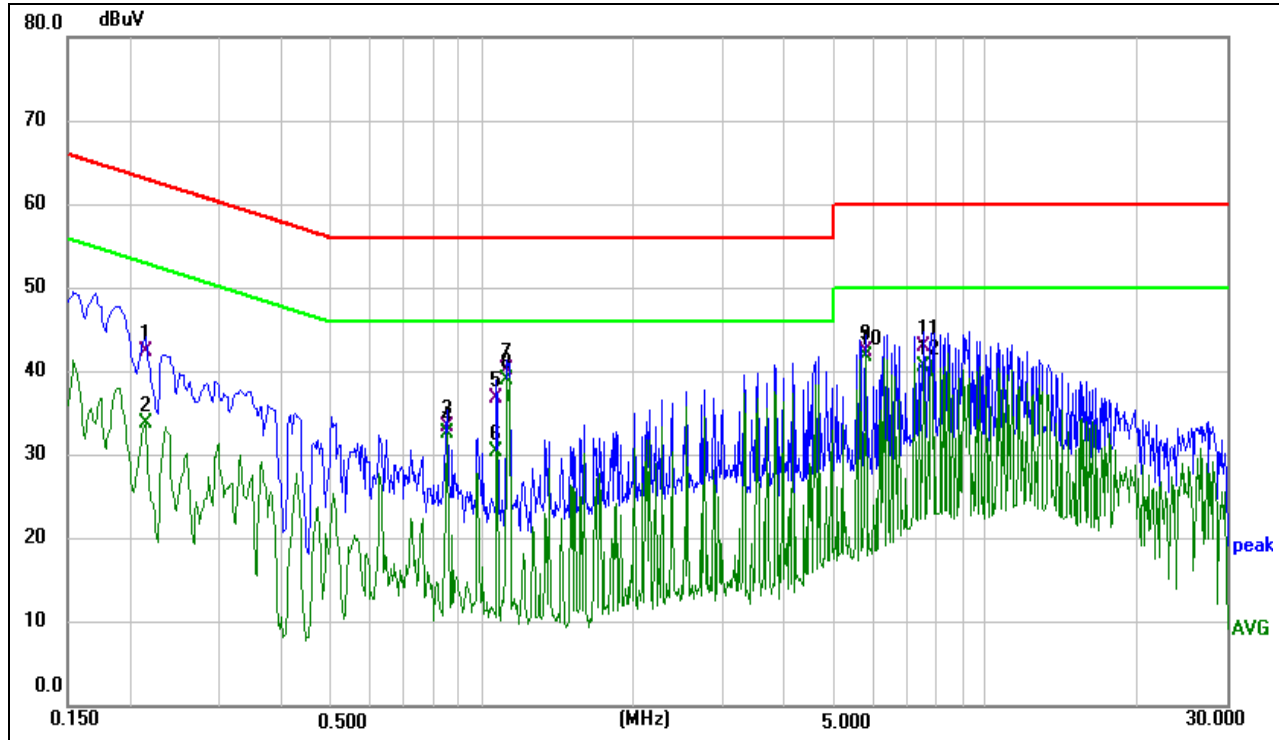

<b>Limit:</b>	<b>FCC Part 15 C Conduction(QP)</b>	<b>Phase:</b>	<b>L1</b>
<b>EUT:</b>	<b>FOLDABLE WIRELESS CHARGER</b>	<b>Test Time:</b>	<b>2023/12/11</b>
<b>M/N.:</b>	<b>2733345</b>	<b>Power Rating:</b>	<b>AC120V/60Hz</b>
<b>Mode:</b>	<b>Charging Power 15W: Output 15W</b>	<b>Test Engineer:</b>	<b>Reg</b>

No.	Frequency (MHz)	Reading (dBuV)	Correct (dB)	Result (dBuV)	Limit (dBuV)	Margin (dB)	Remark
1	0.2140	31.49	10.81	42.30	63.05	-20.75	QP
2	0.2140	23.04	10.81	33.85	53.05	-19.20	AVG
3	0.8500	23.08	10.42	33.50	56.00	-22.50	QP
4	0.8500	22.22	10.42	32.64	46.00	-13.36	AVG
5	1.0700	26.48	10.42	36.90	56.00	-19.10	QP
6	1.0700	19.99	10.42	30.41	46.00	-15.59	AVG
7	1.1180	29.78	10.42	40.20	56.00	-15.80	QP
8 *	1.1180	28.62	10.42	39.04	46.00	-6.96	AVG
9	5.7660	31.79	10.51	42.30	60.00	-17.70	QP
10	5.7660	31.29	10.51	41.80	50.00	-8.20	AVG
11	7.5220	32.30	10.60	42.90	60.00	-17.10	QP
12	7.5220	30.06	10.60	40.66	50.00	-9.34	AVG

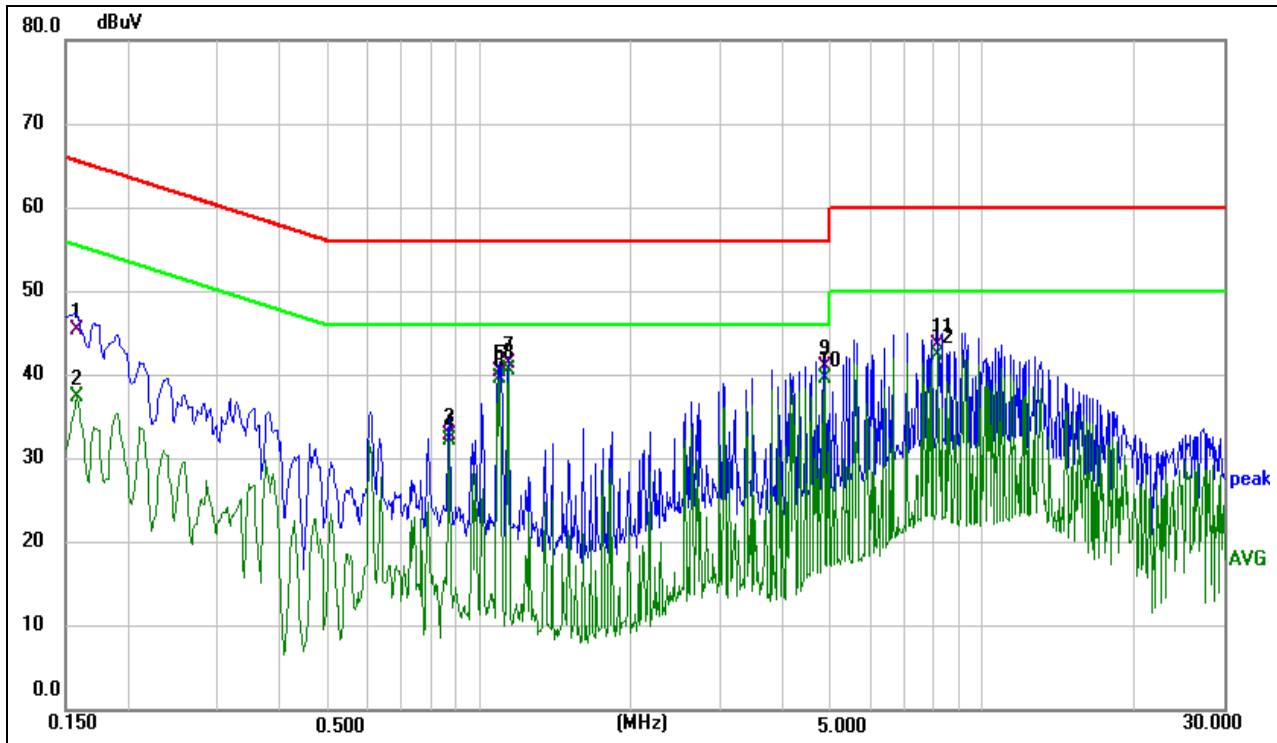

<b>Limit:</b>	<b>FCC Part 15 C Conduction(QP)</b>	<b>Phase:</b>	<b>N</b>
<b>EUT:</b>	<b>FOLDABLE WIRELESS CHARGER</b>	<b>Test Time:</b>	<b>2023/12/11</b>
<b>M/N.:</b>	<b>2733345</b>	<b>Power Rating:</b>	<b>AC120V/60Hz</b>
<b>Mode:</b>	<b>Charging Power 15W: Output 15W</b>	<b>Test Engineer:</b>	<b>Reg</b>

No.	Frequency (MHz)	Reading (dBuV)	Correct (dB)	Result (dBuV)	Limit (dBuV)	Margin (dB)	Remark
1	0.1580	34.67	10.63	45.30	65.57	-20.27	QP
2	0.1580	26.84	10.63	37.47	55.57	-18.10	AVG
3	0.8700	22.45	10.35	32.80	56.00	-23.20	QP
4	0.8700	21.82	10.35	32.17	46.00	-13.83	AVG
5	1.0940	30.05	10.35	40.40	56.00	-15.60	QP
6	1.0940	29.31	10.35	39.66	46.00	-6.34	AVG
7	1.1380	30.95	10.35	41.30	56.00	-14.70	QP
8 *	1.1380	30.22	10.35	40.57	46.00	-5.43	AVG
9	4.8620	30.49	10.41	40.90	56.00	-15.10	QP
10	4.8620	29.18	10.41	39.59	46.00	-6.41	AVG
11	8.1459	32.95	10.55	43.50	60.00	-16.50	QP
12	8.1459	31.76	10.55	42.31	50.00	-7.69	AVG

### 5.6 Conducted Measurement Photo



## 6 Radiated Emission Test

### 6.1 Measurement Procedure

1. The EUT was placed on a turntable which is 0.8m above ground plane.
2. Maximum procedure was performed on the six highest emissions to ensure EUT compliance.
3. And also, each emission was to be maximized by changing the polarization of receiving antenna both horizontal and vertical.
4. Repeat above procedures until all frequency measured were complete.

### 6.2 Test SET-UP (Block Diagram of Configuration)

(A) Radiated Emission Test Set-Up, Frequency Below 30MHz

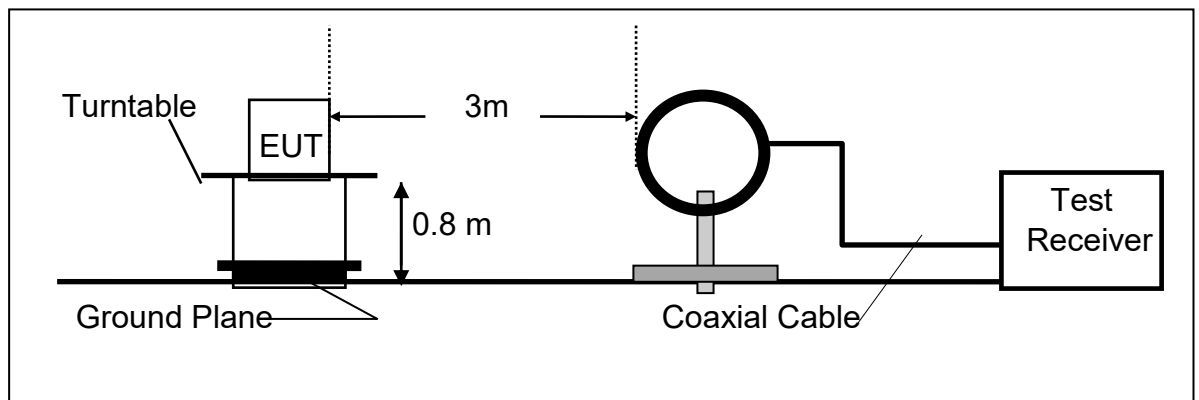

(B) Radiated Emission Test Set-Up, Frequency Below 1000MHz

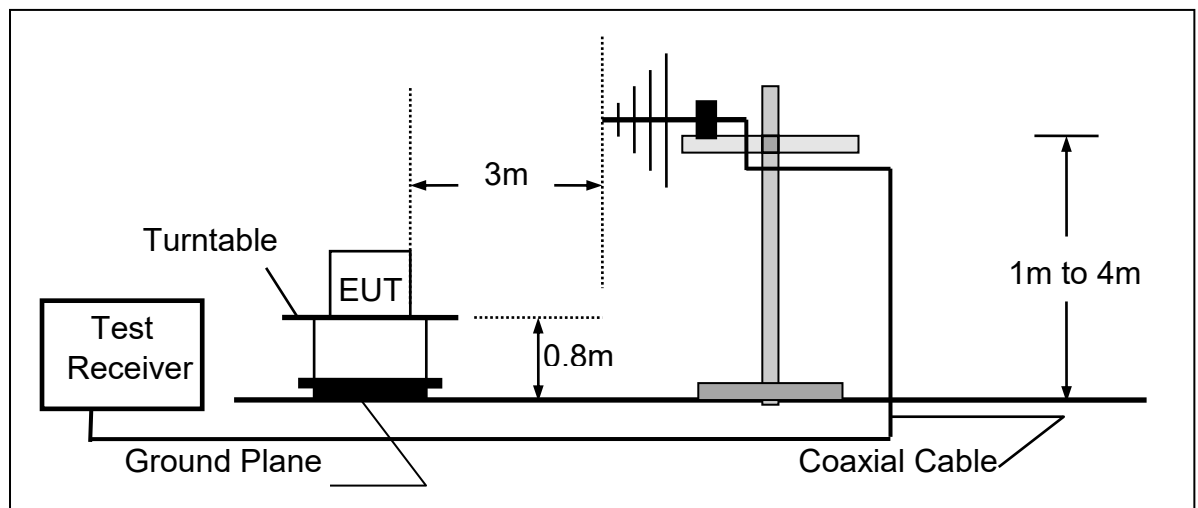

### 6.3 Measurement Equipment Used

Equipment	Manufacturer	Model No.	Serial No.	Last Cal.	Due Date
3m Semi-anechoic Chamber	ETS	9m*6m*6m	Q2146	2022/08/30	2025/08/29
EMI Test Receiver	Rohde & Schwarz	ESCI3	101409	2023/09/18	2024/09/17
Spectrum Analyzer	KEYSIGHT	N9020A	MY51283932	2023/09/18	2024/09/17
Pre-Amplifier	HzEMC	HPA-9K0130	HYP A21001	2023/09/18	2024/09/17
Biconilog Antenna	Schwarzbeck	VULB 9168	01315	2022/10/10	2025/10/09
Biconilog Antenna	ETS	3142E	00243646	2022/03/23	2025/03/22
Loop Antenna	ETS	6502	243668	2022/03/30	2025/03/29
Test Software	Farad	EZ-EMC (Ver.FA-03A2 RE)	N/A	N/A	N/A

### 6.4 Radiated Emission Limit

The emissions from an intentional radiator shall not exceed the field strength levels specified in the following table 15.209(a):

FCC Part 15.209				
Frequency (MHz)	Field Strength Limitation		Field Strength Limitation Frequency tion at 3m Measurement Dist	
	(uV/m)	Dist	(uV/m)	(dBuV/m)
0.009 – 0.490	$2400 / F(\text{KHz})$	300m	$10000 * 2400/F(\text{KHz})$	$20\log 2400/F(\text{KHz}) + 80$
0.490 – 1.705	$24000 / F(\text{KHz})$	30m	$100 * 24000/F(\text{KHz})$	$20\log 24000/F(\text{KHz}) + 40$
1.705 – 30.00	30	30m	$100 * 30$	$20\log 30 + 40$
30.0 – 88.0	100	3m	100	$20\log 100$
88.0 – 216.0	150	3m	150	$20\log 150$
216.0 – 960.0	200	3m	200	$20\log 200$
Above 960.0	500	3m	500	$20\log 500$



## 15.205 Restricted bands of operation

MHz	MHz	MHz	GHz
0.090 - 0.110	16.42 - 16.423	399.9 - 410	4.5 - 5.15
<sup>1</sup> 0.495 - 0.505	16.69475 - 16.69525	608 - 614	5.35 - 5.46
2.1735 - 2.1905	16.80425 - 16.80475	960 - 1240	7.25 - 7.75
4.125 - 4.128	25.5 - 25.67	1300 - 1427	8.025 - 8.5
4.17725 - 4.17775	37.5 - 38.25	1435 - 1626.5	9.0 - 9.2
4.20725 - 4.20775	73 - 74.6	1645.5 - 1646.5	9.3 - 9.5
6.215 - 6.218	74.8 - 75.2	1660 - 1710	10.6 - 12.7
6.26775 - 6.26825	108 - 121.94	1718.8 - 1722.2	13.25 - 13.4
6.31175 - 6.31225	123 - 138	2200 - 2300	14.47 - 14.5
8.291 - 8.294	149.9 - 150.05	2310 - 2390	15.35 - 16.2
8.362 - 8.366	156.52475 - 156.52525	2483.5 - 2500	17.7 - 21.4
8.37625 - 8.38675	156.7 - 156.9	2690 - 2900	22.01 - 23.12
8.41425 - 8.41475	162.0125 - 167.17	3260 - 3267	23.6 - 24.0
12.29 - 12.293	167.72 - 173.2	3332 - 3339	31.2 - 31.8
12.51975 - 12.52025	240 - 285	3345.8 - 3358	36.43 - 36.5
12.57675 - 12.57725	322 - 335.4	3600 - 4400	( <sup>2</sup> )

- Remark:
1. Emission level in dBuV/m=20 log (uV/m)
  2. Measurement was performed at an antenna to the closed point of EUT distance of meters.
  3. Only spurious frequency is permitted to locate within the Restricted Bands specified in provision of  $\xi$  15.205, and the emissions located in restricted bands also comply with 15.209 limit.

### 6.5 Measurement Result

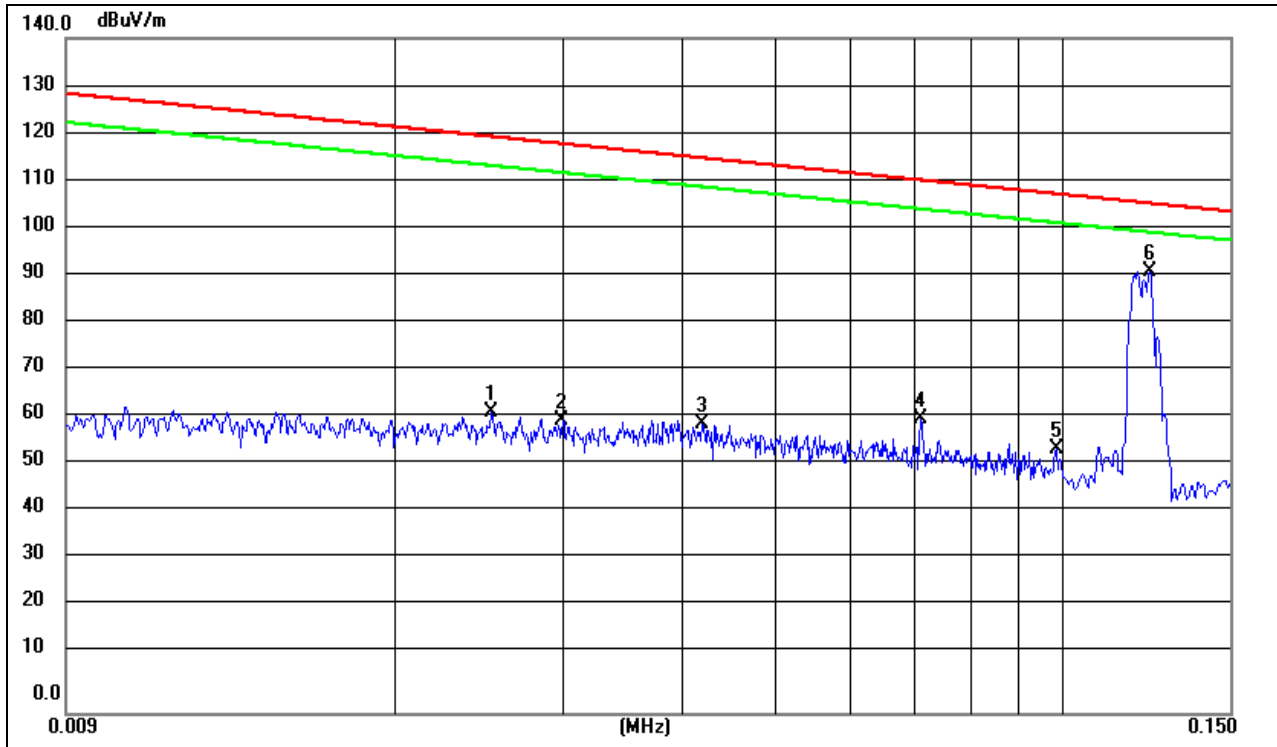

<b>Limit:</b>	<b>FCC Part 15C 3m Radiation(QP)</b>	<b>Antenna:</b>	<b>coaxial</b>
<b>EUT:</b>	<b>FOLDABLE WIRELESS CHARGER</b>	<b>Temperature:</b>	<b>24.3°C</b>
<b>M/N.:</b>	<b>2733345</b>	<b>Humidity:</b>	<b>53.2% RH</b>
<b>Mode:</b>	<b>Wireless Charging Power 15W: Output 15W</b>	<b>Power Rating:</b>	<b>AC 120V /60Hz</b>
<b>Test Engineer:</b>	<b>Ellie</b>	<b>Test Time:</b>	<b>2023/12/09</b>

No.	Frequency (MHz)	Reading (dBuV)	Factor (dB/m)	Level (dBuV/m)	Limit (dBuV/m)	Margin (dB)	Det.	Remark
1	0.0252	42.35	20.22	62.57	119.56	-56.99	peak	
2	0.0299	40.53	20.15	60.68	118.08	-57.40	peak	
3	0.0418	40.01	20.02	60.03	115.17	-55.14	peak	
4	0.0710	41.44	19.65	61.09	110.57	-49.48	peak	
5	0.0986	35.13	19.65	54.78	107.72	-52.94	peak	
6 *	0.1235	72.02	19.61	91.63	105.76	-14.13	peak	

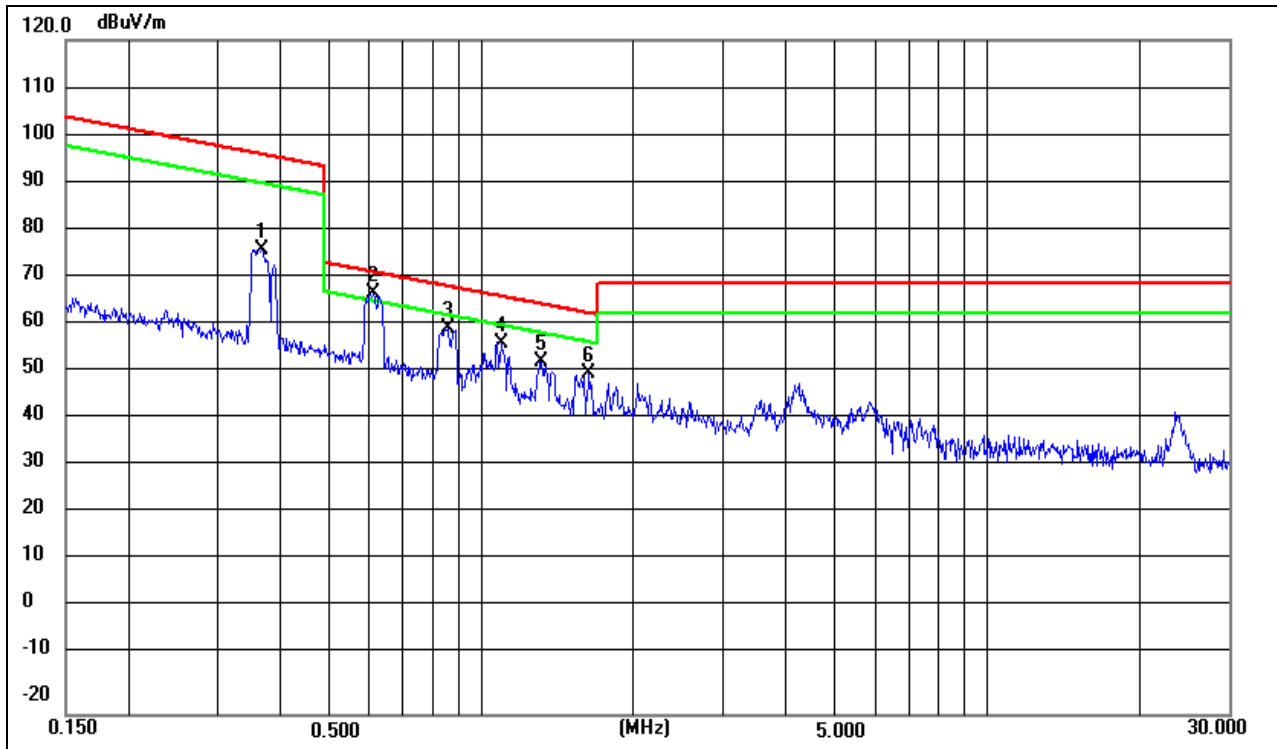

<b>Limit:</b>	<b>FCC Part 15C 3m Radiation(QP)</b>	<b>Antenna:</b>	<b>coaxial</b>
<b>EUT:</b>	<b>FOLDABLE WIRELESS CHARGER</b>	<b>Temperature:</b>	<b>24.3°C</b>
<b>M/N.:</b>	<b>2733345</b>	<b>Humidity:</b>	<b>53.2% RH</b>
<b>Mode:</b>	<b>Wireless Charging Power 15W: Output 15W</b>	<b>Power Rating:</b>	<b>AC 120V /60Hz</b>
<b>Test Engineer:</b>	<b>Ellie</b>	<b>Test Time:</b>	<b>2023/12/09</b>

No.	Frequency (MHz)	Reading (dBuV)	Factor (dB/m)	Level (dBuV/m)	Limit (dBuV/m)	Margin (dB)	Det.	Remark
1	0.3672	56.93	19.61	76.54	96.30	-19.76	peak	
2 *	0.6107	47.92	19.56	67.48	71.89	-4.41	peak	
3	0.8571	40.85	19.49	60.34	68.96	-8.62	peak	
4	1.0938	37.74	19.44	57.18	66.84	-9.66	peak	
5	1.3098	33.87	19.47	53.34	65.28	-11.94	peak	
6	1.6275	31.30	19.50	50.80	63.40	-12.60	peak	

- Note:** (1) All Readings are Peak Value.  
 (2) Emission Level= Reading Level+Probe Factor +Cable Loss.  
 (3) The average measurement was not performed when the peak measured data under the limit of average detection.  
 (4) EUT lying on the table position is the worst case result in the report.

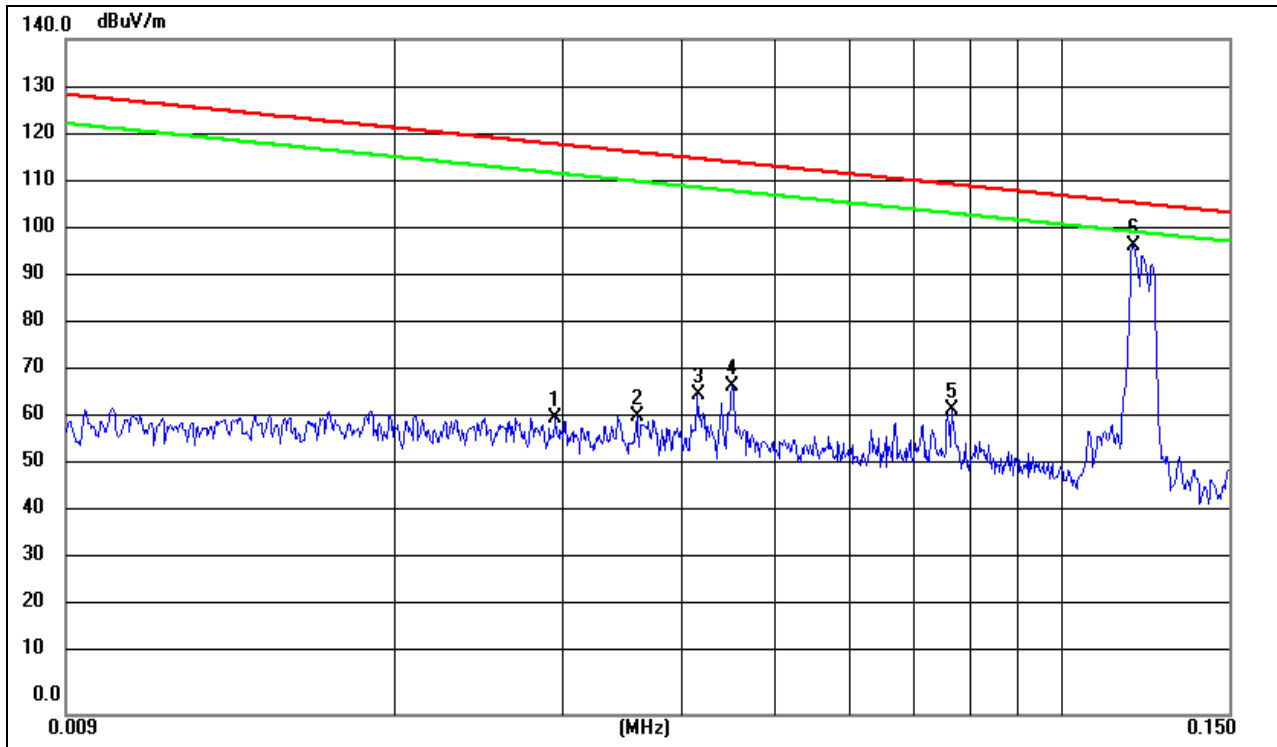

<b>Limit:</b>	<b>FCC Part 15C 3m Radiation(QP)</b>	<b>Antenna:</b>	<b>coplaner</b>
<b>EUT:</b>	<b>FOLDABLE WIRELESS CHARGER</b>	<b>Temperature:</b>	<b>24.3°C</b>
<b>M/N.:</b>	<b>2733345</b>	<b>Humidity:</b>	<b>53.2%RH</b>
<b>Mode:</b>	<b>Wireless Charging Power 15W: Output 15W</b>	<b>Power Rating:</b>	<b>AC 120V /60Hz</b>
<b>Test Engineer:</b>	<b>Ellie</b>	<b>Test Time:</b>	<b>2023/12/09</b>

No.	Frequency (MHz)	Reading (dBuV)	Factor (dB/m)	Level (dBuV/m)	Limit (dBuV/m)	Margin (dB)	Det.	Remark
1	0.0294	41.27	20.16	61.43	118.22	-56.79	peak	
2	0.0358	41.61	20.08	61.69	116.51	-54.82	peak	
3	0.0415	46.33	20.02	66.35	115.23	-48.88	peak	
4	0.0451	48.19	19.99	68.18	114.51	-46.33	peak	
5	0.0768	43.44	19.67	63.11	109.89	-46.78	peak	
6 *	0.1191	77.60	19.59	97.19	106.08	-8.89	peak	

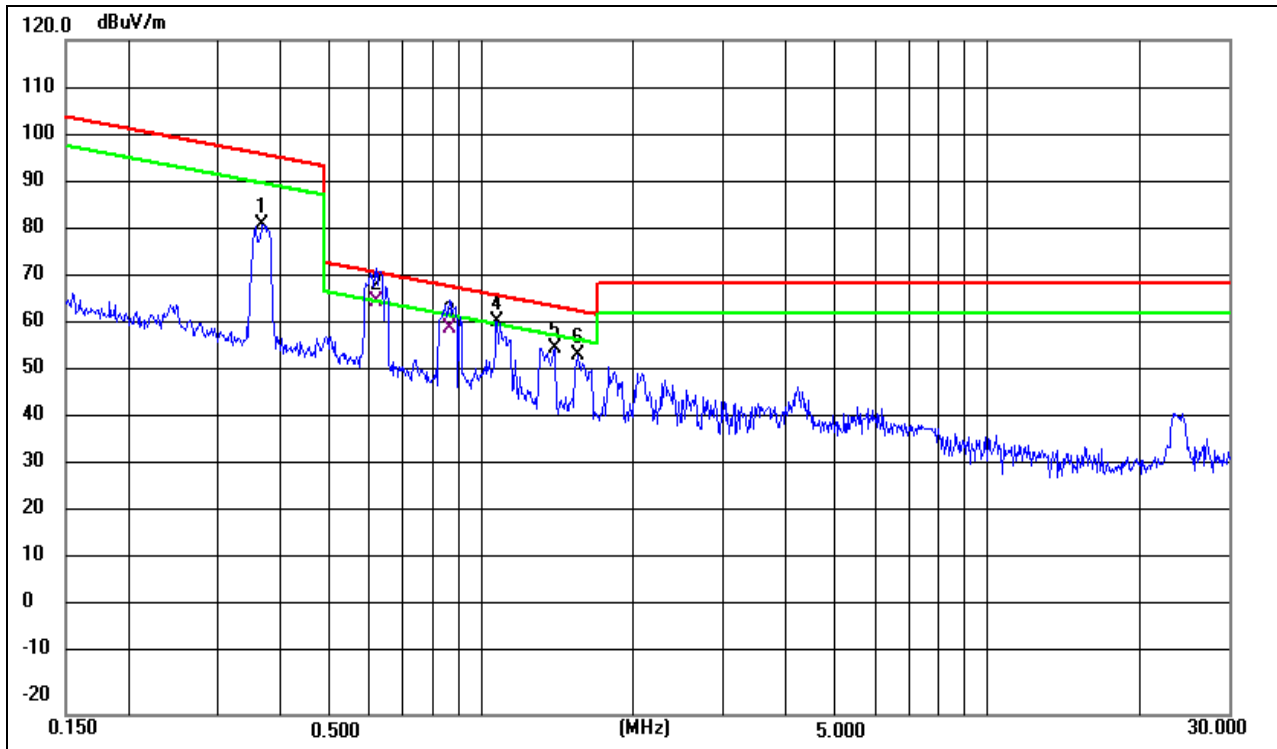

<b>Limit:</b>	<b>FCC Part 15C 3m Radiation(QP)</b>	<b>Antenna:</b>	<b>coplaner</b>
<b>EUT:</b>	<b>FOLDABLE WIRELESS CHARGER</b>	<b>Temperature:</b>	<b>24.3°C</b>
<b>M/N.:</b>	<b>2733345</b>	<b>Humidity:</b>	<b>53.2% RH</b>
<b>Mode:</b>	<b>Wireless Charging Power 15W: Output 15W</b>	<b>Power Rating:</b>	<b>AC 120V /60Hz</b>
<b>Test Engineer:</b>	<b>Ellie</b>	<b>Test Time:</b>	<b>2023/12/09</b>

No.	Frequency (MHz)	Reading (dBuV)	Factor (dB/m)	Level (dBuV/m)	Limit (dBuV/m)	Margin (dB)	Det.	Remark
1	0.3673	62.05	19.61	81.66	96.30	-14.64	peak	
2	0.6173	46.06	19.55	65.61	71.80	-6.19	QP	
3	0.8618	40.65	19.49	60.14	68.91	-8.77	QP	
4 *	1.0710	42.10	19.44	61.54	67.03	-5.49	peak	
5	1.3884	36.74	19.48	56.22	64.78	-8.56	peak	
6	1.5436	35.13	19.49	54.62	63.86	-9.24	peak	

- Note:** (1) All Readings are Peak Value.  
 (2) Emission Level= Reading Level+Probe Factor +Cable Loss.  
 (3) The average measurement was not performed when the peak measured data under the limit of average detection.  
 (4) EUT lying on the table position is the worst case result in the report.

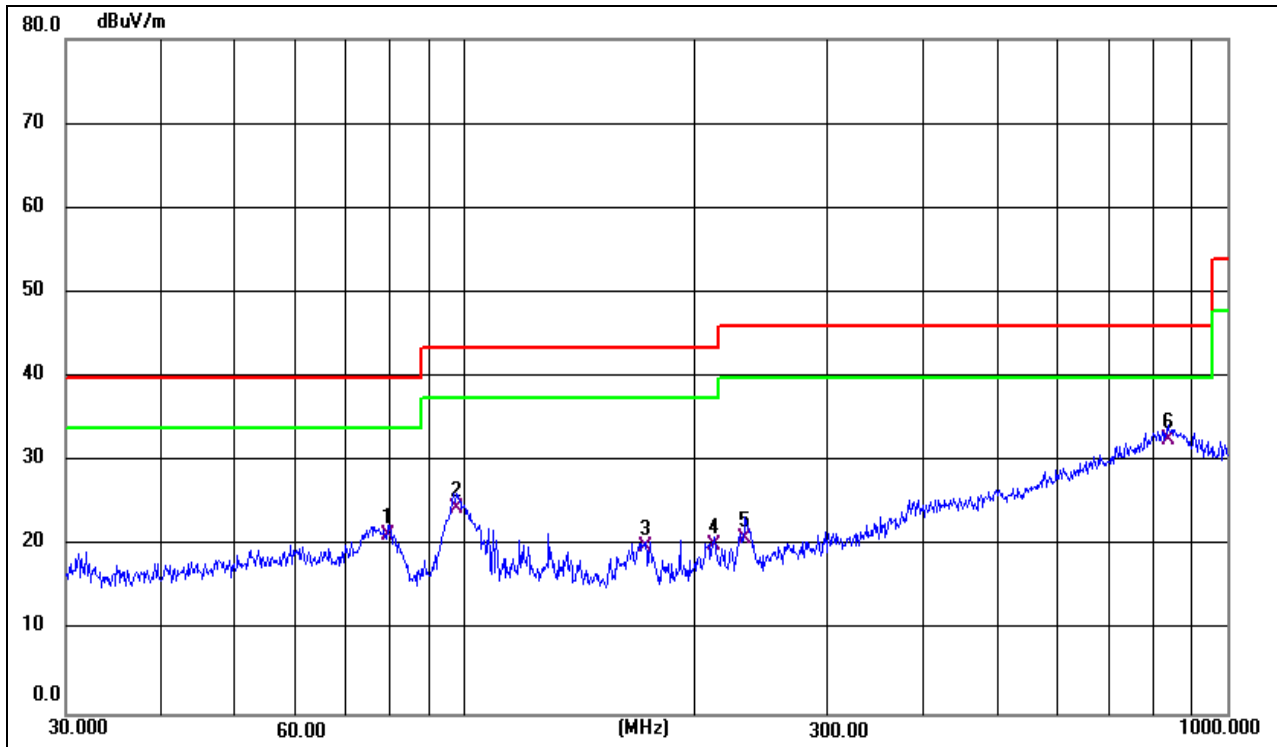

<b>Limit:</b>	<b>FCC Part 15C 3m Radiation</b>	<b>Antenna:</b>	<b>Horizontal</b>
<b>EUT:</b>	<b>FOLDABLE WIRELESS CHARGER</b>	<b>Temperature:</b>	<b>23.5°C</b>
<b>M/N.:</b>	<b>2733345</b>	<b>Humidity:</b>	<b>51% RH</b>
<b>Mode:</b>	<b>Wireless Charging Power 15W: Output 15W</b>	<b>Power Rating:</b>	<b>AC 120V /60Hz</b>
<b>Test Engineer:</b>	<b>Reg</b>	<b>Test Time:</b>	<b>2023/12/11</b>

No.	Frequency (MHz)	Reading (dBuV)	Factor (dB/m)	Level (dBuV/m)	Limit (dBuV/m)	Margin (dB)	Det.	Remark
1	79.5209	34.15	-12.85	21.30	40.00	-18.70	QP	
2	97.4560	36.59	-12.09	24.50	43.50	-19.00	QP	
3	172.5988	31.28	-11.38	19.90	43.50	-23.60	QP	
4	213.0151	31.29	-11.19	20.10	43.50	-23.40	QP	
5	233.3487	31.30	-10.50	20.80	46.00	-25.20	QP	
6 *	836.2443	27.32	5.18	32.50	46.00	-13.50	QP	

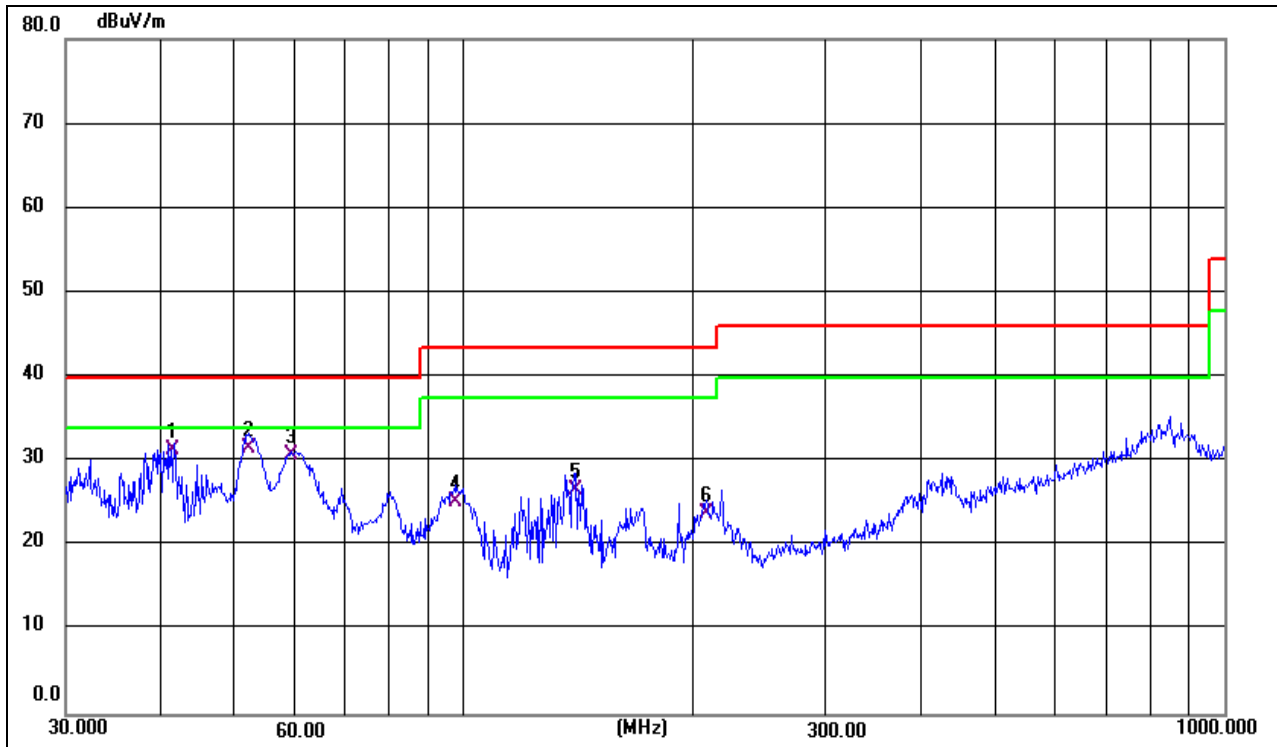

<b>Limit:</b>	<b>FCC Part 15C 3m Radiation</b>	<b>Antenna:</b>	<b>Vertical</b>
<b>EUT:</b>	<b>FOLDABLE WIRELESS CHARGER</b>	<b>Temperature:</b>	<b>23.5°C</b>
<b>M/N.:</b>	<b>2733345</b>	<b>Humidity:</b>	<b>51% RH</b>
<b>Mode:</b>	<b>Wireless Charging Power 15W: Output 15W</b>	<b>Power Rating:</b>	<b>AC 120V /60Hz</b>
<b>Test Engineer:</b>	<b>Ellie</b>	<b>Test Time:</b>	<b>2023/12/11</b>

No.	Frequency (MHz)	Reading (dBuV)	Factor (dB/m)	Level (dBuV/m)	Limit (dBuV/m)	Margin (dB)	Det.	Remark
1	41.7129	41.76	-10.36	31.40	40.00	-8.60	QP	
2 *	52.2079	40.75	-9.25	31.50	40.00	-8.50	QP	
3	59.4405	40.03	-9.33	30.70	40.00	-9.30	QP	
4	97.4560	37.39	-12.09	25.30	43.50	-18.20	QP	
5	140.3421	38.61	-11.91	26.70	43.50	-16.80	QP	
6	208.5803	35.27	-11.37	23.90	43.50	-19.60	QP	

## 6.6 Radiated Measurement Photos

9kHz-30MHz



30MHz-1GHz

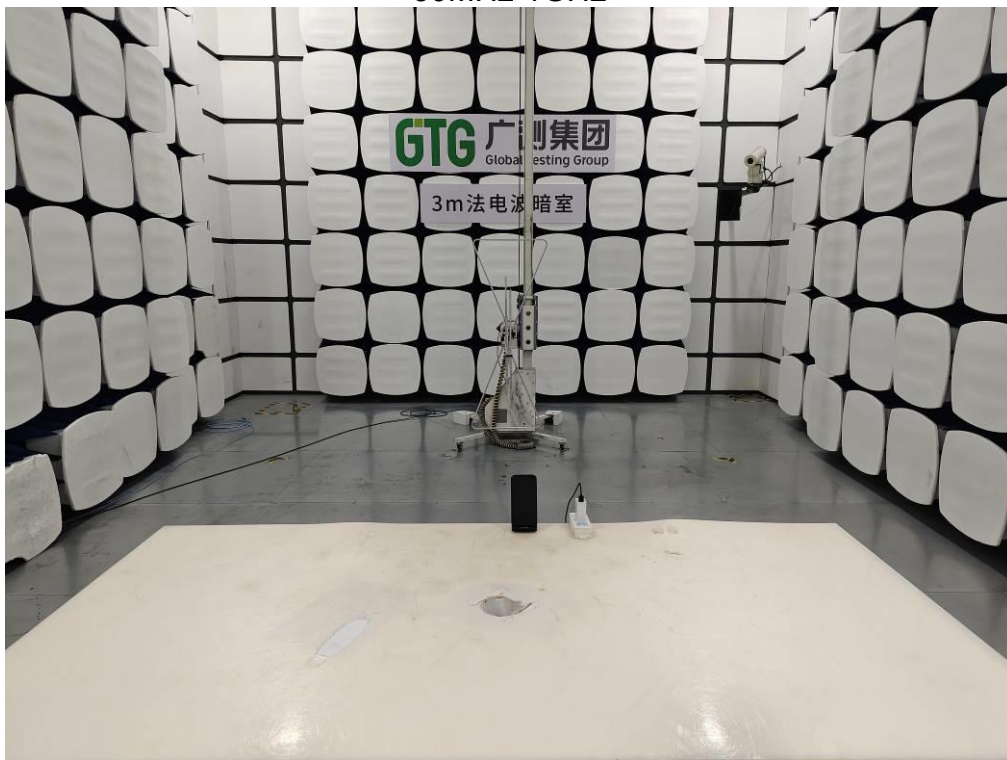



## 7 20db Bandwidth

### 7.1 20dB Bandwidth Limit

None: for reporting purposed only.

### 7.2 Test Instruments

Refer a test equipment and calibration data table in this test report.

### 7.3 Test Procedure

The bandwidth of the fundamental frequency was measured by spectrum analyzer with 1KHz RBW and 3KHz VBW. The 20dB bandwidth is defined as the total spectrum the power of which is higher than peak power minus 20dB.

### 7.4 Test Setup

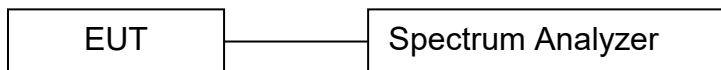

### 7.5 Test Result

Frequency (KHz)	20dB Bandwidth (KHz)	Results
113.7	2.689	PASS

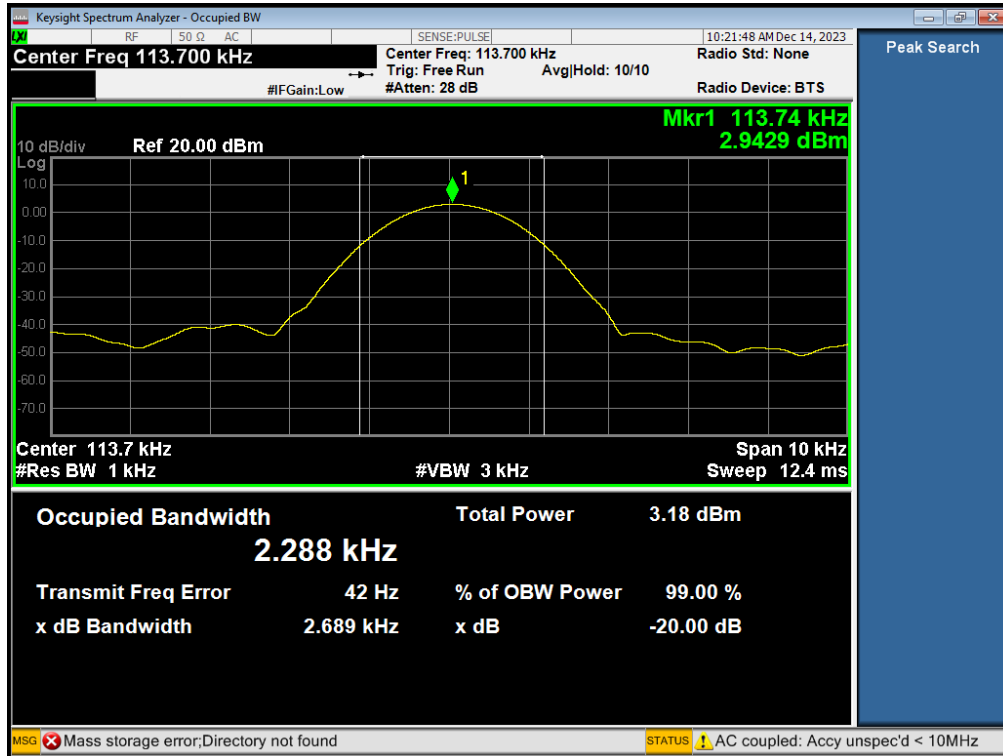

## **8 Antenna Application**

### **8.1 Antenna requirement**

For intentional device, according to FCC 47 CFR Section 15.203, an intentional radiator shall be designed to ensure that no antenna other than that furnished by the responsible party shall be used with the device.

### **8.2 Result**

The EUT's antenna, permanent attached antenna, used an Induction coil and integrated on PCB, The antenna's gain meets the requirement.

**APPENDIX**

**(Photos of EUT)**

**External-1**



**External-2**



**External-3**



**External-4**



**External-5**



**External-6**



**External-7**



**External-8**



**Internal-1**



**Internal-2**

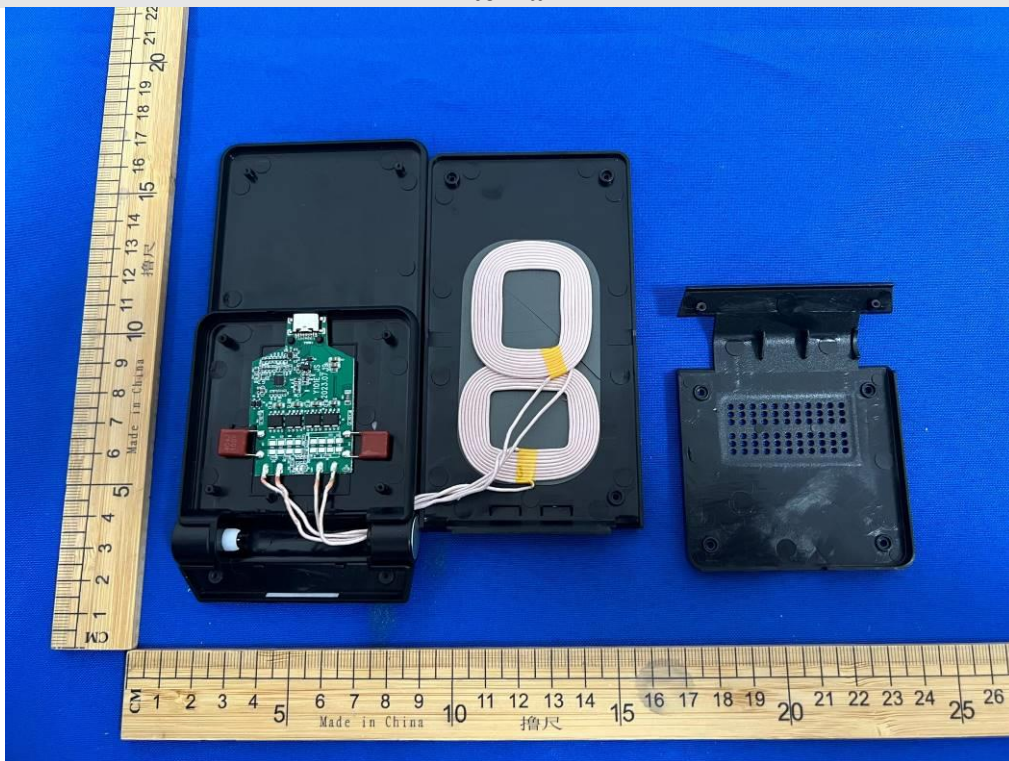



**Internal-3**

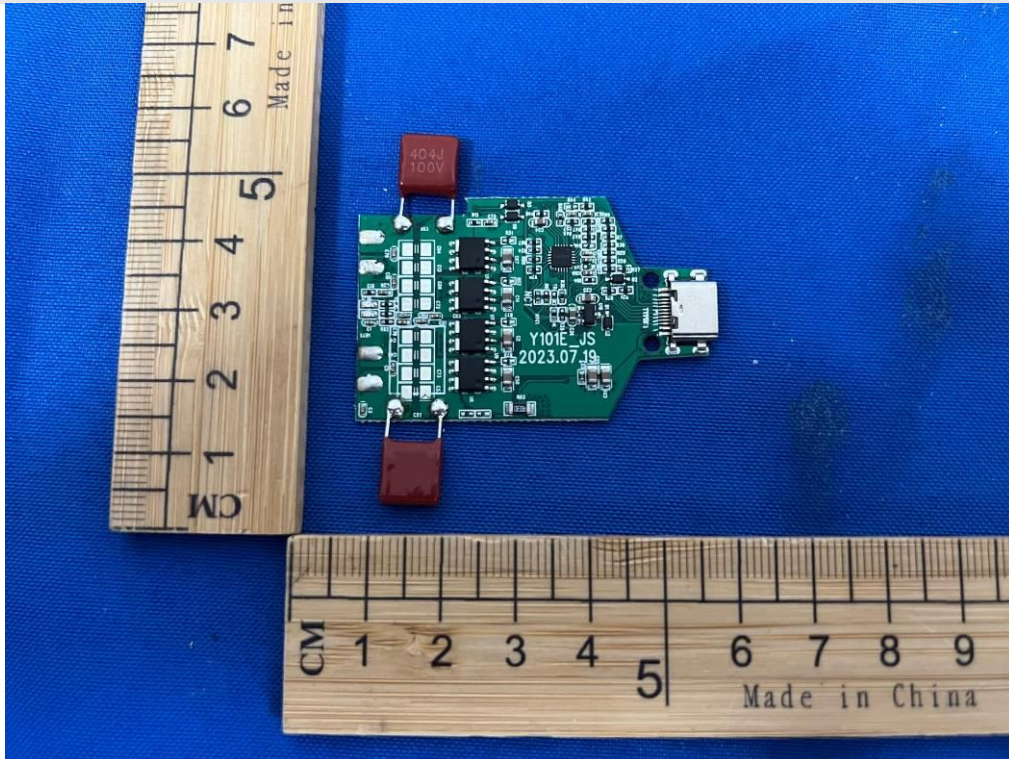

**Internal-4**

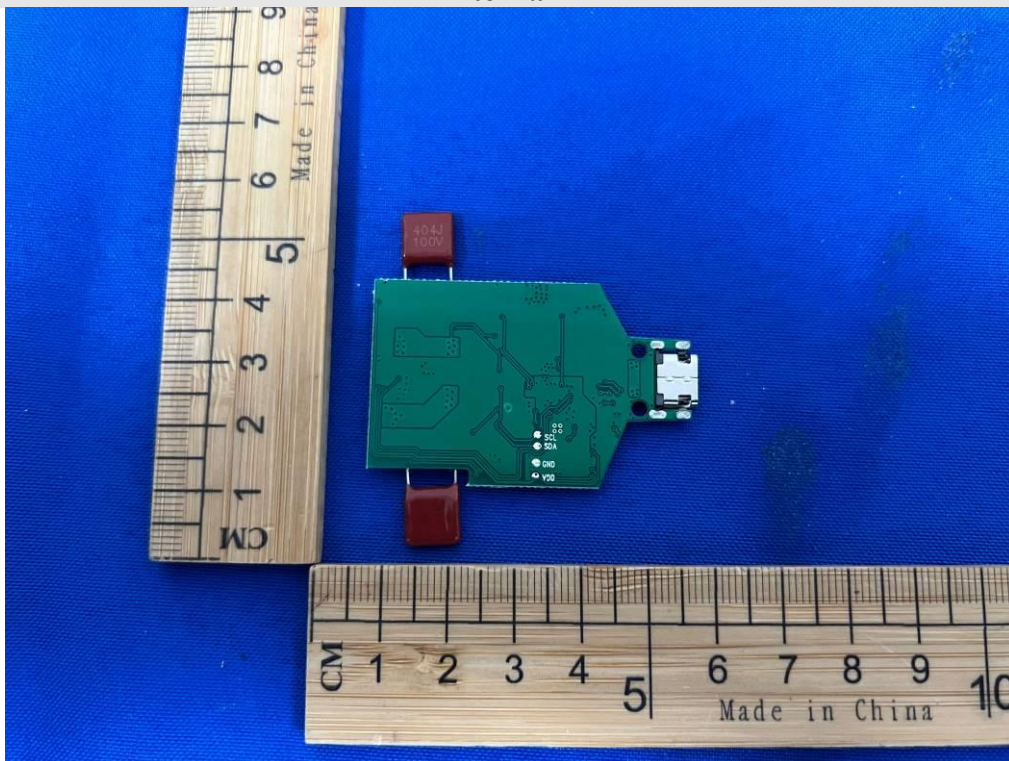

**--- END OF REPORT---**