

TEST REPORT

Report No.: BCTC2108319218-2E

Applicant: Shenzhen Viofo Technology Co., Ltd

Product Name: Car Dash Camera

Model/Type Ref.: T130 3CH

Tested Date: 2021-08-17 to 2021-09-26

Issued Date: 2021-09-28

Shenzhen BCTC Testing Co., Ltd.



FCC ID: 2AMBW-T130

Product Name: Car Dash Camera
Trademark: VIOFO
Model/Type Ref.: T130 3CH
T130 Plus , T130 Pro, T230
Prepared For: Shenzhen Viofo Technology Co., Ltd
Address: Room201, Second Floor, Factory Building NO.1, Guanghui Science and Technology Park, Minqing Rd, Longhua Street, Longhua District, Shenzhen.
Manufacturer: Shenzhen Viofo Technology Co., Ltd
Address: Room201, Second Floor, Factory Building NO.1, Guanghui Science and Technology Park, Minqing Rd, Longhua Street, Longhua District, Shenzhen.
Prepared By: Shenzhen BCTC Testing Co., Ltd.
Address: 1-2/F., Building B, Pengzhou Industrial Park, No.158, Fuyuan 1st Road, Tangwei, Fuhai Subdistrict, Bao'an District, Shenzhen, Guangdong, China
Sample Received Date: 2021-08-17
Sample tested Date: 2021-08-17 to 2021-09-26
Issue Date: 2021-09-28
Report No.: BCTC2108319218-2E
Test Standards: FCC Part15.247
ANSI C63.10-2013
Test Results: PASS
Remark: This is WIFI-2.4GHz band radio test report.

Tested by:

Eric Yang/Project Handler

Approved by:

Zero Zhou/Reviewer

The test report is effective only with both signature and specialized stamp. This result(s) shown in this report refer only to the sample(s) tested. Without written approval of Shenzhen BCTC Testing Co., Ltd, this report can't be reproduced except in full. The tested sample(s) and the sample information are provided by the client.

Table Of Content

Test Report Declaration	Page
1. Version	5
2. Test Summary	6
3. Measurement Uncertainty	7
4. Product Information And Test Setup	8
4.1 Product Information	8
4.2 Test Setup Configuration	8
4.3 Support Equipment	9
4.4 Channel List	9
4.5 Test Mode	10
5. Test Facility And Test Instrument Used	11
5.1 Test Facility	11
5.2 Test Instrument Used	11
6. Conducted Emissions	13
6.1 Block Diagram Of Test Setup	13
6.2 Limit	13
6.3 Test Procedure	13
6.4 EUT Operating Conditions	14
6.5 Test Result	14
7. Radiated Emissions	15
7.1 Block Diagram Of Test Setup	15
7.2 Limit	16
7.3 Test Procedure	17
7.4 EUT Operating Conditions	18
7.5 Test Result	19
8. Radiated Band Emission Measurement And Restricted Bands Of Operation	25
8.1 Block Diagram Of Test Setup	25
8.2 Limit	25
8.3 Test Procedure	26
8.4 EUT Operating Conditions	26
8.5 Test Result	27
9. Power Spectral Density Test	29
9.1 Block Diagram Of Test Setup	29
9.2 Limit	29
9.3 Test Procedure	29
9.4 EUT Operating Conditions	29
9.5 Test Result	30
10. Bandwidth Test	36
10.1 Block Diagram Of Test Setup	36

10.2	Limit	36
10.3	Test Procedure	36
10.4	EUT Operating Conditions	36
10.5	Test Result	37
11.	Peak Output Power Test	43
11.1	Block Diagram Of Test Setup	43
11.2	Limit	43
11.3	Test Procedure	43
11.4	EUT Operating Conditions	43
11.5	Test Result	44
12.	100 Khz Bandwidth Of Frequency Band Edge	45
12.1	Block Diagram Of Test Setup	45
12.2	Limit	45
12.3	Test Procedure	45
12.4	EUT Operating Conditions	45
12.5	Test Result	46
13.	Duty Cycle Of Test Signal	52
13.1	Standard Requirement	52
13.2	Formula	52
13.3	Test Procedure	52
13.4	Test Result	52
14.	Antenna Requirement	55
14.1	Limit	55
14.2	Test Result	55
15.	EUT Photographs	56
16.	EUT Test Setup Photographs	57

(Note: N/A Means Not Applicable)

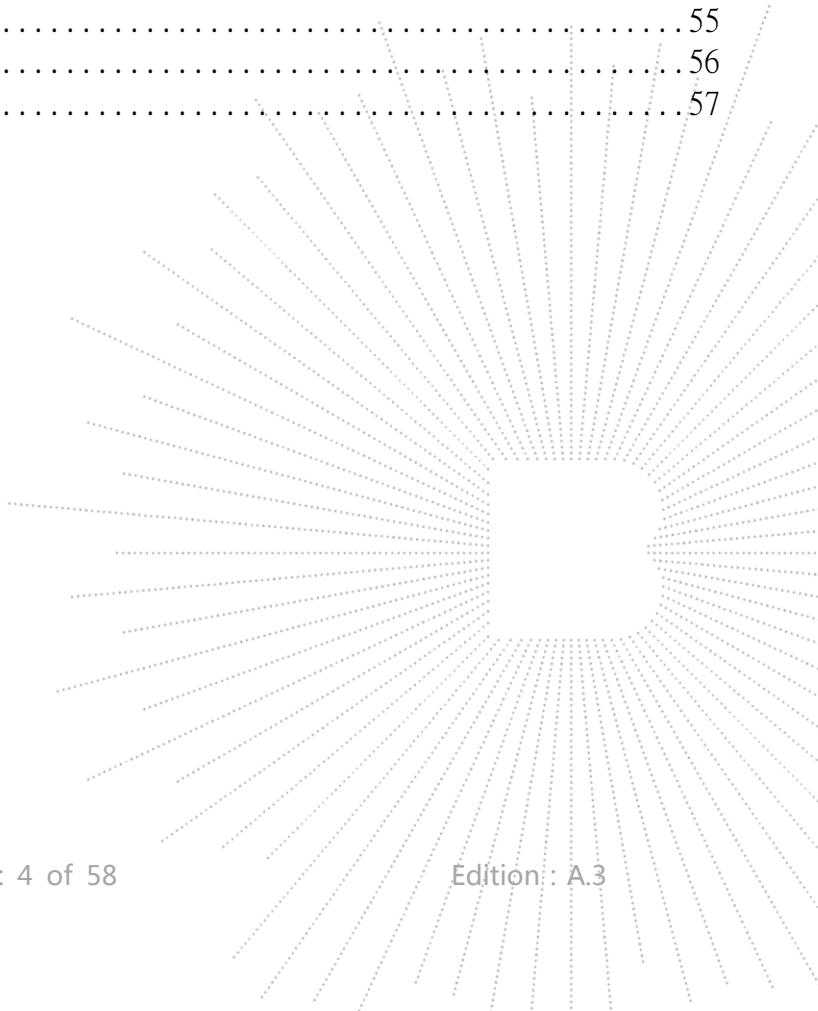

1. Version

Report No.	Issue Date	Description	Approved
BCTC2108319218-2E	2021-09-28	Original	Valid

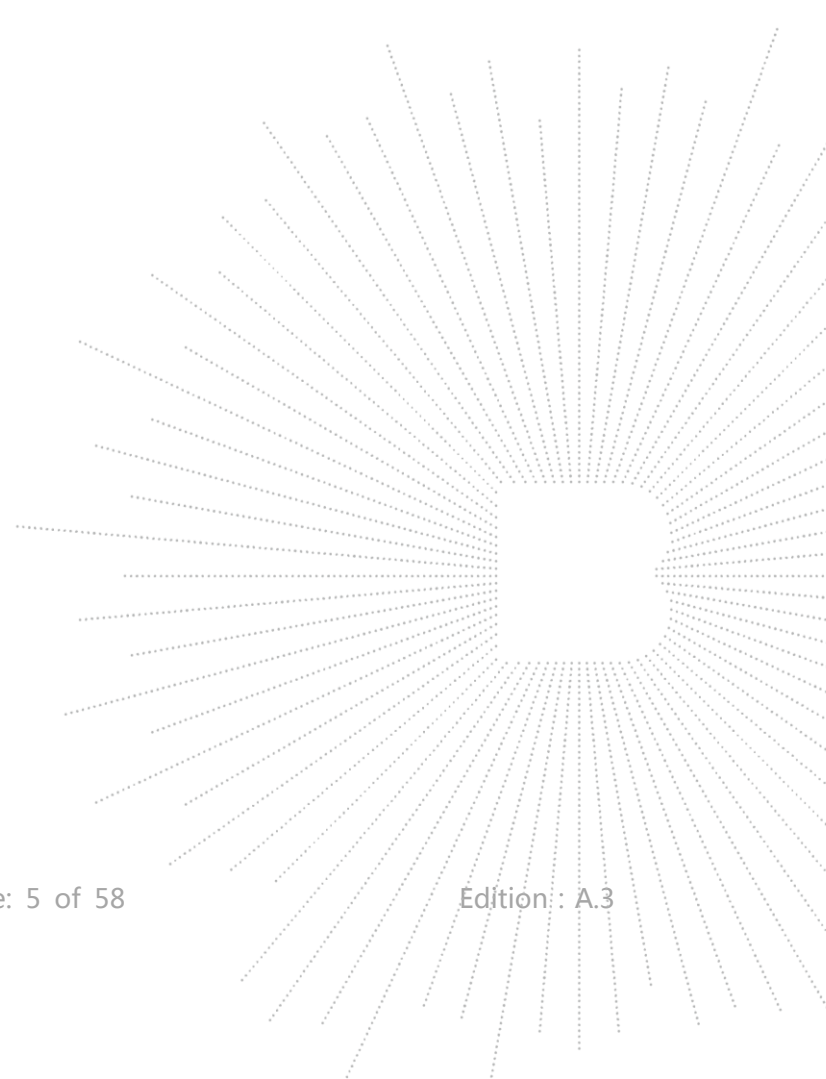

2. Test Summary

The Product has been tested according to the following specifications:

No.	Test Parameter	Clause No	Results
1	Conducted Emission	15.207	N/A
2	6dB Bandwidth	15.247 (a)(2)	PASS
3	Peak Output Power	15.247 (b)	PASS
4	Radiated Spurious Emission	15.247 (d)	PASS
5	Power Spectral Density	15.247 (e)	PASS
6	Restricted Band of Operation	15.205	PASS
7	Band Edge (Out of Band Emissions)	15.247 (d)	PASS
8	Antenna Requirement	15.203	PASS

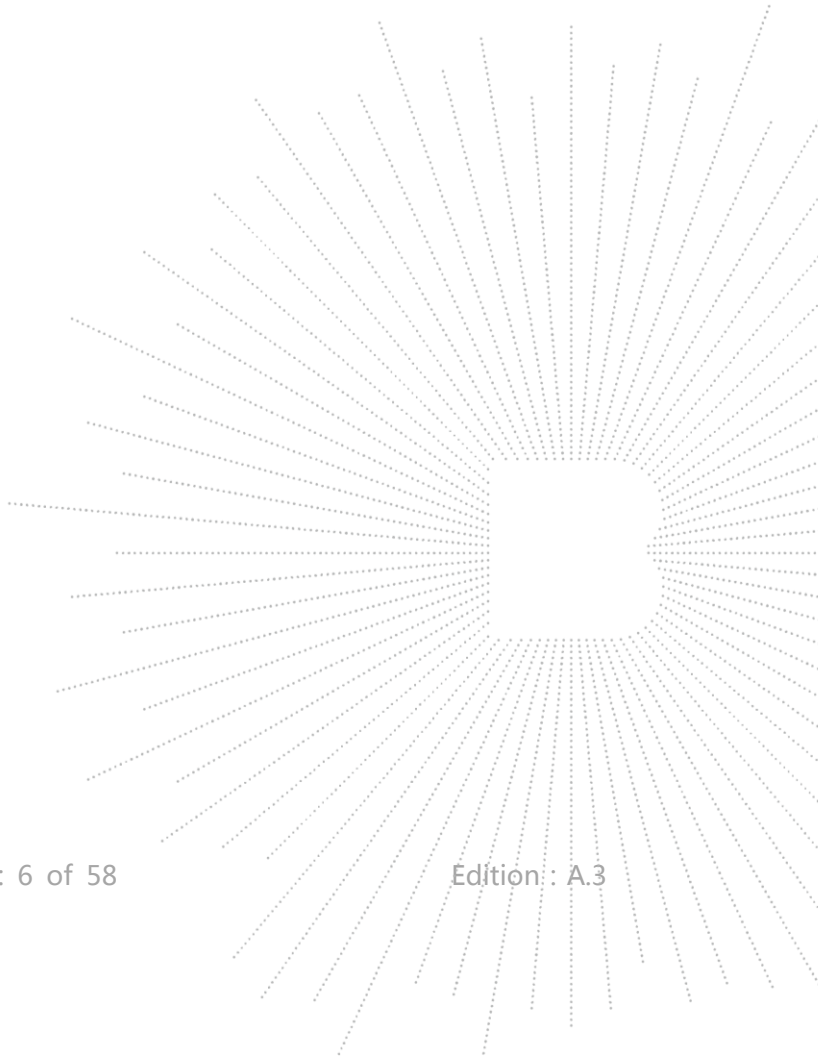

3. Measurement Uncertainty

Where relevant, the following measurement uncertainty levels have been estimated for tests performed on the Product as specified in CISPR 16-4-2. This uncertainty represents an expanded uncertainty expressed at approximately the 95% confidence level using a coverage factor of k=2.

No.	Item	Uncertainty
1	3m chamber Radiated spurious emission(9kHz-30MHz)	U=3.7dB
2	3m chamber Radiated spurious emission(30MHz-1GHz)	U=4.3dB
3	3m chamber Radiated spurious emission(1GHz-18GHz)	U=4.5dB
4	3m chamber Radiated spurious emission(18GHz-40GHz)	U=3.34dB
5	Conducted Emission(150kHz-30MHz)	U=3.20dB
6	Conducted Adjacent channel power	U=1.38dB
7	Conducted output power uncertainty Above 1G	U=1.576dB
8	Conducted output power uncertainty below 1G	U=1.28dB
9	humidity uncertainty	U=5.3%
10	Temperature uncertainty	U=0.59°C

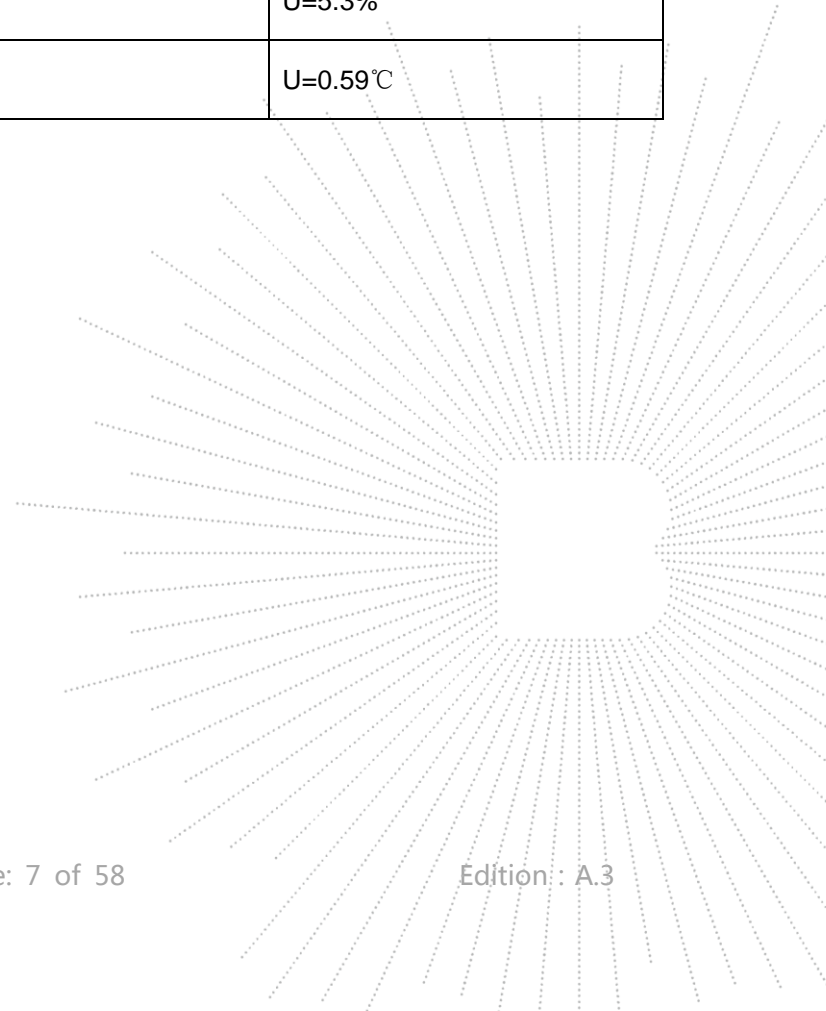

4. Product Information And Test Setup

4.1 Product Information

Model/Type Ref.:	T130 3CH T130 Plus, T130 Pro, T230
Model differences:	All the model are the same circuit and RF module, except model names.
Operation Frequency:	802.11b/g/n20MHz:2412~2462 MHz
Bit Rate of Transmitter	802.11b:11/5.5/2/1 Mbps 802.11g:54/48/36/24/18/12/9/6Mbps 802.11n Up to 75Mbps
Type of Modulation:	WIFI: OFDM/DSSS
Number Of Channel	802.11b/g/n20MHz:11 CH
Antenna installation:	FPC antenna
Antenna Gain:	1dBi
Ratings:	DC 5V 2A
Car charger:	Input: DC 12V Output: DC 5V 3A

4.2 Test Setup Configuration

See test photographs attached in *EUT TEST SETUP PHOTOGRAPHS* for the actual connections between Product and support equipment.

Radiated Spurious Emission:

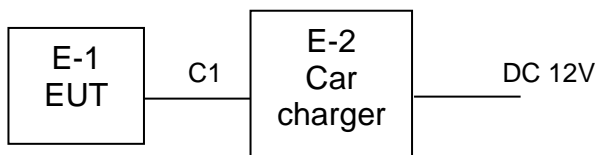

4.3 Support Equipment

No.	Device Type	Brand	Model	Series No.	Note
E-2	Car charger	N/A	CC-030N	N/A	Auxiliary

Item	Shielded Type	Ferrite Core	Length	Note
C-1	NO	NO	3M	DC cable unshielded

Notes:

1. All the equipment/cables were placed in the worst-case configuration to maximize the emission during the test.
2. Grounding was established in accordance with the manufacturer's requirements and conditions for the intended use.

4.4 Channel List

Channel List for 802.11b/g/n(20)					
Channel	Frequency (MHz)	Channel	Frequency (MHz)	Channel	Frequency (MHz)
01	2412	02	2417	03	2422
04	2427	05	2432	06	2437
07	2442	08	2447	09	2452
10	2457	11	2462		

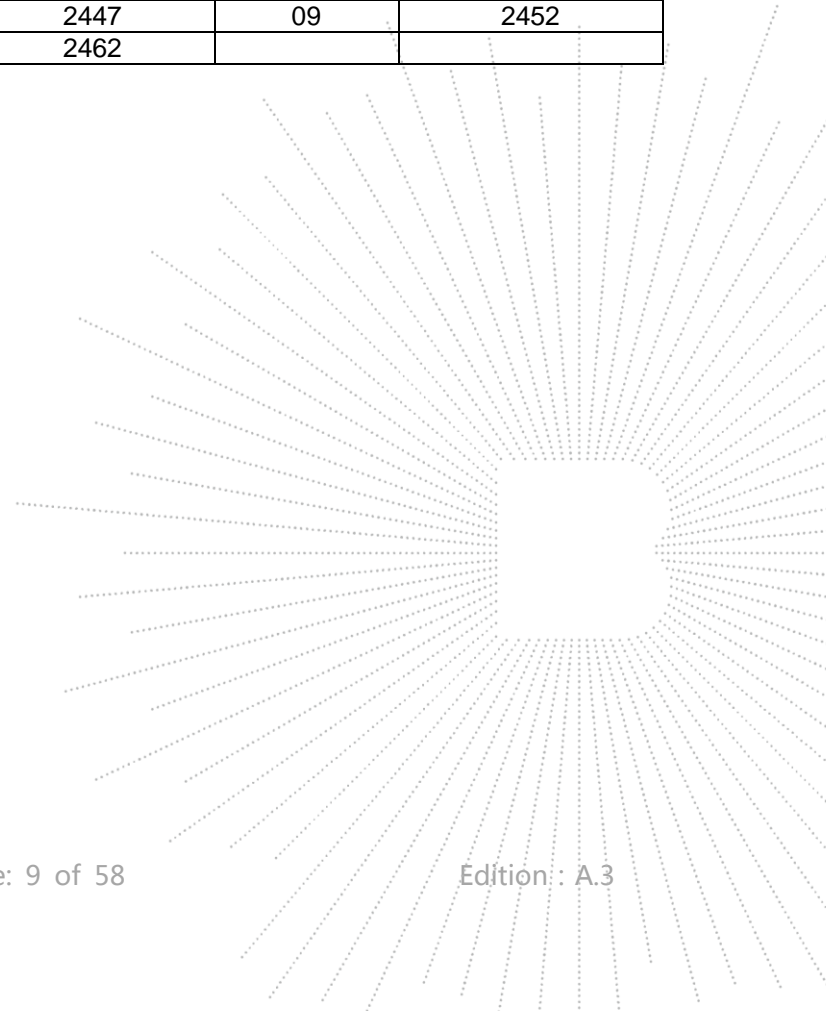

4.5 Test Mode

To investigate the maximum EMI emission characteristics generates from EUT, the test system was pre-scanning tested base on the consideration of following EUT operation mode or test configuration mode which possible have effect on EMI emission level. Each of these EUT operation mode(s) or test configuration mode(s) mentioned above was evaluated respectively.

Pretest Mode	Description
Mode 1	802.11b CH1/ CH6/ CH11
Mode 2	802.11g CH1/ CH6/ CH11
Mode 3	802.11n20 CH1/ CH6/ CH11
Mode 4	Link Mode

Radiated Emission	
Final Test Mode	Description
Mode 4	Link Mode

For Radiated Emission	
Final Test Mode	Description
Mode 1	802.11b CH1/ CH6/ CH11
Mode 2	802.11g CH1/ CH6/ CH11
Mode 3	802.11n20 CH1/ CH6/ CH11

Note:

(1) The measurements are performed at all Bit Rate of Transmitter, the worst data was reported.

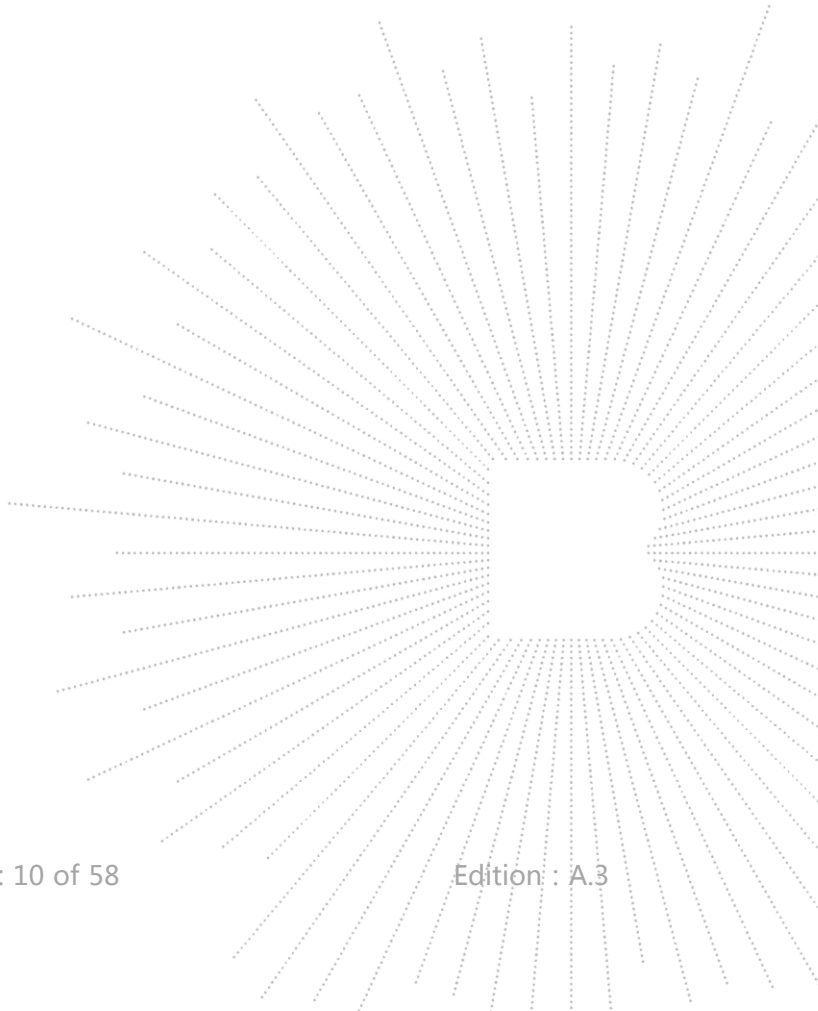

5. Test Facility And Test Instrument Used

5.1 Test Facility

All measurement facilities used to collect the measurement data are located at Shenzhen BCTC Testing Co., Ltd. Address: 1-2/F., Building B, Pengzhou Industrial Park, No.158, Fuyuan 1st Road, Tangwei, Fuhai Subdistrict, Bao'an District, Shenzhen, Guangdong, China. The site and apparatus are constructed in conformance with the requirements of ANSI C63.4 and CISPR 16-1-1 other equivalent standards.

FCC Test Firm Registration Number: 712850

IC Registered No.: 23583

5.2 Test Instrument Used

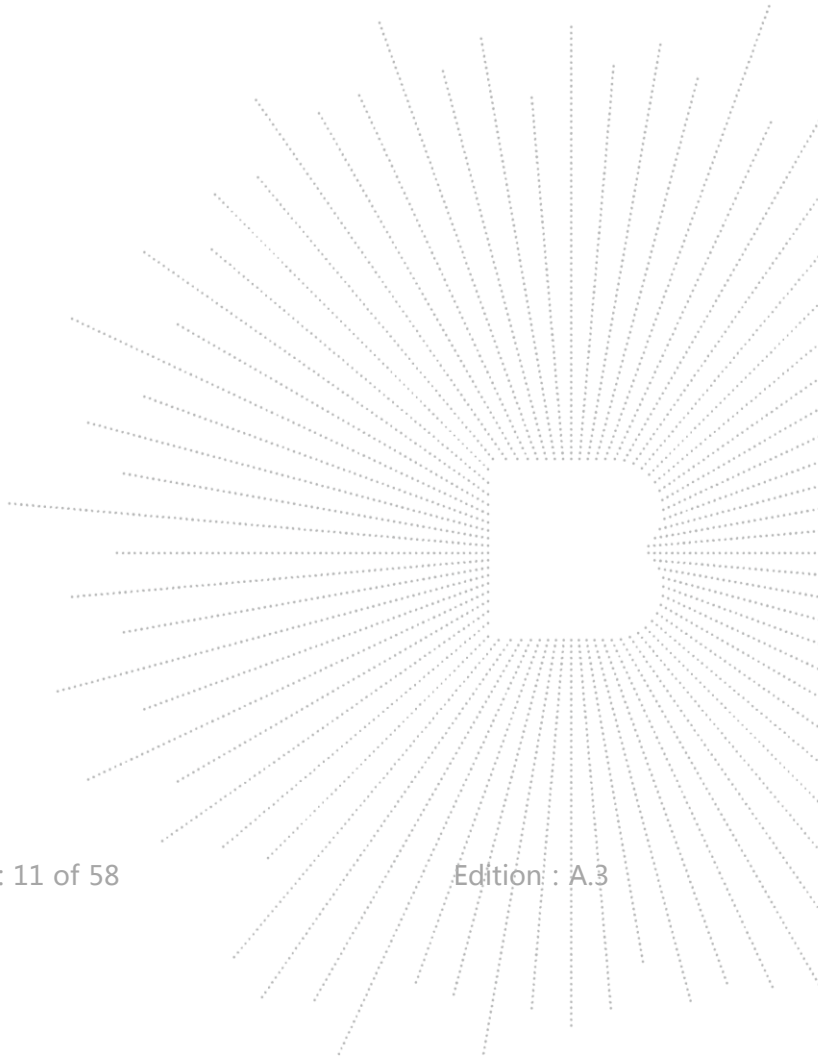

Radiated emissions Test (966 chamber)					
Equipment	Manufacturer	Model#	Serial#	Last Cal.	Next Cal.
966 chamber	ChengYu	966 Room	966	Jun. 06. 2020	Jun. 05, 2023
Receiver	R&S	ESR3	102075	May 28, 2021	May 27, 2022
Receiver	R&S	ESRP	101154	May 28, 2021	May 27, 2022
Amplifier	SKET	LAPA_01G18 G-45dB	\	May 28, 2021	May 27, 2022
Amplifier	Schwarzbeck	BBV9744	9744-0037	May 28, 2021	May 27, 2022
TRILOG Broadband Antenna	schwarzbeck	VULB 9163	VULB9163-9 42	Jun. 01, 2021	May 31, 2022
Horn Antenna	SCHWARZBECK	BBHA9120D	1541	Jun. 02, 2021	Jun. 01, 2022
Horn Antenna (18GHz-40GHz)	SCHWARZBECK	BBHA9170	822	Jun. 15, 2021	Jun. 14, 2022
Amplifier (18GHz-40GHz)	MITEQ	TTA1840-35- HG	2034381	May 28, 2021	May 27, 2022
Loop Antenna (9kHz-30MHz)	SCHWARZBECK	FMZB1519B	014	Jun. 02, 2021	Jun. 01, 2022
RF cables1 (9kHz-30MHz)	Huber+Suhnar	9kHz-30MHz	B1702988-00 08	May 28, 2021	May 27, 2022
RF cables2 (30MHz-1GHz)	Huber+Suhnar	30MHz-1GHz	1486150	May 28, 2021	May 27, 2022
RF cables3 (1GHz-40GHz)	Huber+Suhnar	1GHz-40GHz	1607106	May 28, 2021	May 27, 2022
Power Metter	Keysight	E4419B	\	May 28, 2021	May 27, 2022
Power Sensor (AV)	Keysight	E9 300A	\	May 28, 2021	May 27, 2022
Signal Analyzer 20kHz-26.5GHz	KEYSIGHT	N9020A	MY49100060	May 28, 2021	May 27, 2022
Spectrum Analyzer 9kHz-40GHz	R&S	FSP40	100363	May 28, 2021	May 27, 2022
Software	Frad	EZ-EMC	FA-03A2 RE	\	\

6. Conducted Emissions

6.1 Block Diagram Of Test Setup

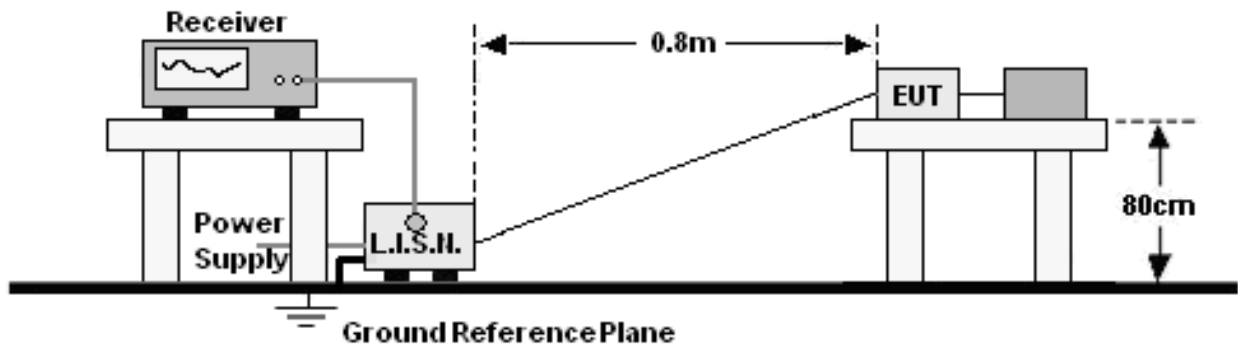

6.2 Limit

FREQUENCY (MHz)	Limit (dBuV)	
	Quas-peak	Average
0.15 -0.5	66 - 56 *	56 - 46 *
0.50 -5.0	56.00	46.00
5.0 -30.0	60.00	50.00

Notes:

- *Decreasing linearly with logarithm of frequency.
- The lower limit shall apply at the transition frequencies.

6.3 Test Procedure

Receiver Parameters	Setting
Attenuation	10 dB
Start Frequency	0.15 MHz
Stop Frequency	30 MHz
IF Bandwidth	9 kHz

a. The Product was placed on a nonconductive table 0.8 m above the horizontal ground reference plane, and 0.4 m from the vertical ground reference plane, and connected to the main through Line Impedance Stability Network (L.I.S.N).

b. The RBW of the receiver was set at 9 kHz in 150 kHz ~ 30MHz with Peak and AVG detector in Max Hold mode. Run the receiver's pre-scan to record the maximum disturbance generated from Product in all power lines in the full band.

c. For each frequency whose maximum record was higher or close to limit, measure its QP and AVG values and record.

6.4 EUT Operating Conditions

The EUT was configured for testing in a typical fashion (as a customer would normally use it). The EUT has been programmed to continuously transmit during test. This operating condition was tested and used to collect the included data.

6.5 Test Result

The EUT is powered by the DC only and has no antenna port, the test item is not applicable.

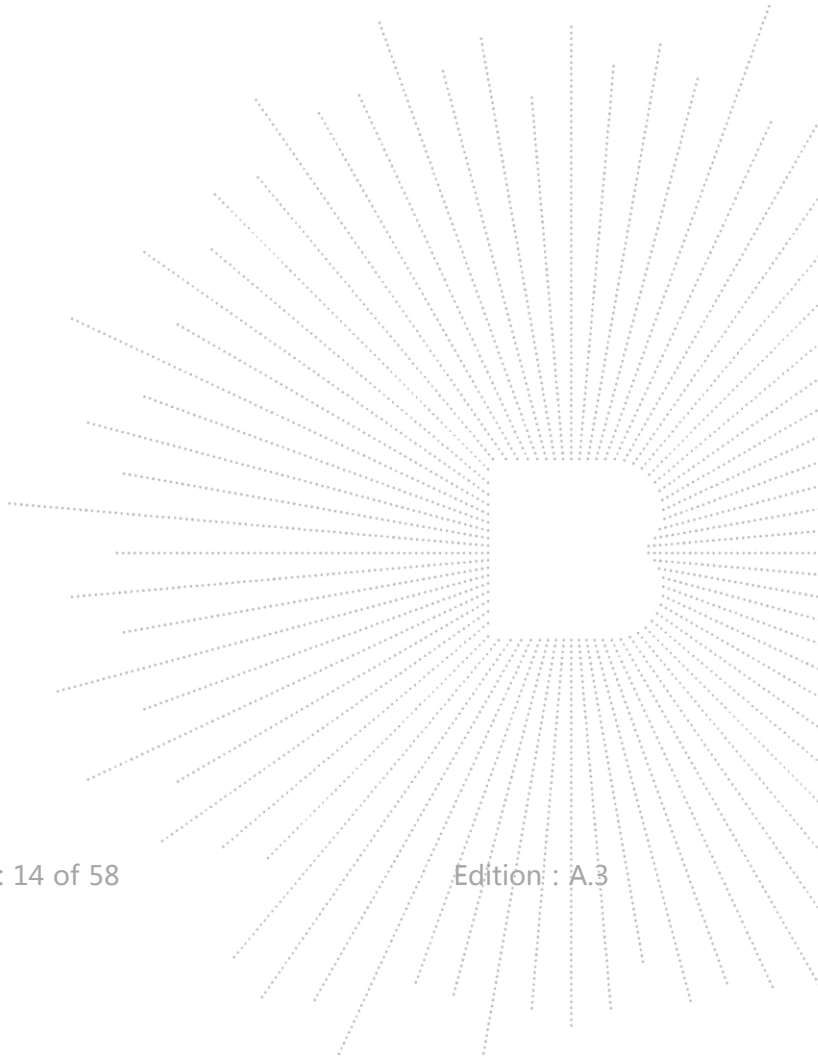

7. Radiated Emissions

7.1 Block Diagram Of Test Setup

(A) Radiated Emission Test-Up Frequency Below 30MHz

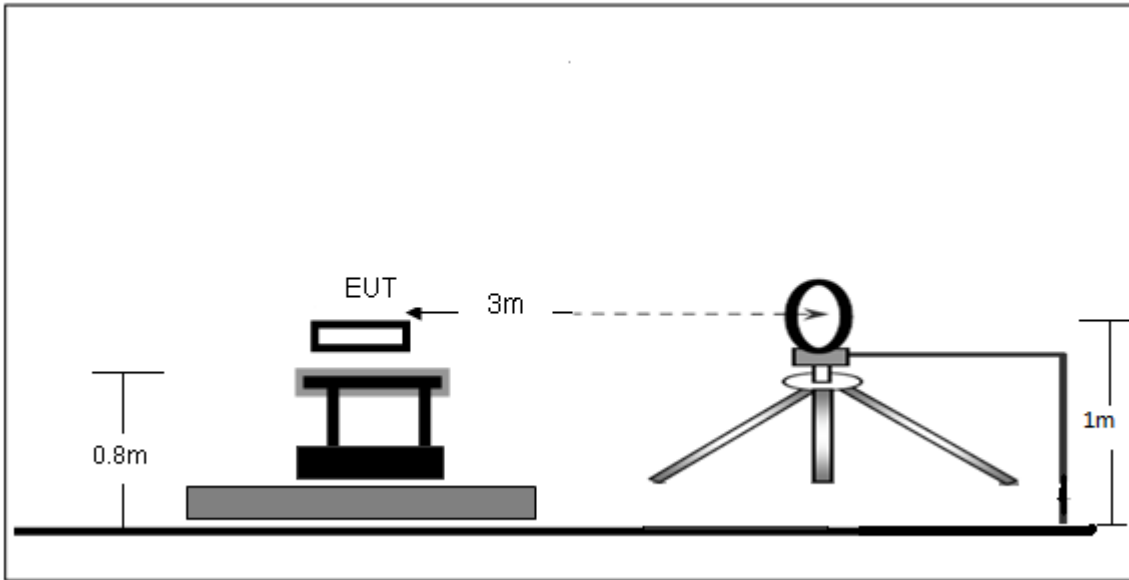

(B) Radiated Emission Test-Up Frequency 30MHz~1GHz

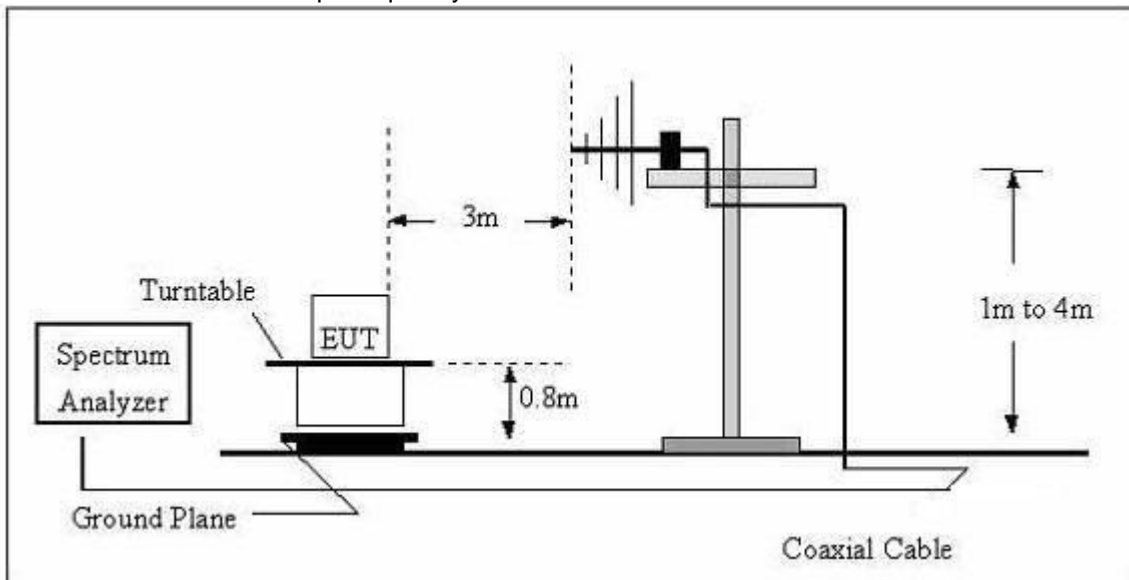

(C) Radiated Emission Test-Up Frequency Above 1GHz

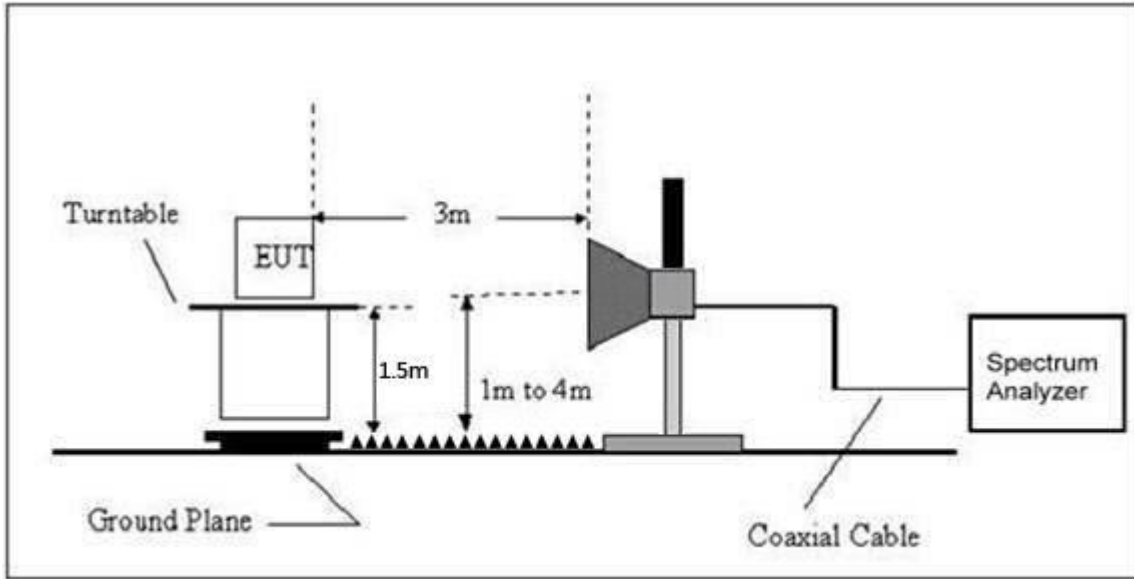

7.2 Limit

20dBc in any 100 kHz bandwidth outside the operating frequency band. In case the emission fall within the restricted band specified on 15.205(a), then the 15.209(a) limit in the table below has to be followed.

Frequency (MHz)	Field Strength uV/m	Distance (m)	Field Strength Limit at 3m Distance	
			uV/m	dBuV/m
0.009 ~ 0.490	2400/F(kHz)	300	10000 * 2400/F(kHz)	20log ^{(2400/F(kHz))} + 80
0.490 ~ 1.705	24000/F(kHz)	30	100 * 24000/F(kHz)	20log ^{(24000/F(kHz))} + 40
1.705 ~ 30	30	30	100 * 30	20log ⁽³⁰⁾ + 40
30 ~ 88	100	3	100	20log ⁽¹⁰⁰⁾
88 ~ 216	150	3	150	20log ⁽¹⁵⁰⁾
216 ~ 960	200	3	200	20log ⁽²⁰⁰⁾
Above 960	500	3	500	20log ⁽⁵⁰⁰⁾

LIMITS OF RADIATED EMISSION MEASUREMENT (Above 1000MHz)

FREQUENCY (MHz)	Limit (dBuV/m) (at 3M)	
	PEAK	AVERAGE
Above 1000	74	54

Notes:

- (1) The limit for radiated test was performed according to FCC PART 15C.
- (2) The tighter limit applies at the band edges.
- (3) Emission level (dBuV/m)=20log Emission level (uV/m).

FREQUENCY RANGE OF RADIATED MEASUREMENT (For unintentional radiators)

Highest frequency generated or Upper frequency of measurement used in the device or on which the device operates or tunes (MHz)	Range (MHz)
Below 1.705	30
1.705 – 108	1000
108 – 500	2000
500 – 1000	5000
Above 1000	5 th harmonic of the highest frequency or 40 GHz, whichever is lower

7.3 Test Procedure

Receiver Parameter	Setting
Attenuation	Auto
9kHz~150kHz	RBW 200Hz for QP
150kHz~30MHz	RBW 9kHz for QP
30MHz~1000MHz	RBW 120kHz for QP

Spectrum Parameter	Setting
1-25GHz	RBW 1 MHz /VBW 1 MHz for Peak, RBW 1 MHz / VBW 10Hz for Average

Below 1GHz test procedure as below:

- a. The EUT was placed on the top of a rotating table 0.8 meters above the ground at a 3 meter semi-anechoic chamber. The table was rotated 360 degrees to determine the position of the highest radiation.
- b. The EUT was set 3 meters away from the interference-receiving antenna, which was mounted on the top of a variable-height antenna tower.
- c. The antenna height is varied from one meter to four meters above the ground to determine the maximum value of the field strength. Both horizontal and vertical polarizations of the antenna are set to make the measurement.
- d. For each suspected emission, the EUT was arranged to its worst case and then the antenna was tuned to heights from 1 meter to 4 meters (for the test frequency of below 30MHz, the antenna was tuned to heights 1 meter) and the rotatable table was turned from 0 degrees to 360 degrees to find the maximum reading.
- e. The test-receiver system was set to Peak Detect Function and Specified Bandwidth with Maximum Hold Mode.
- f. If the emission level of the EUT in peak mode was 10dB lower than the limit specified, then testing could be stopped and the peak values of the EUT would be reported. Otherwise the emissions that did not have 10dB margin would be re-tested one by one using peak, quasi-peak or average method as specified and then reported in a data sheet.

Above 1GHz test procedure as below:

g. Different between above is the test site, change from Semi- Anechoic Chamber to fully Anechoic Chamber and change form table 0.8 metre to 1.5 metre(Above 18GHz the distance is 1 meter and table is 1.5 metre).

h. Test the EUT in the lowest channel ,the middle channel ,the Highest channel.

Note:

Both horizontal and vertical antenna polarities were tested and performed pretest to three orthogonal axis. The worst case emissions were reported.

Above 1GHz test procedure as below:

a. The EUT was placed on the top of a rotating table 1.5 meters above the ground at a 3 meter chamber. The table was rotated 360 degrees to determine the position of the highest radiation.

b. The EUT was set 3 meters away from the interference-receiving antenna, which was mounted on the top of a variable-height antenna tower.

c. The antenna height is varied from one meter to four meters above the ground to determine the maximum value of the field strength. Both horizontal and vertical polarizations of the antenna are set to make the measurement.

d. For each suspected emission, the EUT was arranged to its worst case and then the antenna was tuned to heights from 1 meter to 4 meters and the rota table was turned from 0 degrees to 360 degrees to find the maximum reading.

e. The test-receiver system was set to Peak Detect Function and Specified Bandwidth with Maximum Hold Mode.

f. If the emission level of the EUT in peak mode was 10dB lower than the limit specified, then testing could be stopped and the peak values of the EUT would be reported. Otherwise the emissions that did not have 10dB margin would be re-tested one by one using peak, quasi-peak or average method as specified and then reported in a data sheet.

g. Test the EUT in the lowest channel, the Highest channel.

Note:

Both horizontal and vertical antenna polarities were tested and performed pretest to three orthogonal axis. The worst case emissions were reported.

7.4 EUT Operating Conditions

The EUT was configured for testing in a typical fashion (as a customer would normally use it). The EUT has been programmed to continuously transmit during test. This operating condition was tested and used to collect the included data.

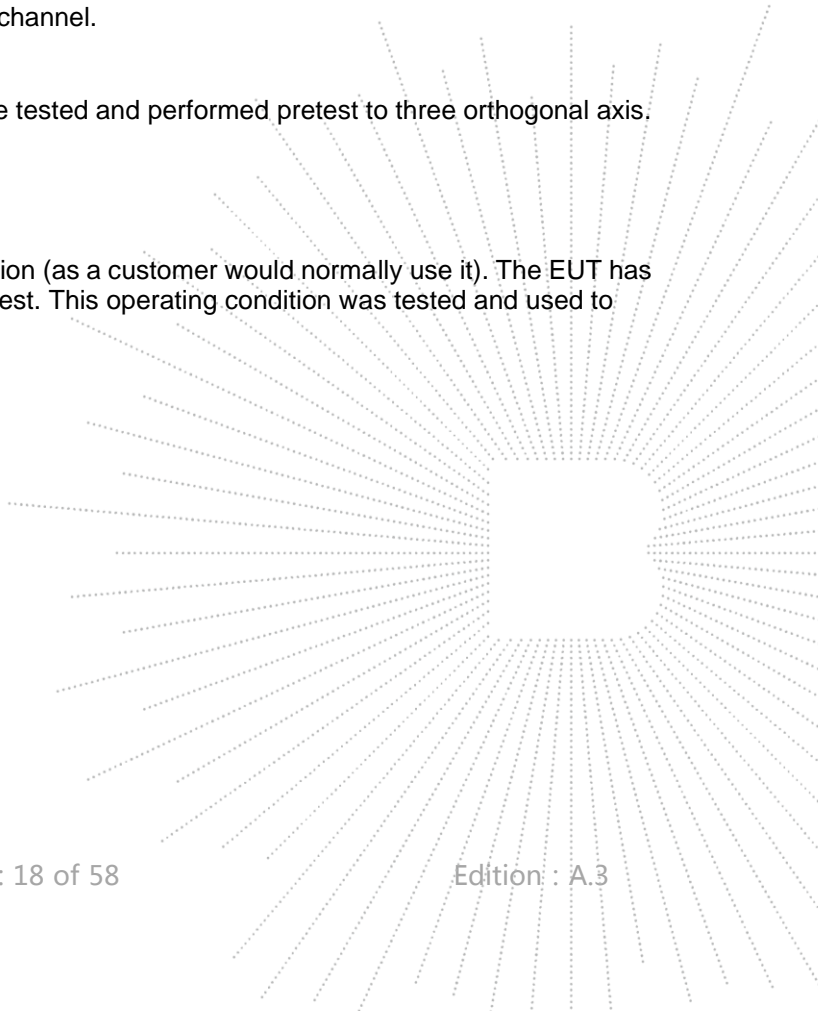

7.5 Test Result

Below 30MHz

Temperature:	26°C	Relative Humidity:	24%
Pressure:	101 kPa	Test Voltage :	DC 12V
Test Mode :	Mode 4	Polarization :	--

Freq. (MHz)	Reading (dBuV/m)	Limit (dBuV/m)	Margin (dB)	State P/F
--	--	--	--	PASS
--	--	--	--	PASS

Note:

The amplitude of spurious emissions which are attenuated by more than 20dB below the permissible value has no need to be reported.

Distance extrapolation factor = $40 \log(\text{specific distance}/\text{test distance})$ (dB);

Limit line = specific limits(dBuV) + distance extrapolation factor.

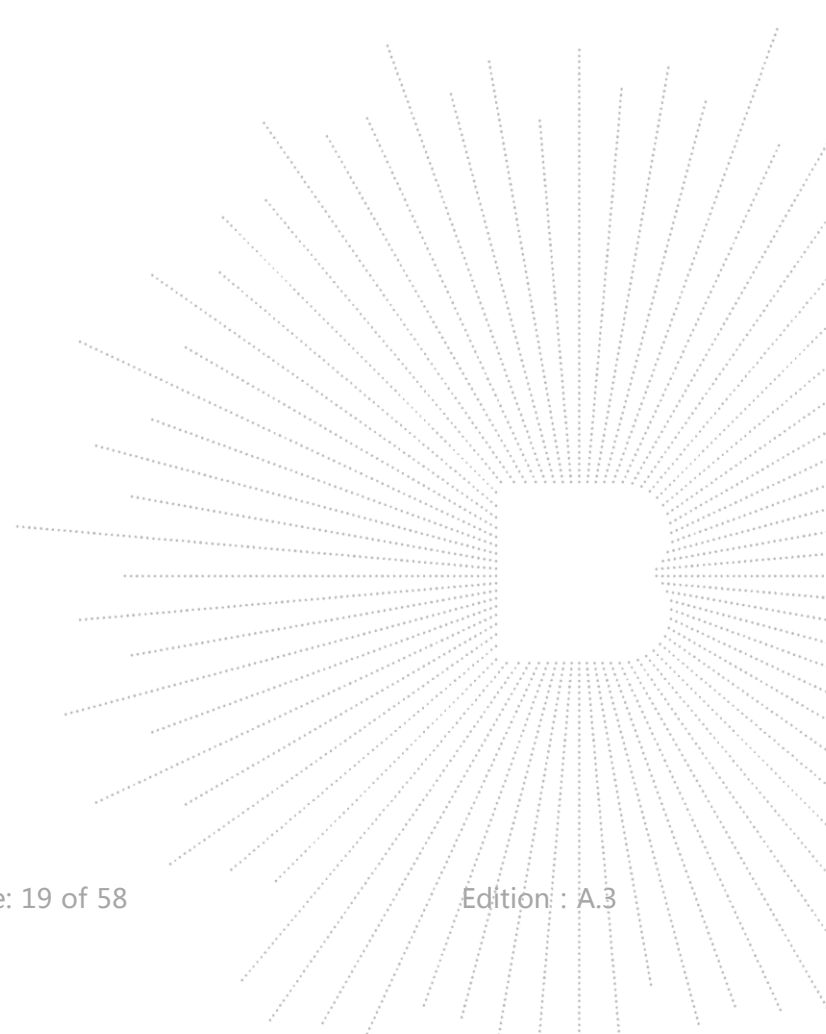

Between 30MHz – 1GHz

Temperature:	26°C	Relative Humidity:	54%
Pressure:	101 kPa	Test Voltage :	DC 12V
Test Mode :	Mode 4	Polarization :	Horizontal

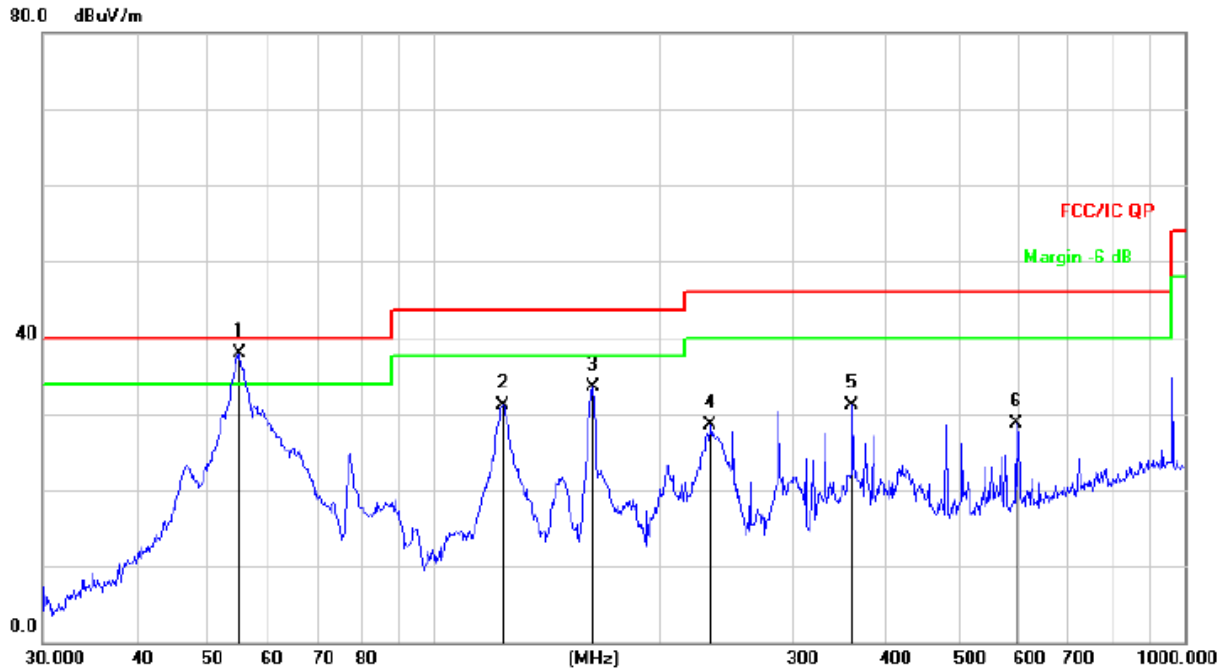

Remark:

Factor = Antenna Factor + Cable Loss – Pre-amplifier.

No.	Mk.	Freq. MHz	Reading Level dBuV	Correct Factor dB	Measure- ment dBuV/m	Limit dB/m	Over dB	Detector
1	*	54.8348	53.57	-15.71	37.86	40.00	-2.14	QP
2		123.2655	48.80	-17.69	31.11	43.50	-12.39	QP
3		162.6106	51.89	-18.47	33.42	43.50	-10.08	QP
4		233.3487	43.41	-14.92	28.49	46.00	-17.51	QP
5		360.4476	43.08	-12.00	31.08	46.00	-14.92	QP
6		595.1327	34.80	-6.13	28.67	46.00	-17.33	QP

Temperature:	26°C	Relative Humidity:	54%
Pressure:	101 kpa	Test Voltage :	DC 12V
Test Mode :	Mode 4	Polarization :	Vertical

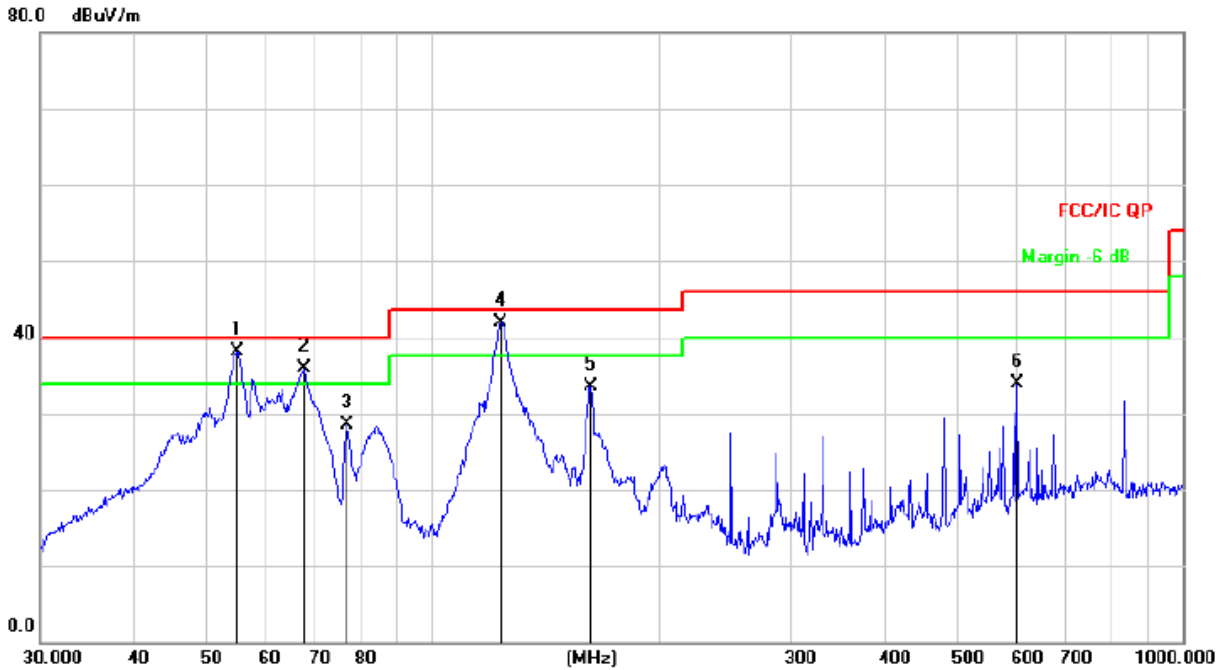

Remark:

Factor = Antenna Factor + Cable Loss – Pre-amplifier.

No.	Mk.	Freq. MHz	Reading Level dBuV	Correct Factor dB	Measure- ment dBuV/m	Limit dB/m	Over dB	Detector
1	!	54.8348	53.86	-15.71	38.15	40.00	-1.85	QP
2	!	67.4381	53.99	-18.05	35.94	40.00	-4.06	QP
3		77.0502	48.32	-19.88	28.44	40.00	-11.56	QP
4	*	123.2655	59.67	-17.69	41.98	43.50	-1.52	QP
5		162.6106	52.04	-18.47	33.57	43.50	-9.93	QP
6		601.4265	39.90	-5.98	33.92	46.00	-12.08	QP

Between 1GHz – 25GHz
802.11b

Polar (H/V)	Frequency	Reading Level	Correct Factor	Measure- ment	Limits	Over	Detector Type
	(MHz)	(dBuV/m)	(dB)	(dBuV/m)	(dBuV/ m)	(dB)	
Low channel:2412MHz							
V	4824.00	52.96	-0.43	52.53	74.00	-21.47	PK
V	4824.00	44.24	-0.43	43.81	54.00	-10.19	AV
V	7236.00	43.94	8.31	52.25	74.00	-21.75	PK
V	7236.00	33.28	8.31	41.59	54.00	-12.41	AV
H	4824.00	48.94	-0.43	48.51	74.00	-25.49	PK
H	4824.00	39.94	-0.43	39.51	54.00	-14.49	AV
H	7236.00	42.60	8.31	50.91	74.00	-23.09	PK
H	7236.00	34.96	8.31	43.27	54.00	-10.73	AV
Middle channel:2437MHz							
V	4874.00	50.26	-0.38	49.88	74.00	-24.12	PK
V	4874.00	42.02	-0.38	41.64	54.00	-12.36	AV
V	7311.00	41.18	8.83	50.01	74.00	-23.99	PK
V	7311.00	32.39	8.83	41.22	54.00	-12.78	AV
H	4874.00	48.57	-0.38	48.19	74.00	-25.81	PK
H	4874.00	37.79	-0.38	37.41	54.00	-16.59	AV
H	7311.00	38.50	8.83	47.33	74.00	-26.67	PK
H	7311.00	30.21	8.83	39.04	54.00	-14.96	AV
High channel:2462MHz							
V	4924.00	51.92	-0.32	51.60	74.00	-22.40	PK
V	4924.00	43.33	-0.32	43.01	54.00	-10.99	AV
V	7386.00	44.81	9.35	54.16	74.00	-19.84	PK
V	7386.00	34.87	9.35	44.22	54.00	-9.78	AV
H	4924.00	49.03	-0.32	48.71	74.00	-25.29	PK
H	4924.00	38.35	-0.32	38.03	54.00	-15.97	AV
H	7386.00	43.54	9.35	52.89	74.00	-21.11	PK
H	7386.00	36.11	9.35	45.46	54.00	-8.54	AV

Remark:

1. Emission Level = Meter Reading + Factor,
 Factor = Antenna Factor + Cable Loss – Pre-amplifier.
 Over = Emission Level - Limit
2. If peak below the average limit, the average emission was no test.
3. In restricted bands of operation, The spurious emissions below the permissible value more than 20dB
4. The amplitude of spurious emissions which are attenuated by more than 20dB below the permissible value has no need to be reported.
5. All the Modulation are test, the worst mode is 802.11b, the data recording in the report.

802.11g

Polar (H/V)	Frequency	Reading Level	Correct Factor	Measurement	Limits	Over	Detector Type
	(MHz)	(dBuV/m)	(dB)	(dBuV/m)	(dBuV/m)	(dB)	
Low channel:2412MHz							
V	4824.00	52.84	-0.43	52.41	74.00	-21.59	PK
V	4824.00	43.24	-0.43	42.81	54.00	-11.19	AV
V	7236.00	45.24	8.31	53.55	74.00	-20.45	PK
V	7236.00	35.30	8.31	43.61	54.00	-10.39	AV
H	4824.00	51.27	-0.43	50.84	74.00	-23.16	PK
H	4824.00	42.18	-0.43	41.75	54.00	-12.25	AV
H	7236.00	43.78	8.31	52.09	74.00	-21.91	PK
H	7236.00	36.66	8.31	44.97	54.00	-9.03	AV
Middle channel:2437MHz							
V	4874.00	50.01	-0.38	49.63	74.00	-24.37	PK
V	4874.00	42.65	-0.38	42.27	54.00	-11.73	AV
V	7311.00	42.64	8.83	51.47	74.00	-22.53	PK
V	7311.00	34.34	8.83	43.17	54.00	-10.83	AV
H	4874.00	47.62	-0.38	47.24	74.00	-26.76	PK
H	4874.00	36.86	-0.38	36.48	54.00	-17.52	AV
H	7311.00	39.78	8.83	48.61	74.00	-25.39	PK
H	7311.00	31.11	8.83	39.94	54.00	-14.06	AV
High channel:2462MHz							
V	4924.00	52.42	-0.32	52.10	74.00	-21.90	PK
V	4924.00	42.80	-0.32	42.48	54.00	-11.52	AV
V	7386.00	46.11	9.35	55.46	74.00	-18.54	PK
V	7386.00	35.73	9.35	45.08	54.00	-8.92	AV
H	4924.00	51.32	-0.32	51.00	74.00	-23.00	PK
H	4924.00	40.37	-0.32	40.05	54.00	-13.95	AV
H	7386.00	43.53	9.35	52.88	74.00	-21.12	PK
H	7386.00	35.90	9.35	45.25	54.00	-8.75	AV

Remark:

1. Emission Level = Meter Reading + Factor,
Factor = Antenna Factor + Cable Loss – Pre-amplifier.
Over = Emission Level - Limit
2. If peak below the average limit, the average emission was no test.
3. In restricted bands of operation, The spurious emissions below the permissible value more than 20dB
4. The amplitude of spurious emissions which are attenuated by more than 20dB below the permissible value has no need to be reported.
5. All the Modulation are test, the worst mode is 802.11b, the data recording in the report.

802.11n20

Polar (H/V)	Frequency	Reading Level	Correct Factor	Measurement	Limits	Over	Detector Type
	(MHz)	(dBuV/m)	(dB)	(dBuV/m)	(dBuV/m)	(dB)	
Low channel:2412MHz							
V	4824.00	53.62	-0.43	53.19	74.00	-20.81	PK
V	4824.00	44.64	-0.43	44.21	54.00	-9.79	AV
V	7236.00	43.77	8.31	52.08	74.00	-21.92	PK
V	7236.00	33.68	8.31	41.99	54.00	-12.01	AV
H	4824.00	50.98	-0.43	50.55	74.00	-23.45	PK
H	4824.00	41.86	-0.43	41.43	54.00	-12.57	AV
H	7236.00	41.42	8.31	49.73	74.00	-24.27	PK
H	7236.00	32.74	8.31	41.05	54.00	-12.95	AV
Middle channel:2437MHz							
V	4874.00	51.91	-0.38	51.53	74.00	-22.47	PK
V	4874.00	44.67	-0.38	44.29	54.00	-9.71	AV
V	7311.00	42.05	8.83	50.88	74.00	-23.12	PK
V	7311.00	33.35	8.83	42.18	54.00	-11.82	AV
H	4874.00	49.00	-0.38	48.62	74.00	-25.38	PK
H	4874.00	39.91	-0.38	39.53	54.00	-14.47	AV
H	7311.00	39.48	8.83	48.31	74.00	-25.69	PK
H	7311.00	31.30	8.83	40.13	54.00	-13.87	AV
High channel:2462MHz							
V	4924.00	53.19	-0.32	52.87	74.00	-21.13	PK
V	4924.00	43.28	-0.32	42.96	54.00	-11.04	AV
V	7386.00	45.37	9.35	54.72	74.00	-19.28	PK
V	7386.00	35.84	9.35	45.19	54.00	-8.81	AV
H	4924.00	52.07	-0.32	51.75	74.00	-22.25	PK
H	4924.00	41.50	-0.32	41.18	54.00	-12.82	AV
H	7386.00	43.60	9.35	52.95	74.00	-21.05	PK
H	7386.00	36.11	9.35	45.46	54.00	-8.54	AV

Remark:

1. Emission Level = Meter Reading + Factor,
Factor = Antenna Factor + Cable Loss – Pre-amplifier.
Over= Emission Level - Limit
2. If peak below the average limit, the average emission was no test.
3. In restricted bands of operation, The spurious emissions below the permissible value more than 20dB
4. The amplitude of spurious emissions which are attenuated by more than 20dB below the permissible value has no need to be reported.
5. All the Modulation are test, the worst mode is 802.11b, the data recording in the report.

8. Radiated Band Emission Measurement And Restricted Bands Of Operation

8.1 Block Diagram Of Test Setup

Radiated Emission Test-Up Frequency Above 1GHz

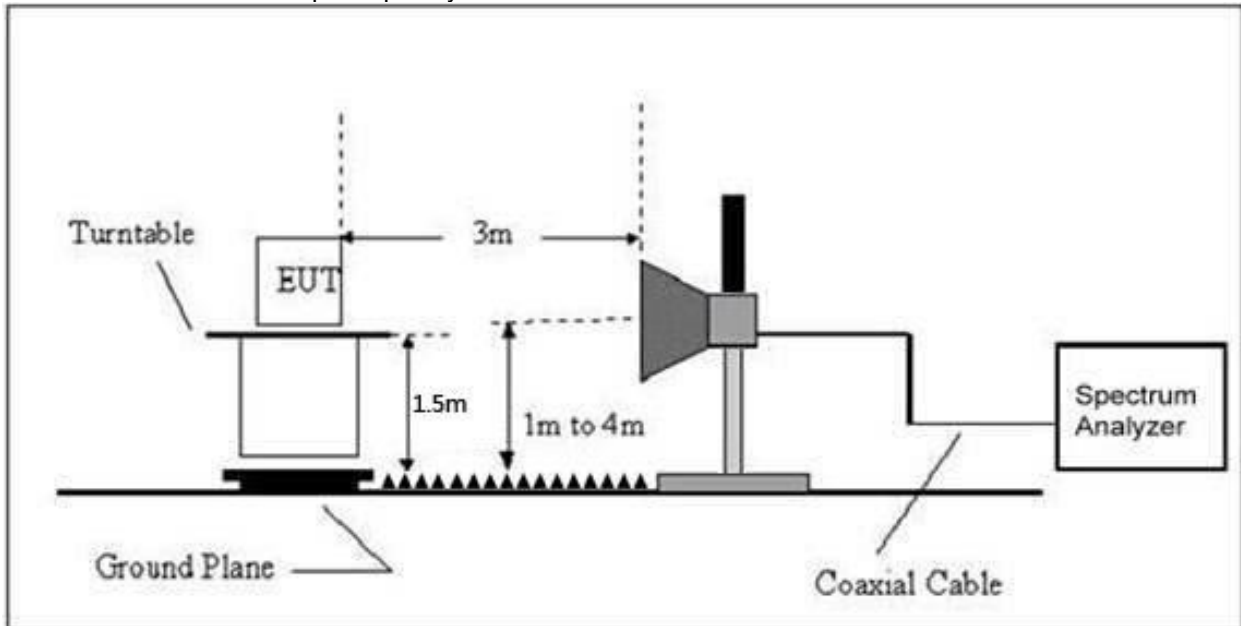

8.2 Limit

FCC Part15 C Section 15.209 and 15.205

(a) Except as shown in paragraph (d) of this section, only spurious emissions are permitted in any of the frequency bands listed below:

MHz	MHz	MHz	GHz
0.090-0.110	16.42-16.423	399.9-410	4.5-5.15
0.495-0.505	16.69475-16.69525	608-614	5.35-5.46
2.1735-2.1905	16.80425-16.80475	960-1240	7.25-7.75
4.125-4.128	25.5-25.67	1300-1427	8.025-8.5
4.17725-4.17775	37.5-38.25	1435-1626.5	9.0-9.2
4.20725-4.20775	73-74.6	1645.5-1646.5	9.3-9.5
6.215-6.218	74.8-75.2	1660-1710	10.6-12.7
6.26775-6.26825	108-121.94	1718.8-1722.2	13.25-13.4
6.31175-6.31225	123-138	2200-2300	14.47-14.5
8.291-8.294	149.9-150.05	2310-2390	15.35-16.2
8.362-8.366	156.52475-156.52525	2483.5-2500	17.7-21.4
8.37625-8.38675	156.7-156.9	2690-2900	22.01-23.12
8.41425-8.41475	162.0125-167.17	3260-3267	23.6-24.0
12.29-12.293	167.72-173.2	3332-3339	31.2-31.8
12.51975-12.52025	240-285	3345.8-3358	36.43-36.5
12.57675-12.57725	322-335.4	3600-4400	(²)
13.36-13.41			

LIMITS OF RADIATED EMISSION MEASUREMENT (Above 1000MHz)

FREQUENCY (MHz)	Limit (dBuV/m) (at 3M)	
	PEAK	AVERAGE
Above 1000	74	54

Notes:

- (1)The limit for radiated test was performed according to FCC PART 15C.
- (2)The tighter limit applies at the band edges.
- (3)Emission level (dBuV/m)=20log Emission level (uV/m).

8.3 Test Procedure

Receiver Parameter	Setting
Attenuation	Auto
Start Frequency	2300MHz
Stop Frequency	2520
RB / VB (emission in restricted band)	1 MHz / 1 MHz for Peak, 1 MHz / 10Hz for Average

Above 1GHz test procedure as below:

- a. The EUT was placed on the top of a rotating table 1.5 meters above the ground at a 3 meter chamber. The table was rotated 360 degrees to determine the position of the highest radiation.
- b. The EUT was set 3 meters away from the interference-receiving antenna, which was mounted on the top of a variable-height antenna tower.
- c. The antenna height is varied from one meter to four meters above the ground to determine the maximum value of the field strength. Both horizontal and vertical polarizations of the antenna are set to make the measurement.
- d. For each suspected emission, the EUT was arranged to its worst case and then the antenna was tuned to heights from 1 meter to 4 meters and the rota table was turned from 0 degrees to 360 degrees to find the maximum reading.
- e. The test-receiver system was set to Peak Detect Function and Specified Bandwidth with Maximum Hold Mode.
- f. If the emission level of the EUT in peak mode was 10dB lower than the limit specified, then testing could be stopped and the peak values of the EUT would be reported. Otherwise the emissions that did not have 10dB margin would be re-tested one by one using peak, quasi-peak or average method as specified and then reported in a data sheet.
- g. Test the EUT in the lowest channel, the Highest channel.

Note:

Both horizontal and vertical antenna polarities were tested and performed pretest to three orthogonal axis. The worst case emissions were reported.

8.4 EUT Operating Conditions

The EUT was configured for testing in a typical fashion (as a customer would normally use it). The EUT has been programmed to continuously transmit during test. This operating condition was tested and used to collect the included data.

8.5 Test Result

	Polar (H/V)	Frequency (MHz)	Reading Level (dBuV/m)	Correct Factor (dB)	Measurement (dBuV/m)	Limits (dBuV/m)		Result
					PK	PK	AV	
802.11b	Low Channel 2412MHz							
	H	2390.00	56.54	-6.70	49.84	74.00	54.00	PASS
	H	2400.00	48.00	-6.71	41.29	74.00	54.00	PASS
	V	2390.00	55.76	-6.70	49.06	74.00	54.00	PASS
	V	2400.00	47.98	-6.71	41.27	74.00	54.00	PASS
	High Channel 2462MHz							
	H	2483.50	56.92	-6.79	50.13	74.00	54.00	PASS
	H	2485.00	47.80	-6.81	40.99	74.00	54.00	PASS
	V	2483.50	54.03	-6.79	47.24	74.00	54.00	PASS
	V	2485.00	45.22	-6.81	38.41	74.00	54.00	PASS
802.11g	Low Channel 2412MHz							
	H	2390.00	57.05	-6.70	50.35	74.00	54.00	PASS
	H	2400.00	48.90	-6.71	42.19	74.00	54.00	PASS
	V	2390.00	57.31	-6.70	50.61	74.00	54.00	PASS
	V	2400.00	49.28	-6.71	42.57	74.00	54.00	PASS
	High Channel 2462MHz							
	H	2483.50	55.49	-6.79	48.70	74.00	54.00	PASS
	H	2485.00	49.41	-6.81	42.60	74.00	54.00	PASS
	V	2483.50	57.17	-6.79	50.38	74.00	54.00	PASS
	V	2485.00	48.33	-6.81	41.52	74.00	54.00	PASS

Remark:

1. Emission Level = Meter Reading + Factor,
Factor = Antenna Factor + Cable Loss – Pre-amplifier.
Over= Emission Level - Limit
2. If the PK measured levels comply with average limit, then the average level were deemed to comply with average limit.
- 3 In restricted bands of operation, The spurious emissions below the permissible value more than 20dB
4. The amplitude of spurious emissions which are attenuated by more than 20dB below the permissible value has no need to be reported.

	Polar (H/V)	Frequency (MHz)	Reading Level (dBuV/m)	Correct Factor (dB)	Measurement (dBuV/m)	Limits (dBuV/m)		Result
					PK	PK	AV	
802.11 n20	Low Channel 2412MHz							
	H	2390.00	56.19	-6.70	49.49	74.00	54.00	PASS
	H	2400.00	48.52	-6.71	41.81	74.00	54.00	PASS
	V	2390.00	55.73	-6.70	49.03	74.00	54.00	PASS
	V	2400.00	47.60	-6.71	40.89	74.00	54.00	PASS
	High Channel 2462MHz							
	H	2483.50	56.57	-6.79	49.78	74.00	54.00	PASS
	H	2500.00	47.64	-6.81	40.83	74.00	54.00	PASS
	V	2483.50	56.10	-6.79	49.31	74.00	54.00	PASS
	V	2500.00	48.39	-6.81	41.58	74.00	54.00	PASS

Remark:

1. Emission Level = Meter Reading + Factor,
Factor = Antenna Factor + Cable Loss – Pre-amplifier.
Over= Emission Level - Limit
2. If the PK measured levels comply with average limit, then the average level were deemed to comply with average limit.
- 3 In restricted bands of operation, The spurious emissions below the permissible value more than 20dB
4. The amplitude of spurious emissions which are attenuated by more than 20dB below the permissible value has no need to be reported.

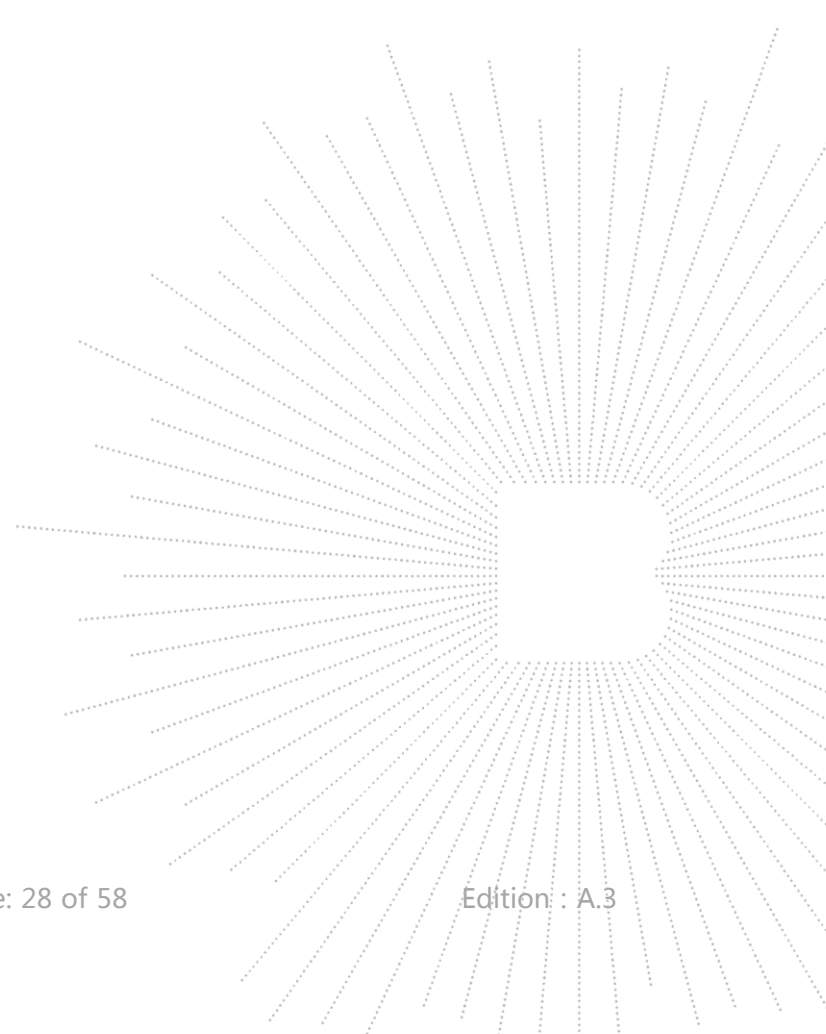

9. Power Spectral Density Test

9.1 Block Diagram Of Test Setup



9.2 Limit

FCC Part15 (15.247) , Subpart C				
Section	Test Item	Limit	Frequency Range (MHz)	Result
15.247	Power Spectral Density	8 dBm (in any 3KHz)	2400-2483.5	PASS

LIMITS OF RADIATED EMISSION MEASUREMENT (Above 1000MHz)

9.3 Test Procedure

1. Set analyzer center frequency to DTS channel center frequency.
2. Set the span to 1.5 times the DTS bandwidth.
3. Set the RBW to: 3 kHz
4. Set the VBW $\geq 3 \times$ RBW.
5. Detector = peak.
6. Sweep time = auto couple.
7. Trace mode = max hold.
8. Allow trace to fully stabilize.
9. Use the peak marker function to determine the maximum amplitude level within the RBW.
10. If measured value exceeds limit, reduce RBW (no less than 3 kHz) and repeat.

9.4 EUT Operating Conditions

The EUT tested system was configured as the statements of 4.6 Unless otherwise a special operating condition is specified in the follows during the testing.

Note: Power Spectral Density(dBm)=Reading+Cable Loss

9.5 Test Result

Temperature :	26°C	Relative Humidity :	54%
Pressure :	101kPa	Test Voltage :	DC 12V
Test Mode :	TX b Mode		

Frequency	Power Spectral Density(dBm/3kHz)	Limit (dBm/3kHz)	Result
2412 MHz	-7.21	8	PASS
2437 MHz	-10.08	8	PASS
2462 MHz	-9.62	8	PASS

TX CH01

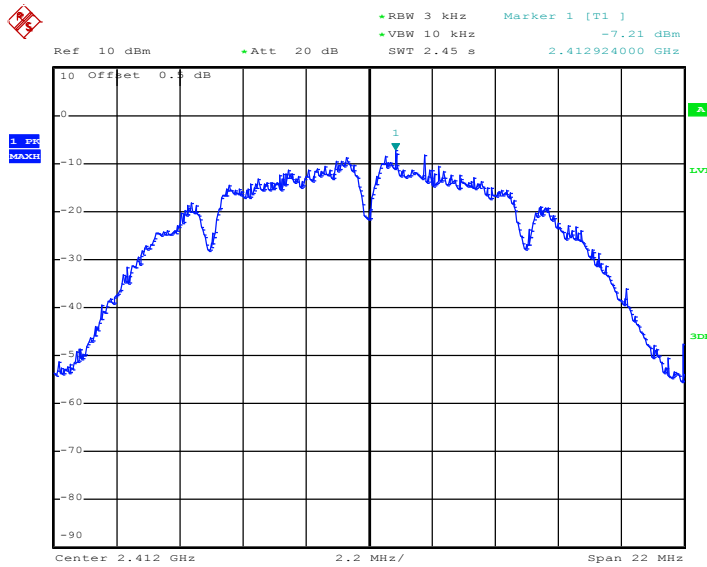

Date: 14.SEP.2021 14:53:42

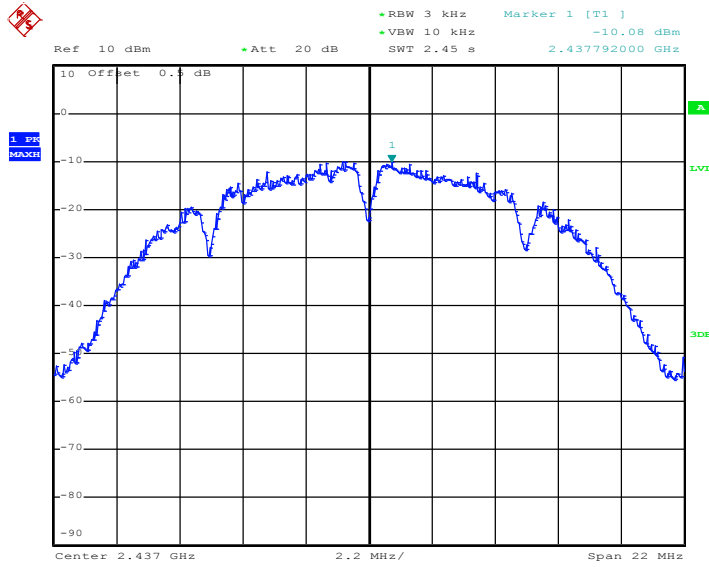
TX CH06

Date: 14.SEP.2021 14:54:43

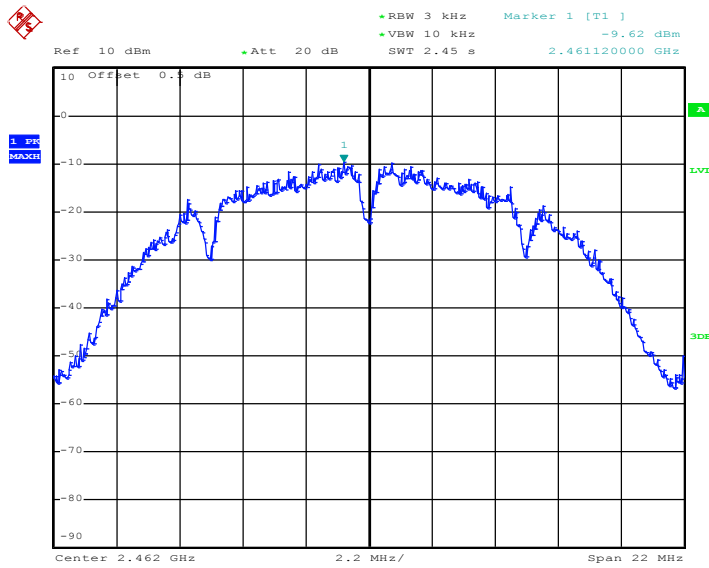
TX CH11

Date: 14.SEP.2021 14:55:20

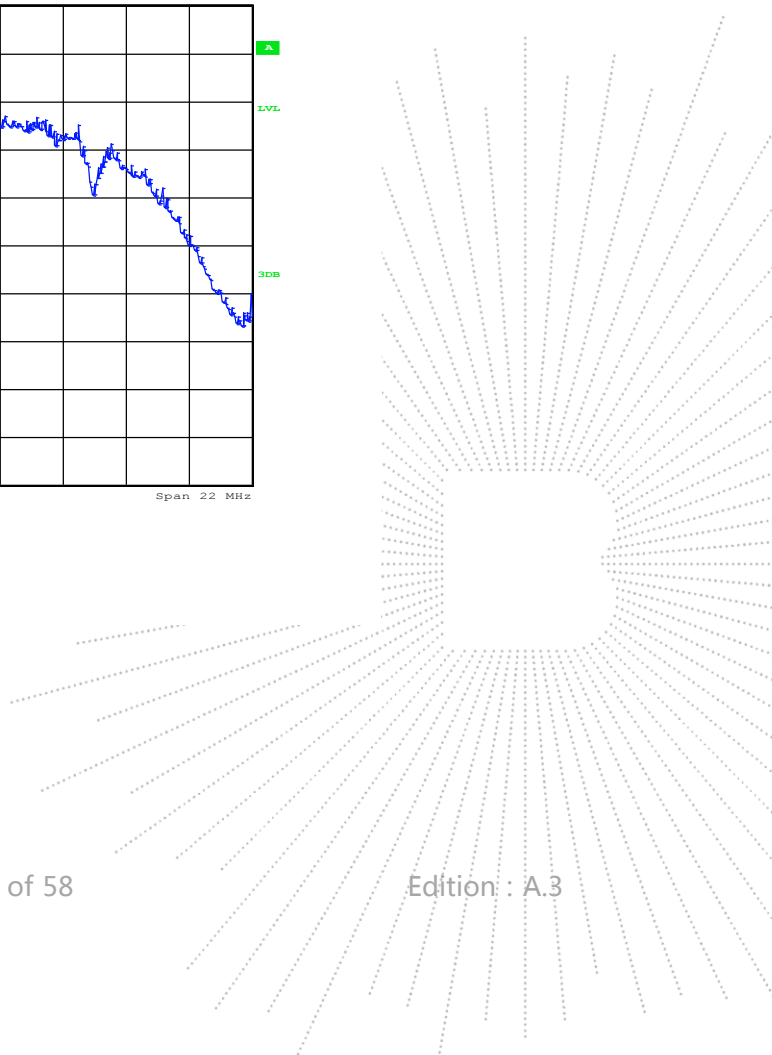

Temperature :	26°C	Relative Humidity :	54%
Pressure :	101kPa	Test Voltage :	DC 12V
Test Mode :	TX g Mode		

Frequency	Power Spectral Density(dBm/3kHz)	Limit (dBm/3kHz)	Result
2412 MHz	-16.36	8	PASS
2437 MHz	-17.24	8	PASS
2462 MHz	-17.20	8	PASS

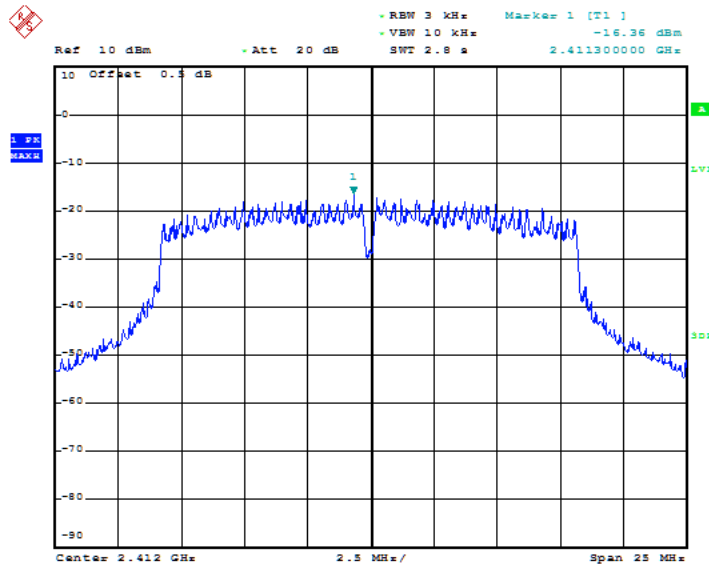
TX CH01

Date: 14.SEP.2021 14:57:21

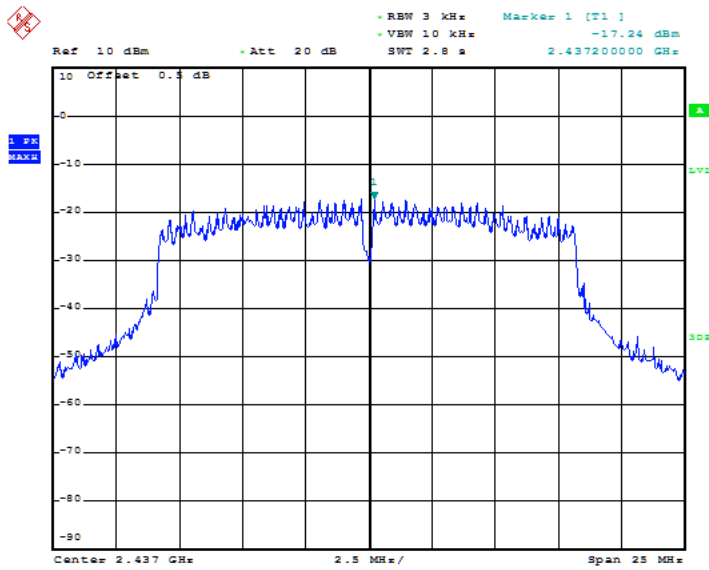
TX CH06

Date: 14.SEP.2021 14:58:21

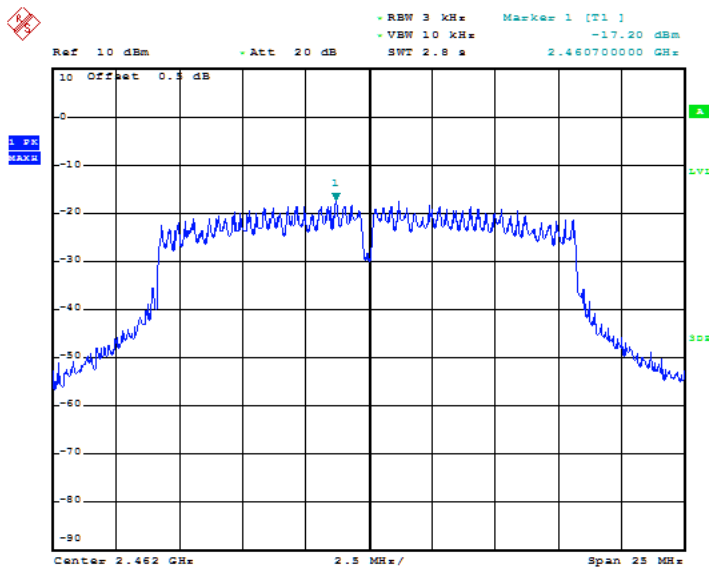
TX CH11

Date: 14.SEP.2021 14:59:03

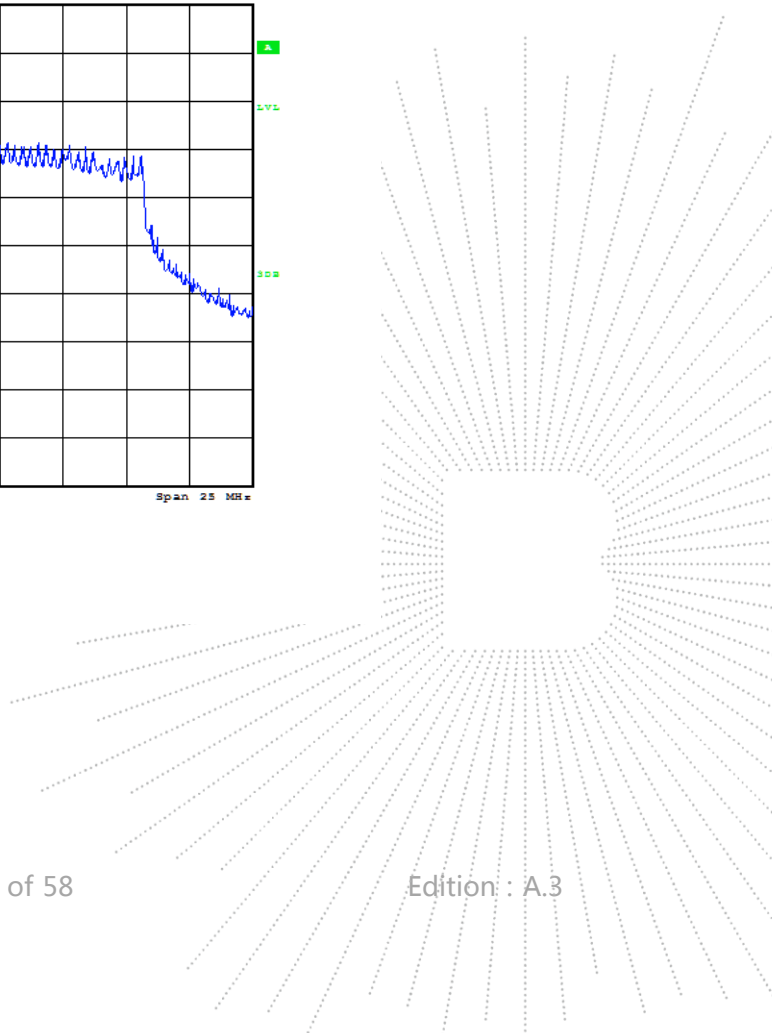

Temperature :	26°C	Relative Humidity :	54%
Pressure :	101kPa	Test Voltage :	DC 12V
Test Mode :	TX n Mode(20M)		

Frequency	Power Spectral Density(dBm/3kHz)	Limit (dBm/3kHz)	Result
2412 MHz	-16.84	8	PASS
2437 MHz	-17.53	8	PASS
2462 MHz	-16.55	8	PASS

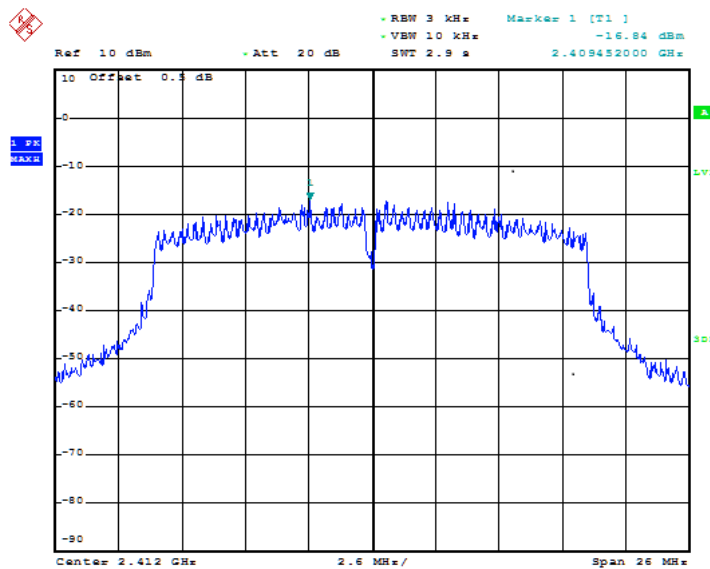
TX CH01

Date: 14.SEP.2021 15:01:06

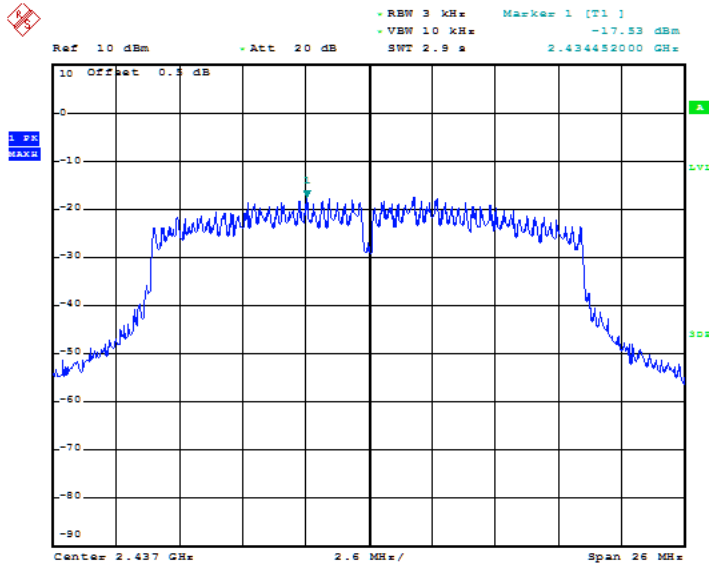
TX CH06

Date: 14.SEP.2021 15:01:58

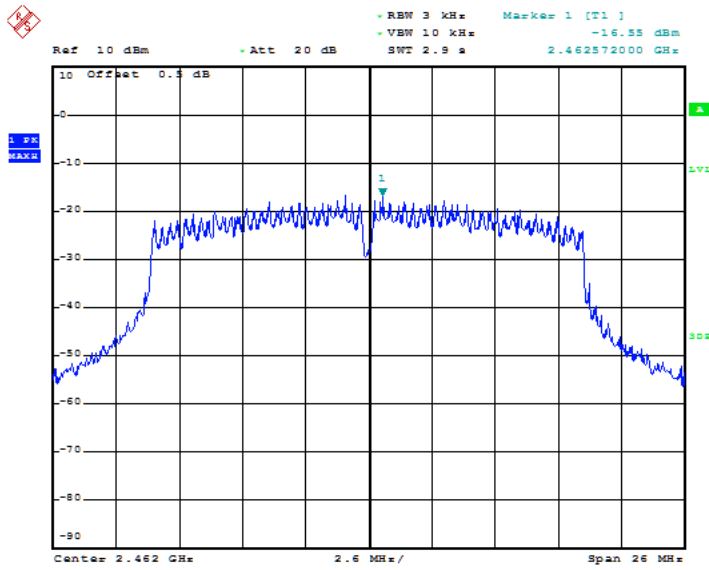
TX CH11

Date: 14.SEP.2021 15:02:55

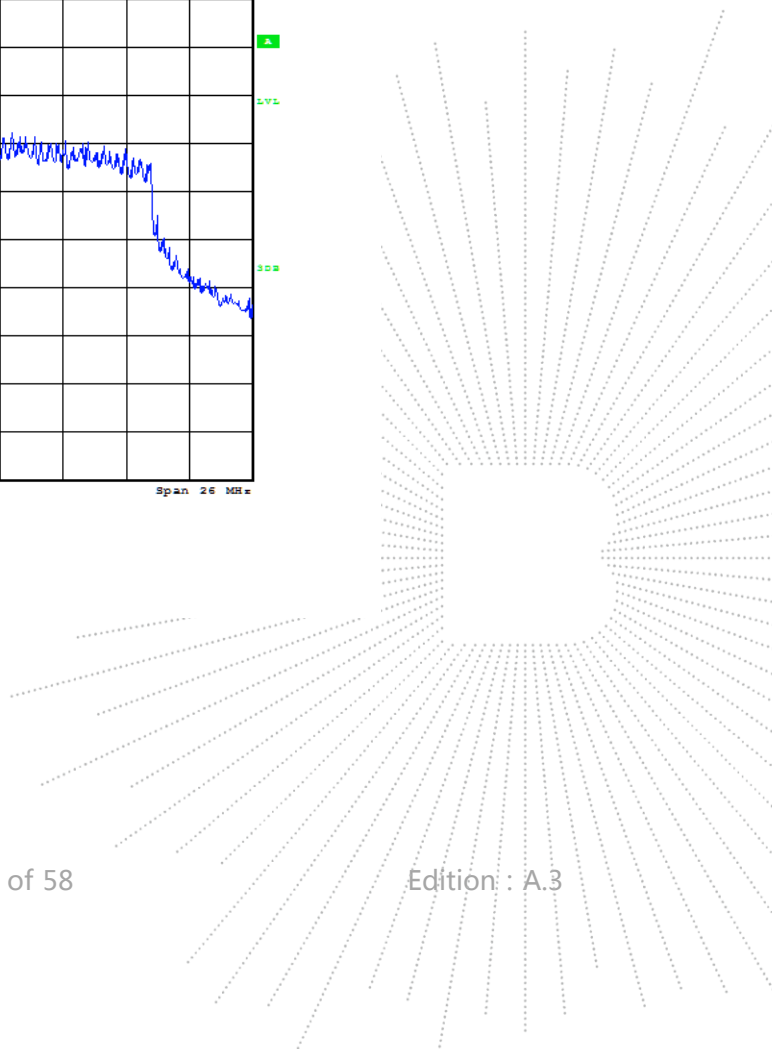

10. Bandwidth Test

10.1 Block Diagram Of Test Setup



10.2 Limit

FCC Part15 (15.247) , Subpart C				
Section	Test Item	Limit	Frequency Range (MHz)	Result
15.247(a)(2)	Bandwidth	$\geq 500\text{KHz}$ (6dB bandwidth)	2400-2483.5	PASS

10.3 Test Procedure

1. Set RBW = 100 kHz.
2. Set the video bandwidth (VBW) $\geq 3 \times$ RBW.
3. Detector = Peak.
4. Trace mode = max hold.
5. Sweep = auto couple.
6. Allow the trace to stabilize.
7. Measure the maximum width of the emission that is constrained by the frequencies associated with the two outermost amplitude points (upper and lower frequencies) that are attenuated by 6 dB relative to the maximum level measured in the fundamental emission.

10.4 EUT Operating Conditions

The EUT tested system was configured as the statements of 4.6 Unless otherwise a special operating condition is specified in the follows during the testing.

Note: Power Spectral Density(dBm)=Reading+Cable Loss

10.5 Test Result

Temperature :	26°C	Relative Humidity :	54%
Pressure :	101kPa	Test Voltage :	DC 12V
Test Mode :	TX b Mode		

Frequency (MHz)	6dB bandwidth (MHz)	Limit (kHz)	Result
2412	10.02	500	Pass
2437	10.02	500	Pass
2462	10.02	500	Pass

TX CH 01

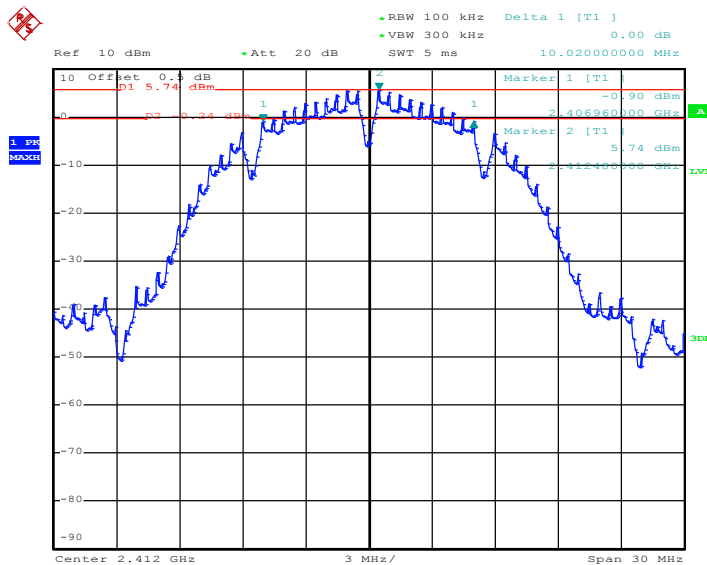

Date: 14.SEP.2021 11:57:33

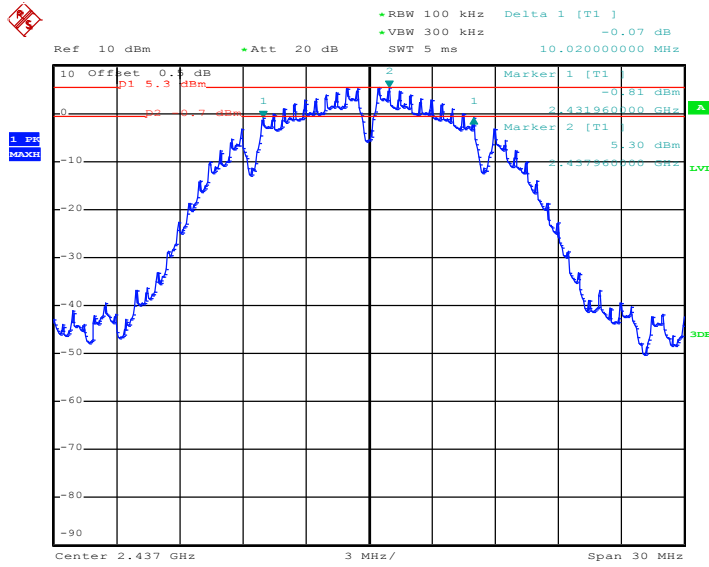
TX CH 06

Date: 14.SEP.2021 11:59:21

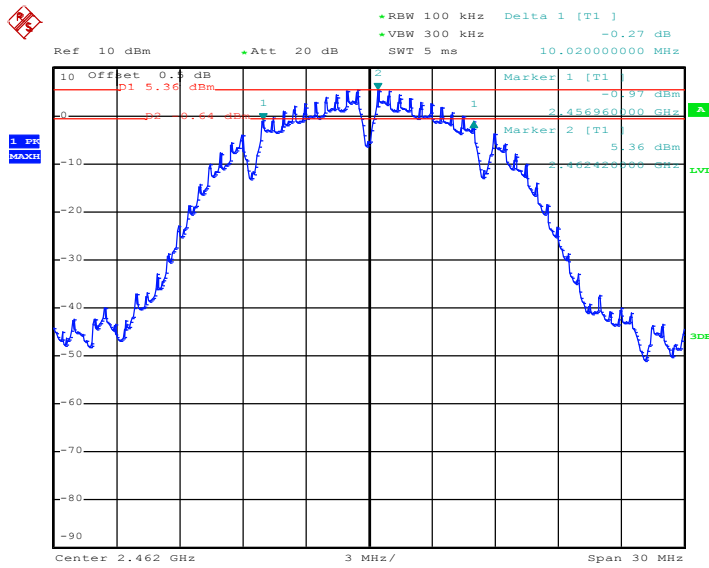
TX CH 11

Date: 14.SEP.2021 12:00:57

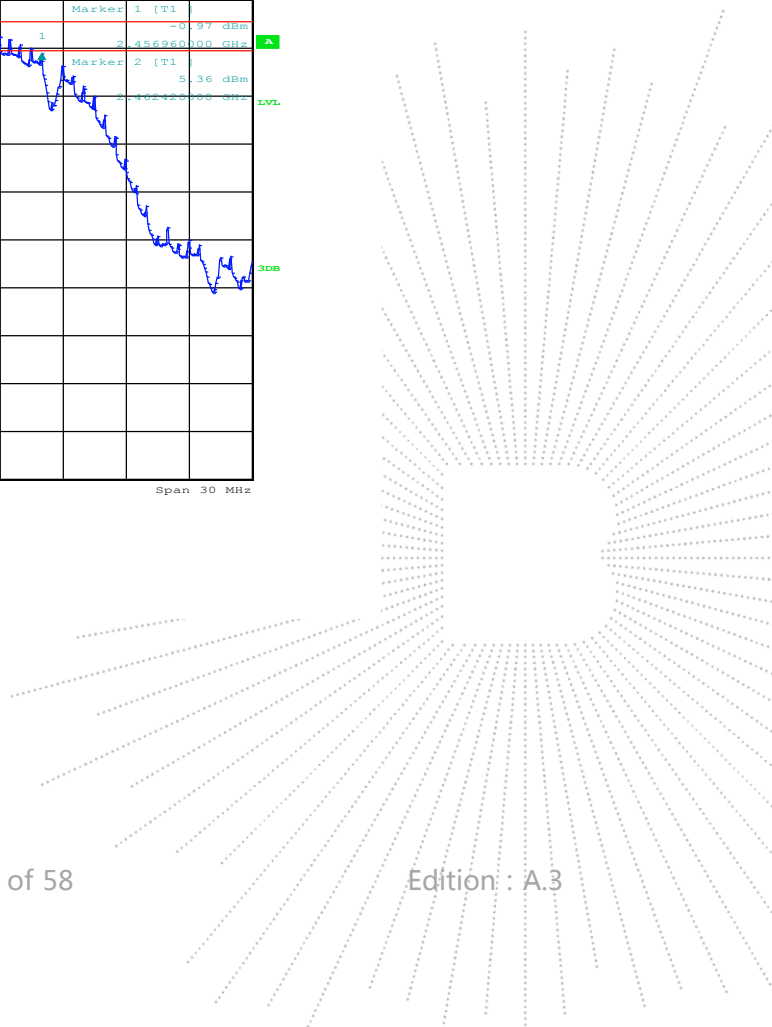

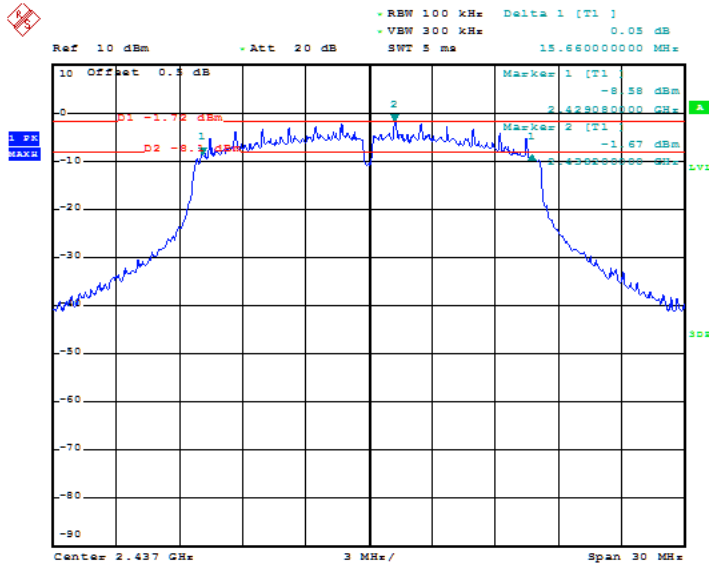
TX CH 06

Date: 14.SEP.2021 12:18:54

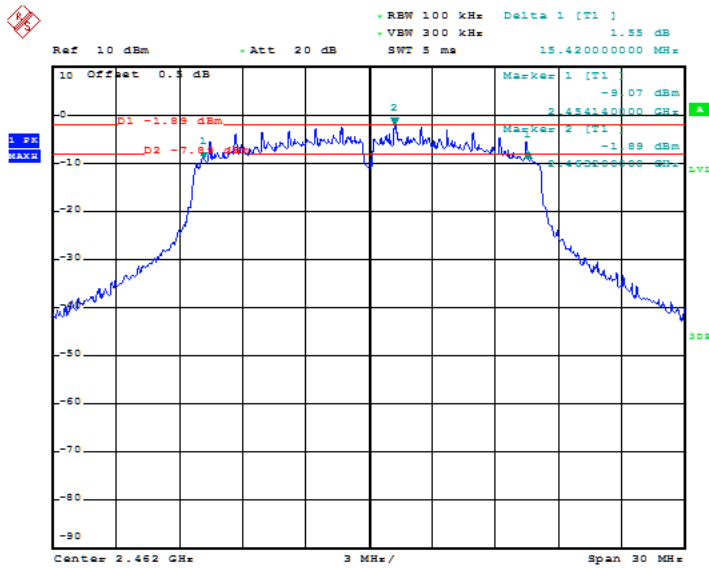
TX CH 11

Date: 14.SEP.2021 12:24:12

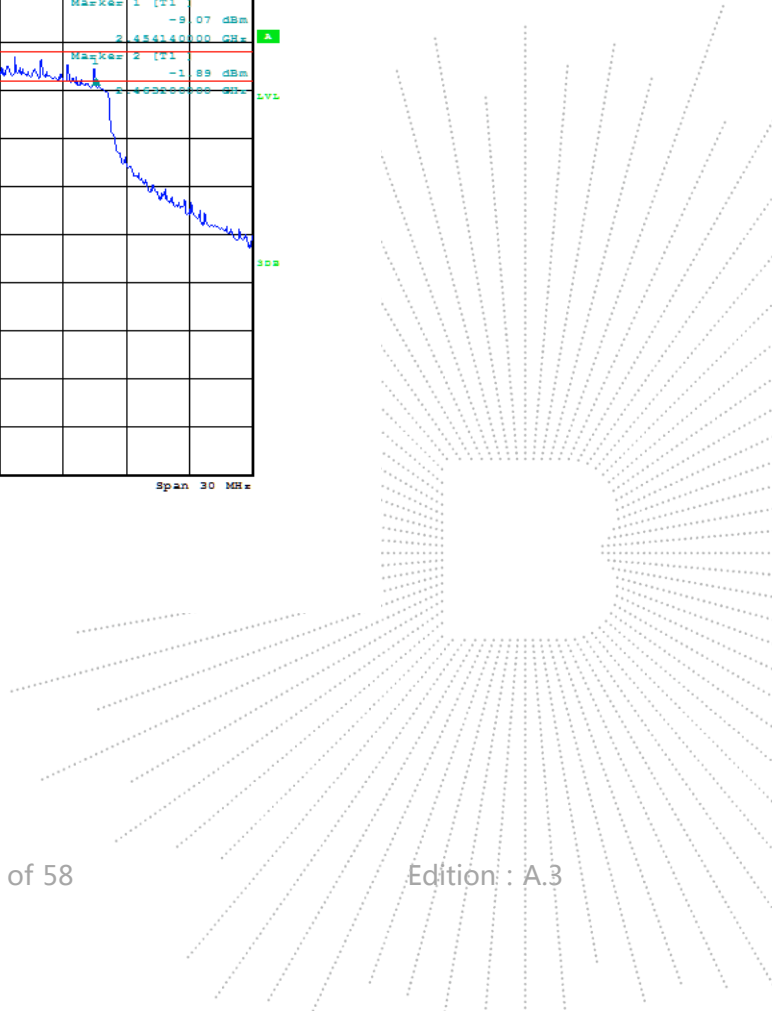

Temperature :	26°C	Relative Humidity :	54%
Pressure :	101kPa	Test Voltage :	DC 12V
Test Mode :	TX n Mode(20M)		

Frequency (MHz)	6dB bandwidth (MHz)	Limit (kHz)	Result
2412	15.96	500	Pass
2437	15.54	500	Pass
2462	15.48	500	Pass

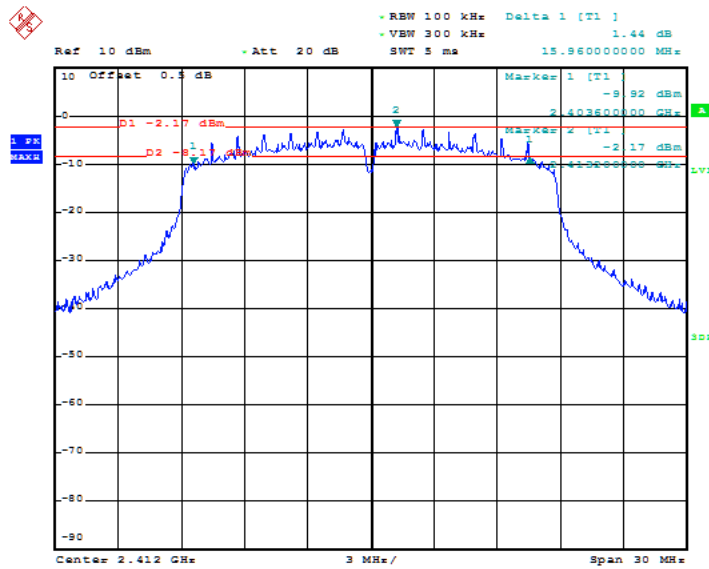
TX CH 01

Date: 14.SEP.2021 12:40:28

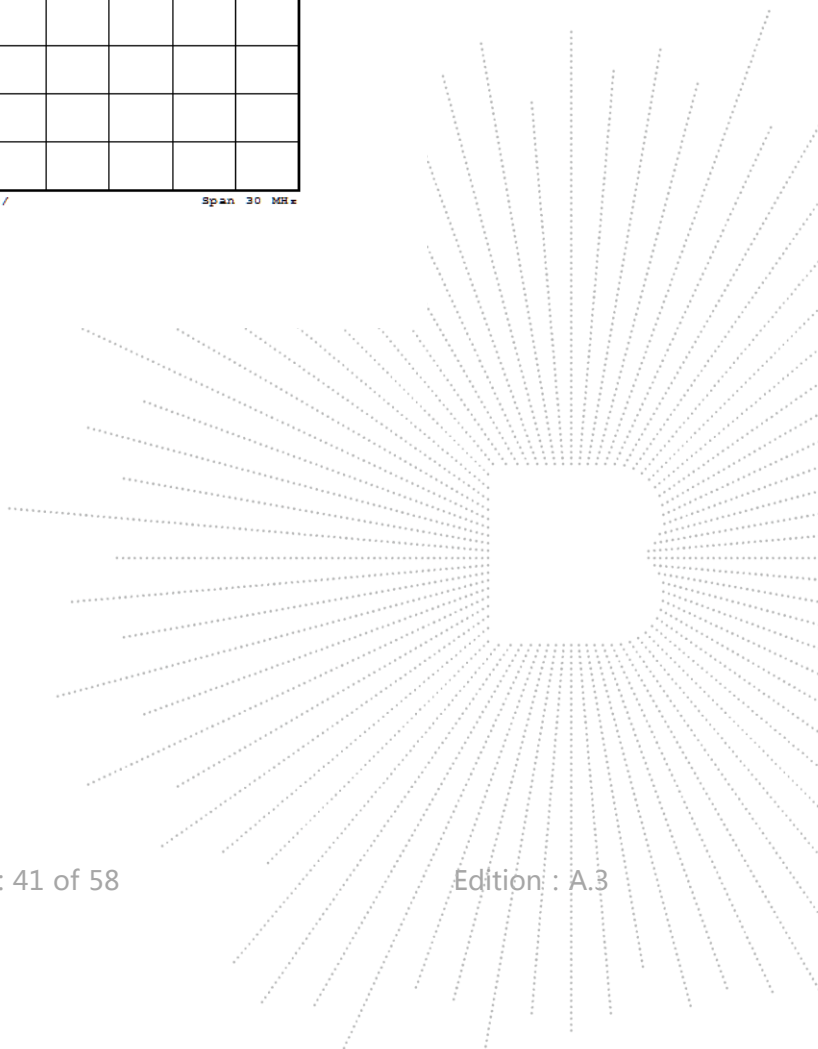

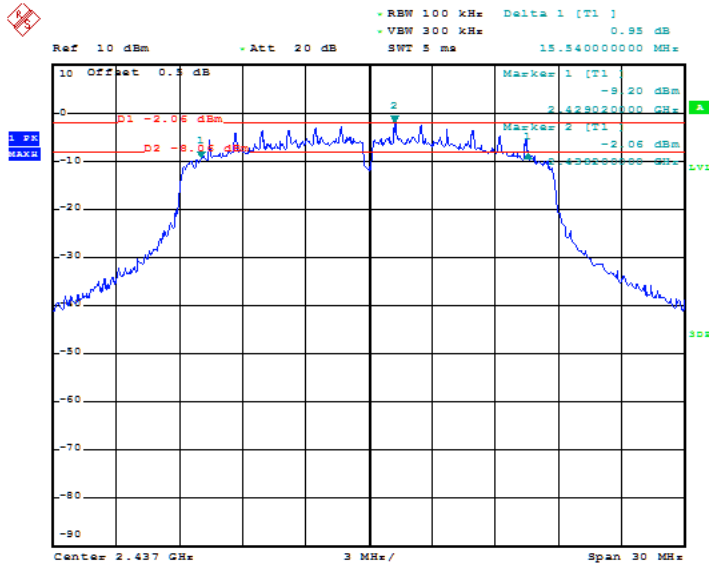
TX CH 06

Date: 14.SEP.2021 12:43:51

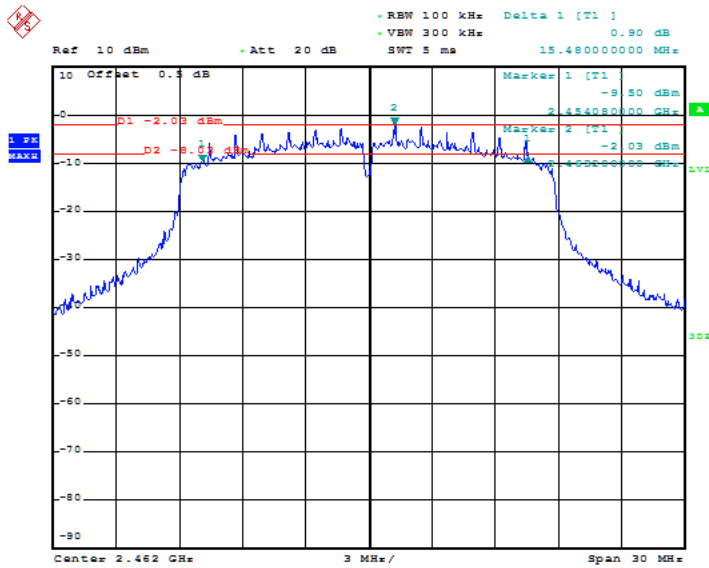
TX CH 11

Date: 14.SEP.2021 12:47:11

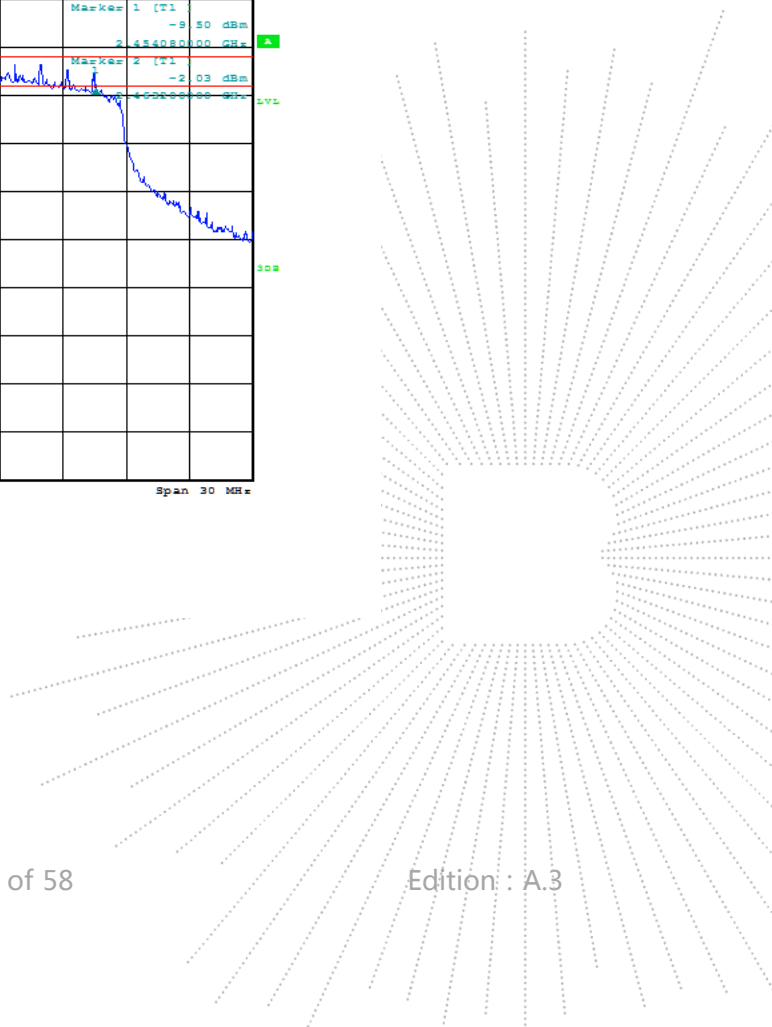

11. Peak Output Power Test

11.1 Block Diagram Of Test Setup



11.2 Limit

FCC Part15 (15.247) , Subpart C				
Section	Test Item	Limit	Frequency Range (MHz)	Result
15.247(b)(3)	Peak Output Power	1 watt or 30dBm	2400-2483.5	PASS

11.3 Test Procedure

- a. The EUT was directly connected to the Power meter

11.4 EUT Operating Conditions

The EUT tested system was configured as the statements of 4.6 Unless otherwise a special operating condition is specified in the follows during the testing.

Note: Power Spectral Density(dBm)=Reading+Cable Loss

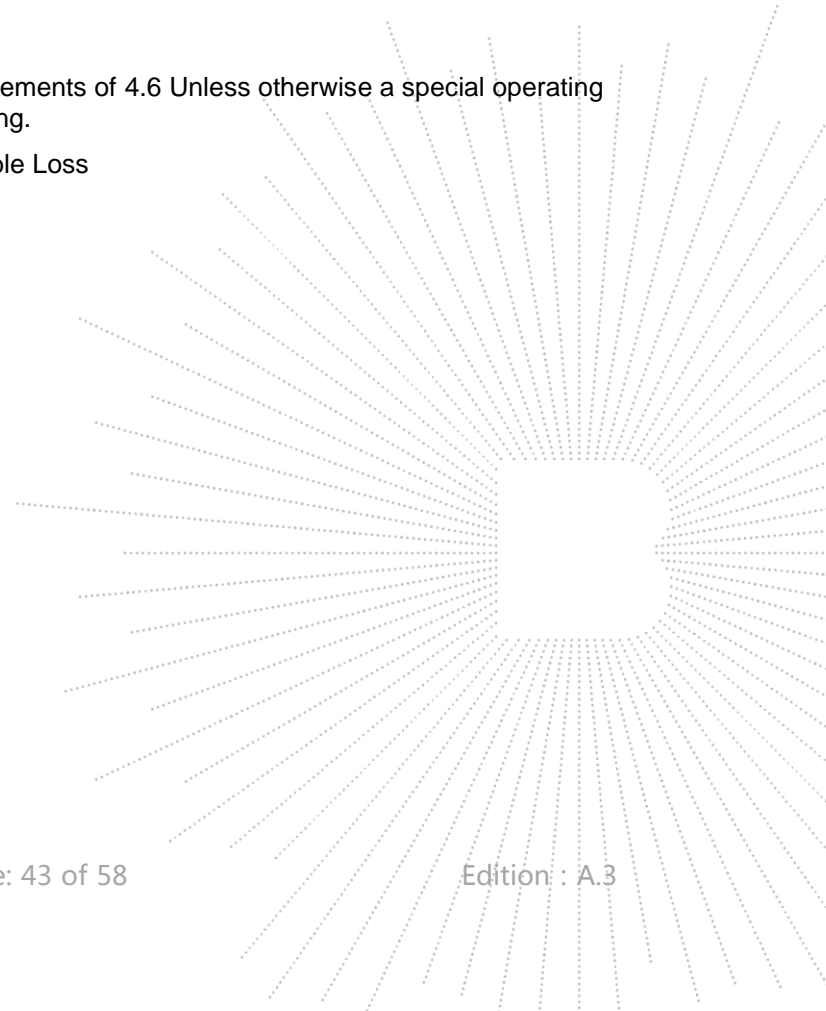

11.5 Test Result

Temperature :	26°C	Relative Humidity :	54%
Pressure :	101kPa	Test Voltage :	DC 12V

	Frequency	Maximum Conducted Output Power(PK)	LIMIT
	(MHz)	(dBm)	dBm
802.11b	2412	14.61	30
	2437	13.94	30
	2462	14.25	30
802.11g	2412	12.67	30
	2437	12.61	30
	2462	12.70	30
802.11n20	2412	12.15	30
	2437	12.25	30
	2462	12.49	30

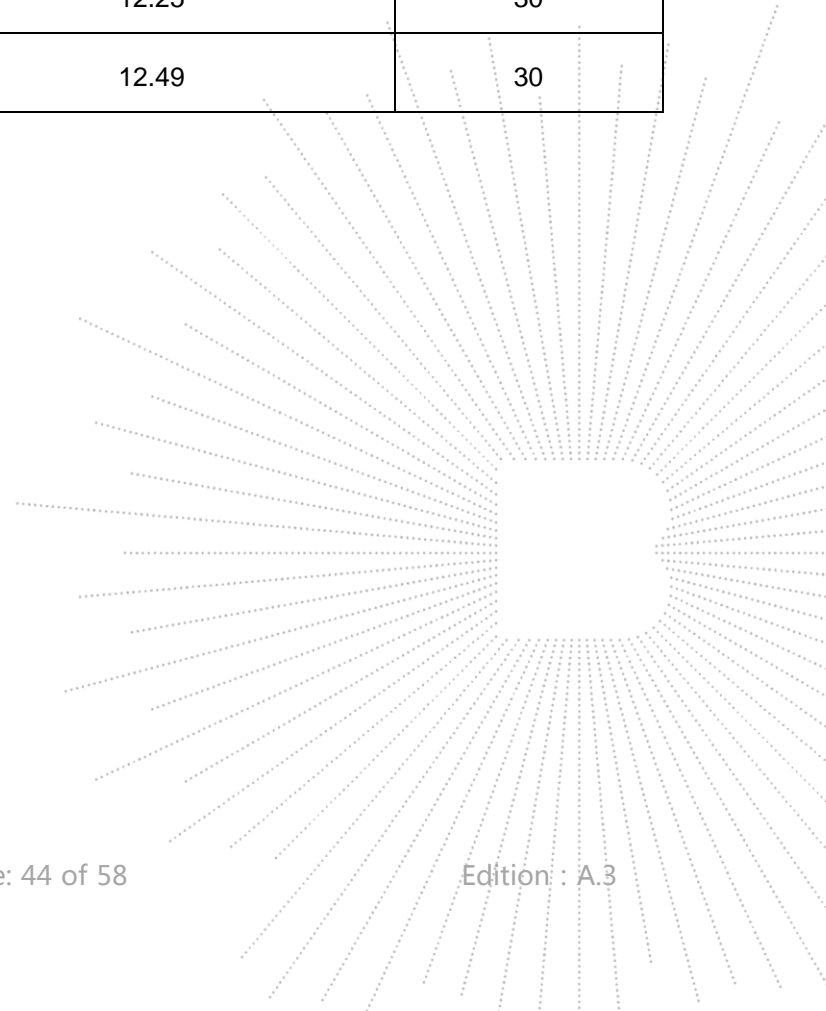

12. 100 Khz Bandwidth Of Frequency Band Edge

12.1 Block Diagram Of Test Setup



12.2 Limit

In any 100 kHz bandwidth outside the frequency band in which the spread spectrum intentional radiator is operating, the radio frequency power that is produced by the intentional radiator shall be at least 20 dB below that in the 100 kHz bandwidth within the band that contains the highest level of the desired power, based on either an RF conducted or a radiated measurement.

12.3 Test Procedure

Using the following spectrum analyzer setting:

- a) Set the RBW = 100KHz.
- b) Set the VBW = 300KHz.
- c) Sweep time = auto couple.
- d) Detector function = peak.
- e) Trace mode = max hold.
- f) Allow trace to fully stabilize..

12.4 EUT Operating Conditions

The EUT tested system was configured as the statements of 4.6 Unless otherwise a special operating condition is specified in the follows during the testing.

Note: Power Spectral Density(dBm)=Reading+Cable Loss

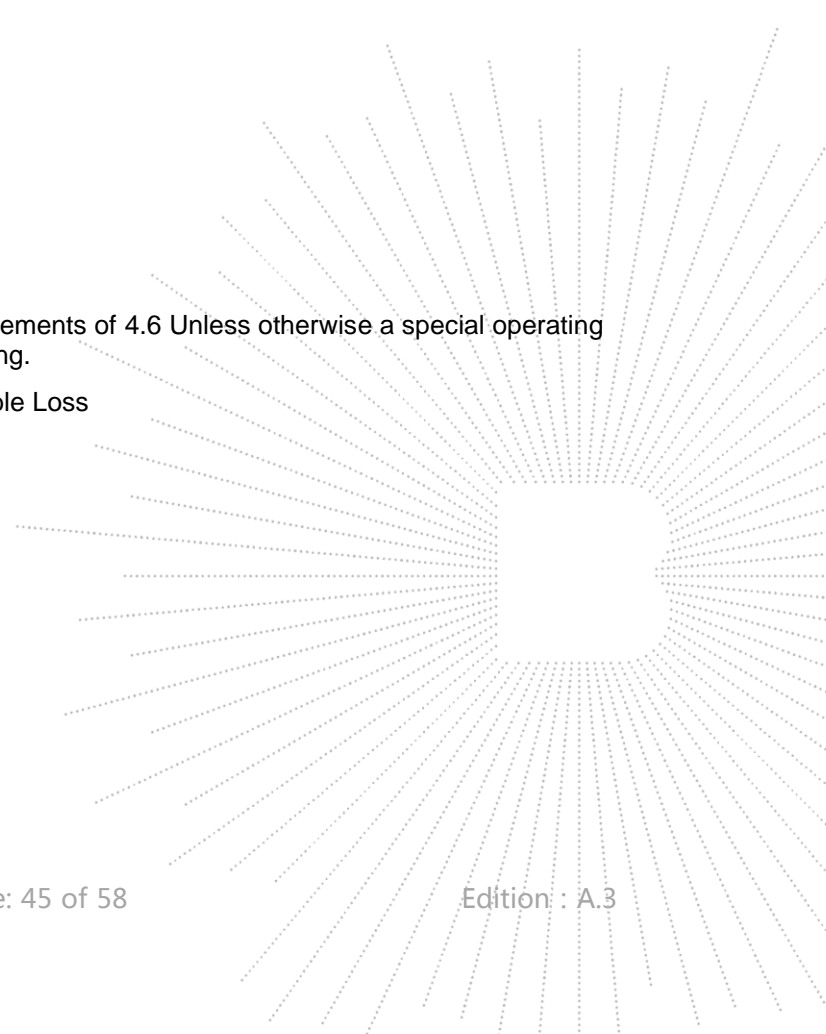

12.5 Test Result

Temperature :	26°C	Relative Humidity :	54%
Pressure :	101kPa	Test Voltage :	DC 12V

802.11b: Band Edge, Left Side

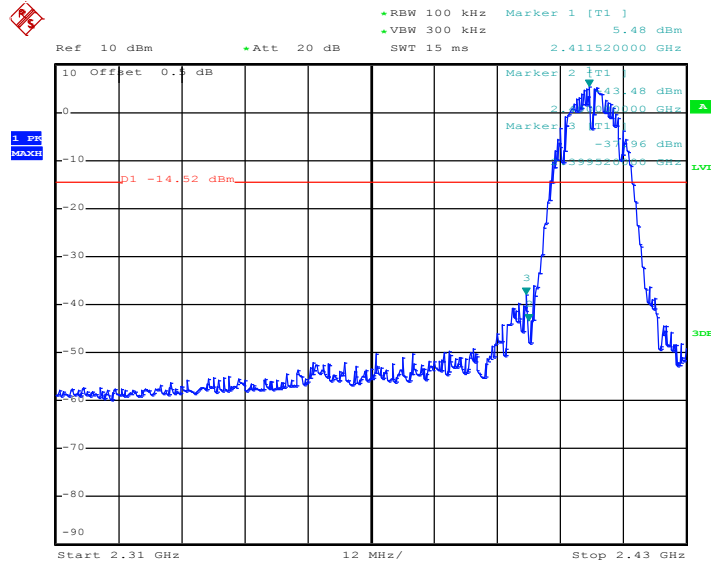

Date: 14.SEP.2021 14:39:07

802.11b: Band Edge, Right Side

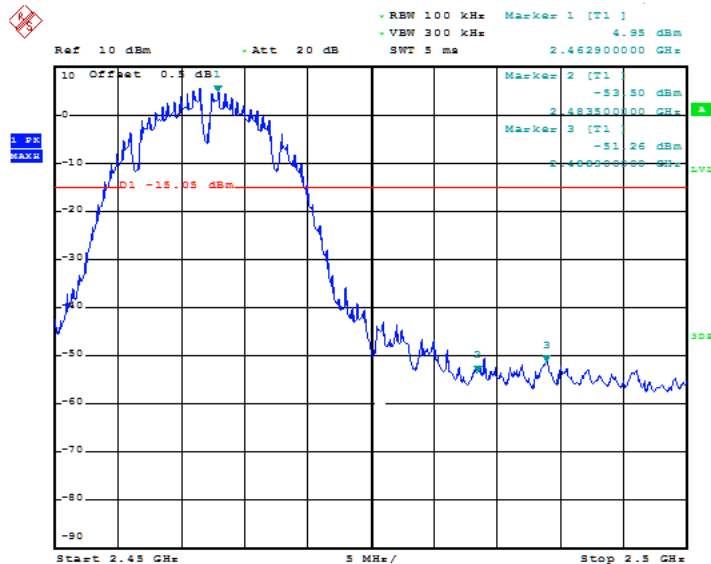

Date: 14.SEP.2021 14:41:28

802.11g: Band Edge, Left Side

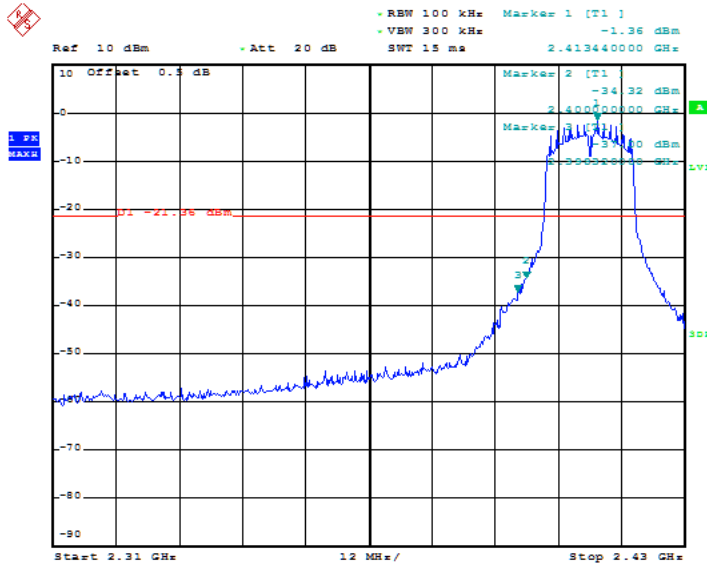

Date: 14.SEP.2021 14:44:44

802.11g: Band Edge, Right Side

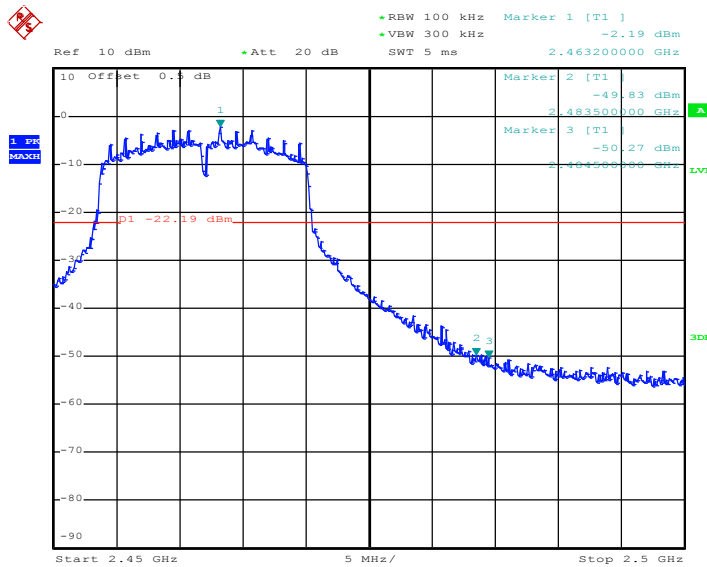

Date: 14.SEP.2021 14:43:32

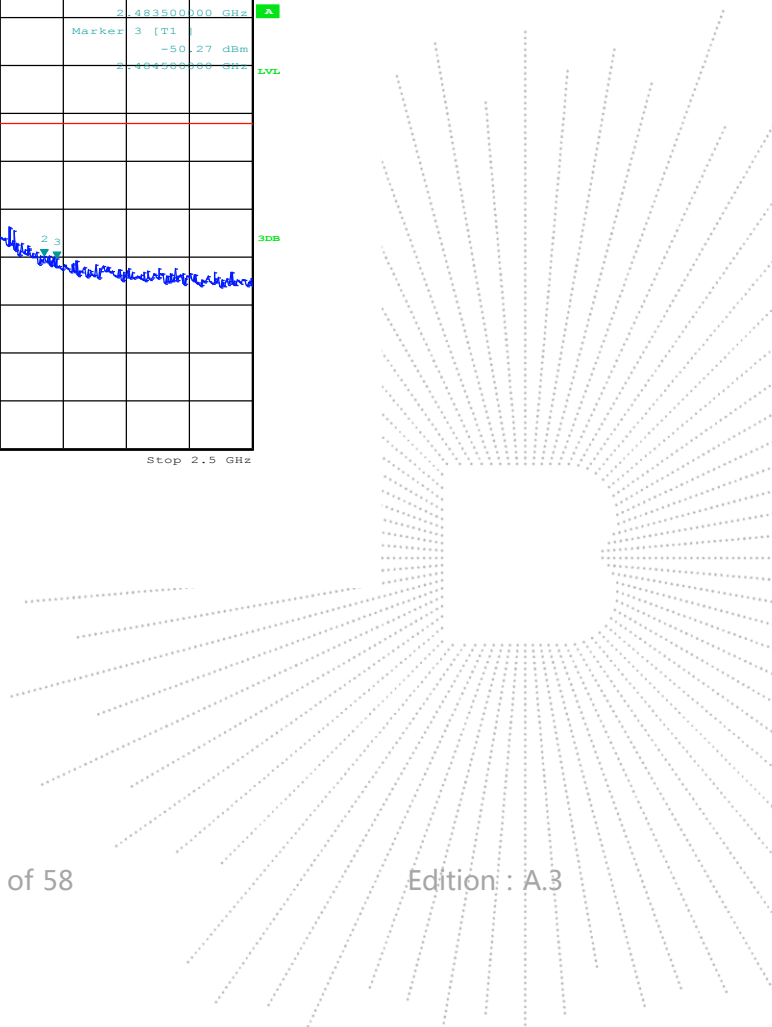

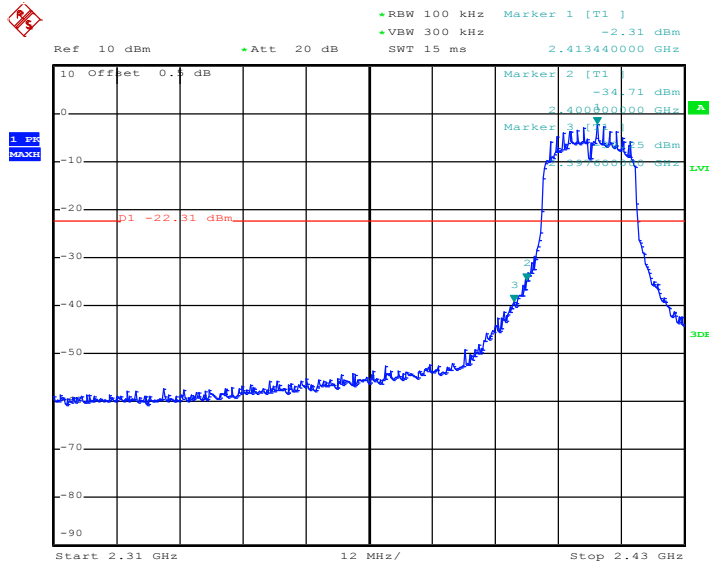
802.11n-HT20: Band Edge, Left Side

Date: 14.SEP.2021 14:46:43

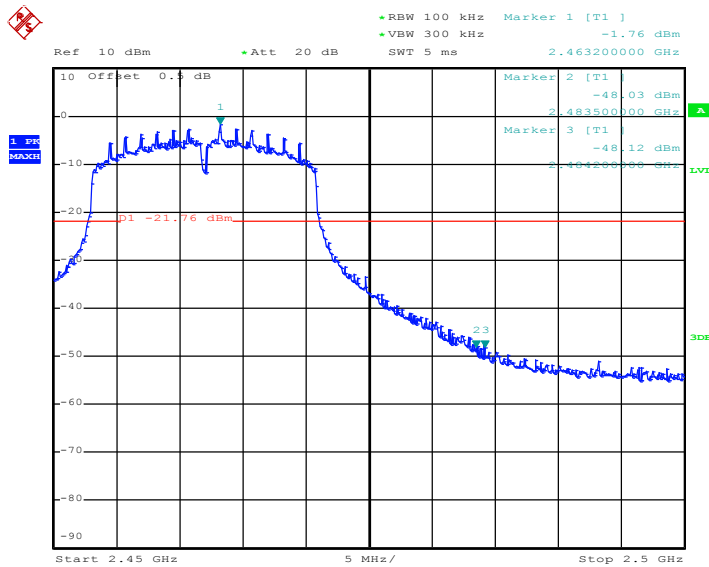
802.11n-HT20: Band Edge, Right Side

Date: 14.SEP.2021 14:49:32

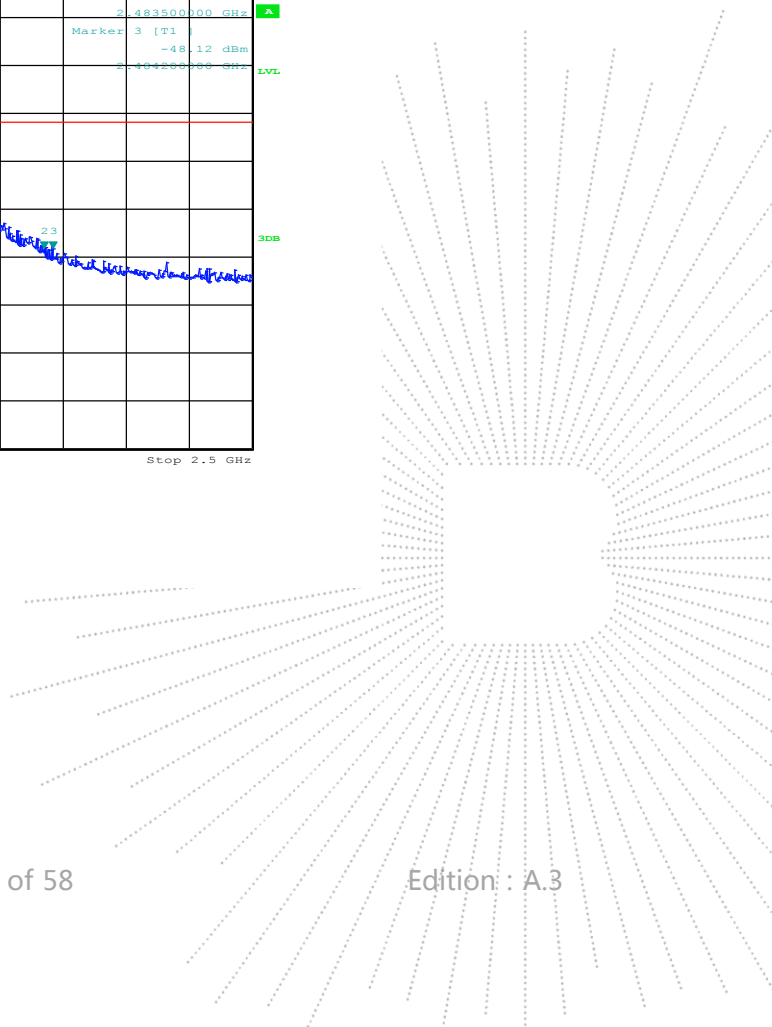

CONDUCTED EMISSION MEASUREMENT

802.11b

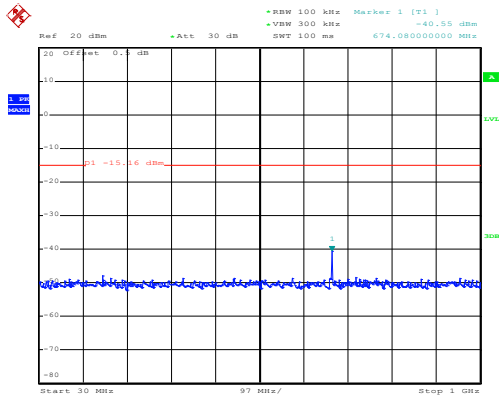
Low Channel 2412MHz

Date: 14.SEP.2021 11:10:46

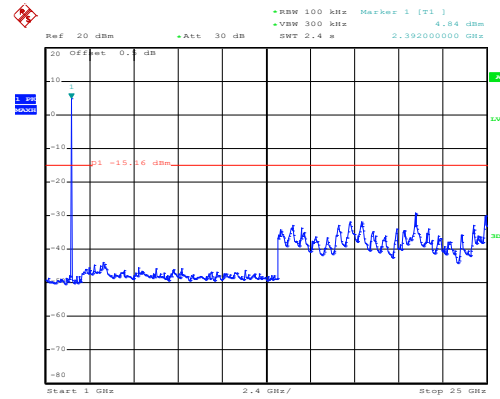

Date: 14.SEP.2021 11:09:34

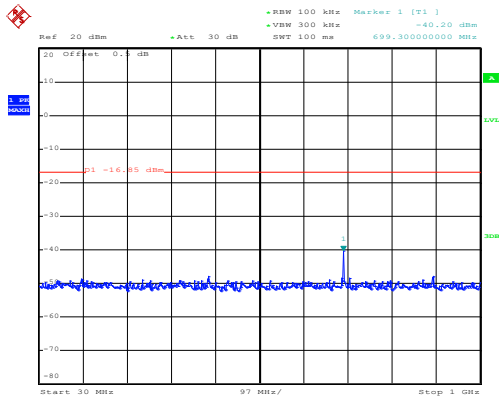
Middle Channel 2437MHz

Date: 14.SEP.2021 11:08:02

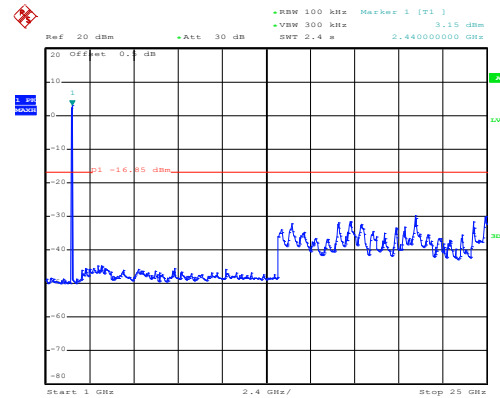

Date: 14.SEP.2021 11:07:42

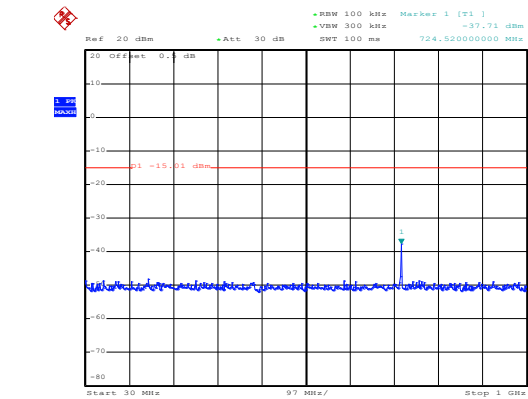
High Channel 2462MHz

Date: 14.SEP.2021 11:04:53

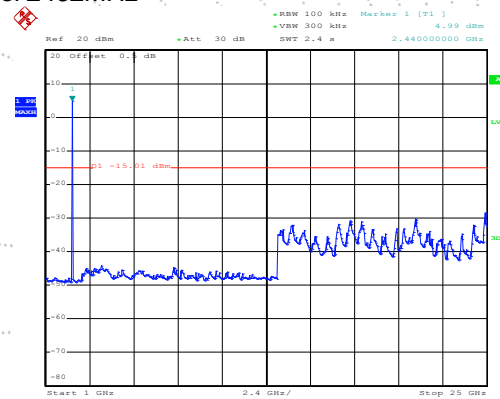

Date: 14.SEP.2021 11:04:28

802.11g

Low Channel 2412MHz

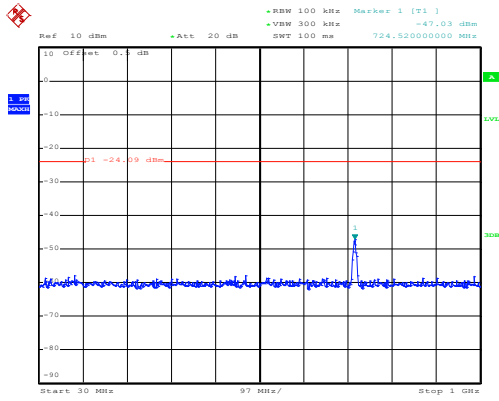

Date: 14.SEP.2021 11:22:11

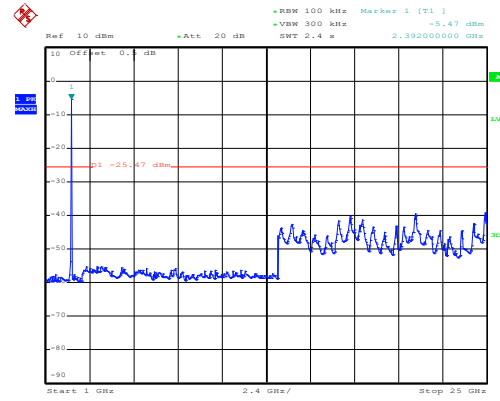

Date: 14.SEP.2021 11:16:10

Middle Channel 2437MHz

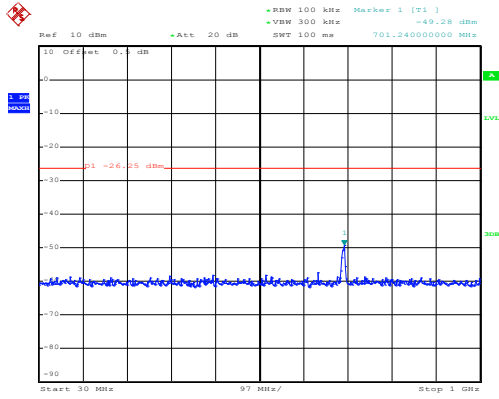

Date: 14.SEP.2021 11:19:47

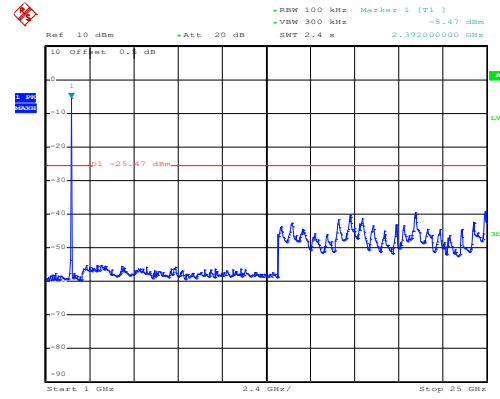

Date: 14.SEP.2021 11:16:10

High Channel 2462MHz

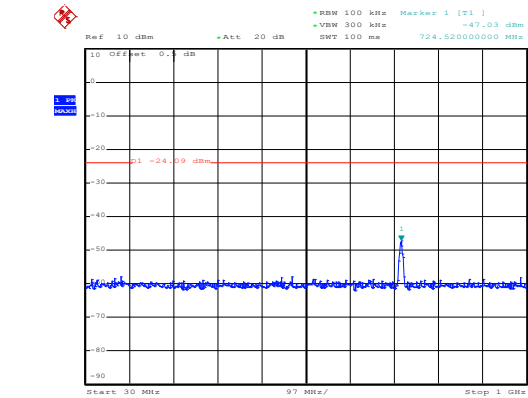

Date: 14.SEP.2021 11:22:11

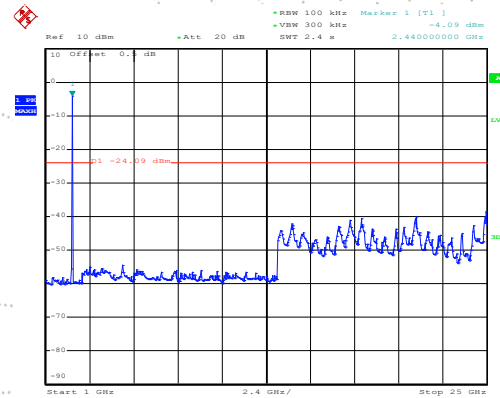

Date: 14.SEP.2021 11:21:20

802.11n20

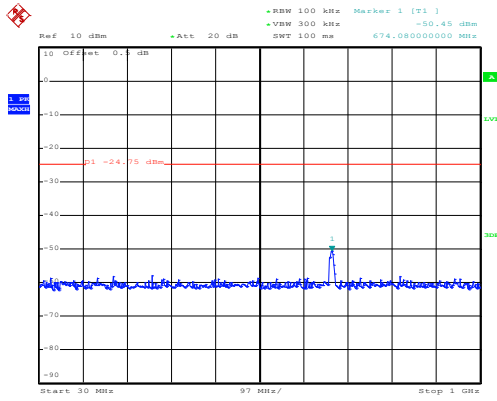
Low Channel 2412MHz

Date: 14.SEP.2021 11:25:50

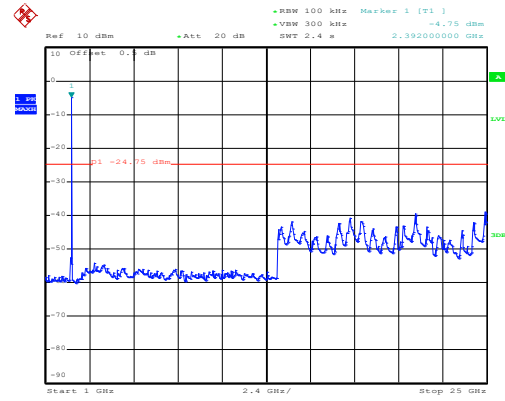

Date: 14.SEP.2021 11:25:24

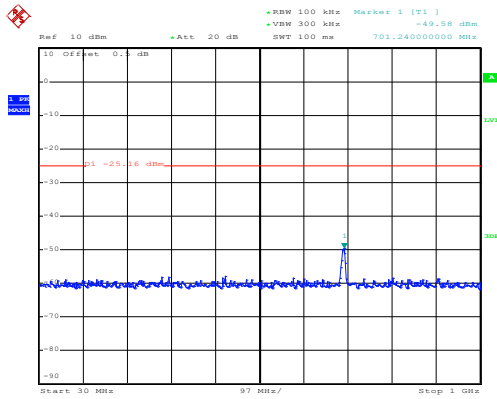
Middle Channel 2437MHz

Date: 14.SEP.2021 11:28:09

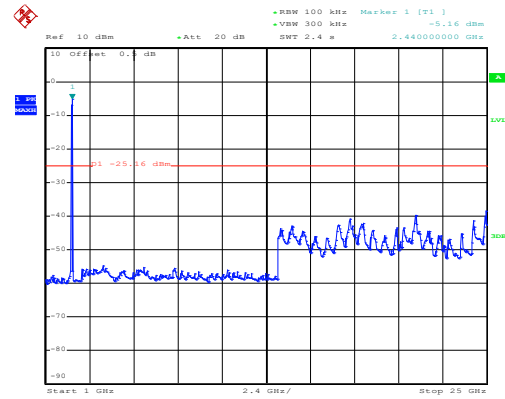

Date: 14.SEP.2021 11:27:35

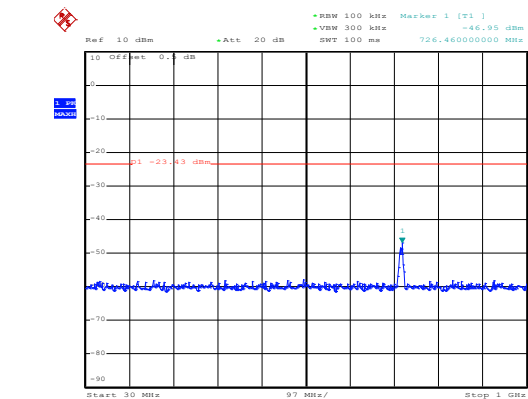
High Channel 2462MHz

Date: 14.SEP.2021 11:30:33

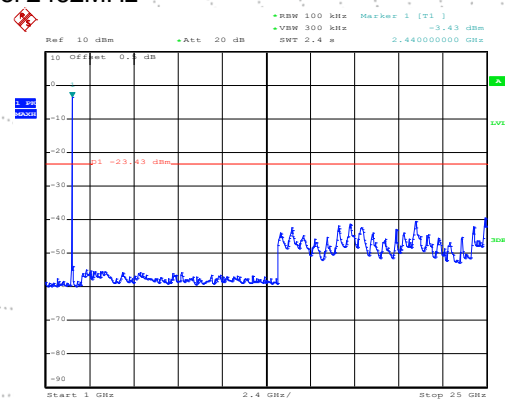

Date: 14.SEP.2021 11:29:41

13. Duty Cycle Of Test Signal

13.1 Standard Requirement

Pre-analysis Check: While conducting average power measurement, duty cycle of each mode shall be checked to ensure its duty cycle in order to compensate for the loss due to insufficient ratio of duty cycle. All duty cycle is pre-scanned, and result as obtained below shows only the most representative ones where duty cycle is conducted as the given transmission with given virtual operation that expresses the percentage.

13.2 Formula

$$\text{Duty Cycle} = \text{Ton} / (\text{Ton} + \text{Toff})$$

13.3 Test Procedure

1. Set span = Zero
2. RBW = 8MHz
3. VBW = 8MHz,
4. Detector = Peak

13.4 Test Result

	Duty Cycle	Duty Fator (dB)
802.11b	1	0
802.11g	1	0
802.11n(HT20)	1	0

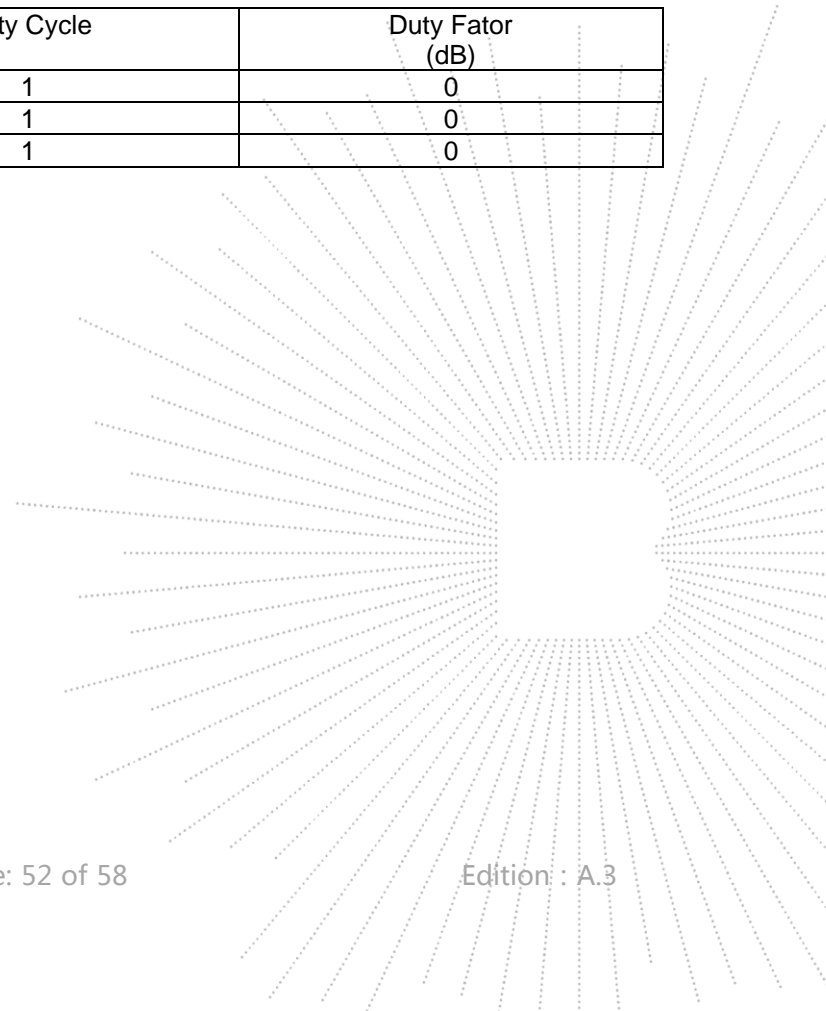

802.11b

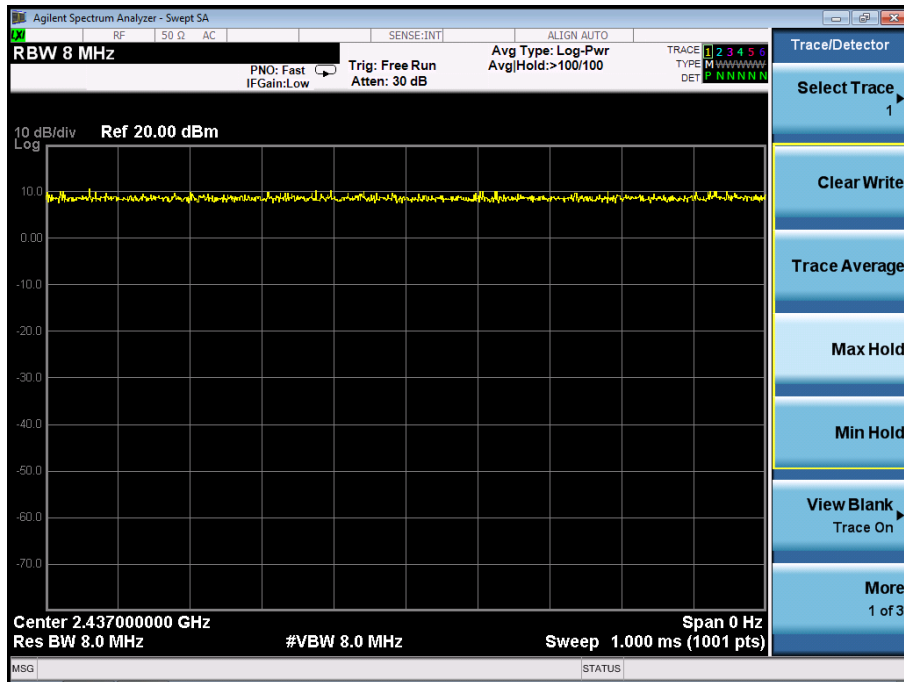

802.11g

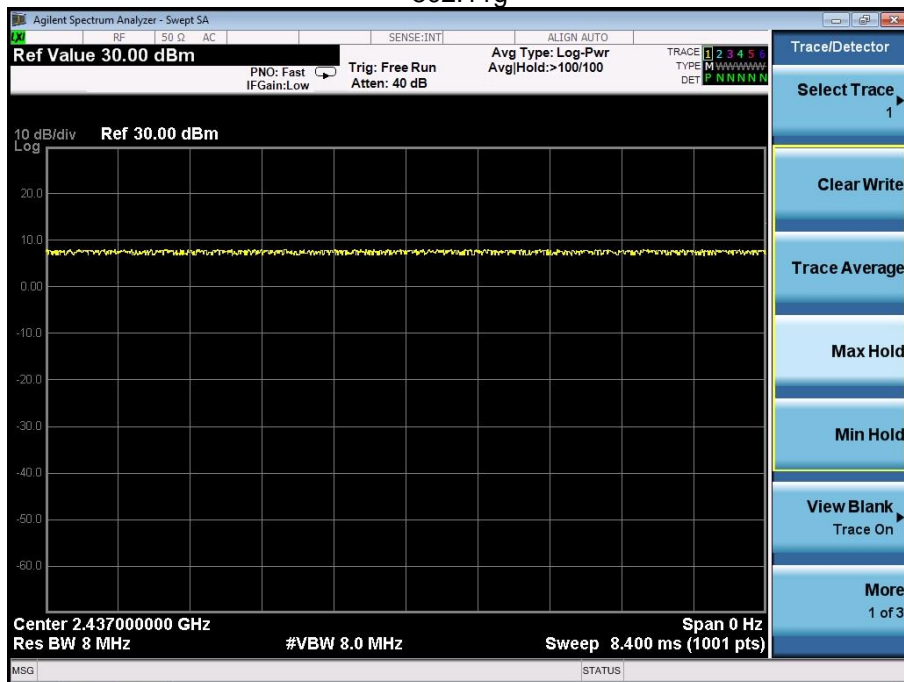

802.11n(HT20)

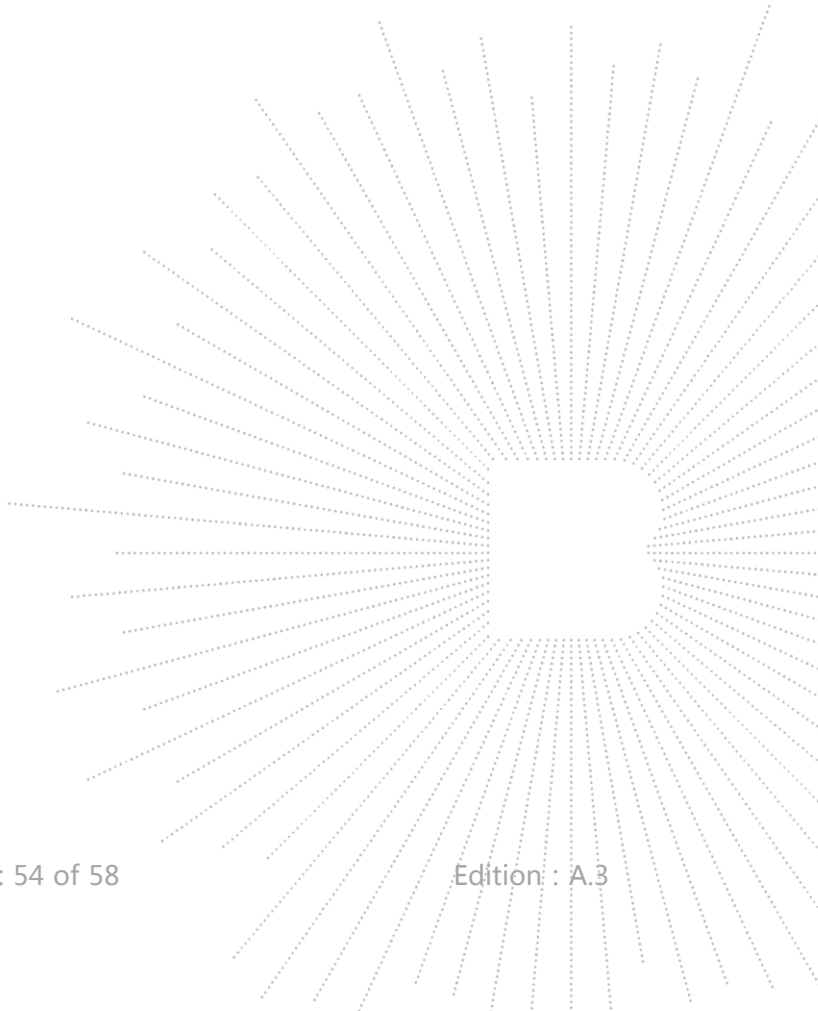
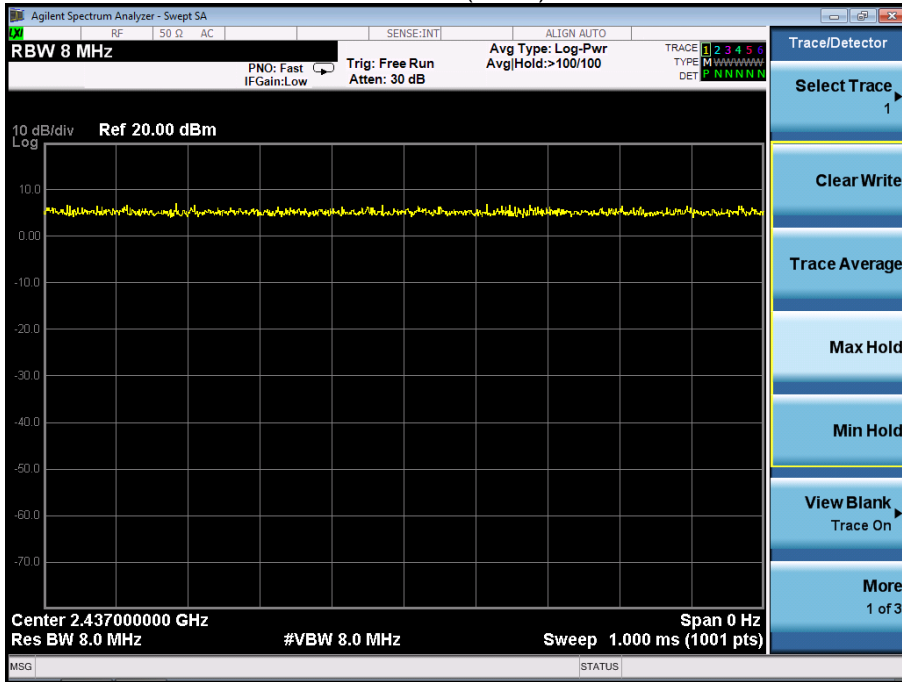

14. Antenna Requirement

14.1 Limit

15.203 requirement: For intentional device, according to 15.203: an intentional radiator shall be designed to ensure that no antenna other than that furnished by the responsible party shall be used with the device.

14.2 Test Result

The EUT antenna is FPC antenna, fulfill the requirement of this section.

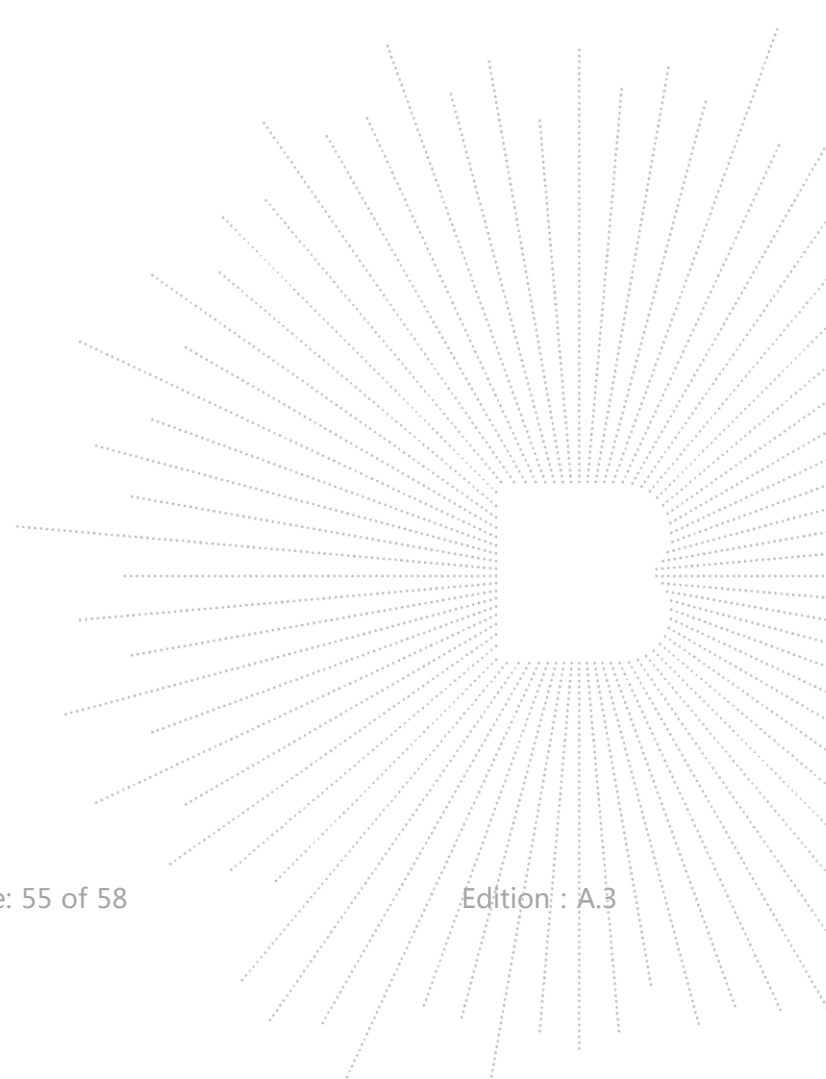

15. EUT Photographs

EUT Photo 1



EUT Photo 2

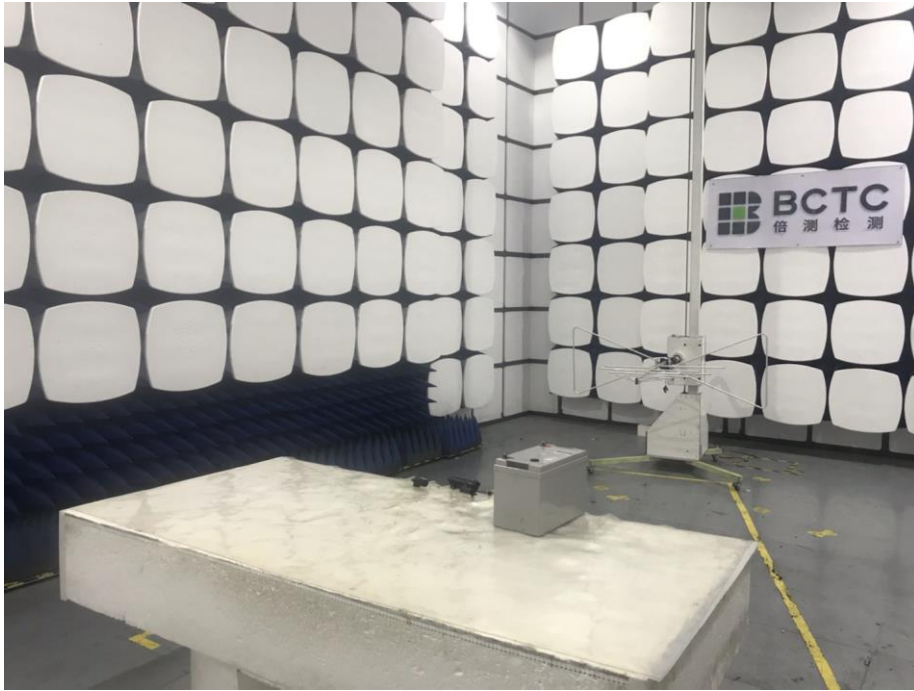

16. EUT Test Setup Photographs**Radiated Measurement Photos**

STATEMENT

- 1.The equipment lists are traceable to the national reference standards.
- 2.The test report can not be partially copied unless prior written approval is issued from our lab.
- 3.The test report is invalid without stamp of laboratory.
- 4.The test report is invalid without signature of person(s) testing and authorizing.
- 5.The test process and test result is only related to the Unit Under Test.
- 6.The quality system of our laboratory is in accordance with ISO/IEC17025.
- 7.If there is any objection to report, the client should inform issuing laboratory within 15 days from the date of receiving test report.

Address:

1-2/F., Building B, Pengzhou Industrial Park, No.158, Fuyuan 1st Road, Tangwei, Fuhai Subdistrict, Bao'an District, Shenzhen, Guangdong, China

TEL : 400-788-9558

P.C.: 518103

FAX : 0755-33229357

Website : <http://www.chnbctc.com>

E-Mail : bctc@bctc-lab.com.cn

***** END *****

