

FCC RADIO TEST REPORT

FCC ID: 2AMA8-T8PLUS-2

Product : Internet TV BOX

Trade Name : Zoomtak

Model Name : T8Plus-2

Serial Model : UPlus, UPro, M5Plus, NEXTGE 2.0,
APOLLO 1.0, T8Plus, T8plus-X,T8 max

Report No. : UNIA2018120101FR-01

Prepared for

Shen Zhen Zoomtak Electronics Co., Ltd
F6, A2 Building, HuaFeng Industrial Park, HangCheng Avenue, Gushu, Bao'an District
Shenzhen 518126 China

Prepared by

Shenzhen United Testing Technology Co., Ltd.
2F, Annex Bldg, Jiahuangyuan Tech Park, #365 Baotian 1 Rd, Tiegang
Community, Xixiang Str, Bao'an District, Shenzhen, China

TEST RESULT CERTIFICATION

Applicant's name : Shen Zhen Zoomtak Electronics Co., Ltd
Address : F6, A2 Building, HuaFeng Industrial Park, HangCheng Avenue, Gushu, Bao'an Distric Shenzhen 518126 China
Manufacture's Name : Shen Zhen Zoomtak Electronics Co., Ltd
Address : F6, A2 Building, HuaFeng Industrial Park, HangCheng Avenue, Gushu, Bao'an Distric Shenzhen 518126 China
Product description
Product name : Internet TV BOX
Trade Mark : Zoomtak
Model and/or type reference : T8Plus-2, UPlus, UPro, M5Plus, NEXTGE 2.0, APOLLO 1.0, T8Plus, T8plus-X, T8 max
Standards : FCC Rules and Regulations Part 15 Subpart C Section 15.247
 ANSI C63.10: 2013

This device described above has been tested by Shenzhen United Testing Technology Co., Ltd., and the test results show that the equipment under test (EUT) is in compliance with the FCC requirements. And it is applicable only to the tested sample identified in the report.

This report shall not be reproduced except in full, without the written approval of UNI, this document may be altered or revised by Shenzhen United Testing Technology Co., Ltd., personnel only, and shall be noted in the revision of the document.

Date of Test :
Date (s) of performance of tests : Dec. 26, 2018 ~ Jan. 03, 2019
Date of Issue : Jan. 04, 2019
Test Result : Pass

Prepared by:

Kaiming yang/Editor

Reviewer:

Sherwin Qian/Supervisor

Approved & Authorized Signer:

Liuze/Manager

| Table of Contents | Page |
|---|------|
| 1 . TEST SUMMARY | 5 |
| 2 . GENERAL INFORMATION | 6 |
| 2.1 GENERAL DESCRIPTION OF EUT | 6 |
| 2.2 Carrier Frequency of Channels | 7 |
| 2.3 Operation of EUT during testing | 7 |
| 2.4 DESCRIPTION OF TEST SETUP | 7 |
| 2.5 MEASUREMENT INSTRUMENTS LIST | 8 |
| 3 . CONDUCTED EMISSIONS TEST | 9 |
| 3.1 Conducted Power Line Emission Limit | 9 |
| 3.2 Test Setup | 9 |
| 3.3 Test Procedure | 9 |
| 3.4 Test Result | 9 |
| 4 RADIATED EMISSION TEST | 12 |
| 4.1 Radiation Limit | 12 |
| 4.2 Test Setup | 12 |
| 4.3 Test Procedure | 13 |
| 4.4 Test Result | 13 |
| 5 BAND EDGE | 28 |
| 5.1 Limits | 28 |
| 5.2 Test Procedure | 28 |
| 5.3 Test Result | 28 |
| 6 OCCUPIED BANDWIDTH MEASUREMENT | 36 |
| 6.1 Test Limit | 36 |
| 6.2 Test Procedure | 36 |
| 6.3 Measurement Equipment Used | 36 |
| 6.4 Test Result | 36 |
| 7 POWER SPECTRAL DENSITY TEST | 45 |
| 7.1 Test Limit | 45 |
| 7.2 Test Procedure | 45 |
| 7.3 Measurement Equipment Used | 45 |
| 7.4 Test Result | 45 |
| 8 PEAK OUTPUT POWER TEST | 54 |
| 8.1 Test Limit | 54 |
| 8.2 Test Procedure | 54 |

| Table of Contents | Page |
|--------------------------------|------|
| 8.3 Measurement Equipment Used | 54 |
| 8.4 Test Result | 54 |
| 9 OUT OF BAND EMISSIONS TEST | 55 |
| 9.1 Test Limit | 55 |
| 9.2 Test Procedure | 55 |
| 9.3 Test Setup | 55 |
| 9.4 Test Result | 55 |
| 10 ANTENNA REQUIREMENT | 60 |

1. TEST SUMMARY

1.1 TEST PROCEDURES AND RESULTS

| DESCRIPTION OF TEST | RESULT |
|--------------------------------|-----------|
| CONDUCTED EMISSIONS TEST | COMPLIANT |
| RADIATED EMISSION TEST | COMPLIANT |
| BAND EDGE | COMPLIANT |
| OCCUPIED BANDWIDTH MEASUREMENT | COMPLIANT |
| POWER SPECTRAL DENSITY | COMPLIANT |
| PEAK OUTPUT POWER | COMPLIANT |
| OUT OF BAND EMISSIONS | COMPLIANT |
| ANTENNA REQUIREMENT | COMPLIANT |

1.2 TEST FACILITY

Test Firm : Shenzhen United Testing Technology Co., Ltd.
 Address : 2F, Annex Bldg, Jiahuangyuan Tech Park, #365 Baotian 1 Rd, Tiegang Community, Xixiang Str, Bao'an District, Shenzhen, China

The testing quality ability of our laboratory meet with "Quality Law of People's Republic of China" Clause 19. The testing quality system of our laboratory meets with ISO/IEC-17025 requirements, which is approved by CNAS. This approval result is accepted by MRA of APLAC.

Our test facility is recognized, certified, or accredited by the following organizations:

CNAS-LAB Code: L6494

The EMC Laboratory has been assessed and in compliance with CNAS-CL01 accreditation criteria for testing Laboratories (identical to ISO/IEC 17025:2017 General Requirements) for the Competence of testing Laboratories.

Designation Number: CN1227

Test Firm Registration Number: 674885

The EMC Laboratory has been registered and fully described in a report filed with the (FCC) Federal Communications commission. The acceptance letter from the FCC is maintained in our files.

1.3 MEASUREMENT UNCERTAINTY

| Measurement Uncertainty | |
|---|---------------|
| Conducted Emission Expanded Uncertainty | = 2.23dB, k=2 |
| Radiated emission expanded uncertainty(9kHz-30MHz) | = 3.08dB, k=2 |
| Radiated emission expanded uncertainty(30MHz-1000MHz) | = 4.42dB, k=2 |
| Radiated emission expanded uncertainty(Above 1GHz) | = 4.06dB, k=2 |

2. GENERAL INFORMATION

2.1 GENERAL DESCRIPTION OF EUT

| | |
|--------------------|---|
| Equipment | Internet TV BOX |
| Trade Mark | Zoomtak |
| Model Name | T8Plus-2 |
| Serial No. | UPlus, UPro, M5Plus, NEXTGE 2.0, APOLLO 1.0, T8Plus, T8plus-X, T8 max |
| Model Difference | All model's the function, software and electric circuit are the same, only with a model named different. Test sample model: T8Plus-2. |
| FCC ID | 2AMA8-T8PLUS-2 |
| Antenna Type | Integration Antenna |
| Antenna Gain | 4dBi |
| Frequency Range | 802.11b/g/n20: 2412~2462 MHz 802.11n40: 2422~2452 MHz |
| Number of Channels | 802.11b/g/n20: 11CH 802.11n40: 9CH |
| Modulation Type | DSSS,OFDM,CCK,DQPSK |
| Battery | N/A |
| Power Source | DC 5V from adapter with AC 120V/60Hz |
| Adapter Model | M/N: TY0500200A1mn Input: AC 100-240V, 50/60Hz, 0.6A Output: DC 5V, 2A |

2.2 Carrier Frequency of Channels

| Channel List for 802.11b/g/n(20MHz) | | | | | | | |
|-------------------------------------|-----------------|---------|-----------------|---------|-----------------|---------|-----------------|
| Channel | Frequency (MHz) | Channel | Frequency (MHz) | Channel | Frequency (MHz) | Channel | Frequency (MHz) |
| 01 | 2412 | 04 | 2427 | 07 | 2442 | 10 | 2457 |
| 02 | 2417 | 05 | 2432 | 08 | 2447 | 11 | 2462 |
| 03 | 2422 | 06 | 2437 | 09 | 2452 | | |

| Channel List for 802.11n(40MHz) | | | | | | | |
|---------------------------------|-----------------|---------|-----------------|---------|-----------------|---------|-----------------|
| Channel | Frequency (MHz) | Channel | Frequency (MHz) | Channel | Frequency (MHz) | Channel | Frequency (MHz) |
| 01 | -- | 04 | 2427 | 07 | 2442 | 10 | -- |
| 02 | -- | 05 | 2432 | 08 | 2447 | 11 | -- |
| 03 | 2422 | 06 | 2437 | 09 | 2452 | | |

2.3 Operation of EUT during testing

Operating Mode

The mode is used:

Transmitting mode for 802.11b/g/n(20MHz)

Low Channel: 2412MHz

Middle Channel: 2437MHz

High Channel: 2462MHz

Transmitting mode for 802.11n(40MHz)

Low Channel: 2422MHz

Middle Channel: 2437MHz

High Channel: 2452MHz

2.4 DESCRIPTION OF TEST SETUP

Operation of EUT during Conducted testing:

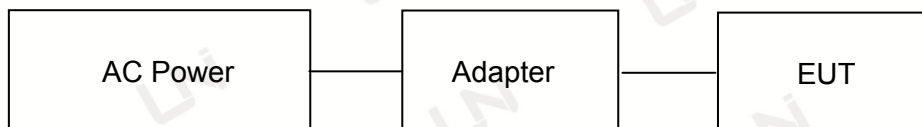

Operation of EUT during Radiation and Above 1GHz Radiation testing:



Table for auxiliary equipment:

| Equipment Description | Manufacturer | Model | Calibration Due Date |
|-----------------------|--------------|-------|----------------------|
| N/A | N/A | N/A | N/A |
| N/A | N/A | N/A | N/A |

2.5 MEASUREMENT INSTRUMENTS LIST

| Item | Equipment | Manufacturer | Model No. | Serial No. | Calibrated until |
|---------------------------------|-------------------------------------|---------------|-------------|---------------|------------------|
| CONDUCTED EMISSIONS TEST | | | | | |
| 1 | AMN | Schwarzbeck | NNLK8121 | 8121370 | 2019.9.9 |
| 2 | AMN | ETS | 3810/2 | 00020199 | 2019.9.9 |
| 3 | EMI TEST RECEIVER | Rohde&Schwarz | ESCI | 101210 | 2019.9.9 |
| 4 | AAN | TESEQ | T8-Cat6 | 38888 | 2019.9.9 |
| RADIATED EMISSION TEST | | | | | |
| 1 | Horn Antenna | Sunol | DRH-118 | A101415 | 2019.9.29 |
| 2 | BicoNILog Antenna | Sunol | JB1 Antenna | A090215 | 2019.9.29 |
| 3 | PREAMP | HP | 8449B | 3008A00160 | 2019.9.9 |
| 4 | PREAMP | HP | 8447D | 2944A07999 | 2019.9.9 |
| 5 | EMI TEST RECEIVER | Rohde&Schwarz | ESR3 | 101891 | 2019.9.9 |
| 6 | VECTOR Signal Generator | Rohde&Schwarz | SMU200A | 101521 | 2019.9.28 |
| 7 | Signal Generator | Agilent | E4421B | MY4335105 | 2019.9.28 |
| 8 | MXA Signal Analyzer | Agilent | N9020A | MY50510140 | 2019.9.28 |
| 9 | MXA Signal Analyzer | Agilent | N9020A | MY51110104 | 2019.9.9 |
| 10 | ANT Tower&Turn table Controller | Champro | EM 1000 | 60764 | 2019.9.28 |
| 11 | Anechoic Chamber | Taihe Maorui | 9m*6m*6m | 966A0001 | 2019.9.9 |
| 12 | Shielding Room | Taihe Maorui | 6.4m*4m*3m | 643A0001 | 2019.9.9 |
| 13 | RF Power sensor | DARE | RPR3006W | 15I00041SNO88 | 2019.3.14 |
| 14 | RF Power sensor | DARE | RPR3006W | 15I00041SNO89 | 2019.3.14 |
| 15 | RF power divider | Anritsu | K241B | 992289 | 2019.9.28 |
| 16 | Wideband radio communication tester | Rohde&Schwarz | CMW500 | 154987 | 2019.9.28 |
| 17 | Biconical antenna | Schwarzbeck | VHA 9103 | 91032360 | 2019.9.8 |
| 18 | Biconical antenna | Schwarzbeck | VHA 9103 | 91032361 | 2019.9.8 |
| 19 | Broadband Hybrid Antennas | Schwarzbeck | VULB9163 | VULB9163#958 | 2019.9.8 |
| 20 | Horn Antenna | Schwarzbeck | BBHA9120D | 9120D-1680 | 2019.1.12 |
| 21 | Active Receive Loop Antenna | Schwarzbeck | FMZB 1919B | 00023 | 2019.9.8 |
| 22 | Horn Antenna | Schwarzbeck | BBHA 9170 | BBHA9170651 | 2019.03.14 |
| 23 | Microwave Broadband Preamplifier | Schwarzbeck | BBV 9721 | 100472 | 2019.9.8 |
| 24 | Active Loop Antenna | Com-Power | AL-130R | 10160009 | 2019.05.10 |
| 25 | Power Meter | KEYSIGHT | N1911A | MY50520168 | 2019.05.10 |
| 26 | Frequency Meter | VICTOR | VC2000 | 997406086 | 2019.05.10 |
| 27 | DC Power Source | HYELEC | HY5020E | 055161818 | 2019.05.10 |

3. CONDUCTED EMISSIONS TEST

3.1 Conducted Power Line Emission Limit

For unintentional device, according to § 15.107(a) Line Conducted Emission Limits is as following

| Frequency (MHz) | Maximum RF Line Voltage(dB V) | | | |
|--------------------|-------------------------------|------|---------|--------|
| | CLASS A | | CLASS B | |
| | Q.P. | Ave. | Q.P. | Ave. |
| 0.15~0.50 | 79 | 66 | 66~56* | 56~46* |
| 0.50~5.00 | 73 | 60 | 56 | 46 |
| 5.00~30.0 | 73 | 60 | 60 | 50 |

* Decreasing linearly with the logarithm of the frequency

For intentional device, according to §15.207(a) Line Conducted Emission Limit is same as above table.

3.2 Test Setup

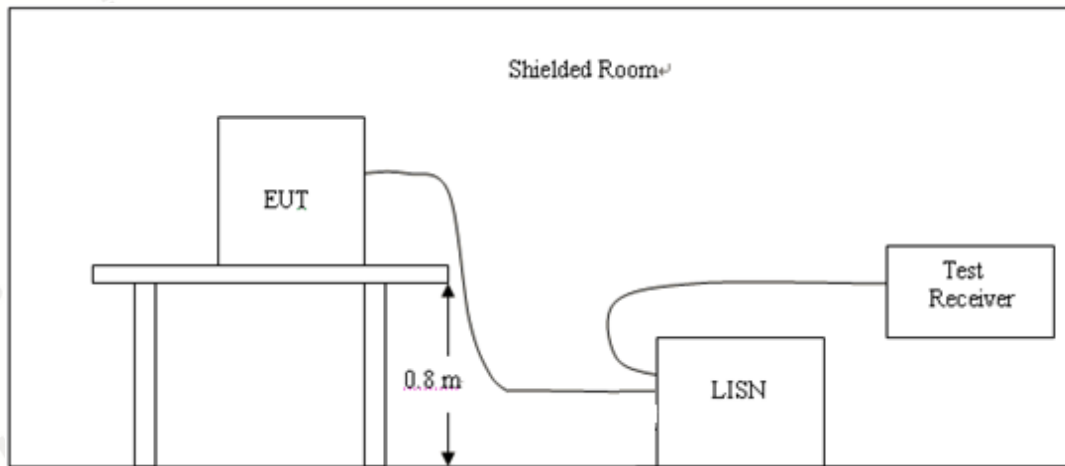

3.3 Test Procedure

- 1, The equipment was set up as per the test configuration to simulate typical actual usage per the user's manual. A wooden table with a height of 0.8 meters is used and is placed on the ground plane as per ANSI C63.10.
- 2, Support equipment, if needed, was placed as per ANSI C63.10.
- 3, All I/O cables were positioned to simulate typical actual usage as per ANSI C63.10.
- 4, If a EUT received DC power from the USB Port of Notebook PC, the PC's adapter received AC120V/60Hz power through a Line Impedance Stabilization Network (LISN) which supplied power source and was grounded to the ground plane.
- 5, All support equipments received AC power from a second LISN, if any.
- 6, The EUT test program was started. Emissions were measured on each current carrying line of the EUT using a spectrum Analyzer / Receiver connected to the LISN powering the EUT. The LISN has two monitoring points: Line 1 (Hot Side) and Line 2 (Neutral Side). Two scans were taken: one with Line 1 connected to Analyzer / Receiver and Line 2 connected to a 50 ohm load; the second scan had Line 1 connected to a 50 ohm load and Line 2 connected to the Analyzer / Receiver.
- 7, Analyzer / Receiver scanned from 150 KHz to 30MHz for emissions in each of the test modes.

3.4 Test Result

Pass

Remark:

1. All modes were tested at AC 120V and 240V, only the worst result of AC 120V was reported.
2. All modes were tested at Low, Middle, and High channel, only the worst result of 802.11b Low Channel was reported as below:

| | | | |
|---------------|--------------------------------------|--------------------|---------|
| Temperature: | 24°C | Relative Humidity: | 48% |
| Test Date: | Dec. 26, 2018 | Pressure: | 1010hPa |
| Test Voltage: | AC 120V, 60Hz | Phase: | Line |
| Test Mode: | Transmitting mode of 802.11b 2412MHz | | |

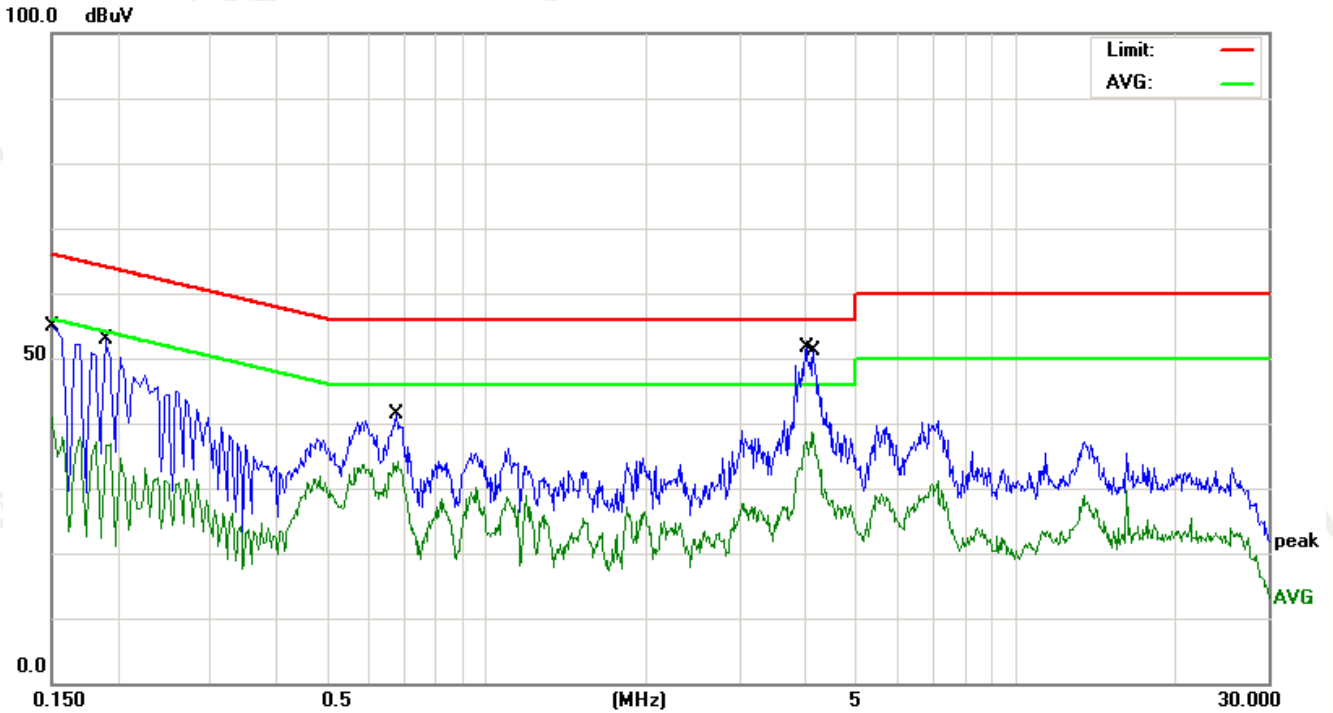

| No. | Mk. | Freq. MHz | Reading Level dBuV | Correct Factor dB | Measure- ment dBuV | Limit dBuV | Over dB | Detector |
|-----|-----|--------------|--------------------------|-------------------------|--------------------------|---------------|------------|----------|
| 1 | | 0.1500 | 28.94 | 11.94 | 40.88 | 55.99 | -15.11 | AVG |
| 2 | | 0.1900 | 41.53 | 11.26 | 52.79 | 64.03 | -11.24 | QP |
| 3 | | 0.6740 | 31.41 | 9.98 | 41.39 | 56.00 | -14.61 | QP |
| 4 | | 0.6780 | 24.19 | 9.98 | 34.17 | 46.00 | -11.83 | AVG |
| 5 | * | 4.0140 | 41.63 | 10.06 | 51.69 | 56.00 | -4.31 | QP |
| 6 | | 4.1180 | 28.67 | 10.06 | 38.73 | 46.00 | -7.27 | AVG |

Remark: Factor = Insertion Loss + Cable Loss, Result = Reading + Factor, Margin = Result – Limit.

| | | | |
|---------------|--------------------------------------|--------------------|---------|
| Temperature: | 24°C | Relative Humidity: | 48% |
| Test Date: | Dec. 26, 2018 | Pressure: | 1010hPa |
| Test Voltage: | AC 120V, 60Hz | Phase: | Neutral |
| Test Mode: | Transmitting mode of 802.11b 2412MHz | | |

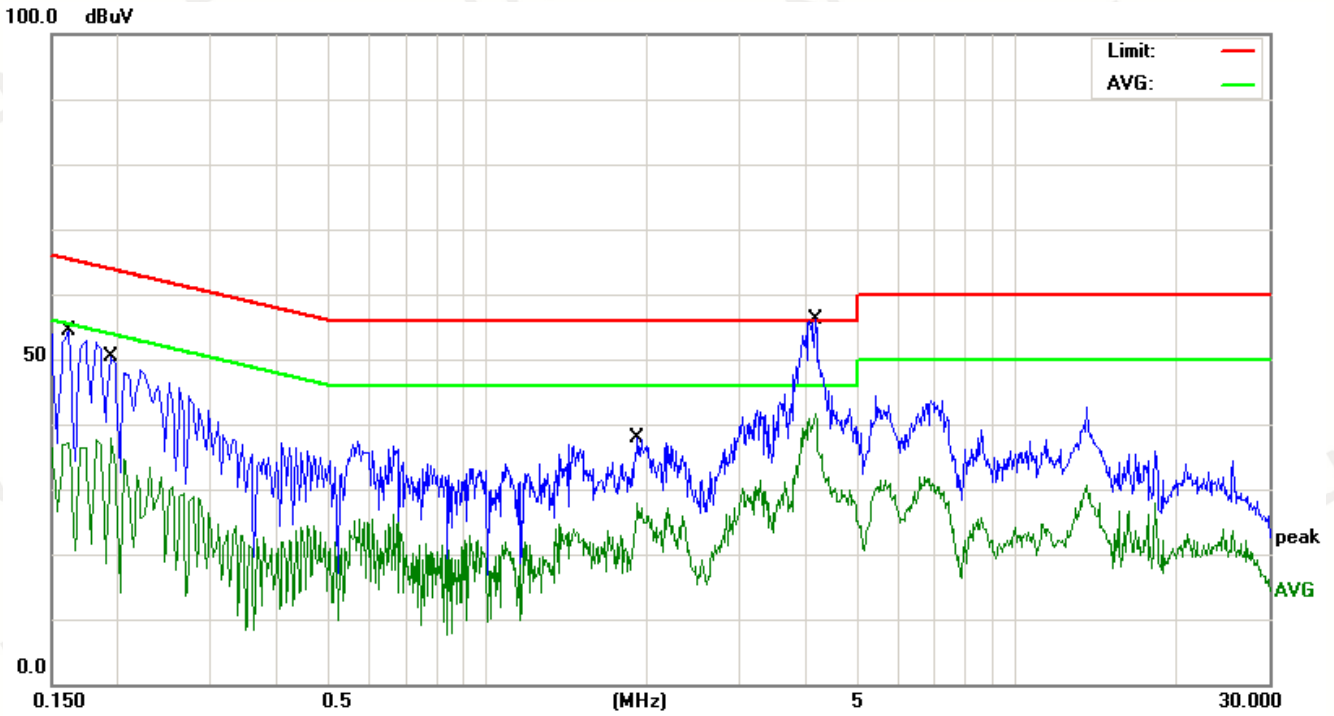

| No. | Mk. | Freq. MHz | Reading Level dBuV | Correct Factor dB | Measure- ment dBuV | Limit dBuV | Over dB | Detector |
|-----|-----|--------------|--------------------------|-------------------------|--------------------------|---------------|------------|----------|
| 1 | | 0.1620 | 42.71 | 11.68 | 54.39 | 65.36 | -10.97 | QP |
| 2 | | 0.1940 | 26.58 | 11.21 | 37.79 | 53.86 | -16.07 | AVG |
| 3 | | 1.9260 | 28.01 | 9.99 | 38.00 | 56.00 | -18.00 | QP |
| 4 | | 1.9260 | 17.84 | 9.99 | 27.83 | 46.00 | -18.17 | AVG |
| 5 | | 4.1740 | 39.04 | 10.06 | 49.10 | 56.00 | -6.90 | QP |
| 6 | * | 4.1740 | 31.68 | 10.06 | 41.74 | 46.00 | -4.26 | AVG |

Remark: Factor = Insertion Loss + Cable Loss, Result = Reading + Factor, Margin = Result – Limit.

4 RADIATED EMISSION TEST

4.1 Radiation Limit

For unintentional device, according to § 15.109(a), except for Class A digital devices, the field strength of radiated emissions from unintentional radiators at a distance of 3 meters shall not exceed the following values:

| Frequency (MHz) | Distance (Meters) | Radiated (dB μ V/m) | Radiated (μ V/m) |
|-----------------|-------------------|-------------------------|-----------------------|
| 30-88 | 3 | 40 | 100 |
| 88-216 | 3 | 43.5 | 150 |
| 216-960 | 3 | 46 | 200 |
| Above 960 | 3 | 54 | 500 |

For intentional device, according to § 15.209(a), the general requirement of field strength of radiated emissions from intentional radiators at a distance of 3 meters shall not exceed the above table.

4.2 Test Setup

1. Radiated Emission Test-Up Frequency Below 30MHz

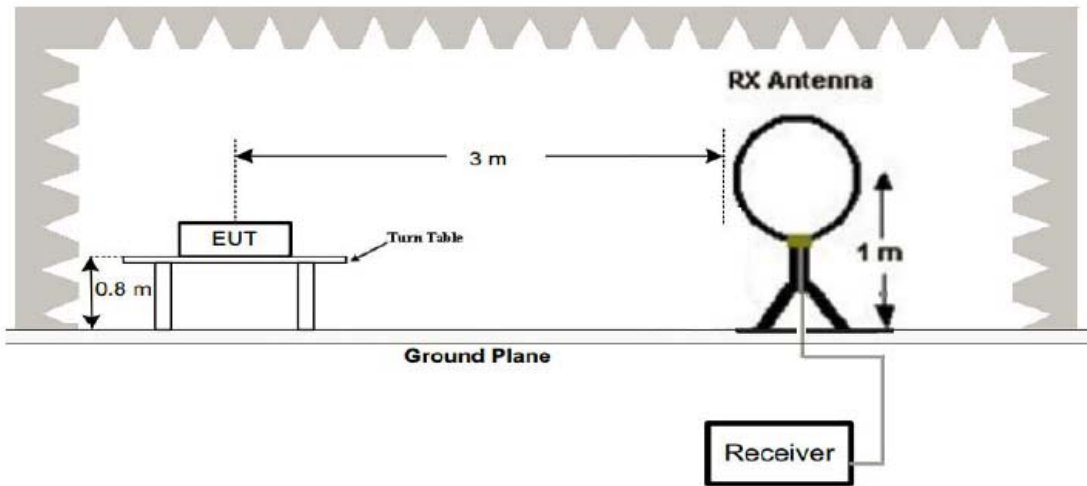

2. Radiated Emission Test-Up Frequency 30MHz~1GHz

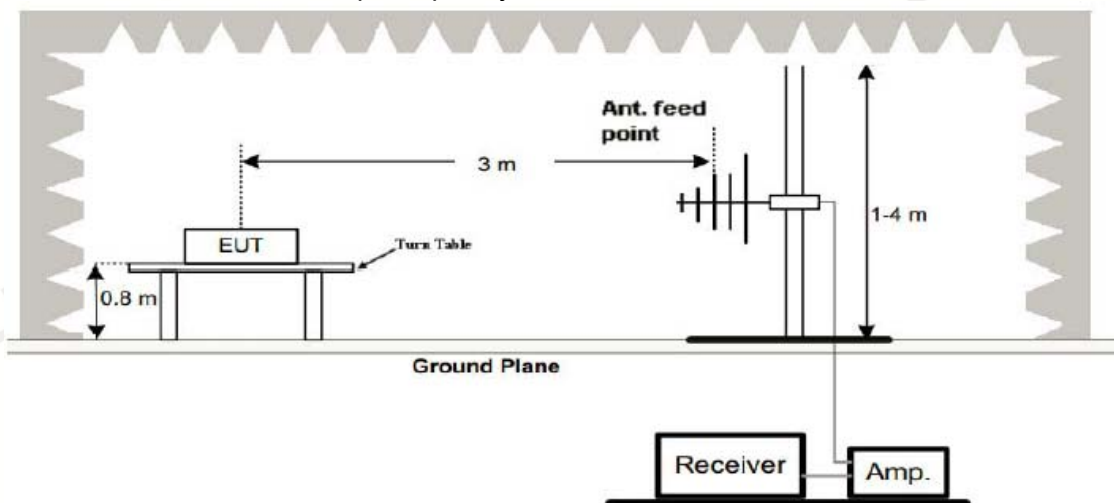

3. Radiated Emission Test-Up Frequency Above 1GHz

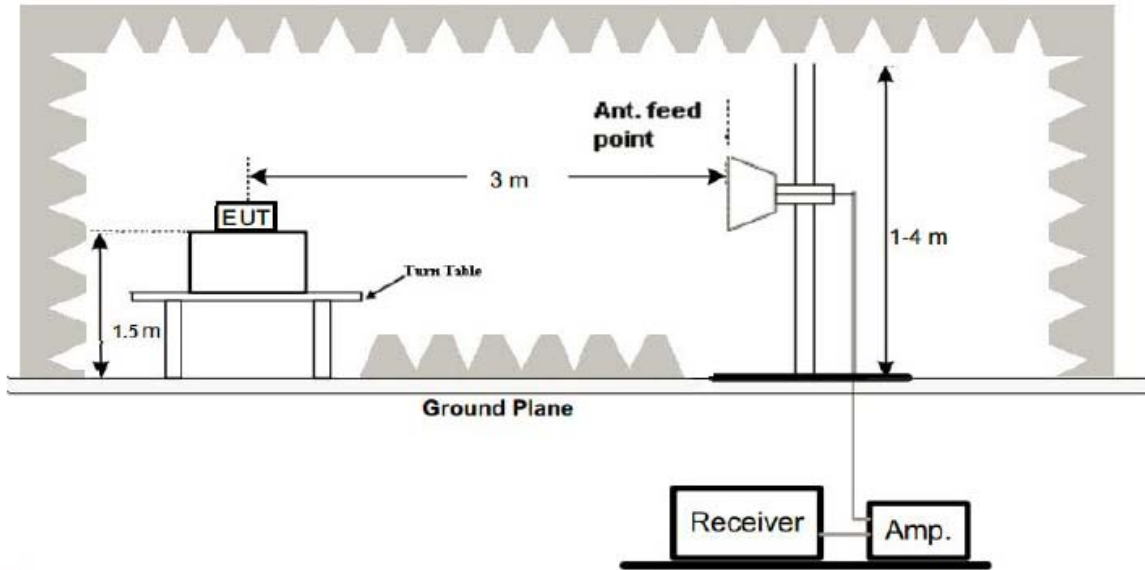

4.3 Test Procedure

1. Below 1GHz measurement the EUT is placed on turntable which is 0.8m above ground plane. And above 1GHz measurement EUT was placed on low permittivity and low tangent turn table which is 1.5m above ground plane.
2. The turntable shall be rotated for 360 degrees to determine the position of maximum emission level.
3. EUT is set 3m away from the receiving antenna, which is varied from 1m to 4m to find out the highest emissions.
4. Maximum procedure was performed on the six highest emissions to ensure EUT compliance.
5. And also, each emission was to be maximized by changing the polarization of receiving antenna both horizontal and vertical.
6. Repeat above procedures until the measurements for all frequencies are complete.
7. The test frequency range from 9KHz to 25GHz per FCC PART 15.33(a).

Note:

For battery operated equipment, the equipment tests shall be performed using a new battery.

4.4 Test Result

PASS

Remark:

1. All modes of 802.11b/g/n20/n40 were tested at Low, Middle, and High channel, and only the worst result of 802.11b Low Channel was reported for below 1GHz test.
2. By preliminary testing and verifying three axis (X, Y and Z) position of EUT transmitted status, it was found that "Z axis" position was the worst, and test data recorded in this report.

Below 1GHz Test Results:

| | | | |
|---------------|--------------------------------------|--------------------|------------|
| Temperature: | 22°C | Relative Humidity: | 48% |
| Test Date: | Dec. 26, 2018 | Pressure: | 1010hPa |
| Test Voltage: | AC 120V, 60Hz | Polarization: | Horizontal |
| Test Mode: | Transmitting mode of 802.11b 2412MHz | | |

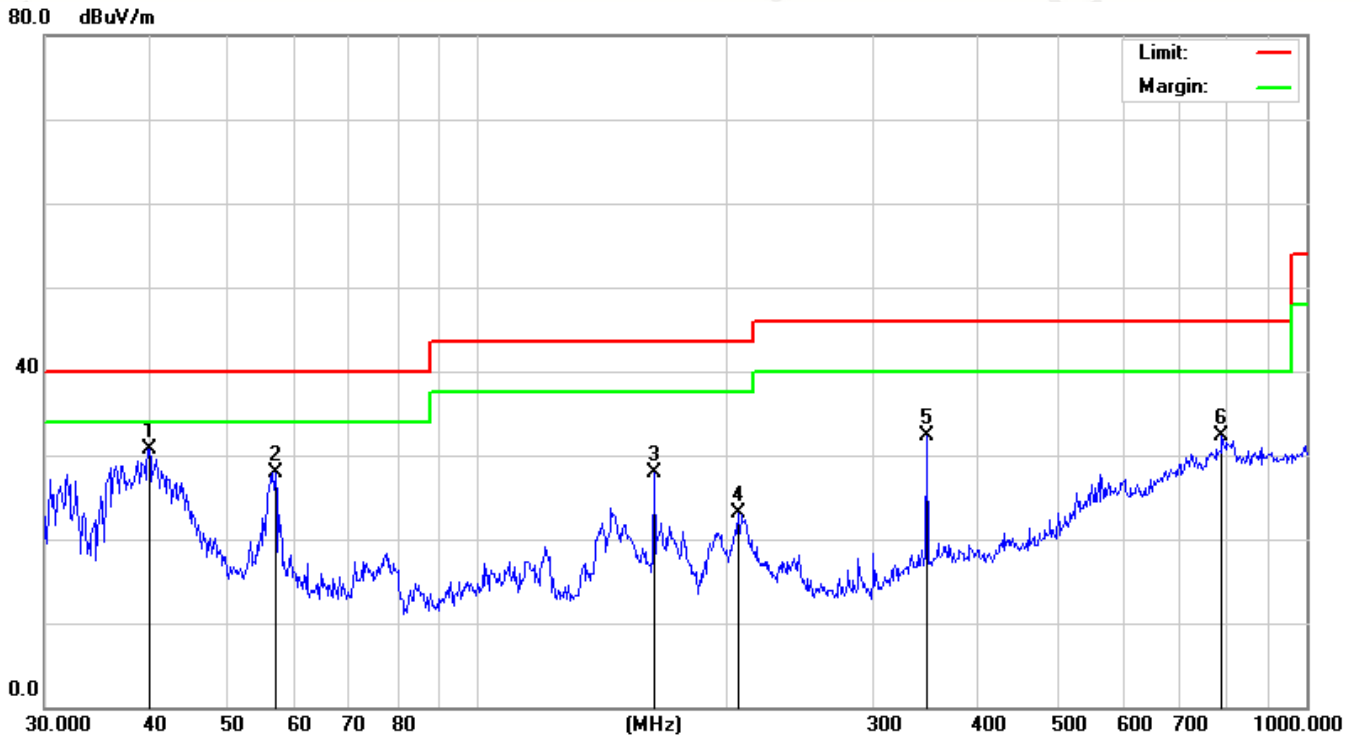

| No. | Mk. | Freq. MHz | Reading Level dBuV | Correct Factor dB | Measure- ment dBuV/m | Limit dBuV/m | Over dB | Detector |
|-----|-----|--------------|--------------------------|-------------------------|----------------------------|-----------------|------------|----------|
| 1 | * | 40.1347 | 34.96 | -4.20 | 30.76 | 40.00 | -9.24 | QP |
| 2 | | 56.9911 | 34.78 | -6.94 | 27.84 | 40.00 | -12.16 | QP |
| 3 | | 163.1818 | 36.78 | -8.80 | 27.98 | 43.50 | -15.52 | QP |
| 4 | | 206.3976 | 27.95 | -4.93 | 23.02 | 43.50 | -20.48 | QP |
| 5 | | 348.0274 | 37.31 | -4.95 | 32.36 | 46.00 | -13.64 | QP |
| 6 | | 790.6187 | 24.71 | 7.69 | 32.40 | 46.00 | -13.60 | QP |

Remark: Absolute Level = Reading Level + Factor, Margin = Absolute Level – Limit
 Factor = Ant. Factor + Cable Loss – Pre-amplifier

| | | | |
|---------------|--------------------------------------|--------------------|----------|
| Temperature: | 22°C | Relative Humidity: | 48% |
| Test Date: | Dec. 26, 2018 | Pressure: | 1010hPa |
| Test Voltage: | AC 120V, 60Hz | Polarization: | Vertical |
| Test Mode: | Transmitting mode of 802.11b 2412MHz | | |

80.0 dBuV/m

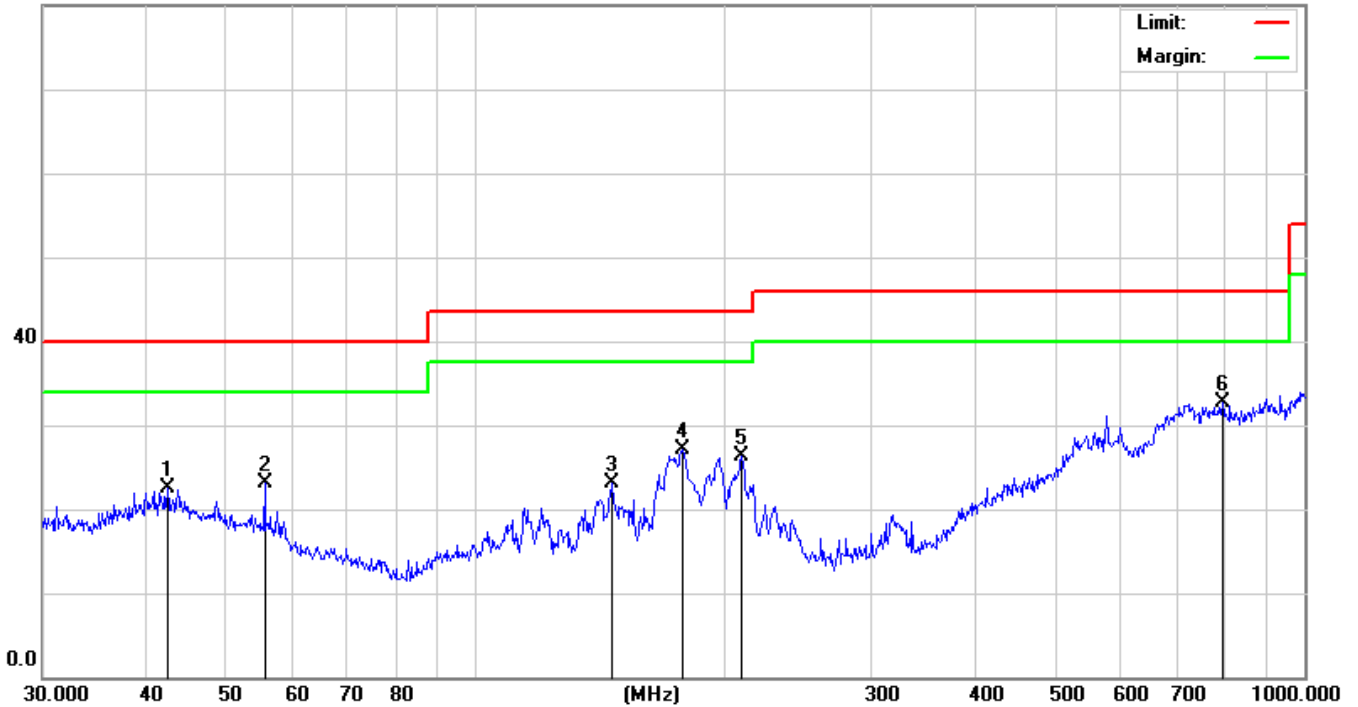

| No. | Mk. | Freq. MHz | Reading Level dBuV | Correct Factor dB | Measure- ment dBuV/m | Limit dBuV/m | Over dB | Detector |
|-----|-----|--------------|--------------------------|-------------------------|----------------------------|-----------------|------------|----------|
| 1 | | 42.4508 | 24.45 | -1.94 | 22.51 | 40.00 | -17.49 | QP |
| 2 | | 55.6094 | 27.47 | -4.42 | 23.05 | 40.00 | -16.95 | QP |
| 3 | | 145.8611 | 29.83 | -6.77 | 23.06 | 43.50 | -20.44 | QP |
| 4 | | 177.5092 | 33.99 | -6.91 | 27.08 | 43.50 | -16.42 | QP |
| 5 | | 209.3129 | 33.43 | -7.14 | 26.29 | 43.50 | -17.21 | QP |
| 6 | * | 796.1830 | 25.16 | 7.45 | 32.61 | 46.00 | -13.39 | QP |

Remark: Absolute Level = Reading Level + Factor, Margin = Absolute Level – Limit
 Factor = Ant. Factor + Cable Loss – Pre-amplifier

Remark:

- (1) Measuring frequencies from 9 KHz to the 1 GHz, Radiated emission test from 9KHz to 30MHz was verified, and no any emission was found except system noise floor.
- (2) * denotes emission frequency which appearing within the Restricted Bands specified in provision of 15.205, then the general radiated emission limits in 15.209 apply.
- (3) The IF bandwidth of EMI Test Receiver between 30MHz to 1GHz was 120KHz, 1 MHz for measuring above 1 GHz, below 30MHz was 10KHz.

Above 1 GHz Test Results:

CH Low of 802.11b Mode (2412MHz)

Horizontal:

| Frequency (MHz) | Reading Result (dBµV) | Factor (dB) | Emission Level (dBµV/m) | Limits (dBµV/m) | Margin (dB) | Detector Type |
|--------------------|--------------------------|----------------|----------------------------|--------------------|----------------|------------------|
| 4824 | 53.25 | 5.08 | 58.33 | 74 | -15.67 | PK |
| 4824 | 42.81 | 5.08 | 47.89 | 54 | -6.11 | AV |
| 7236 | 47.28 | 7.16 | 54.44 | 74 | -19.56 | PK |
| 7236 | 35.18 | 7.16 | 42.34 | 54 | -11.66 | AV |

Remark: Factor = Antenna Factor + Cable Loss – Pre-amplifier. Margin = Absolute Level – Limit

Vertical:

| Frequency (MHz) | Reading Result (dBµV) | Factor (dB) | Emission Level (dBµV/m) | Limits (dBµV/m) | Margin (dB) | Detector Type |
|--------------------|--------------------------|----------------|----------------------------|--------------------|----------------|------------------|
| 4824 | 54.44 | 5.08 | 59.52 | 74 | -14.48 | PK |
| 4824 | 42.82 | 5.08 | 47.90 | 54 | -6.10 | AV |
| 7236 | 47.25 | 7.16 | 54.41 | 74 | -19.59 | PK |
| 7236 | 36.87 | 7.16 | 44.03 | 54 | -9.97 | AV |

Remark: Factor = Antenna Factor + Cable Loss – Pre-amplifier. Margin = Absolute Level – Limit

CH Middle of 802.11b Mode (2437MHz)

Horizontal:

| Frequency | Reading Result | Factor | Emission Level | Limits | Margin | Detector |
|-----------|----------------|--------|----------------|----------------|--------|----------|
| (MHz) | (dB μ V) | (dB) | (dB μ V/m) | (dB μ V/m) | (dB) | Type |
| 4874 | 53.88 | 5.13 | 59.01 | 74 | -14.99 | PK |
| 4874 | 40.28 | 5.13 | 45.41 | 54 | -8.59 | AV |
| 7311 | 48.15 | 7.49 | 55.64 | 74 | -18.36 | PK |
| 7311 | 36.26 | 7.49 | 43.75 | 54 | -10.25 | AV |

Remark: Factor = Antenna Factor + Cable Loss – Pre-amplifier. Margin = Absolute Level – Limit

Vertical:

| Frequency | Reading Result | Factor | Emission Level | Limits | Margin | Detector |
|-----------|----------------|--------|----------------|----------------|--------|----------|
| (MHz) | (dB μ V) | (dB) | (dB μ V/m) | (dB μ V/m) | (dB) | Type |
| 4874 | 55.47 | 5.13 | 60.60 | 74 | -13.4 | PK |
| 4874 | 43.5 | 5.13 | 48.63 | 54 | -5.37 | AV |
| 7311 | 47.72 | 7.49 | 55.21 | 74 | -18.79 | PK |
| 7311 | 36.18 | 7.49 | 43.67 | 54 | -10.33 | AV |

Remark: Factor = Antenna Factor + Cable Loss – Pre-amplifier. Margin = Absolute Level – Limit

CH High of 802.11b Mode (2462MHz)

Horizontal:

| Frequency | Reading Result | Factor | Emission Level | Limits | Margin | Detector |
|-----------|----------------|--------|----------------|----------------|--------|----------|
| (MHz) | (dB μ V) | (dB) | (dB μ V/m) | (dB μ V/m) | (dB) | Type |
| 4924 | 53.14 | 5.18 | 58.32 | 74 | -15.68 | PK |
| 4924 | 41.42 | 5.18 | 46.60 | 54 | -7.40 | AV |
| 7386 | 47.45 | 7.82 | 55.27 | 74 | -18.73 | PK |
| 7386 | 35.62 | 7.82 | 43.44 | 54 | -10.56 | AV |

Remark: Factor = Antenna Factor + Cable Loss – Pre-amplifier. Margin = Absolute Level – Limit

Vertical:

| Frequency | Reading Result | Factor | Emission Level | Limits | Margin | Detector |
|-----------|----------------|--------|----------------|----------------|--------|----------|
| (MHz) | (dB μ V) | (dB) | (dB μ V/m) | (dB μ V/m) | (dB) | Type |
| 4924 | 54.25 | 5.18 | 59.43 | 74 | -14.57 | PK |
| 4924 | 43.14 | 5.18 | 48.32 | 54 | -5.68 | AV |
| 7386 | 46.89 | 7.82 | 54.71 | 74 | -19.29 | PK |
| 7386 | 35.29 | 7.82 | 43.11 | 54 | -10.89 | AV |

Remark: Factor = Antenna Factor + Cable Loss – Pre-amplifier. Margin = Absolute Level – Limit

Remark :

- (1) Measuring frequencies from 1 GHz to the 25 GHz.
- (2) "F" denotes fundamental frequency; "H" denotes spurious frequency. "E" denotes band edge frequency.
- (3) * denotes emission frequency which appearing within the Restricted Bands specified in provision of 15.205, then the general radiated emission limits in 15.209 apply.
- (4) Data of measurement within this frequency range shown "---" in the table above means the reading of emissions are attenuated more than 20dB below the permissible limits or the field strength is too small to be measured.
- (5) The IF bandwidth of EMI Test Receiver between 30MHz to 1GHz was 120KHz, 1 MHz for measuring above 1 GHz, below 30MHz was 10KHz. The resolution bandwidth of test receiver/spectrum analyzer is 1MHz and video bandwidth is 3MHz for peak measurement with peak detector at frequency above 1GHz. The resolution bandwidth of test receiver/spectrum analyzer is 1MHz and video bandwidth is 10Hz for Average measurement with peak detection at frequency above 1GHz.
- (6) When the test results of Peak Detected below the limits of Average Detected, the Average Detected is not need completed. For example: Top Channel at Fundamental 73.16dBuV/m(PK Value) <93.98(AV Limit), at harmonic 53.20 dBuV/m(PK Value) <54 dBuV/m(AV Limit), the Average Detected not need to completed.

CH Low of 802.11g Mode (2412MHz)

Horizontal:

| Frequency (MHz) | Reading Result (dB μ V) | Factor (dB) | Emission Level (dB μ V/m) | Limits (dB μ V/m) | Margin (dB) | Detector Type |
|--------------------|--------------------------------|----------------|----------------------------------|--------------------------|----------------|------------------|
| 4824 | 52.88 | 5.08 | 57.96 | 74 | -16.04 | PK |
| 4824 | 41.32 | 5.08 | 46.40 | 54 | -7.60 | AV |
| 7236 | 47.23 | 7.16 | 54.39 | 74 | -19.61 | PK |
| 7236 | 35.85 | 7.16 | 43.01 | 54 | -10.99 | AV |

Remark: Factor = Antenna Factor + Cable Loss – Pre-amplifier. Margin = Absolute Level – Limit

Vertical:

| Frequency (MHz) | Reading Result (dB μ V) | Factor (dB) | Emission Level (dB μ V/m) | Limits (dB μ V/m) | Margin (dB) | Detector Type |
|--------------------|--------------------------------|----------------|----------------------------------|--------------------------|----------------|------------------|
| 4824 | 55.52 | 5.08 | 60.60 | 74 | -13.4 | PK |
| 4824 | 43.55 | 5.08 | 48.63 | 54 | -5.37 | AV |
| 7236 | 46.97 | 7.16 | 54.13 | 74 | -19.87 | PK |
| 7236 | 33.12 | 7.16 | 40.28 | 54 | -13.72 | AV |

Remark: Factor = Antenna Factor + Cable Loss – Pre-amplifier. Margin = Absolute Level – Limit

CH Middle of 802.11g Mode (2437MHz)

Horizontal:

| Frequency | Reading Result | Factor | Emission Level | Limits | Margin | Detector |
|-----------|----------------|--------|----------------|----------------|--------|----------|
| (MHz) | (dB μ V) | (dB) | (dB μ V/m) | (dB μ V/m) | (dB) | Type |
| 4874 | 53.21 | 5.13 | 58.34 | 74 | -15.66 | PK |
| 4874 | 40.78 | 5.13 | 45.91 | 54 | -8.09 | AV |
| 7311 | 48.31 | 7.49 | 55.80 | 74 | -18.2 | PK |
| 7311 | 37.55 | 7.49 | 45.04 | 54 | -8.96 | AV |

Remark: Factor = Antenna Factor + Cable Loss – Pre-amplifier. Margin = Absolute Level – Limit

Vertical:

| Frequency | Reading Result | Factor | Emission Level | Limits | Margin | Detector |
|-----------|----------------|--------|----------------|----------------|--------|----------|
| (MHz) | (dB μ V) | (dB) | (dB μ V/m) | (dB μ V/m) | (dB) | Type |
| 4874 | 54.35 | 5.13 | 59.48 | 74 | -14.52 | PK |
| 4874 | 42.84 | 5.13 | 47.97 | 54 | -6.03 | AV |
| 7311 | 46.78 | 7.49 | 54.27 | 74 | -19.73 | PK |
| 7311 | 35.51 | 7.49 | 43.00 | 54 | -11.00 | AV |

Remark: Factor = Antenna Factor + Cable Loss – Pre-amplifier. Margin = Absolute Level – Limit

CH High of 802.11g Mode (2462MHz)

Horizontal:

| Frequency | Reading Result | Factor | Emission Level | Limits | Margin | Detector |
|-----------|----------------|--------|----------------|----------------|--------|----------|
| (MHz) | (dB μ V) | (dB) | (dB μ V/m) | (dB μ V/m) | (dB) | Type |
| 4924 | 53.55 | 5.18 | 58.73 | 74 | -15.27 | PK |
| 4924 | 41.22 | 5.18 | 46.40 | 54 | -7.60 | AV |
| 7386 | 46.32 | 7.82 | 54.14 | 74 | -19.86 | PK |
| 7386 | 35.22 | 7.82 | 43.04 | 54 | -10.96 | AV |

Remark: Factor = Antenna Factor + Cable Loss – Pre-amplifier. Margin = Absolute Level – Limit

Vertical:

| Frequency | Reading Result | Factor | Emission Level | Limits | Margin | Detector |
|-----------|----------------|--------|----------------|----------------|--------|----------|
| (MHz) | (dB μ V) | (dB) | (dB μ V/m) | (dB μ V/m) | (dB) | Type |
| 4924 | 54.24 | 5.18 | 59.42 | 74 | -14.58 | PK |
| 4924 | 42.88 | 5.18 | 48.06 | 54 | -5.94 | AV |
| 7386 | 47.14 | 7.82 | 54.96 | 74 | -19.04 | PK |
| 7386 | 37.34 | 7.82 | 45.16 | 54 | -8.84 | AV |

Remark: Factor = Antenna Factor + Cable Loss – Pre-amplifier. Margin = Absolute Level – Limit

Remark :

- (1) Measuring frequencies from 1 GHz to the 25 GHz.
- (2) "F" denotes fundamental frequency; "H" denotes spurious frequency. "E" denotes band edge frequency.
- (3) * denotes emission frequency which appearing within the Restricted Bands specified in provision of 15.205, then the general radiated emission limits in 15.209 apply.
- (4) Data of measurement within this frequency range shown "---" in the table above means the reading of emissions are attenuated more than 20dB below the permissible limits or the field strength is too small to be measured.
- (5) The IF bandwidth of EMI Test Receiver between 30MHz to 1GHz was 120KHz, 1 MHz for measuring above 1 GHz, below 30MHz was 10KHz. The resolution bandwidth of test receiver/spectrum analyzer is 1MHz and video bandwidth is 3MHz for peak measurement with peak detector at frequency above 1GHz. The resolution bandwidth of test receiver/spectrum analyzer is 1MHz and video bandwidth is 10Hz for Average measurement with peak detection at frequency above 1GHz.
- (6) When the test results of Peak Detected below the limits of Average Detected, the Average Detected is not need completed. For example: Top Channel at Fundamental 73.16dBuV/m(PK Value) <93.98(AV Limit), at harmonic 53.20 dBuV/m(PK Value) <54 dBuV/m(AV Limit), the Average Detected not need to completed.

CH Low of 802.11n/H20 Mode (2412MHz)

Horizontal:

| Frequency (MHz) | Reading Result (dB μ V) | Factor (dB) | Emission Level (dB μ V/m) | Limits (dB μ V/m) | Margin (dB) | Detector Type |
|--------------------|--------------------------------|----------------|----------------------------------|--------------------------|----------------|------------------|
| 4824 | 53.28 | 5.08 | 58.36 | 74 | -15.64 | PK |
| 4824 | 42.82 | 5.08 | 47.90 | 54 | -6.10 | AV |
| 7236 | 47.52 | 7.16 | 54.68 | 74 | -19.32 | PK |
| 7236 | 37.25 | 7.16 | 44.41 | 54 | -9.59 | AV |

Remark: Factor = Antenna Factor + Cable Loss – Pre-amplifier. Margin = Absolute Level – Limit

Vertical:

| Frequency (MHz) | Reading Result (dB μ V) | Factor (dB) | Emission Level (dB μ V/m) | Limits (dB μ V/m) | Margin (dB) | Detector Type |
|--------------------|--------------------------------|----------------|----------------------------------|--------------------------|----------------|------------------|
| 4824 | 54.28 | 5.08 | 59.36 | 74 | -14.64 | PK |
| 4824 | 43.05 | 5.08 | 48.13 | 54 | -5.87 | AV |
| 7236 | 46.29 | 7.16 | 53.45 | 74 | -20.55 | PK |
| 7236 | 35.12 | 7.16 | 42.28 | 54 | -11.72 | AV |

Remark: Factor = Antenna Factor + Cable Loss – Pre-amplifier. Margin = Absolute Level – Limit

CH Middle of 802.11n/H20 Mode (2437MHz)

Horizontal:

| Frequency | Reading Result | Factor | Emission Level | Limits | Margin | Detector |
|-----------|----------------|--------|----------------|----------------|--------|----------|
| (MHz) | (dB μ V) | (dB) | (dB μ V/m) | (dB μ V/m) | (dB) | Type |
| 4874 | 53.85 | 5.13 | 58.98 | 74 | -15.02 | PK |
| 4874 | 39.28 | 5.13 | 44.41 | 54 | -9.59 | AV |
| 7311 | 46.18 | 7.49 | 53.67 | 74 | -20.33 | PK |
| 7311 | 34.55 | 7.49 | 42.04 | 54 | -11.96 | AV |

Remark: Factor = Antenna Factor + Cable Loss – Pre-amplifier. Margin = Absolute Level – Limit

Vertical:

| Frequency | Reading Result | Factor | Emission Level | Limits | Margin | Detector |
|-----------|----------------|--------|----------------|----------------|--------|----------|
| (MHz) | (dB μ V) | (dB) | (dB μ V/m) | (dB μ V/m) | (dB) | Type |
| 4874 | 55.17 | 5.13 | 60.3 | 74 | -13.7 | PK |
| 4874 | 43.22 | 5.13 | 48.35 | 54 | -5.65 | AV |
| 7311 | 46.81 | 7.49 | 54.3 | 74 | -19.7 | PK |
| 7311 | 35.25 | 7.49 | 42.74 | 54 | -11.26 | AV |

Remark: Factor = Antenna Factor + Cable Loss – Pre-amplifier. Margin = Absolute Level – Limit

CH High of 802.11n/H20 Mode (2462MHz)

Horizontal:

| Frequency | Reading Result | Factor | Emission Level | Limits | Margin | Detector |
|-----------|----------------|--------|----------------|----------|--------|----------|
| (MHz) | (dBμV) | (dB) | (dBμV/m) | (dBμV/m) | (dB) | Type |
| 4924 | 53.14 | 5.18 | 58.32 | 74 | -15.68 | PK |
| 4924 | 42.37 | 5.18 | 47.55 | 54 | -6.45 | AV |
| 7386 | 46.19 | 7.82 | 54.01 | 74 | -19.99 | PK |
| 7386 | 35.38 | 7.82 | 43.20 | 54 | -10.80 | AV |

Remark: Factor = Antenna Factor + Cable Loss – Pre-amplifier. Margin = Absolute Level – Limit

Vertical:

| Frequency | Reading Result | Factor | Emission Level | Limits | Margin | Detector |
|-----------|----------------|--------|----------------|----------|--------|----------|
| (MHz) | (dBμV) | (dB) | (dBμV/m) | (dBμV/m) | (dB) | Type |
| 4924 | 55.11 | 5.18 | 60.29 | 74 | -13.71 | PK |
| 4924 | 42.26 | 5.18 | 47.44 | 54 | -6.56 | AV |
| 7386 | 48.19 | 7.82 | 56.01 | 74 | -17.99 | PK |
| 7386 | 34.32 | 7.82 | 42.14 | 54 | -11.86 | AV |

Remark: Factor = Antenna Factor + Cable Loss – Pre-amplifier. Margin = Absolute Level – Limit

CH Low of 802.11n/H40 Mode (2422MHz)

Horizontal:

| Frequency (MHz) | Reading Result (dBμV) | Factor (dB) | Emission Level (dBμV/m) | Limits (dBμV/m) | Margin (dB) | Detector Type |
|--------------------|--------------------------|----------------|----------------------------|--------------------|----------------|------------------|
| 4844 | 52.52 | 5.11 | 57.63 | 74 | -16.37 | PK |
| 4844 | 41.21 | 5.11 | 46.32 | 54 | -7.68 | AV |
| 7266 | 44.34 | 7.29 | 51.63 | 74 | -22.37 | PK |
| 7266 | 33.15 | 7.29 | 40.44 | 54 | -13.56 | AV |

Remark: Factor = Antenna Factor + Cable Loss – Pre-amplifier. Margin = Absolute Level – Limit

Vertical:

| Frequency (MHz) | Reading Result (dBμV) | Factor (dB) | Emission Level (dBμV/m) | Limits (dBμV/m) | Margin (dB) | Detector Type |
|--------------------|--------------------------|----------------|----------------------------|--------------------|----------------|------------------|
| 4844 | 52.27 | 5.08 | 57.35 | 74 | -16.65 | PK |
| 4844 | 43.28 | 5.08 | 48.36 | 54 | -5.64 | AV |
| 7266 | 46.21 | 7.29 | 53.50 | 74 | -20.50 | PK |
| 7266 | 34.53 | 7.29 | 41.82 | 54 | -12.18 | AV |

Remark: Factor = Antenna Factor + Cable Loss – Pre-amplifier. Margin = Absolute Level – Limit

CH Middle of 802.11n/H40 Mode (2437MHz)

Horizontal:

| Frequency | Reading Result | Factor | Emission Level | Limits | Margin | Detector |
|-----------|----------------|--------|----------------|----------------|--------|----------|
| (MHz) | (dB μ V) | (dB) | (dB μ V/m) | (dB μ V/m) | (dB) | Type |
| 4874 | 52.82 | 5.13 | 57.95 | 74 | -16.05 | PK |
| 4874 | 39.98 | 5.13 | 45.11 | 54 | -8.89 | AV |
| 7311 | 45.24 | 7.49 | 52.73 | 74 | -21.27 | PK |
| 7311 | 35.52 | 7.49 | 43.01 | 54 | -10.99 | AV |

Remark: Factor = Antenna Factor + Cable Loss – Pre-amplifier. Margin = Absolute Level – Limit

Vertical:

| Frequency | Reading Result | Factor | Emission Level | Limits | Margin | Detector |
|-----------|----------------|--------|----------------|----------------|--------|----------|
| (MHz) | (dB μ V) | (dB) | (dB μ V/m) | (dB μ V/m) | (dB) | Type |
| 4874 | 53.12 | 5.13 | 58.25 | 74 | -15.75 | PK |
| 4874 | 40.22 | 5.13 | 45.35 | 54 | -8.65 | AV |
| 7311 | 44.28 | 7.49 | 51.77 | 74 | -22.23 | PK |
| 7311 | 33.22 | 7.49 | 40.71 | 54 | -13.29 | AV |

Remark: Factor = Antenna Factor + Cable Loss – Pre-amplifier. Margin = Absolute Level – Limit

CH High of 802.11n/H40 Mode (2452MHz)

Horizontal:

| Frequency | Reading Result | Factor | Emission Level | Limits | Margin | Detector |
|-----------|----------------|--------|----------------|----------|--------|----------|
| (MHz) | (dBμV) | (dB) | (dBμV/m) | (dBμV/m) | (dB) | Type |
| 4904 | 52.2 | 5.16 | 57.36 | 74 | -16.64 | PK |
| 4904 | 42.4 | 5.16 | 47.56 | 54 | -6.44 | AV |
| 7356 | 45.34 | 7.69 | 53.03 | 74 | -20.97 | PK |
| 7356 | 34.71 | 7.69 | 42.4 | 54 | -11.6 | AV |

Remark: Factor = Antenna Factor + Cable Loss – Pre-amplifier. Margin = Absolute Level – Limit

Vertical:

| Frequency | Reading Result | Factor | Emission Level | Limits | Margin | Detector |
|-----------|----------------|--------|----------------|----------|--------|----------|
| (MHz) | (dBμV) | (dB) | (dBμV/m) | (dBμV/m) | (dB) | Type |
| 4904 | 51.2 | 5.16 | 56.36 | 74 | -17.64 | PK |
| 4904 | 40.27 | 5.16 | 45.43 | 54 | -8.57 | AV |
| 7356 | 46.49 | 7.69 | 54.18 | 74 | -19.82 | PK |
| 7356 | 34.75 | 7.69 | 42.44 | 54 | -11.56 | AV |

Remark: Factor = Antenna Factor + Cable Loss – Pre-amplifier. Margin = Absolute Level – Limit

Remark :

- (1) Measuring frequencies from 1 GHz to the 25 GHz.
- (2) "F" denotes fundamental frequency; "H" denotes spurious frequency. "E" denotes band edge frequency.
- (3) * denotes emission frequency which appearing within the Restricted Bands specified in provision of 15.205, then the general radiated emission limits in 15.209 apply.
- (4) Data of measurement within this frequency range shown "---" in the table above means the reading of emissions are attenuated more than 20dB below the permissible limits or the field strength is too small to be measured.
- (5) The IF bandwidth of EMI Test Receiver between 30MHz to 1GHz was 120KHz, 1 MHz for measuring above 1 GHz, below 30MHz was 10KHz. The resolution bandwidth of test receiver/spectrum analyzer is 1MHz and video bandwidth is 3MHz for peak measurement with peak detector at frequency above 1GHz. The resolution bandwidth of test receiver/spectrum analyzer is 1MHz and video bandwidth is 10Hz for Average measurement with peak detection at frequency above 1GHz.
- (6) When the test results of Peak Detected below the limits of Average Detected, the Average Detected is not need completed. For example: Top Channel at Fundamental 73.16dBuV/m(PK Value) <93.98(AV Limit), at harmonic 53.20 dBuV/m(PK Value) <54 dBuV/m(AV Limit), the Average Detected not need to completed.

5 BAND EDGE

5.1 Limits

FCC PART 15.247 Emissions radiated outside of the specified frequency bands, except for harmonics, shall be attenuated by at least 20 dB below the level of the fundamental or to the general radiated emission limits in §15.209, whichever is the lesser attenuation.

5.2 Test Procedure

The band edge compliance of RF radiated emission should be measured by following the guidance in ANSI C63.10 with respect to maximizing the emission by rotating the EUT, measuring the emission while the EUT is situated in three orthogonal planes (if appropriate), adjusting the measurement antenna height and polarization etc. Set RBW to 100KHz and VBM to 300KHz to measure the peak field strength and set RBW to 1MHz and VBW to 10Hz to measure the average radiated field strength. The conducted RF band edge was measured by using a spectrum analyzer. Set span wide enough to capture the highest in-band emission and the emission at the band edge. Set RBW to 100 KHz and VBW to 300 KHz, to measure the conducted peak band edge.

5.3 Test Result

PASS

Operation Mode: 802.11b Mode TX CH Low (2412MHz)

Horizontal:

| Frequency (MHz) | Reading Result (dBμV) | Factor (dB) | Emission Level (dBμV/m) | Limits (dBμV/m) | Margin (dB) | Detector Type |
|--------------------|--------------------------|----------------|----------------------------|--------------------|----------------|------------------|
| 2310 | 56.15 | -6.42 | 49.73 | 74 | -24.27 | |
| 2310 | / | -6.42 | / | 54 | / | AV |
| 2390 | 57.61 | -5.79 | 51.82 | 74 | -22.18 | PK |
| 2390 | / | -5.79 | / | 54 | / | AV |
| 2400 | 61.42 | -5.70 | 55.72 | 74 | -18.28 | PK |
| 2400 | 53.98 | -5.70 | 48.28 | 54 | -5.72 | AV |

Remark: Factor = Antenna Factor + Cable Loss – Pre-amplifier.

Vertical:

| Frequency (MHz) | Reading Result (dBμV) | Factor (dB) | Emission Level (dBμV/m) | Limits (dBμV/m) | Margin (dB) | Detector Type |
|--------------------|--------------------------|----------------|----------------------------|--------------------|----------------|------------------|
| 2310 | 54.42 | -6.42 | 48.00 | 74 | -26.00 | |
| 2310 | / | -6.42 | / | 54 | / | AV |
| 2390 | 54.96 | -5.79 | 49.17 | 74 | -24.83 | PK |
| 2390 | / | -5.79 | / | 54 | / | AV |
| 2400 | 60.80 | -5.70 | 55.10 | 74 | -18.90 | PK |
| 2400 | 52.76 | -5.70 | 47.06 | 54 | -6.94 | AV |

Remark: Factor = Antenna Factor + Cable Loss – Pre-amplifier.

Operation Mode: 802.11b Mode TX CH High (2462MHz)

Horizontal:

| Frequency | Reading Result | Factor | Emission Level | Limits | Margin | Detector Type |
|-----------|----------------|--------|----------------|----------------|--------|---------------|
| (MHz) | (dB μ V) | (dB) | (dB μ V/m) | (dB μ V/m) | (dB) | |
| 2483.5 | 55.83 | -4.98 | 50.85 | 74 | -23.15 | PK |
| 2483.5 | / | -4.98 | / | 54 | / | AV |
| 2500 | 55.50 | -4.83 | 50.67 | 74 | -23.33 | PK |
| 2500 | / | -4.83 | / | 54 | / | AV |

Remark: Factor = Antenna Factor + Cable Loss – Pre-amplifier.

Vertical:

| Frequency | Reading Result | Factor | Emission Level | Limits | Margin | Detector Type |
|-----------|----------------|--------|----------------|----------------|--------|---------------|
| (MHz) | (dB μ V) | (dB) | (dB μ V/m) | (dB μ V/m) | (dB) | |
| 2483.5 | 53.52 | -4.98 | 48.54 | 74 | -25.46 | PK |
| 2483.5 | / | -4.98 | / | 54 | / | AV |
| 2500 | 53.75 | -4.83 | 48.92 | 74 | -25.08 | PK |
| 2500 | / | -4.83 | / | 54 | / | AV |

Remark: Factor = Antenna Factor + Cable Loss – Pre-amplifier.

Operation Mode: 802.11g Mode TX CH Low (2412MHz)

Horizontal:

| Frequency (MHz) | Reading Result (dB μ V) | Factor (dB) | Emission Level (dB μ V/m) | Limits (dB μ V/m) | Margin (dB) | Detector Type |
|--------------------|--------------------------------|----------------|----------------------------------|--------------------------|----------------|---------------|
| 2310 | 56.62 | -6.42 | 50.20 | 74 | -23.80 | PK |
| 2310 | / | -6.42 | / | 54 | / | AV |
| 2390 | 63.37 | -5.79 | 57.58 | 74 | -16.42 | PK |
| 2390 | 50.86 | -5.79 | 45.07 | 54 | -8.93 | AV |
| 2400 | 64.74 | -5.70 | 59.04 | 74 | -14.96 | PK |
| 2400 | 53.18 | -5.70 | 47.48 | 54 | -6.52 | AV |

Remark: Factor = Antenna Factor + Cable Loss – Pre-amplifier.

Vertical:

| Frequency (MHz) | Reading Result (dB μ V) | Factor (dB) | Emission Level (dB μ V/m) | Limits (dB μ V/m) | Margin (dB) | Detector Type |
|--------------------|--------------------------------|----------------|----------------------------------|--------------------------|----------------|---------------|
| 2310 | 53.96 | -6.42 | 47.54 | 74 | -26.46 | PK |
| 2310 | / | -6.42 | / | 54 | / | AV |
| 2390 | 61.76 | -5.79 | 55.97 | 74 | -18.03 | PK |
| 2390 | 49.62 | -5.79 | 43.83 | 54 | -10.17 | AV |
| 2400 | 63.00 | -5.70 | 57.30 | 74 | -16.70 | PK |
| 2400 | 52.70 | -5.70 | 47.00 | 54 | -7.00 | AV |

Remark: Factor = Antenna Factor + Cable Loss – Pre-amplifier.

Operation Mode: 802.11g Mode TX CH High (2462MHz)

Horizontal:

| Frequency | Reading Result | Factor | Emission Level | Limits | Margin | Detector Type |
|-----------|----------------|--------|----------------|----------------|--------|---------------|
| (MHz) | (dB μ V) | (dB) | (dB μ V/m) | (dB μ V/m) | (dB) | |
| 2483.5 | 63.77 | -4.98 | 58.79 | 74 | -15.21 | PK |
| 2483.5 | 53.31 | -4.98 | 48.33 | 54 | -5.67 | AV |
| 2500 | 52.25 | -4.83 | 47.42 | 74 | -26.58 | PK |
| 2500 | / | -4.83 | / | 54 | / | AV |

Remark: Factor = Antenna Factor + Cable Loss – Pre-amplifier.

Vertical:

| Frequency | Reading Result | Factor | Emission Level | Limits | Margin | Detector Type |
|-----------|----------------|--------|----------------|----------------|--------|---------------|
| (MHz) | (dB μ V) | (dB) | (dB μ V/m) | (dB μ V/m) | (dB) | |
| 2483.5 | 61.21 | -4.98 | 56.23 | 74 | -17.77 | PK |
| 2483.5 | 50.41 | -4.98 | 45.43 | 54 | -8.57 | AV |
| 2500 | 48.22 | -4.83 | 43.39 | 74 | -30.61 | PK |
| 2500 | / | -4.83 | / | 54 | / | AV |

Remark: Factor = Antenna Factor + Cable Loss – Pre-amplifier.

Operation Mode: 802.11n/H20 Mode TX CH Low (2412MHz)

Horizontal:

| Frequency (MHz) | Reading Result (dB μ V) | Factor (dB) | Emission Level (dB μ V/m) | Limits (dB μ V/m) | Margin (dB) | Detector Type |
|--------------------|--------------------------------|----------------|----------------------------------|--------------------------|----------------|------------------|
| 2310 | 55.46 | -6.42 | 49.04 | 74 | -24.96 | PK |
| 2310 | / | -6.42 | / | 54 | / | AV |
| 2390 | 63.17 | -5.79 | 57.38 | 74 | -16.62 | PK |
| 2390 | 51.85 | -5.79 | 46.06 | 54 | -7.94 | AV |
| 2400 | 64.34 | -5.70 | 58.64 | 74 | -15.36 | PK |
| 2400 | 53.61 | -5.70 | 47.91 | 54 | -6.09 | AV |

Remark: Factor = Antenna Factor + Cable Loss – Pre-amplifier.

Vertical:

| Frequency (MHz) | Reading Result (dB μ V) | Factor (dB) | Emission Level (dB μ V/m) | Limits (dB μ V/m) | Margin (dB) | Detector Type |
|--------------------|--------------------------------|----------------|----------------------------------|--------------------------|----------------|------------------|
| 2310 | 54.47 | -6.42 | 48.05 | 74 | -25.95 | PK |
| 2310 | / | -6.42 | / | 54 | / | AV |
| 2390 | 60.71 | -5.79 | 54.92 | 74 | -19.08 | PK |
| 2390 | 49.82 | -5.79 | 44.03 | 54 | -9.97 | AV |
| 2400 | 63.64 | -5.70 | 57.94 | 74 | -16.06 | PK |
| 2400 | 51.88 | -5.70 | 46.18 | 54 | -7.82 | AV |

Remark: Factor = Antenna Factor + Cable Loss – Pre-amplifier.

Operation Mode: 802.11n/H20 Mode TX CH High (2462MHz)

Horizontal:

| Frequency | Reading Result | Factor | Emission Level | Limits | Margin | Detector Type |
|-----------|----------------|--------|----------------|----------------|--------|---------------|
| (MHz) | (dB μ V) | (dB) | (dB μ V/m) | (dB μ V/m) | (dB) | |
| 2483.5 | 63.18 | -4.98 | 58.20 | 74 | -15.80 | PK |
| 2483.5 | 52.41 | -4.98 | 47.43 | 54 | -6.57 | AV |
| 2500 | 51.00 | -4.83 | 46.17 | 74 | -27.83 | PK |
| 2500 | / | -4.83 | / | 54 | / | AV |

Remark: Factor = Antenna Factor + Cable Loss – Pre-amplifier.

Vertical:

| Frequency | Reading Result | Factor | Emission Level | Limits | Margin | Detector Type |
|-----------|----------------|--------|----------------|----------------|--------|---------------|
| (MHz) | (dB μ V) | (dB) | (dB μ V/m) | (dB μ V/m) | (dB) | |
| 2483.5 | 60.65 | -4.98 | 55.67 | 74 | -18.33 | PK |
| 2483.5 | 49.25 | -4.98 | 44.27 | 54 | -9.73 | AV |
| 2500 | 48.25 | -4.83 | 43.42 | 74 | -30.58 | PK |
| 2500 | / | -4.83 | / | 54 | / | AV |

Remark: Factor = Antenna Factor + Cable Loss – Pre-amplifier.

Operation Mode: 802.11n/H40 Mode TX CH Low (2422MHz)

Horizontal:

| Frequency (MHz) | Reading Result (dB μ V) | Factor (dB) | Emission Level (dB μ V/m) | Limits (dB μ V/m) | Margin (dB) | Detector Type |
|--------------------|--------------------------------|----------------|----------------------------------|--------------------------|----------------|---------------|
| 2310 | 56.27 | -6.42 | 49.85 | 74 | -24.15 | PK |
| 2310 | / | -6.42 | / | 54 | / | AV |
| 2390 | 62.36 | -5.79 | 56.57 | 74 | -17.43 | PK |
| 2390 | 50.39 | -5.79 | 44.60 | 54 | -9.40 | AV |
| 2400 | 64.13 | -5.70 | 58.43 | 74 | -15.57 | PK |
| 2400 | 52.16 | -5.70 | 46.46 | 54 | -7.54 | AV |

Remark: Factor = Antenna Factor + Cable Loss – Pre-amplifier.

Vertical:

| Frequency (MHz) | Reading Result (dB μ V) | Factor (dB) | Emission Level (dB μ V/m) | Limits (dB μ V/m) | Margin (dB) | Detector Type |
|--------------------|--------------------------------|----------------|----------------------------------|--------------------------|----------------|---------------|
| 2310 | 55.65 | -6.42 | 49.23 | 74 | -24.77 | PK |
| 2310 | / | -6.42 | / | 54 | / | AV |
| 2390 | 59.66 | -5.79 | 53.87 | 74 | -20.13 | PK |
| 2390 | 48.23 | -5.79 | 42.44 | 54 | -11.56 | AV |
| 2400 | 61.70 | -5.70 | 56.00 | 74 | -18.00 | PK |
| 2400 | 50.48 | -5.70 | 44.78 | 54 | -9.22 | AV |

Remark: Factor = Antenna Factor + Cable Loss – Pre-amplifier.

Operation Mode: 802.11n/H40 Mode TX CH High (2452MHz)

Horizontal:

| Frequency | Reading Result | Factor | Emission Level | Limits | Margin | Detector Type |
|-----------|----------------|--------|----------------|----------------|--------|---------------|
| (MHz) | (dB μ V) | (dB) | (dB μ V/m) | (dB μ V/m) | (dB) | |
| 2483.5 | 59.65 | -4.98 | 54.67 | 74 | -19.33 | PK |
| 2483.5 | 47.04 | -4.98 | 42.06 | 54 | -11.94 | AV |
| 2500 | 51.35 | -4.83 | 46.52 | 74 | -27.48 | PK |
| 2500 | / | -4.83 | / | 54 | / | AV |

Remark: Factor = Antenna Factor + Cable Loss – Pre-amplifier.

Vertical:

| Frequency | Reading Result | Factor | Emission Level | Limits | Margin | Detector Type |
|-----------|----------------|--------|----------------|----------------|--------|---------------|
| (MHz) | (dB μ V) | (dB) | (dB μ V/m) | (dB μ V/m) | (dB) | |
| 2483.5 | 57.82 | -4.98 | 52.84 | 74 | -21.16 | PK |
| 2483.5 | 46.88 | -4.98 | 41.90 | 54 | -12.10 | AV |
| 2500 | 51.03 | -4.83 | 46.20 | 74 | -27.80 | PK |
| 2500 | / | -4.83 | / | 54 | / | AV |

Remark: Factor = Antenna Factor + Cable Loss – Pre-amplifier.

6 OCCUPIED BANDWIDTH MEASUREMENT

6.1 Test Limit

| FCC Part15(15.247), Subpart C | | | | |
|-------------------------------|-----------|---|-----------------------|--------|
| Section | Test Item | Limit | Frequency Range (MHz) | Result |
| 15.247(a)(2) | Bandwidth | $\geq 500\text{KHz}$ (6dB bandwidth) | 2400-2483.5 | PASS |

6.2 Test Procedure

1. The EUT was placed on a turn table which is 0.8m above ground plane.
2. Set EUT as normal operation.
3. Based on FCC Part15 C Section 15.247: RBW=100KHz, VBW=300KHz.
4. The useful radiated emission from the EUT was detected by the spectrum analyzer with peak detector.

6.3 Measurement Equipment Used

Same as Radiated Emission Measurement

6.4 Test Result

PASS

| TX 802.11b Mode | | | |
|-----------------|---------------------|--------------------------|--------|
| Frequency (MHz) | 6dB Bandwidth (MHz) | Channel Separation (MHz) | Result |
| 2412 | 9.1025 | >=500KHz | PASS |
| 2437 | 9.105 | >=500KHz | PASS |
| 2462 | 9.1138 | >=500KHz | PASS |

CH: 2412MHz

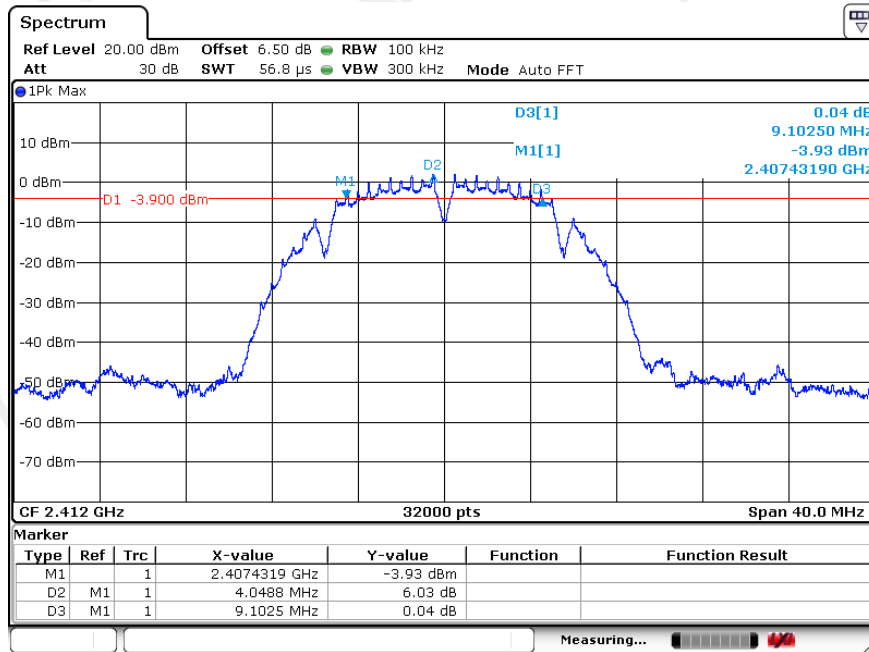

CH: 2437MHz

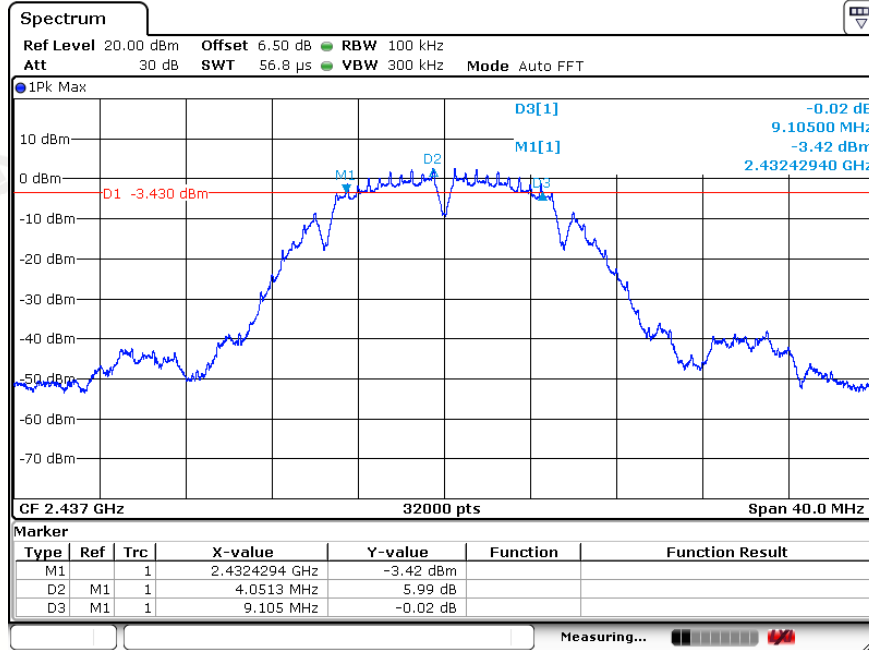

CH: 2462MHz

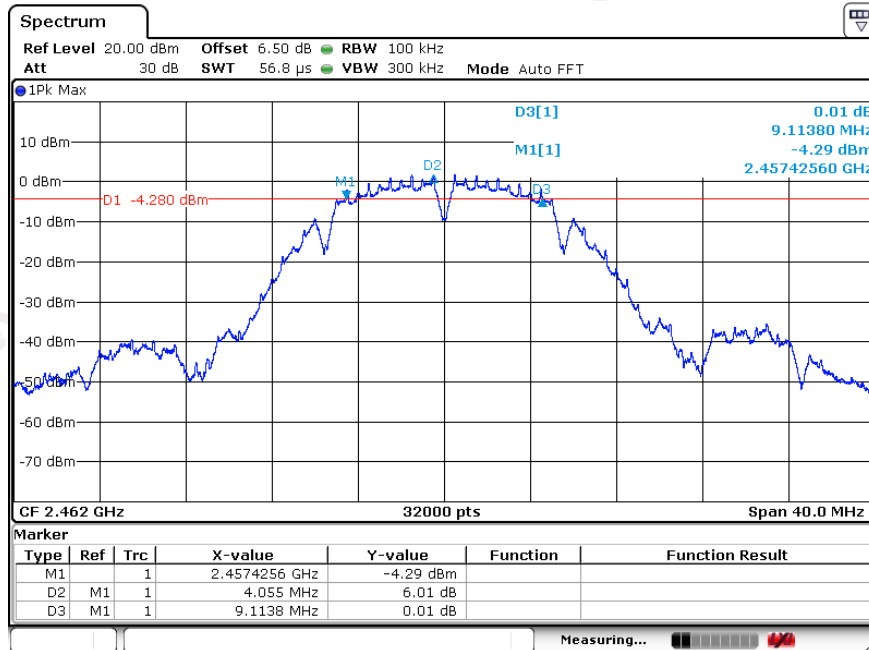

| TX 802.11g Mode | | | |
|-----------------|---------------------|--------------------------|--------|
| Frequency (MHz) | 6dB Bandwidth (MHz) | Channel Separation (MHz) | Result |
| 2412 | 15.1188 | >=500KHz | PASS |
| 2437 | 15.1188 | >=500KHz | PASS |
| 2462 | 15.11 | >=500KHz | PASS |

CH: 2412MHz

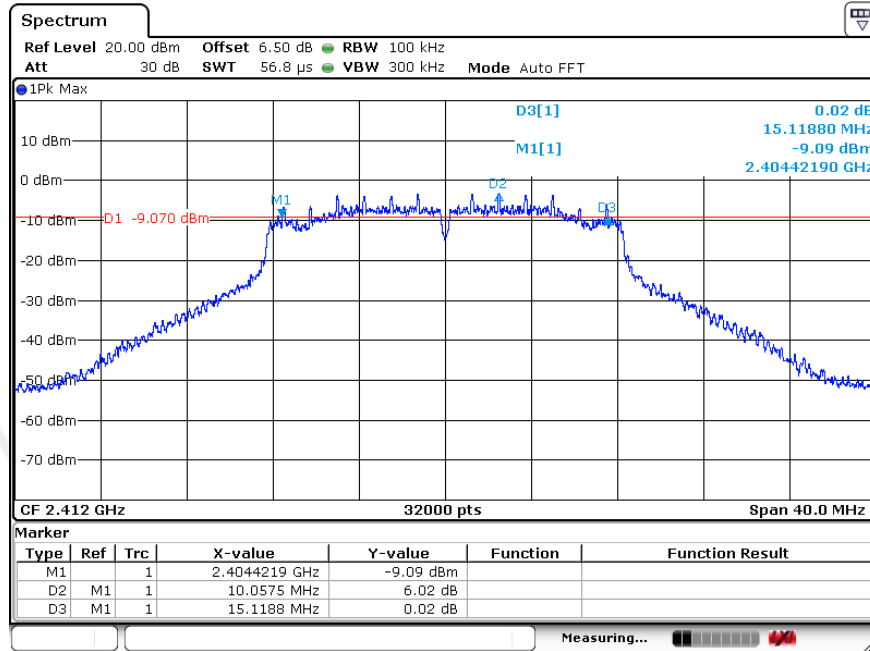

CH: 2437MHz

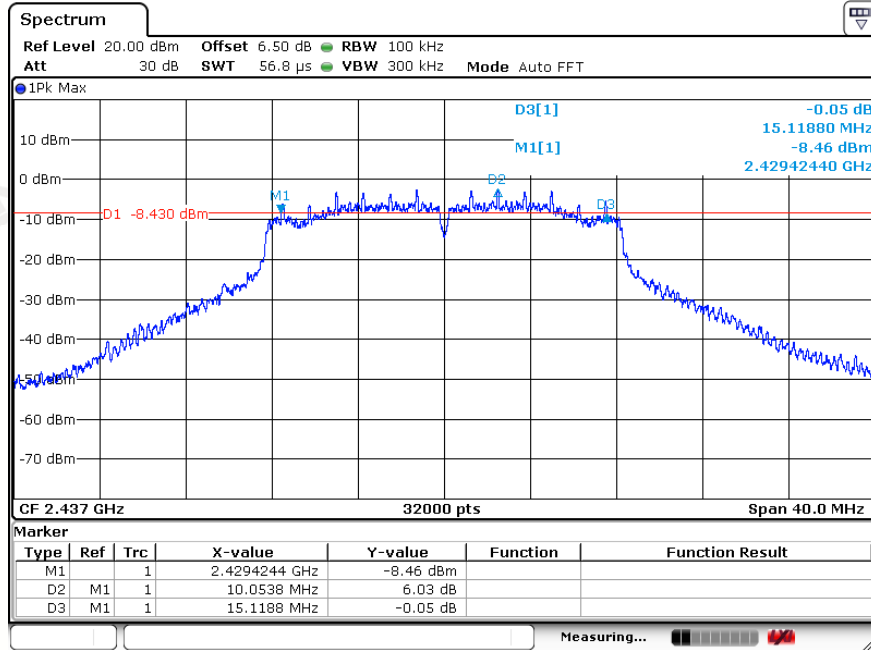

CH: 2462MHz

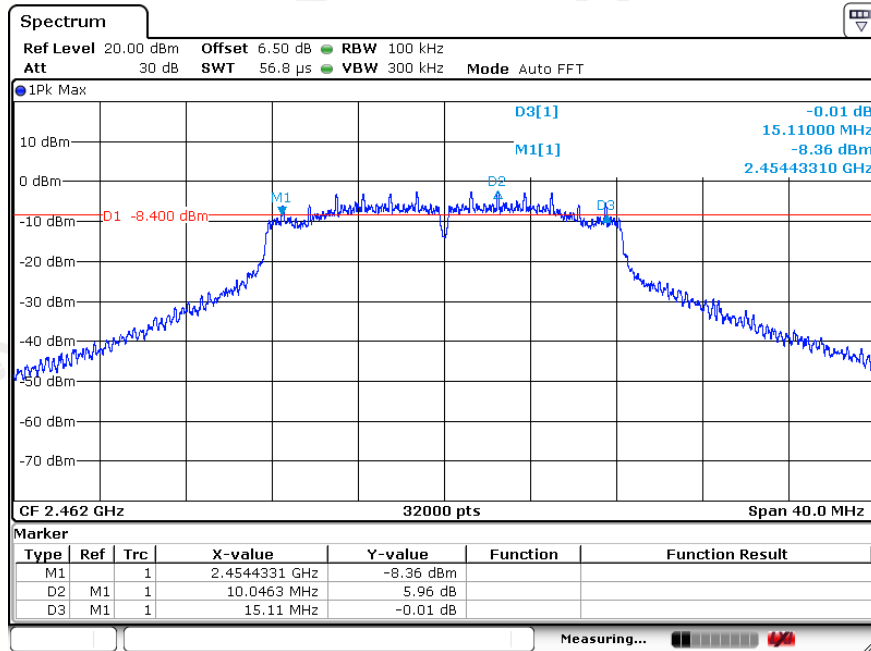

| TX 802.11n/HT20 Mode | | | |
|----------------------|---------------------|--------------------------|--------|
| Frequency (MHz) | 6dB Bandwidth (MHz) | Channel Separation (MHz) | Result |
| 2412 | 15.1175 | >=500KHz | PASS |
| 2437 | 15.1175 | >=500KHz | PASS |
| 2462 | 15.1213 | >=500KHz | PASS |

CH: 2412MHz

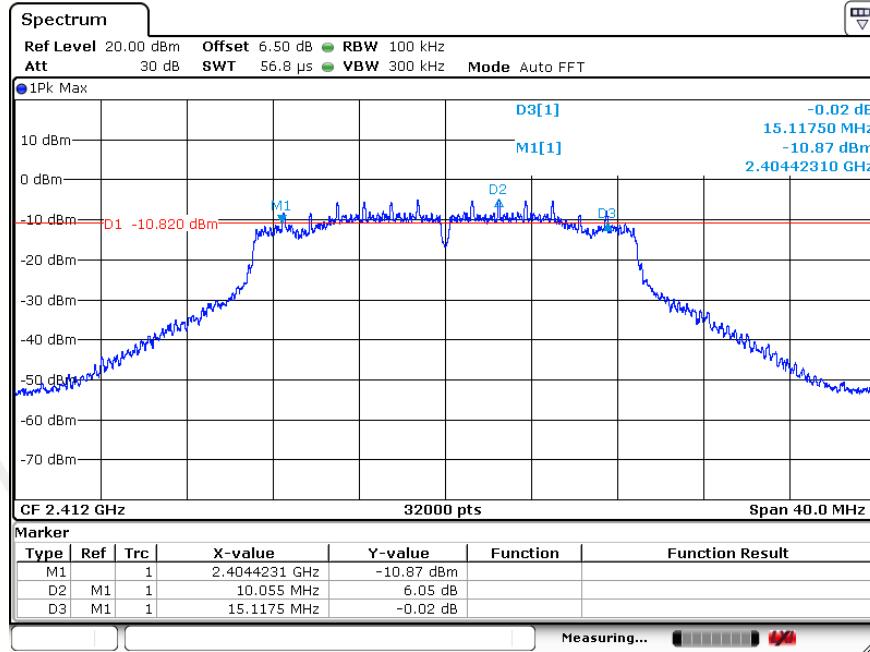

CH: 2437MHz

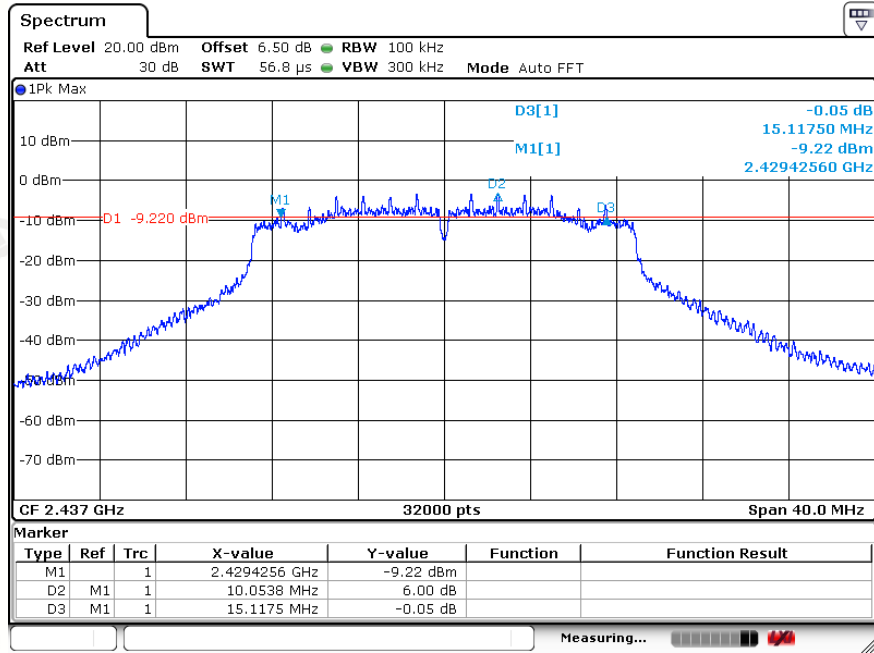

CH: 2462MHz

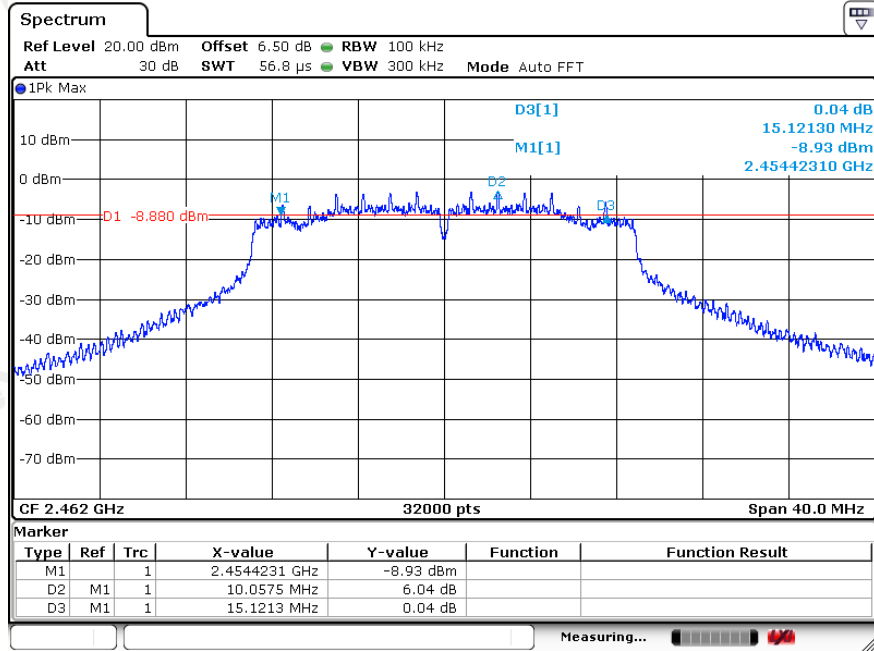

| TX 802.11n/HT40 Mode | | | |
|----------------------|---------------------|--------------------------|--------|
| Frequency (MHz) | 6dB Bandwidth (MHz) | Channel Separation (MHz) | Result |
| 2422 | 35.1075 | >=500KHz | PASS |
| 2437 | 35.1025 | >=500KHz | PASS |
| 2452 | 35.1 | >=500KHz | PASS |

CH: 2422MHz

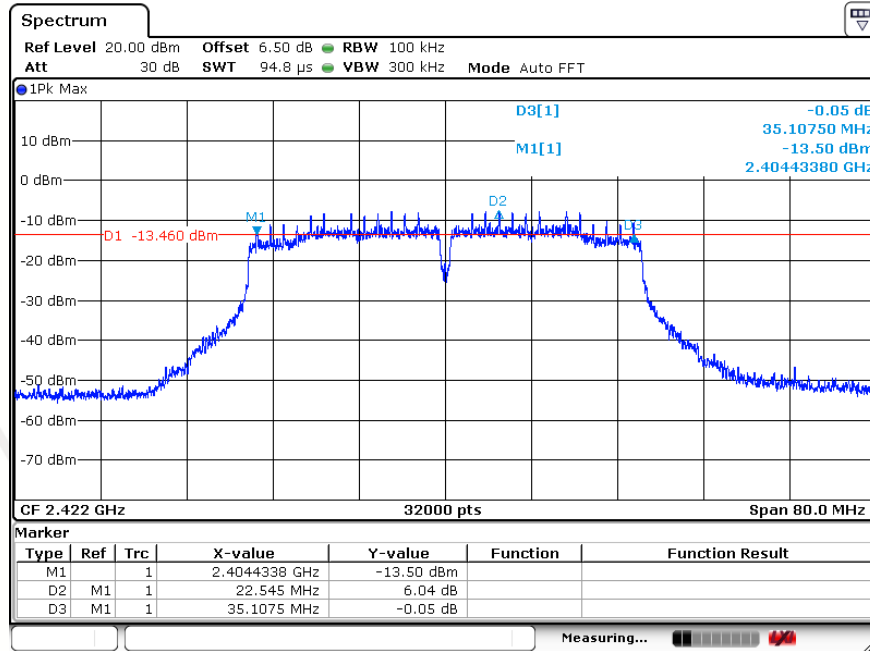

CH: 2437MHz

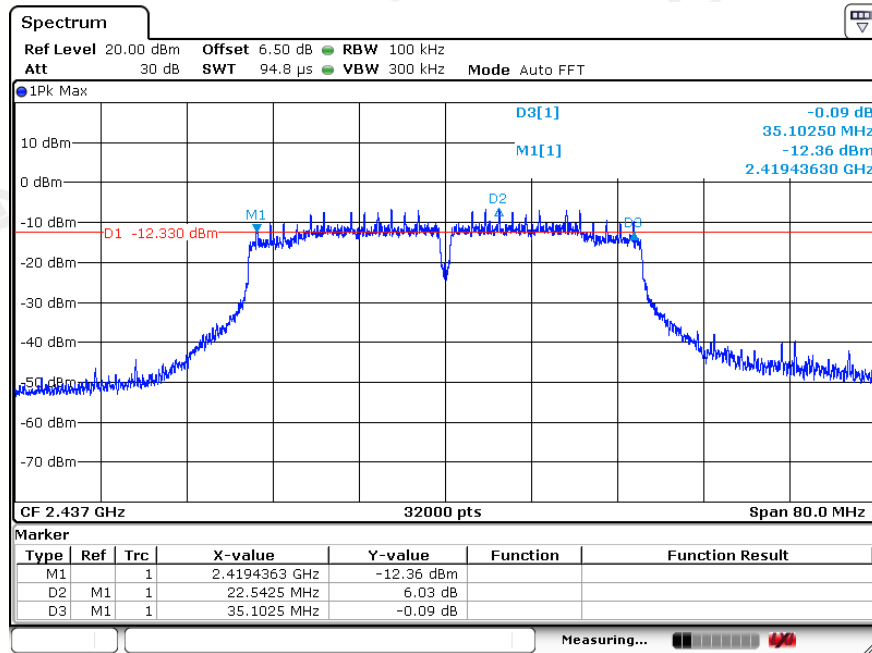

CH: 2452MHz

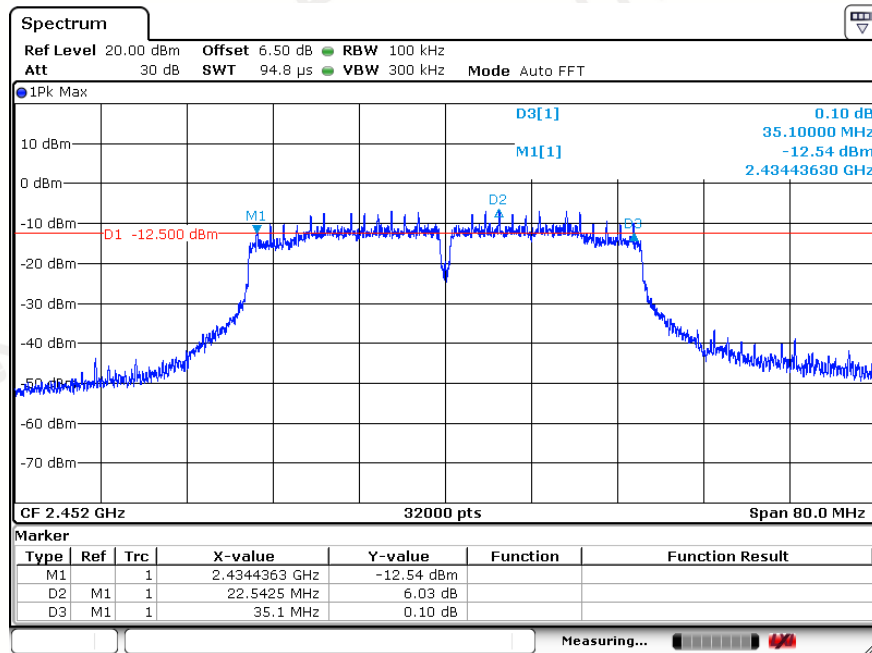

7 POWER SPECTRAL DENSITY TEST

7.1 Test Limit

| FCC Part15(15.247), Subpart C | | | | |
|-------------------------------|------------------------|---------------------|-----------------------|--------|
| Section | Test Item | Limit | Frequency Range (MHz) | Result |
| 15.247 | Power Spectral Density | 8 dBm (in any 3KHz) | 2400-2483.5 | PASS |

7.2 Test Procedure

1. The EUT was placed on a turn table which is 0.8m above ground plane.
2. Set EUT as normal operation.
3. Based on FCC Part15 C Section 15.247: RBW=3KHz, VBW=10KHz.
4. The useful radiated emission from the EUT was detected by the spectrum analyzer with peak detector.

7.3 Measurement Equipment Used

Same as Radiated Emission Measurement

7.4 Test Result

PASS

| TX 802.11b Mode | | | |
|-----------------|--------------------------|------------------|--------|
| Frequency (MHz) | Power Density (dBm/3KHz) | Limit (dBm/3KHz) | Result |
| 2412 | -13.49 | 8 | PASS |
| 2437 | -12.99 | 8 | PASS |
| 2462 | -12.56 | 8 | PASS |

CH: 2412MHz

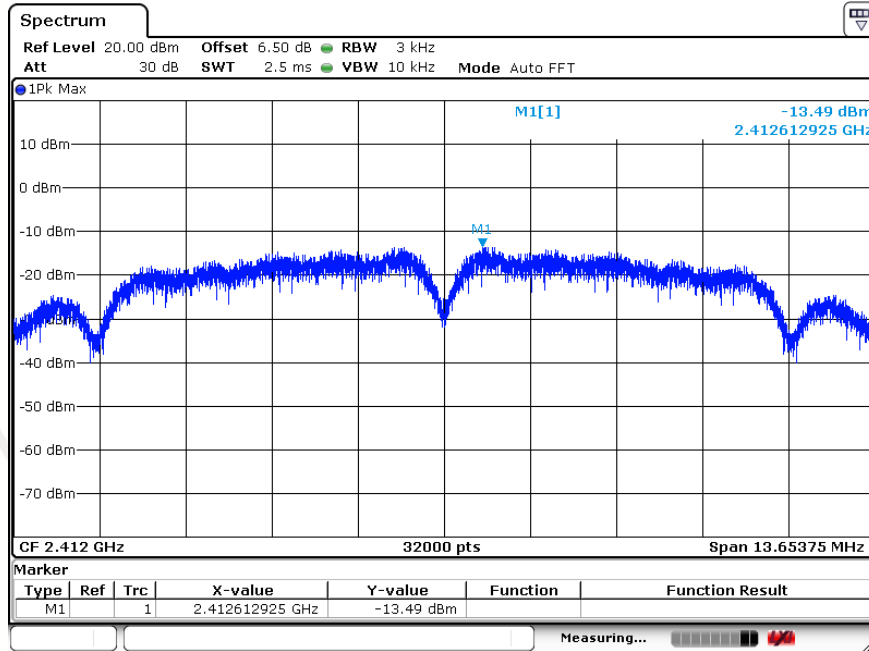

CH: 2437MHz

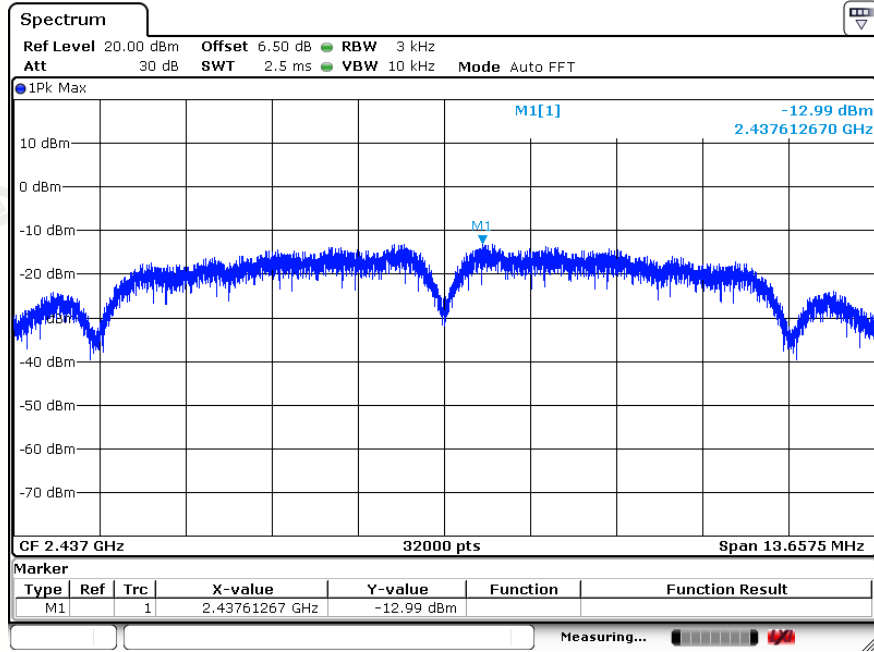

CH: 2462MHz

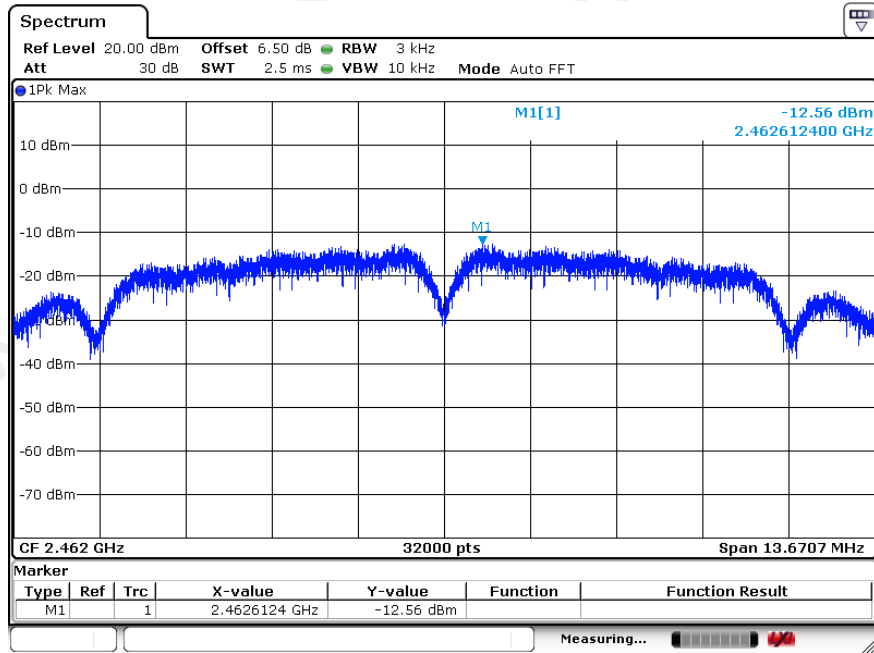

| TX 802.11g Mode | | | |
|-----------------|--------------------------|------------------|--------|
| Frequency (MHz) | Power Density (dBm/3KHz) | Limit (dBm/3KHz) | Result |
| 2412 | -16.90 | 8 | PASS |
| 2437 | -16.22 | 8 | PASS |
| 2462 | -16.22 | 8 | PASS |

CH: 2412MHz

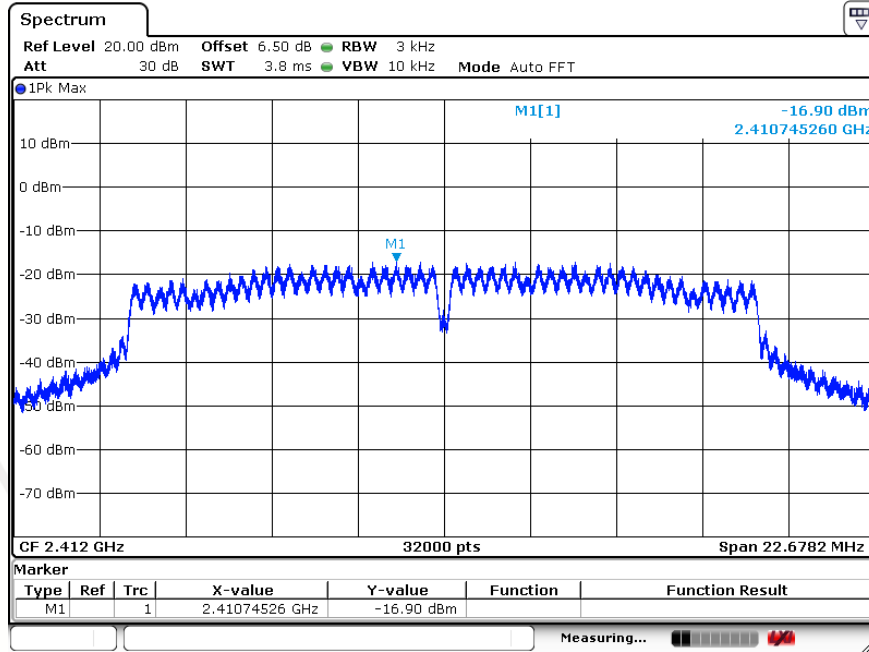

CH: 2437MHz

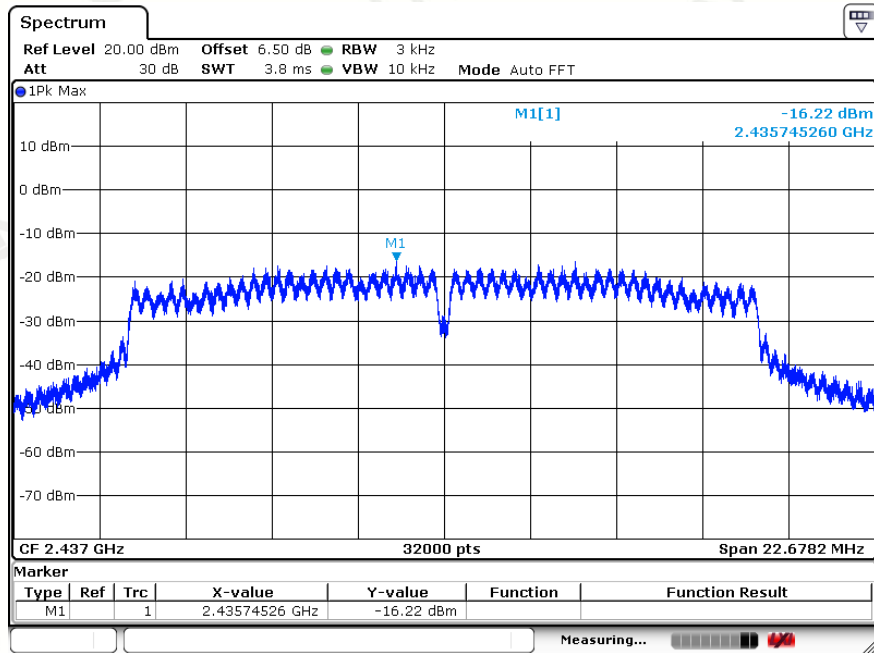

CH: 2462MHz

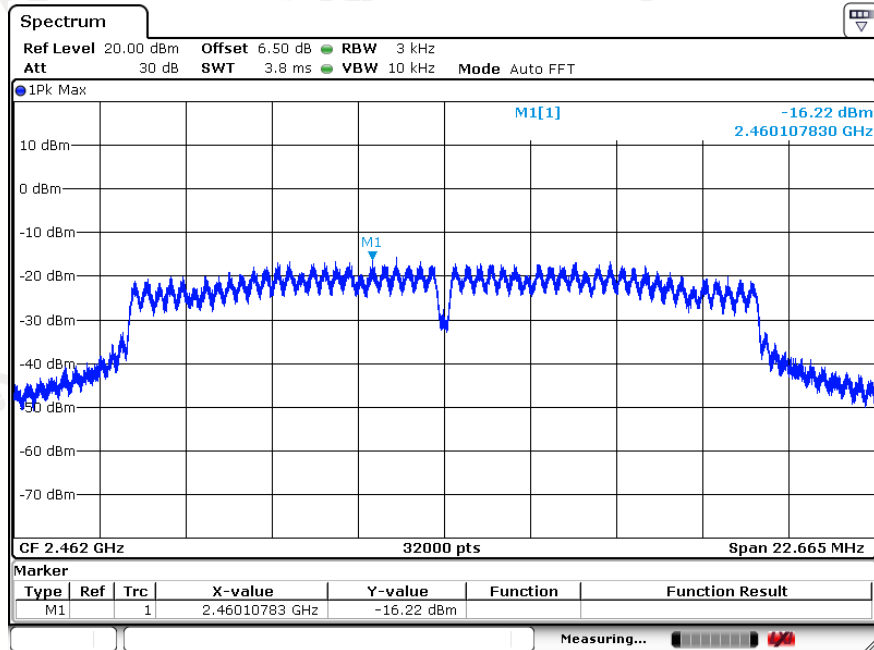

| TX 802.11n/HT20 Mode | | | |
|----------------------|--------------------------|------------------|--------|
| Frequency (MHz) | Power Density (dBm/3KHz) | Limit (dBm/3KHz) | Result |
| 2412 | -18.66 | 8 | PASS |
| 2437 | -17.11 | 8 | PASS |
| 2462 | -16.31 | 8 | PASS |

CH: 2412MHz

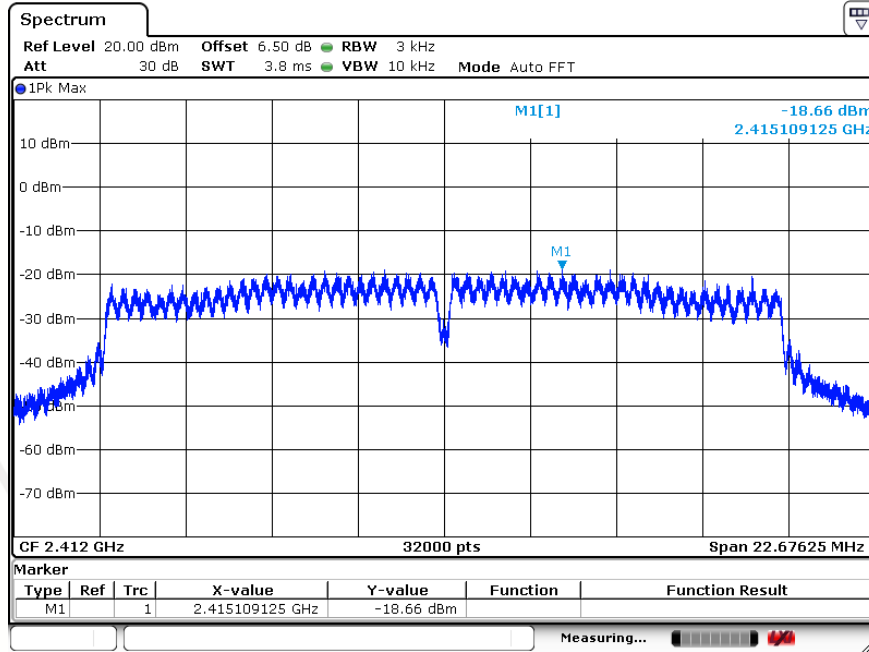

CH: 2437MHz

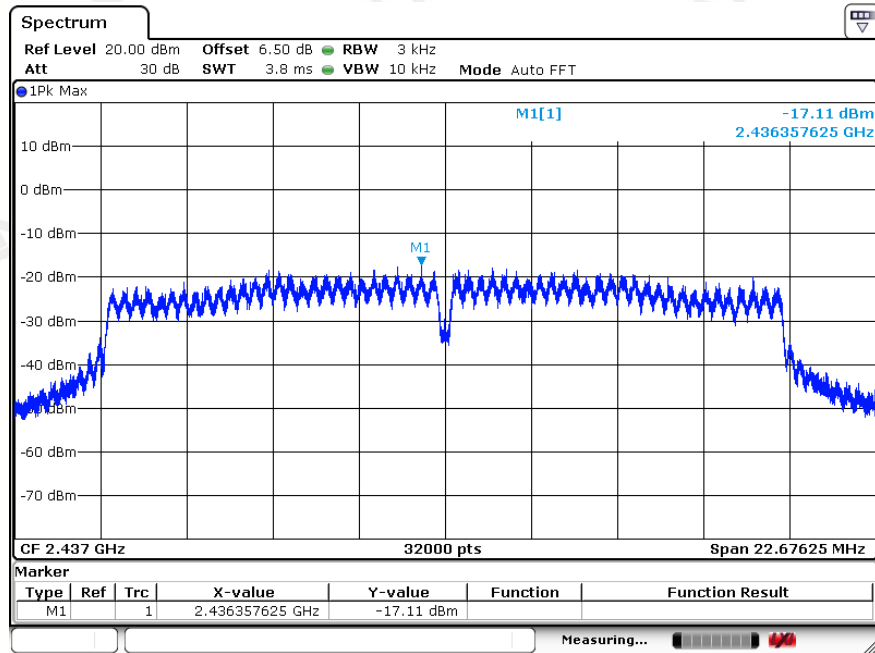

CH: 2462MHz

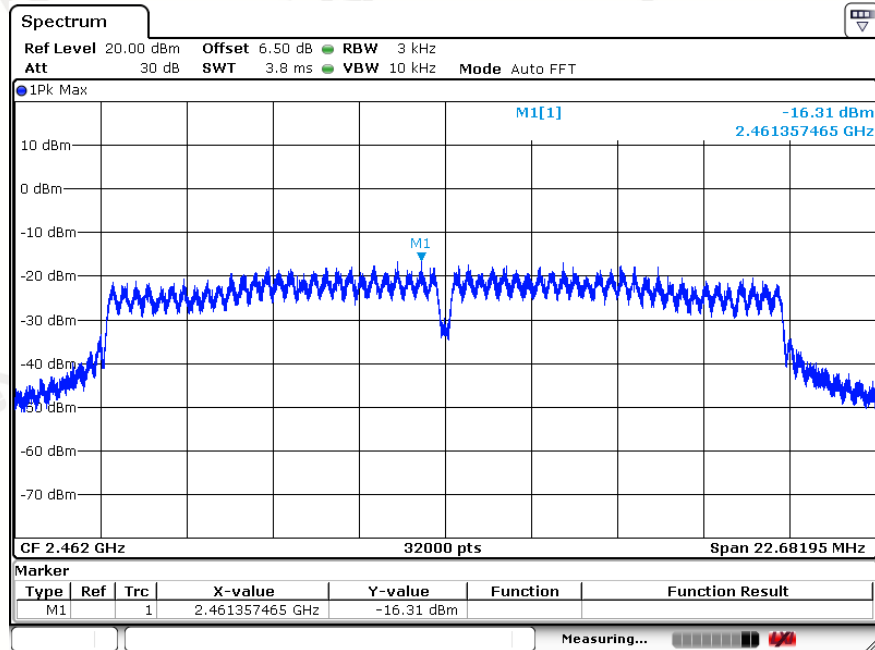

| TX 802.11n/HT40 Mode | | | |
|----------------------|--------------------------|------------------|--------|
| Frequency (MHz) | Power Density (dBm/3KHz) | Limit (dBm/3KHz) | Result |
| 2422 | -21.49 | 8 | PASS |
| 2437 | -20.69 | 8 | PASS |
| 2452 | -20.26 | 8 | PASS |

CH: 2422MHz

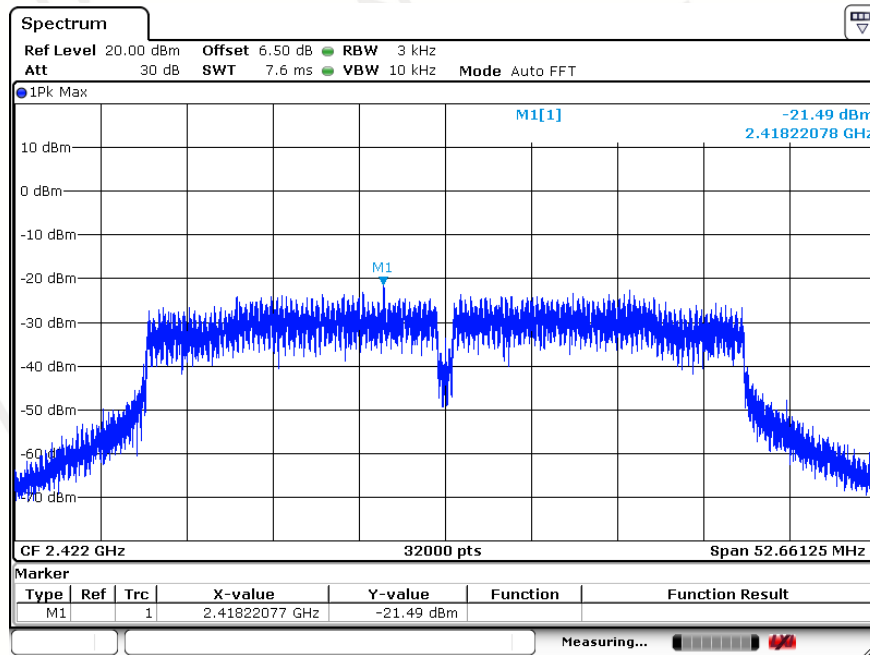

CH: 2437MHz

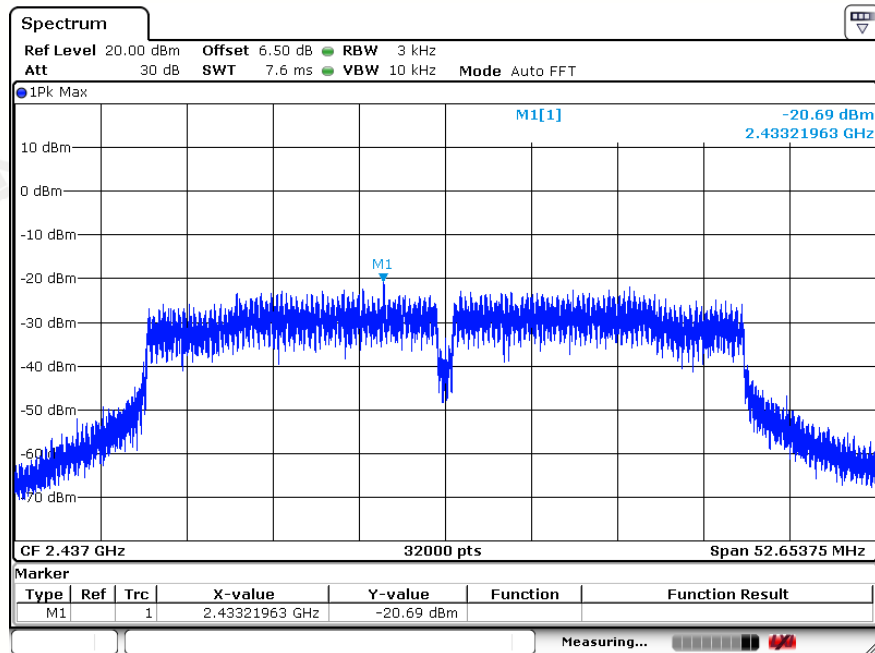

CH: 2452MHz

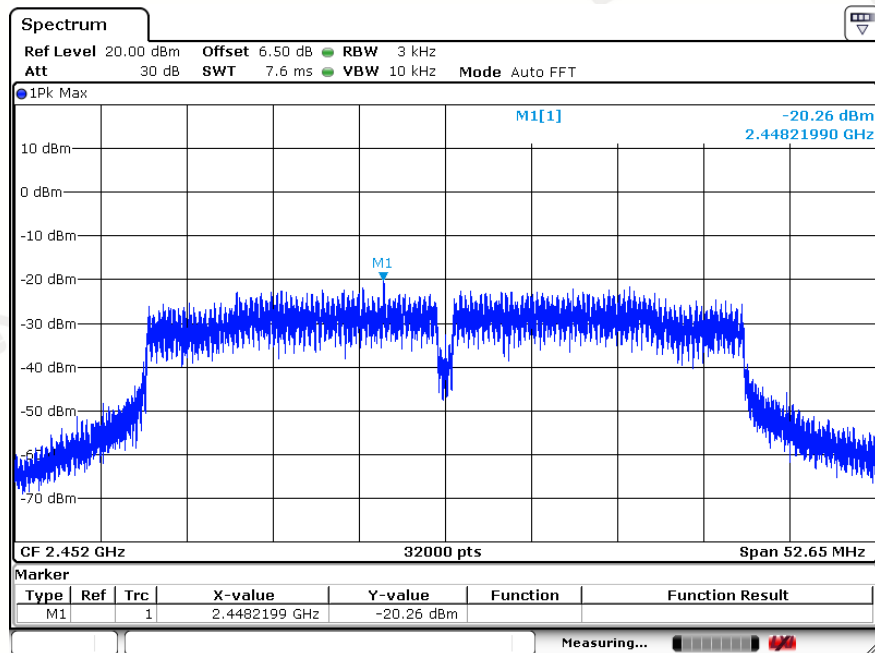

8 PEAK OUTPUT POWER TEST

8.1 Test Limit

| FCC Part15(15.247), Subpart C | | | | |
|-------------------------------|-------------------|-----------------|-----------------------|--------|
| Section | Test Item | Limit | Frequency Range (MHz) | Result |
| 15.247(b)(3) | Peak Output Power | 1 watt or 30dBm | 2400-2483.5 | PASS |

8.2 Test Procedure

1. The EUT was placed on a turn table which is 0.8m above ground plane.
2. The EUT was directly connected to the Power meter.

8.3 Measurement Equipment Used

Same as Radiated Emission Measurement

8.4 Test Result

PASS

All the test modes completed for test.

| TX 802.11b Mode | | | |
|--------------------|-----------------|---|-------------|
| Test Channel | Frequency (MHz) | Maximum Peak Conducted Output Power (dBm) | LIMIT (dBm) |
| CH01 | 2412 | 14.71 | 30 |
| CH06 | 2437 | 14.55 | 30 |
| CH11 | 2462 | 13.92 | 30 |
| TX 802.11g Mode | | | |
| CH01 | 2412 | 13.46 | 30 |
| CH06 | 2437 | 13.25 | 30 |
| CH11 | 2462 | 13.87 | 30 |
| TX 802.11n20 Mode | | | |
| CH01 | 2412 | 12.24 | 30 |
| CH06 | 2437 | 12.17 | 30 |
| CH11 | 2462 | 12.18 | 30 |
| TX 802.11 n40 Mode | | | |
| CH03 | 2422 | 12.46 | 30 |
| CH06 | 2437 | 12.15 | 30 |
| CH09 | 2452 | 12.37 | 30 |

9 OUT OF BAND EMISSIONS TEST

9.1 Test Limit

In any 100 kHz bandwidth outside the frequency band in which the spread spectrum or digitally modulated intentional radiator is operating, the radio frequency power that is produced by the intentional radiator shall be at least 20 dB below that in the 100 kHz bandwidth within the band that contains the highest level of the desired power, based on either an RF conducted or a radiated measurement, provided the transmitter demonstrates compliance with the peak conducted power limits. If the transmitter complies with the conducted power limits based on the use of RMS averaging over a time interval, as permitted under paragraph (b)(3) of this section, the attenuation required under this paragraph shall be 30 dB instead of 20 dB.

9.2 Test Procedure

1. The EUT was placed on a turn table which is 0.8m above ground plane.
2. Set EUT as TX operation and connect directly to the spectrum analyzer.
3. Based on FCC Part15 C Section 15.247: RBW=100KHz, VBW=300KHz.
4. Set detected by the spectrum analyzer with peak detector.

9.3 Test Setup

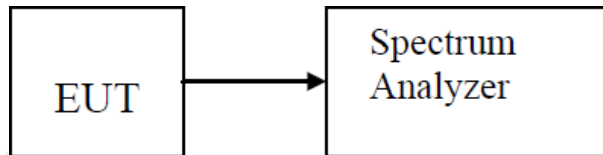

9.4 Test Result

PASS

TX 802.11b Mode
CH: 2412MHz

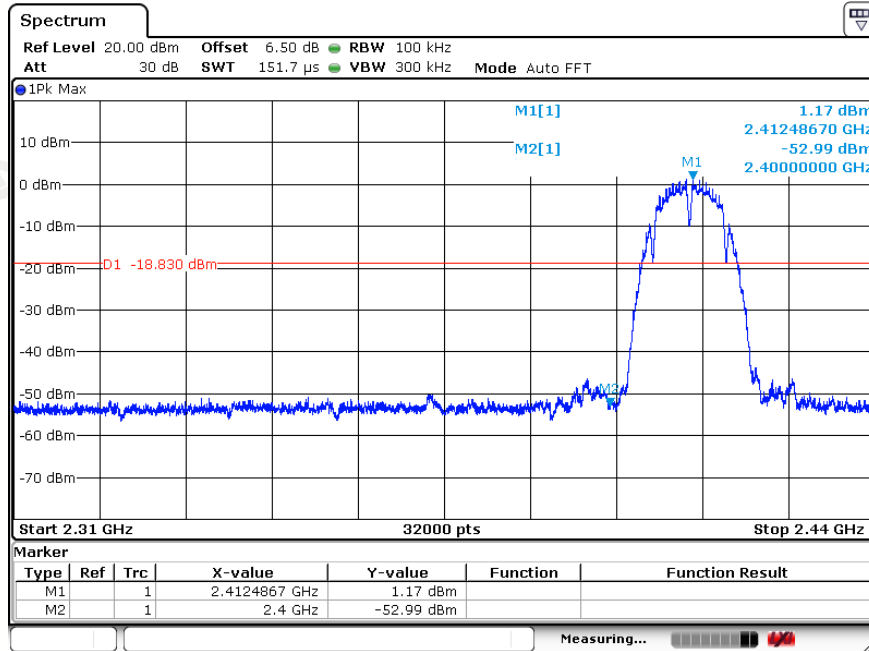

CH: 2462MHz

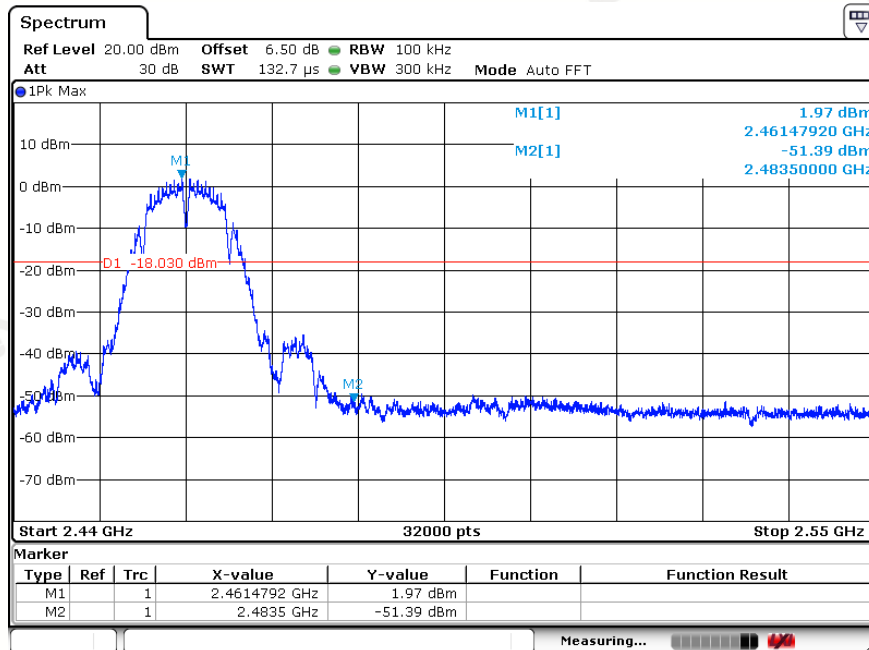

TX 802.11g Mode
CH: 2412MHz

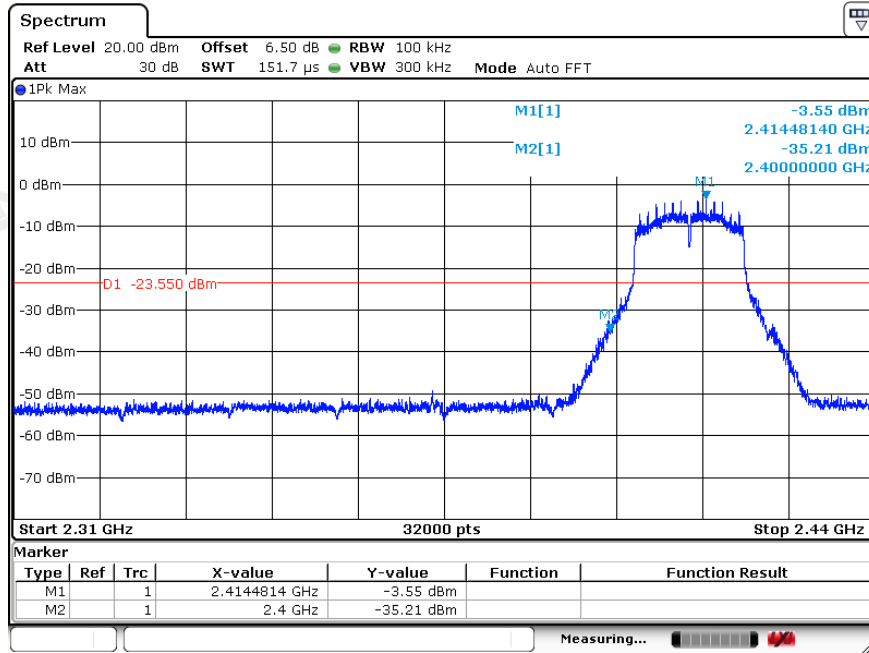

CH: 2462MHz

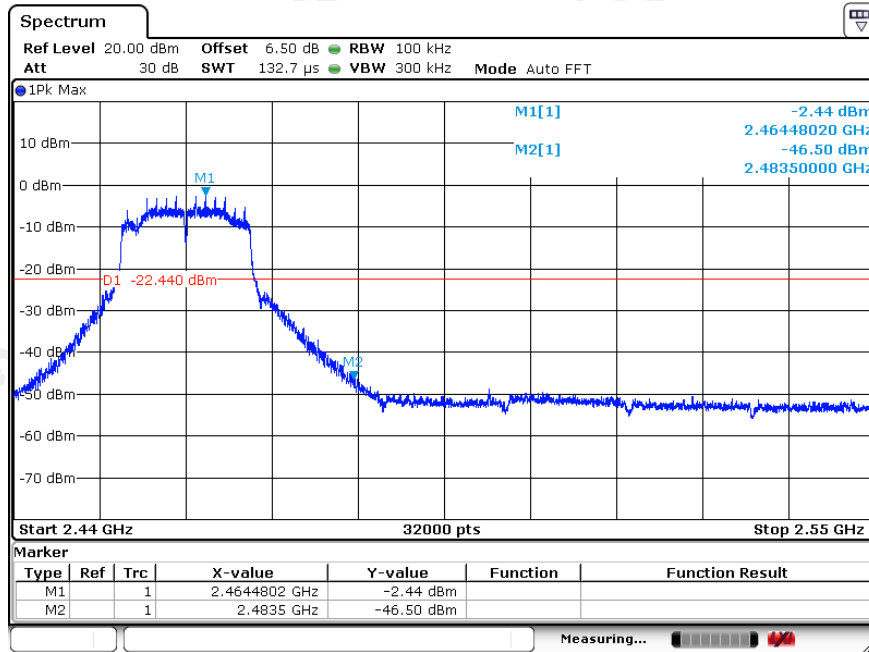

CH: 2412MHz

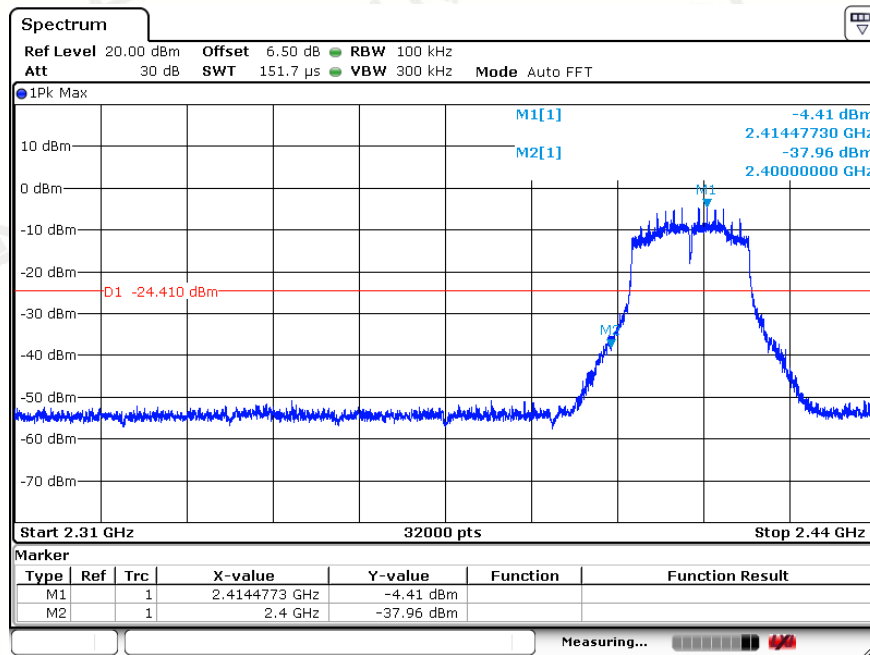

CH: 2462MHz

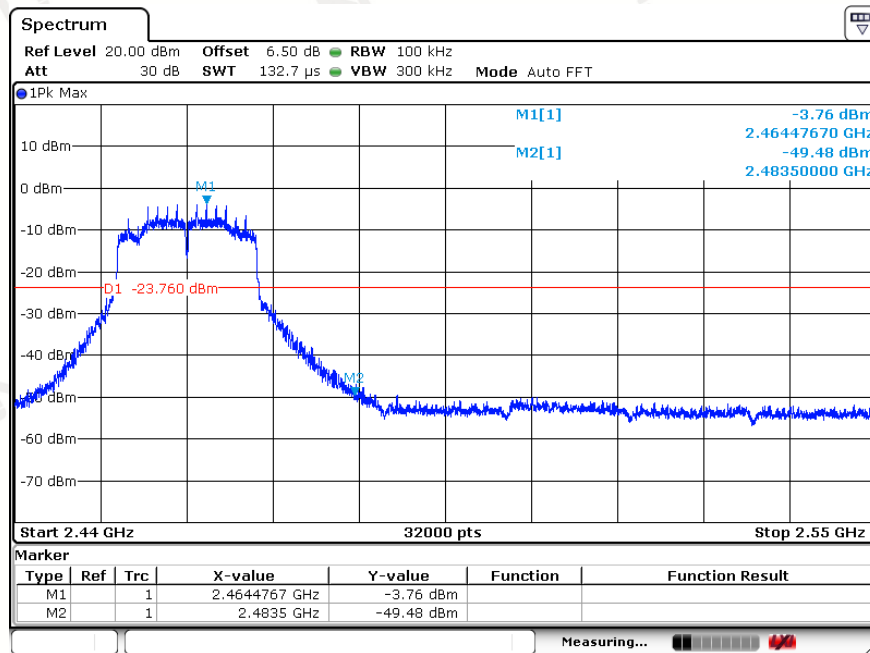

TX 802.11n/HT40 Mode
CH: 2422MHz

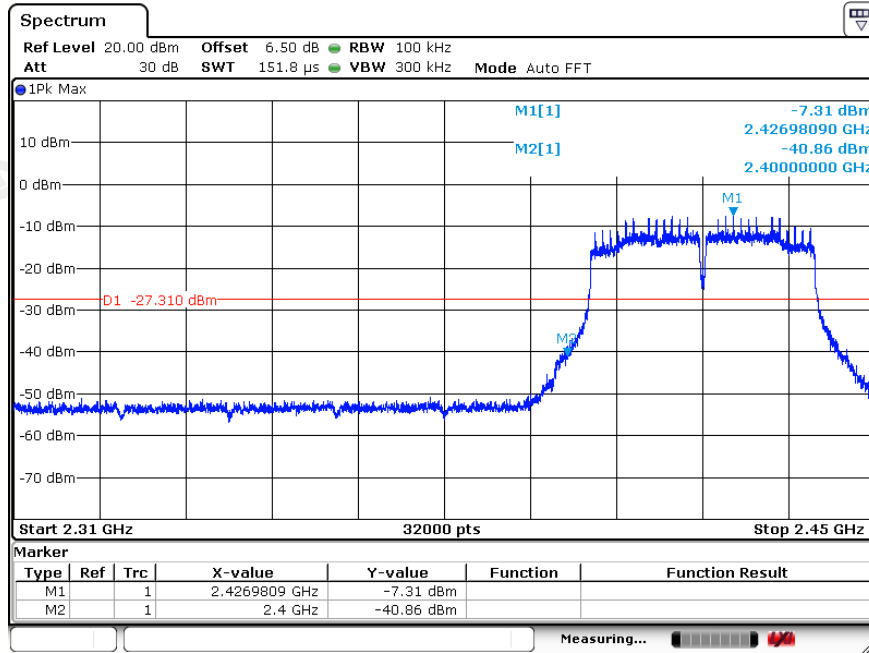

CH: 2452MHz

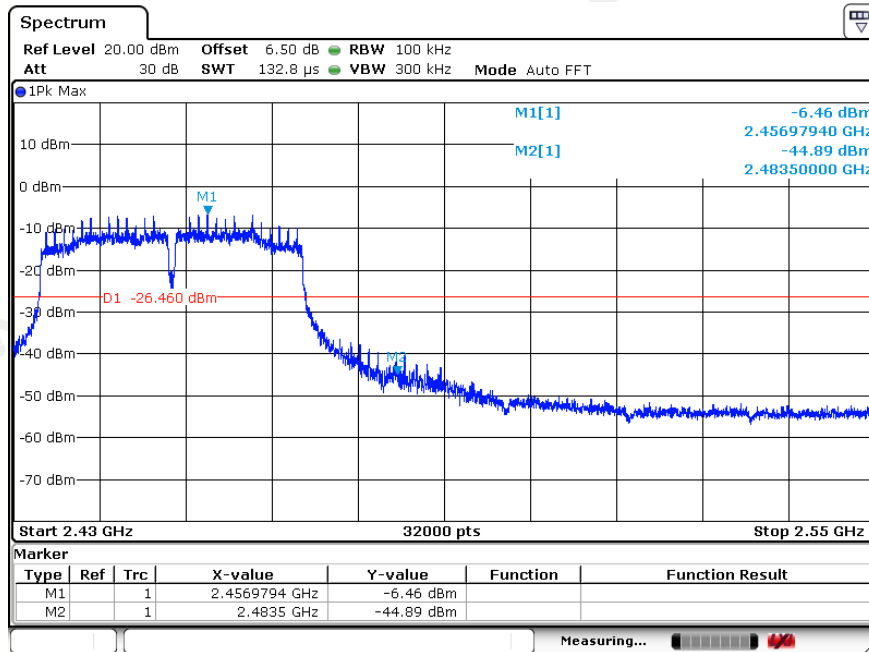

10 ANTENNA REQUIREMENT

Standard Applicable:

For intentional device, according to FCC 47 CFR Section 15.203, an intentional radiator shall be designed to ensure that no antenna other than that furnished by the responsible party shall be used with the device.

Antenna Connected Construction

The antenna used in this product is an Integration Antenna, The directional gains of antenna used for transmitting is 4dBi.

ANTENNA:

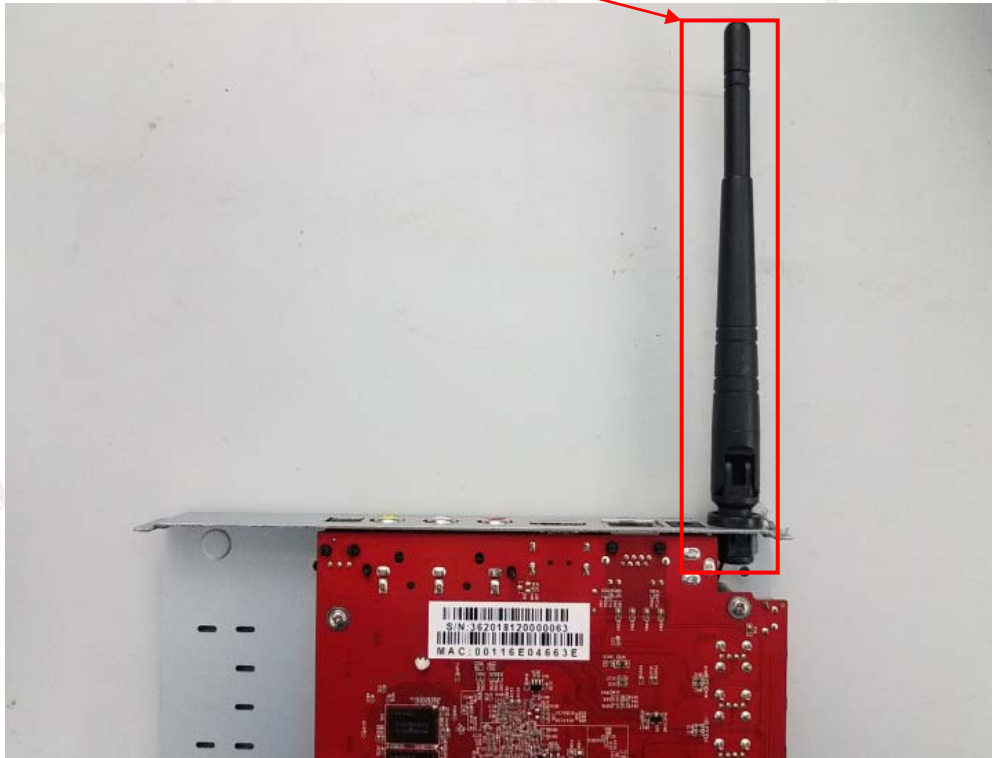

End of Report