

Prüfbericht-Nr.: <i>Test Report No.:</i>	50148210 001	Auftrags-Nr.: <i>Order No.:</i>	114074320	Seite 1 von 33 <i>Page 1 of 33</i>	
Kunden-Referenz-Nr.: <i>Client Reference No.:</i>	N/A	Auftragsdatum: <i>Order date:</i>	24-Jan-2018		
Auftraggeber: <i>Client:</i>	ImGate, Inc. B-4F, 25 Pangyo-ro 256beon-gil, Bundang-gu, Seongnam-si, Gyeonggi-do, South Korea				
Prüfgegenstand: <i>Test item:</i>	Electronic BLE Deadbolt				
Bezeichnung / Typ-Nr.: <i>Identification / Type No.:</i>	IG200				
Auftrags-Inhalt: <i>Order content:</i>	FCC Part15C test report				
Prüfgrundlage: <i>Test specification:</i>	FCC 47 CFR Part 15: Subpart C Section 15.247				
Wareneingangsdatum: <i>Date of receipt:</i>	7-Mar-2018				
Prüfmuster-Nr.: <i>Test sample No.:</i>	A000702775-001 A000702775-003				
Prüfzeitraum: <i>Testing period:</i>	8-Mar-2018 - 8-Mar-2018				
Ort der Prüfung: <i>Place of testing:</i>	EMC/RF Laboratory Taipei				
Prüflaboratorium: <i>Testing laboratory:</i>	TUV Rheinland Taiwan Ltd.				
Prüfergebnis*: <i>Test result*:</i>	Pass				
Report Date / tested by:	kontrolliert von / reviewed by:				
2018-06-01 SamC.J. Kuo/Project Engineer	2018-06-01 Arvin Ho/Vice General Manager				
Datum <i>Date</i>	Name / Stellung <i>Name / Position</i>	Unterschrift <i>Signature</i>	Datum <i>Date</i>	Name / Stellung <i>Name / Position</i>	Unterschrift <i>Signature</i>
Sonstiges / Other:					
Zustand des Prüfgegenstandes bei Anlieferung: <i>Condition of the test item at delivery:</i>			Prüfmuster vollständig und unbeschädigt <i>Test item complete and undamaged</i>		
* Legende: 1 = sehr gut 2 = gut 3 = befriedigend 4 = ausreichend 5 = mangelhaft P(ass) = entspricht o.g. Prüfgrundlage(n) F(ail) = entspricht nicht o.g. Prüfgrundlage(n) N/A = nicht anwendbar N/T = nicht getestet Legend: 1 = very good 2 = good 3 = satisfactory 4 = sufficient 5 = poor P(ass) = passed a.m. test specification(s) F(ail) = failed a.m. test specification(s) N/A = not applicable N/T = not tested					
Dieser Prüfbericht bezieht sich nur auf das o.g. Prüfmuster und darf ohne Genehmigung der Prüfstelle nicht auszugsweise vervielfältigt werden. Dieser Bericht berechtigt nicht zur Verwendung eines Prüfzeichens. <i>This test report only relates to the a. M. Test sample. Without permission of the test center this test report is not permitted to be duplicated in extracts. This test report does not entitle to carry any test mark.</i>					

TEST SUMMARY

5.1.1 ANTENNA REQUIREMENT

RESULT: *Passed*

5.1.2 PEAK OUTPUT POWER

RESULT: *Passed*

5.1.3 6dB BANDWIDTH 99% BANDWIDTH

RESULT: *Passed*

5.1.4 POWER DENSITY

RESULT: *Passed*

5.1.5 CONDUCTED SPURIOUS EMISSIONS AND FREQUENCY BAND EDGE MEASURED IN 100KHz BANDWIDTH

RESULT: *Passed*

5.1.6 SPURIOUS EMISSION

RESULT: *Passed*

6.1.1 ELECTROMAGNETIC FIELDS

RESULT: *Passed*

Contents

1.	GENERAL REMARKS	5
1.1	COMPLEMENTARY MATERIALS.....	5
2.	TEST SITES	6
2.1	TEST FACILITY.....	6
2.2	LIST OF TEST AND MEASUREMENT INSTRUMENTS.....	7
2.3	TRACEABILITY	8
2.4	CALIBRATION	8
2.5	MEASUREMENT UNCERTAINTY	8
3.	GENERAL PRODUCT INFORMATION.....	9
3.1	PRODUCT FUNCTION AND INTENDED USE	9
3.2	SYSTEM DETAILS AND RATINGS.....	9
3.3	INDEPENDENT OPERATION MODES.....	10
3.4	NOISE GENERATING AND NOISE SUPPRESSING PARTS	10
3.5	SUBMITTED DOCUMENTS.....	10
4.	TEST SET-UP AND OPERATION MODES.....	11
4.1	PRINCIPLE OF CONFIGURATION SELECTION	11
4.2	TEST OPERATION AND TEST SOFTWARE.....	11
4.3	SPECIAL ACCESSORIES AND AUXILIARY EQUIPMENT	11
4.4	COUNTERMEASURES TO ACHIEVE EMC COMPLIANCE.....	12
4.5	TEST SETUP DIAGRAM	12
4.6	TEST ENVIRONMENT	14
5.	TEST RESULTS	15
5.1	TRANSMITTER REQUIREMENT & TEST SUITES.....	15
5.1.1	<i>Antenna Requirement</i>	<i>15</i>
5.1.2	<i>Peak Output Power</i>	<i>16</i>
5.1.3	<i>6dB Bandwidth 99% Bandwidth.....</i>	<i>17</i>
5.1.4	<i>Power Density</i>	<i>20</i>
5.1.5	<i>Conducted spurious emissions and Frequency Band Edge measured in 100kHz Bandwidth.....</i>	<i>23</i>
5.1.6	<i>Spurious Emission</i>	<i>27</i>
6.	SAFETY HUMAN EXPOSURE	28
6.1	RADIO FREQUENCY EXPOSURE COMPLIANCE	28
6.1.1	<i>Electromagnetic Fields.....</i>	<i>28</i>
7.	PHOTOGRAPHS OF THE TEST SET-UP.....	29

8.	LIST OF TABLES	33
9.	LIST OF PHOTOGRAPHS.....	33

1. General Remarks

1.1 Complementary Materials

These attachments are integral parts of this test report:

Appendix P: Photo Documentation internal view
(File Name: 50148210APPENDIXP)

Appendix D: Test Result of Radiated Emissions
(File Name: 50148210APPENDIXD)

Test Specifications

The following standards were applied.

Table 1: Applied Standard and Test Levels

Radio
FCC 47 CFR Part 15: Subpart C Section 15.247
FCC 47 CFR Part 2: Subpart J Section 2.1091
ANSI C63.10:2013
KDB 558074 D01 DTS Meas Guidance v03r05
KDB 447498 D01 General RF Exposure Guidance v06

2. Test Sites

2.1 Test Facility

TUV Rheinland Taiwan Ltd.
Taipei Office

11F. No.758, Sec. 4, Bade Rd., Songshan Dist.
Taipei City 105
Taiwan (R.O.C.)

FCC RegistrationNo.: 340738
IC Canada Registration No.: 9465A-1
TAF Accredited NCC Test Lab. No.:0759
TAF ISO17025 Certification effective periods: 2016-Jul-1st to 2019-Jun-30th



Testing Laboratory
0759

2.2 List of Test and Measurement Instruments

Table 2: List of Test and Measurement Equipment

Kind of Equipment	Manu-facturer	Type	S/N	Last Calibration	Next Calibration
Test Software	Farad	EZ_EMG	Ver. TUV3A1	N/A	N/A
EMI Test Receiver	R&S	ESR 7	101549	2017/11/10	2018/11/10
Spectrum Analyzer	R&S	FSV 40	100921	2017/05/02	2018/05/01
Spectrum Analyzer	Agilent	N9010A	MY53470241	2017/05/23	2018/05/22
Preamplifier (30MHz -1GHz)	HP	8447F	2805A03335	2017/08/14	2018/08/14
Preamplifier (18 GHz -40 GHz)	COM-POWER	PAM-840	461257	2018/01/18	2019/01/18
Pre-Amplifier (1GHz~18GHz)	EM Electronics	EM01G18G	60558	2017/11/21	2018/11/21
Bilog Antenna	TESEQ	CBL6111D	29802	2017/07/12	2018/07/12
Horn Antenna	ETS-Lindgren	3117	138160	2017/05/25	2018/05/25
Horn Antenna (18GHz~40GHz)	COM-POWER	AH-840	101029	2017/11/28	2018/11/28
Loop Antenna	Schwarzbeck	FMZB 1513	1513-076	2017/06/14	2018/06/14

2.3 Traceability

All measurement equipment calibrations are traceable to NML(Taiwan)/NIST(USA) or where calibration is performed outside Taiwan, to equivalent nationally recognized standards organizations.

2.4 Calibration

Equipment requiring calibration is calibrated periodically in a suitably accredited Calibration Lab. Additionally all equipment is verified for proper performance on a regular schedule using in house standards or comparisons.

2.5 Measurement Uncertainty

The estimated combined standard uncertainty for radiated emissions and conducted emissions measurements.

Table 3: Emission Measurement Uncertainty

Parameter	Uncertainty
Radio Frequency	$\pm 1 \times 10^{-7}$
RF power, conducted	± 1.5 dB
RF power density, conducted	± 3 dB
spurious emissions, conducted	± 3 dB
all emissions, radiated	± 6 dB
Temperature	± 1 °C
Humidity	± 5 %
DC and low frequency voltages	± 3 %

3. General Product Information

3.1 Product Function and Intended Use

The EUT is a Electronic BLE Deadbolt. It contains a Bluetooth Low Energy compatible module enabling the user to communicate data through a Wireless interface.

For details refer to the User Guide, Data Sheet and Circuit Diagram.

3.2 System Details and Ratings

Table 4: Basic Information of EUT

Item	EUT information
Kind of Equipment	Electronic BLE Deadbolt
Type Designation	IG200
FCC ID	2AM9G-IG200

Table 5: Technical Specification of EUT

Technical Specification	Value
Operating Frequencies	2402~2480 MHz
Channel Spacing	2 MHz
Channel number	40
Operation Voltage	6Vdc
Modulation	GFSK
Antenna gain	3.88 dBi

3.3 Independent Operation Modes

Basic operation modes are:

- A. Transmitting
 - 1. Low channel
 - 2. Middle channel
 - 3. High channel
- B. Receiving
- C. Standby
- D. Off

3.4 Noise Generating and Noise Suppressing Parts

Refer to the Circuit Diagram.

3.5 Submitted Documents

- Circuit Diagram
- Instruction Manual
- Rating Label
- Technical Description

4. Test Set-up and Operation Modes

4.1 Principle of Configuration Selection

The equipment under test (EUT) was configured to measure its maximum power level. The test modes were adapted accordingly in reference to the instructions for use.

4.2 Test Operation and Test Software

Setup for testing: Test samples are provided with USB interface which makes it possible to control them through test software installed on a notebook computer.

This software, nRFgo was running on the laptop computer connected to the EUT. It was used to enable the operation modes listed in section 3.3 as appropriate.

Full test was applied on all test modes, but only worst case was shown

4.3 Special Accessories and Auxiliary Equipment

The product has been tested together with the following additional accessories:

Description	Manufacturer	Model No.	Serial No.
Notebook(EMC-06)	Lenovo	TP00048A	PB-0F8B2

4.4 Countermeasures to achieve EMC Compliance

The test sample which has been tested contained the noise suppression parts as described in the Constructional Data Form or the Technical Construction File. No additional measures were employed to achieve compliance.

4.5 Test Setup Diagram

Diagram of Measurement Configuration for Radiation Test

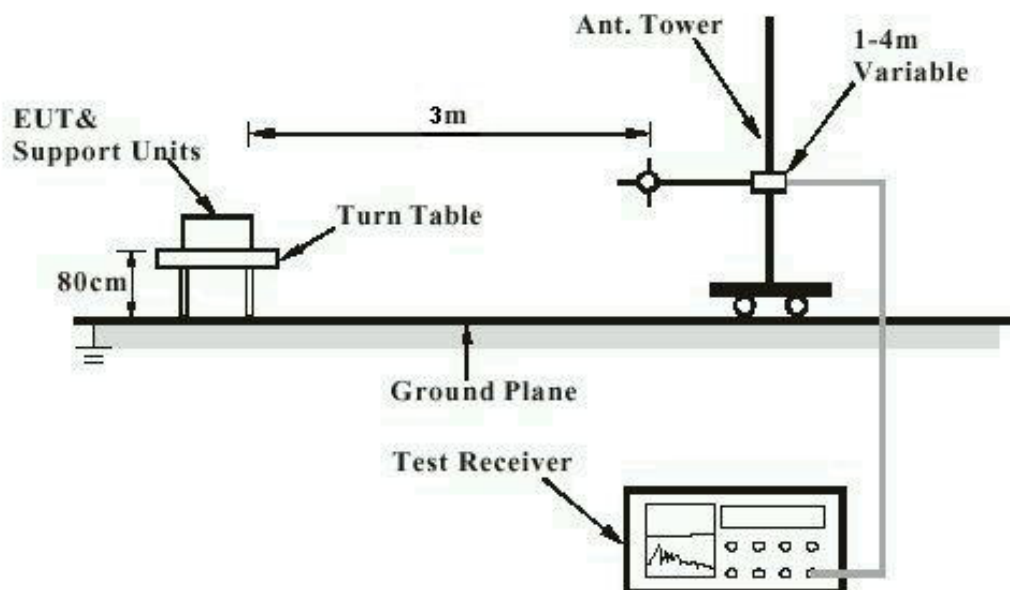

Note: Measurements above 1 GHz are done with a table height of 1.5m

Diagram of Measurement Equipment Configuration for Mains Conduction Measurement (if applicable)

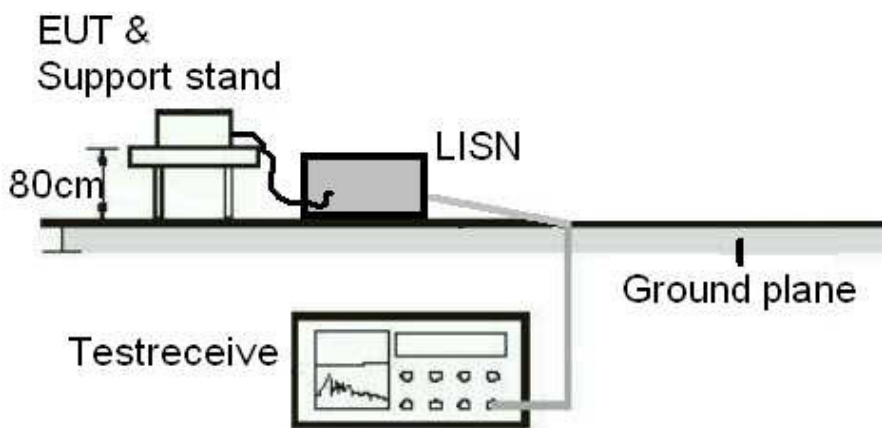
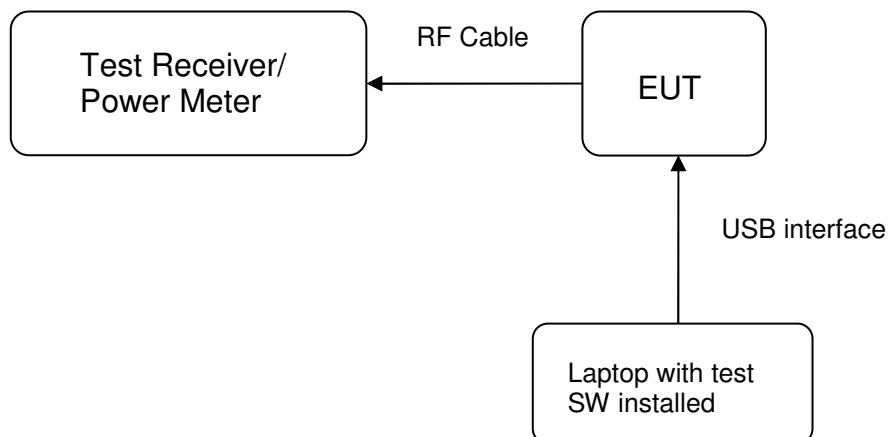

Diagram of Measurement Equipment Configuration for Conducted Transmitter Measurement



Prüfbericht - Nr.: 50148210 001
Test Report No.

Seite 14 von 33
Page 14 of 33

4.6 Test Environment

Ambient temperature : 18-25°C
Relative humidity : 45-65 %

5. Test Results

5.1 Transmitter Requirement & Test Suites

5.1.1 Antenna Requirement

RESULT: **Passed**

Test standard	:	LP0002(2018): 2.2, 3.10.1,3 FCC Part 15.247(b)(4), Part 15.203 and RSS- Gen 8.3
Requirement	:	use of approved antennas only with directional gains that do not exceed 6 dBi

According to the manufacturer declaration, the EUT has an antenna with a directional gain of 3.88 dBi. The antenna is PCB Antenna with no possibility of replacement with a non-approved antenna by the end-user. Therefore, the EUT is considered to comply with this provision.

Refer to EUT photo for details.

5.1.2 Peak Output Power

RESULT:
Passed

Test standard : LP0002(2018): 3.10.1.2 (1) (C)
 FCC Part 15.247(b)(3), RSS-247 5.4(4)
 Basic standard : ANSI C63.10:2013, KDB558074
 Limit : 1 Watt
 Kind of test site : Shielded room/Conducted room

Test setup

Test Channel : Low/ Middle/ High
 Operation Mode : A

Table 6: Test result of Peak Output Power

Channel	Channel Frequency (MHz)	Output Power		Limit
		(dBm)	(W)	(W)
Low Channel	2402	-30.56	0.000001	1
Middle Channel	2440	-30.10	0.000001	1
High Channel	2480	-30.42	0.000001	1

Pmax: 0.001mW

5.1.3 6dB Bandwidth 99% Bandwidth

RESULT:
Passed

Test standard : LP0002(2018): 3.10.1.6 (2)(A)
 FCC Part 15.247(a)(2), RSS-247 5.2(1)
 Basic standard : ANSI C63.10:2013, KDB558074
 Kind of test site : Shielded room/Conducted room

Test setup

Test Channel : Low/ Middle/ High
 Operation Mode : A

Table 7: Test result of 6dB Bandwidth

Channel	Channel Frequency (MHz)	6dB Bandwidth (kHz)	Limit (kHz)	Result
Low Channel	2402	689.3	>500	Pass
Mid Channel	2440	692.3	>500	Pass
High Channel	2480	686.3	>500	Pass

Table 8: Test result of 99% Bandwidth,

Channel	Channel Frequency (MHz)	99% Bandwidth (MHz)
Mid Channel	2440	2.439

Test Plot of 6dB Bandwidth

Low Channel

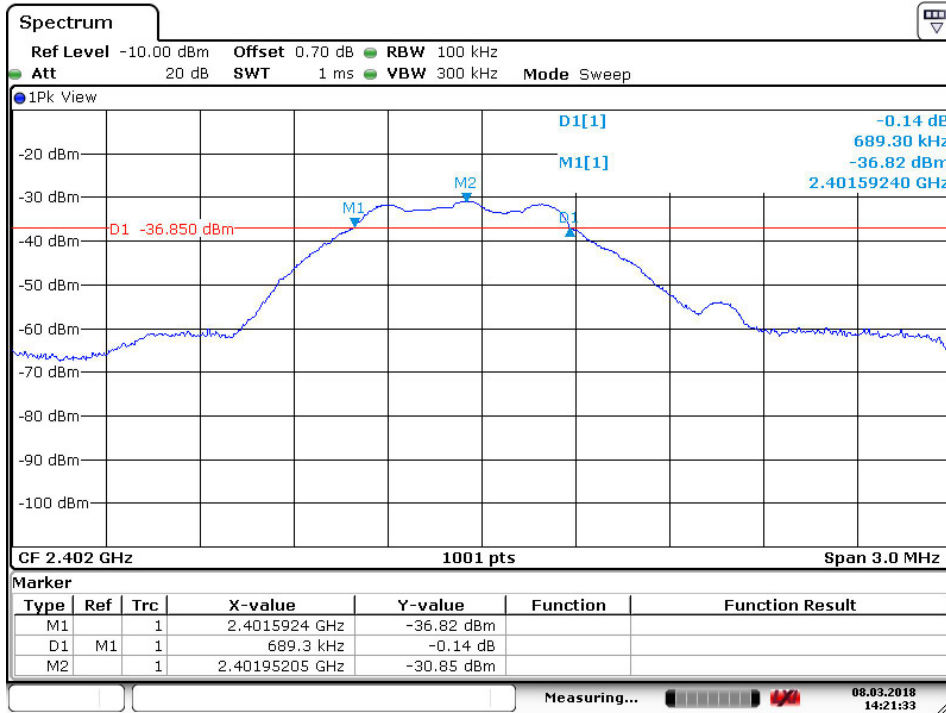

Date: 8. MAR 2018 14:21:33

Middle Channel

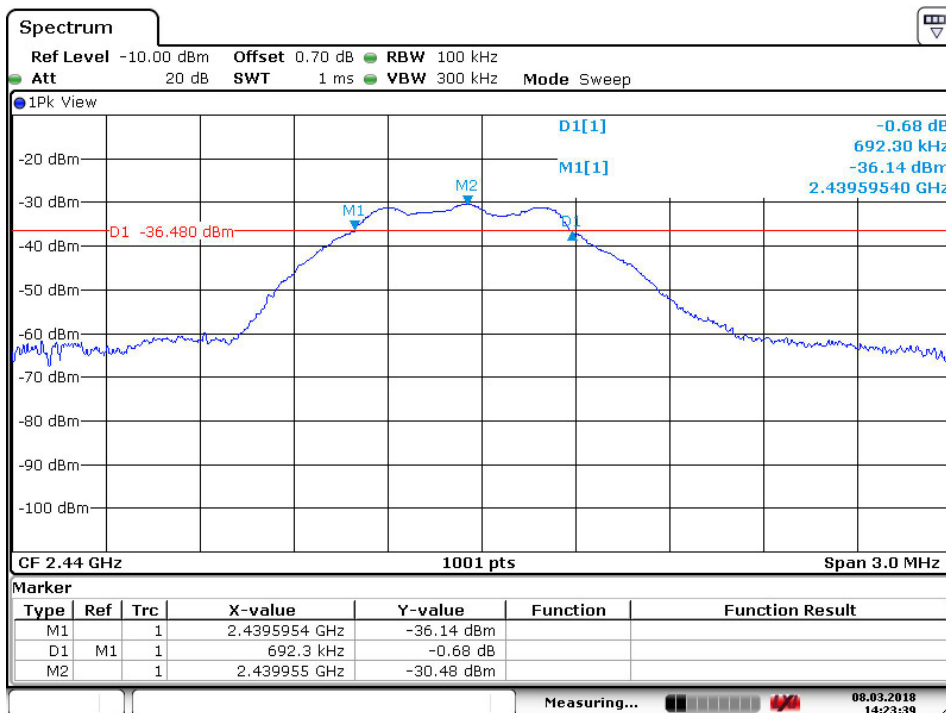

Date: 8. MAR 2018 14:23:39

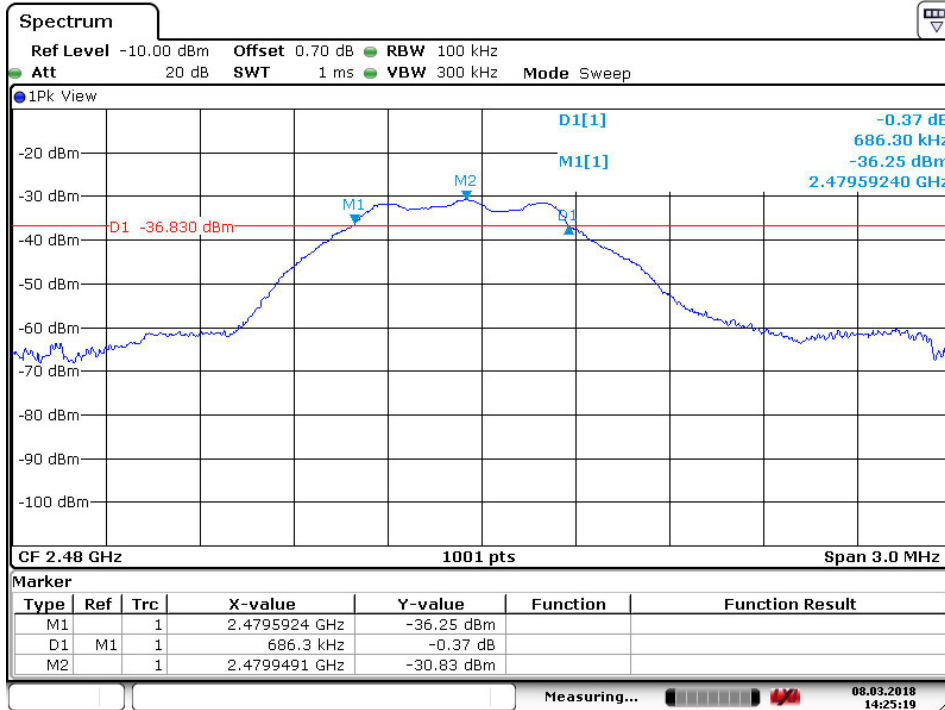
High Channel

Date: 8. MAR. 2018 14:25:19

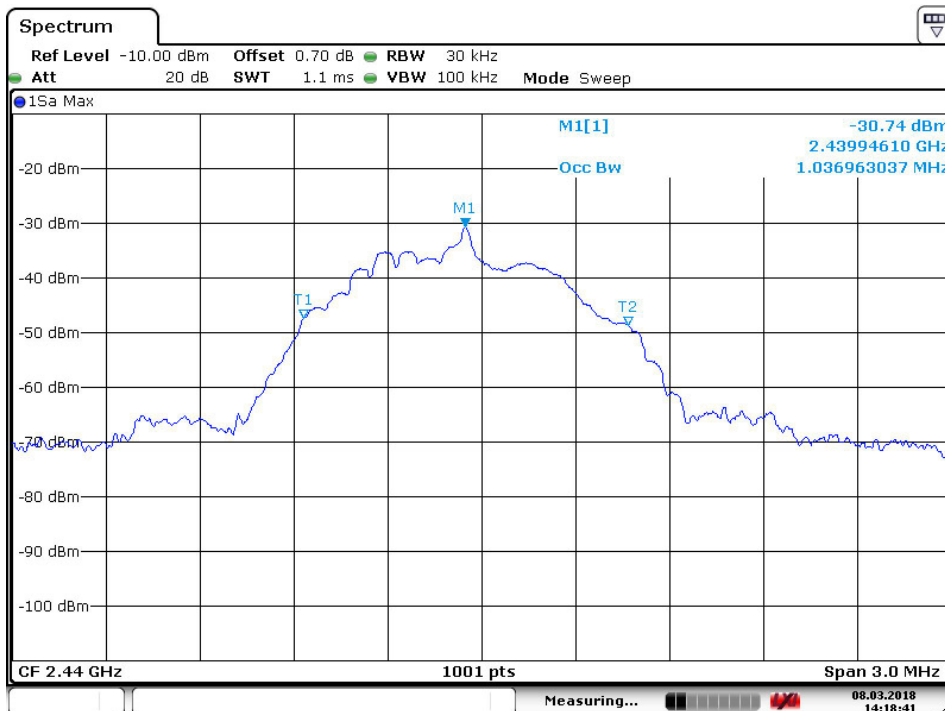
Test Plot of 99% Bandwidth

Date: 8. MAR. 2018 14:18:40

5.1.4 Power Density

RESULT:**Passed**

Test standard : LP0002(2018): 3.10.1,6 (2)(B)
FCC Part 15.247(e) , RSS-247 5.2(2)
Basic standard : ANSI C63.10:2013, KDB558074
Kind of test site : Shielded room/Conducted room

Test setup

Test Channel : Low/ Middle/ High
Operation Mode : A

Table 9: Test result of Power Density

Channel	Channel Frequency (MHz)	Power Density	Limit
		(dBm)	(dBm)
Low Channel	2402	-43.98	8
Middle Channel	2440	-41.79	8
High Channel	2480	-42.78	8

Test Plot of Power Density

Low Channel

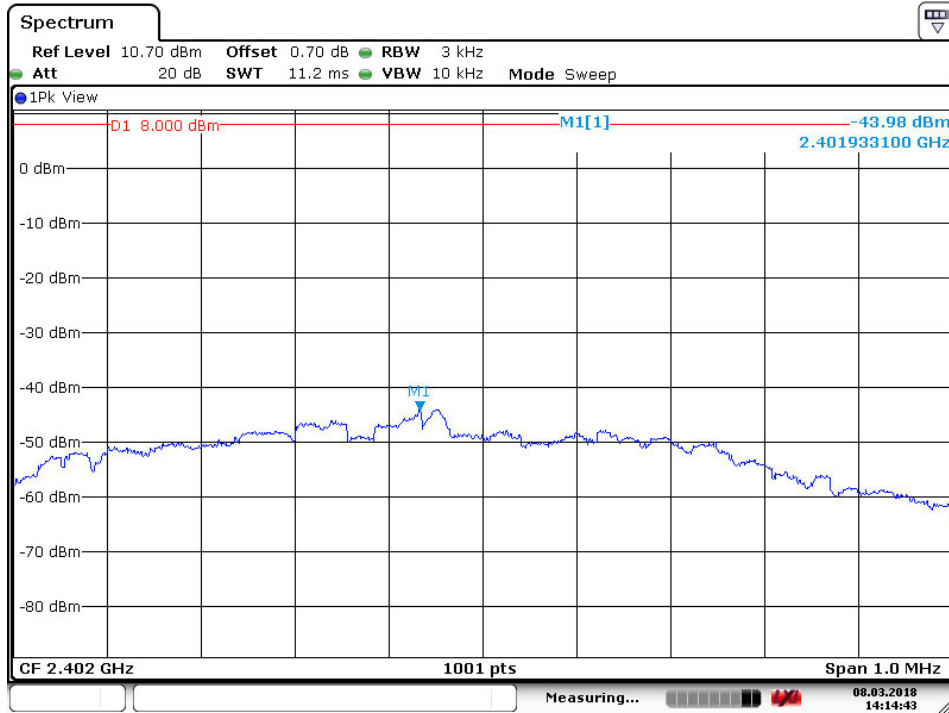

Date: 8. MAR 2018 14:14:43

Middle Channel

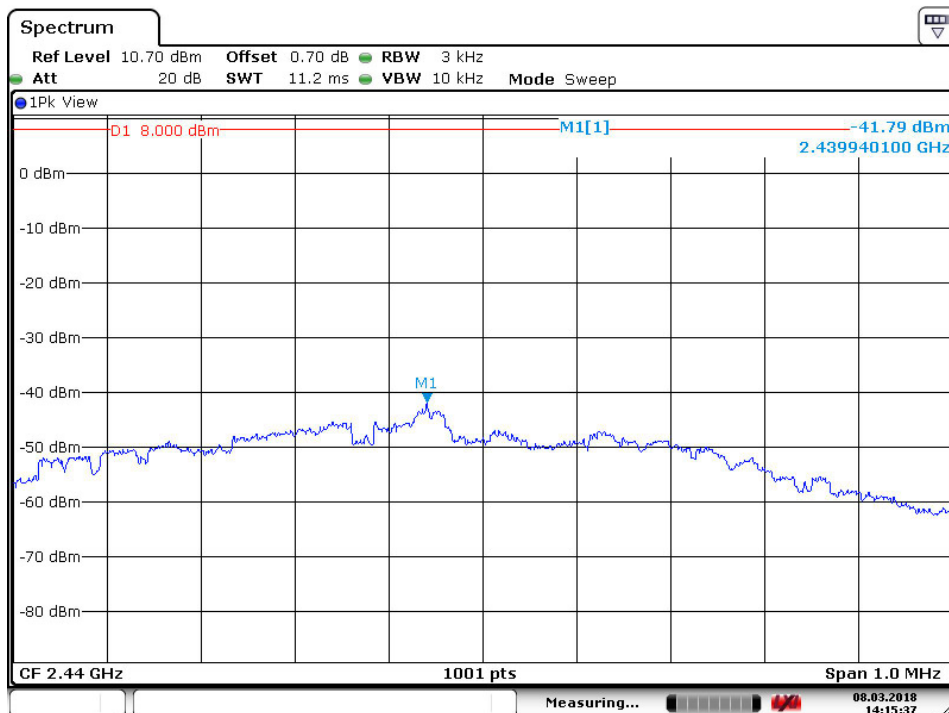

Date: 8. MAR 2018 14:15:38

High Channel

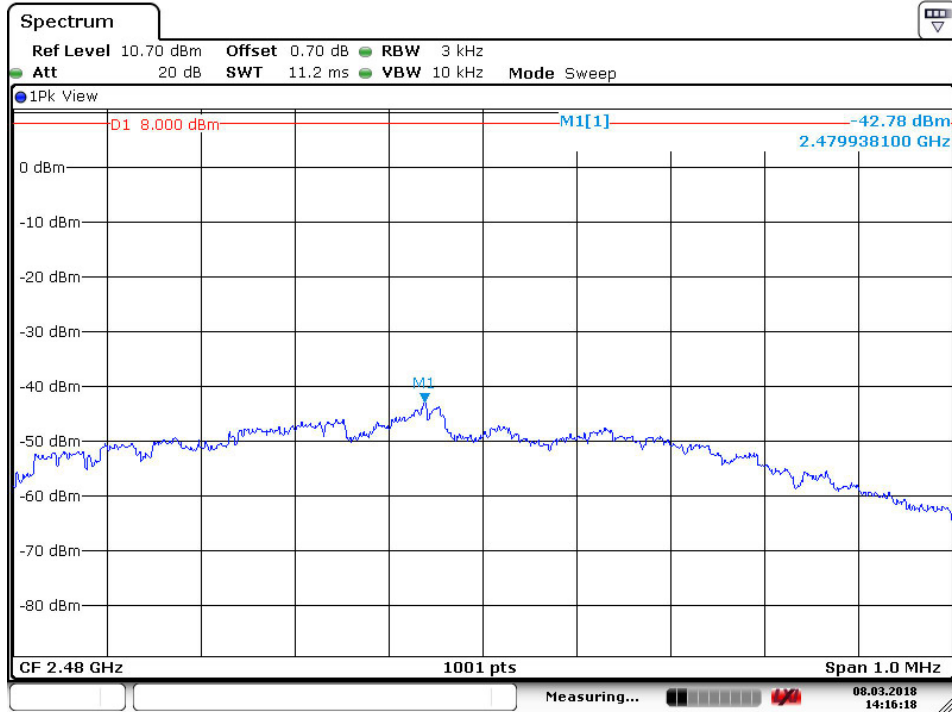

Date: 8.MAR.2018 14:16:18

5.1.5 Conducted spurious emissions and Frequency Band Edge measured in 100kHz Bandwidth

RESULT:**Passed**

Test standard : LP0002(2018): 3.10.1.5
FCC part 15.247(d), RSS-247 5.5
Basic standard : ANSI C63.10:2013, KDB558074
Limit : 20dB (below that in the 100kHz bandwidth within the
band that contains the highest level of the desired power)
Kind of test site : Shielded room/Conducted room

Test setup

Test Channel : Low/Mid/High for spurious emissions,
Low/High for Band Edge
Operation mode : A

All emissions are more than 20dB below fundamental, details refer to following test plot, and compliance is achieved as well.
Due to the small size of the product and that there are no inductive components of significant size, 9kHz to 30MHz frequency range is not tested based on technical judgment.

Test Plot 100kHz Conducted Emissions

Low Channel

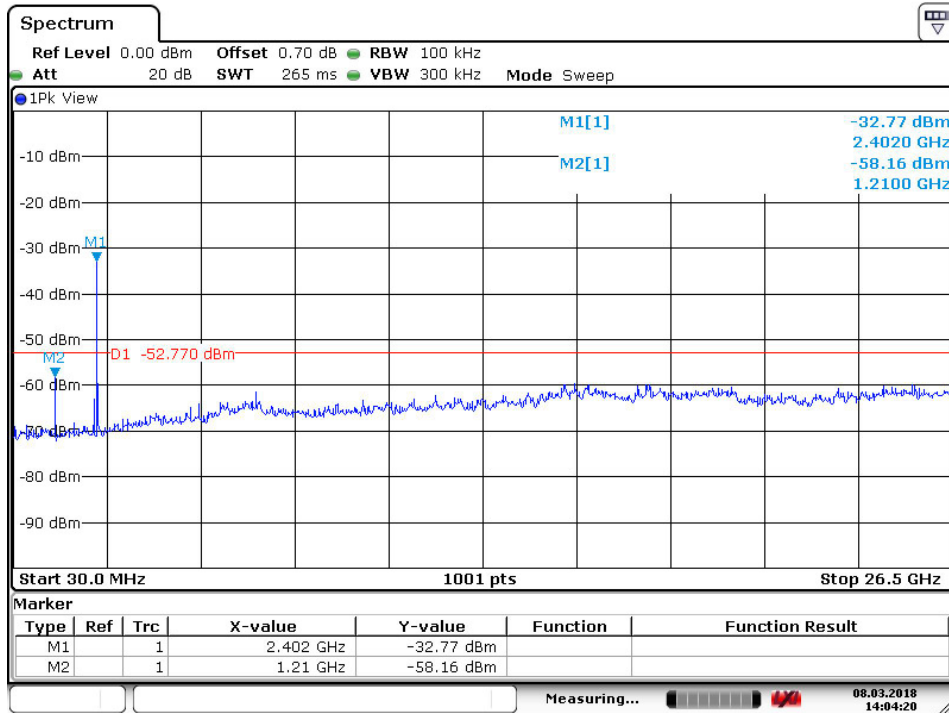

Date: 8.MAR.2018 14:04:19

Middle Channel

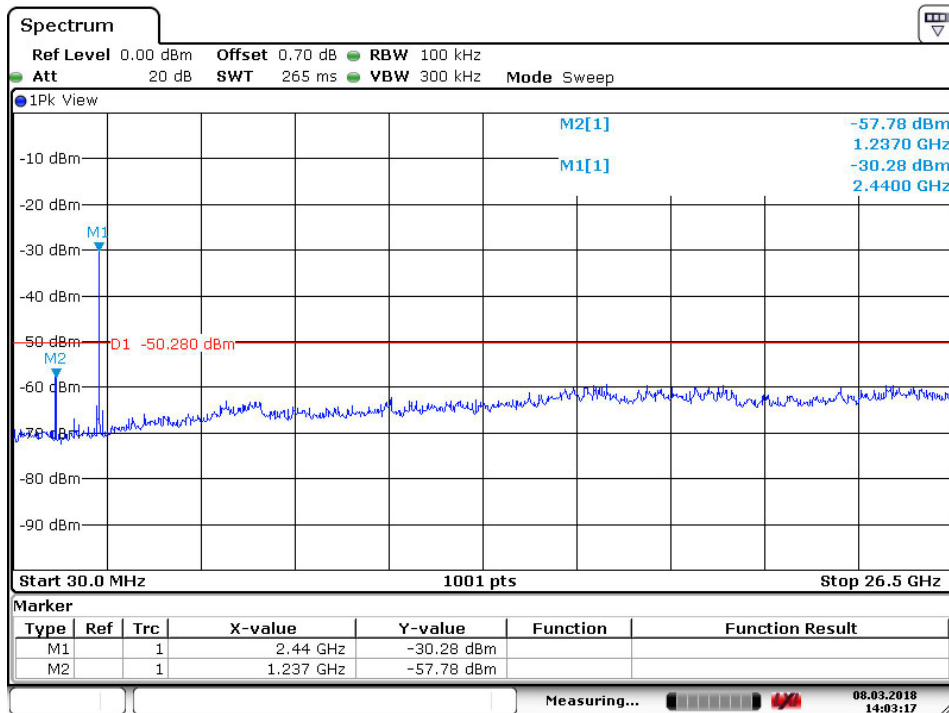

Date: 8.MAR.2018 14:03:17

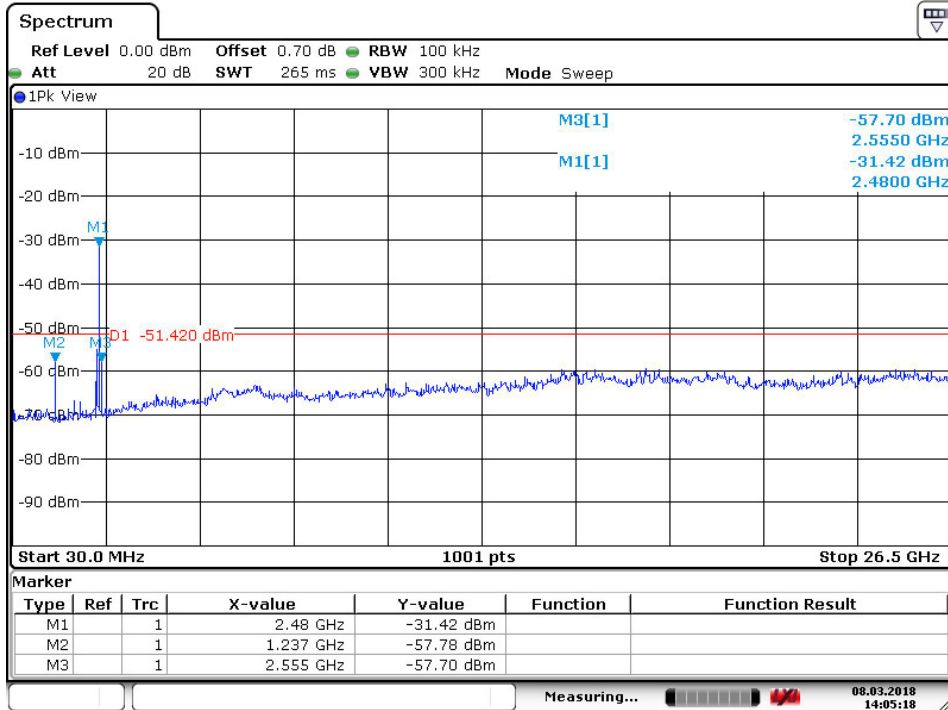
High Channel

Date: 8.MAR.2018 14:05:19

Test Plot 100kHz RBW of Band Edge

Low Channel

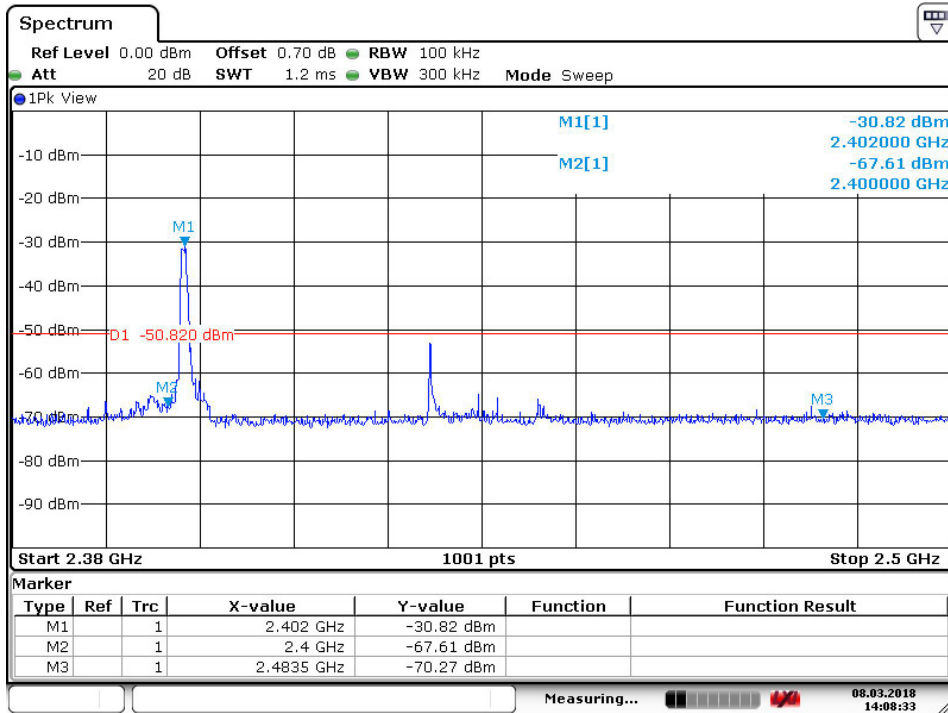

Date: 8. MAR. 2018 14:08:33

High Channel

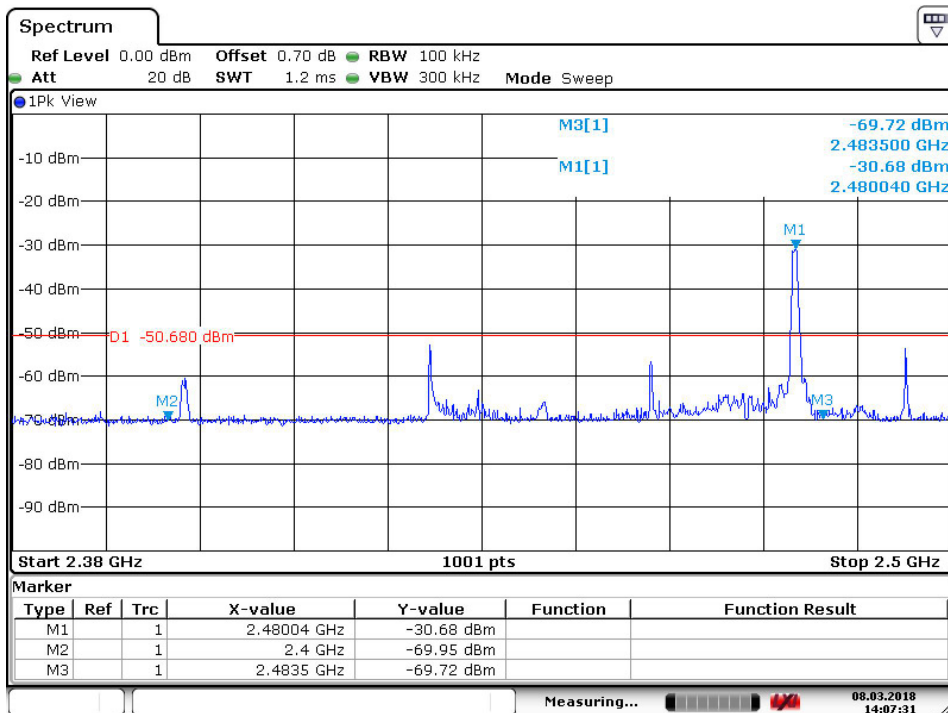

Date: 8. MAR. 2018 14:07:31

5.1.6 Spurious Emission

RESULT:**Passed**

Test standard	:	FCC part 15.247(d), FCC 15.205, FCC 15.209, RSS-210 2.2, RSS-247 5.5 and RSS-Gen i4, 8.9 (Table 6), LP0002(2018): 3.10.1.5
Basic standard	:	ANSI C63.10: 2009
Limits	:	Radiated emissions which fall in the restricted bands, as defined in FCC 15.205(a) and RSS-Gen i4, 8.9 (Table 6), must comply with the radiated emission limits specified in FCC 15.209(a) and RSS-Gen i4, 8.9 (Table 4 and 5). Radiated emissions which fall in the restricted bands, as defined in LP0002(2018): 2.7 , must comply with the radiated emission limits specified in LP0002(2018): 2.8 Emission radiated outside the specified frequency bands must comply with the radiated emission limits specified in FCC 15.209(a) and FCC 15.249(a), RSS-Gen i4, 8.9 (Table 4 and 5) and RSS-210 A2.9(a). Emission radiated outside the specified frequency bands must comply with the radiated emission limits specified in LP0002(2018): 2.8
Kind of test site	:	3m Semi-Anechoic Chamber

Test setup

Test Channel	:	Low/ Middle/ High
Operation mode	:	A, B

Remark: Testing was carried out within frequency range 30MHz to the tenth harmonic.

For details refer to Appendix D.

Testing was carried out within frequency range 30MHz to the tenth harmonic. For details refer to Appendix D. The Radiated Emissions testing was performed in the X, Y and Z axis orientation. The worst-case Axis orientation is recorded in this test report.

6. Safety Human exposure

6.1 Radio Frequency Exposure Compliance

6.1.1 Electromagnetic Fields

RESULT:**Passed**

Test standard : FCC KDB Publication 447498 D01 v06

FCC:

Since maximum peak output power of the transmitter is $0.001\text{mW} < 10\text{mW}$, hence the EUT is excluded from SAR evaluation according to FCC KDB publication 447498 D01 v05: Mobile Portable RF Exposure

7. Photographs of the Test Set-Up

Photograph 1: Set-up for Spurious Emissions (Front View)

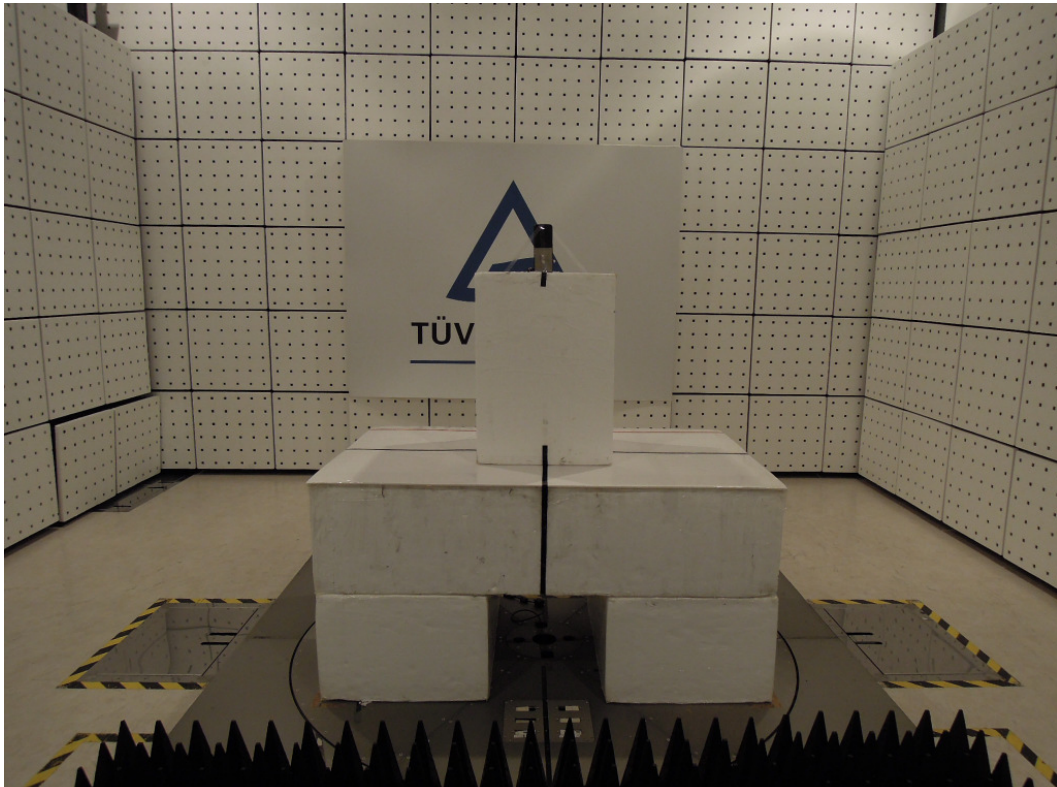

Photograph 2: Set-up for Spurious Emissions (Back View 1)



Photograph 3: Set-up for Spurious Emissions (Back View 2)

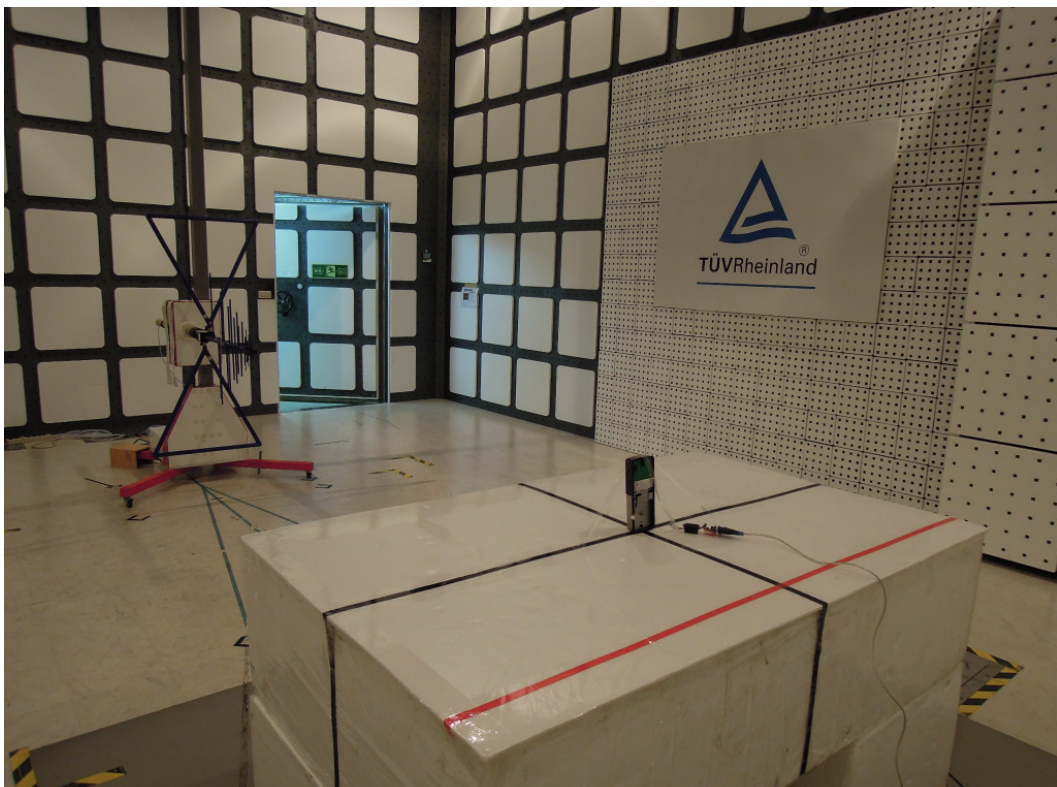

Photograph 4: Set-up for Spurious Emissions (Back View 3)

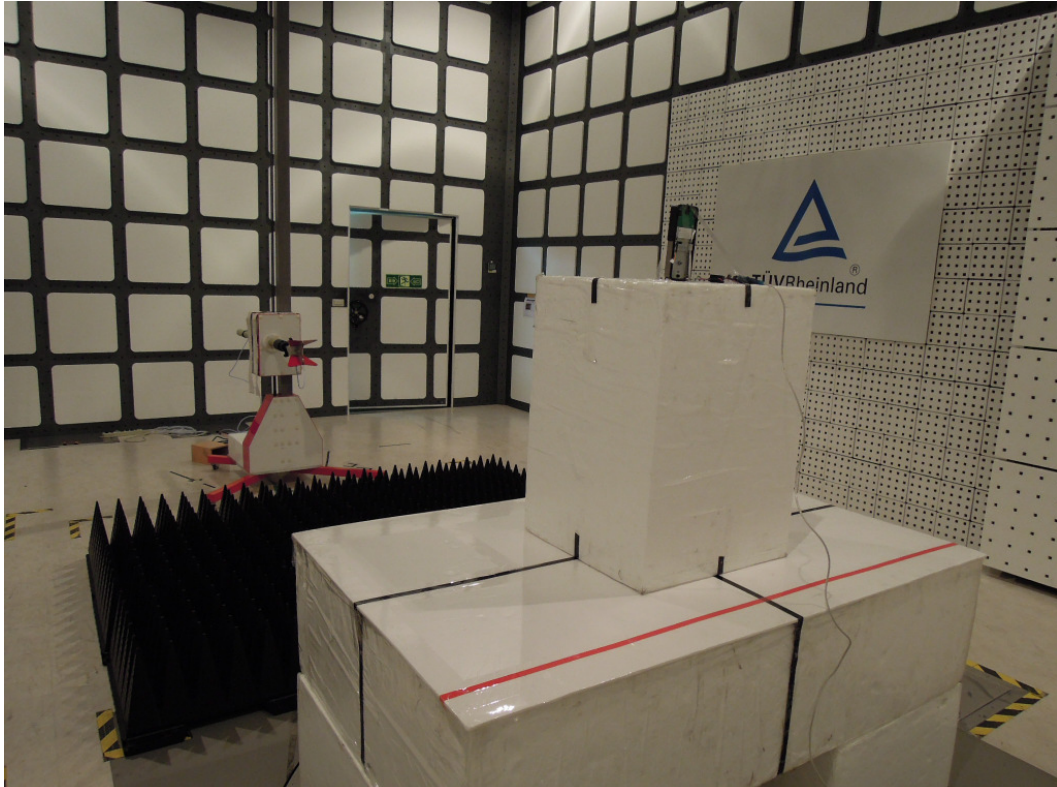

Photograph 5: Set-up for Spurious Emissions (Back View 4)

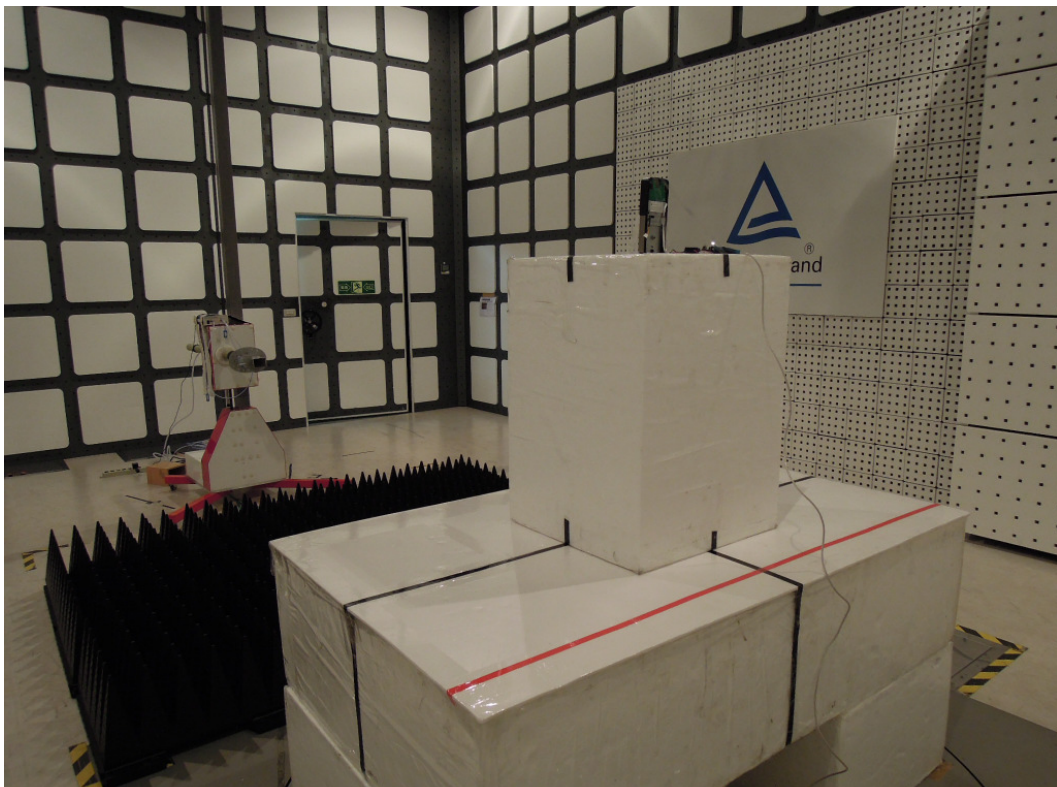

Photograph 6: Set-up for Conducted testing

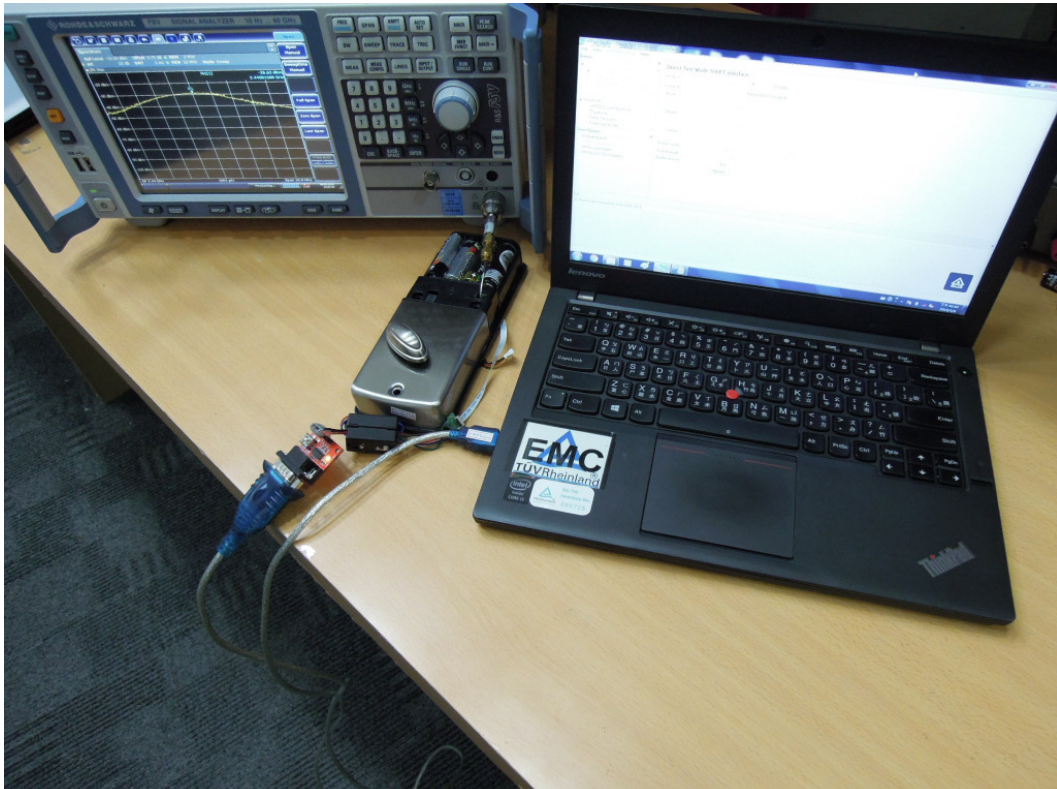

8. List of Tables

Table 1: Applied Standard and Test Levels	5
Table 2: List of Test and Measurement Equipment	7
Table 3: Emission Measurement Uncertainty.....	8
Table 4: Basic Information of EUT	9
Table 5: Technical Specification of EUT	9
Table 6: Test result of Peak Output Power	16
Table 7: Test result of 6dB Bandwidth	17
Table 8: Test result of 99% Bandwidth,.....	17
Table 9: Test result of Power Density	20

9. List of Photographs

Photograph 1: Set-up for Spurious Emissions (Front View).....	29
Photograph 2: Set-up for Spurious Emissions (Back View 1)	30
Photograph 3: Set-up for Spurious Emissions (Back View 2)	30
Photograph 4: Set-up for Spurious Emissions (Back View 3)	31
Photograph 4: Set-up for Spurious Emissions (Back View 4)	31
Photograph 5: Set-up for Conducted testing	32