



TEST REPORT

FCC PART 15.247

Report Reference No.: CTL1906061031-WF01

Compiled by:
(position+printed name+signature)

Happy Guo
(File administrators)

Happy Guo

Tested by:
(position+printed name+signature)

Nice Nong
(Test Engineer)

Nice Nong

Approved by:
(position+printed name+signature)

Ivan Xie
(Manager)

Ivan Xie

Product Name.....: IPX7 Outdoor Speaker

Model/Type reference: HPS-022

List Model(s).....: See page 2.

Trade Mark.....: N/A

FCC ID.....: 2AM8S-HPS0

Applicant's name: **SHENZHEN HOTOP ELECTRONIC TECHNOLOGY CO., LTD.**

Address of applicant: No.6, Lane 2, ShaTai Road, The Second Industrial Park,
NanShan, HuMen District, Dong Guan, China

Test Firm: **Shenzhen CTL Testing Technology Co., Ltd.**

Address of Test Firm: Floor 1-A, Baisha Technology Park, No.3011, Shahexi Road,
Nanshan District, Shenzhen, China 518055

Test specification.....:

Standard.....: **FCC Part 15.247:** Operation within the bands 902-928 MHz,
2400-2483.5 MHz and 5725-5850 MHz.

TRF Originator: Shenzhen CTL Testing Technology Co., Ltd.

Master TRF: Dated 2011-01

Date of receipt of test item.....: Jul. 05, 2019

Date of sampling.....: Jul. 05, 2019

Date of Test Date.....: Jul. 05, 2019–Jul. 15, 2019

Data of Issue.....: Jul. 23, 2019

Result.....: **Pass**

Shenzhen CTL Testing Technology Co., Ltd. All rights reserved.

This publication may be reproduced in whole or in part for non-commercial purposes as long as the Shenzhen CTL Testing Technology Co., Ltd. is acknowledged as copyright owner and source of the material. Shenzhen CTL Testing Technology Co., Ltd. takes no responsibility for and will not assume liability for damages resulting from the reader's interpretation of the reproduced material due to its placement and context.

TEST REPORT

Test Report No. :	CTL1906061031-WF01	Jul. 23, 2019 Date of issue
--------------------------	---------------------------	--------------------------------

Equipment under Test : IPX7 Outdoor Speaker

Model /Type : HPS-022

Listed Models : HPS-086, HPS-087, HPS-088, HPS-089, HPS-090, HPS-091, HPS-092, HPS-093, HPS-094, HPS-095, HPS-096, HPS-097, HPS-098, HPS-099, HPS-100, HPS-101, HPS-102, HPS-103, HPS-104, HPS-105, HPS-106, HPS-107, HPS-108, HPS-109, HPS-110, HPS-111, HPS-112, HPS-113, HPS-114, HPS-115, HPS-116, HPS-117, HPS-118, HPS-119, HPS-120, HPS-121, HPS-122, HPS-123, HPS-124, HPS-125, HPS-126, HPS-127, HPS-128, HPS-129, HPS-130

Applicant : **SHENZHEN HOTOP ELECTRONIC TECHNOLOGY CO., LTD.**

Address : No.6, Lane 2, ShaTai Road, The Second Industrial Park, NanShan, HuMen District, Dong Guan, China

Manufacturer : **SHENZHEN HOTOP ELECTRONIC TECHNOLOGY CO., LTD**

Address : No.6, Lane 2, ShaTai Road, The Second Industrial Park, NanShan, HuMen District, Dong Guan, China

Test result	Pass *
--------------------	---------------

*In the configuration tested, the EUT complied with the standards specified page 5.

The test results presented in this report relate only to the object tested.

This report shall not be reproduced, except in full, without the written approval of the issuing testing laboratory.

Table of Contents

Page

1. SUMMARY.....	5
1.1. TEST STANDARDS.....	5
1.2. TEST DESCRIPTION.....	5
1.3. TEST FACILITY.....	6
1.4. STATEMENT OF THE MEASUREMENT UNCERTAINTY.....	6
2. GENERAL INFORMATION.....	8
2.1. ENVIRONMENTAL CONDITIONS.....	8
2.2. GENERAL DESCRIPTION OF EUT.....	8
2.3. DESCRIPTION OF TEST MODES AND TEST FREQUENCY.....	8
2.4. EQUIPMENTS USED DURING THE TEST.....	9
2.5. RELATED SUBMITTAL(S) / GRANT (S).....	10
2.6. MODIFICATIONS.....	10
3. TEST CONDITIONS AND RESULTS.....	11
3.1. CONDUCTED EMISSIONS TEST.....	11
3.2. RADIATED EMISSIONS AND BAND EDGE.....	14
3.3. MAXIMUM PEAK OUTPUT POWER.....	21
3.4. 20dB BANDWIDTH.....	25
3.5. FREQUENCY SEPARATION.....	29
3.6. NUMBER OF HOPPING FREQUENCY.....	31
3.7. TIME OF OCCUPANCY (DWELL TIME).....	33
3.8. OUT-OF-BAND EMISSIONS.....	37
3.9. PSEUDORANDOM FREQUENCY HOPPING SEQUENCE.....	45
3.10. ANTENNA REQUIREMENT.....	46
4. TEST SETUP PHOTOS OF THE EUT.....	47
5. PHOTOS OF THE EUT.....	48

1. SUMMARY

1.1. TEST STANDARDS

The tests were performed according to following standards:

[FCC Rules Part 15.247](#): Frequency Hopping, Direct Spread Spectrum and Hybrid Systems that are in operation within the bands of 902-928 MHz, 2400-2483.5 MHz, and 5725-5850 MHz

[ANSI C63.10: 2013](#): American National Standard for Testing Unlicensed Wireless Devices

1.2. Test Description

FCC PART 15.247		
FCC Part 15.207	AC Power Conducted Emission	PASS
FCC Part 15.247(a)(1)(i)	20dB Bandwidth	PASS
FCC Part 15.247(d)	Spurious RF Conducted Emission	PASS
FCC Part 15.247(b)	Maximum Peak Output Power	PASS
FCC Part 15.247(b)	Pseudorandom Frequency Hopping Sequence	PASS
FCC Part 15.247(a)(1)(iii)	Number of hopping frequency & Time of Occupancy	PASS
FCC Part 15.247(a)(1)	Frequency Separation	PASS
FCC Part 15.205/15.209	Radiated Emissions	PASS
FCC Part 15.247(d)	Band Edge Compliance of RF Emission	PASS
FCC Part 15.203/15.247 (b)	Antenna Requirement	PASS

1.3. Test Facility

1.3.1 Address of the test laboratory

Shenzhen CTL Testing Technology Co., Ltd.

Floor 1-A, Baisha Technology Park, No. 3011, Shahexi Road, Nanshan, Shenzhen 518055 China

There is one 3m semi-anechoic chamber and two line conducted labs for final test. The Test Sites meet the requirements in documents ANSI C63.4 and CISPR 32/EN 55032 requirements.

1.3.2 Laboratory accreditation

The test facility is recognized, certified, or accredited by the following organizations:

CNAS-Lab Code: L7497

Shenzhen CTL Testing Technology Co., Ltd. has been assessed and proved to be in compliance with CNAS-CL01 Accreditation Criteria for Testing and Calibration Laboratories (identical to ISO/IEC 17025: 2005 General Requirements) for the Competence of Testing and Calibration Laboratories.

A2LA-Lab Cert. No. 4343.01

Shenzhen CTL Testing Technology Co., Ltd, EMC Laboratory has been accredited by A2LA for technical competence in the field of electrical testing, and proved to be in compliance with ISO/IEC 17025: 2005 General Requirements for the Competence of Testing and Calibration Laboratories and any additional program requirements in the identified field of testing.

IC Registration No.: 9518B

CAB identifier: CN0041

The 3m alternate test site of Shenzhen CTL Testing Technology Co., Ltd. EMC Laboratory has been registered by Innovation, Science and Economic Development Canada to test to Canadian radio equipment requirements with Registration No.: 9518B on Jan. 22, 2019.

FCC-Registration No.: 399832

Designation No.: CN1216

Shenzhen CTL Testing Technology Co., Ltd. EMC Laboratory has been registered and fully described in a report filed with the (FCC) Federal Communications Commission. The acceptance letter from the FCC is maintained in our files. Registration 399832, December 08, 2017.

1.4. Statement of the measurement uncertainty

The data and results referenced in this document are true and accurate. The reader is cautioned that there may be errors within the calibration limits of the equipment and facilities. The measurement uncertainty was calculated for all measurements listed in this test report acc. to CISPR 16 - 4 "Specification for radio disturbance and immunity measuring apparatus and methods – Part 4: Uncertainty in EMC Measurements" and is documented in the Shenzhen CTL Testing Technology Co., Ltd. quality system acc. to DIN EN ISO/IEC 17025. Furthermore, component and process variability of devices similar to that tested may result in additional deviation. The manufacturer has the sole responsibility of continued compliance of the device.

Hereafter the best measurement capability for CTL laboratory is reported:

Test	Measurement Uncertainty	Notes
Transmitter power conducted	±0.57 dB	(1)
Transmitter power Radiated	±2.20 dB	(1)
Conducted spurious emission 9KHz-40 GHz	±2.20 dB	(1)
Occupied Bandwidth	±0.01ppm	(1)
Radiated Emission 30~1000MHz	±4.10dB	(1)
Radiated Emission Above 1GHz	±4.32dB	(1)

Conducted Disturbance0.15~30MHz	$\pm 3.20\text{dB}$	(1)
---------------------------------	---------------------	-----

(1) This uncertainty represents an expanded uncertainty expressed at approximately the 95% confidence level using a coverage factor of $k=2$.

2. GENERAL INFORMATION

2.1. Environmental conditions

During the measurement the environmental conditions were within the listed ranges:

Normal Temperature:	25°C
Relative Humidity:	55 %
Air Pressure:	101 kPa

2.2. General Description of EUT

Product Name:	IPX7 Outdoor Speaker
Model/Type reference:	HPS-022
Power supply:	DC 3.7V from battery
Bluetooth :	
Supported type:	Bluetooth BR/EDR
Modulation:	GFSK, $\pi/4$ DQPSK, 8DPSK
Operation frequency:	2402MHz~2480MHz
Channel number:	79
Channel separation:	1MHz
Antenna type:	PCB antenna
Antenna gain:	0dBi

Note: For more details, please refer to the user's manual of the EUT.

2.3. Description of Test Modes and Test Frequency

The Applicant provides communication tools software to control the EUT for staying in continuous transmitting (Duty Cycle more than 98%) and receiving mode for testing .There are 79 channels provided to the EUT and Channel 00/39/78 were selected to test.

Operation Frequency :

Channel	Frequency (MHz)
00	2402
01	2403
:	:
38	2440
39	2441
40	2442
:	:
77	2479
78	2480

Preliminary tests were performed in each mode and packet length of BT, and found worst case as below, finally test were conducted at those mode and recorded in this report.

Test Items	Worst case
Conducted Emissions	DH5 Middle channel
Radiated Emissions and Band Edge	DH5
Maximum Conducted Output Power	DH5/2DH5/3DH5
20dB Bandwidth	DH5/2DH5/3DH5
Frequency Separation	DH5/2DH5/3DH5 Middle channel
Number of hopping frequency	DH5/2DH5/3DH5
Time of Occupancy (Dwell Time)	DH1/DH3/DH5 Middle channel 2DH1/2DH3/2DH5 Middle channel 3DH1/3DH3/3DH5 Middle channel
Out-of-band Emissions	DH5/2DH5/3DH5

2.4. Equipments Used during the Test

Test Equipment	Manufacturer	Model No.	Serial No.	Calibration Date	Calibration Due Date
LISN	R&S	ENV216	3560.6550.1 2	2019/05/24	2020/05/23
LISN	R&S	ESH2-Z5	860014/010	2019/05/24	2020/05/23
Bilog Antenna	Sunol Sciences Corp.	JB1	A061713	2019/05/24	2020/05/23
EMI Test Receiver	R&S	ESCI	1166.5950.03	2019/05/24	2020/05/23
Spectrum Analyzer	Agilent	E4407B	MY41440676	2019/05/24	2020/05/23
Spectrum Analyzer	Agilent	N9020	US46220290	2019/05/24	2020/05/23
Controller	EM Electronics	EM 1000	060859	2019/05/24	2020/05/23
Horn Antenna	Sunol Sciences Corp.	DRH-118	A062013	2019/05/24	2020/05/23
Active Loop Antenna	Da Ze	ZN30900A	/	2019/05/24	2020/05/23
Amplifier	Agilent	8449B	3008A02306	2019/05/24	2020/05/23
Amplifier	Agilent	8447D	2944A10176	2019/05/24	2020/05/23
Temperature/Humidity Meter	Gangxing	CTH-608	02	2019/05/24	2020/05/23
High-Pass Filter	micro-tranics	HPM50108	G174	2019/05/24	2020/05/23
High-Pass Filter	micro-tranics	HPM50111	G142	2019/05/24	2020/05/23
Coaxial Cables	HUBER+SUHNER	SUCOFLEX 104PEA-10M	10m	2019/05/24	2020/05/23
Coaxial Cables	HUBER+SUHNER	SUCOFLEX 104PEA-3M	3m	2019/05/24	2020/05/23
Coaxial Cables	HUBER+SUHNER	SUCOFLEX 104PEA-3M	3m	2019/05/24	2020/05/23
RF Cable	Megalon	RF-A303	N/A	2019/05/24	2020/05/23
Power Sensor	Agilent	U2021XA	MY5365004	2019/05/23	2020/05/23

Power Meter	Agilent	U2531A	TW53323507	2019/05/24	2020/05/23
-------------	---------	--------	------------	------------	------------

The calibration interval was one year

2.5. Related Submittal(s) / Grant (s)

This submittal(s) (test report) is intended to comply with Section 15.247 of the FCC Part 15, Subpart C Rules.

2.6. Modifications

No modifications were implemented to meet testing criteria.

3. TEST CONDITIONS AND RESULTS

3.1. Conducted Emissions Test

LIMIT

FCC CFR Title 47 Part 15 Subpart C Section 15.207

Frequency range (MHz)	Limit (dBuV)	
	Quasi-peak	Average
0.15-0.5	66 to 56*	56 to 46*
0.5-5	56	46
5-30	60	50

* Decreases with the logarithm of the frequency.

TEST CONFIGURATION



TEST PROCEDURE

1. The equipment was set up as per the test configuration to simulate typical actual usage per the user's manual. The EUT is a tabletop system; a wooden table with a height of 0.8 meters is used and is placed on the ground plane as per ANSI C63.10:2013.
2. Support equipment, if needed, was placed as per ANSI C63.10:2013.
3. All I/O cables were positioned to simulate typical actual usage as per ANSI C63.10:2013.
4. The adapter received AC120V/60Hz power through a Line Impedance Stabilization Network (LISN) which supplied power source and was grounded to the ground plane.
5. All support equipments received AC power from a second LISN, if any.
6. The EUT test program was started. Emissions were measured on each current carrying line of the EUT using a spectrum Analyzer / Receiver connected to the LISN powering the EUT. The LISN has two monitoring points: Line 1 (Hot Side) and Line 2 (Neutral Side). Two scans were taken: one with Line 1 connected to Analyzer / Receiver and Line 2 connected to a 50 ohm load; the second scan had Line 1 connected to a 50 ohm load and Line 2 connected to the Analyzer / Receiver.
7. Analyzer / Receiver scanned from 150 KHz to 30MHz for emissions in each of the test modes.
8. During the above scans, the emissions were maximized by cable manipulation.

TEST RESULTS

Remark: All modes of GFSK, Pi/4 DQPSK, and 8DPSK were test at Low, Middle, and High channel; only the worst result of GFSK Middle Channel was reported as below:

SCAN TABLE: "Voltage (9K-30M) FIN"

Short Description: 150K-30M Voltage

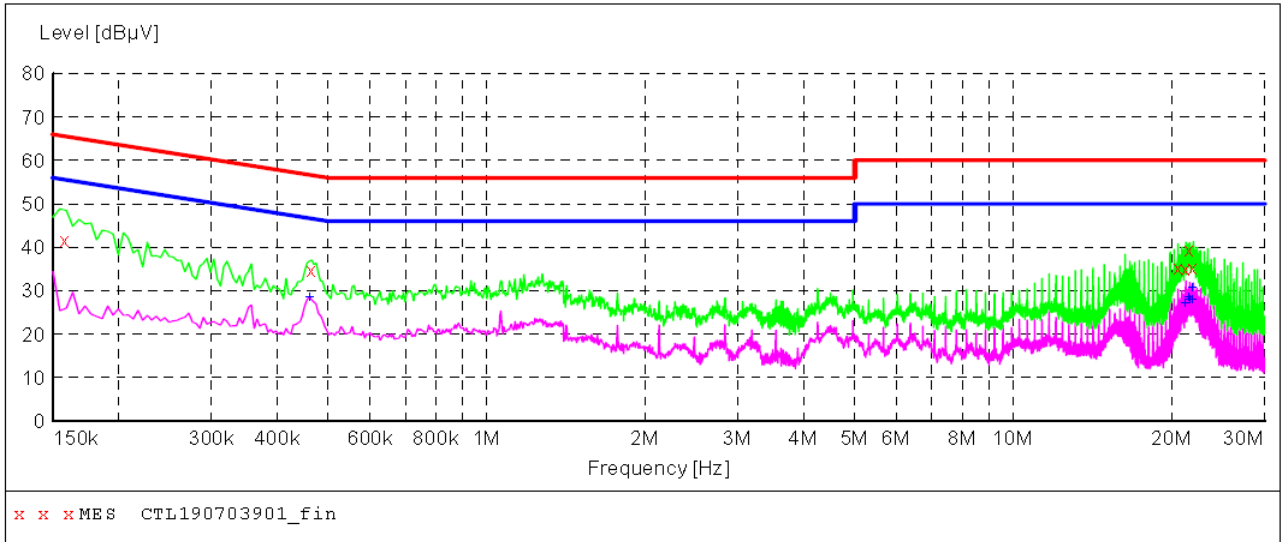

MEASUREMENT RESULT: "CTL190703901_fin"

2019-7-3 06:29??

Frequency MHz	Level dBµV	Transd dB	Limit dBµV	Margin dB	Detector	Line	PE
0.158000	41.80	11.2	66	23.8	QP	L1	GND
0.466000	34.70	11.2	57	21.9	QP	L1	GND
20.588000	35.30	11.5	60	24.7	QP	L1	GND
21.308000	35.00	11.5	60	25.0	QP	L1	GND
21.644000	39.50	11.5	60	20.5	QP	L1	GND
21.992000	35.30	11.5	60	24.7	QP	L1	GND

MEASUREMENT RESULT: "CTL190703901_fin2"

2019-7-3 06:29??

Frequency MHz	Level dBµV	Transd dB	Limit dBµV	Margin dB	Detector	Line	PE
0.462000	28.50	11.2	47	18.2	AV	L1	GND
21.284000	27.10	11.5	50	22.9	AV	L1	GND
21.644000	28.50	11.5	50	21.5	AV	L1	GND
21.716000	28.00	11.5	50	22.0	AV	L1	GND
21.932000	27.80	11.5	50	22.2	AV	L1	GND
22.004000	30.70	11.5	50	19.3	AV	L1	GND

SCAN TABLE: "Voltage (9K-30M) FIN"
 Short Description: 150K-30M Voltage

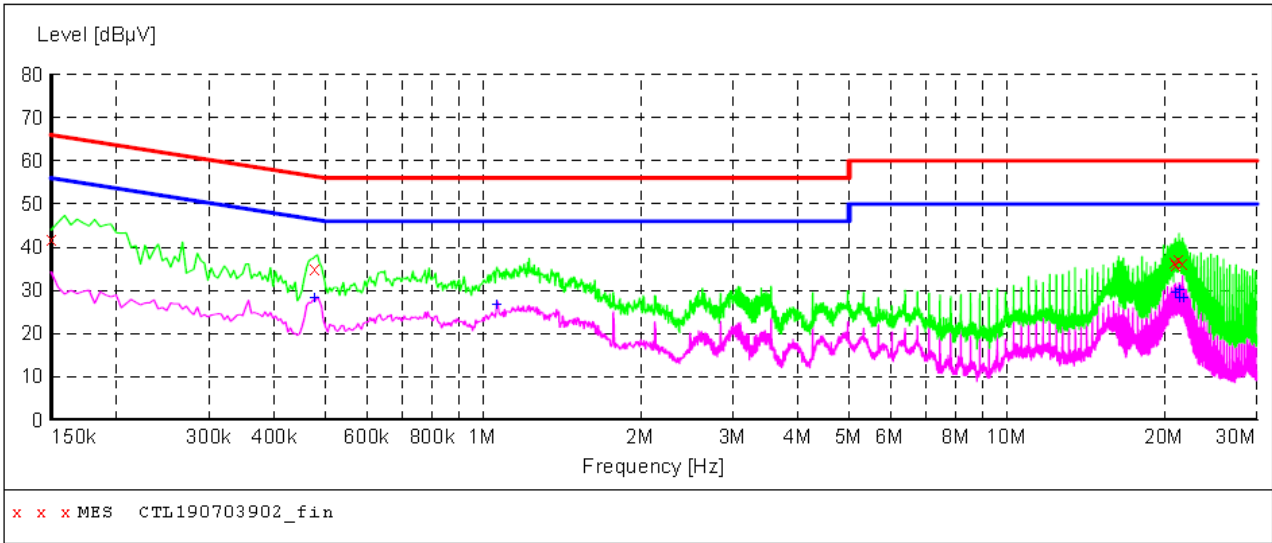

MEASUREMENT RESULT: "CTL190703902_fin"

2019-7-3 06:32??

Frequency MHz	Level dBµV	Transd dB	Limit dBµV	Margin dB	Detector	Line	PE
0.150000	41.80	11.2	66	24.2	QP	N	GND
0.478000	35.10	11.2	56	21.3	QP	N	GND
20.972000	36.80	11.5	60	23.2	QP	N	GND
20.984000	36.00	11.5	60	24.0	QP	N	GND
21.326000	37.20	11.5	60	22.8	QP	N	GND
21.680000	36.30	11.5	60	23.7	QP	N	GND

MEASUREMENT RESULT: "CTL190703902_fin2"

2019-7-3 06:32??

Frequency MHz	Level dBµV	Transd dB	Limit dBµV	Margin dB	Detector	Line	PE
0.478000	28.10	11.2	46	18.3	AV	N	GND
1.064000	26.60	11.3	46	19.4	AV	N	GND
20.972000	29.60	11.5	50	20.4	AV	N	GND
21.326000	30.20	11.5	50	19.8	AV	N	GND
21.422000	28.10	11.5	50	21.9	AV	N	GND
21.716000	28.20	11.5	50	21.8	AV	N	GND

3.2. Radiated Emissions and Band Edge

Limit

For intentional device, according to § 15.209(a), the general requirement of field strength of radiated emission out of authorized band shall not exceed the following table at a 3 meters measurement distance.

In addition, radiated emissions which fall in the restricted bands, as defined in §15.205(a), must also comply with the radiated emission limits specified in §15.209(a)

Radiated emission limits

Frequency (MHz)	Distance (Meters)	Radiated (dBµV/m)	Radiated (µV/m)
0.009-0.49	3	$20\log(2400/F(\text{KHz}))+40\log(300/3)$	$2400/F(\text{KHz})$
0.49-1.705	3	$20\log(24000/F(\text{KHz}))+ 40\log(30/3)$	$24000/F(\text{KHz})$
1.705-30	3	$20\log(30)+ 40\log(30/3)$	30
30-88	3	40.0	100
88-216	3	43.5	150
216-960	3	46.0	200
Above 960	3	54.0	500

TEST CONFIGURATION

(A) Radiated Emission Test Set-Up, Frequency Below 30MHz

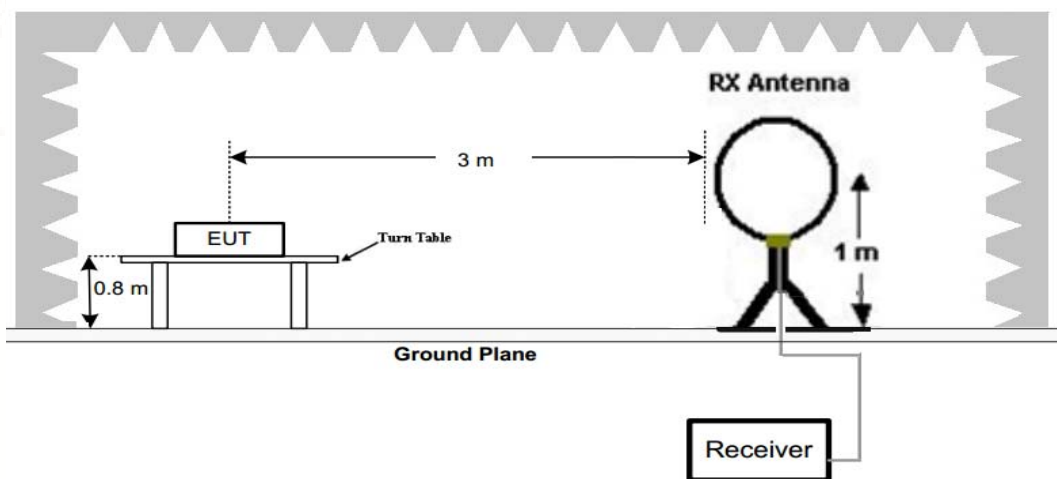

(B) Radiated Emission Test Set-Up, Frequency below 1000MHz

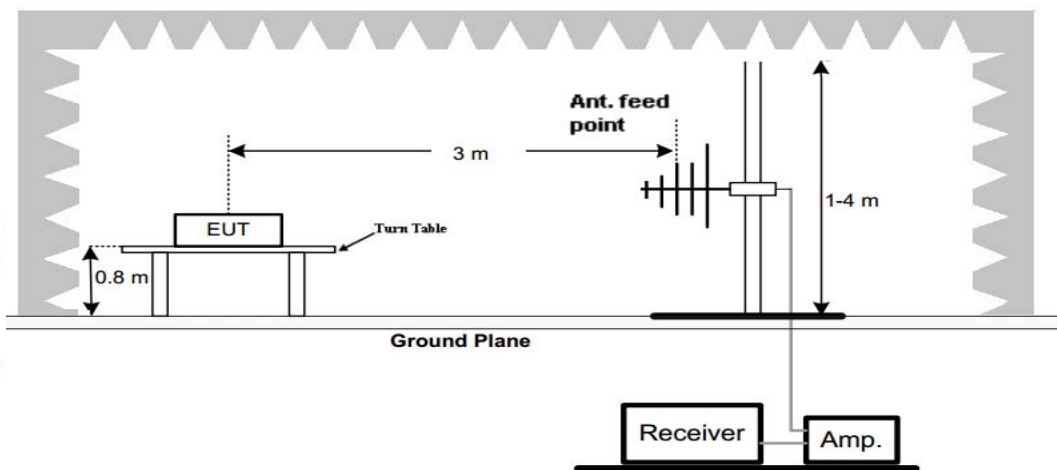

(C) Radiated Emission Test Set-Up, Frequency above 1000MHz

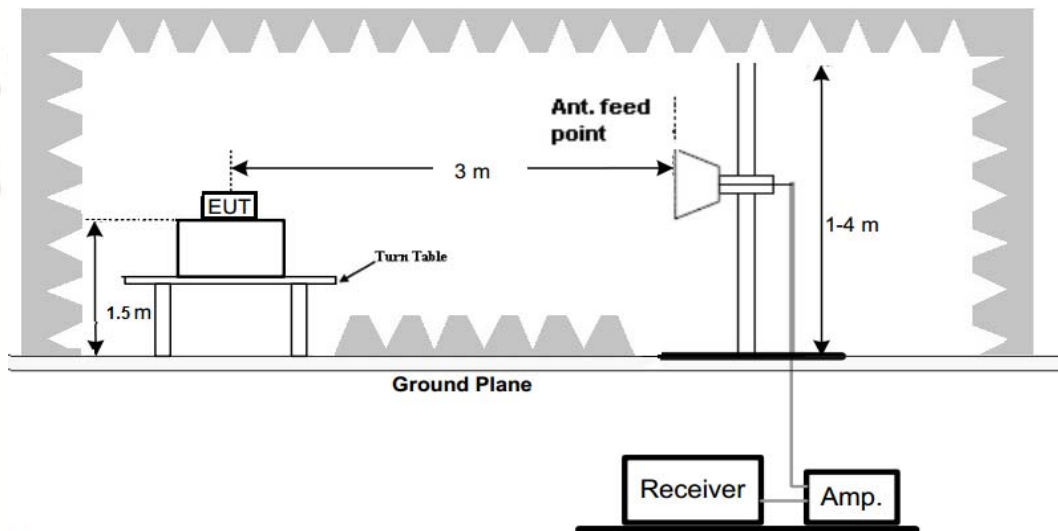

Test Procedure

1. Below 1GHz measurement the EUT is placed on a turntable which is 0.8m above ground plane, and above 1GHz measurement EUT was placed on a low permittivity and low loss tangent turn table which is 1.5m above ground plane.
2. Maximum procedure was performed by raising the receiving antenna from 1m to 4m and rotating the turn table from 0° to 360° to acquire the highest emissions from EUT
3. And also, each emission was to be maximized by changing the polarization of receiving antenna both horizontal and vertical.
4. Repeat above procedures until all frequency measurements have been completed.

TEST RESULTS

Remark:

1. We measured Radiated Emission at GFSK, $\pi/4$ DQPSK and 8DPSK mode from 9 KHz to 25GHz and recorded worst case at GFSK DH5 mode.
2. For below 1GHz testing recorded worst at GFSK DH5 low channel.
3. Radiated emission test from 9 KHz to 10th harmonic of fundamental was verified, and no emission found except system noise floor in 9 KHz to 30MHz and not recorded in this report.

For 30MHz-1GHz

Horizontal

SWEEP TABLE: "test (30M-1G)"

Short Description:		Field Strength				Transducer
Start	Stop	Detector	Meas.	IF		
Frequency	Frequency	Time	Bandw.			
30.0 MHz	1.0 GHz	MaxPeak	300.0 ms	120 kHz	JB1	

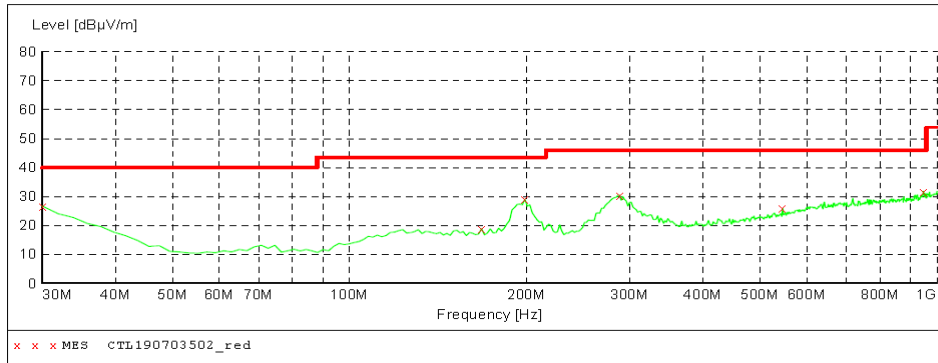

MEASUREMENT RESULT: "CTL190703502_red"

03/07/2019 12:41

Frequency	Level	Transd	Limit	Margin	Det.	Height	Azimuth	Polarization
MHz	dBuV/m	dB	dBuV/m	dB		cm	deg	
30.000000	26.70	22.2	40.0	13.3	---	0.0	0.00	HORIZONTAL
167.740000	18.90	14.5	43.5	24.6	---	0.0	0.00	HORIZONTAL
198.780000	29.10	14.7	43.5	14.4	---	0.0	0.00	HORIZONTAL
288.020000	30.50	15.7	46.0	15.5	---	0.0	0.00	HORIZONTAL
546.040000	25.90	21.8	46.0	20.1	---	0.0	0.00	HORIZONTAL
947.620000	31.80	27.3	46.0	14.2	---	0.0	0.00	HORIZONTAL

Vertical

SWEEP TABLE: "test (30M-1G)"

Short Description:		Field Strength				Transducer
Start	Stop	Detector	Meas.	IF		
Frequency	Frequency	Time	Bandw.			
30.0 MHz	1.0 GHz	MaxPeak	300.0 ms	120 kHz	JB1	

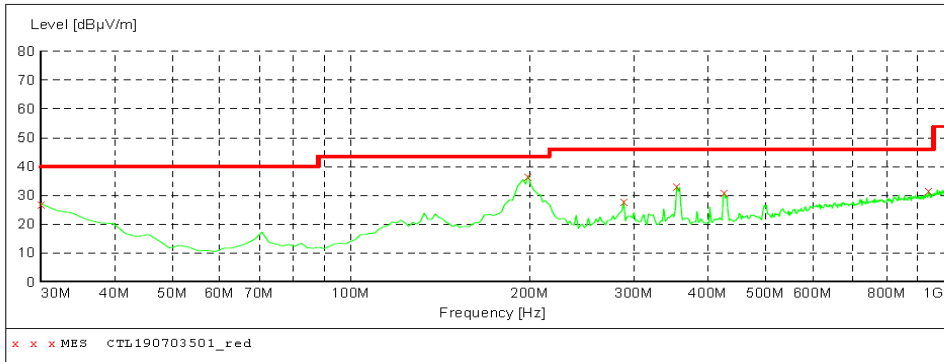

MEASUREMENT RESULT: "CTL190703501_red"

03/07/2019 12:39

Frequency	Level	Transd	Limit	Margin	Det.	Height	Azimuth	Polarization
MHz	dBuV/m	dB	dBuV/m	dB		cm	deg	
30.000000	27.00	22.2	40.0	13.0	---	0.0	0.00	VERTICAL
198.780000	36.80	14.7	43.5	6.7	---	0.0	0.00	VERTICAL
288.020000	28.00	15.7	46.0	18.0	---	0.0	0.00	VERTICAL
353.980000	33.20	17.4	46.0	12.8	---	0.0	0.00	VERTICAL
425.760000	31.00	18.9	46.0	15.0	---	0.0	0.00	VERTICAL
939.860000	31.60	27.1	46.0	14.4	---	0.0	0.00	VERTICAL

For 1GHz to 25GHz

Note: GFSK, Pi/4 DQPSK and 8DPSK all have been tested, only worse case GFSK is reported.

GFSK (above 1GHz)

Frequency(MHz):			2402		Polarity:			HORIZONTAL	
Frequency (MHz)	Emission Level (dBuV/m)		Limit (dBuV/m)	Margin (dB)	Raw Value (dBuV)	Antenna Factor (dB/m)	Cable Factor (dB)	Pre-amplifier (dB)	Correction Factor (dB/m)
4804.00	56.49	PK	74	17.51	51.98	33.49	6.91	35.89	4.51
4804.00	51.16	AV	54	2.84	46.65	33.49	6.91	35.89	4.51
5039.75	43.04	PK	74	30.96	36.18	34.06	7.04	34.24	6.86
5039.75	--	AV	54	--	--	--	--	--	--
7206.00	47.45	PK	74	26.55	36.35	36.95	9.18	35.03	11.10
7206.00	--	AV	54	--	--	--	--	--	--

Frequency(MHz):			2402		Polarity:			VERTICAL	
Frequency (MHz)	Emission Level (dBuV/m)		Limit (dBuV/m)	Margin (dB)	Raw Value (dBuV)	Antenna Factor (dB/m)	Cable Factor (dB)	Pre-amplifier (dB)	Correction Factor (dB/m)
4804.00	56.18	PK	74	17.82	51.67	33.49	6.91	35.89	4.51
4804.00	50.61	AV	54	3.39	46.10	33.49	6.91	35.89	4.51
5039.75	43.87	PK	74	30.13	37.01	34.06	7.04	34.24	6.86
5039.75	--	AV	54	--	--	--	--	--	--
7206.00	46.84	PK	74	27.16	35.74	36.95	9.18	35.03	11.10
7206.00	--	AV	54	--	--	--	--	--	--

Frequency(MHz):			2441		Polarity:			HORIZONTAL	
Frequency (MHz)	Emission Level (dBuV/m)		Limit (dBuV/m)	Margin (dB)	Raw Value (dBuV)	Antenna Factor (dB/m)	Cable Factor (dB)	Pre-amplifier (dB)	Correction Factor (dB/m)
4882.00	56.29	PK	74	17.71	49.93	33.60	6.95	34.19	6.36
4882.00	51.07	AV	54	2.93	44.71	33.60	6.95	34.19	6.36
5145.05	43.52	PK	74	30.48	35.92	34.56	7.15	34.11	7.60
5145.05	--	AV	54	--	--	--	--	--	--
7323.00	47.05	PK	74	26.95	35.35	37.46	9.23	35.00	11.70
7323.00	--	AV	54	--	--	--	--	--	--

Frequency(MHz):			2441		Polarity:			VERTICAL	
Frequency (MHz)	Emission Level (dBuV/m)		Limit (dBuV/m)	Margin (dB)	Raw Value (dBuV)	Antenna Factor (dB/m)	Cable Factor (dB)	Pre-amplifier (dB)	Correction Factor (dB/m)
4882.00	57.05	PK	74	16.95	50.69	33.60	6.95	34.19	6.36
4882.00	50.34	AV	54	3.66	43.98	33.60	6.95	34.19	6.36
5145.05	43.09	PK	74	30.91	35.49	34.56	7.15	34.11	7.60
5145.05	--	AV	54	--	--	--	--	--	--
7323.00	46.98	PK	74	27.02	35.28	37.46	9.23	35.00	11.70
7323.00	--	AV	54	--	--	--	--	--	--

Frequency(MHz):			2480		Polarity:			HORIZONTAL	
Frequency (MHz)	Emission Level (dBuV/m)		Limit (dBuV/m)	Margin (dB)	Raw Value (dBuV)	Antenna Factor (dB/m)	Cable Factor (dB)	Pre- amplifier (dB)	Correction Factor (dB/m)
4960.00	56.16	PK	74	17.84	51.24	33.84	7.00	35.92	4.92
4960.00	51.71	AV	54	2.29	46.79	33.84	7.00	35.92	4.92
5225.75	43.06	PK	74	30.94	35.78	34.45	7.12	34.29	7.28
5225.75	--	AV	54	--	--	--	--	--	--
7440.00	47.28	PK	74	26.72	35.33	37.64	9.28	34.97	11.95
7440.00	--	AV	54	--	--	--	--	--	--

Frequency(MHz):			2480		Polarity:			VERTICAL	
Frequency (MHz)	Emission Level (dBuV/m)		Limit (dBuV/m)	Margin (dB)	Raw Value (dBuV)	Antenna Factor (dB/m)	Cable Factor (dB)	Pre- amplifier (dB)	Correction Factor (dB/m)
4960.00	57.27	PK	74	16.73	52.35	33.84	7.00	35.92	4.92
4960.00	50.82	AV	54	3.18	45.90	33.84	7.00	35.92	4.92
5225.75	43.38	PK	74	30.62	36.1	34.45	7.12	34.29	7.28
5225.75	--	AV	54	--	--	--	--	--	--
7440.00	46.91	PK	74	27.09	34.96	37.64	9.28	34.97	11.95
7440.00	--	AV	54	--	--	--	--	--	--

REMARKS:

1. Emission level (dBuV/m) =Raw Value (dBuV)+Correction Factor (dB/m)
2. Correction Factor (dB/m) = Antenna Factor (dB/m)+Cable Factor (dB)-Pre-amplifier Factor
3. Margin value = Limit value- Emission level.
4. -- Mean the PK detector measured value is below average limit.
5. The other emission levels were very low against the limit.
6. RBW1MHz VBW3MHz Peak detector is for PK value; RBW 1MHz VBW10Hz Peak detector is for AV value.

Results of Band Edges Test (Radiated)

Note: GFSK, Pi/4 DQPSK and 8DPSK all have been tested, only worse case GFSK is reported.

Frequency(MHz):			2402		Polarity:			HORIZONTAL	
Frequency (MHz)	Emission Level (dBuV/m)		Limit (dBuV/m)	Margin (dB)	Raw Value (dBuV)	Antenna Factor (dB/m)	Cable Factor (dB)	Pre-amplifier (dB)	Correction Factor (dB/m)
2402.00	99.42	PK	--	--	66.03	28.78	4.61	0	33.39
2402.00	93.05	AV	--	--	59.66	28.78	4.61	0	33.39
2341.15	43.47	PK	74	30.53	10.39	28.52	4.56	0	33.08
2341.15	--	AV	54	--	--	--	--	--	--
2390.00	49.28	PK	74	24.72	15.96	28.72	4.60	0	33.32
2390.00	--	AV	54	--	--	--	--	--	--
2400.00	50.03	PK	74	23.97	16.64	28.78	4.61	0	33.39
2400.00	--	AV	54	--	--	--	--	--	--

Frequency(MHz):			2402		Polarity:			VERTICAL	
Frequency (MHz)	Emission Level (dBuV/m)		Limit (dBuV/m)	Margin (dB)	Raw Value (dBuV)	Antenna Factor (dB/m)	Cable Factor (dB)	Pre-amplifier (dB)	Correction Factor (dB/m)
2402.00	98.75	PK	--	--	65.36	28.78	4.61	0	33.39
2402.00	91.22	AV	--	--	57.83	28.78	4.61	0	33.39
2341.15	43.24	PK	74	30.76	10.16	28.52	4.56	0	33.08
2341.15	--	AV	54	--	--	--	--	--	--
2390.00	48.67	PK	74	25.33	15.35	28.72	4.60	0	33.32
2390.00	--	AV	54	--	--	--	--	--	--
2400.00	49.93	PK	74	24.07	16.54	28.78	4.61	0	33.39
2400.00	--	AV	54	--	--	--	--	--	--

Frequency(MHz):			2480		Polarity:			HORIZONTAL	
Frequency (MHz)	Emission Level (dBuV/m)		Limit (dBuV/m)	Margin (dB)	Raw Value (dBuV)	Antenna Factor (dB/m)	Cable Factor (dB)	Pre-amplifier (dB)	Correction Factor (dB/m)
2480.00	100.08	PK	--	--	66.46	28.92	4.70	0.00	33.62
2480.00	93.25	AV	--	--	59.63	28.92	4.70	0.00	33.62
2483.50	43.17	PK	74	30.83	9.54	28.93	4.70	0.00	33.63
2483.50	--	AV	54	--	--	--	--	--	--
2490.75	43.96	PK	74	30.04	10.3	28.95	4.71	0.00	33.66
2490.75	--	AV	54	--	--	--	--	--	--
2500.00	42.87	PK	74	31.13	9.19	28.96	4.72	0.00	33.68
2500.00	--	AV	54	--	--	--	--	--	--

Frequency(MHz):			2480		Polarity:			VERTICAL	
Frequency (MHz)	Emission Level (dBuV/m)		Limit (dBuV/m)	Margin (dB)	Raw Value (dBuV)	Antenna Factor (dB/m)	Cable Factor (dB)	Pre-amplifier (dB)	Correction Factor (dB/m)
2480.00	99.71	PK	--	--	66.09	28.92	4.70	0.00	33.62
2480.00	91.06	AV	--	--	57.44	28.92	4.70	0.00	33.62
2483.50	43.15	PK	74	30.85	9.52	28.93	4.70	0.00	33.63
2483.50	--	AV	54	--	--	--	--	--	--
2490.75	43.01	PK	74	30.99	9.35	28.95	4.71	0.00	33.66
2490.75	--	AV	54	--	--	--	--	--	--
2500.00	42.94	PK	74	31.06	9.26	28.96	4.72	0.00	33.68
2500.00	--	AV	54	--	--	--	--	--	--

REMARKS:

1. Emission level (dBuV/m) =Raw Value (dBuV)+Correction Factor (dB/m)
2. Correction Factor (dB/m) = Antenna Factor (dB/m)+Cable Factor (dB)-Pre-amplifier Factor
3. Margin value = Limit value- Emission level.
4. -- Mean the PK detector measured value is below average limit.
5. The other emission levels were very low against the limit.
6. RBW1MHz VBW3MHz Peak detector is for PK value; RBW 1MHz VBW10Hz Peak detector is for AV value.
7. For fundamental frequency, RBW 3MHz VBW 3MHz Peak detector is for PK Value; RMS detector is for AV value.

3.3. Maximum Peak Output Power

Limit

For frequency hopping systems operating in the 2400-2483.5 MHz band employing at least 75 non-overlapping hopping channels: 1 watt.

For all other frequency hopping systems in the 2400-2483.5 MHz band: 0.125 watts.

Test Procedure

Remove the antenna from the EUT and then connect a low loss RF cable from the antenna port to the spectrum.

Test Configuration



Test Results

Type	Channel	Output power (dBm)	Limit (dBm)	Result
GFSK	00	5.745	30	Pass
	39	5.793		
	78	5.613		
$\pi/4$ DQPSK	00	6.383	20.97	Pass
	39	6.415		
	78	6.284		
8DPSK	00	6.388	20.97	Pass
	39	6.435		
	78	6.295		

Note: 1.The test results including the cable lose.

Test plot as follows:

GFSK Modulation

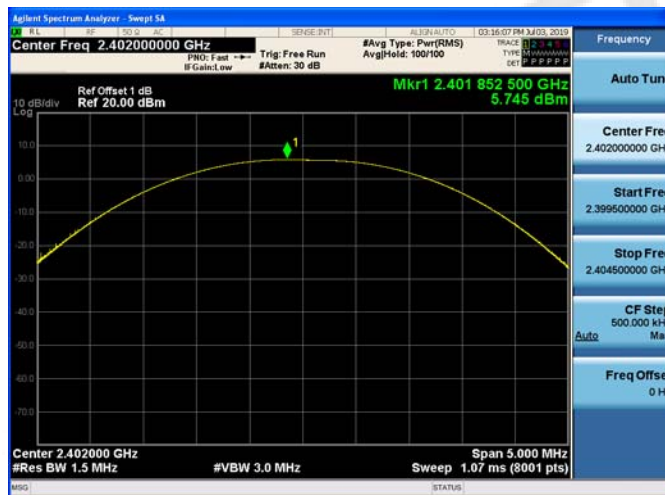

CH00

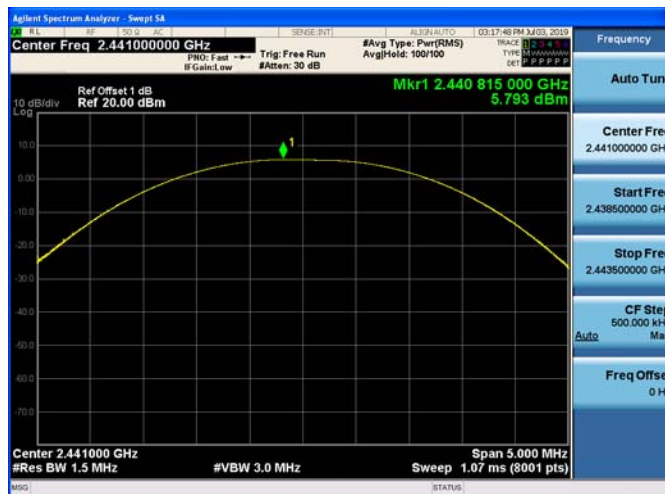

CH39

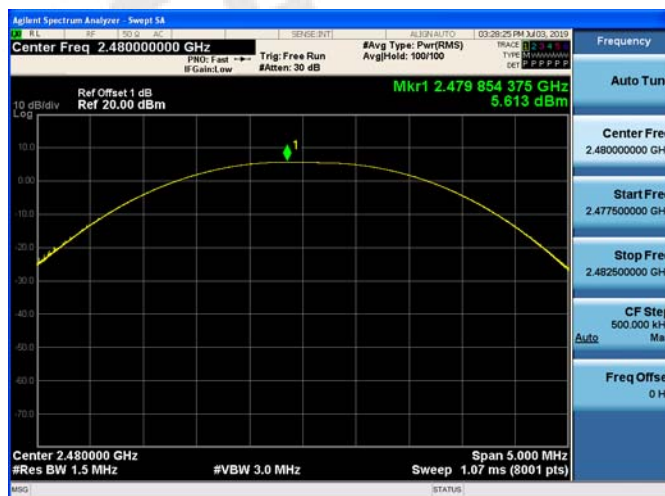

CH78

$\pi/4$ DQPSK Modulation

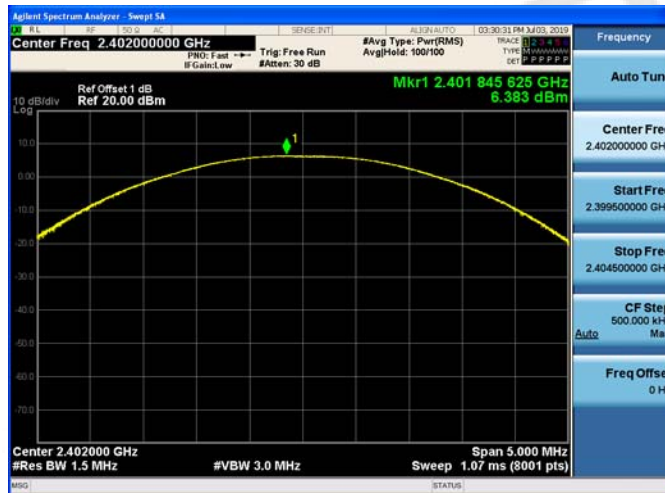

CH00

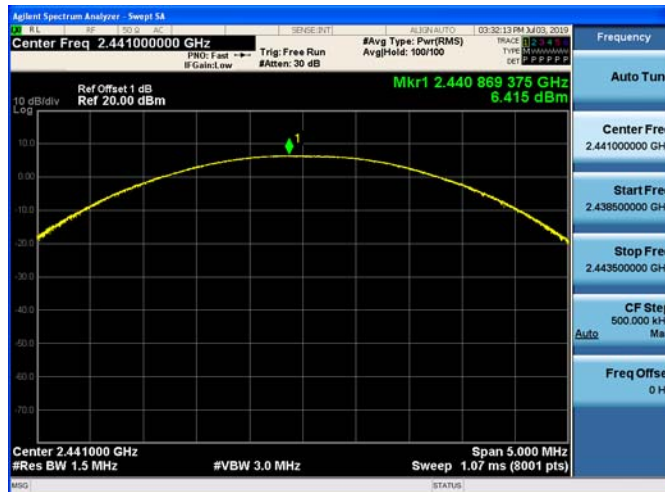

CH39

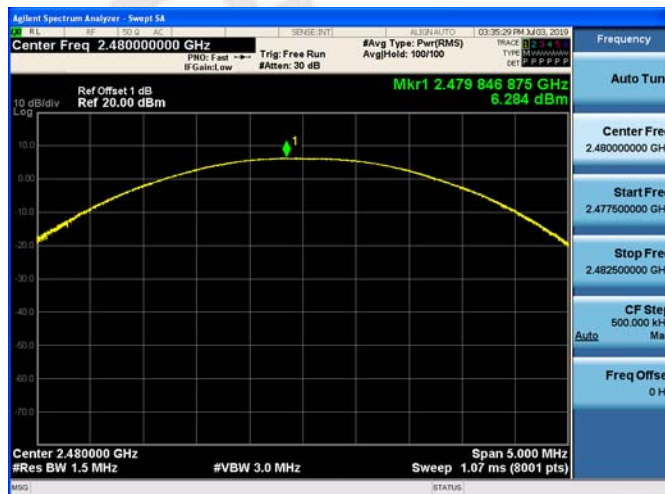

CH78

8DPSK Modulation

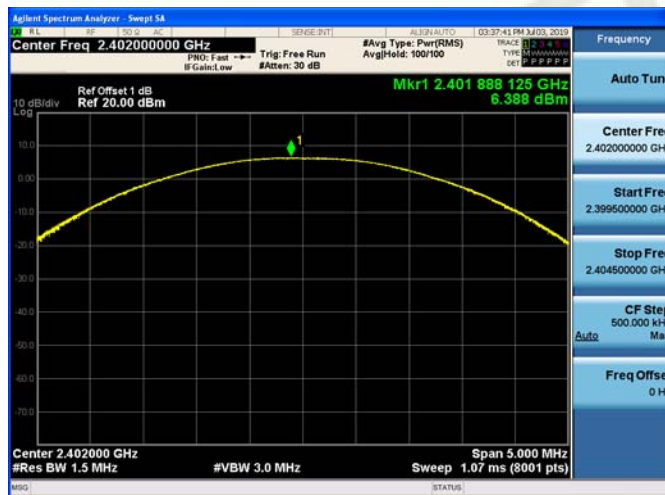

CH00

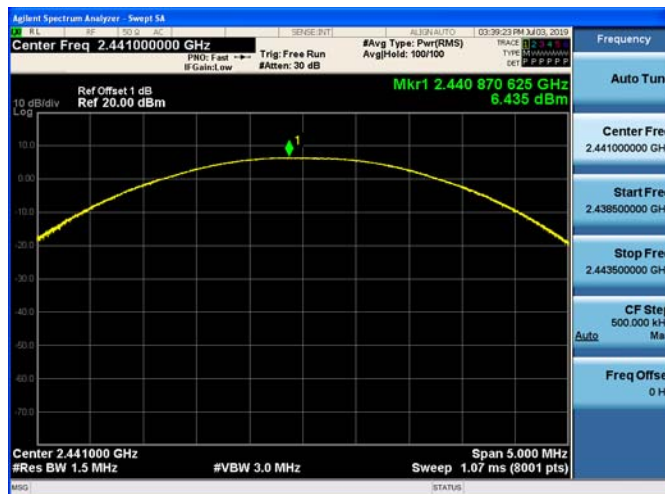

CH39

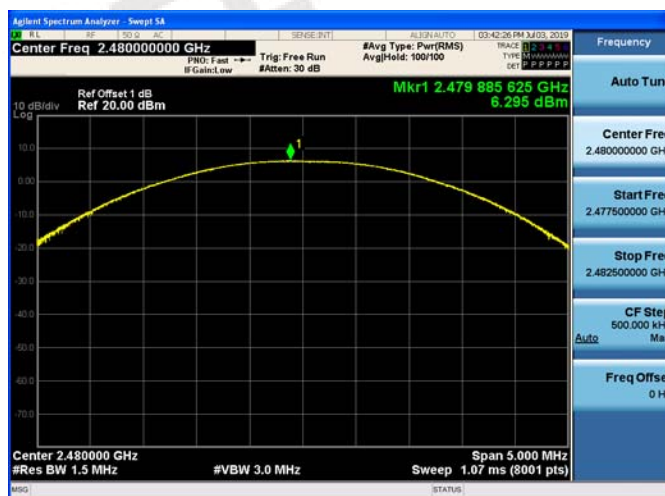

CH78

3.4. 20dB Bandwidth

Limit

For frequency hopping systems operating in the 2400MHz-2483.5MHz no limit for 20dB bandwidth.

Test Procedure

The transmitter output was connected to the spectrum analyzer through an attenuator. The bandwidth of the fundamental frequency was measured by spectrum analyzer with 30 KHz RBW and 100 KHz VBW.

The 20dB bandwidth is defined as the total spectrum the power of which is higher than peak power minus 20dB.

Test Configuration



Test Results

Modulation	Channel	20dB bandwidth (MHz)	99% OBW (MHz)	Result
GFSK	CH00	0.9532	0.84666	Pass
	CH39	0.9475	0.84838	
	CH78	0.9442	0.83836	
$\pi/4$ DQPSK	CH00	1.307	1.1892	
	CH39	1.310	1.1822	
	CH78	1.319	1.1869	
8DPSK	CH00	1.311	1.1857	
	CH39	1.321	1.1920	
	CH78	1.314	1.1866	

Test plot as follows:

GFSK Modulation

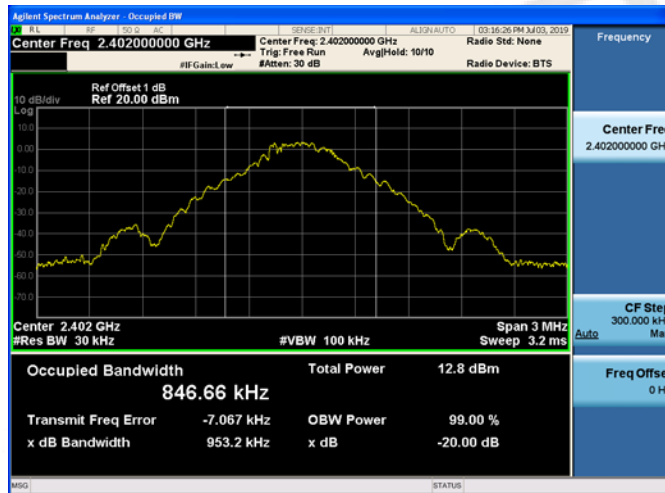

CH00



CH39

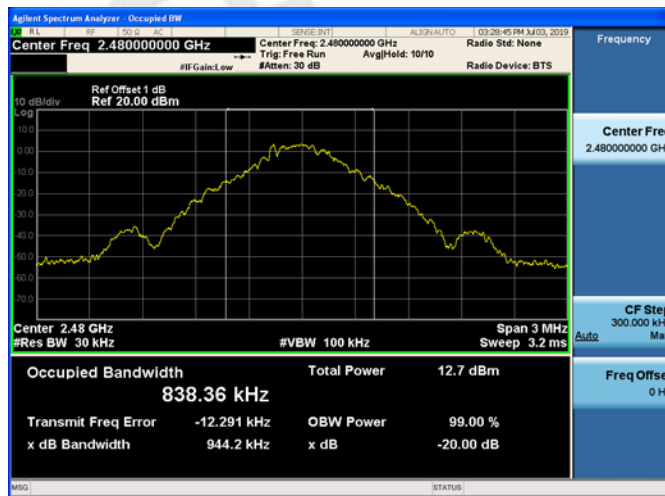

CH78

$\pi/4$ DQPSK Modulation

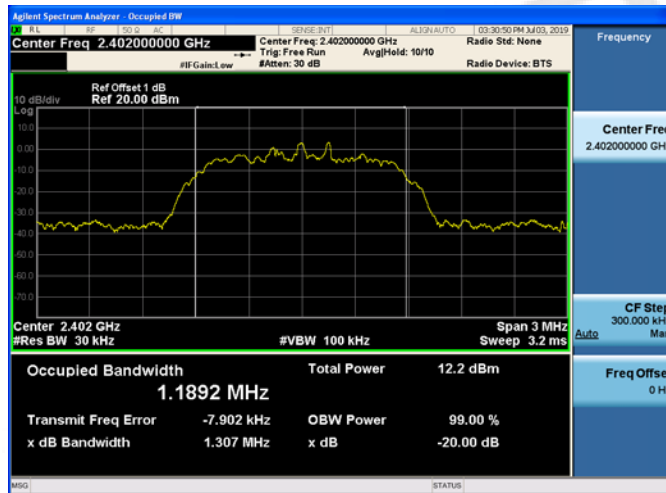

CH00

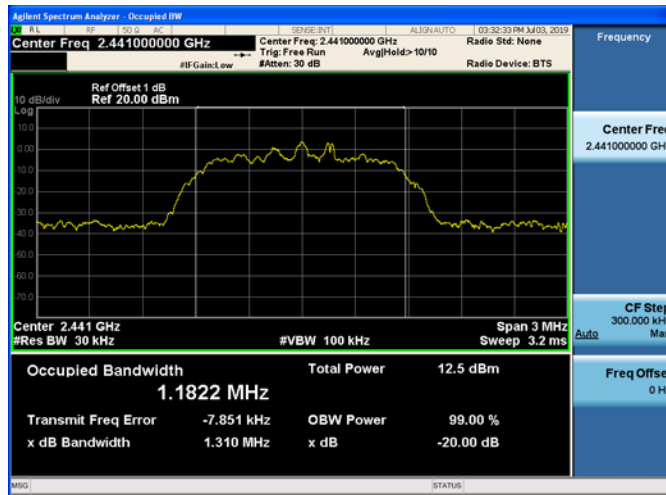

CH39

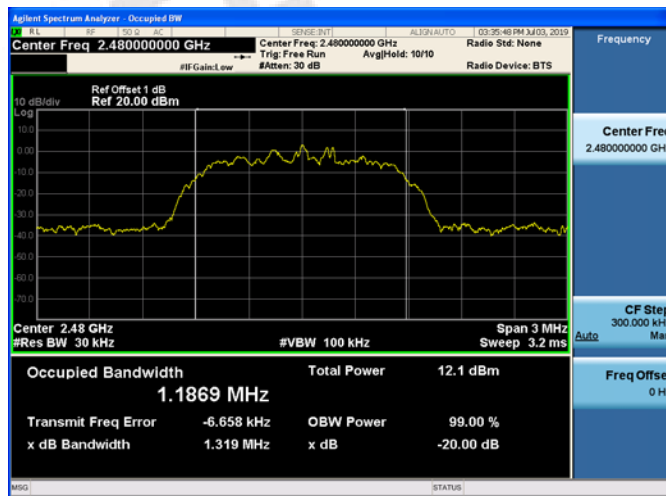

CH78

8DPSK Modulation

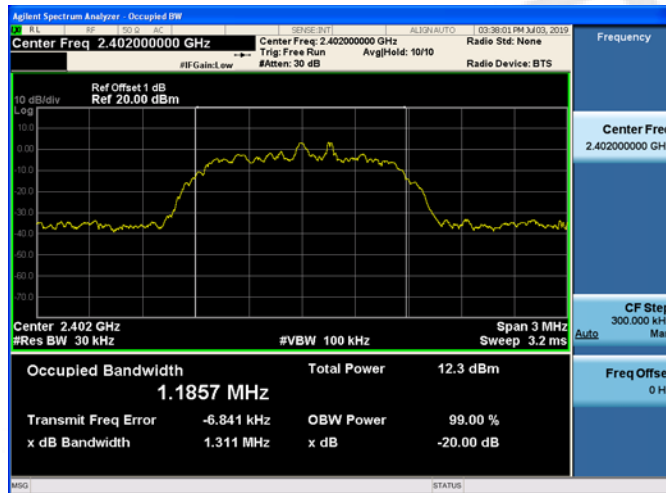

CH00

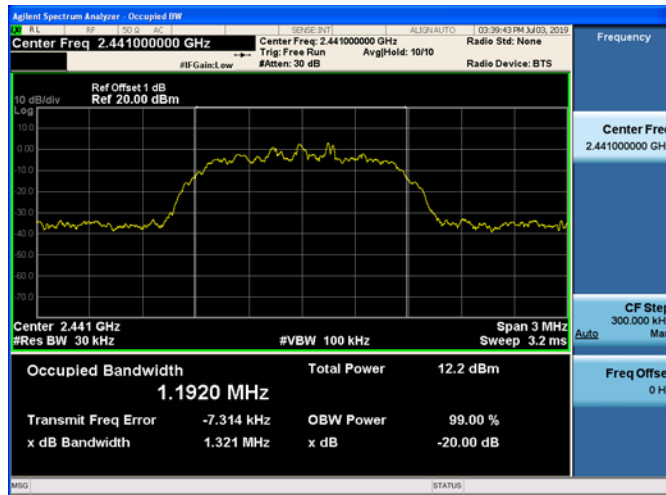

CH39

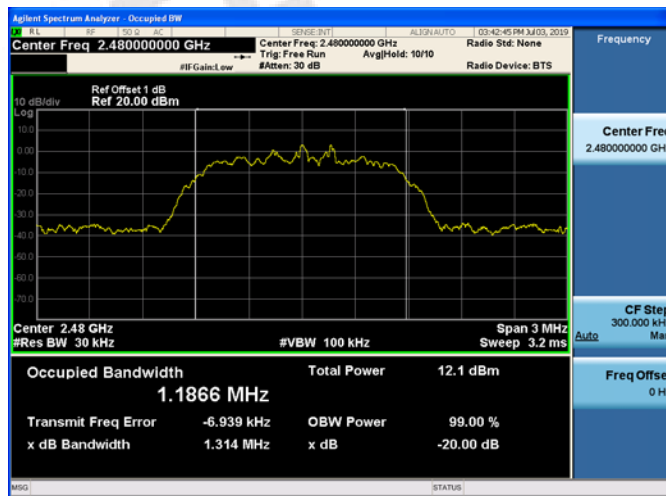

CH78

3.5. Frequency Separation

LIMIT

According to 15.247(a)(1), frequency hopping systems shall have hopping channel carrier frequencies separated by minimum of 25KHz or the $2/3 \times 20\text{dB}$ bandwidth of the hopping channel, whichever is greater.

TEST PROCEDURE

The transmitter output was connected to the spectrum analyzer through an attenuator. The bandwidth of the fundamental frequency was measured by spectrum analyzer with 100 KHz RBW and 300 KHz VBW.

TEST CONFIGURATION

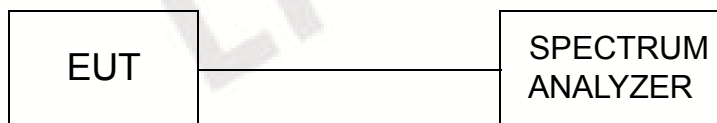

TEST RESULTS

Modulation	Channel	Channel Separation (MHz)	Limit(MHz)	Result
GFSK	CH39	0.829	25KHz or $2/3 \times 20\text{dB}$ bandwidth	Pass
	CH40			
$\pi/4$ DQPSK	CH39	1.002	25KHz or $2/3 \times 20\text{dB}$ bandwidth	Pass
	CH40			
8DPSK	CH39	0.726	25KHz or $2/3 \times 20\text{dB}$ bandwidth	Pass
	CH40			

Note:

We have tested all mode at high, middle and low channel, and recorded worst case at middle

Test plot as follows:

GFSK Modulation



$\pi/4$ DQPSK Modulation



8DPSK Modulation

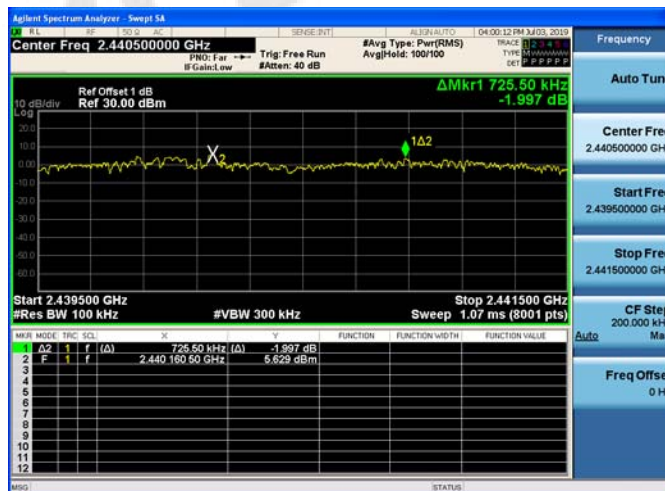

3.6. Number of hopping frequency

Limit

Frequency hopping systems in the 2400–2483.5 MHz band shall use at least 15 channels.

Test Procedure

The transmitter output was connected to the spectrum analyzer through an attenuator. Set spectrum analyzer start 2400MHz to 2483.5MHz with 100 KHz RBW and 300 KHz VBW.

Test Configuration



Test Results

Modulation	Number of Hopping Channel	Limit	Result
GFSK	79	≥15	Pass
$\pi/4$ DQPSK	79		
8DPSK	79		

Test plot as follows:

GFSK Modulation

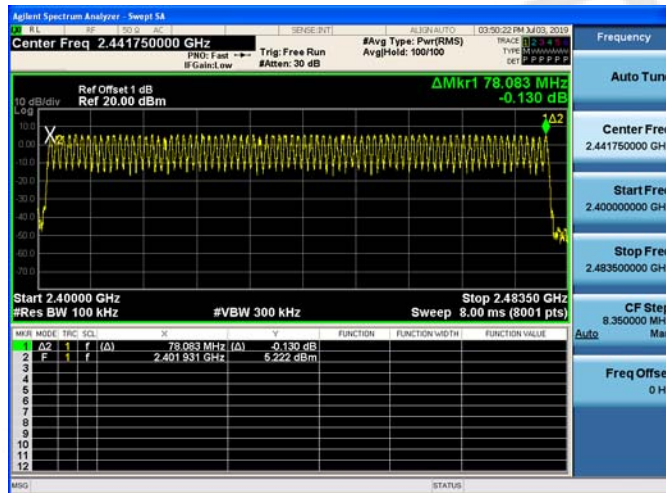

$\pi/4$ DQPSK Modulation

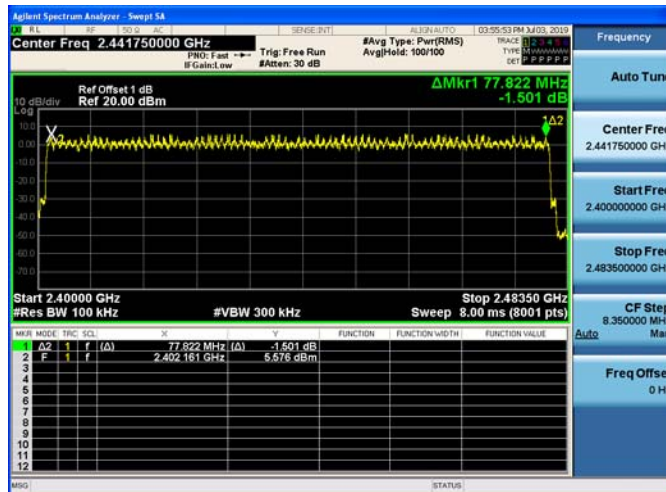

8DPSK Modulation

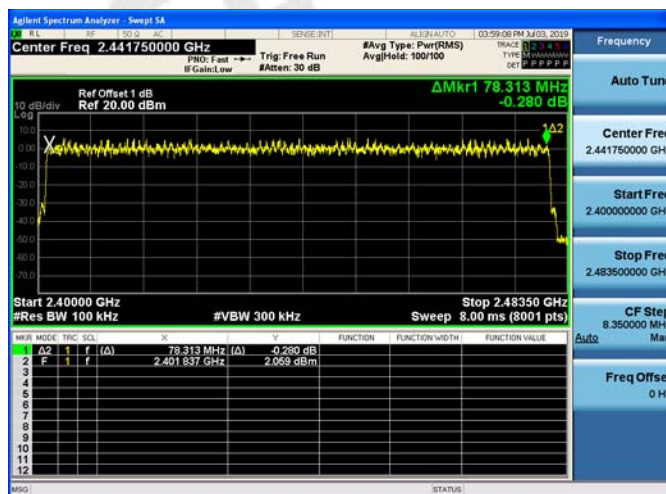

3.7. Time of Occupancy (Dwell Time)

Limit

The average time of occupancy on any channel shall not be greater than 0.4 seconds within a period of 0.4 seconds multiplied by the number of hopping channels employed.

Test Procedure

The transmitter output was connected to the spectrum analyzer through an attenuator. Set center frequency of spectrum analyzer=operating frequency with 1MHz RBW and 1MHz VBW, Span 0Hz.

Test Configuration

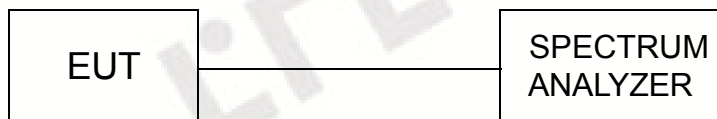

Test Results

Modulation	Packet	Pulse time (ms)	Dwell time (s)	Limit (s)	Result
GFSK	DH1	0.376	0.120	0.40	Pass
	DH3	1.631	0.261		
	DH5	2.878	0.307		
π/4DQPSK	2-DH1	0.386	0.124	0.40	Pass
	2-DH3	1.637	0.262		
	2-DH5	2.884	0.308		
8DPSK	3-DH1	0.387	0.124	0.40	Pass
	3-DH3	1.637	0.262		
	3-DH5	2.886	0.308		

Note:

- We have tested all mode at high,middle and low channel,and recoreded worst case at middle channel.
- $\text{Dwell time} = \text{Pulse time (ms)} \times (1600 \div 2 \div 79) \times 31.6 \text{ Second}$ for DH1, 2-DH1, 3-DH1
 $\text{Dwell time} = \text{Pulse time (ms)} \times (1600 \div 4 \div 79) \times 31.6 \text{ Second}$ for DH3, 2-DH3, 3-DH3
 $\text{Dwell time} = \text{Pulse time (ms)} \times (1600 \div 6 \div 79) \times 31.6 \text{ Second}$ for DH5, 2-DH5, 3-DH5

Test plot as follows:

GFSK Modulation

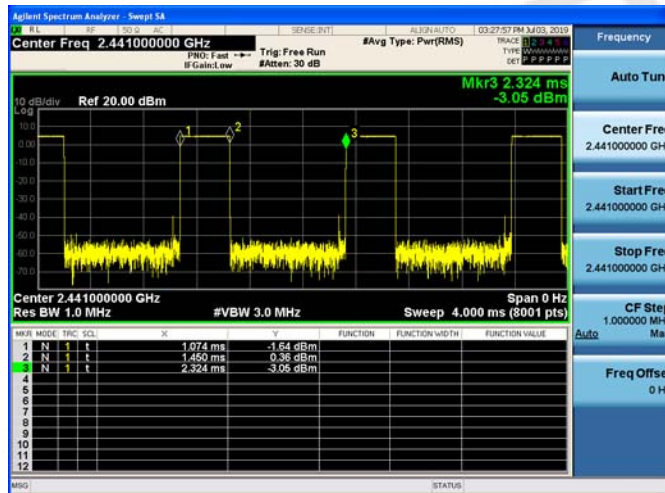

DH1

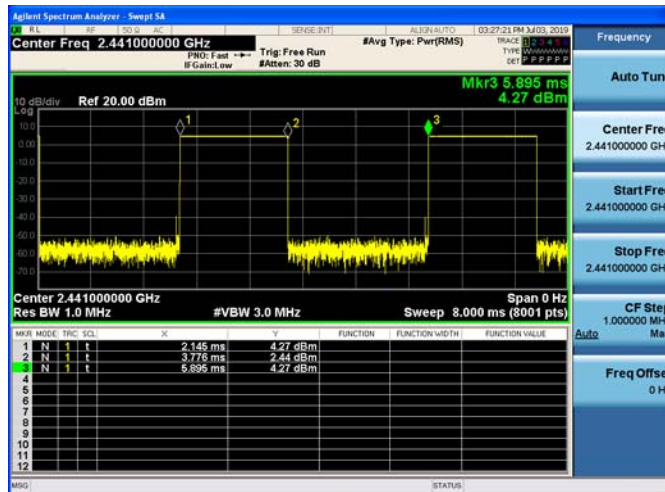

DH3

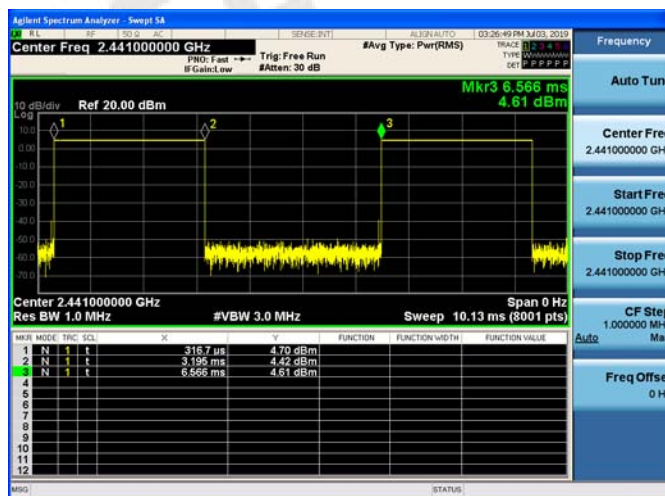

DH5

$\pi/4$ DQPSK Modulation

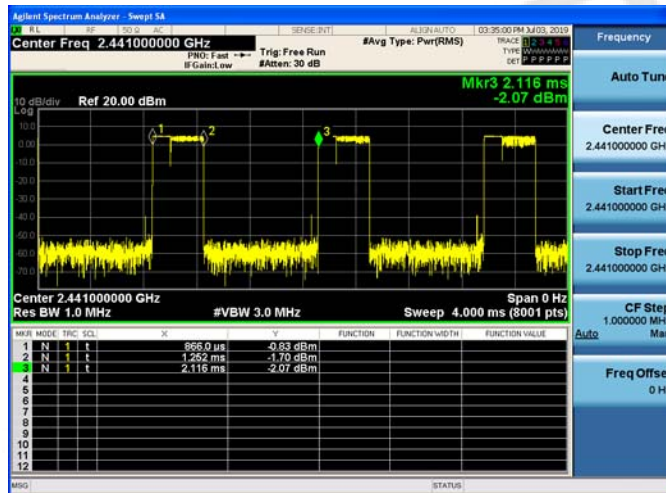

2-DH1

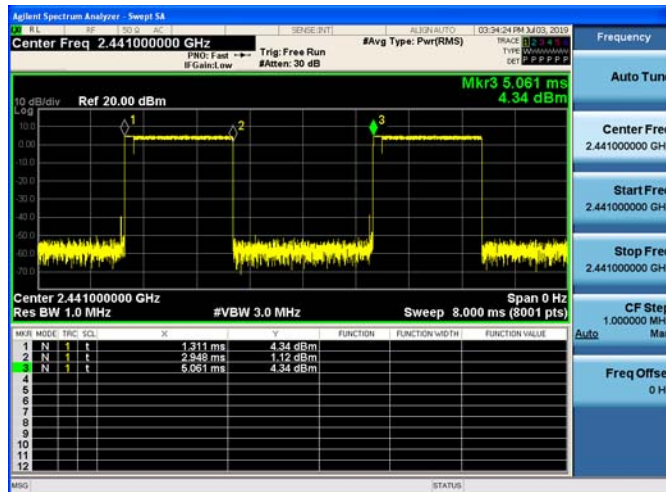

2-DH3

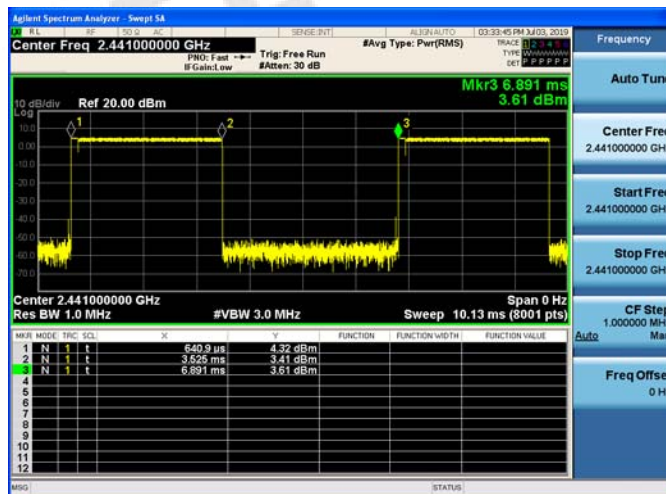

2-DH5

8DPSK Modulation

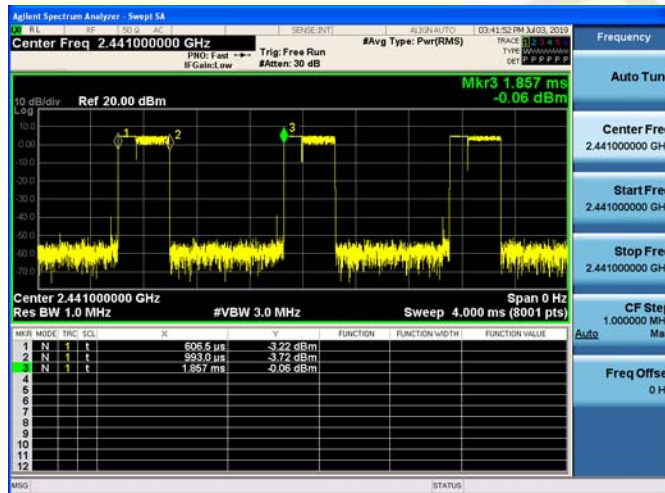

3-DH1

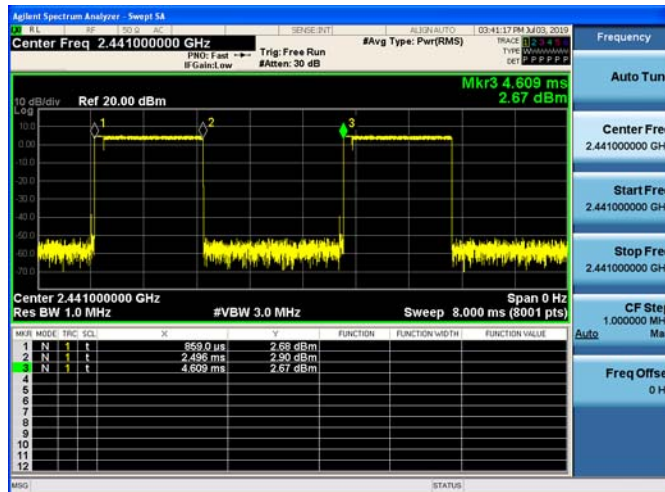

3-DH3

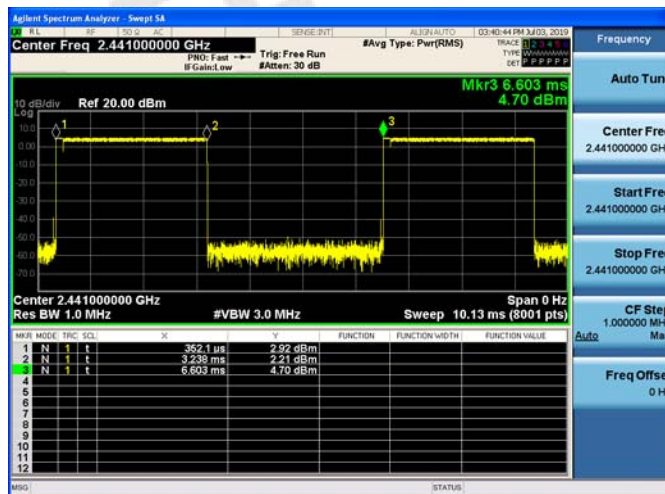

3-DH5

3.8. Out-of-band Emissions

Limit

In any 100 kHz bandwidth outside the frequency band in which the spread spectrum or digitally modulated intentional radiator is operating, the radio frequency power that is produced by the intentional radiator shall be at least 20 dB below that in the 100 kHz bandwidth within the band that contains the highest level of the desired power, based on either an RF conducted or a radiated measurement, provided the transmitter demonstrates compliance with the peak conducted power limits. If the transmitter complies with the conducted power limits based on the use of RMS averaging over a time interval, as permitted under paragraph (b)(3) of this section, the attenuation required under this paragraph shall be 30 dB instead of 20 dB. Attenuation below the general limits specified in §15.209(a) is not required.

Test Procedure

Connect the transmitter output to spectrum analyzer using a low loss RF cable, and set the spectrum analyzer to RBW=100 kHz, VBW= 300 kHz, peak detector , and max hold. Measurements utilizing these setting are made of the in-band reference level, bandedge and out-of-band emissions.

Test Configuration

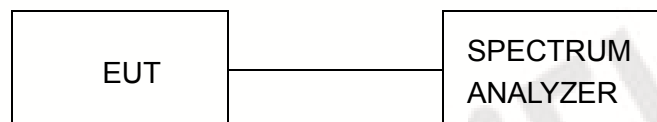

Test Results

Remark: The measurement frequency range is from 30MHz to the 10th harmonic of the fundamental frequency. The lowest, middle and highest channels are tested to verify the spurious emissions and bandage measurement data.

We measured all conditions (DH1, DH3, DH5) and recorded worst case at DH5

Test plot as follows:

GFSK CH00

GFSK CH39



Reference

Reference

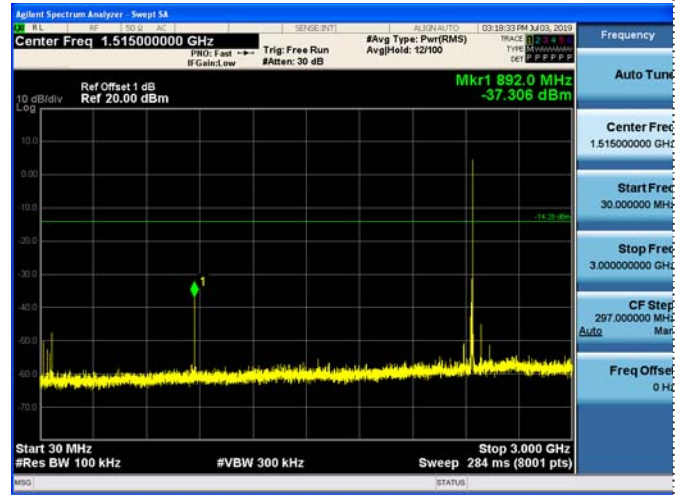
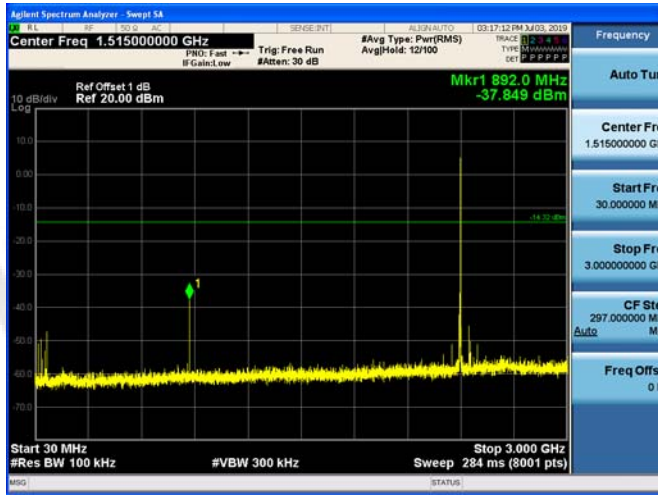

30MHz-3GHz

30MHz-3GHz

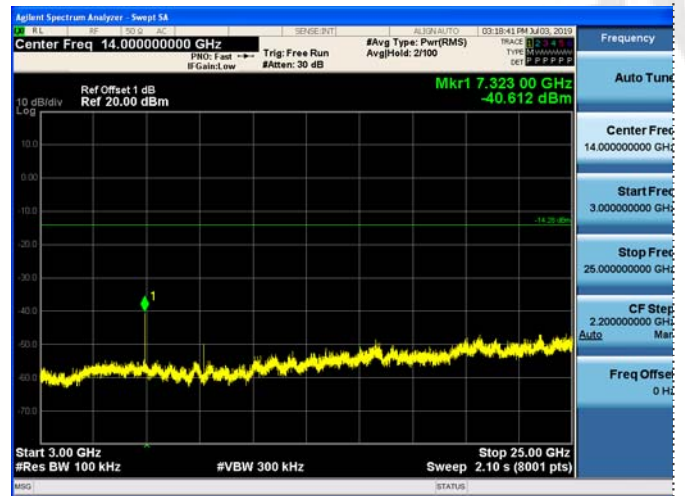
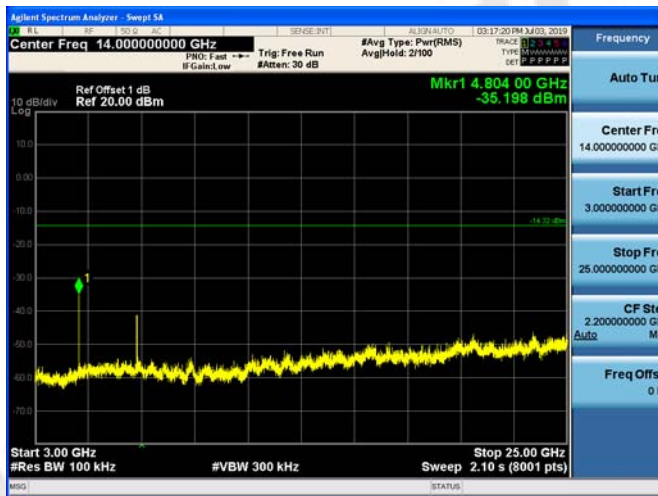

3GHz-25GHz

3GHz-25GHz

GFSK CH78

$\pi/4$ DQPSK CH00



Reference

Reference

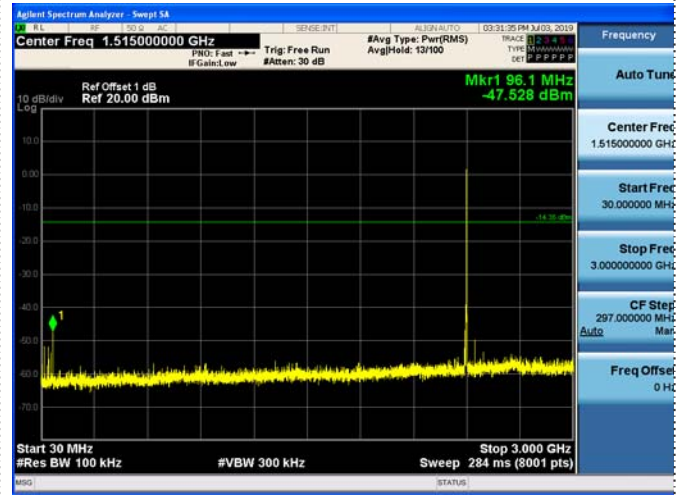
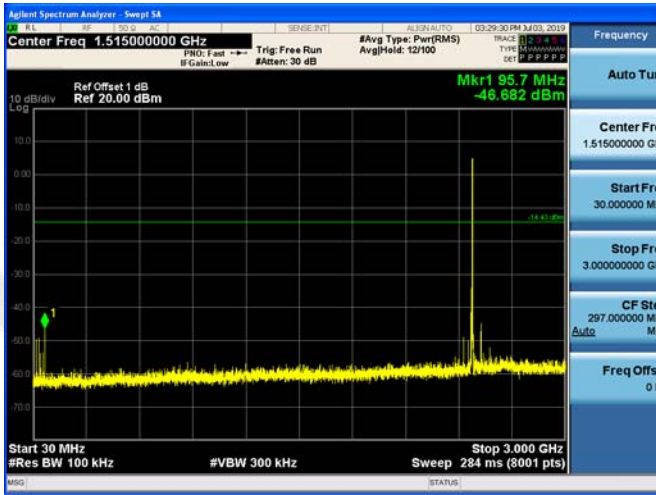

30MHz-3GHz

30MHz-3GHz

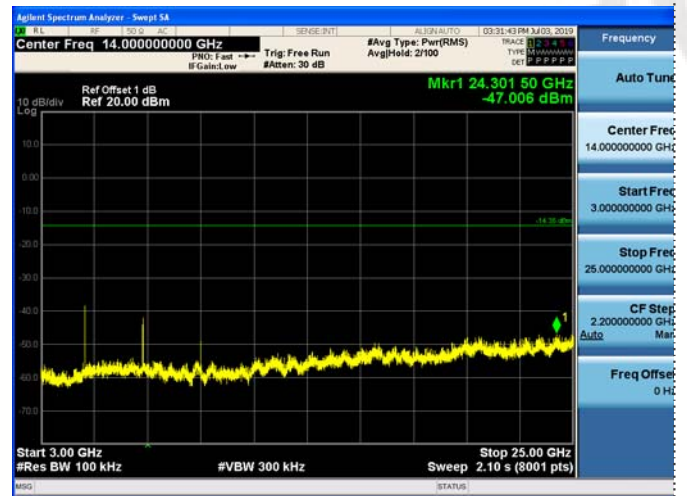
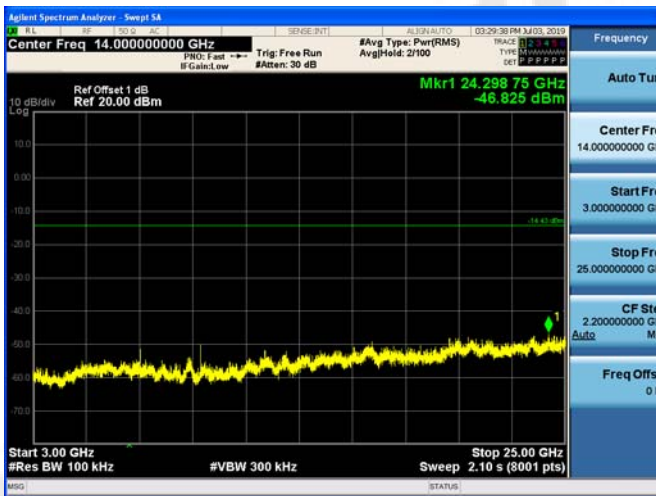

3GHz-25GHz

3GHz-25GHz

$\pi/4$ DQPSK CH39



Reference

$\pi/4$ DQPSK CH78

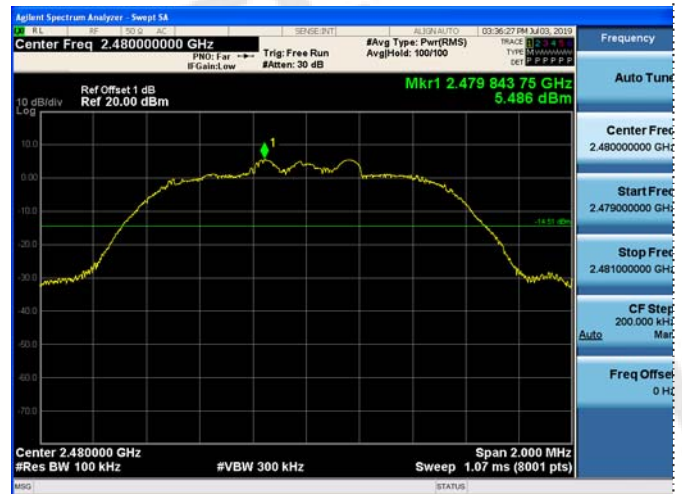

Reference

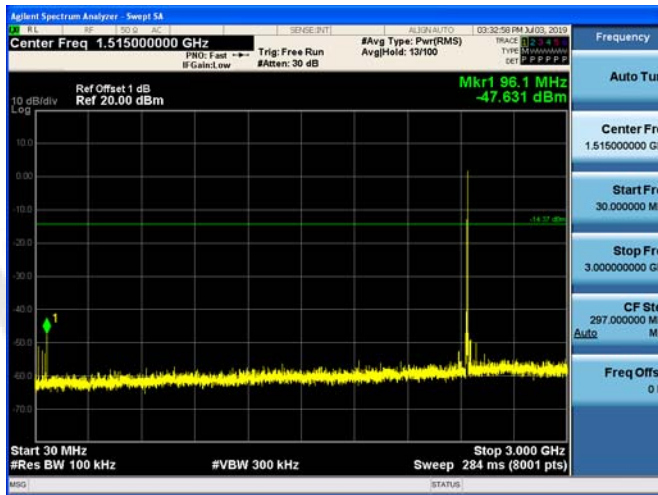

30MHz-3GHz

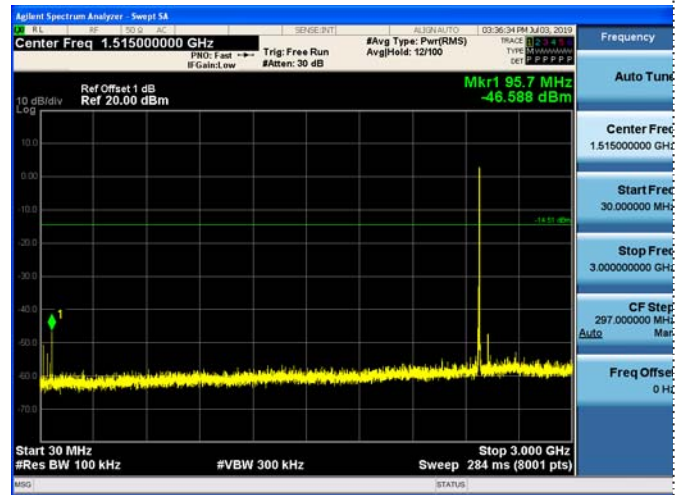

30MHz-3GHz

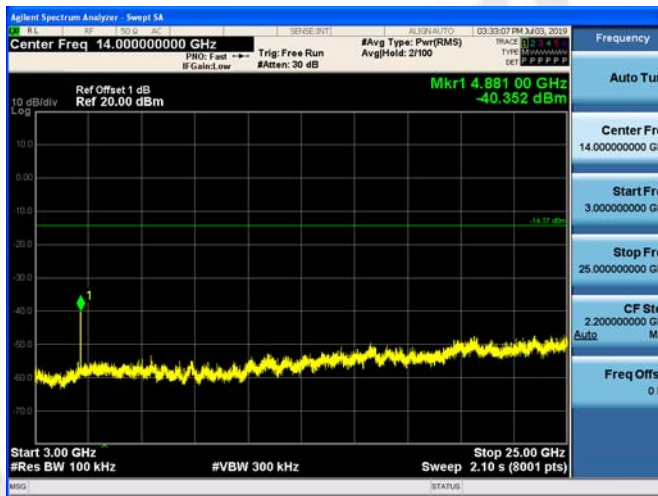

3GHz-25GHz

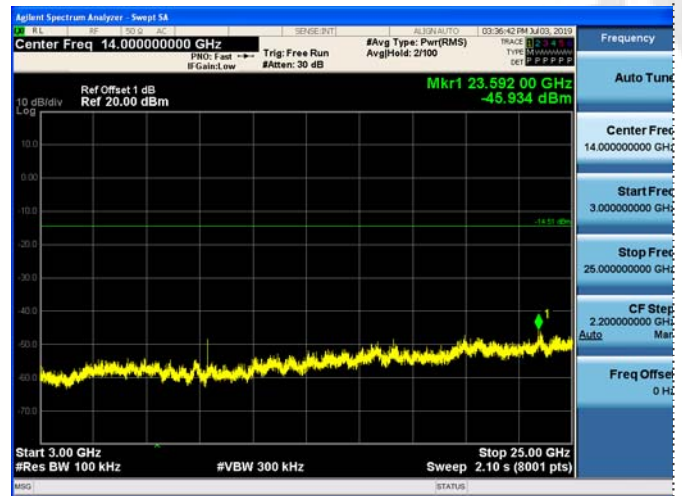

3GHz-25GHz

8DPSK CH00

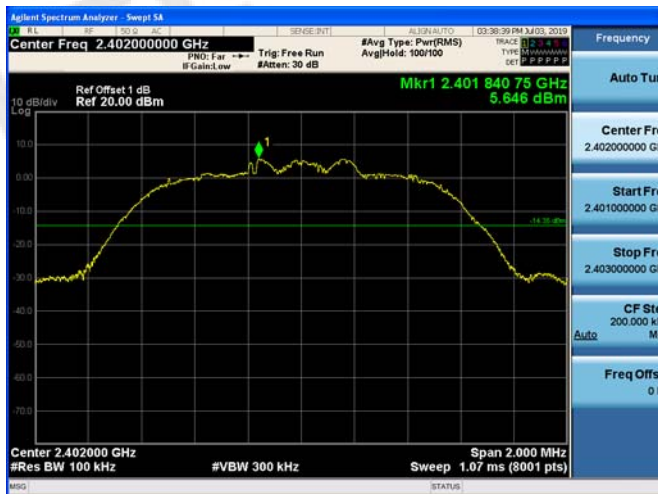

8DPSK CH39

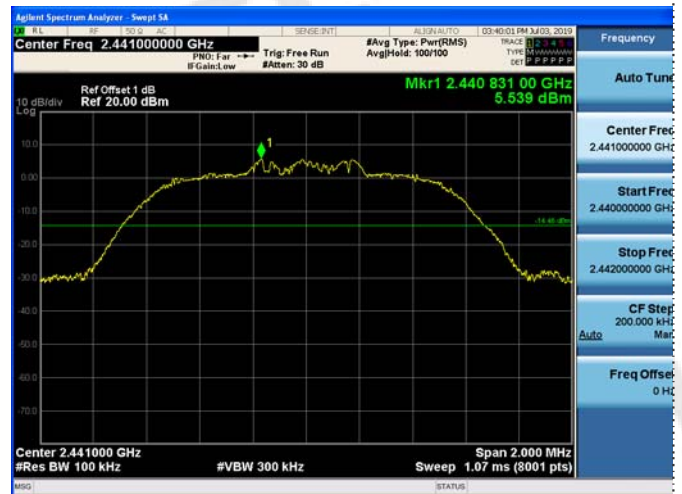

Reference

Reference

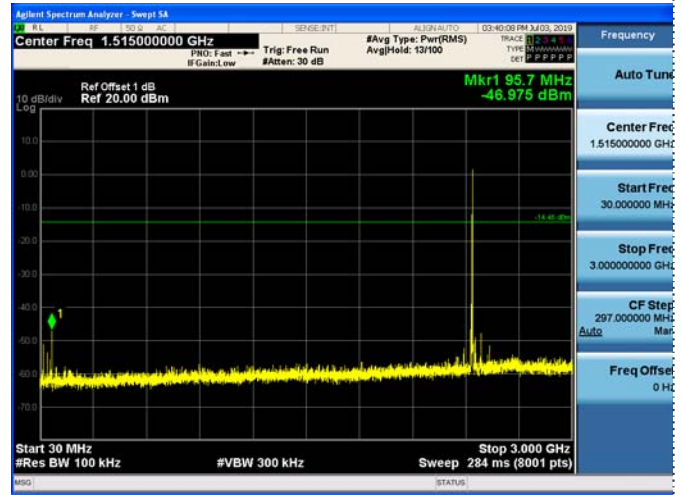
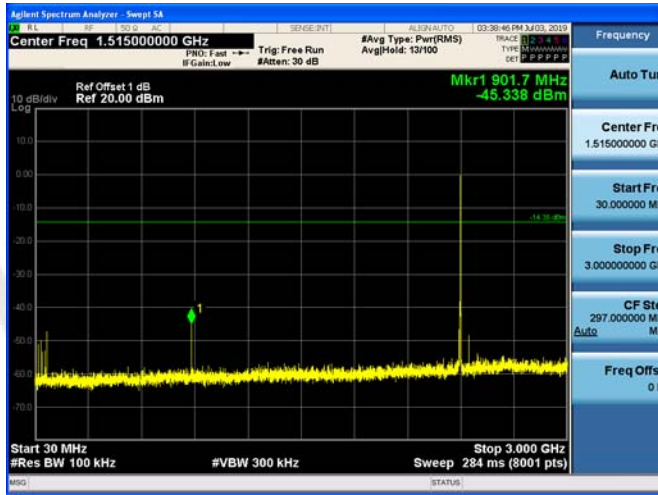

30MHz-3GHz

30MHz-3GHz

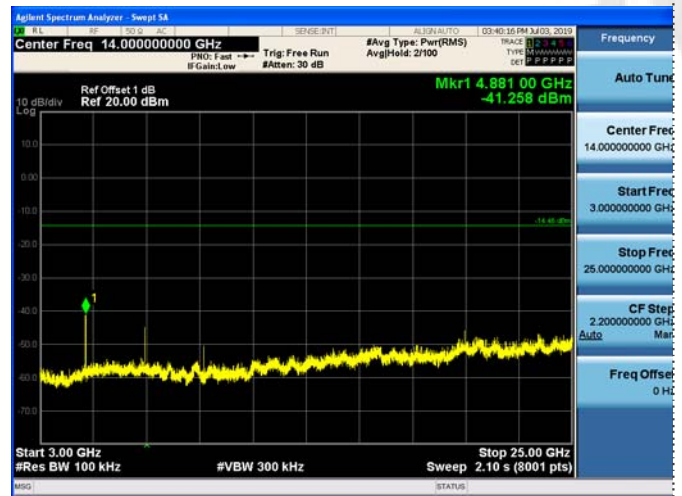
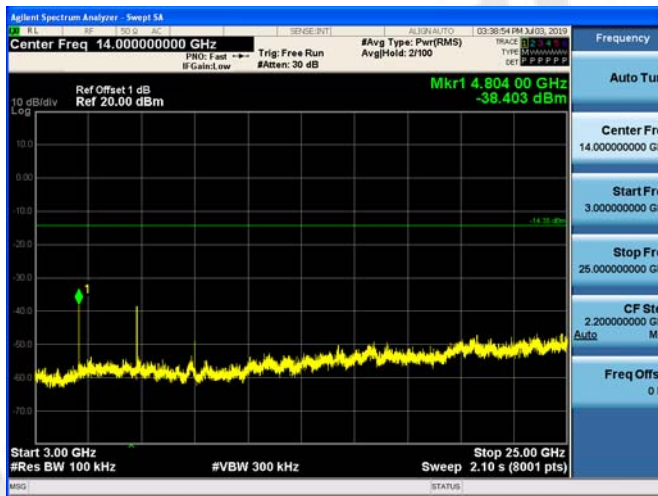

3GHz-25GHz

3GHz-25GHz

8DPSK CH78



Reference

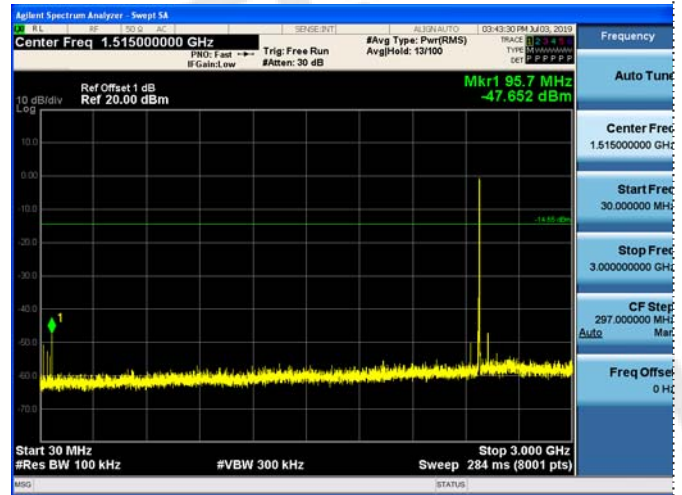

30MHz-3GHz

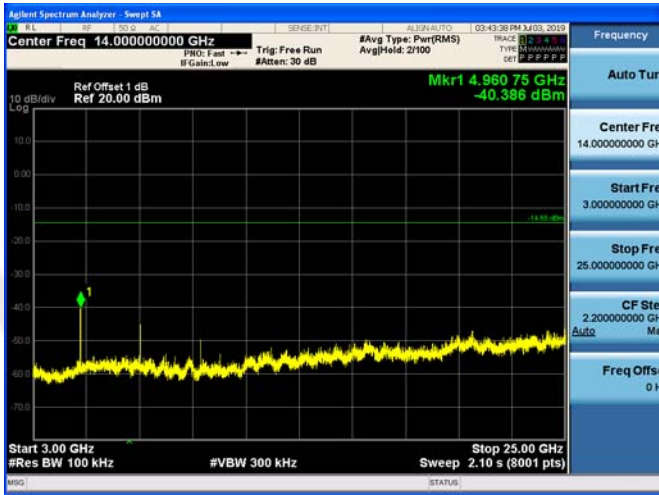

3GHz-25GHz

Band-edge Measurements for RF Conducted Emissions:

GFSK

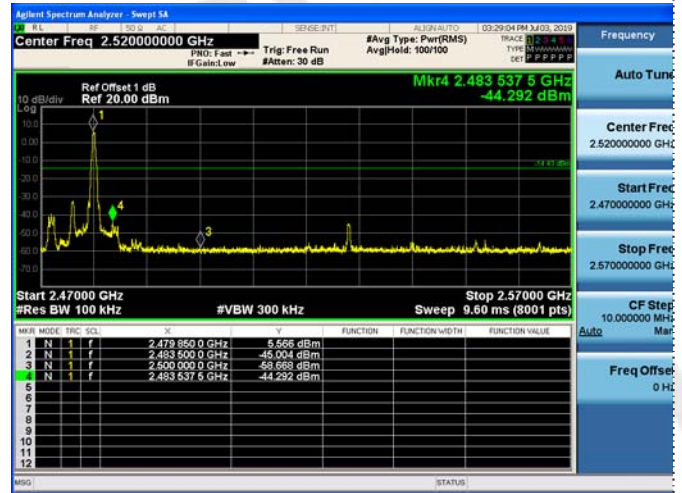
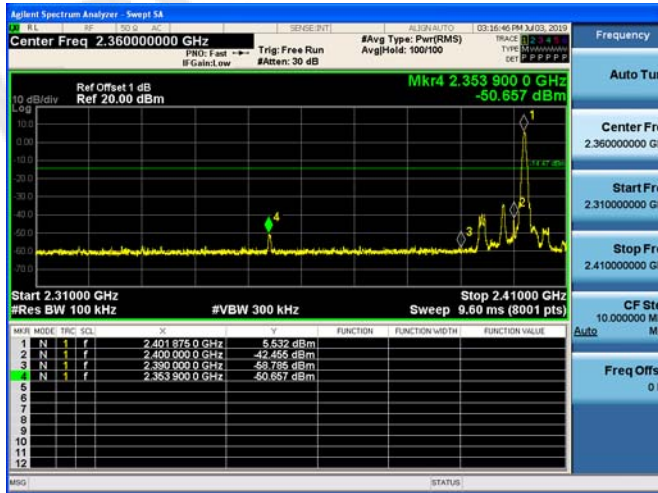

Left Band edge hopping off

Right Band edge hopping off

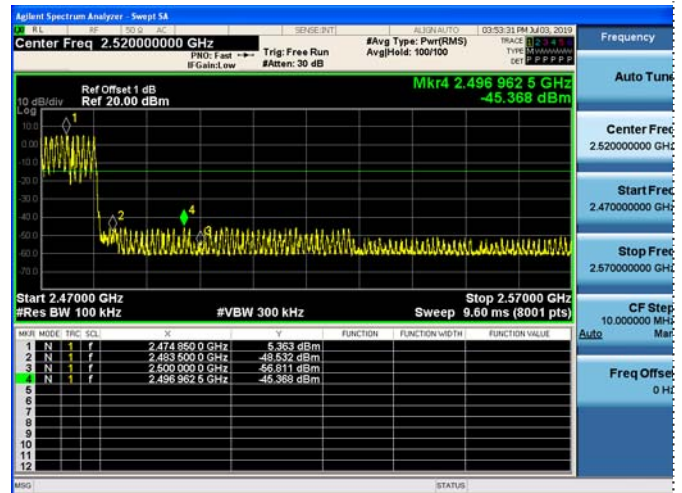
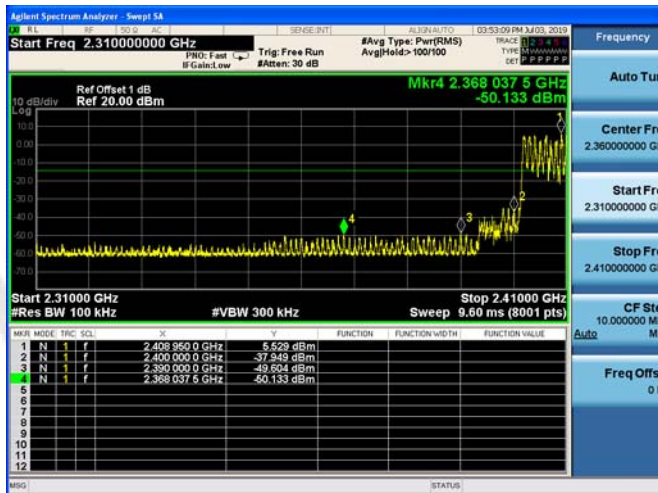

Left Band edge hopping on

Right Band edge hopping on

$\pi/4$ DQPSK

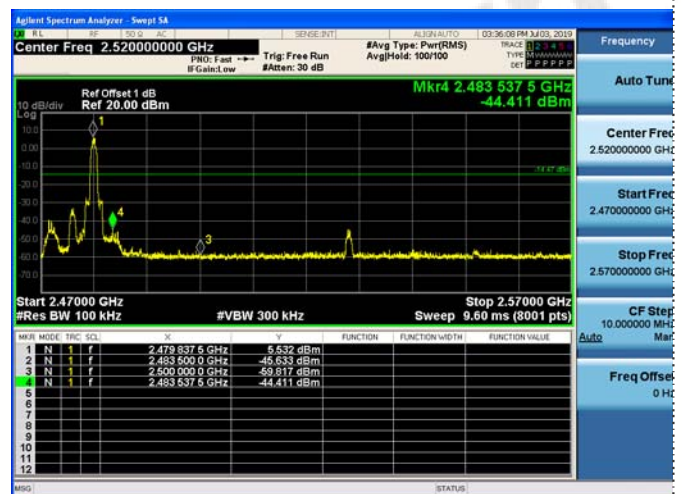
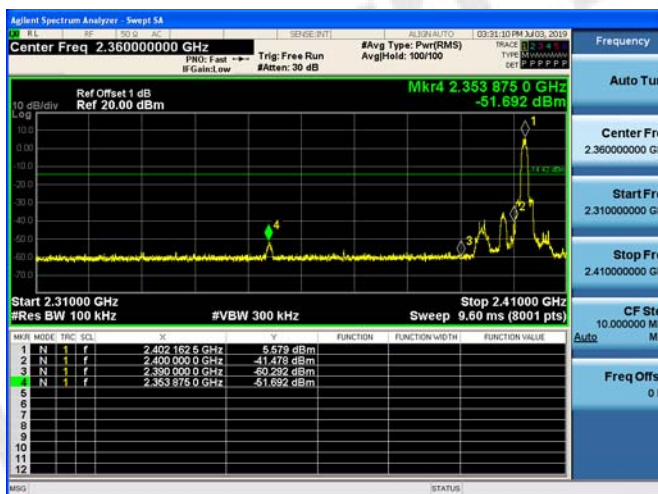

Left Band edge hopping off

Right Band edge hopping off

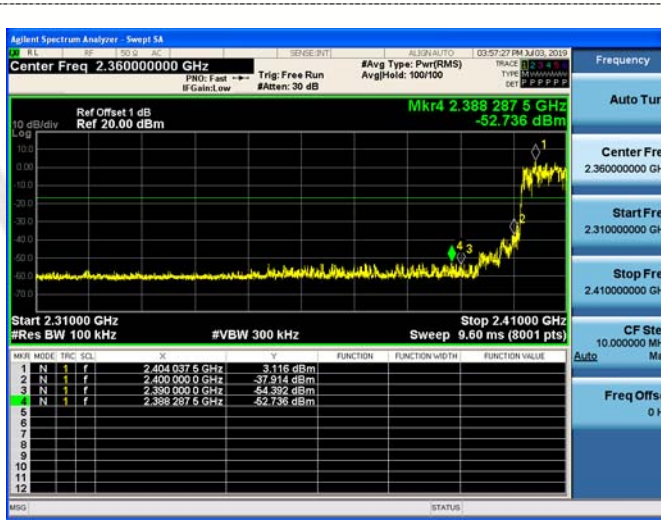

Left Band edge hopping on

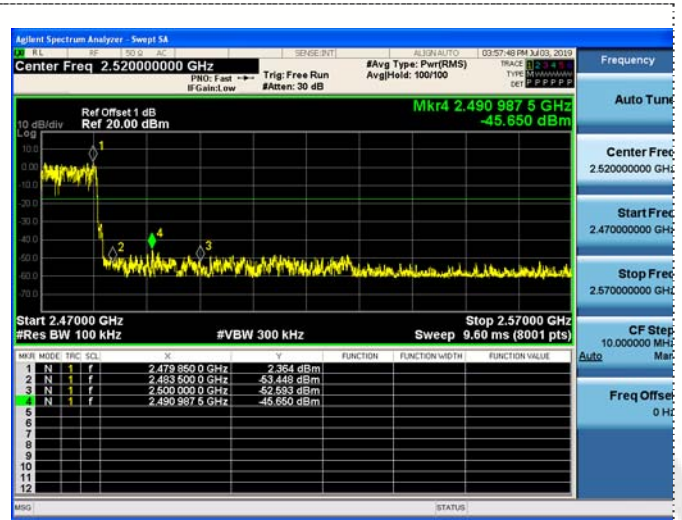

Right Band edge hopping on

8DPSK

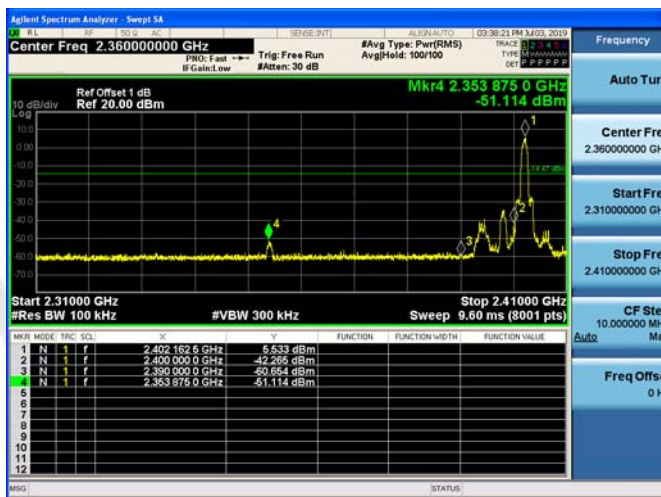

Left Band edge hopping off

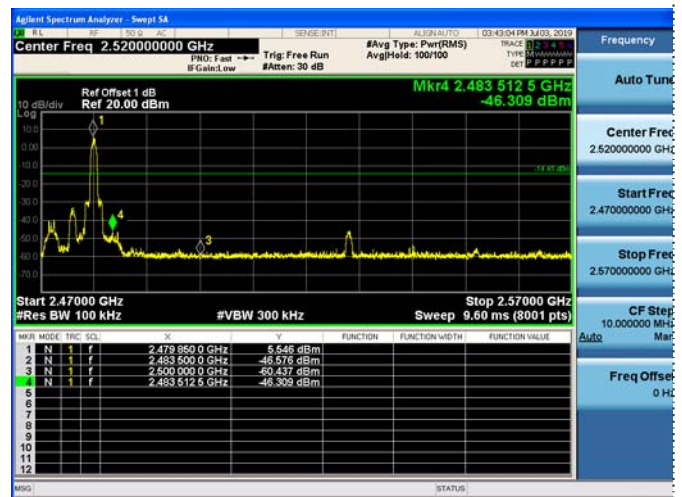

Right Band edge hopping off

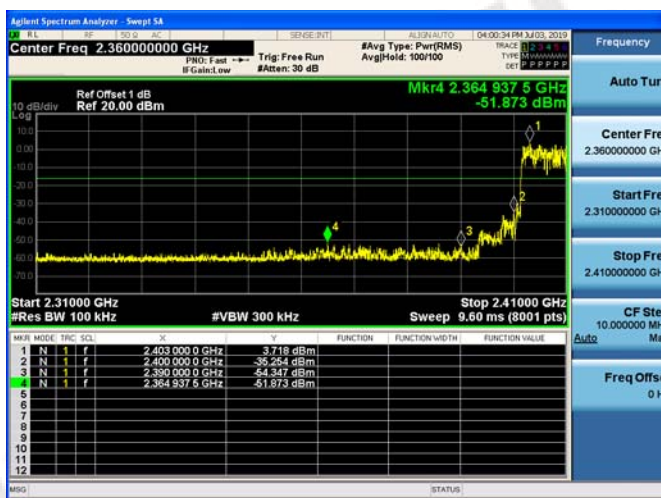

Left Band edge hopping on

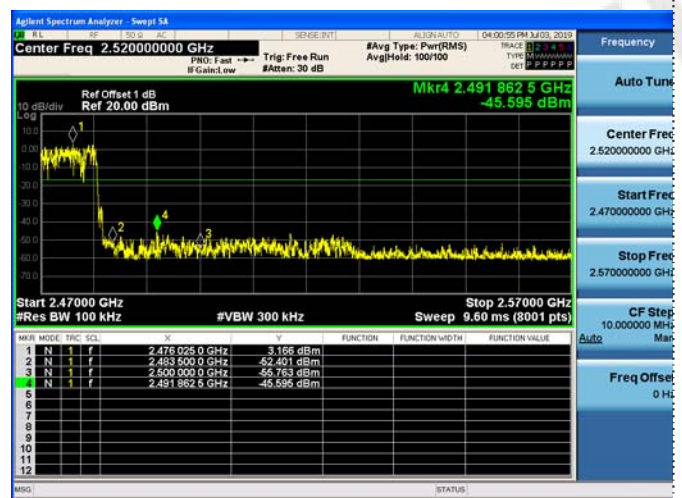

Right Band edge hopping on

3.9. Pseudorandom Frequency Hopping Sequence

TEST APPLICABLE

For 47 CFR Part 15C section 15.247 (a) (1) requirement:

Frequency hopping systems shall have hopping channel carrier frequencies separated by a minimum of 25 kHz or the 20 dB bandwidth of the hop-ping channel, whichever is greater. Alternatively, frequency hopping systems operating in the 2400–2483.5 MHz band may have hopping channel carrier frequencies that are separated by 25 kHz or two-thirds of the 20 dB bandwidth of the hopping channel, whichever is greater, provided the systems operate with an output power no greater than 125 mW. The system shall hop to channel frequencies that are selected at the system hopping rate from a pseudo randomly ordered list of hopping frequencies. Each frequency must be used equally on the average by each transmitter. The system receivers shall have input bandwidths that match the hop-ping channel bandwidths of their corresponding transmitters and shall shift frequencies in synchronization with the transmitted signals.

EUT Pseudorandom Frequency Hopping Sequence Requirement

The pseudorandom frequency hopping sequence may be generated in a nine-stage shift register whose 5th and 9th stage outputs are added in a modulo-two addition stage. And the result is fed back to the input of the first stage. The sequence begins with the first one of 9 consecutive ones, for example: the shift register is initialized with nine ones.

- Number of shift register stages:9
- Length of pseudo-random sequence:29-1=511 bits
- Longest sequence of zeros:8(non-inverted signal)

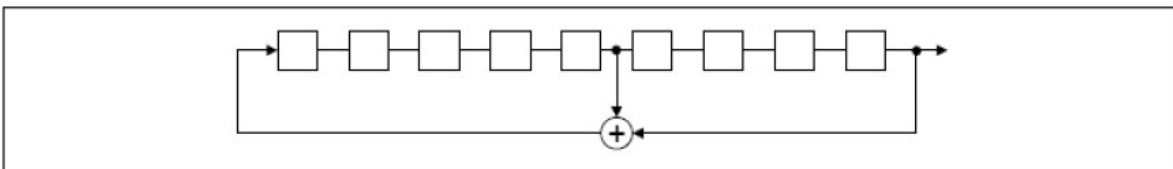

Linear Feedback Shift Register for Generation of the PRBS sequence

An example of pseudorandom frequency hopping sequence as follows:

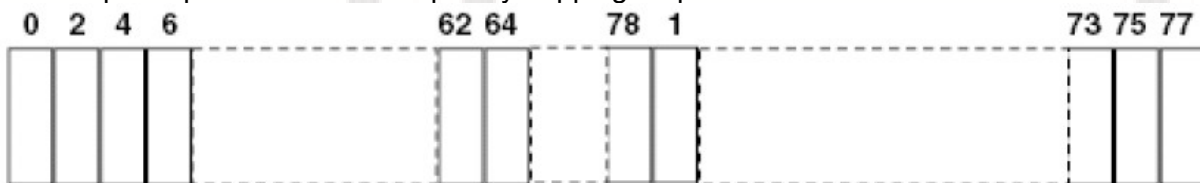

Each frequency used equally one the average by each transmitter.

The system receiver have input bandwidths that match the hopping channel bandwidths of their corresponding transmitter and shift frequencies in synchronization with the transmitted signals.

3.10. Antenna Requirement

Standard Applicable

For intentional device, according to FCC 47 CFR Section 15.203, an intentional radiator shall be designed to ensure that no antenna other than that furnished by the responsible party shall be used with the device.

And according to FCC 47 CFR Section 15.247 (c), if transmitting antennas of directional gain greater than 6dBi are used, the power shall be reduced by the amount in dB that the directional gain of the antenna exceeds 6dBi.

Refer to statement below for compliance

The manufacturer may design the unit so that the user can replace a broken antenna, but the use of a standard antenna jack or electrical connector is prohibited. Further, this requirement does not apply to intentional radiators that must be professionally installed.

Antenna Connected Construction

The maximum gain of antenna was 0dBi.

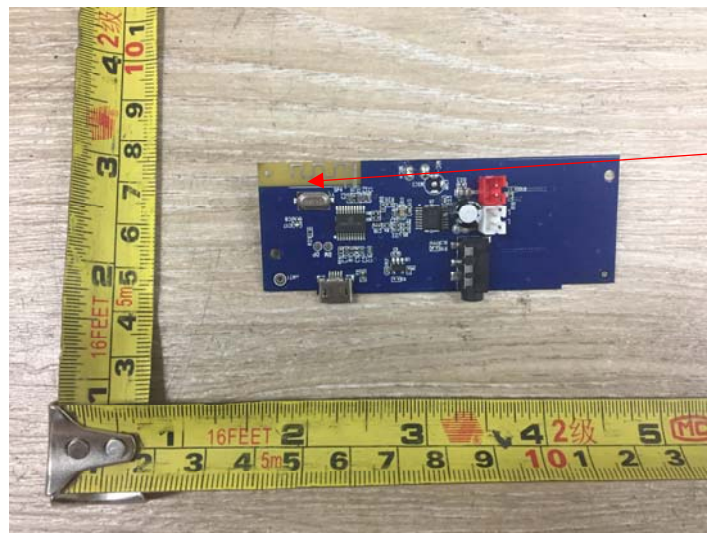

Antenna

4. Test Setup Photos of the EUT



5. Photos of the EUT

External Photos of EUT





Internal Photos of EUT



antenna

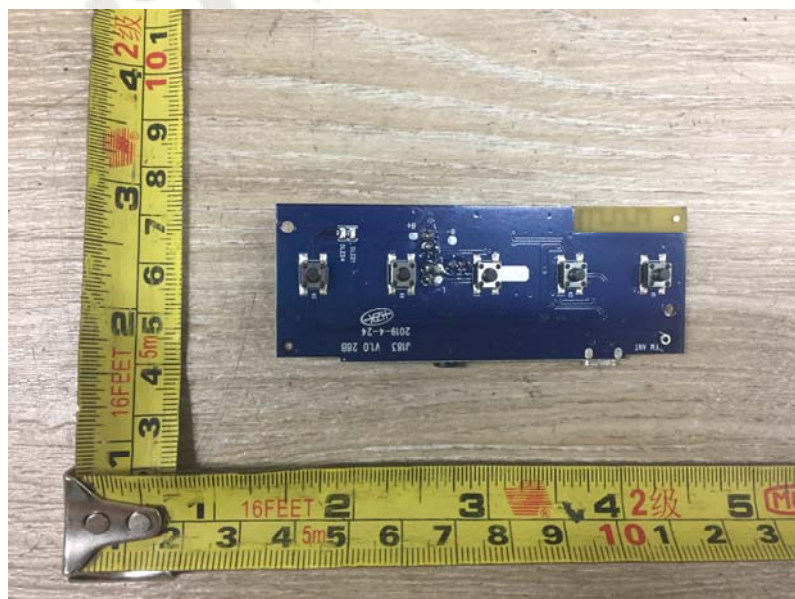
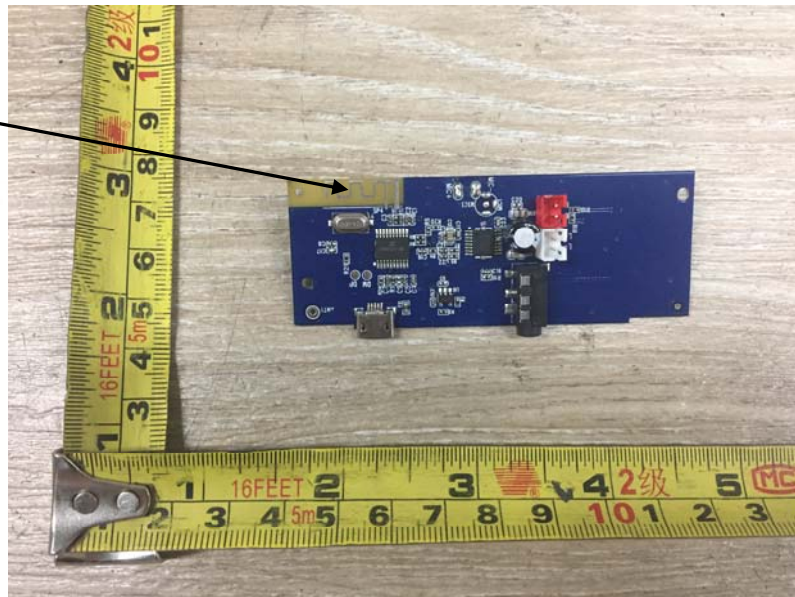

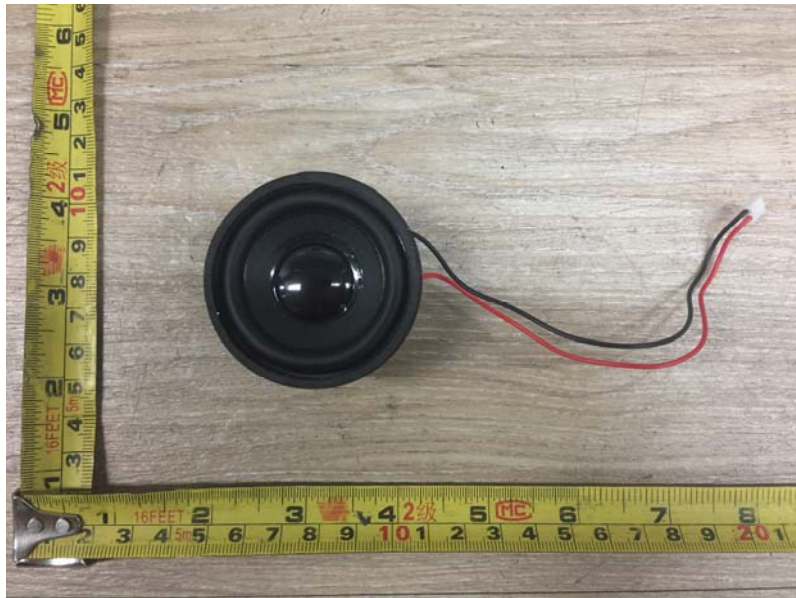

***** End of Report *****