



FCC RADIO TEST REPORT

FCC ID: 2AM8RBC08

Product: Bluetooth Beacon

Trade Name: N/A

Model Name: BC08

Serial Model: N/A

Report No.: POCE17073135QRF

Prepared for

Netradyne Inc

4350 Executive Drive, Suite 150, San Diego, CA 92121. USA

Prepared by

Shenzhen POCE Technology Co.,Ltd.

Room 502, Bldg. 1, Xinghua Garden, Baoan Road Xixiang,
Baoan District, Shenzhen, China

TEST RESULT CERTIFICATION

Applicant's name Netradyne Inc
Address..... 4350 Executive Drive, Suite 150, San Diego, CA 92121. USA

Manufacturer's Name.. Tzone Digital Technology Co.,LTD
Address..... 16D, Haiying Building, South of Caitian Road, Futian District, Shenzhen, China

Product description

Product name Bluetooth Beacon

Model and/or type
Reference BC08

Trade Name N/A

Standards FCC Part15.247, KDB558074 D01 DTS Meas Guidance v03r03

Test procedure ANSI C63.10: 2013

This device described above has been tested by POCE, and the test results show that the equipment under test (EUT) is in compliance with the FCC requirements. And it is applicable only to the tested sample identified in the report.

This report shall not be reproduced except in full, without the written approval of POCE, this document may be altered or revised by POCE, personal only, and shall be noted in the revision of the document.

Date of Test

Date (s) of performance of tests 20 Jun. 2017 ~10 Jul. 2017

Date of Issue 10 Jul. 2017

Test Result **Pass**

Testing Engineer : 
_____ (Ken Li)

Technical Manager : 
_____ (Jimmy Yao)

Authorized Signatory : 

Table of Contents

	Page
1 . SUMMARY OF TEST RESULTS	5
1.1 TEST FACILITY	6
1.2 MEASUREMENT UNCERTAINTY	6
2 . GENERAL INFORMATION	7
2.1 GENERAL DESCRIPTION OF EUT	7
2.2 DESCRIPTION OF TEST MODES	9
2.3 BLOCK DIGRAM SHOWING THE CONFIGURATION OF SYSTEM TESTED	10
2.4 DESCRIPTION OF SUPPORT UNITS(CONDUCTED MODE)	11
2.5 EQUIPMENTS LIST FOR ALL TEST ITEMS	12
3 . EMC EMISSION TEST	13
3.1 CONDUCTED EMISSION MEASUREMENT	13
3.1.1 POWER LINE CONDUCTED EMISSION LIMITS	13
3.1.2 TEST PROCEDURE	14
3.1.3 DEVIATION FROM TEST STANDARD	14
3.1.4 TEST SETUP	14
3.1.5 EUT OPERATING CONDITIONS	14
3.1.6 TEST RESULTS	15
3.2 RADIATED EMISSION MEASUREMENT	16
3.2.1 RADIATED EMISSION LIMITS	16
3.2.2 TEST PROCEDURE	17
3.2.3 DEVIATION FROM TEST STANDARD	17
3.2.4 TEST SETUP	18
3.2.5 EUT OPERATING CONDITIONS	19
3.2.6 TEST RESULTS (BETWEEN 9KHZ – 30 MHZ)	20
3.2.7 TEST RESULTS (BETWEEN 30MHZ – 1GHZ)	21
3.2.8 TEST RESULTS (ABOVE 1000 MHZ)	23
4 . POWER SPECTRAL DENSITY TEST	28
4.1 APPLIED PROCEDURES / LIMIT	28
4.1.1 TEST PROCEDURE	28
4.1.2 DEVIATION FROM STANDARD	28
4.1.3 TEST SETUP	28
4.1.4 EUT OPERATION CONDITIONS	28
4.1.5 TEST RESULTS	29
5 . BANDWIDTH TEST	31
5.1 APPLIED PROCEDURES / LIMIT	31
5.1.1 TEST PROCEDURE	31
5.1.2 DEVIATION FROM STANDARD	31

Table of Contents

	Page
5.1.3 TEST SETUP	31
5.1.4 EUT OPERATION CONDITIONS	31
5.1.5 TEST RESULTS	32
6 . PEAK OUTPUT POWER TEST	34
6.1 APPLIED PROCEDURES / LIMIT	34
6.1.1 TEST PROCEDURE	34
6.1.2 DEVIATION FROM STANDARD	34
6.1.3 TEST SETUP	34
6.1.4 EUT OPERATION CONDITIONS	34
6.1.5 TEST RESULTS	35
7 . ANTENNA REQUIREMENT	37
7.1 STANDARD REQUIREMENT	37
7.2 EUT ANTENNA	37
APPENDIX-PHOTOGRAPHS OF EUT CONSTRUCTIONAL DETAILS	

1. SUMMARY OF TEST RESULTS

Test procedures according to the technical standards:

FCC Part15 (15.247) , Subpart C KDB558074 D01 DTS Meas Guidance v03r05			
Standard Section	Test Item	Judgment	Remark
15.207(a)	AC Conducted Emission	N/A	
15.247 (a)(2)	6dB Bandwidth	PASS	
15.247 (b)(3) 15.31(e)	Peak Output Power	PASS	
15.247 (d) 15.205	Radiated Spurious Emission	PASS	
15.247 (e)	Power Spectral Density	PASS	
15.247(d), 15.205	Band Edge Emission	PASS	
15.203	Antenna Requirement	PASS	

NOTE:

(1) " N/A " denotes test is not applicable in this Test Report

1.1 TEST FACILITY

Shenzhen POCE Technology Co.,Ltd.

Add.: Room 502, Bldg. 1, Xinghua Garden, Baoan Road Xixiang, Baoan District, Shenzhen, China

FCC-Registration No.: 222278

1.2 MEASUREMENT UNCERTAINTY

The reported uncertainty of measurement $y \pm U$, where expanded uncertainty U is based on a standard uncertainty multiplied by a coverage factor of $k=2$, providing a level of confidence of approximately **95** %.

No.	Item	Uncertainty
1	Conducted Emission Test	$\pm 1.38\text{dB}$
2	RF power,conducted	$\pm 0.16\text{dB}$
3	Spurious emissions,conducted	$\pm 0.21\text{dB}$
4	All emissions,radiated(<1G)	$\pm 4.68\text{dB}$
5	All emissions,radiated(>1G)	$\pm 4.89\text{dB}$
6	Temperature	$\pm 0.5^{\circ}\text{C}$
7	Humidity	$\pm 2\%$

2. GENERAL INFORMATION

2.1 GENERAL DESCRIPTION OF EUT

Equipment	Bluetooth Beacon	
Trade Name	N/A	
Model Name	BC08	
Serial Model	N/A	
Model Difference	All the same, Only model name is different.	
Product Description	The EUT is a Bluetooth Beacon	
	Operation Frequency:	2402~2480 MHz
	Modulation Type:	GFSK
	Bluetooth	Bluetooth 4.0
	Number Of Channel	40CH
	Antenna Designation:	Please see Note 3.
	Output Power(Peak):	-5.65dbm
	Antenna Gain (dBi)	0dbi
	Based on the application, features, or specification exhibited in User's Manual, the EUT is considered as an ITE/Computing Device. More details of EUT technical specification, please refer to the User's Manual.	
	Channel List	Please refer to the Note 2.
Battery	DC3.0V	
Connecting I/O Port(s)	Please refer to the User's Manual	

Note:

1. For a more detailed features description, please refer to the manufacturer’s specifications or the User’s Manual.

2.

Channel List							
Channel	Frequency (MHz)	Channel	Frequency (MHz)	Channel	Frequency (MHz)	Channel	Frequency (MHz)
00	2402	10	2422	20	2442	30	2462
01	2404	11	2424	21	2444	31	2464
02	2406	12	2426	22	2446	32	2466
03	2408	13	2428	23	2448	33	2468
04	2410	14	2430	24	2450	34	2470
05	2412	15	2432	25	2452	35	2472
06	2414	16	2434	26	2454	36	2474
07	2416	17	2436	27	2456	37	2476
08	2418	18	2438	28	2458	38	2478
09	2420	19	2440	29	2460	39	2480

3.

Table for Filed Antenna

Ant	Brand	Model Name	Antenna Type	Connector	Gain (dBi)	NOTE
A	N/A	N/A	PCB antenna	N/A	0	N/A

2.2 DESCRIPTION OF TEST MODES

To investigate the maximum EMI emission characteristics generates from EUT, the test system was pre-scanning tested base on the consideration of following EUT operation mode or test configuration mode which possible have effect on EMI emission level. Each of these EUT operation mode(s) or test configuration mode(s) mentioned above was evaluated respectively.

Pretest Mode	Description
Mode 1	TX 2402
Mode 2	TX 2440
Mode 3	TX 2480
Mode 4	Link Mode

For Conducted Emission	
Final Test Mode	Description
Mode 4	N/A

For Radiated Emission	
Final Test Mode	Description
Mode 1	TX 2402
Mode 2	TX 2440
Mode 3	TX 2480
Mode 4	Link Mode

Note:

(1) The measurements are performed at the highest, middle, lowest available channels.

2.3 BLOCK DIGRAM SHOWING THE CONFIGURATION OF SYSTEM TESTED

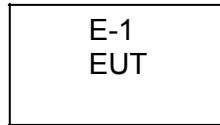

2.4 DESCRIPTION OF SUPPORT UNITS(CONDUCTED MODE)

The EUT has been tested as an independent unit together with other necessary accessories or support units. The following support units or accessories were used to form a representative test configuration during the tests.

Item	Equipment	Mfr/Brand	Model/Type No.	Series No.	Note
E-1	Bluetooth Beacon	N/A	BC08	N/A	EUT

Item	Shielded Type	Ferrite Core	Length	Note

Note:

- (1) The support equipment was authorized by Declaration of Confirmation.
- (2) For detachable type I/O cable should be specified the length in cm in 『Length』 column.

2.5 EQUIPMENTS LIST FOR ALL TEST ITEMS

Radiation Test equipment

Item	Kind of Equipment	Manufacturer	Type No.	Serial No.	Last calibration	Calibrated until	Calibration period
1	Spectrum Analyzer	Agilent	E4407B	MY45108040	2016.09.06	2017.09.05	1 year
2	Test Receiver	R&S	ESPI	101318	2016.09.07	2017.09.06	1 year
3	Bilog Antenna	TESEQ	CBL6111D	31216	2016.09.06	2017.09.05	1 year
4	50Ω Coaxial Switch	Anritsu	MP59B	6200264416	2016.09.07	2017.09.06	1 year
5	Spectrum Analyzer	ADVANTEST	R3132	150900201	2016.09.07	2017.09.06	1 year
6	Horn Antenna	EM	EM-AH-10180	2011071402	2016.09.06	2017.09.05	1 year
7	Horn Ant	Schwarzbeck	BBHA 9170	9170-181	2016.09.06	2017.09.05	1 year
8	Amplifier	EM	EM-30180	060538	2016.12.22	2017.12.21	1 year
9	Loop Antenna	ARA	PLA-1030/B	1029	2016.09.08	2017.09.07	1 year

Conduction Test equipment

Item	Kind of Equipment	Manufacturer	Type No.	Serial No.	Last calibration	Calibrated until	Calibration period
1	Test Receiver	R&S	ESCI	101160	2016.09.06	2017.09.05	1 year
2	LISN	R&S	ENV216	101313	2016.08.24	2017.08.23	1 year
3	LISN	EMCO	3816/2	00042990	2016.08.24	2017.08.23	1 year
4	50Ω Coaxial Switch	Anritsu	MP59B	6200264417	2016.09.07	2017.09.06	1 year
5	Passive Voltage Probe	R&S	ESH2-Z3	100196	2016.09.07	2017.09.06	1 year
6	Absorbing clamp	R&S	MOS-21	100423	2016.09.08	2017.09.07	1 year

3. EMC EMISSION TEST

3.1 CONDUCTED EMISSION MEASUREMENT

3.1.1 POWER LINE CONDUCTED EMISSION Limits (Frequency Range 150KHz-30MHz)

FREQUENCY (MHz)	Class A (dBuV)		Class B (dBuV)		Standard
	Quasi-peak	Average	Quasi-peak	Average	
0.15 -0.5	79.00	66.00	66 - 56 *	56 - 46 *	CISPR
0.50 -5.0	73.00	60.00	56.00	46.00	CISPR
5.0 -30.0	73.00	60.00	60.00	50.00	CISPR

0.15 -0.5	79.00	66.00	66 - 56 *	56 - 46 *	FCC
0.50 -5.0	73.00	60.00	56.00	46.00	FCC
5.0 -30.0	73.00	60.00	60.00	50.00	FCC

Note:

- (1) The tighter limit applies at the band edges.
- (2) The limit of " * " marked band means the limitation decreases linearly with the logarithm of the frequency in the range.

The following table is the setting of the receiver

Receiver Parameters	Setting
Attenuation	10 dB
Start Frequency	0.15 MHz
Stop Frequency	30 MHz
IF Bandwidth	9 kHz

3.1.2 TEST PROCEDURE

- a. The EUT was placed 0.4 meters from the horizontal ground plane with EUT being connected to the power mains through a line impedance stabilization network (LISN). All other support equipments powered from additional LISN(s). The LISN provide 50 Ohm/ 50uH of coupling impedance for the measuring instrument.
- b. Interconnecting cables that hang closer than 40 cm to the ground plane shall be folded back and forth in the center forming a bundle 30 to 40 cm long.
- c. I/O cables that are not connected to a peripheral shall be bundled in the center. The end of the cable may be terminated, if required, using the correct terminating impedance. The overall length shall not exceed 1 m.
- d. LISN at least 80 cm from nearest part of EUT chassis.
- e. For the actual test configuration, please refer to the related Item –EUT Test Photos.

3.1.3 DEVIATION FROM TEST STANDARD

No deviation

3.1.4 TEST SETUP

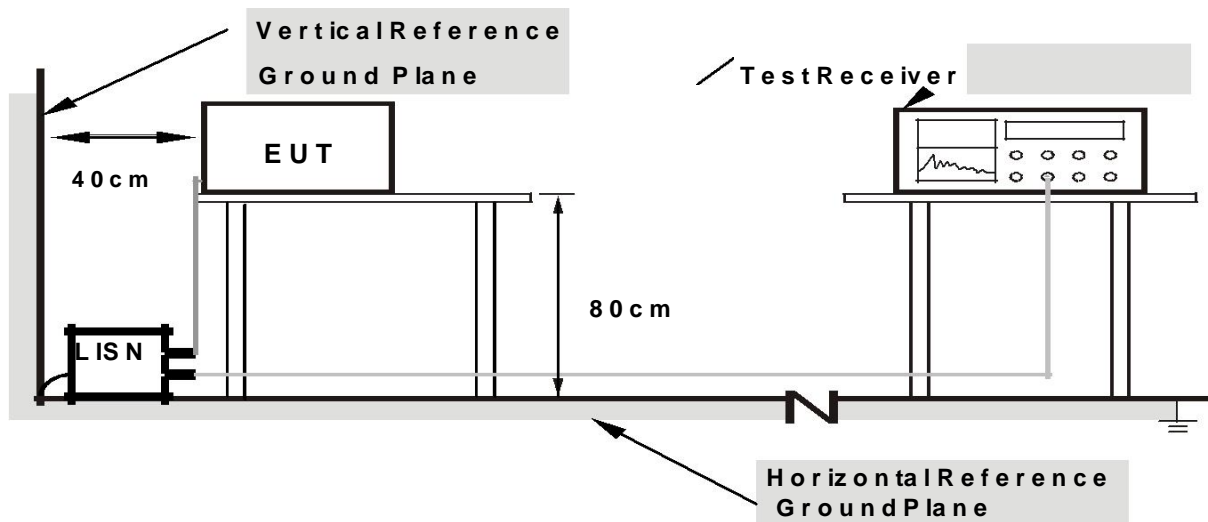

- Note:**
- 1. Support units were connected to second LISN.
 - 2. Both of LISNs (AMN) are 80 cm from EUT and at least 80 from other units and other metal planes

3.1.5 EUT OPERATING CONDITIONS

The EUT was configured for testing in a typical fashion (as a customer would normally use it). The EUT has been programmed to continuously transmit during test. This operating condition was tested and used to collect the included data.

3.1.6 TEST RESULTS

EUT:	Bluetooth Beacon	Model Name. :	BC08
Temperature:	26 °C	Relative Humidity:	54%
Pressure:	1010hPa	Phase :	L
Test Voltage :	N/A	Test Mode:	N/A

NOTE: To Conducted Emission, not suitable for battery devices.

3.2 RADIATED EMISSION MEASUREMENT

3.2.1 RADIATED EMISSION LIMITS (Frequency Range 9kHz-1000MHz)

20dBc in any 100 kHz bandwidth outside the operating frequency band. In case the emission fall within the restricted band specified on 15.205(a), then the 15.209(a) limit in the table below has to be followed.

Frequencies (MHz)	Field Strength (micorvolts/meter)	Measurement Distance (meters)
0.009~0.490	2400/F(KHz)	300
0.490~1.705	24000/F(KHz)	30
1.705~30.0	30	30
30~88	100	3
88~216	150	3
216~960	200	3
Above 960	500	3

Above 1GHz

Spectrum Parameter	Setting
Attenuation	Auto
Start Frequency	1000 MHz
Stop Frequency	10th carrier harmonic
RB / VB (emission in restricted band)	1 MHz / 1 MHz for Peak, 1 MHz / 10Hz for Average

Below 1GHz

Receiver Parameter	Setting
Attenuation	Auto
Start ~ Stop Frequency	9kHz~150kHz / RB 200Hz for QP
Start ~ Stop Frequency	150kHz~30MHz / RB 9kHz for QP
Start ~ Stop Frequency	30MHz~1000MHz / RB 120kHz for QP

3.2.2 TEST PROCEDURE

- a. The measuring distance of at 3 m shall be used for measurements at frequency up to 1GHz. For frequencies above 1GHz, any suitable measuring distance may be used.
- b. The EUT was placed on the top of a rotating table 0.8 meters above the ground at a 3 meter open area test site. The table was rotated 360 degrees to determine the position of the highest radiation.
- c. The height of the equipment or of the substitution antenna shall be 0.8 m; the height of the test antenna shall vary between 1 m to 4 m. Both horizontal and vertical polarizations of the antenna are set to make the measurement.
- d. The initial step in collecting conducted emission data is a spectrum analyzer peak detector mode pre-scanning the measurement frequency range. Significant peaks are then marked and then Quasi Peak detector mode re-measured.
- e. If the Peak Mode measured value compliance with and lower than Quasi Peak Mode Limit, the EUT shall be deemed to meet QP Limits and then no additional QP Mode measurement performed.
- f. For the actual test configuration, please refer to the related Item –EUT Test Photos.

Note:

Both horizontal and vertical antenna polarities were tested and performed pretest to three orthogonal axis. The worst case emissions were reported

3.2.3 DEVIATION FROM TEST STANDARD

No deviation

3.2.4 TEST SETUP

(A) Radiated Emission Test-Up Frequency Below 30MHz

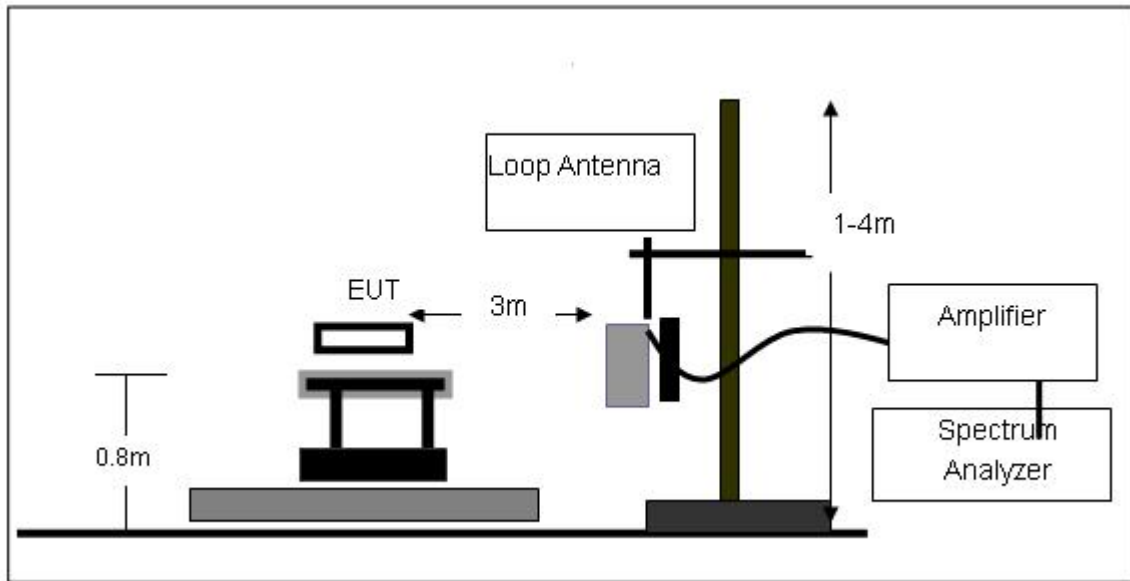

(B) Radiated Emission Test-Up Frequency 30MHz~1GHz

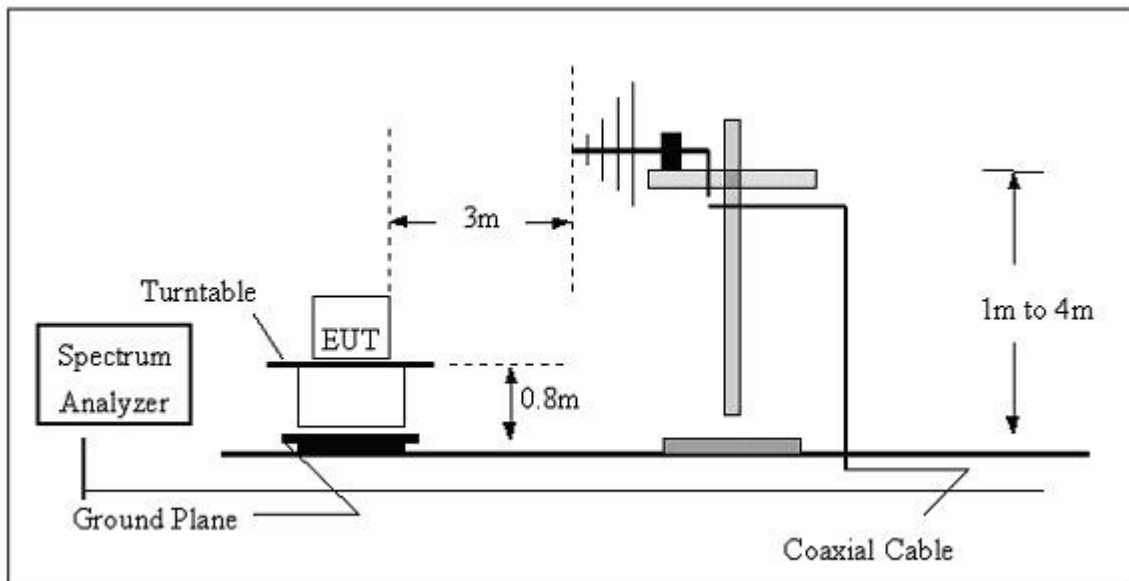

(C) Radiated Emission Test-Up Frequency Above 1GHz

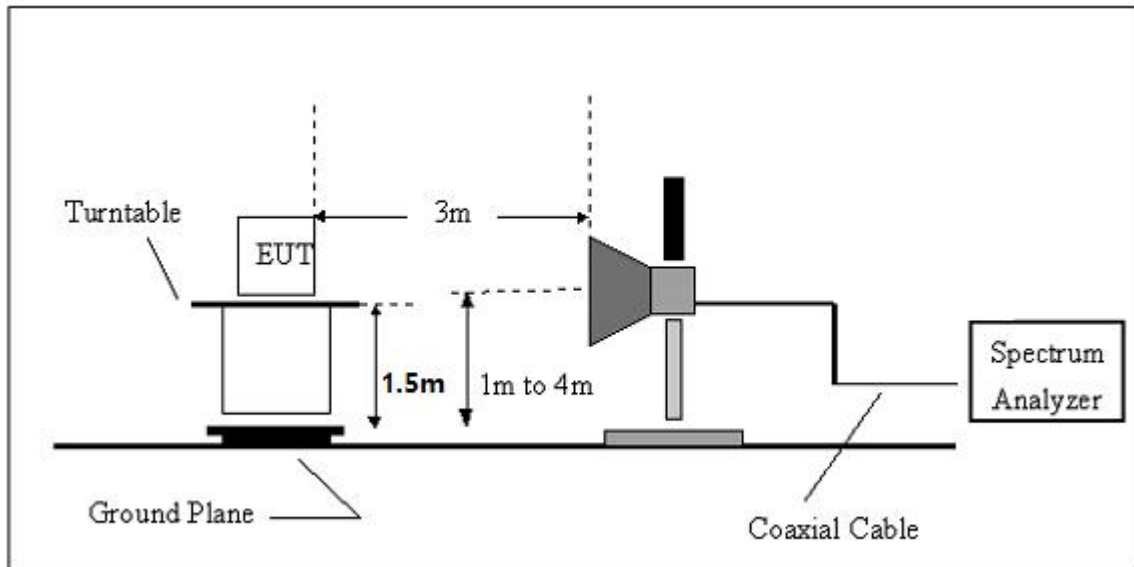

3.2.5 EUT OPERATING CONDITIONS

The EUT tested system was configured as the statements of 2.4 Unless otherwise a special operating condition is specified in the follows during the testing.

3.2.6 TEST RESULTS (BETWEEN 9KHZ – 30 MHZ)

EUT:	Bluetooth Beacon	Model Name. :	BC08
Temperature:	20 °C	Relative Humidity:	48%
Pressure:	1010 hPa	Test Voltage :	DC3.0V
Test Mode :	TX	Polarization :	--

Freq. (MHz)	Reading (dBuV/m)	Limit (dBuV/m)	Margin (dB)	State P/F
--	--	--	--	PASS
--	--	--	--	PASS

NOTE:

The amplitude of spurious emissions which are attenuated by more than 20dB below the permissible value has no need to be reported.

Distance extrapolation factor = $40 \log (\text{specific distance}/\text{test distance})$ (dB);

Limit line = specific limits(dBuv) + distance extrapolation factor.

3.2.7 TEST RESULTS (BETWEEN 30MHZ – 1GHZ)

EUT:	Bluetooth Beacon	Model Name :	BC08
Temperature:	20 °C	Relative Humidity:	48%
Pressure:	1010 hPa	Test Voltage :	DC3.0V
Test Mode : Mode 2			

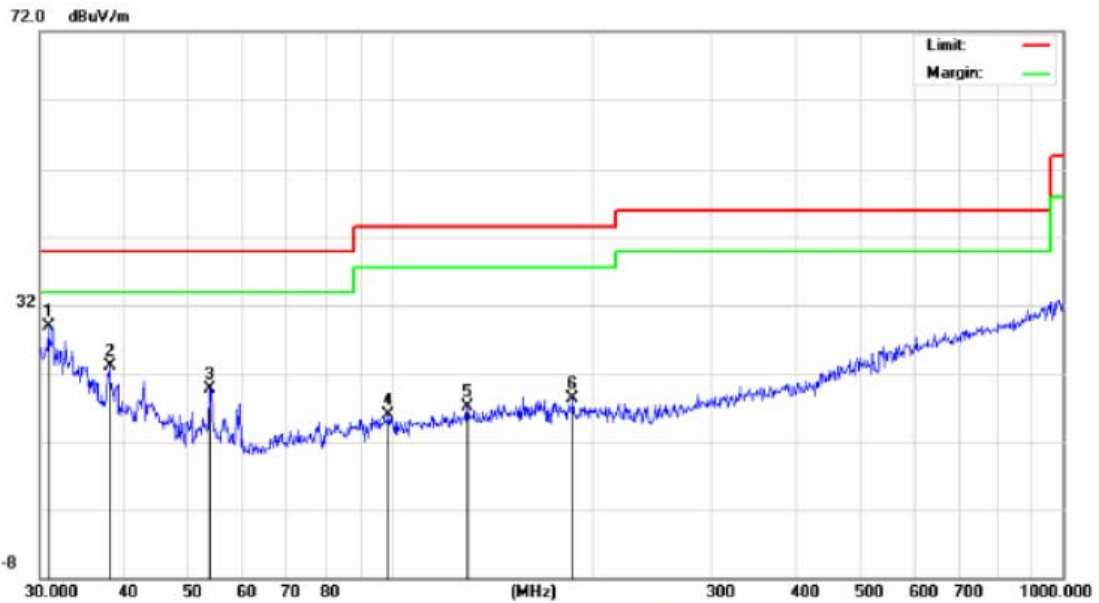

Site: Polarization: *Vertical* Temperature: 24
 Limit: FCC_PART15_B_03m_QP Power: AC 120V/60Hz Humidity: 50 %

No.	Mk.	Freq.	Reading Level	Correct Factor	Measurement	Limit	Over	Antenna Height	Table Degree	
		MHz	dBuV	dB	dBuV/m	dBuV/m	dB	cm	degree	Comment
1	!	31.7313	16.65	18.95	35.60	40.00	-4.40	QP		
2	!	39.2991	21.76	14.97	36.73	40.00	-3.27	QP		
3	!	49.8813	27.15	9.60	36.75	40.00	-3.25	QP		
4	*	71.8319	27.41	9.59	37.00	40.00	-3.00	QP		
5	!	77.0504	27.46	9.54	37.00	40.00	-3.00	QP		
6		601.4265	16.79	19.49	36.28	46.00	-9.72	QP		

EUT:	Bluetooth Beacon	Model Name :	BC08
Temperature:	20 °C	Relative Humidity:	48%
Pressure:	1010 hPa	Test Voltage :	DC3.0V
Test Mode : Mode 2			

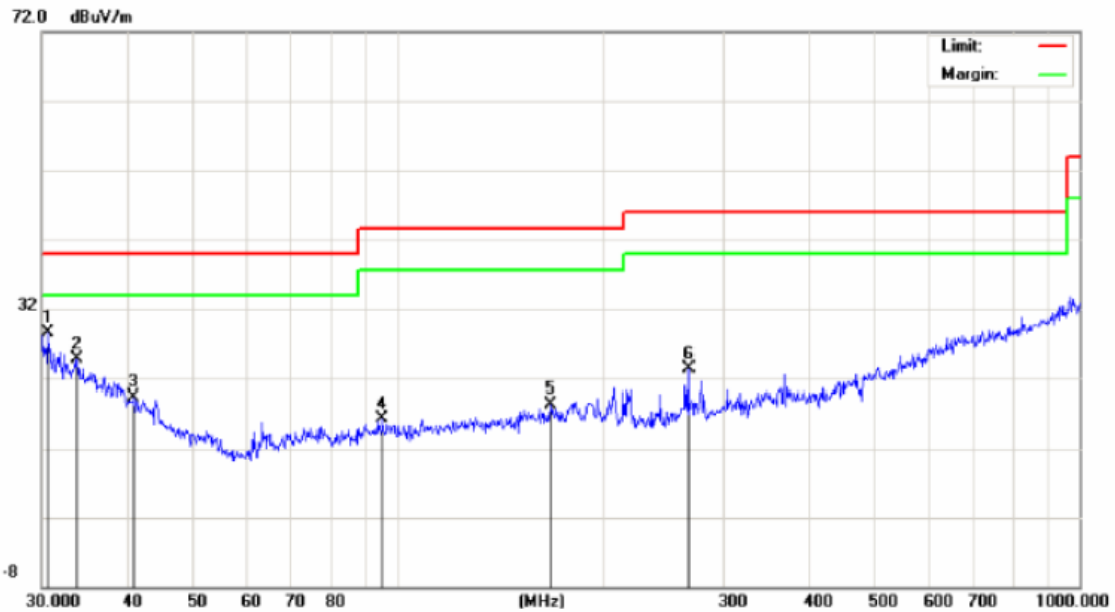

Site: Polarization: *Horizontal* Temperature: 24
 Limit: FCC_PART15_B_03m_QP Power: AC 120V/60Hz Humidity: 50 %

No.	Mk.	Freq.	Reading Level	Correct Factor	Measurement	Limit	Over	Antenna Height	Table Degree	
		MHz	dBuV	dB	dBuV/m	dBuV/m	dB	cm	degree	Comment
1		30.4237	6.74	19.42	26.16	40.00	-13.84			QP
2	*	49.8813	26.79	9.60	36.39	40.00	-3.61			QP
3	!	77.0504	26.55	9.54	36.09	40.00	-3.91			QP
4		197.8926	18.28	11.45	29.73	43.50	-13.77			QP
5		601.4265	16.00	19.49	35.49	46.00	-10.51			QP
6		833.3170	13.62	23.16	36.78	46.00	-9.22			QP

3.2.8 TEST RESULTS (1 GHZ-25GHZ)

EUT:	Bluetooth Beacon	Model Name :	BC08
Temperature:	20 °C	Relative Humidity:	48%
Pressure:	1010 hPa	Test Voltage :	DC3.0V

Frequency (MHz)	Meter Reading (dBµV)	Factor (dB)	Emission Level (dBµV/m)	Limits (dBµV/m)	Margin (dB)	Remark	Comment
Low Channel (2402 MHz)-Above 1G							
4804.59	56.10	-3.64	52.46	74.00	-21.54	Pk	Vertical
4804.59	40.10	-3.64	36.46	54.00	-17.54	AV	Vertical
7206.54	60.99	-0.95	60.04	74.00	-13.96	Pk	Vertical
7206.54	42.10	-0.95	41.15	54.00	-12.85	AV	Vertical
4804.70	59.32	-3.64	55.68	74.00	-18.32	Pk	Horizontal
4804.70	42.43	-3.64	38.79	54.00	-15.21	AV	Horizontal
7206.62	57.89	-0.95	56.94	74.00	-17.06	Pk	Horizontal
7206.62	42.07	-0.95	41.12	54.00	-12.88	AV	Horizontal
Mid Channel (2440 MHz)-Above 1G							
4880.64	60.99	-3.68	57.31	74.00	-16.69	Pk	Vertical
4880.64	39.32	-3.68	35.64	54.00	-18.36	AV	Vertical
7320.54	59.32	-0.82	58.50	74.00	-15.50	Pk	Vertical
7320.54	41.99	-0.82	41.17	54.00	-12.83	AV	Vertical
4880.62	59.07	-3.68	55.39	74.00	-18.61	Pk	Horizontal
4880.62	41.76	-3.68	38.08	54.00	-15.92	AV	Horizontal
7320.47	58.10	-0.82	57.28	74.00	-16.72	Pk	Horizontal
7320.47	41.99	-0.82	41.17	54.00	-12.83	AV	Horizontal
High Channel (2480 MHz)- Above 1G							
4960.95	57.89	-3.59	54.30	74.00	-19.70	Pk	Vertical
4960.95	40.76	-3.59	37.17	54.00	-16.83	AV	Vertical
7440.66	58.07	-0.68	57.39	74.00	-16.61	Pk	Vertical
7440.66	40.07	-0.68	39.39	54.00	-14.61	AV	Vertical
4960.54	58.32	-3.59	54.73	74.00	-19.27	Pk	Horizontal
4960.54	40.40	-3.59	36.81	54.00	-17.19	AV	Horizontal
7440.70	61.76	-0.68	61.08	74.00	-12.92	Pk	Horizontal
7440.70	41.21	-0.68	40.53	54.00	-13.47	AV	Horizontal

Note: (1) All Readings are Peak Value (VBW=3MHz) and Peak Value (VBW=10Hz).

(2) Emission Level= Reading Level+Probe Factor +Cable Loss.

(3)All other emissions more than 20dB below the limit.

EUT:	Bluetooth Beacon	Model Name :	BC08
Temperature:	26 °C	Relative Humidity:	54%
Pressure:	1010 hPa	Test Voltage :	DC3.0V
Test Mode :	GFSK-CH0	Polarization :	Vertical

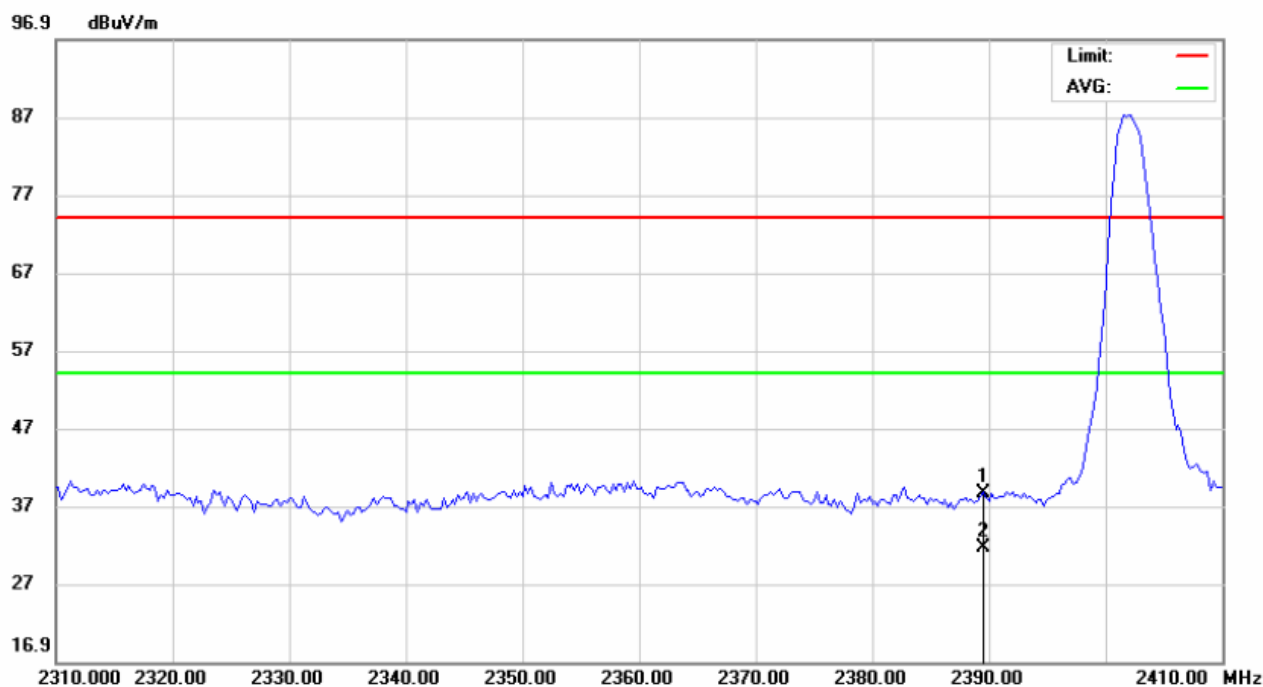

No.	Mk.	Freq. MHz	Reading Level dBuV	Correct Factor dB	Measure- ment dBuV/m	Limit dBuV/m	Over dB	Detector	Antenna Height cm	Table Degree degree	Comment
1		2389.500	47.01	-8.43	38.58	74.00	-35.42	peak			
2	*	2389.500	40.03	-8.43	31.60	54.00	-22.40	AVG			

*:Maximum data x:Over limit l:over margin

EUT:	Bluetooth Beacon	Model Name :	BC08
Temperature:	26 °C	Relative Humidity:	54%
Pressure:	1010 hPa	Test Voltage :	DC3.0V
Test Mode :	GFSK-CH0	Polarization :	Horizontal

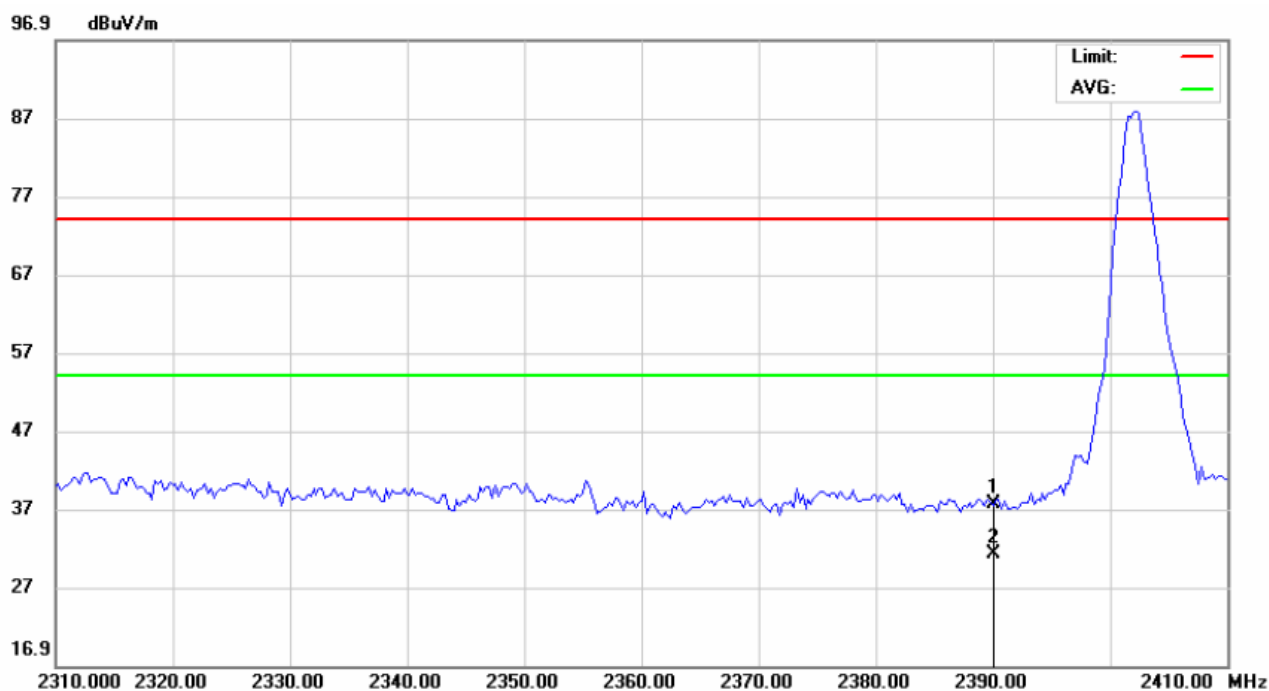

No.	Mk.	Freq.	Reading Level	Correct Factor	Measurement	Limit	Over	Antenna Height	Table Degree
		MHz	dBuV	dB	dBuV/m	dBuV/m	dB	cm	degree
1		2390.000	46.01	-8.43	37.58	74.00	-36.42	peak	
2	*	2390.000	39.58	-8.43	31.15	54.00	-22.85	AVG	

*:Maximum data x:Over limit !:over margin

EUT:	Bluetooth Beacon	Model Name :	BC08
Temperature:	26 °C	Relative Humidity:	54%
Pressure:	1010 hPa	Test Voltage :	DC3.0V
Test Mode :	GFSK-CH39	Polarization :	Vertical

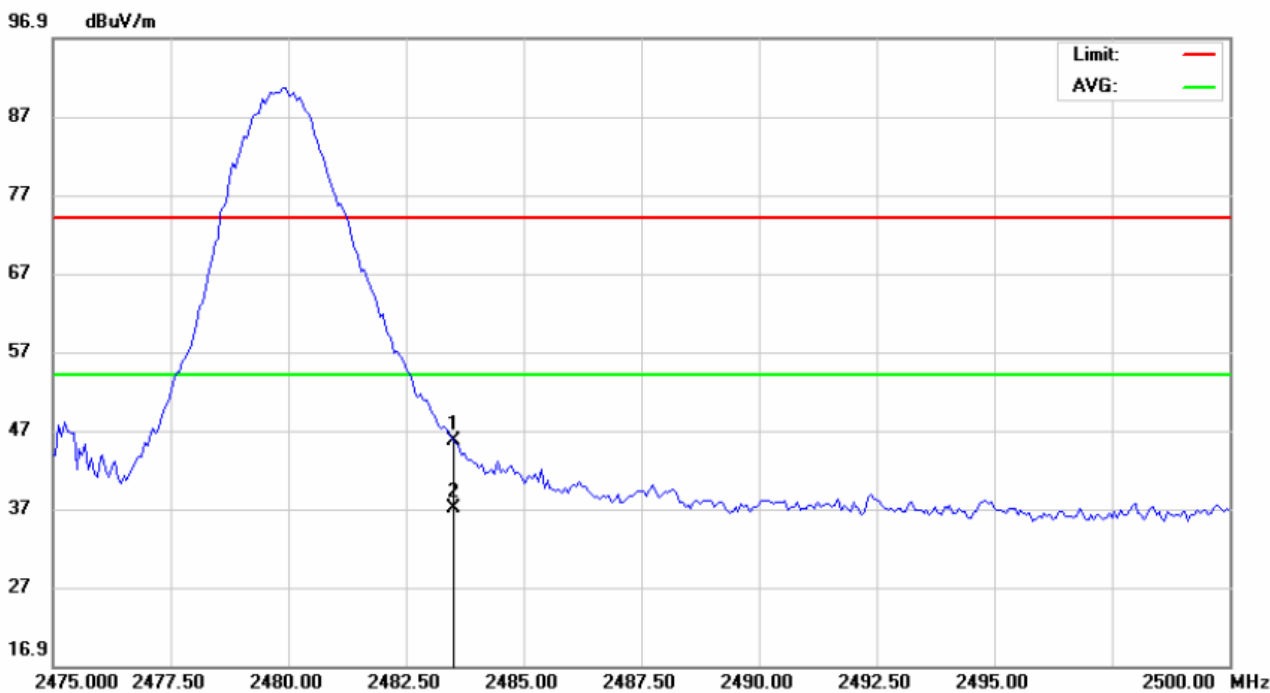

No.	Mk.	Freq. MHz	Reading Level dBuV	Correct Factor dB	Measure- ment dBuV/m	Limit dBuV/m	Over dB	Detector	Antenna Height cm	Table Degree degree	Comment
1		2483.500	53.80	-8.29	45.51	74.00	-28.49	peak			
2	*	2483.500	45.20	-8.29	36.91	54.00	-17.09	AVG			

*:Maximum data x:Over limit l:over margin

EUT:	Bluetooth Beacon	Model Name :	BC08
Temperature:	26 °C	Relative Humidity:	54%
Pressure:	1010 hPa	Test Voltage :	DC3.0V
Test Mode :	GFSK-CH39	Polarization :	Horizontal



No.	Mk.	Freq.	Reading Level	Correct Factor	Measurement	Limit	Over	Antenna Height	Table Degree	
		MHz	dBuV	dB	dBuV/m	dBuV/m	dB	cm	degree	Comment
1		2483.500	59.01	-8.29	50.72	74.00	-23.28			peak
2	*	2483.500	51.70	-8.29	43.41	54.00	-10.59			AVG

*:Maximum data x:Over limit !:over margin

Note: (1) All other emissions more than 20dB below the limit.

4. POWER SPECTRAL DENSITY TEST

4.1 APPLIED PROCEDURES / LIMIT

FCC Part15 (15.247) , Subpart C				
Section	Test Item	Limit	Frequency Range (MHz)	Result
15.247	Power Spectral Density	8 dBm (in any 3KHz)	2400-2483.5	PASS

4.1.1 TEST PROCEDURE

1. Set analyzer center frequency to DTS channel center frequency.
2. Set the span to 1.5 times the DTS channel bandwidth.
3. Set the RBW \geq 3 kHz.
4. Set the VBW \geq 3 x RBW.
5. Detector = peak.
6. Sweep time = auto couple.
7. Trace mode = max hold.
8. Allow trace to fully stabilize.
9. Use the peak marker function to determine the maximum amplitude level.
10. If measured value exceeds limit, reduce RBW (no less than 3 kHz) and repeat.

4.1.2 DEVIATION FROM STANDARD

No deviation.

4.1.3 TEST SETUP



4.1.4 EUT OPERATION CONDITIONS

The EUT tested system was configured as the statements of 2.1 Unless otherwise a special operating condition is specified in the follows during the testing.

4.1.5 TEST RESULTS

EUT:	Bluetooth Beacon	Model Name :	BC08
Temperature:	25 °C	Relative Humidity:	60%
Pressure:	1015 hPa	Test Voltage :	DC3.0V
Test Mode :	TX Mode /CH00, CH19, CH39		

Frequency	Power Density (dBm)	Limit (dBm)	Result
2402 MHz	-7.816	8	PASS
2440 MHz	-5.749	8	PASS
2480 MHz	-6.518	8	PASS

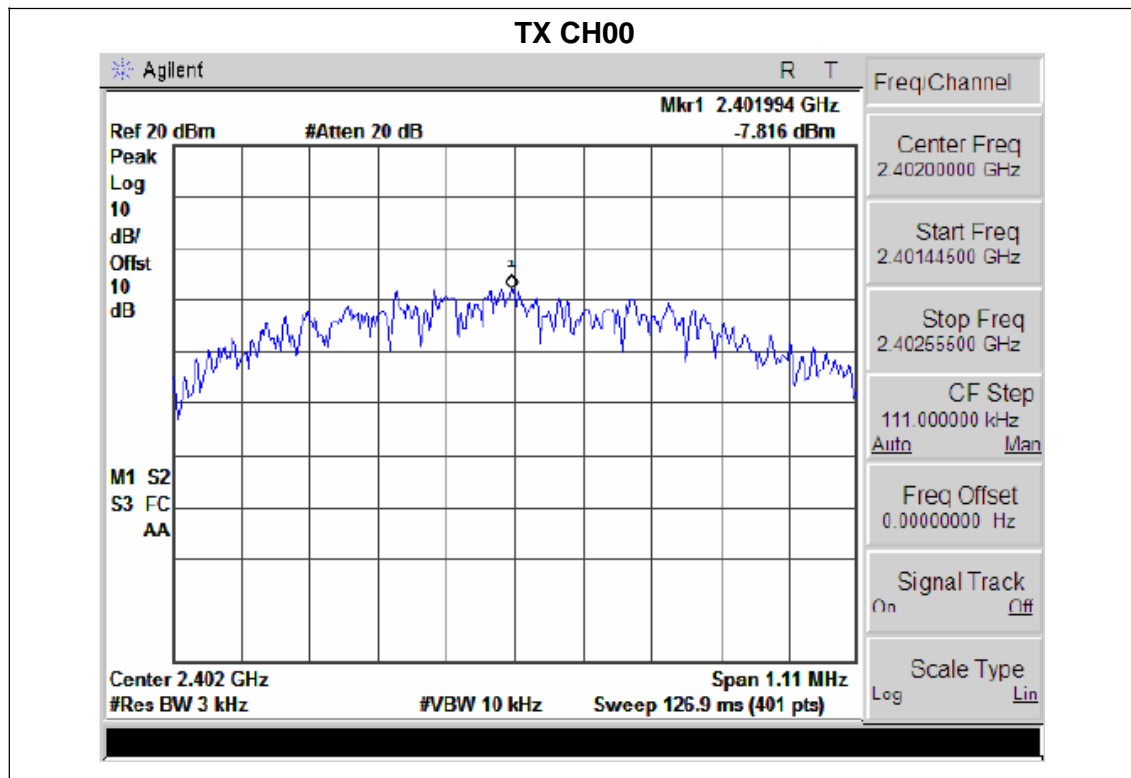

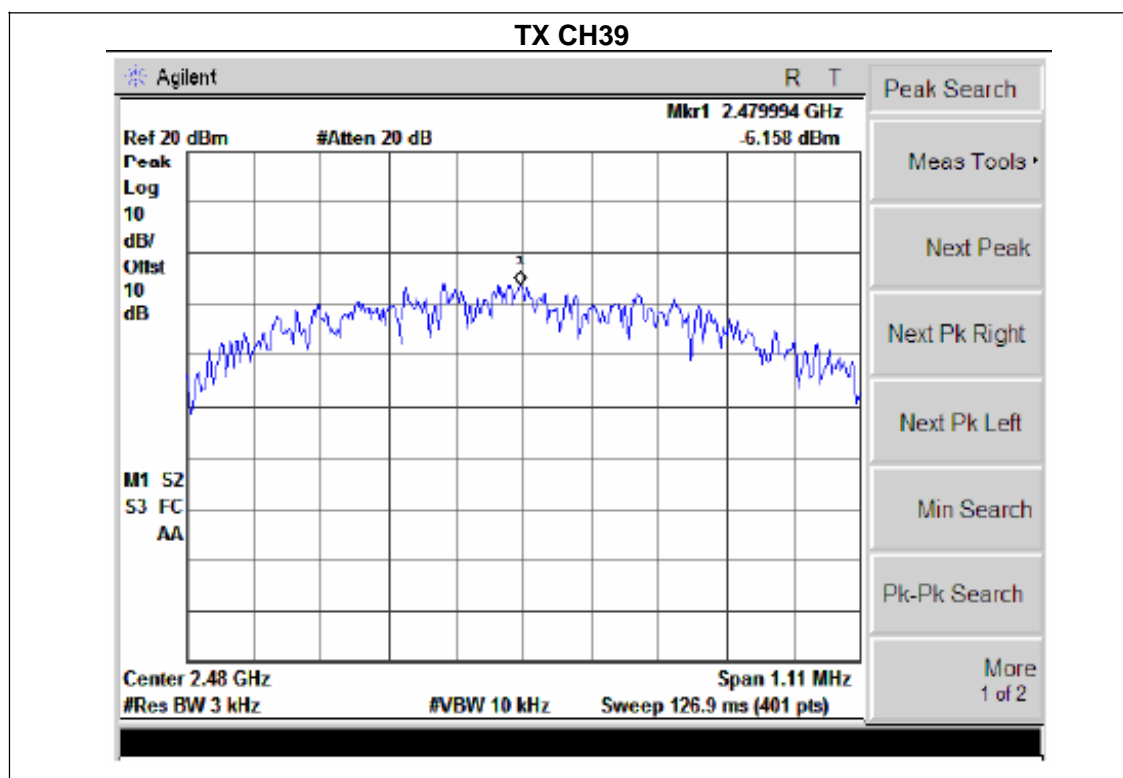
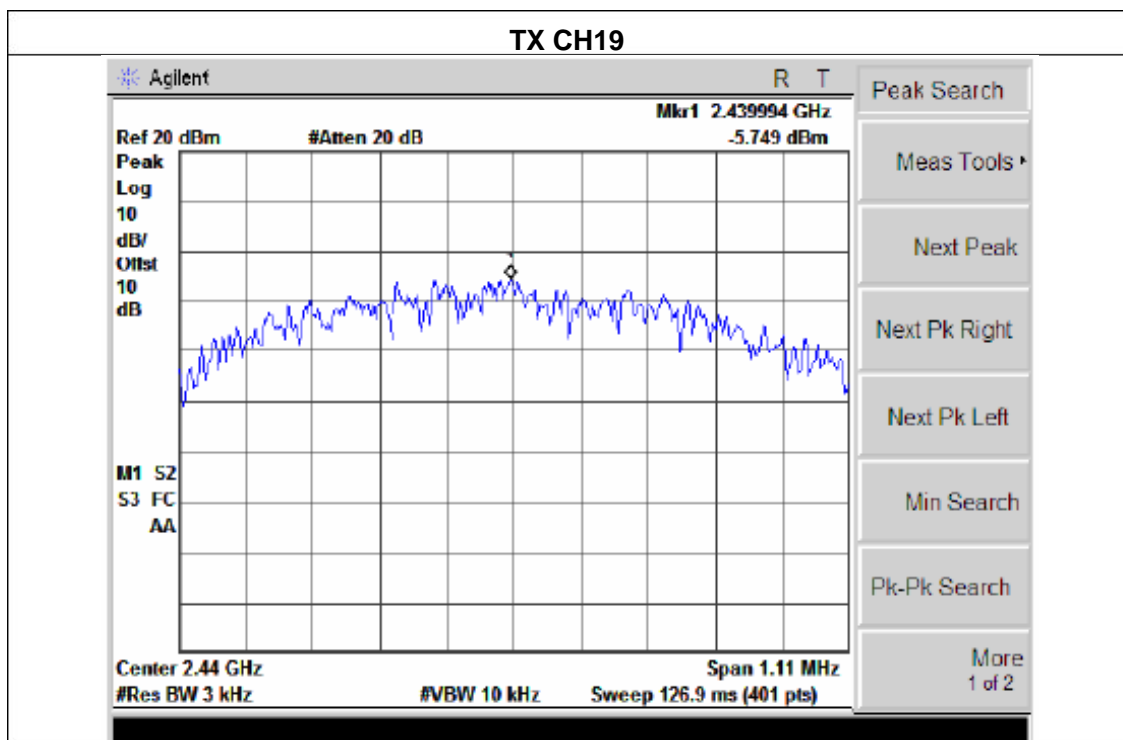

5. BANDWIDTH TEST

5.1 APPLIED PROCEDURES / LIMIT

FCC Part15 (15.247) , Subpart C				
Section	Test Item	Limit	Frequency Range (MHz)	Result
15.247(a)(2)	Bandwidth	$\geq 500\text{KHz}$ (6dB bandwidth)	2400-2483.5	PASS

5.1.1 TEST PROCEDURE

1. Set RBW = 100 kHz.
2. Set the video bandwidth (VBW) $\geq 3 \times$ RBW.
3. Detector = Peak.
4. Trace mode = max hold.
5. Sweep = auto couple.
6. Allow the trace to stabilize.
7. Measure the maximum width of the emission that is constrained by the frequencies associated with the two outermost amplitude points (upper and lower) that are attenuated by 6 dB relative to the maximum level measured in the fundamental emission.

5.1.2 DEVIATION FROM STANDARD

No deviation.

5.1.3 TEST SETUP



5.1.4 EUT OPERATION CONDITIONS

The EUT tested system was configured as the statements of 2.4 Unless otherwise a special operating condition is specified in the follows during the testing.

5.1.5 TEST RESULTS

EUT:	Bluetooth Beacon	Model Name :	BC08
Temperature:	25 °C	Relative Humidity:	60%
Pressure:	1012 hPa	Test Voltage :	DC3.0V
Test Mode :	TX Mode/CH00, CH19, CH39		

Frequency	6dB Bandwidth (kHz)	Channel Separation (MHz)	Result
2402 MHz	681.816	>=500KHz	PASS
2440 MHz	706.845	>=500KHz	PASS
2480 MHz	668.542	>=500KHz	PASS

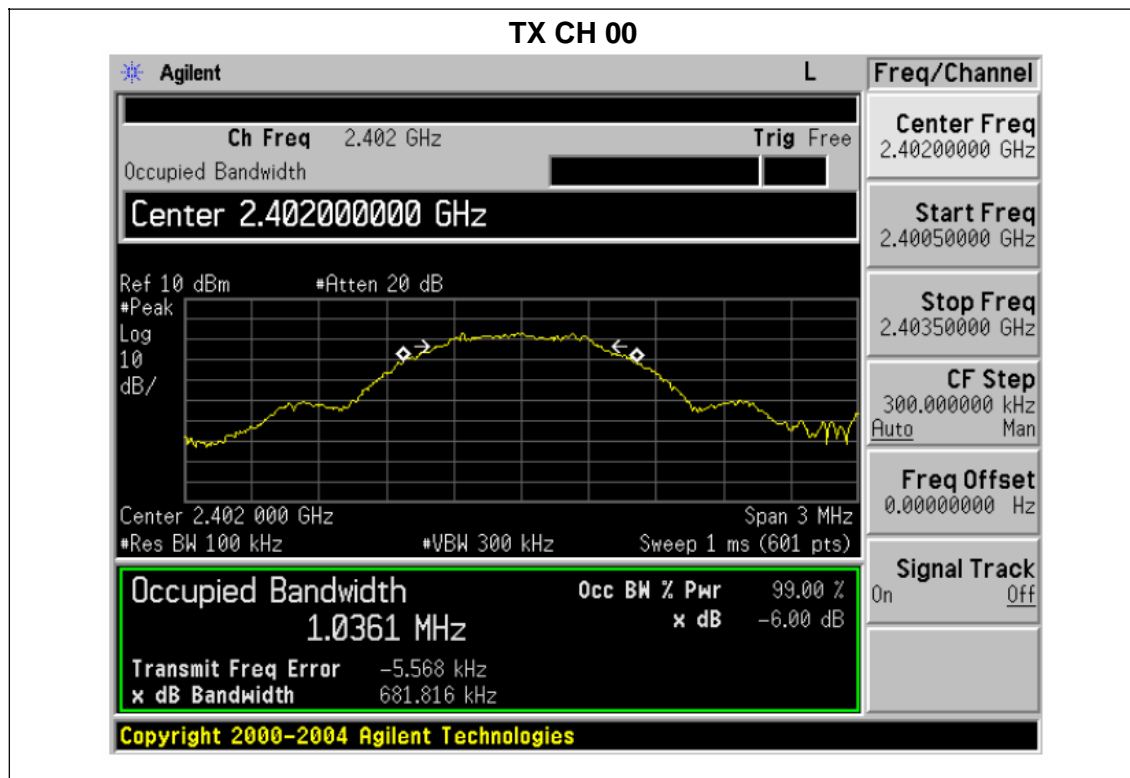

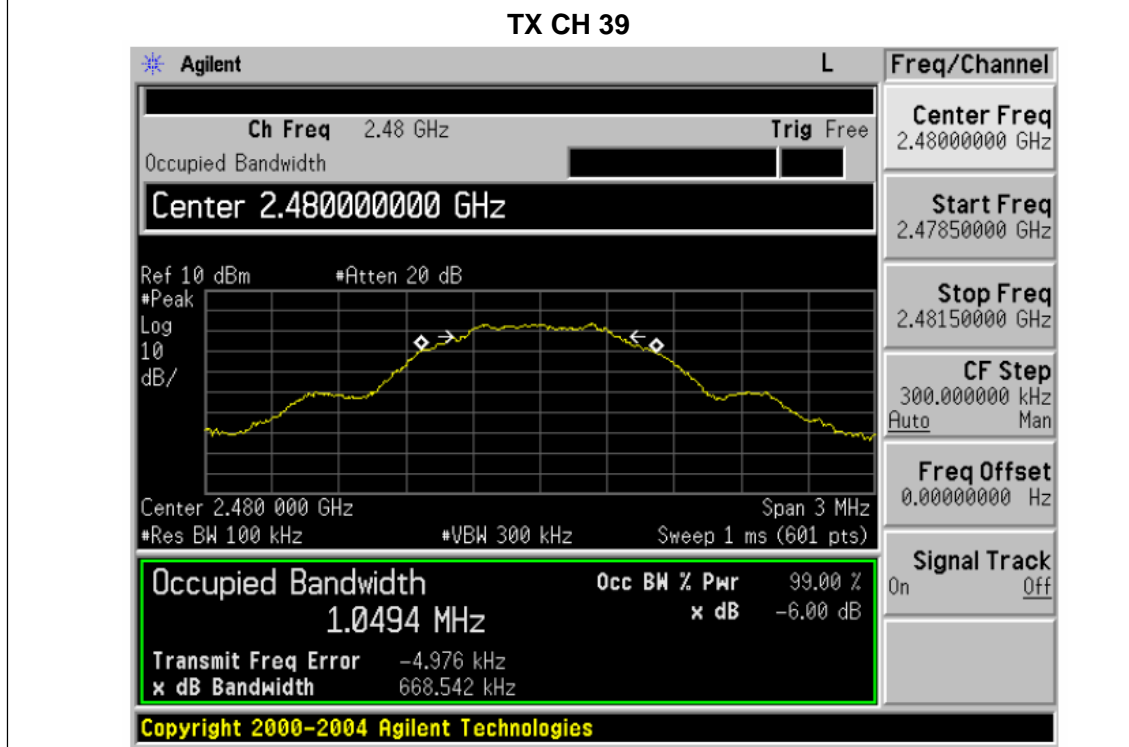
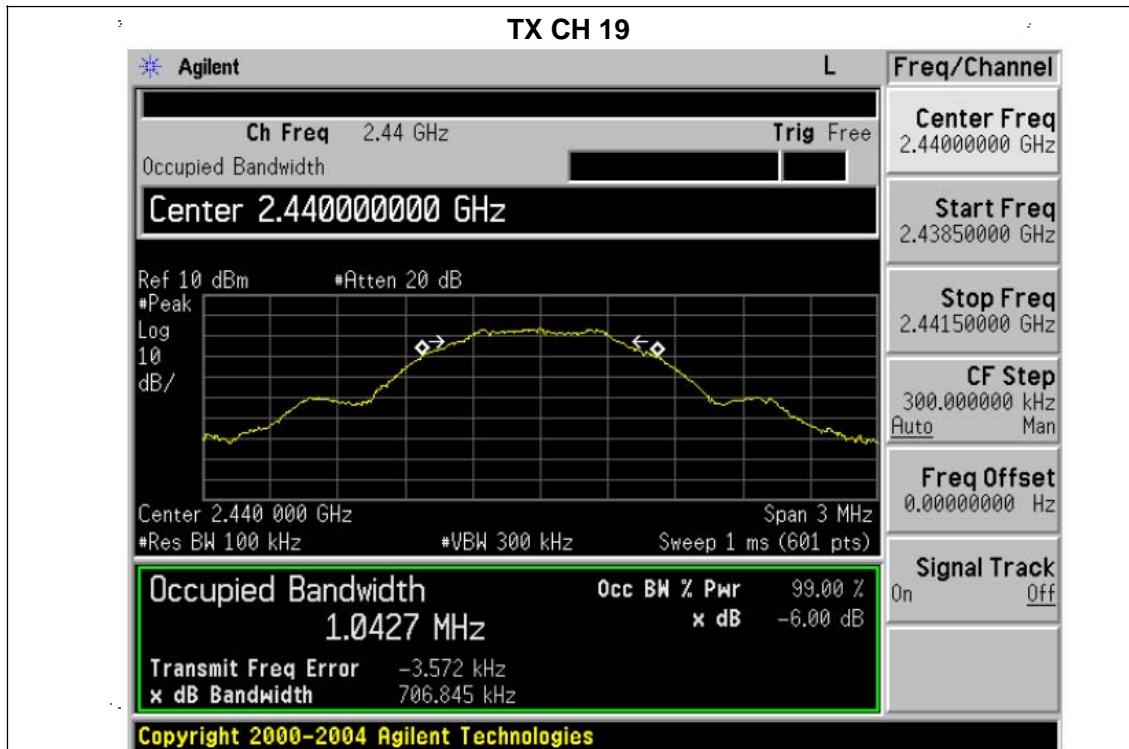

6. PEAK OUTPUT POWER TEST

6.1 APPLIED PROCEDURES / LIMIT

FCC Part15 (15.247) , Subpart C				
Section	Test Item	Limit	Frequency Range (MHz)	Result
15.247(b)(3)	Peak Output Power	1 watt or 30dBm	2400-2483.5	PASS

6.1.1 TEST PROCEDURE

- a. The EUT was directly connected to spectrum analyzer

6.1.2 DEVIATION FROM STANDARD

No deviation.

6.1.3 TEST SETUP



6.1.4 EUT OPERATION CONDITIONS

The EUT tested system was configured as the statements of 2.4 Unless otherwise a special operating condition is specified in the follows during the testing.

6.1.5 TEST RESULTS

EUT:	Bluetooth Beacon	Model Name :	BC08
Temperature:	25 °C	Relative Humidity:	60%
Pressure:	1012 hPa	Test Voltage :	DC3.0V
Test Mode :	TX Mode /CH00, CH19, CH39		

Test Channel	Frequency	Maximum Peak Conducted Output Power	LIMIT
	(MHz)	(dBm)	dBm
CH00	2402	-6.23	30
CH19	2440	-5.69	30
CH39	2480	-5.65	30

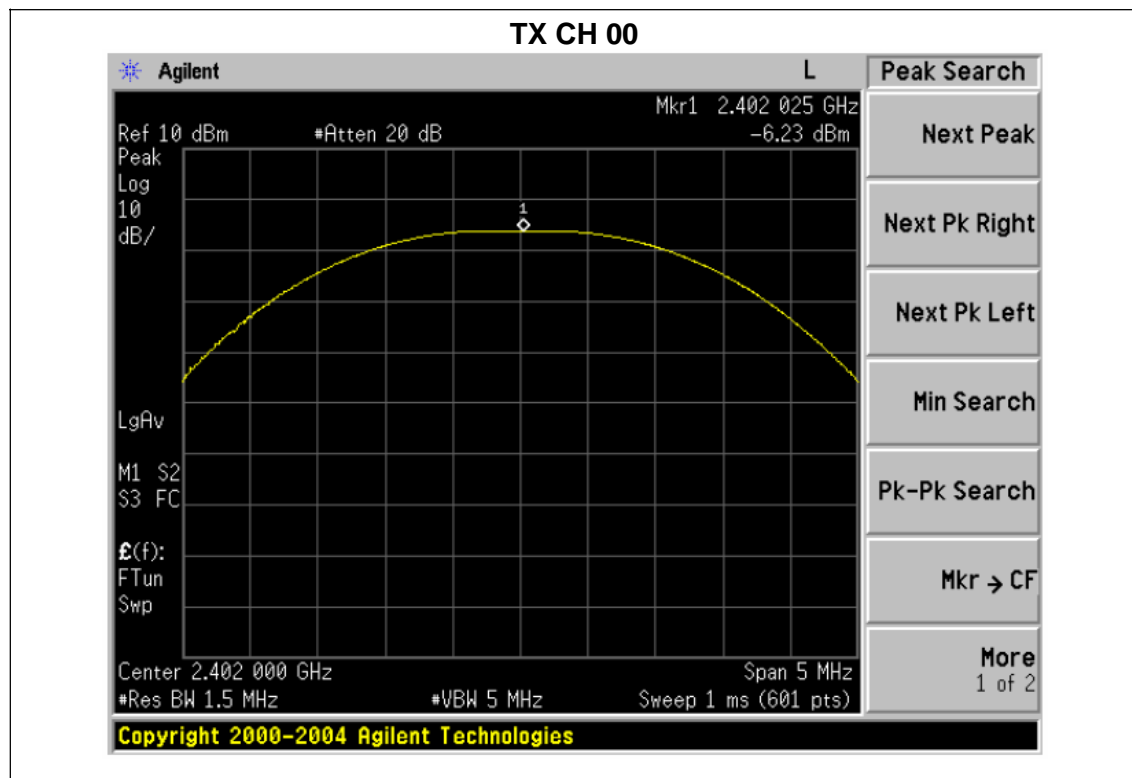

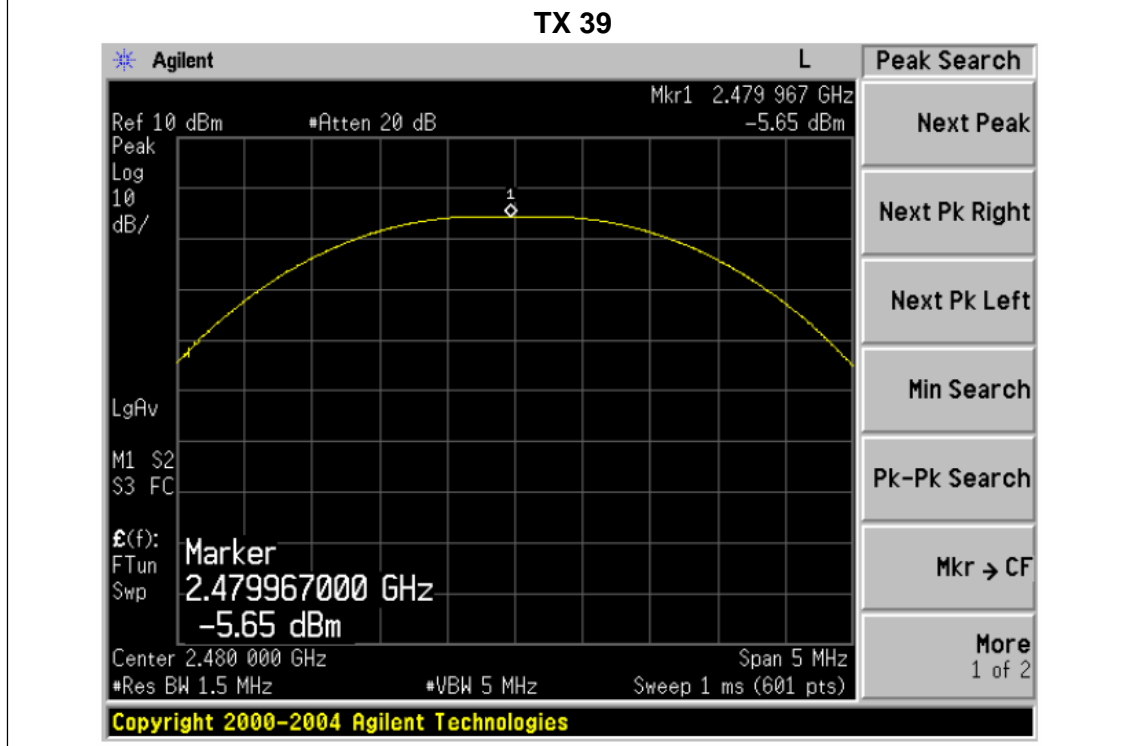
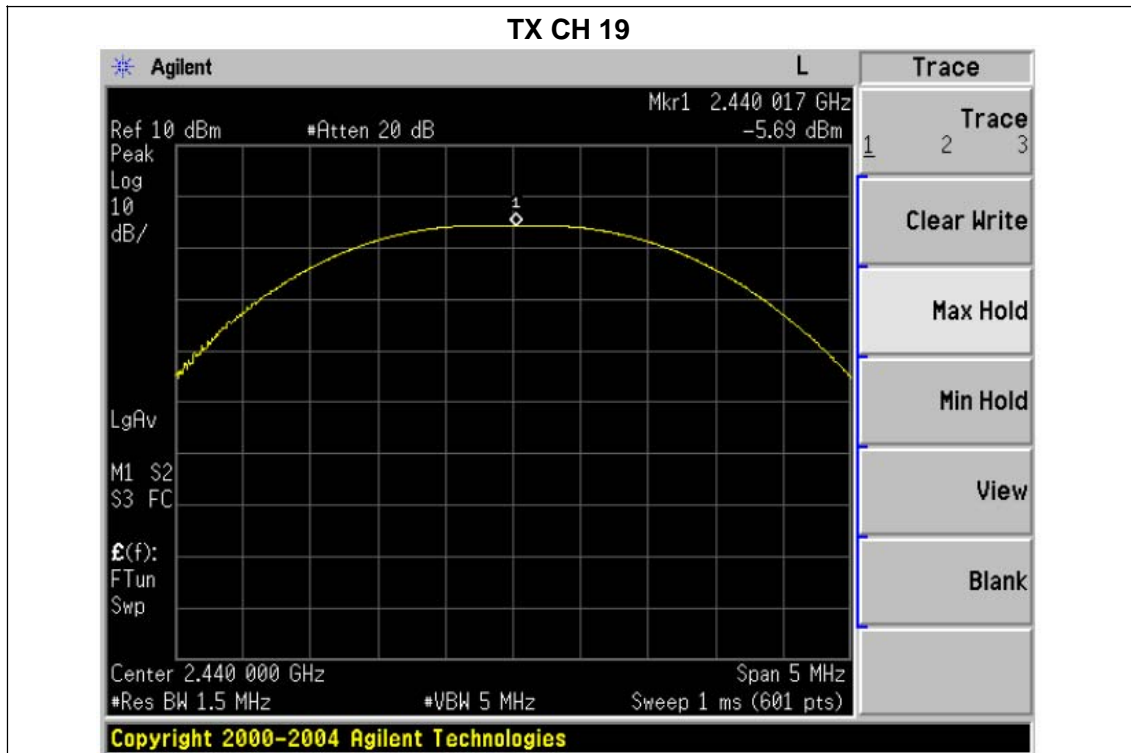

7. ANTENNA REQUIREMENT

7.1 STANDARD REQUIREMENT

15.203 requirement: For intentional device, according to 15.203: an intentional radiator shall be designed to ensure that no antenna other than that furnished by the responsible party shall be used with the device.

7.2 EUT ANTENNA

The EUT antenna is PCB antenna. It comply with the standard requirement.

8. EUT TEST PHOTO

Radiated Measurement Photos

