



Report No.: AAEMT/RF/230809-01-04

FCC RADIO TEST REPORT

Part 15 subpart E

FCC ID: 2AM8R-D450

Report Reference No.....: AAEMT/RF/230809-01-04

Date of issue.....: 2023-11-09

Testing Laboratory: AA Electro Magnetic Test Laboratory Private Limited

Address: Plot No 174, Udyog Vihar - Phase 4, Sector 18,
Gurgaon, Haryana, India

Applicant's name: Netradyne Inc

Address: 9171 Towne Centre Drive Suite 110 San Diego, CA 92122

Manufacturer.....: Netradyne Inc
9171 Towne Centre Drive Suite 110 San Diego, CA 92122

Test item description: Driveri

Trade Mark: 

Model/Type reference: D-450

Ratings.....: **Input : 12VDC, 3A**

Prepared By: (+ signature) Ankur Kumar 

Reviewed & Approved by: (+ signature) 
Dr. Lenin Raja (Authorized Representative) (/ lenin83/)

TABLE OF CONTENTS

1.	Summary of test results	5
2.	General test information	6
2.1.	Description of EUT	6
2.2.	Accessories of EUT.....	7
2.3.	Assistant equipment used for test	7
3.	Equipment's List for All Test Items	8
3.1.	Block diagram of EUT configuration for test	10
3.2.	Test environment conditions	10
3.3.	Measurement uncertainty	10
4.	POWER SPECTRAL DENSITY TEST	11
4.1.	Block diagram of test setup	11
4.2.	Applied procedures / limit	11
4.3.	Test Procedure.....	12
4.4.	Test Result:	13
5.	26 dB & 99% Emission Bandwidth.....	33
5.1.	Block diagram of test setup	33
5.2.	Applied procedures / limit	33
5.3.	Test Procedure.....	33
5.4.	Test Result	34
6.	MAXIMUM CONDUCTED OUTPUT POWER.....	71
6.1.	Test Result	72
7.	Band Edges Measurement	73
7.1.	Test Result	74
8.	RADIATED EMISSION MEASUREMENT	85
8.1.	Block diagram of test setup	85
8.2.	Limit.....	87
8.3.	Test Procedure.....	88
8.4.	Test result(Below 30MHz).....	90
9.	Power Line Conducted Emission.....	104
9.1.	Block diagram of test setup	104
9.2.	Power Line Conducted Emission Limits.....	104
9.3.	Test Procedure.....	105



Report No.: AAEMT/RF/230809-01-04

9.4. Test Result105

10. Conducted Spurious Emissions.....108

11. Antenna Requirements121

11.1. Limit.....121

11.2. EUT ANTENNA121



Report No.: AAEMT/RF/230809-01-04

TEST REPORT DECLARE

Applicant	:	Netradyne Inc
Address	:	9171 Towne Centre Drive Suite 110 San Diego, CA 92122
Equipment under Test	:	Driveri
Model No	:	D-450
Trade Mark	:	 netradyne
Manufacturer	:	Netradyne Inc
Address	:	9171 Towne Centre Drive Suite 110 San Diego, CA 92122

Test Standard Used: FCC Part 15E 15.407

Test procedure used: ANSI C63.10-2013 and KDB 789033 D02 General UNII Test Procedures New Rules v02r01 .

We Declare:

The equipment described above is tested by AA Electro Magnetic Test Laboratory Private Limited and in the configuration tested the equipment complied with the standards specified above. The test results are contained in this test report and AA Electro Magnetic Test Laboratory Private Limited is assumed of full responsibility for the accuracy and completeness of these tests.

After test and evaluation, our opinion is that the equipment provided for test compliance with the requirement of the above FCC standards.

Report No:	AAEMT/RF/230809-01-04		
Date of Test:	Aug 10, 2023 ~ Oct. 04, 2023	Date of Report:	Nov. 09, 2023

Note: This report applies to above tested sample only. This report shall not be reproduced in parts without written approval of AA Electro Magnetic Test Laboratory Private Limited

Report No.: AAEMT/RF/230809-01-04

1. SUMMARY OF TEST RESULTS

The EUT have been tested according to the applicable standards as referenced below.		
FCC Part15 (15.407) , Subpart E		
Description of Test Item	Standard	Results
AC Power Line Conducted Emissions	FCC §15.207/ RSS-Gen	PASS
Spurious Radiated Emissions	FCC §15.209(a), 15.407(b)	PASS
26 dB and 99% Emission Bandwidth	FCC §15.407(a)	PASS
Maximum Conducted Output Power	FCC §407(a) (1)	PASS
Band Edges	FCC §2.1051, §15.407(b)	PASS
Power Spectral Density	FCC §15.407(a)(1)	PASS
Spurious Emissions at Antenna Terminals	FCC §2.1051, §15.407(b)	PASS
Antenna Requirement	FCC §15.203	PASS

2. GENERAL TEST INFORMATION

2.1. DESCRIPTION OF EUT

EUT Name	: Driveri
Model Number	: D-450
Derivative model No.:	: D-450A, D-455
Power supply	: 12VDC, 3A
Operation frequency	: WiFi: 802.11a/n(HT20)/ac(VHT20): 5180MHz~5240MHz; 5745MHz~5825MHz 802.11n(HT40)/ac(VHT40): 5190MHz~5230MHz; 5755MHz~5795MHz 802.11ac(VHT80):5210MHz; 5775MHz
Modulation	: 802.11a/n: BPSK/QPSK/16QAM/64QAM 802.11ac: BPSK/QPSK/16QAM/64QAM/256QAM/1024QAM
Data Rate	: 802.11a:6,9,12,18,24,36,48,54Mbps; 802.11ac(VHT20):MCS0-MCS8 802.11ac(VHT40/80):MCS0-MCS11 802.11n(HT20):MCS0-MCS7; 802.11n(HT40):MCS0-MCS7;
Antenna Type	: Flexible PCB Antenna
Antenna gain	: -1.8 dBi
H/W No.	: 103-00-00005
S/W No.	: 13.0.16
Battery	: N/A
Date of Receipt	: Aug. 09, 2023
Condition of Sample on receipt	: Good
Note:	1 .For a more detailed features description, please refer to the manufacturer's specifications or the User's Manual. 2. Antenna gain and antenna type provided by manufacturer.
Opinions and Interpretations:	: See the specific Note / Annexure if any in the whole /full report.

Report No.: AAEMT/RF/230809-01-04

Channel List							
802.11a/n/ac (20MHz)							
Channel	Frequency (MHz)	Channel	Frequency (MHz)	Channel	Frequency (MHz)	Channel	Frequency (MHz)
36	5180	40	5200	44	5220	48	5240
149	5745	153	5765	157	5785	161	5805
165	5825	--	--	--	--	--	--
802.11n/ac (40MHz)							
Channel	Frequency (MHz)	Channel	Frequency (MHz)	Channel	Frequency (MHz)	Channel	Frequency (MHz)
38	5190	46	5230	151	5755	159	5795
802.11ac (80MHz)							
Channel	Frequency (MHz)	Channel	Frequency (MHz)	Channel	Frequency (MHz)	Channel	Frequency (MHz)
42	5210	-	-	-	-	155	5775

2.2. ACCESSORIES OF EUT

Description of Accessories	Shielded Type	Ferrite Core	Length
Driveri/DCM LTE Module	N/A	N/A	N/A

2.3. ASSISTANT EQUIPMENT USED FOR TEST

Description of Assistant equipment	Manufacturer	Model number or Type	EMC Compliance	SN
Laptop	DELL	Latitude 3490	-	5M2Z1W2

3. EQUIPMENT'S LIST FOR ALL TEST ITEMS

No	Test Equipment	Manufacturer	Model No	Serial No	Cal. Date	Cal.Due Date
1	Spectrum Analyzer	Rohde and Schwarz	FSP	101163	2022/02/08	2024/02/07
2	Loop antenna	DAZE Beijing	ZN30900C	18052	2021/09/15	2024/09/15
3	Hi power horn antenna	DAZE Beijing	ZN30700	18012	2021/09/15	2024/09/15
4	MXA Signal Analyzer	Keysight	N9020A	6272323218	2023/07/25	2025/07/25
5	Horn antenna	DAZE Beijing	ZN30703	18005	2021/09/15	2024/09/15
6	Pre amplifier	KELIANDA	LNA-0009295	-	2023/01/13	2024/01/13
7	Pre amplifier	KELIANDA	CF-00218	-	2023/01/13	2024/01/13
8	Biconical Antenna	DAZE Beijing	ZN30505C	17038	2021/09/15	2024/09/15
9	EMI-RECEIVER	Schwarzbeck	FCKL	1528194	2023/01/13	2024/01/13
10	LISN	Kyoritsu	KNW-407	8-1789-5	2023/01/13	2024/01/13
11	Network-LISN	SCHWARZBECK	NNBM8125	81251314	2023/01/13	2024/01/13
12	Network-LISN	SCHWARZBECK	NNBM8125	81251315	2023/01/13	2024/01/13
13	PULSELIMITER	Rohde and Schwarz	ESH3-Z2	100681	2023/01/13	2024/01/13
14	50Ω Coaxial Switch	DAIWA	1565157	-	2023/01/13	2024/01/13
15	50Ω Coaxial Switch	-	-	-	2023/01/13	2024/01/13
16	Wireless signal power meter	DARE!!	RPR3006W	RFSW190220	2023/01/13	2024/01/13
17	Signal Generator	KEYSIGHT	N5181A	512071	2023/01/13	2024/01/13

Report No.: AAEMT/RF/230809-01-04

18	RF Vector Signal Generator	Keysight	N5182B	512094	2023/01/13	2024/01/13
19	Spectrum analyzer	R&S	FSV-40N	101385	2023/01/13	2024/01/13
20	Radio Communication Tester	R&S	CMW 500	124589	2021/09/15	2024/09/15
21	Signal Generator	R&S	SMP02	837017/004 836593/005	2021/09/15	2024/09/15
22	DC Regulated Power Supply	Metravi	RPS-3005	669076	2022/12/13	2023/12/12
23	Climatic Chamber	Sunrise Scientific Instruments	-	-	2022/11/22	2023/11/21
24	Attenuators	AGILENT	8494B	-	-	-
25	Attenuators	AGILENT	8495B	-	-	-

Report No.: AAEMT/RF/230809-01-04

3.1. BLOCK DIAGRAM OF EUT CONFIGURATION FOR TEST

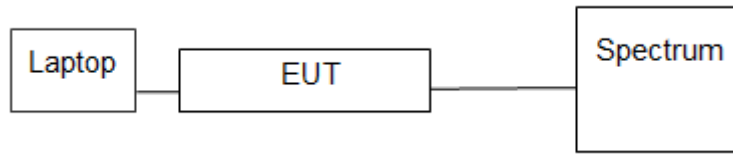

3.2. TEST ENVIRONMENT CONDITIONS

During the measurement the environmental conditions were within the listed ranges:

Temperature range:	21-25°C
Humidity range:	40-75%
Pressure range:	86-106kPa

3.3. MEASUREMENT UNCERTAINTY

No.	Item	Uncertainty
1	Conducted Emission Test	2.70dB
2	Radiated Emission Test	3.09dB
3	RF power, conducted	2.46dB
4	RF power density, conducted	2.24dB
5	Spurious emissions, conducted	2.71dB
6	All emissions, radiated(<1G)	3.08dB
7	All emissions, radiated(>1G)	3.09dB

Note: This uncertainty represents an expanded uncertainty expressed at approximately the 95% confidence level using a coverage factor of k=2.

4. POWER SPECTRAL DENSITY TEST

4.1. BLOCK DIAGRAM OF TEST SETUP

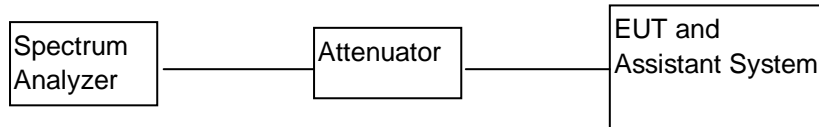

4.2. APPLIED PROCEDURES / LIMIT

According to FCC §15.407(a)(3)

For the band 5.15-5.25 GHz,

(i) For an outdoor access point operating in the band 5.15-5.25 GHz, the maximum power spectral density shall not exceed 17 dBm in any 1 megahertz band. If transmitting antennas of directional gain greater than 6 dBi are used, both the maximum conducted output power and the maximum power spectral density shall be reduced by the amount in dB that the directional gain of the antenna exceeds 6 dBi. The maximum e.i.r.p. at any elevation angle above 30 degrees as measured from the horizon must not exceed 125 mW (21 dBm).

(ii) For an indoor access point operating in the band 5.15-5.25 GHz, the maximum power spectral density shall not exceed 17 dBm in any 1 megahertz band. If transmitting antennas of directional gain greater than 6 dBi are used, both the maximum conducted output power and the maximum power spectral density shall be reduced by the amount in dB that the directional gain of the antenna exceeds 6 dBi.

(iii) For fixed point-to-point access points operating in the band 5.15-5.25 GHz, the maximum power spectral density shall not exceed 17 dBm in any 1 megahertz band. Fixed point-to-point U-NII devices may employ antennas with directional gain up to 23 dBi without any corresponding reduction in the maximum conducted output power or maximum power spectral density. For fixed point-to-point transmitters that employ a directional antenna gain greater than 23 dBi, a 1 dB reduction in maximum conducted output power and maximum power spectral density is required for each 1 dB of antenna gain in excess of 23 dBi. Fixed, point-to-point operations exclude the use of point-to-multipoint systems, omni directional applications, and multiple collocated transmitters transmitting the same information. The operator of the U-NII device, or if the equipment is professionally installed, the installer, is responsible for ensuring that systems employing high gain directional antennas are used exclusively for fixed, point-to-point operations.

(iv) For mobile and portable client devices in the 5.15-5.25 GHz band, the maximum power spectral density shall not exceed 11 dBm in any 1 megahertz band. If transmitting antennas of directional gain greater than 6 dBi are used, both the maximum conducted output power and the maximum power spectral density shall be reduced by the amount in dB that the directional gain of the antenna exceeds 6 dBi.

For the band 5.725-5.85 GHz

For the band 5.725-5.85 GHz, the maximum power spectral density shall not exceed 30 dBm in any 500-kHz band. If transmitting antennas of directional gain greater than 6 dBi are used, both the maximum conducted output power and the maximum power spectral density shall be reduced by the amount in dB that the directional gain of the antenna exceeds 6 dBi..

4.3. TEST PROCEDURE

(For devices operating in the bands 5.15-5.25 GHz, 5.25-5.35 GHz, and 5.47-5.725 GHz, the above procedures make use of 1 MHz RBW to satisfy directly the 1 MHz reference bandwidth specified in § 15.407(a)(5). For devices operating in the band 5.725-5.85 GHz, the rules specify a measurement bandwidth of 500 kHz. Many spectrum analyzers do not have 500 kHz RBW, thus a narrower RBW may need to be used. The rules permit the use of a RBWs less than 1 MHz, or 500 kHz, “provided that the measured power is integrated over the full reference bandwidth” to show the total power over the specified measurement bandwidth (i.e., 1 MHz, or 500 kHz). If measurements are performed using a reduced resolution bandwidth (< 1 MHz, or < 500 kHz) and integrated over 1 MHz, or 500 KHz bandwidth, the following adjustments to the procedures apply:

- a) Set $RBW \geq 1/T$, where T is defined in section II.B.1.a).
- b) Set $VBW \geq 3$ RBW.
- c) If measurement bandwidth of Maximum PSD is specified in 500 kHz, add $10\log(500\text{kHz}/RBW)$ to the measured result, whereas RBW (< 500 KHz) is the reduced resolution bandwidth of the spectrum analyzer set during measurement.
- d) If measurement bandwidth of Maximum PSD is specified in 1 MHz, add $10\log(1\text{MHz}/RBW)$ to the measured result, whereas RBW (< 1 MHz) is the reduced resolution bandwidth of spectrum analyzer set during measurement.
- e) Care must be taken to ensure that the measurements are performed during a period of continuous transmission or are corrected upward for duty cycle.

Note: As a practical matter, it is recommended to use reduced RBW of 100 KHz for the sections 5.c) and 5.d) above, since RBW=100 KHZ is available on nearly all spectrum analyzers.

Report No.: AAEMT/RF/230809-01-04

4.4. TEST RESULT:

CH. No.	Frequency	power density (dBm/MHz)	Limit (dBm/MHz)	Result
TX 802.11a Mode				
CH36	5180	8.30	11	Pass
CH40	5200	8.90	11	Pass
CH48	5240	7.98	11	Pass
TX 802.11n20 Mode				
CH36	5180	6.75	11	Pass
CH40	5200	7.25	11	Pass
CH48	5240	6.69	11	Pass
TX 802.11n40 Mode				
CH38	5190	8.04	11	Pass
CH46	5230	7.51	11	Pass
TX 802.11ac20 Mode				
CH36	5180	8.47	11	Pass
CH40	5200	7.72	11	Pass
CH48	5240	7.34	11	Pass
TX 802.11ac40 Mode				
CH38	5190	5.25	11	Pass
CH46	5230	5.47	11	Pass
TX 802.11ac80 Mode				
CH42	5210	1.43	11	Pass

Report No.: AAEMT/RF/230809-01-04

TEST RESULT

CH. No.	Frequency	power density (dBm/500KHz)	Limit (dBm/500KHz)	Result
TX 802.11a Mode				
CH 149	5745	11.06	30	Pass
CH 157	5785	9.74	30	Pass
CH 165	5825	10.01	30	Pass
TX 802.11n20 Mode				
CH 149	5745	11.53	30	Pass
CH 157	5785	11.46	30	Pass
CH 165	5825	11.80	30	Pass
TX 802.11n40 Mode				
CH151	5755	7.39	30	Pass
CH159	5795	7.04	30	Pass
TX 802.11ac20 Mode				
CH 149	5745	7.20	30	Pass
CH 157	5785	7.11	30	Pass
CH 165	5825	7.20	30	Pass
TX 802.11ac40 Mode				
CH151	5755	3.74	30	Pass
CH159	5795	4.07	30	Pass
TX 802.11ac80 Mode				
CH155	5775	0.12	30	Pass

Report No.: AAEMT/RF/230809-01-04

Test plots as followed



Report No.: AAEMT/RF/230809-01-04

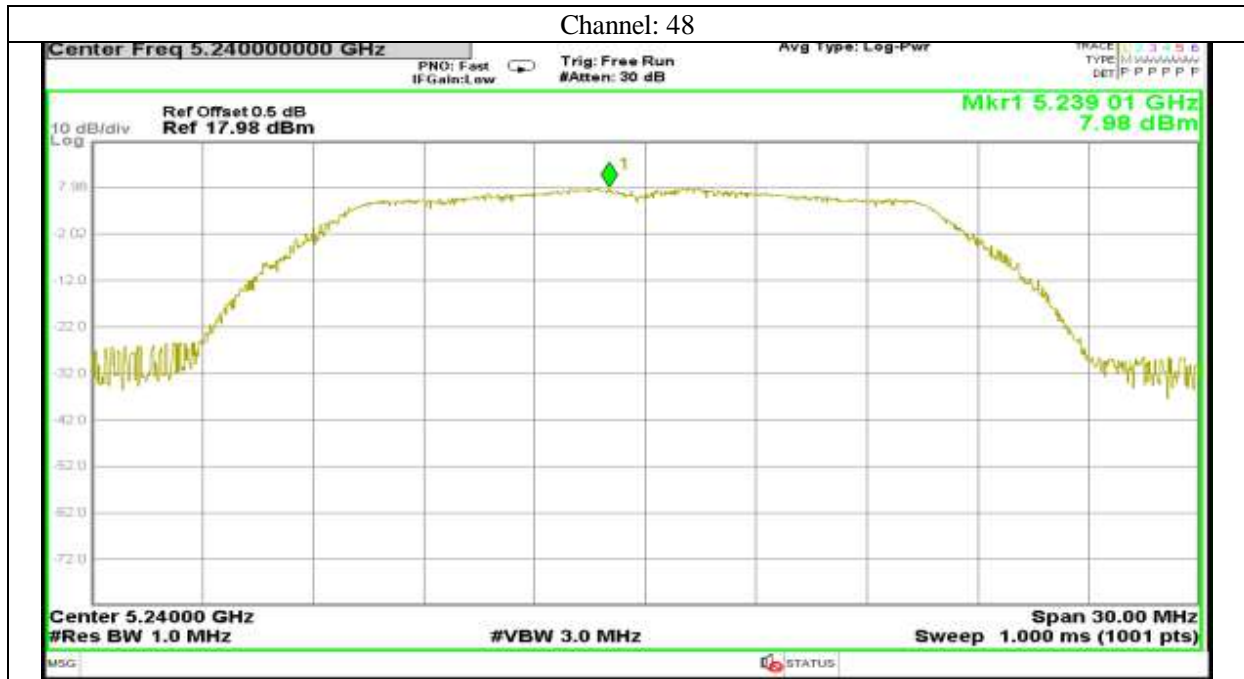

Report No.: AAEMT/RF/230809-01-04



Report No.: AAEMT/RF/230809-01-04



Report No.: AAEMT/RF/230809-01-04

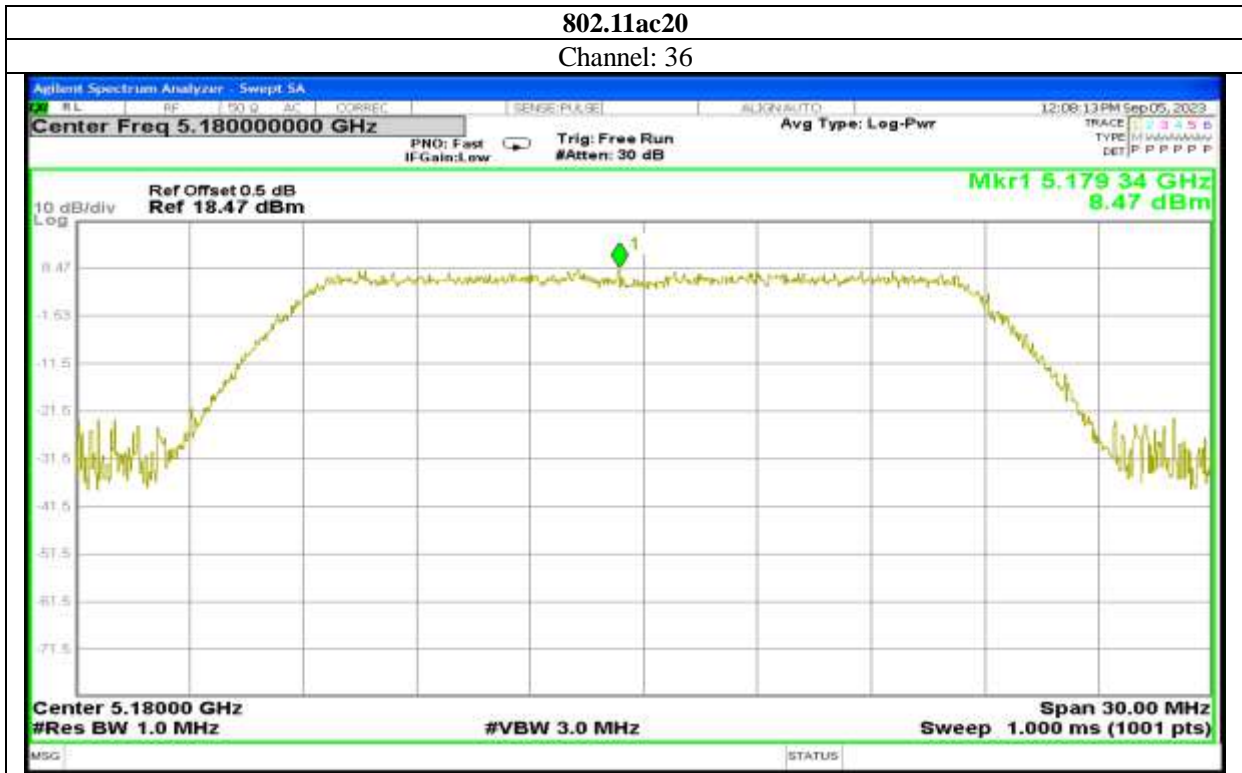

Report No.: AAEMT/RF/230809-01-04

Channel: 48



Report No.: AAEMT/RF/230809-01-04



Report No.: AAEMT/RF/230809-01-04

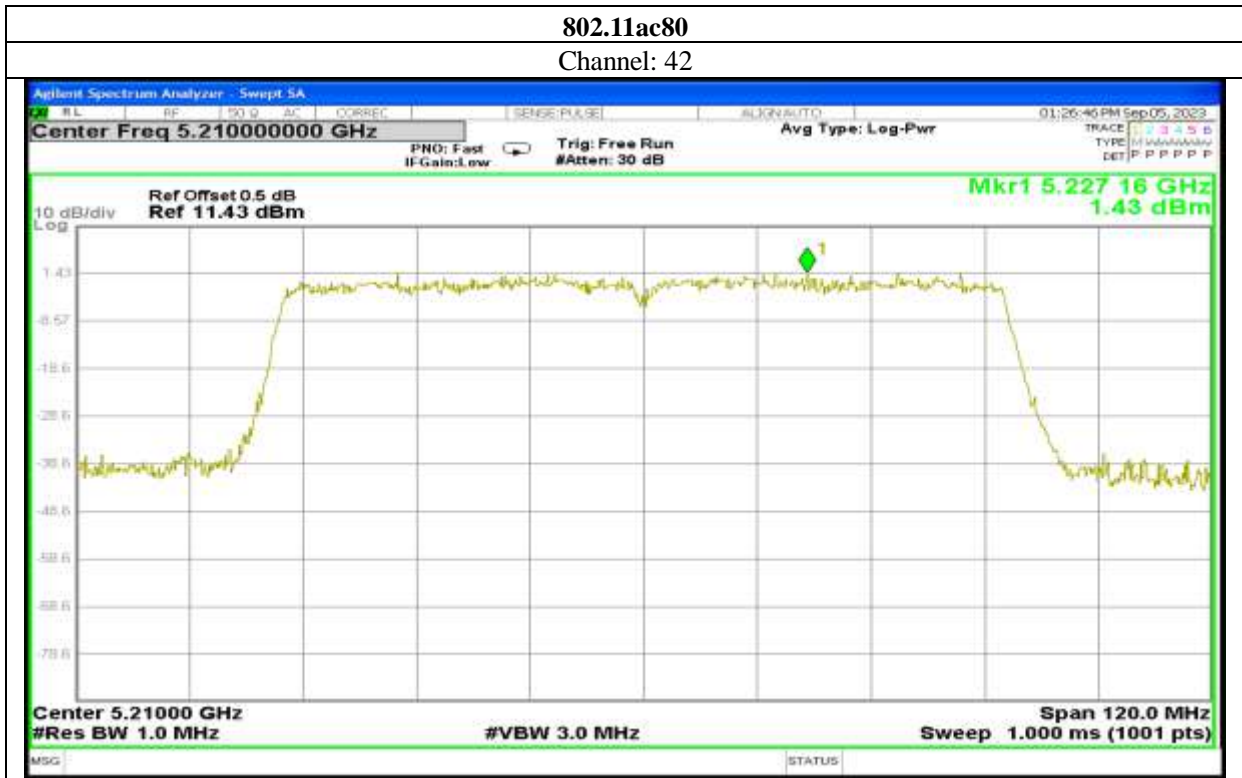

Report No.: AAEMT/RF/230809-01-04

Test plots as followed:

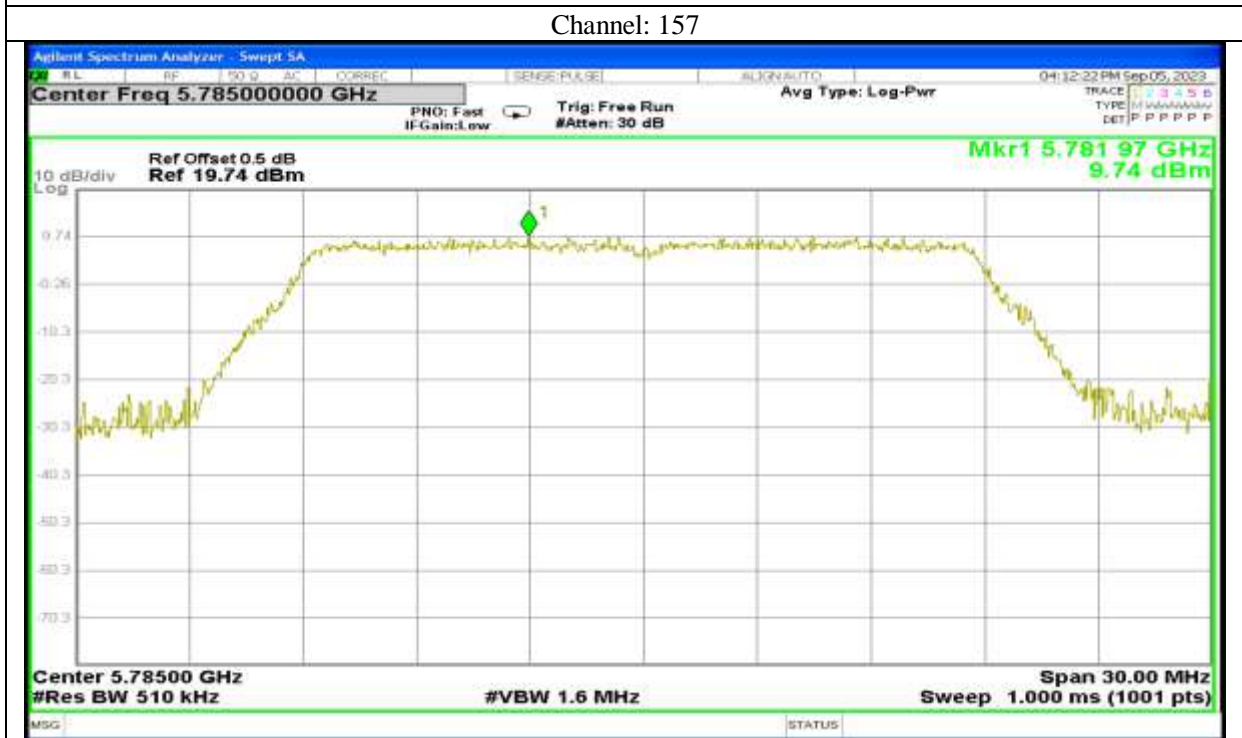

Report No.: AAEMT/RF/230809-01-04

Channel: 165



Report No.: AAEMT/RF/230809-01-04



Report No.: AAEMT/RF/230809-01-04

Channel: 165



Report No.: AAEMT/RF/230809-01-04



Channel: 159



Report No.: AAEMT/RF/230809-01-04



Channel: 157



Report No.: AAEMT/RF/230809-01-04

Channel: 165



Report No.: AAEMT/RF/230809-01-04



Channel: 159



Report No.: AAEMT/RF/230809-01-04

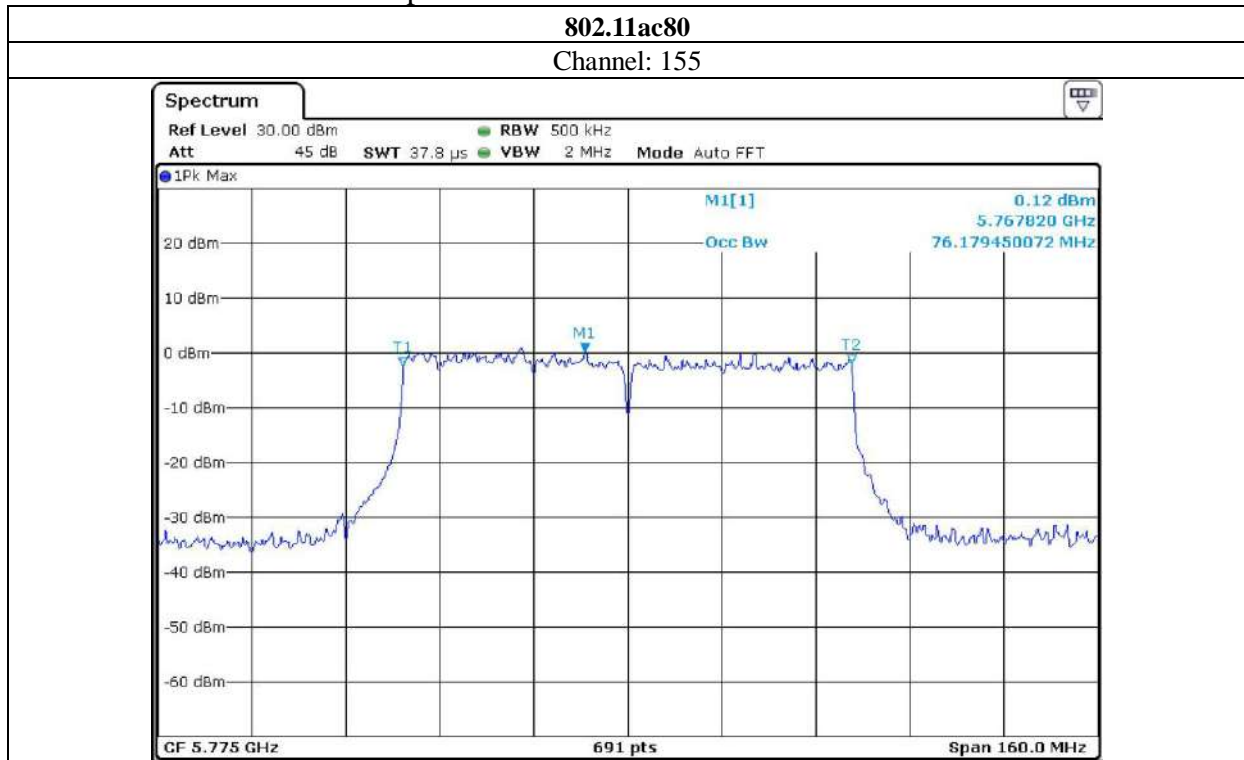

Report No.: AAEMT/RF/230809-01-04

5. 26 dB & 99% Emission Bandwidth

5.1. BLOCK DIAGRAM OF TEST SETUP

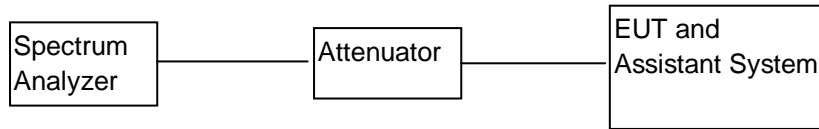

5.2. APPLIED PROCEDURES / LIMIT

The maximum power spectral density is measured as a conducted emission by direct connection of a calibrated test instrument to the equipment under test. If the device cannot be connected directly, alternative techniques acceptable to the Commission may be used. Measurements in the 5.725-5.85 GHz band are made over a reference bandwidth of 500 kHz or the 26 dB emission bandwidth of the device, whichever is less. Measurements in the 5.15-5.25 GHz, 5.25-5.35 GHz, and the 5.47-5.725 GHz bands are made over a bandwidth of 1 MHz or the 26 dB emission bandwidth of the device, whichever is less. A narrower resolution bandwidth can be used, provided that the measured power is integrated over the full reference bandwidth.

5.3. TEST PROCEDURE

- Set RBW = approximately 1% of the emission bandwidth.
- Set the VBW > RBW.
- Detector = Peak.
- Trace mode = max hold.
- Measure the maximum width of the emission that is 26 dB down from the maximum of the emission. Compare this with the RBW setting of the analyzer. Readjust RBW and repeat measurement as needed until the RBW/EBW ratio is approximately 1%.

The following procedure shall be used for measuring (99 %) power bandwidth:

- Set center frequency to the nominal EUT channel center frequency.
- Set span = 1.5 times to 5.0 times the OBW.
- Set RBW = 1 % to 5 % of the OBW
- Set $VBW \geq 3 \cdot RBW$
- Video averaging is not permitted. Where practical, a sample detection and single sweep mode shall be used. Otherwise, peak detection and max hold mode (until the trace stabilizes) shall be used.
- Use the 99 % power bandwidth function of the instrument (if available).
- If the instrument does not have a 99 % power bandwidth function, the trace data points are recovered and directly summed in power units. The recovered amplitude data points, beginning at the lowest frequency, are placed in a running sum until 0.5 % of the total is reached; that frequency is recorded as the lower frequency. The process is repeated until 99.5 % of the total is reached; that frequency is recorded as the upper frequency. The 99% occupied bandwidth is the difference between these two frequencies.

5.4. TEST RESULT

CH. No.	Frequency (MHz)	26dB Occupied Bandwidth (MHz)			99% Occupied Bandwidth (MHz)		
		802.11a	802.11n (HT20)	802.11ac (VHT20)	802.11a	802.11n (HT20)	802.11ac (VHT20)
36	5180.00	20.880	21.420	21.300	16.485	17.766	17.750
40	5200.00	20.880	21.420	21.240	16.497	17.778	17.778
48	5240.00	20.880	21.390	21.090	16.497	17.761	17.765
CH. No.	Frequency (MHz)	6dB Occupied Bandwidth (MHz)			99% Occupied Bandwidth (MHz)		
		802.11a	802.11n (HT20)	802.11ac (VHT20)	802.11a	802.11n (HT20)	802.11ac (VHT20)
149	5745.00	17.280	16.470	17.190	17.404	16.414	17.437
157	5785.00	17.760	16.470	17.760	17.774	16.505	17.740
165	5825.00	17.760	16.470	17.730	17.770	16.499	17.763

CH. No.	Frequency (MHz)	26dB Occupied Bandwidth (MHz)		99% Occupied Bandwidth (MHz)	
		802.11n (HT40)	802.11ac (VHT40)	802.11n (HT40)	802.11ac (VHT40)
38	5190.00	39.600	40.080	36.286	36.474
46	5230.00	39.600	40.020	36.306	36.434
CH. No.	Frequency (MHz)	6dB Occupied Bandwidth (MHz)		99% Occupied Bandwidth (MHz)	
		802.11n (HT40)	802.11ac (VHT40)	802.11n (HT40)	802.11ac (VHT40)
151	5755.00	36.600	36.420	36.296	36.527
159	5795.00	36.540	36.480	36.305	36.466

CH. No.	Frequency (MHz)	26dB Occupied Bandwidth (MHz)	99% Occupied Bandwidth (MHz)
		802.11ac (VHT80)	802.11ac (VHT80)
42	5210.00	75.840	75.891
CH. No.	Frequency (MHz)	6dB Occupied Bandwidth (MHz)	99% Occupied Bandwidth (MHz)
		802.11ac (VHT80)	802.11ac (VHT80)
155	5775.00	81.120	75.795

Report No.: AAEMT/RF/230809-01-04

Test plots as followed:

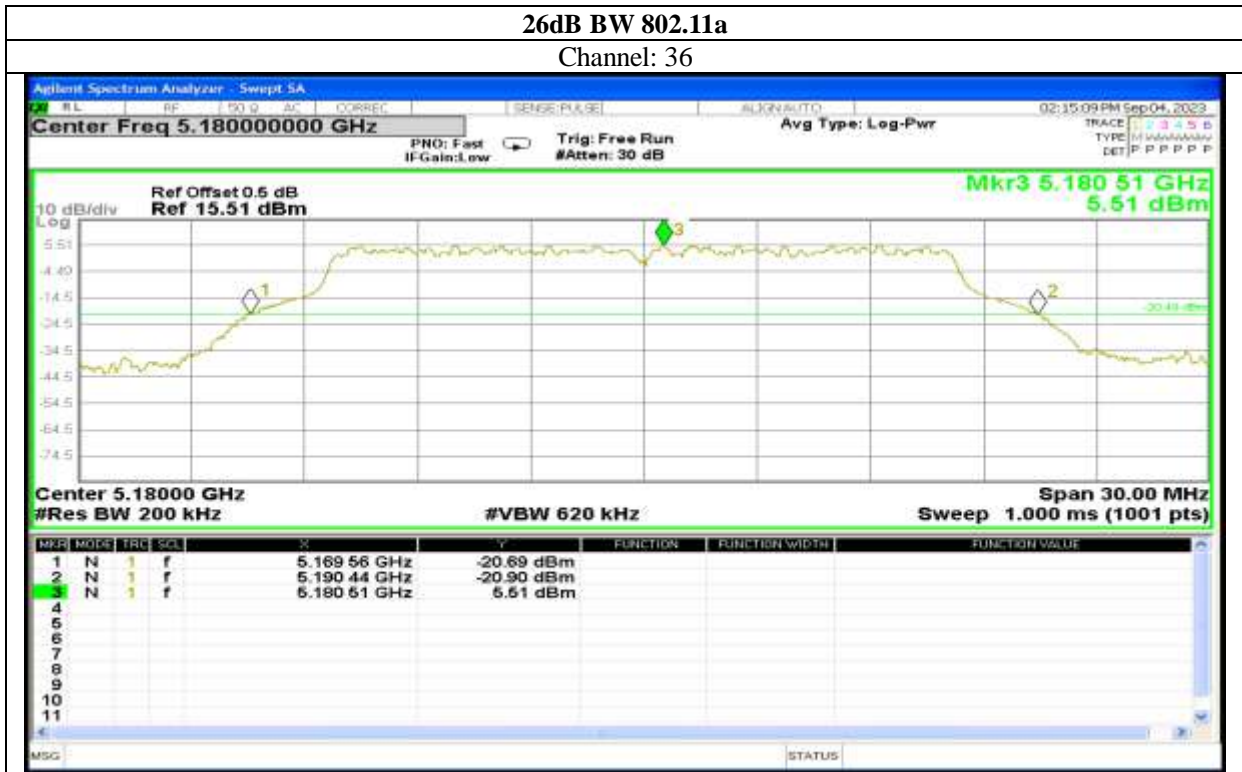

Report No.: AAEMT/RF/230809-01-04

Channel: 48



Report No.: AAEMT/RF/230809-01-04

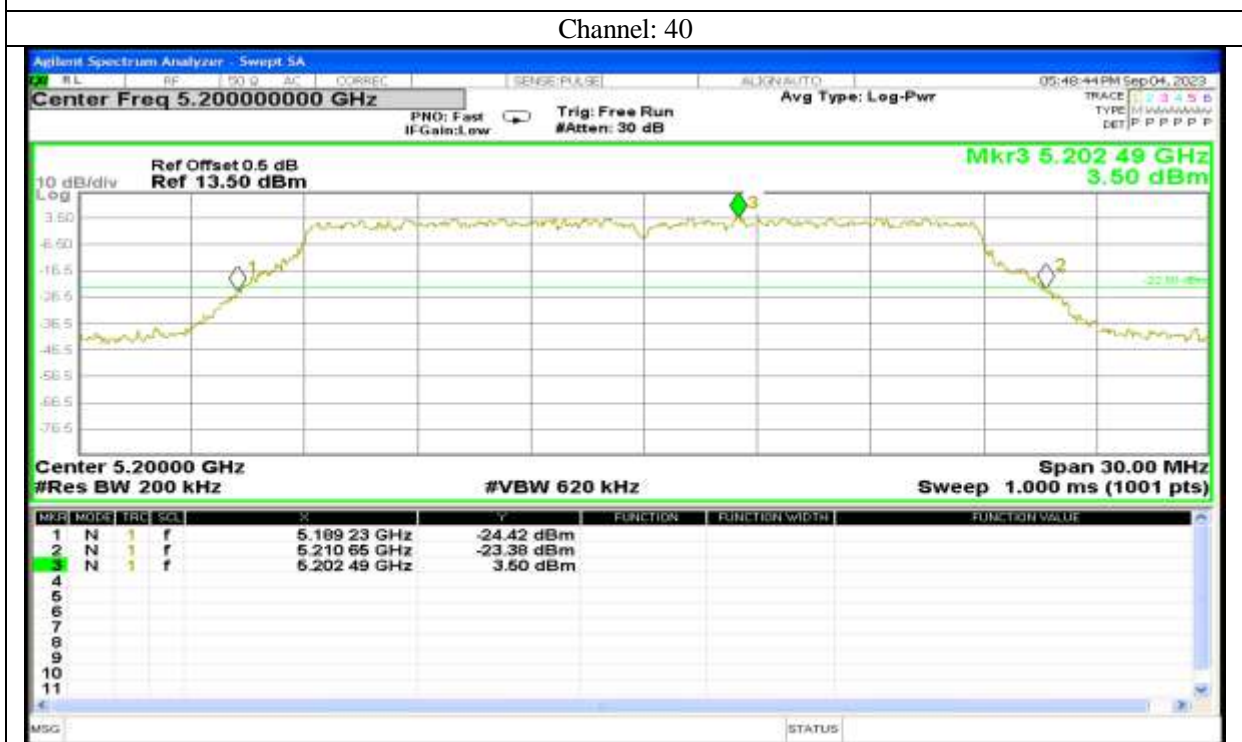
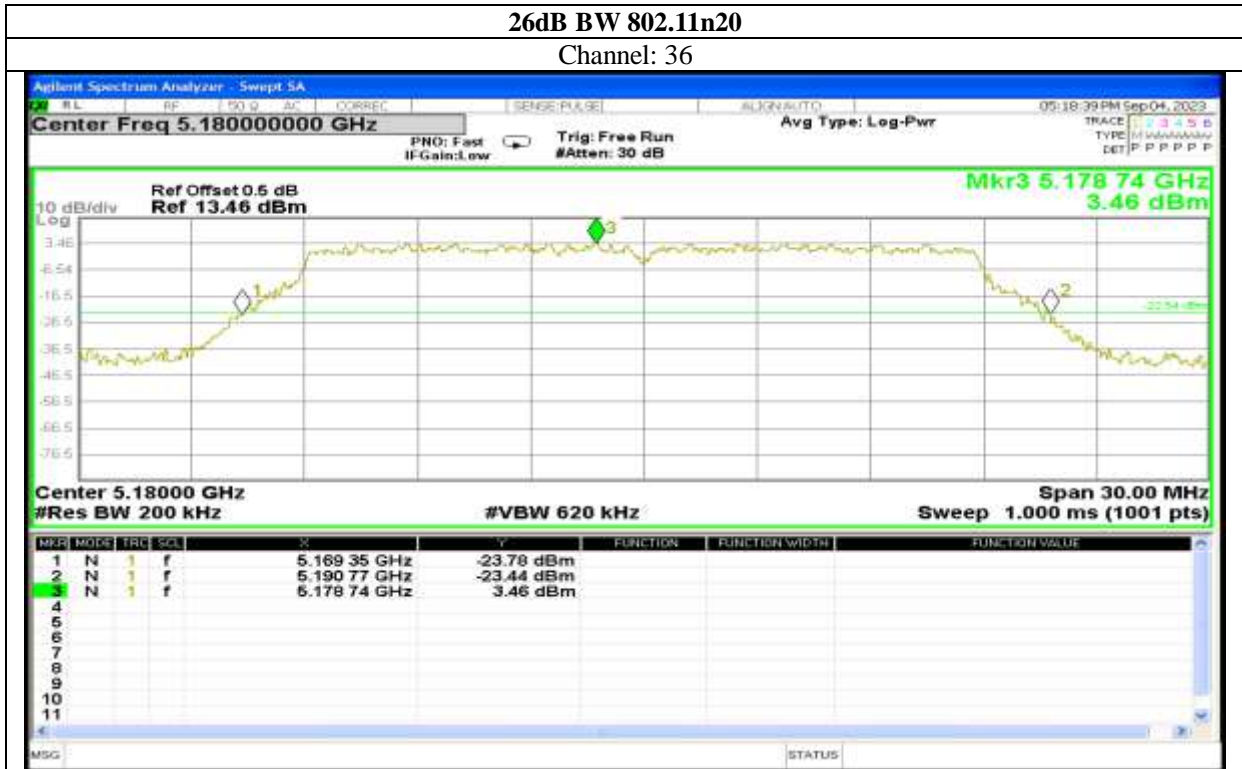

Report No.: AAEMT/RF/230809-01-04

Channel: 48





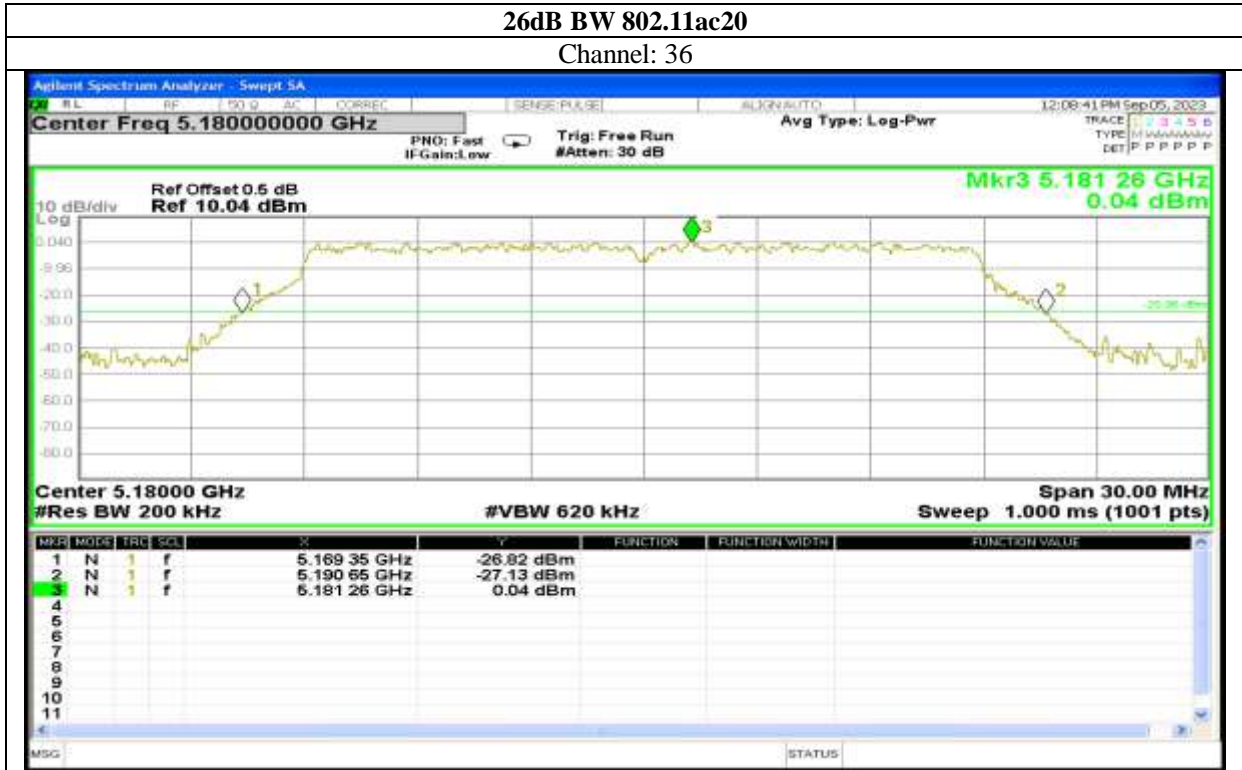

Report No.: AAEMT/RF/230809-01-04

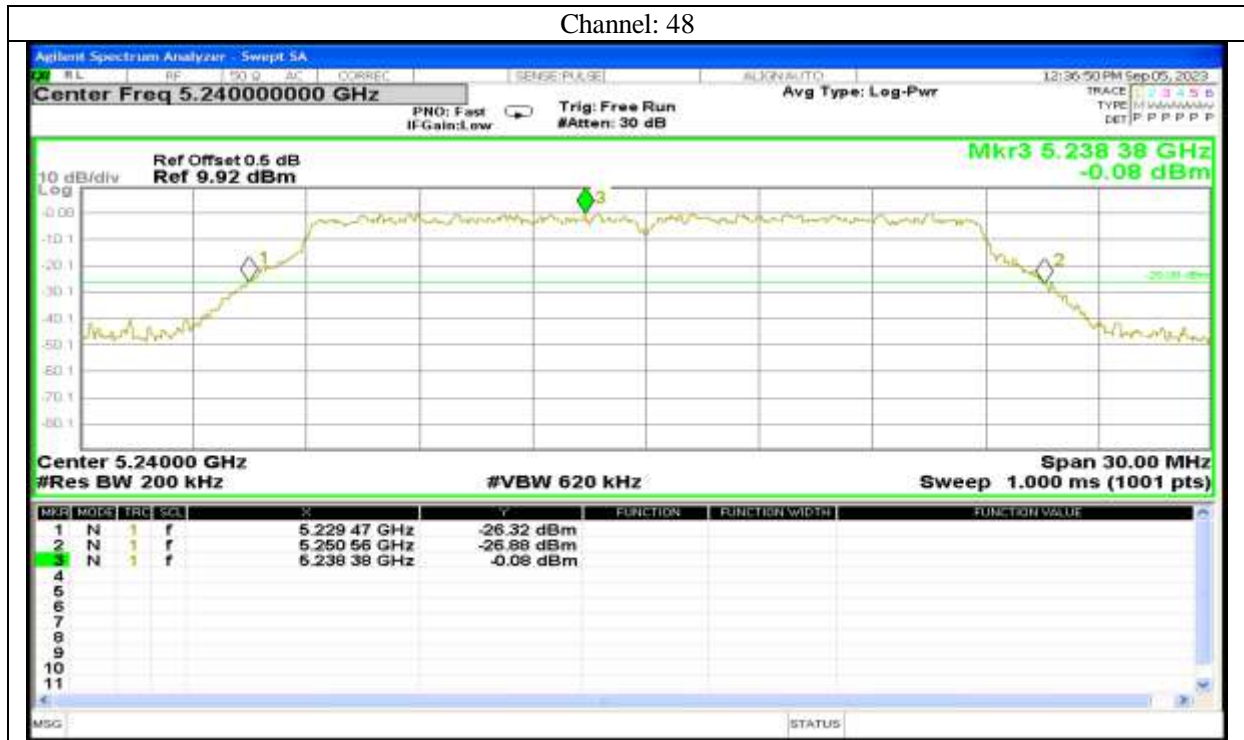

Report No.: AAEMT/RF/230809-01-04

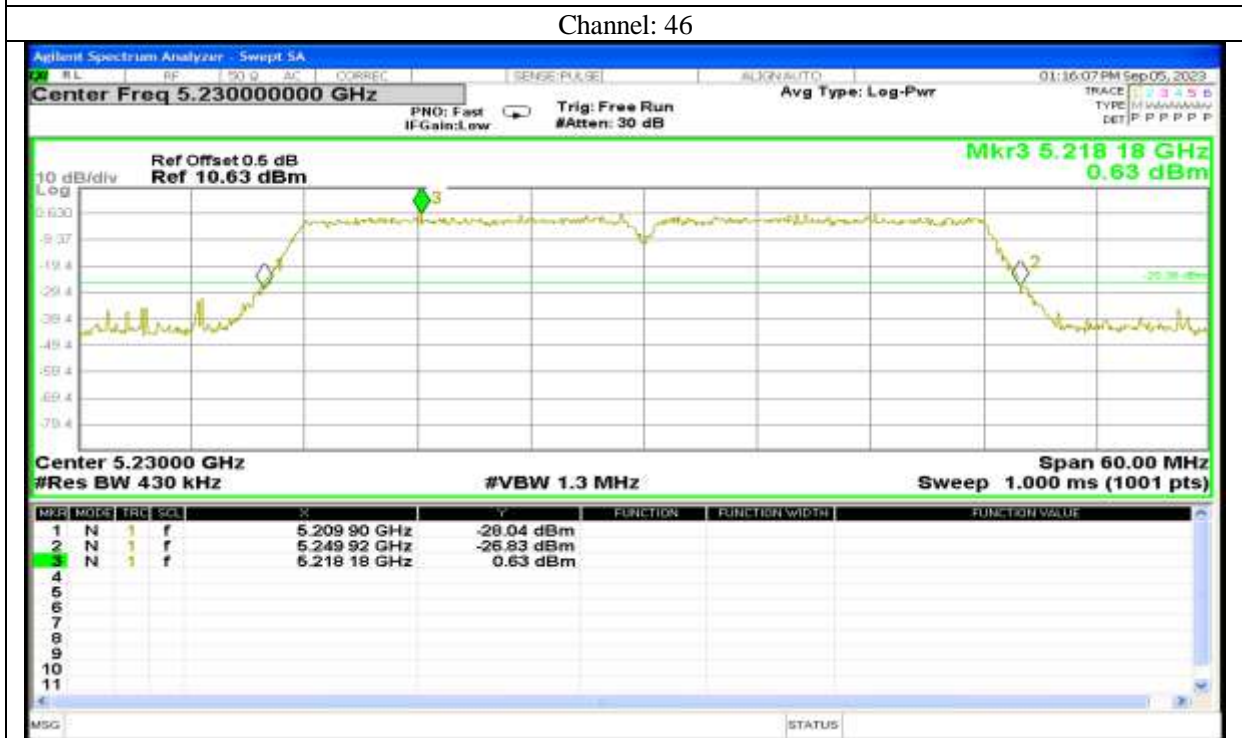
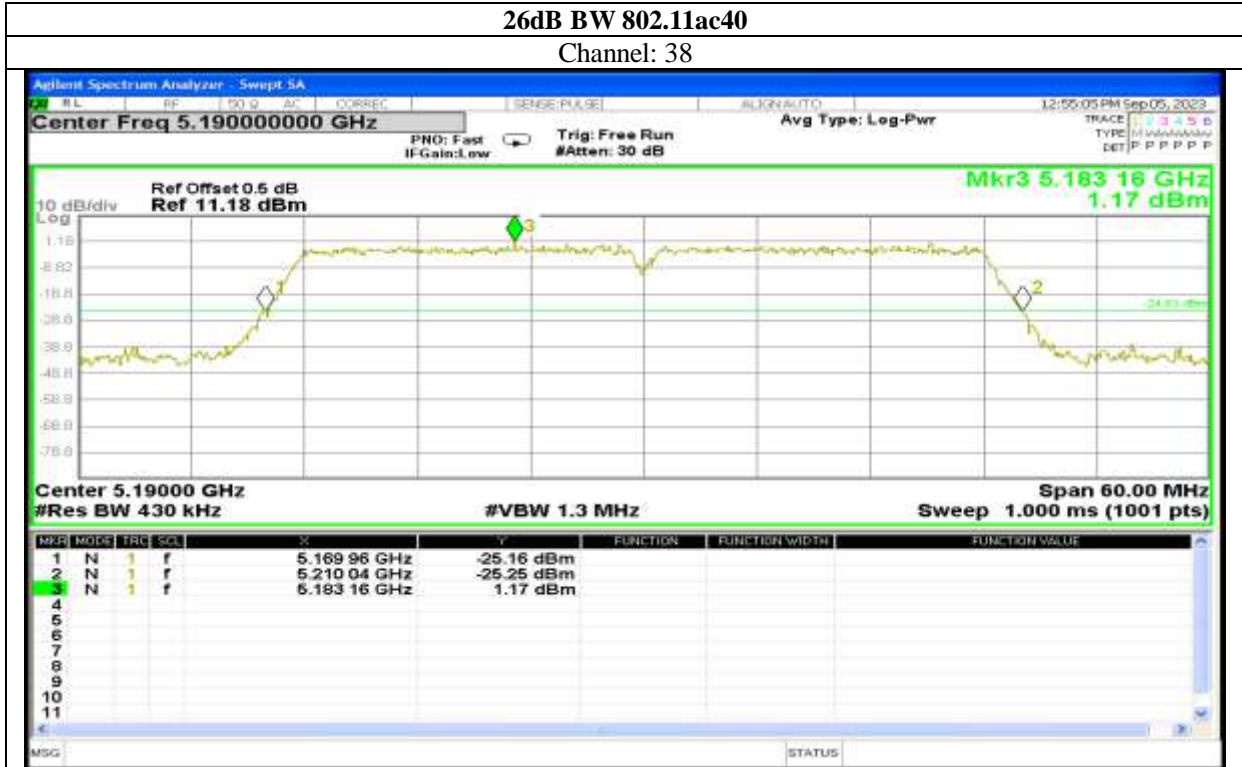

Report No.: AAEMT/RF/230809-01-04

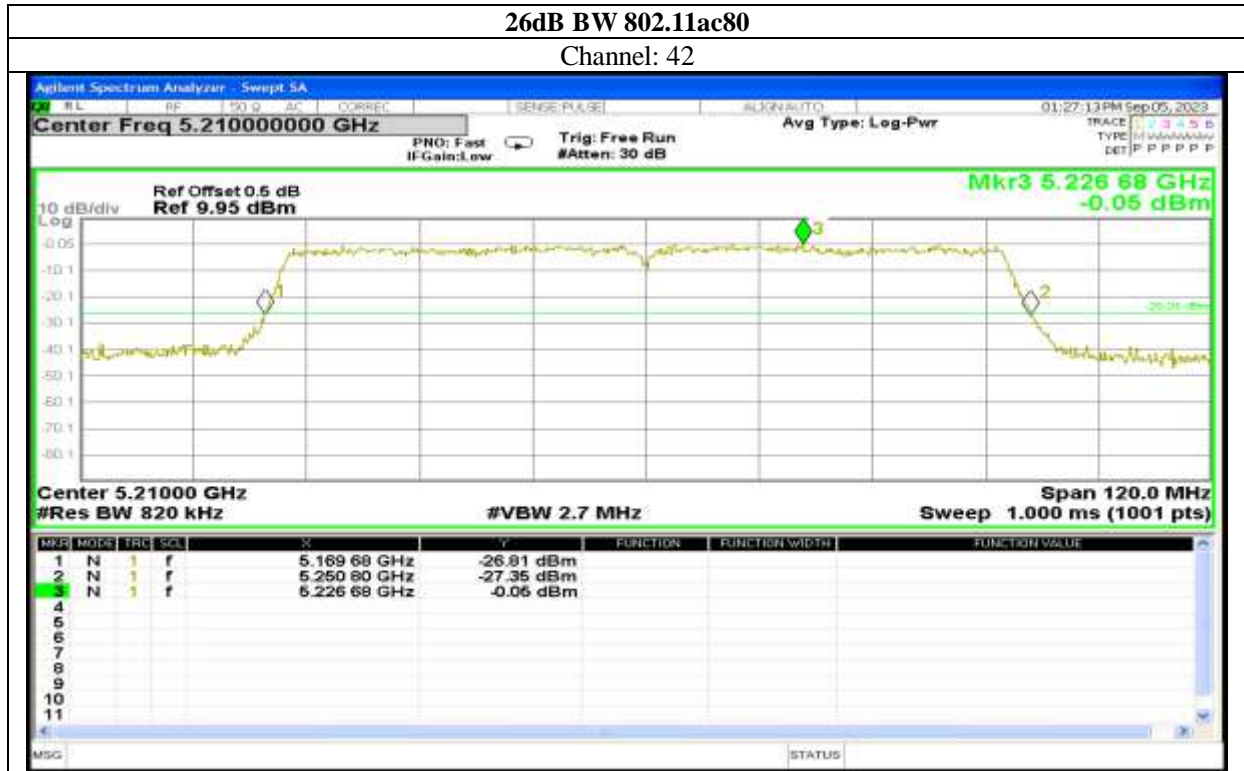

Report No.: AAEMT/RF/230809-01-04

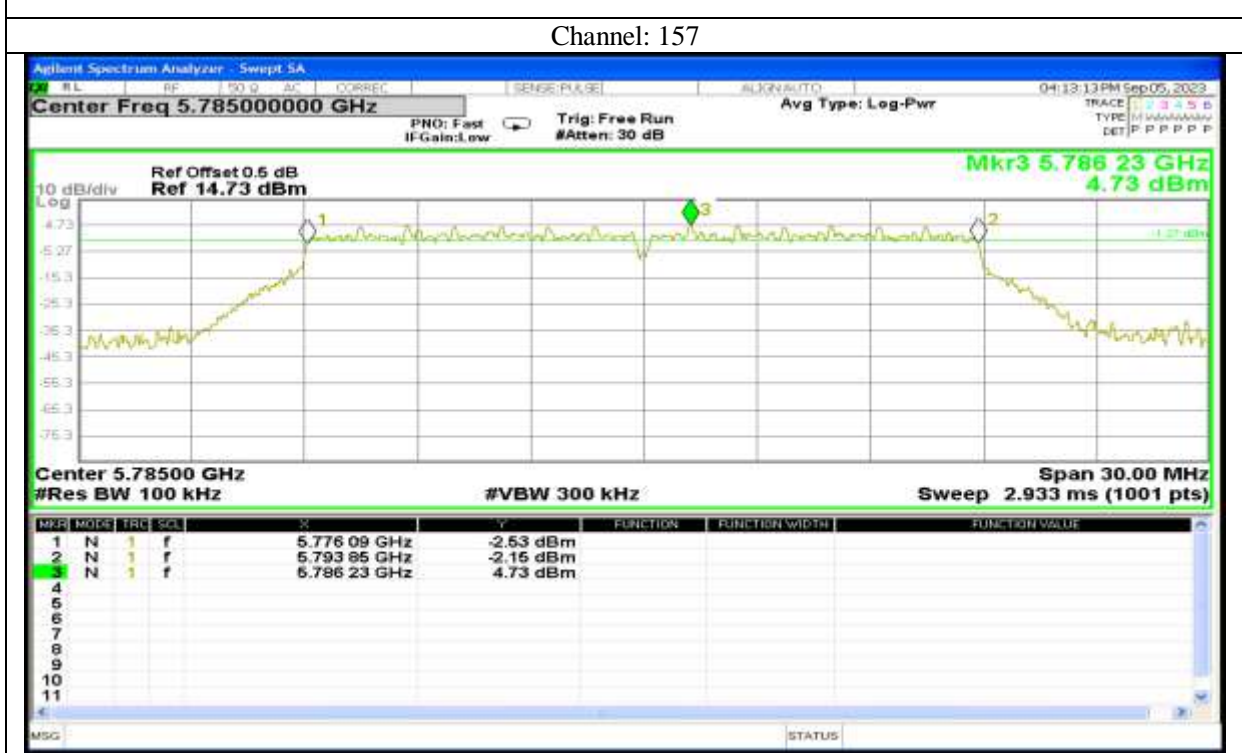
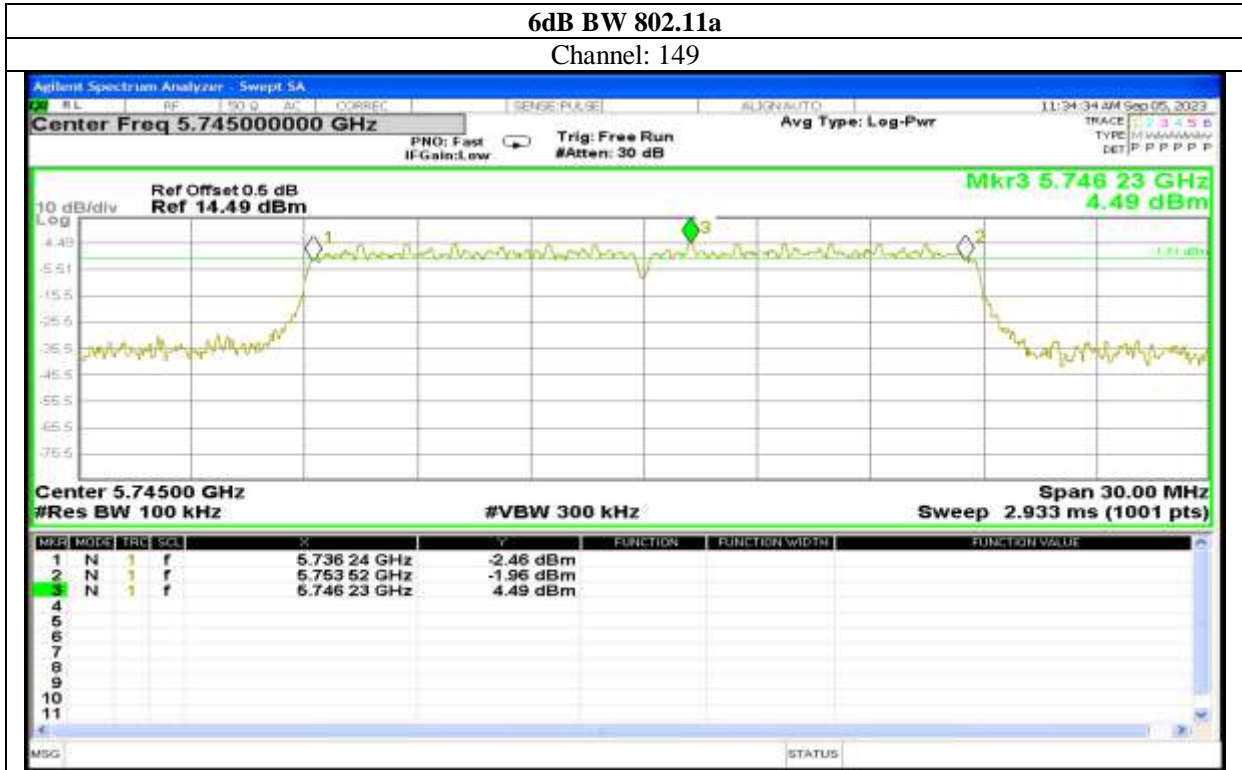

Report No.: AAEMT/RF/230809-01-04

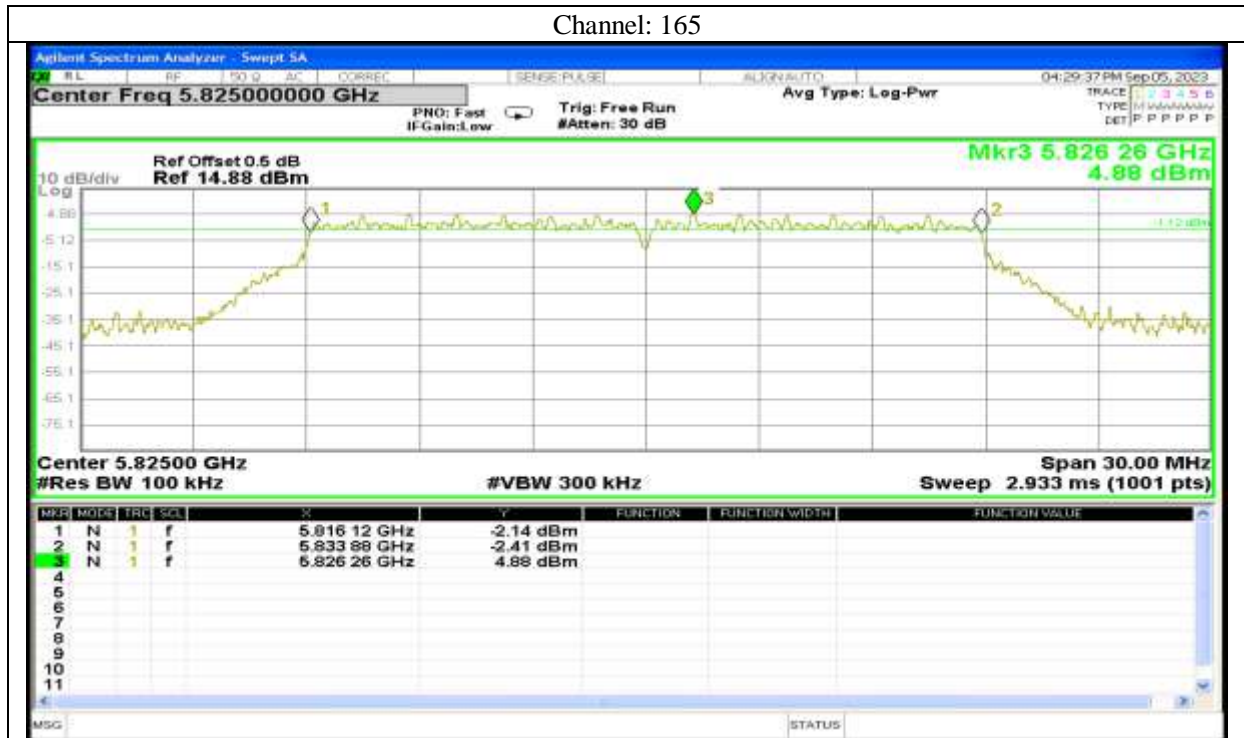

Report No.: AAEMT/RF/230809-01-04

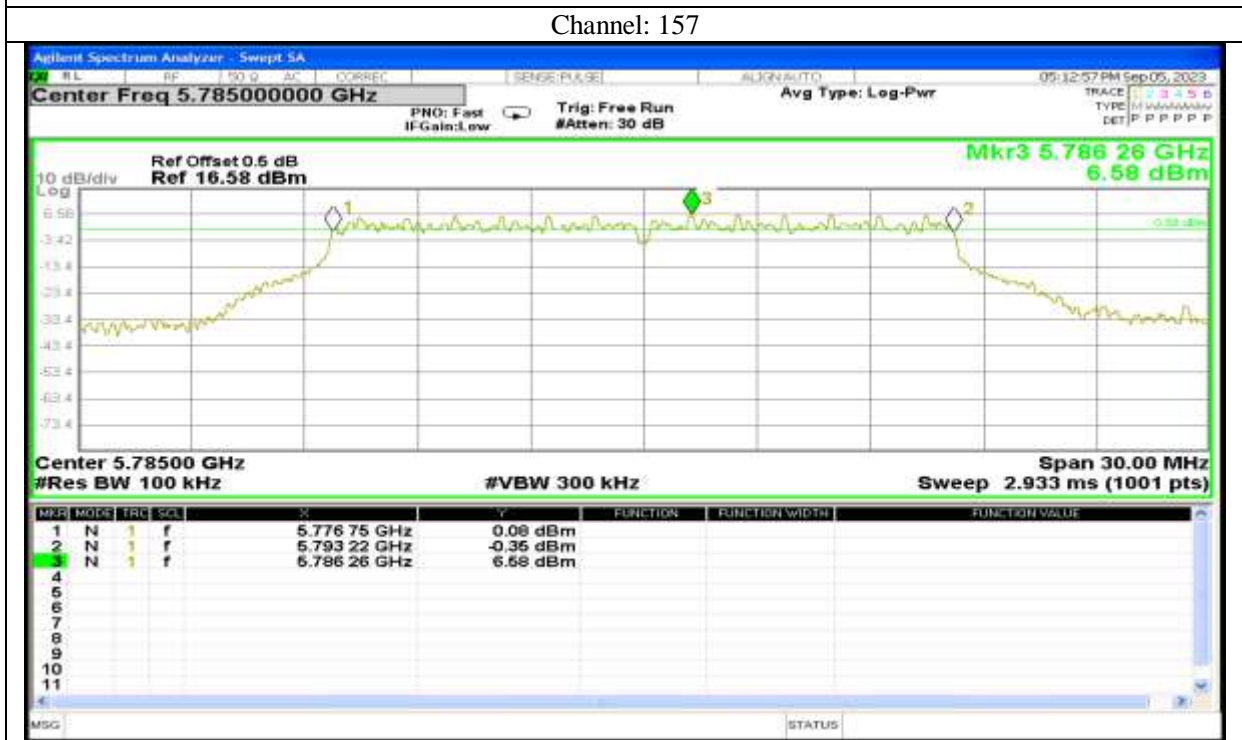
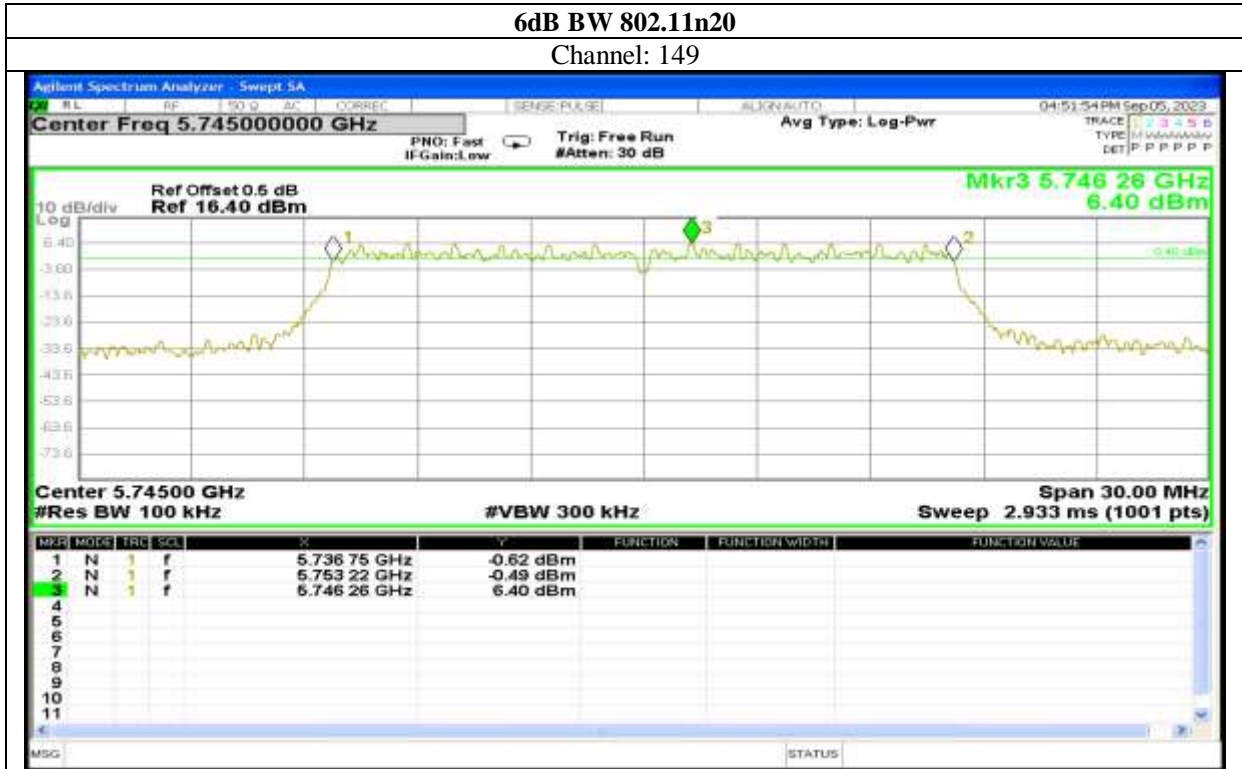

Report No.: AAEMT/RF/230809-01-04

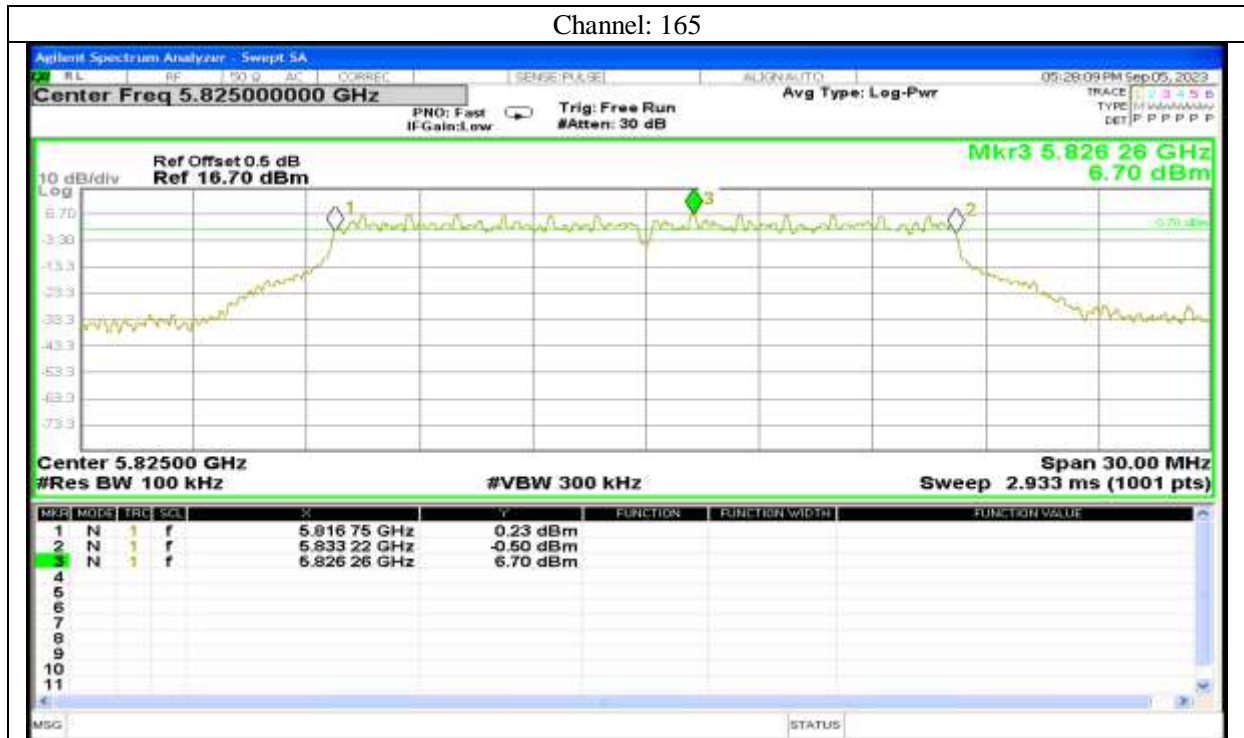

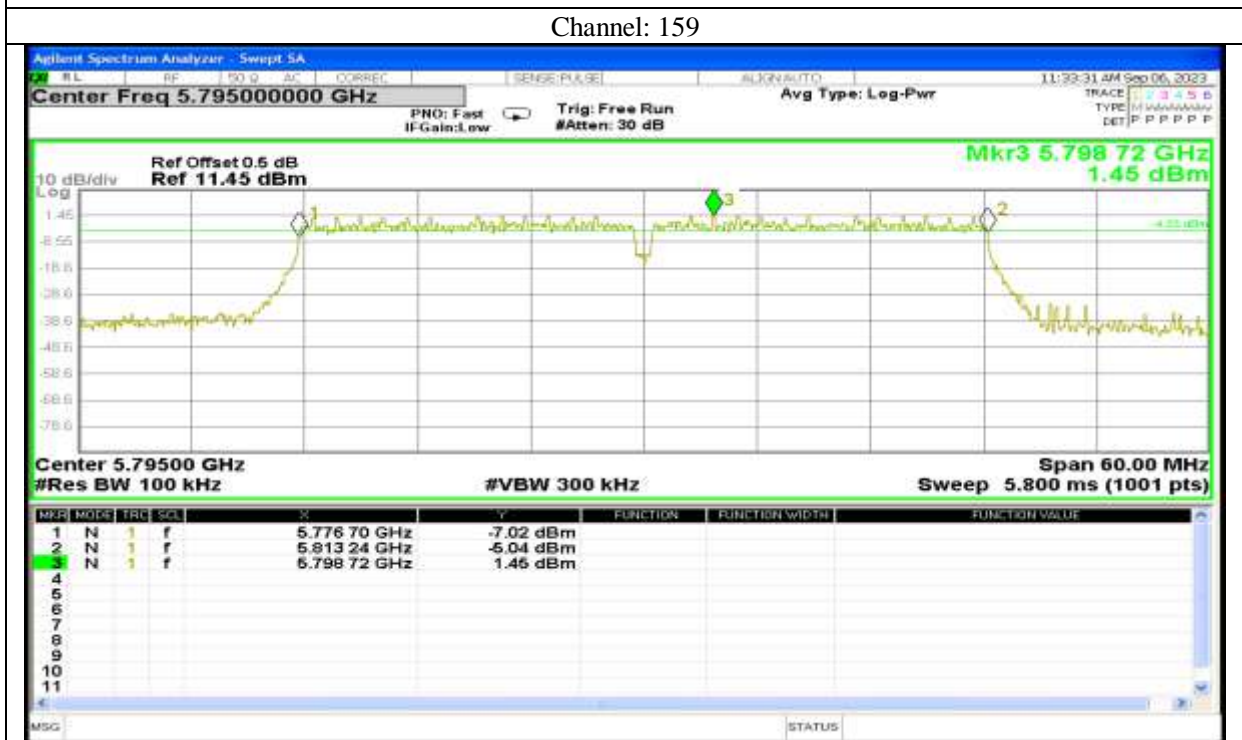
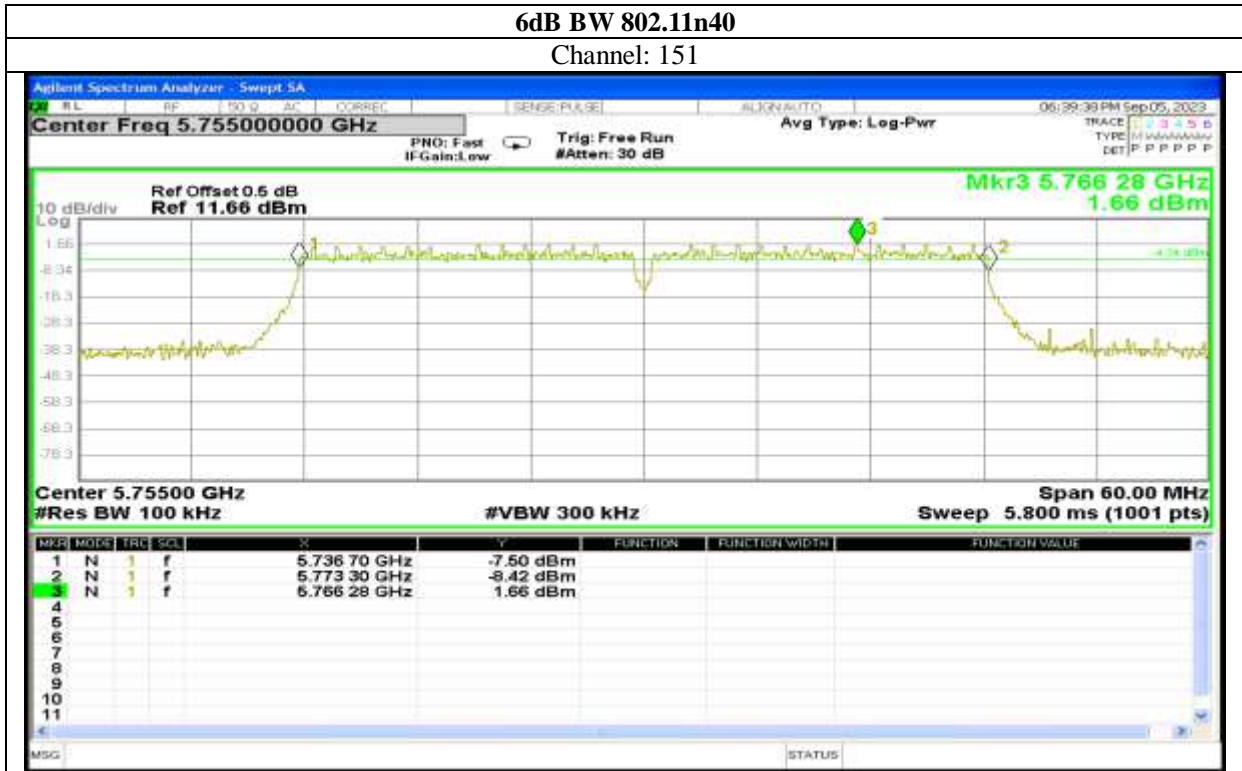

6dB BW 802.11ac20
Channel: 149

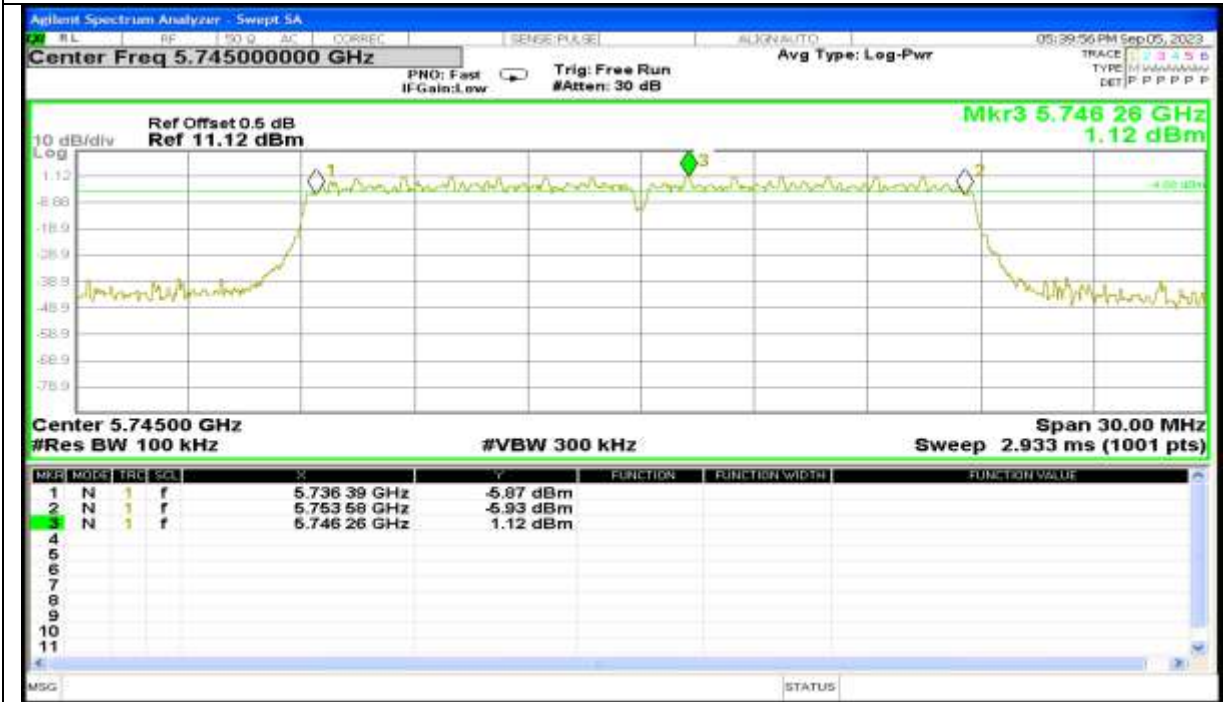

Channel: 157



Report No.: AAEMT/RF/230809-01-04

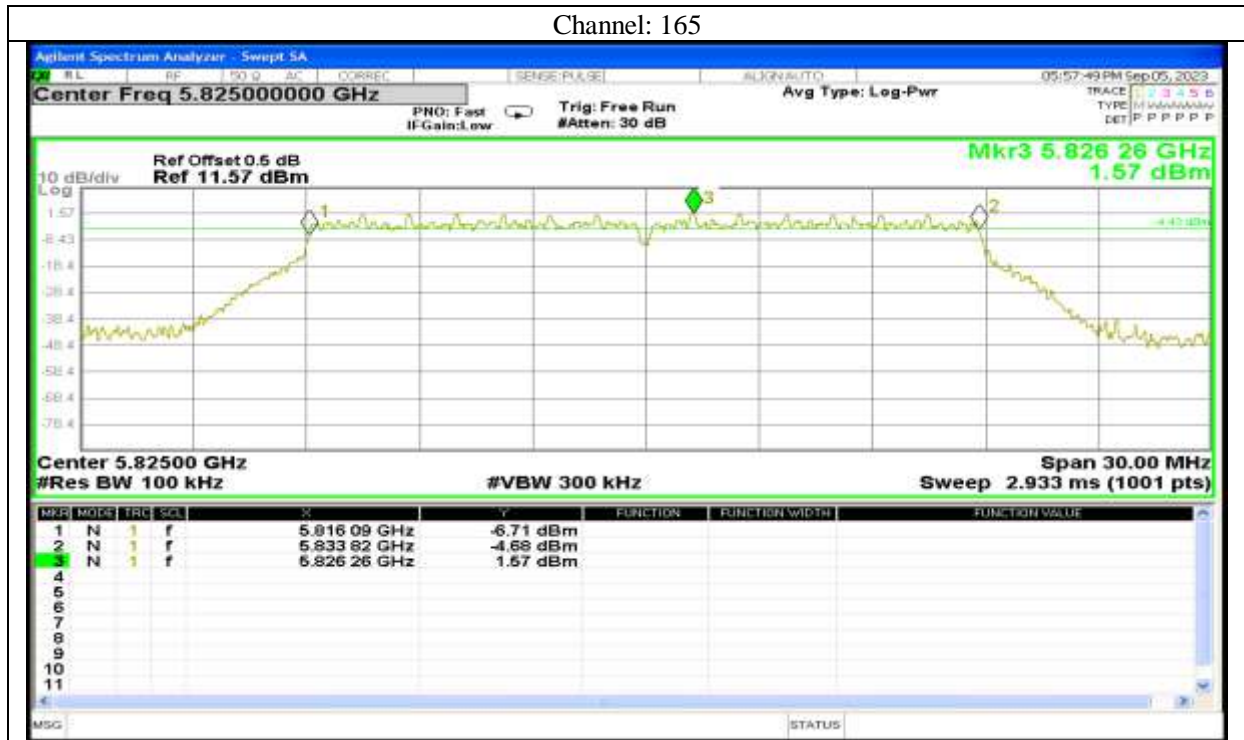

Report No.: AAEMT/RF/230809-01-04

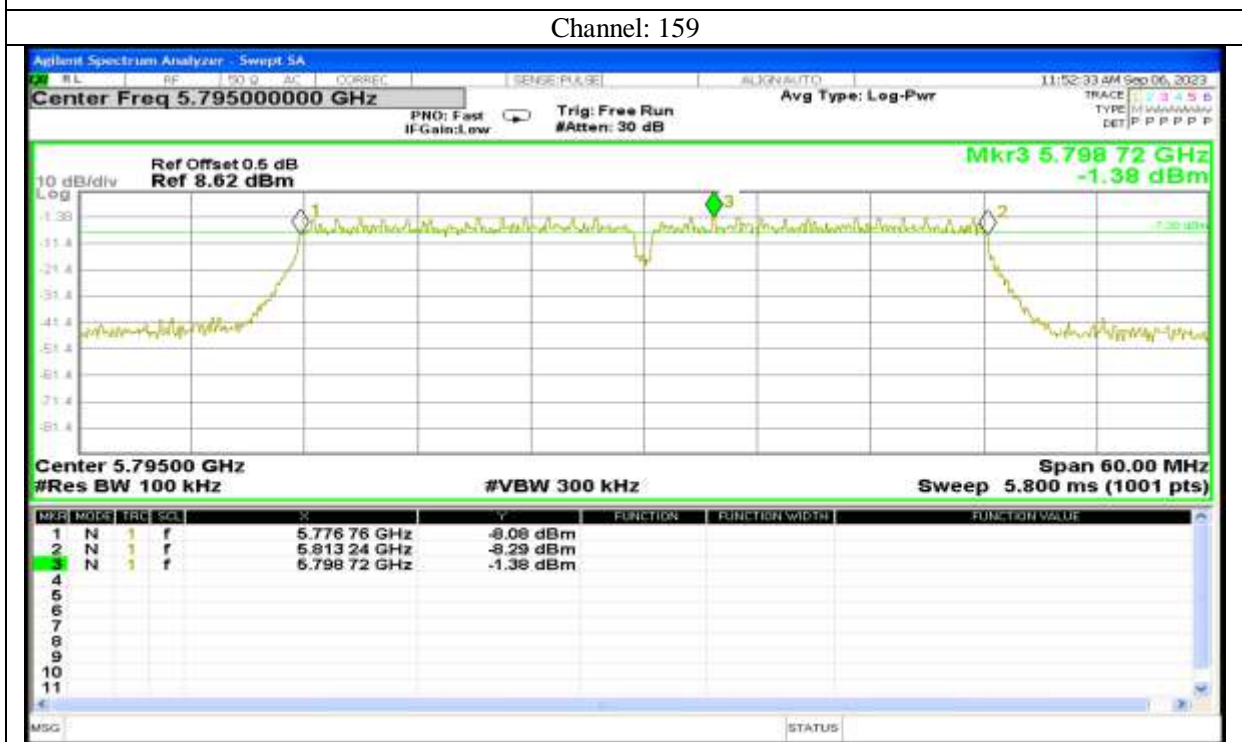
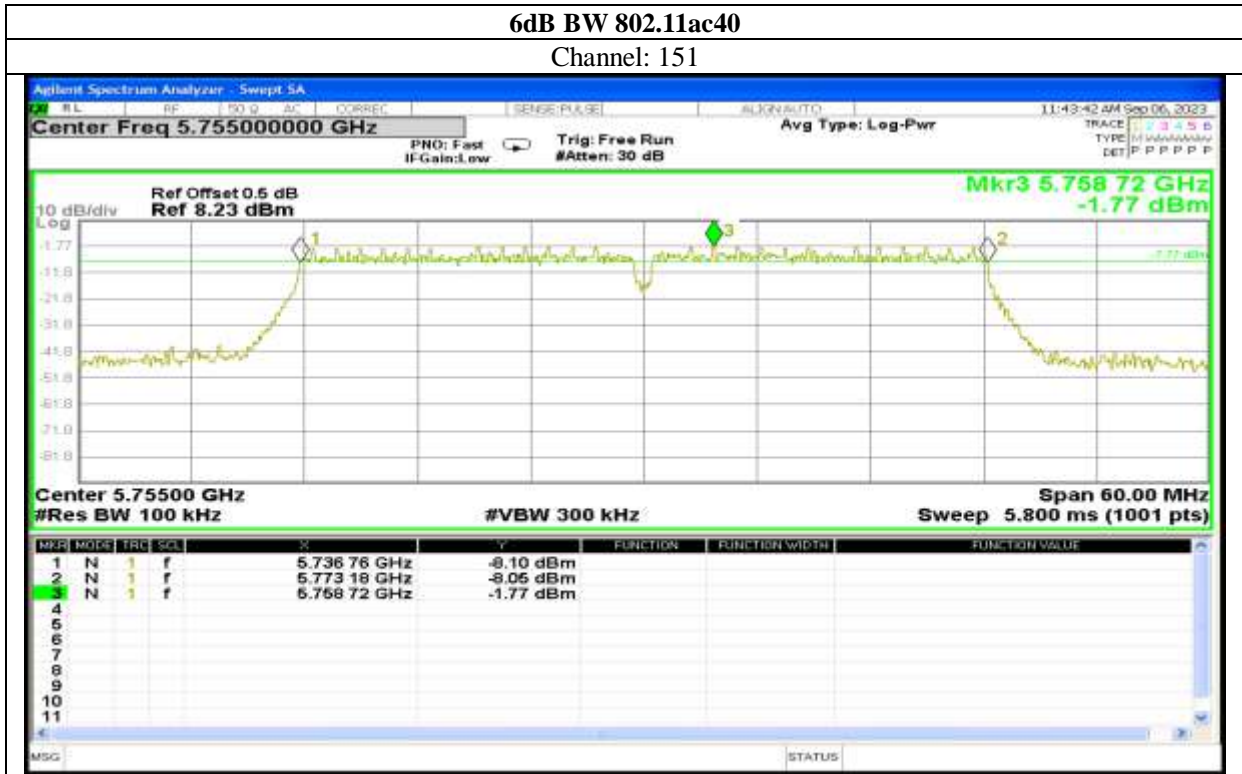

Report No.: AAEMT/RF/230809-01-04

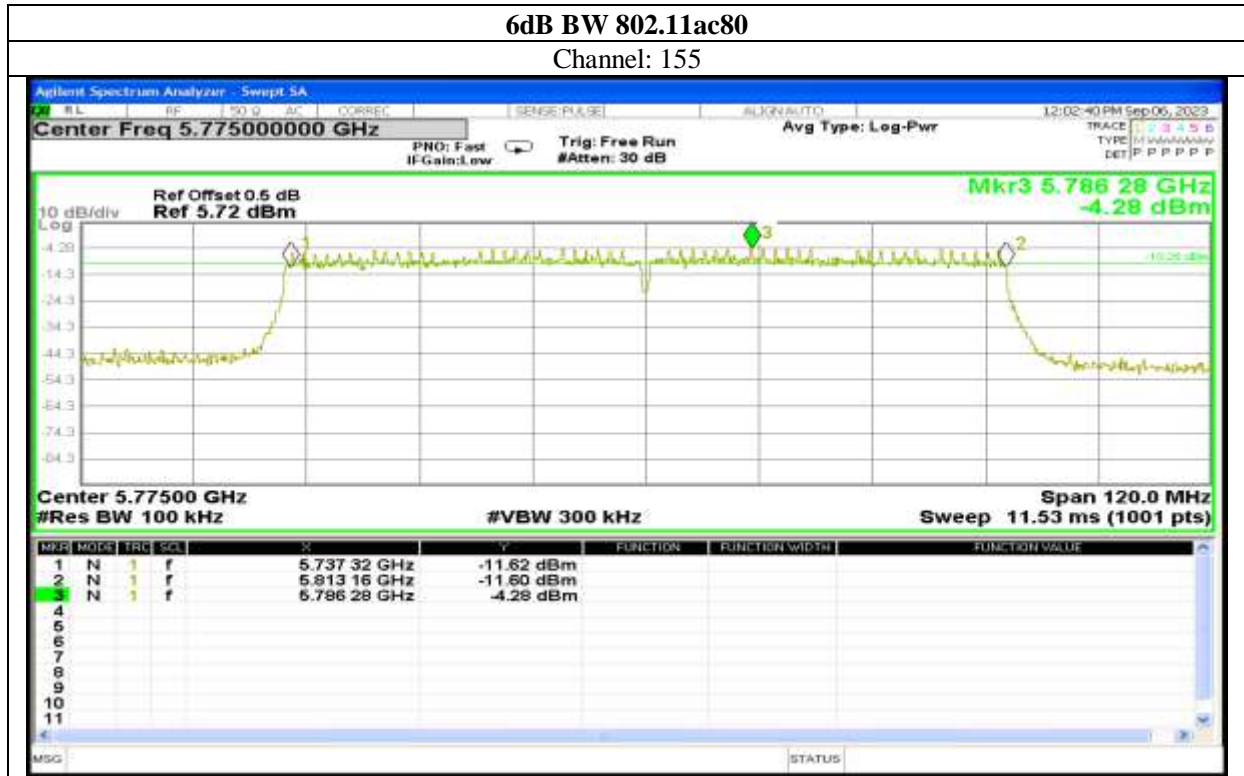

Report No.: AAEMT/RF/230809-01-04

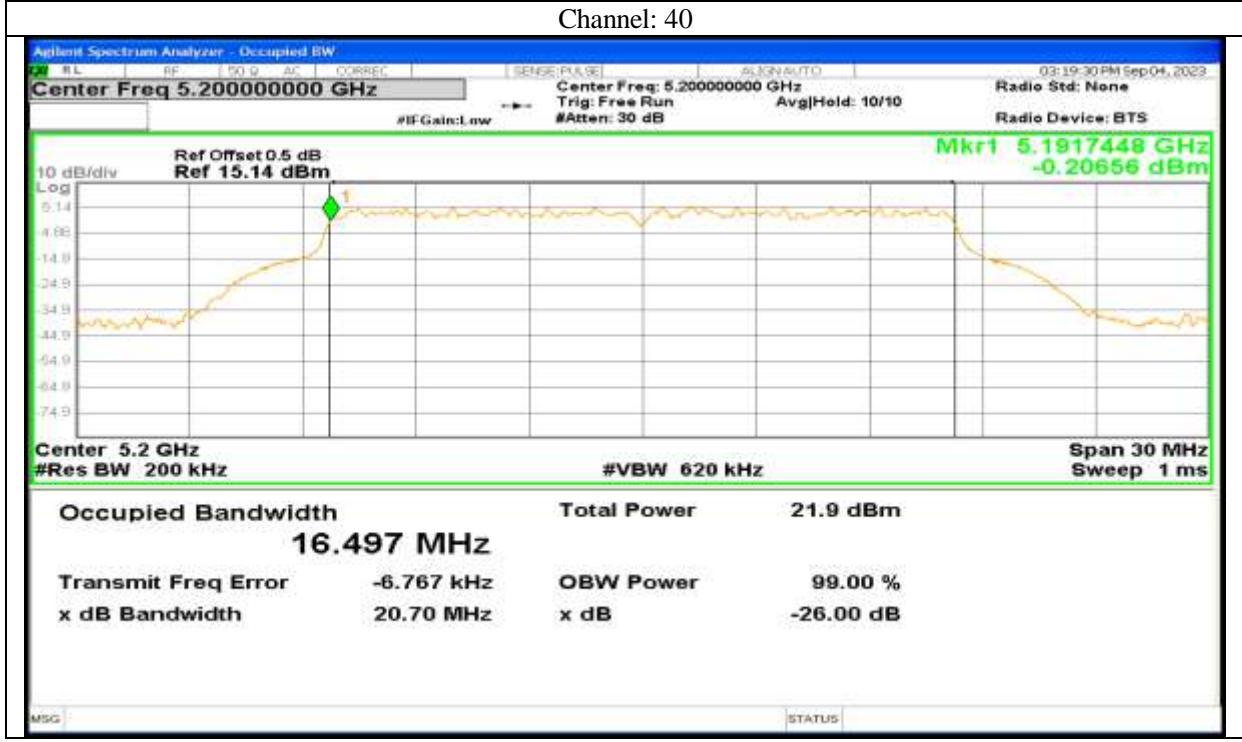
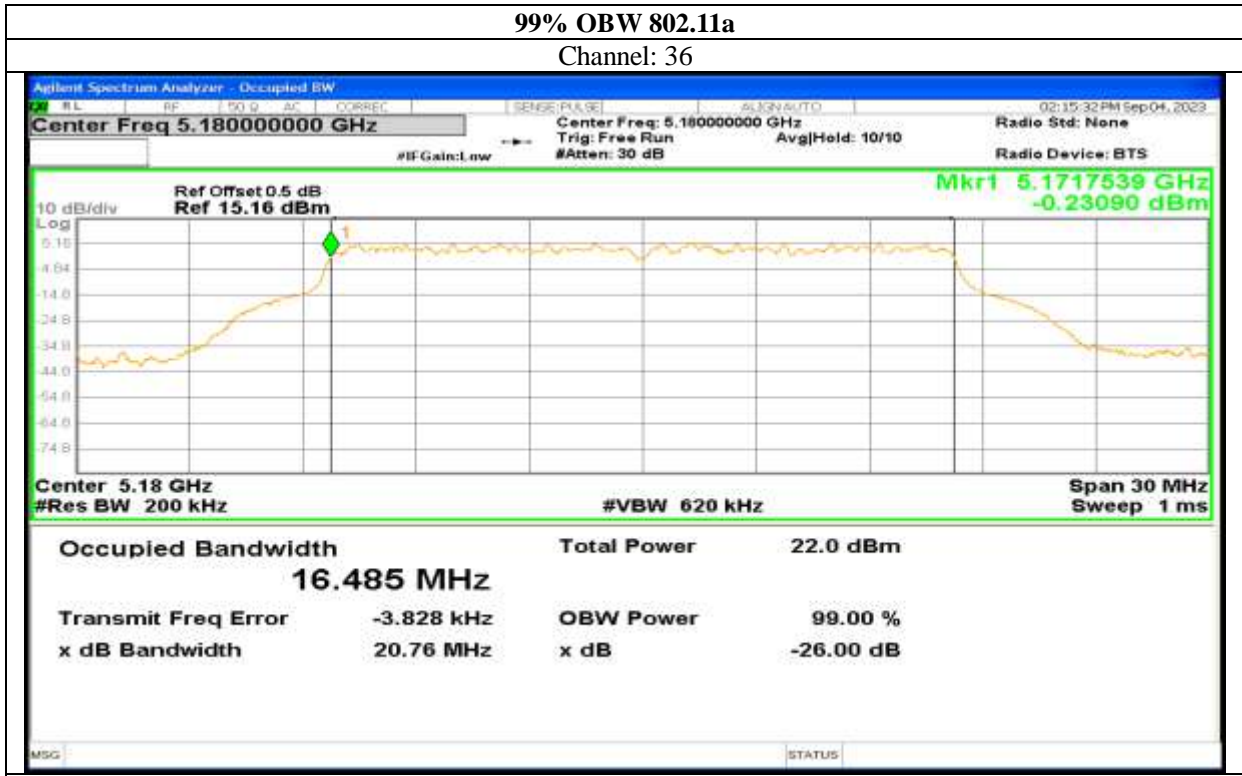

Report No.: AAEMT/RF/230809-01-04

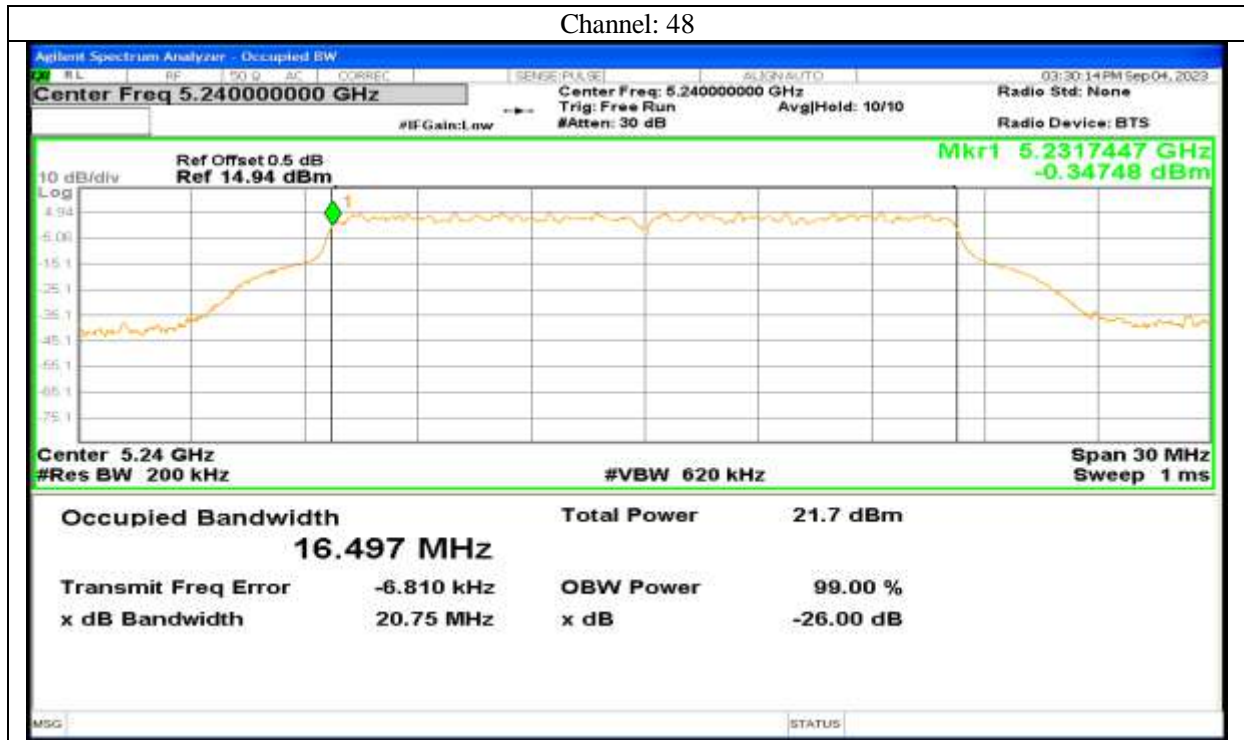

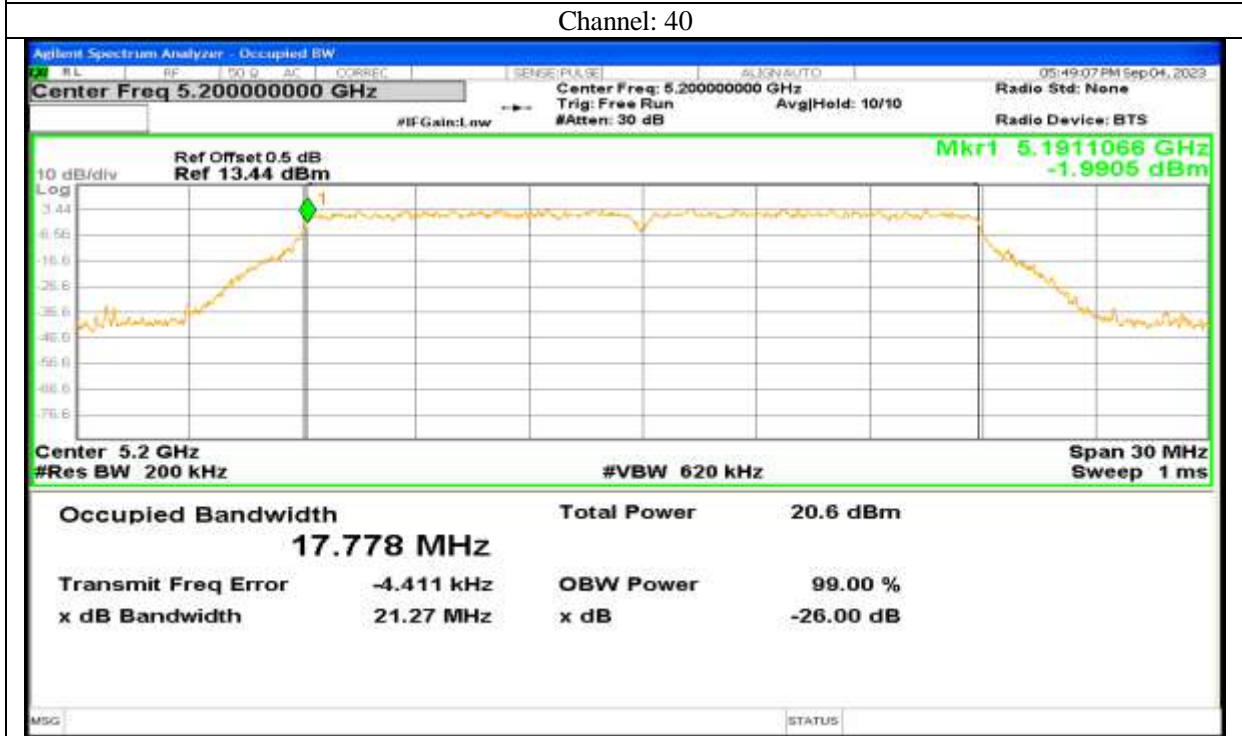
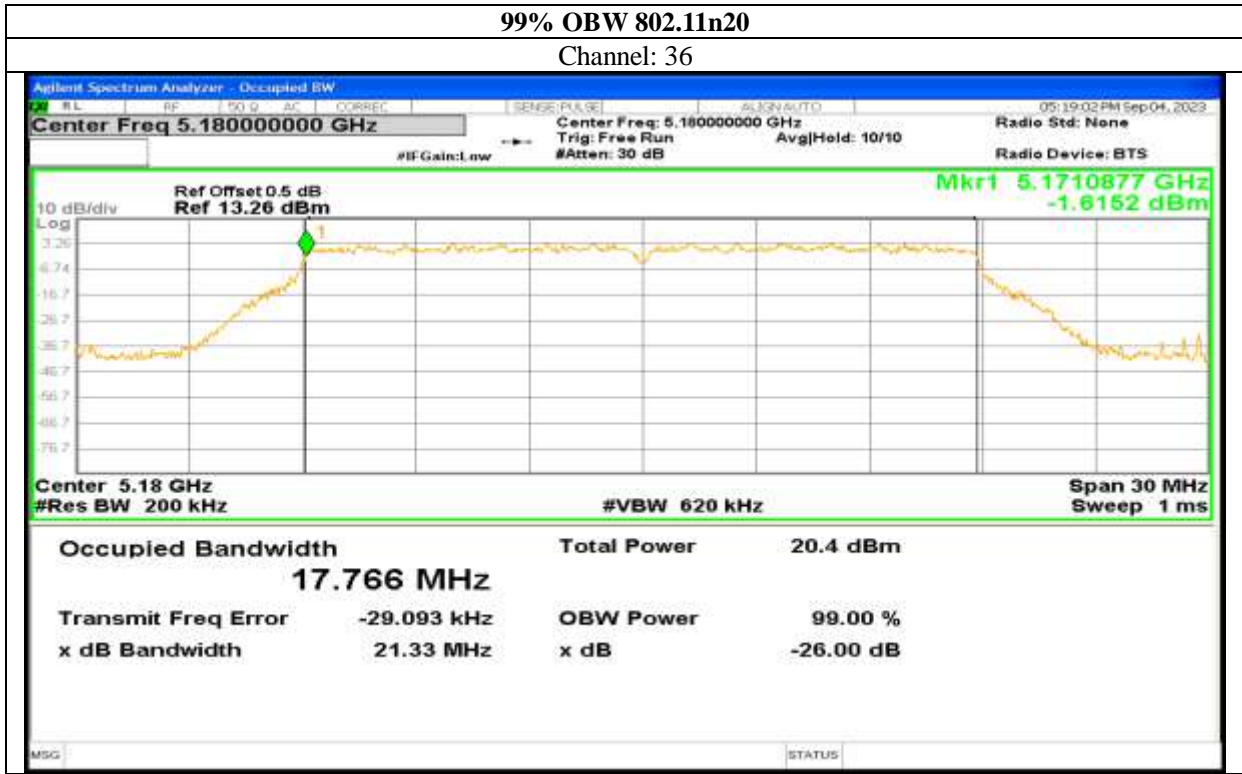

Report No.: AAEMT/RF/230809-01-04

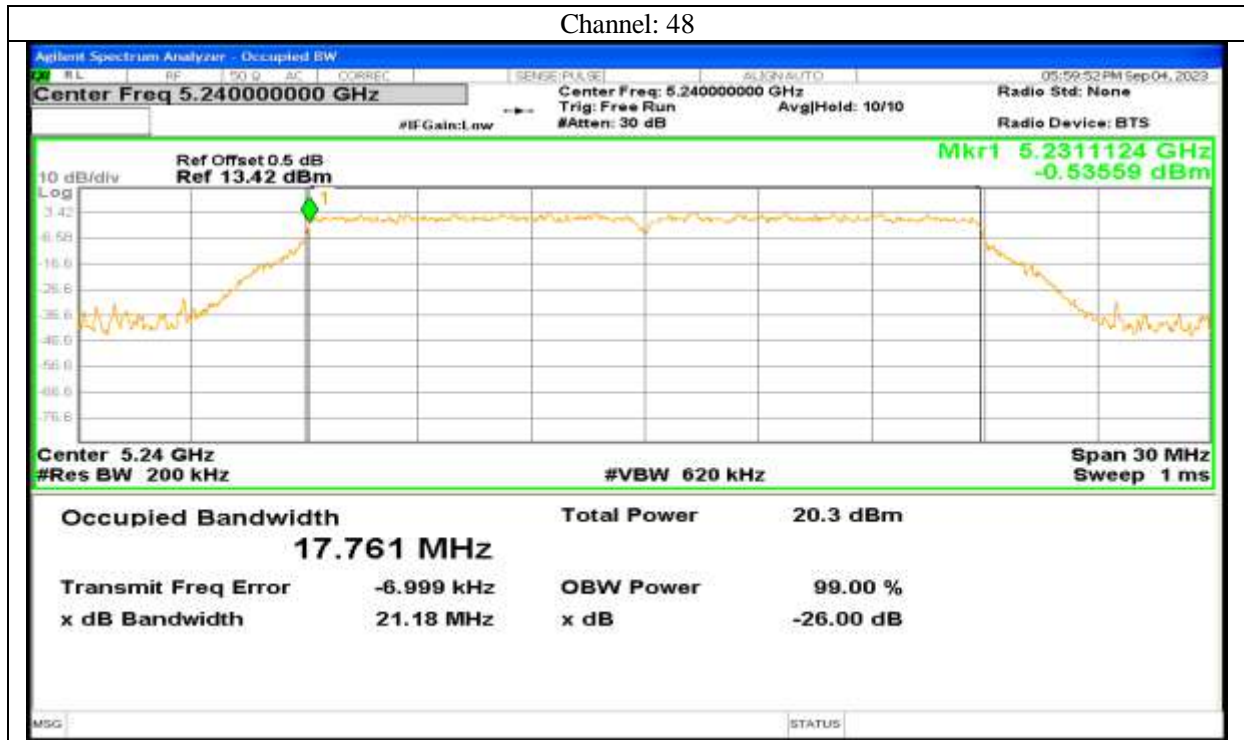

Report No.: AAEMT/RF/230809-01-04

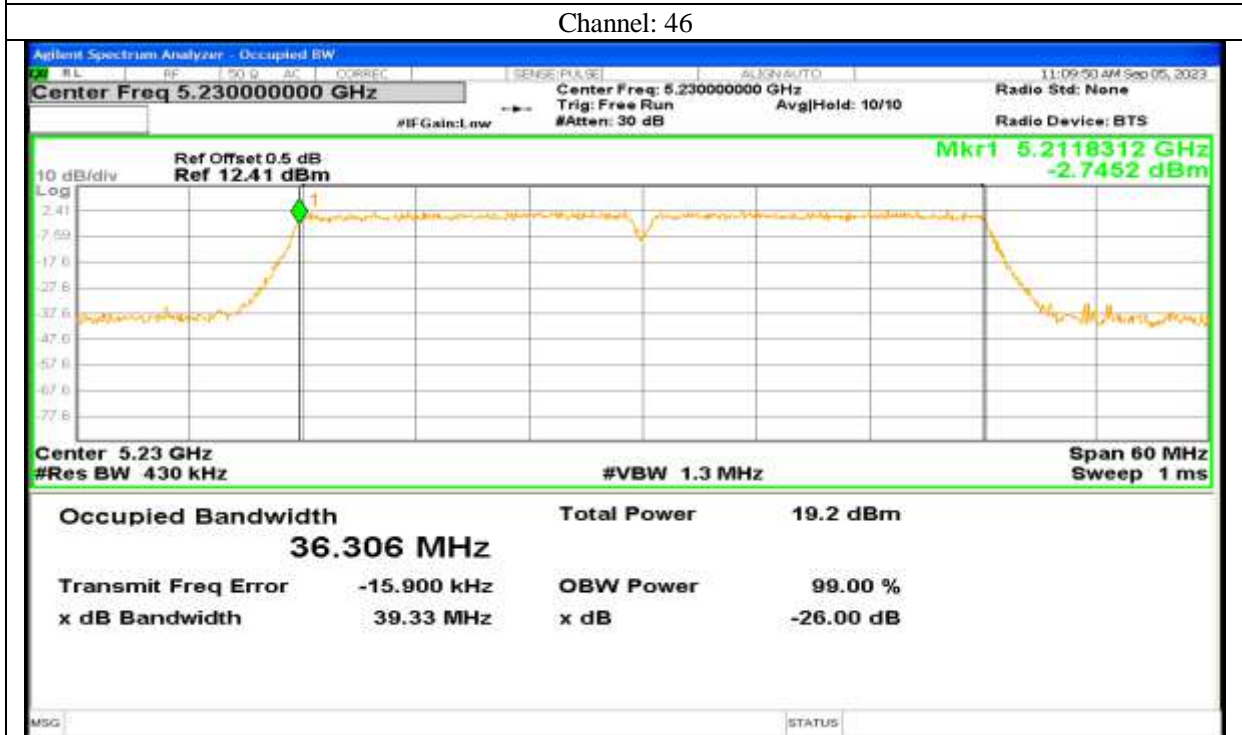
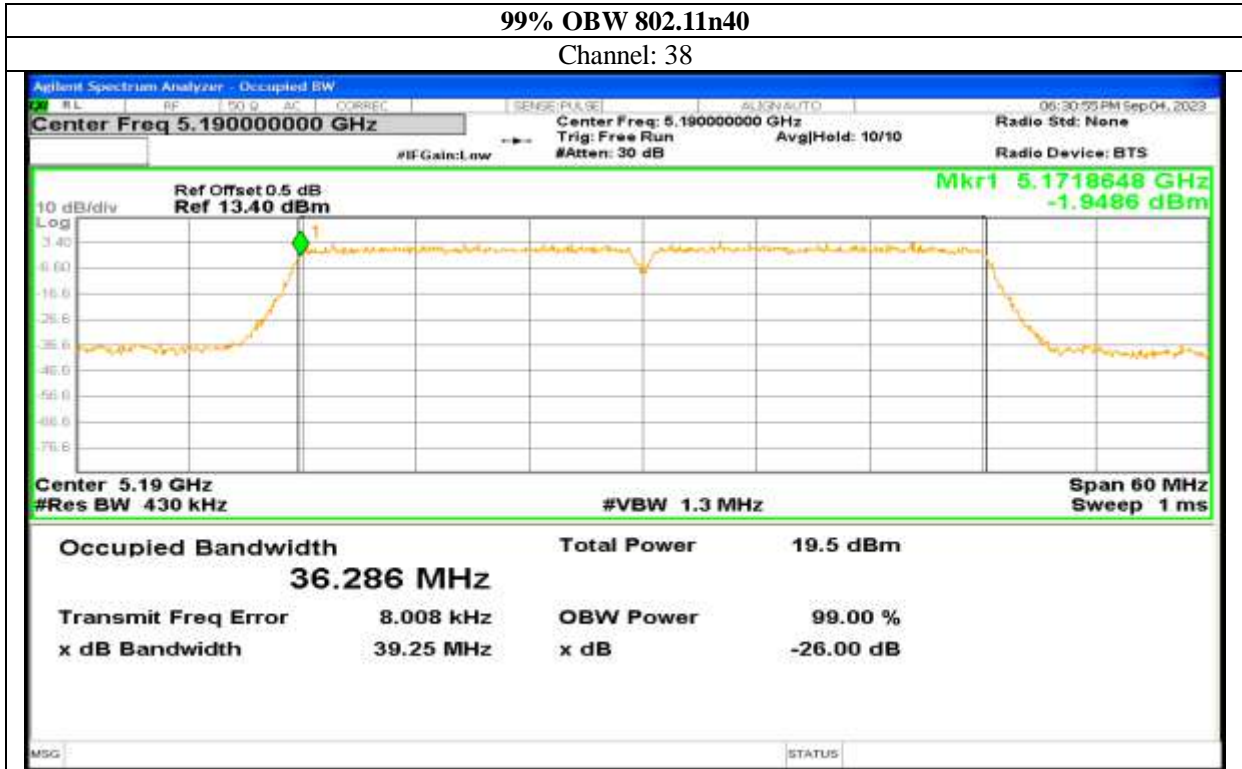

Report No.: AAEMT/RF/230809-01-04

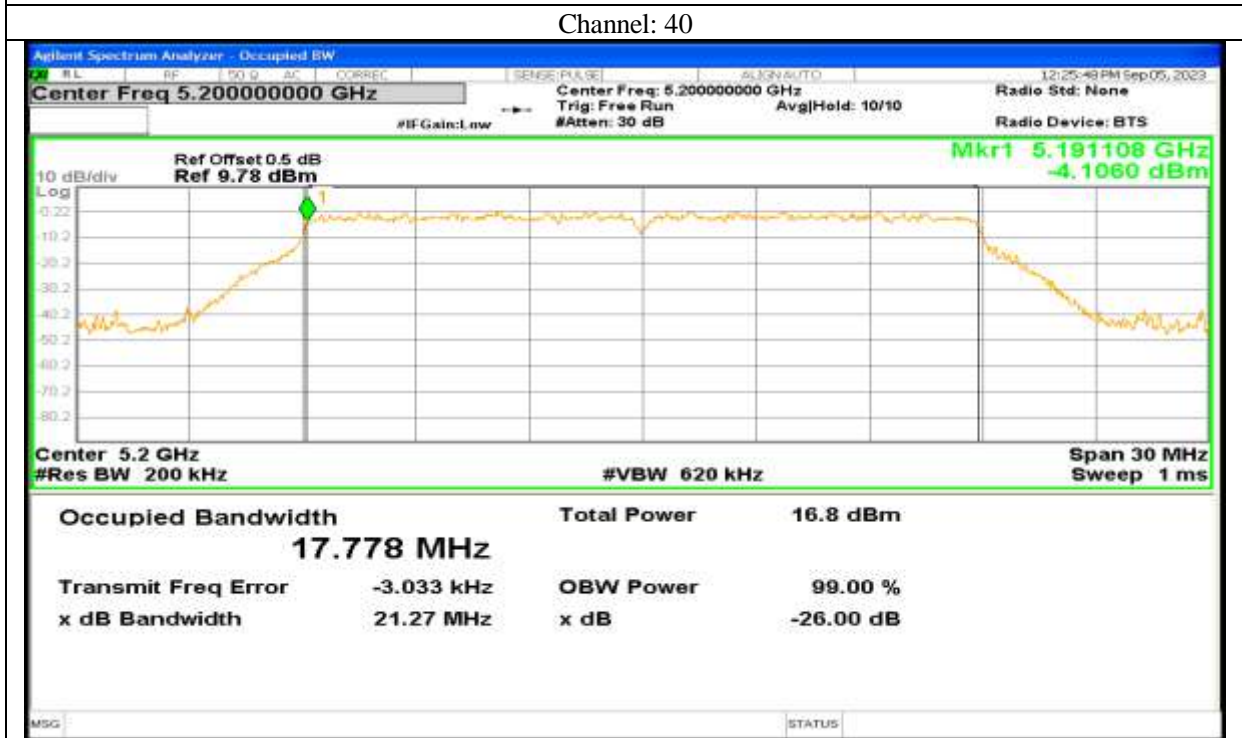
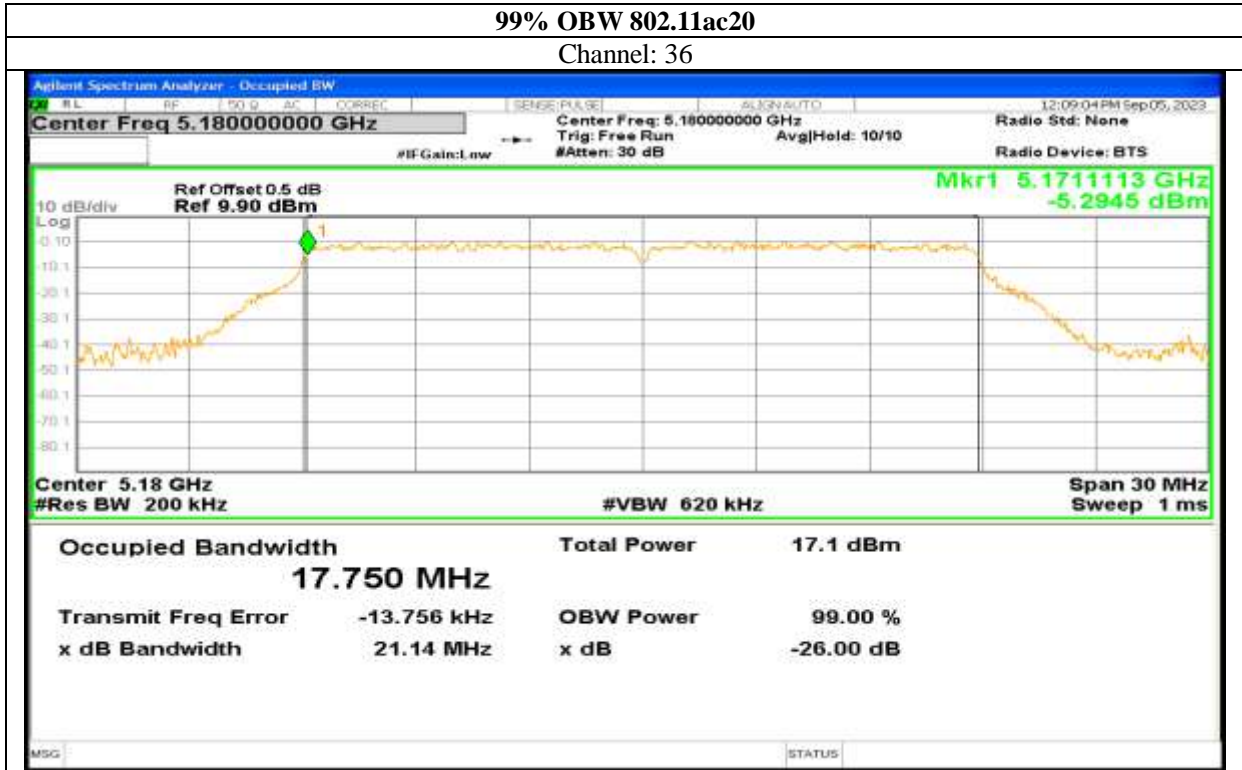

Report No.: AAEMT/RF/230809-01-04

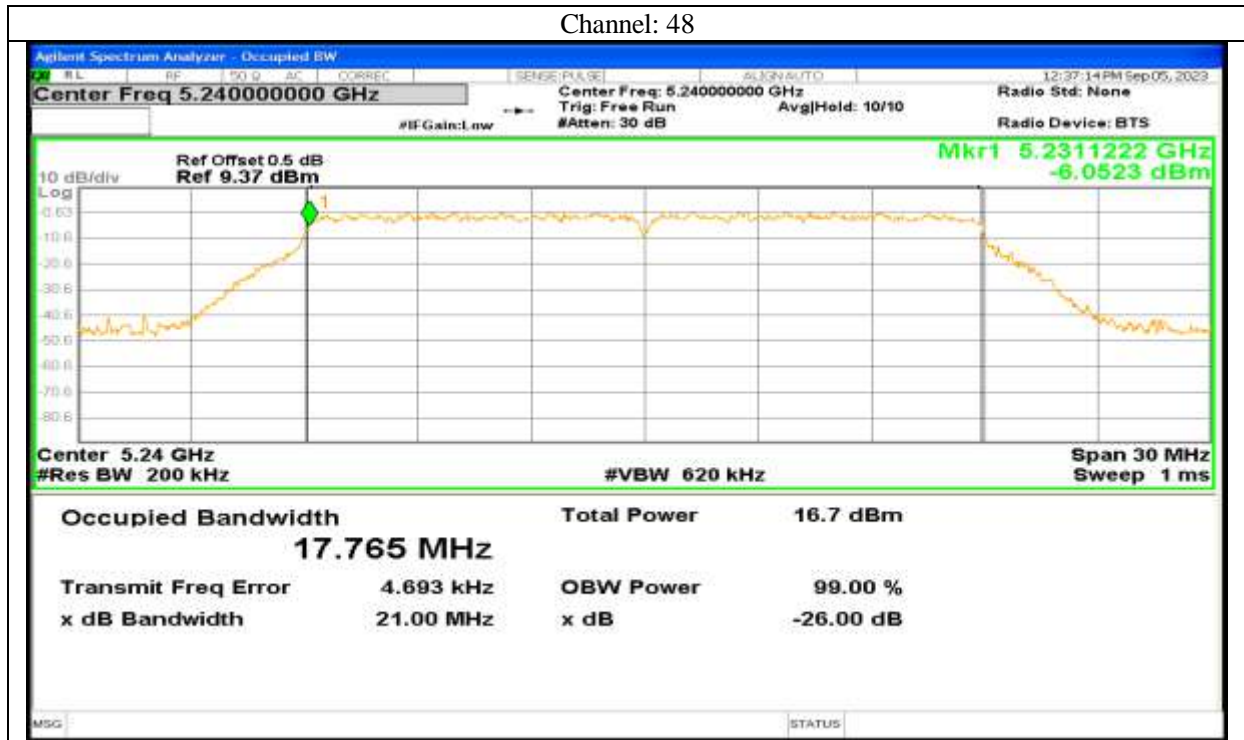

Report No.: AAEMT/RF/230809-01-04

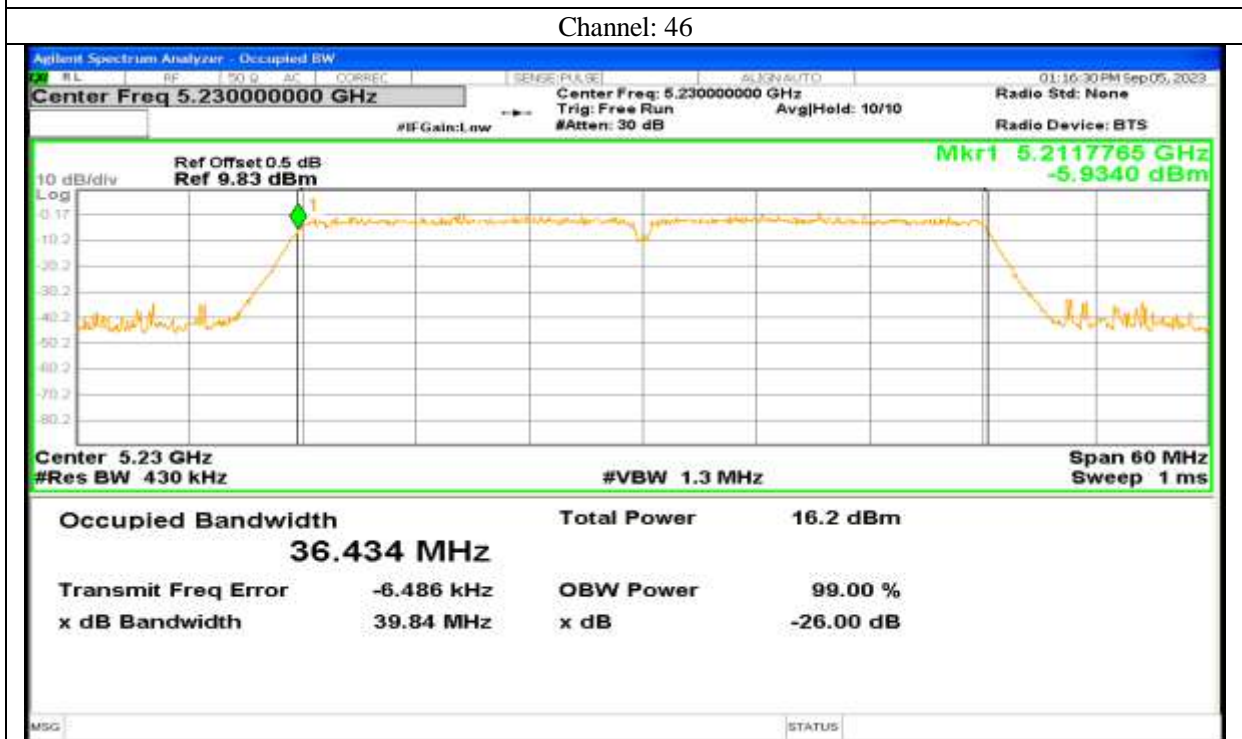
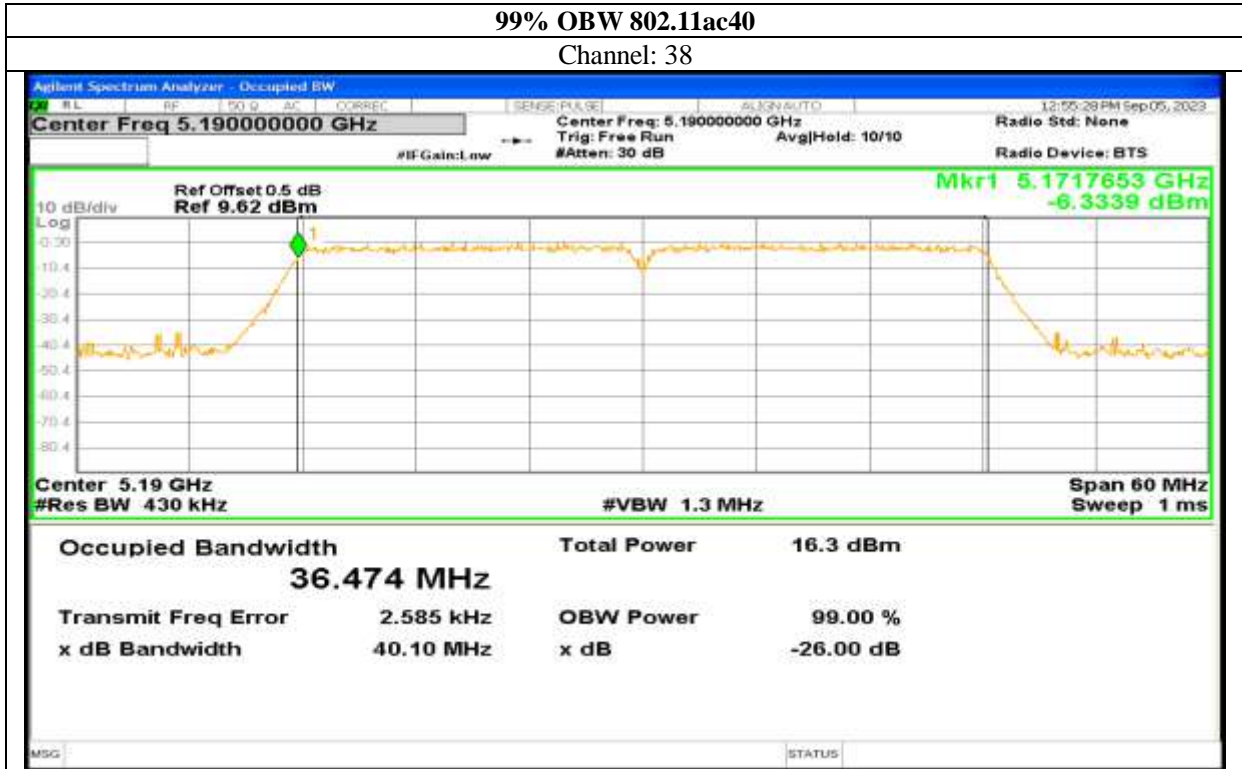

Report No.: AAEMT/RF/230809-01-04

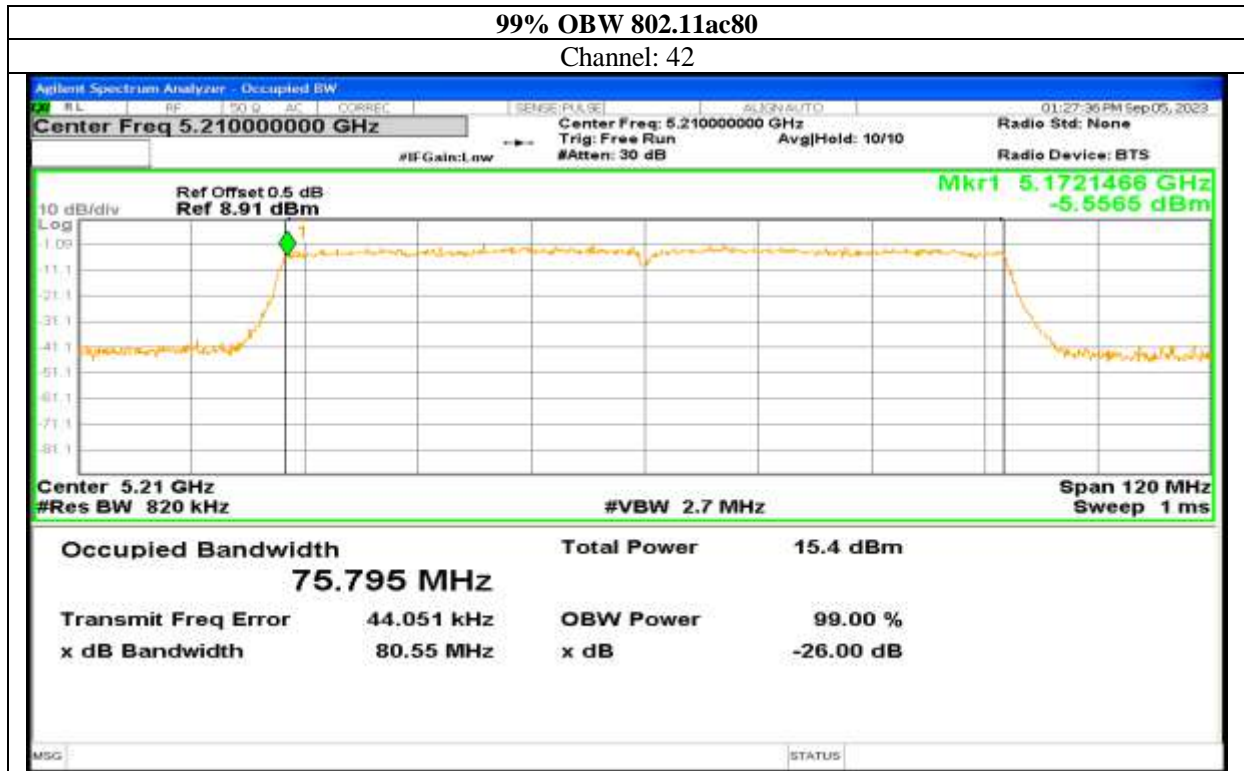

Report No.: AAEMT/RF/230809-01-04

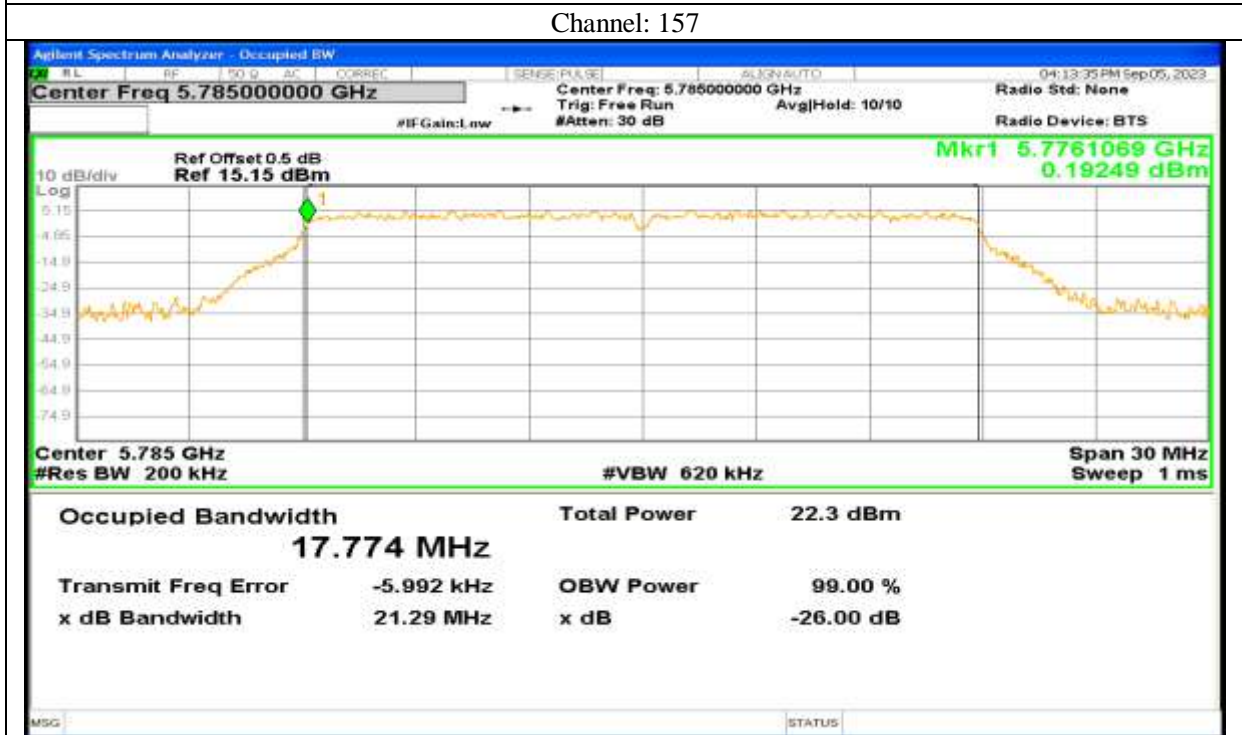
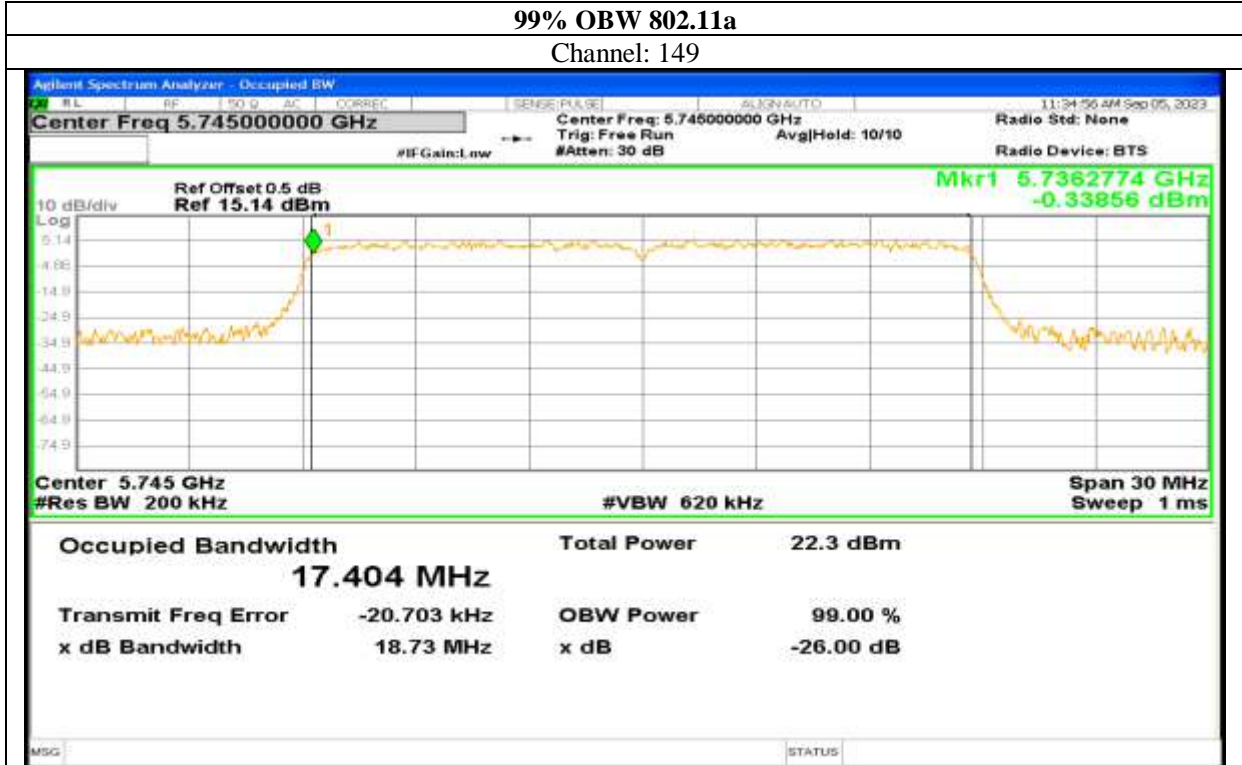

Report No.: AAEMT/RF/230809-01-04

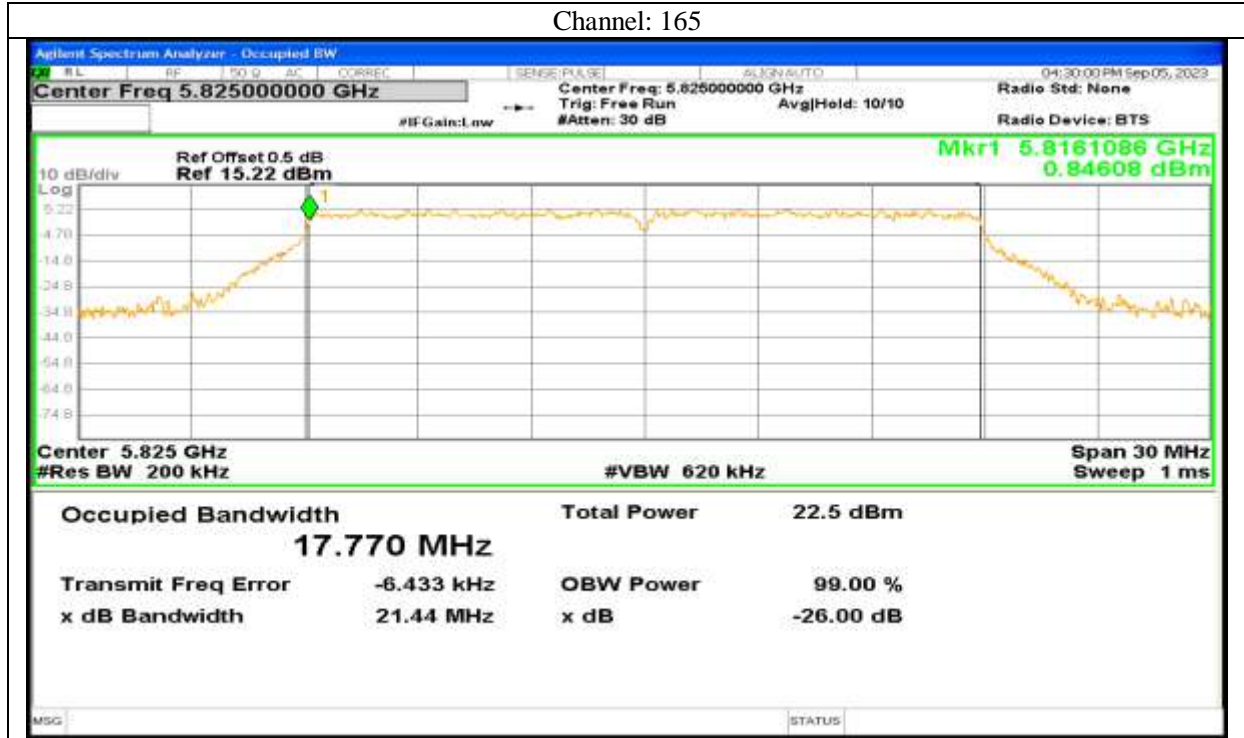

Report No.: AAEMT/RF/230809-01-04

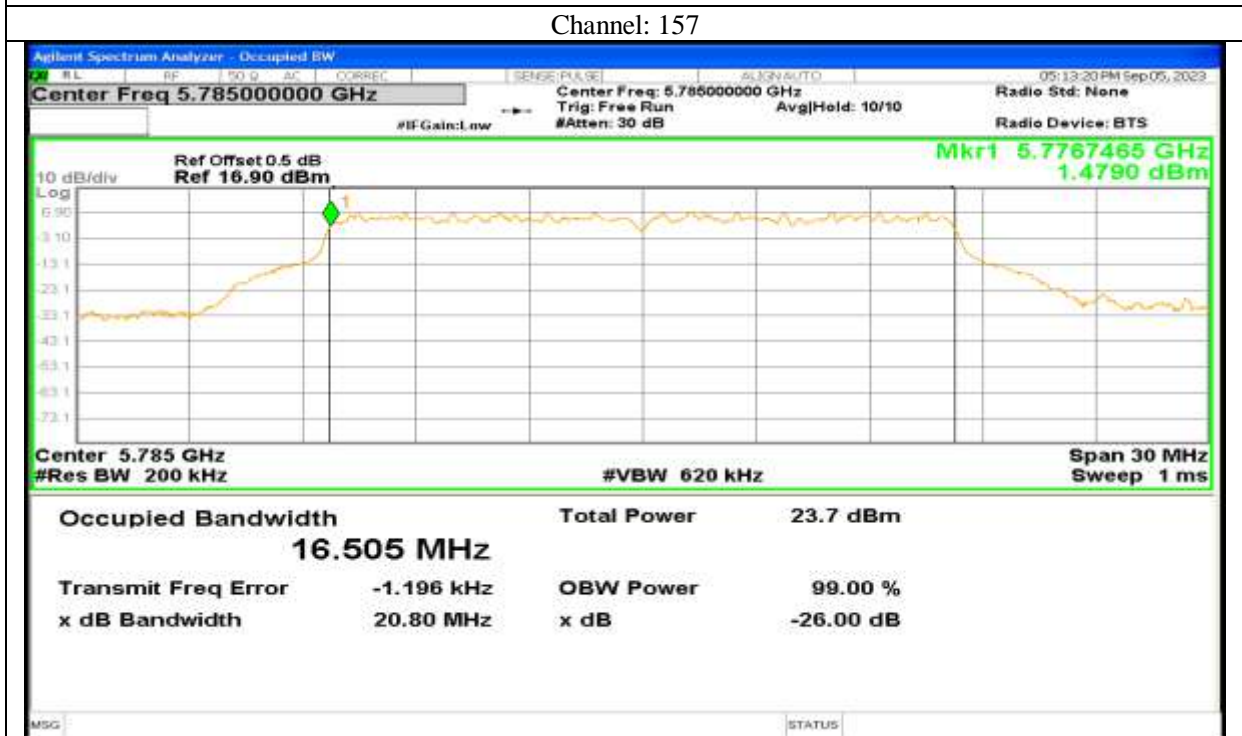
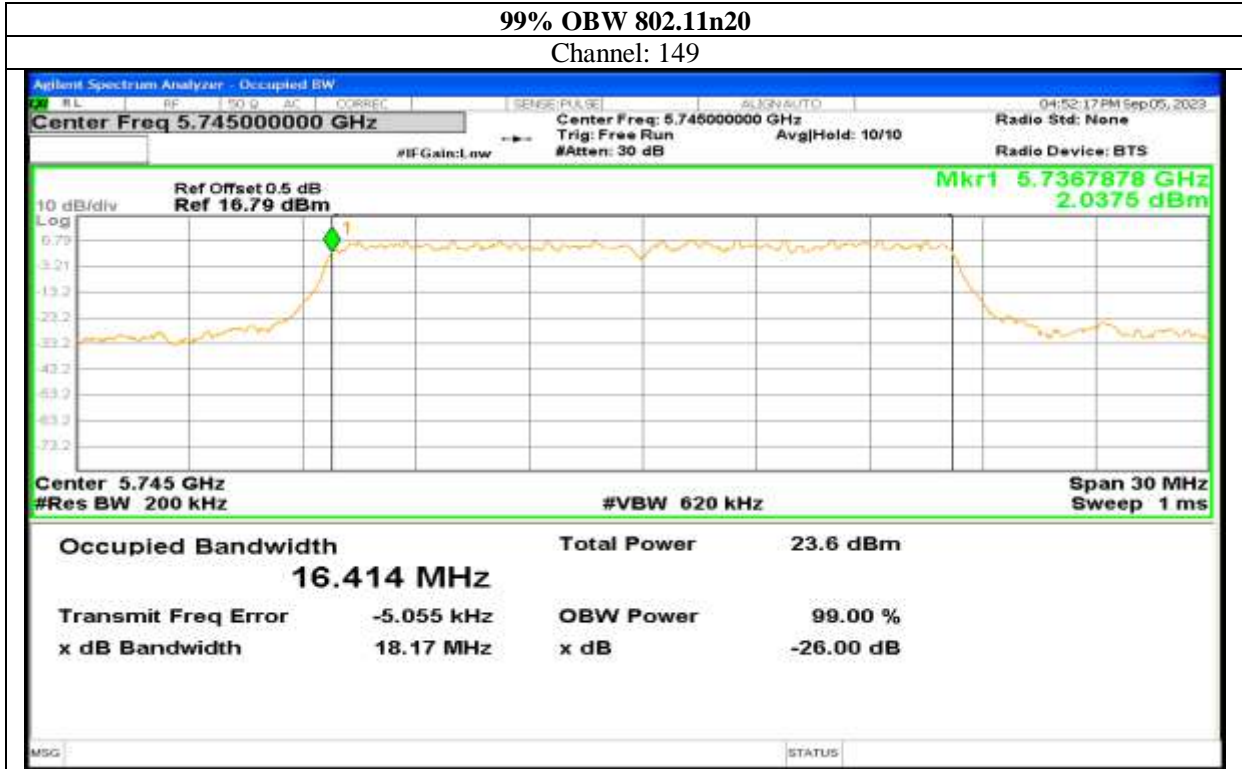

Report No.: AAEMT/RF/230809-01-04

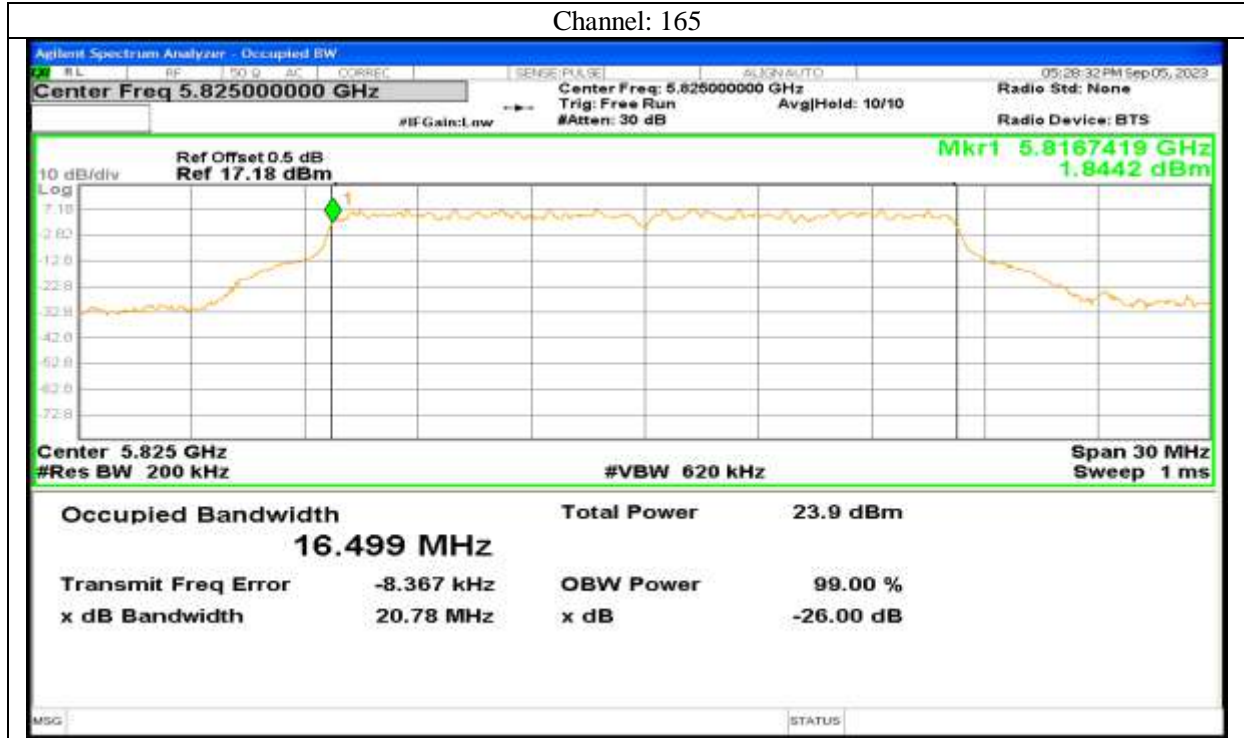

Report No.: AAEMT/RF/230809-01-04

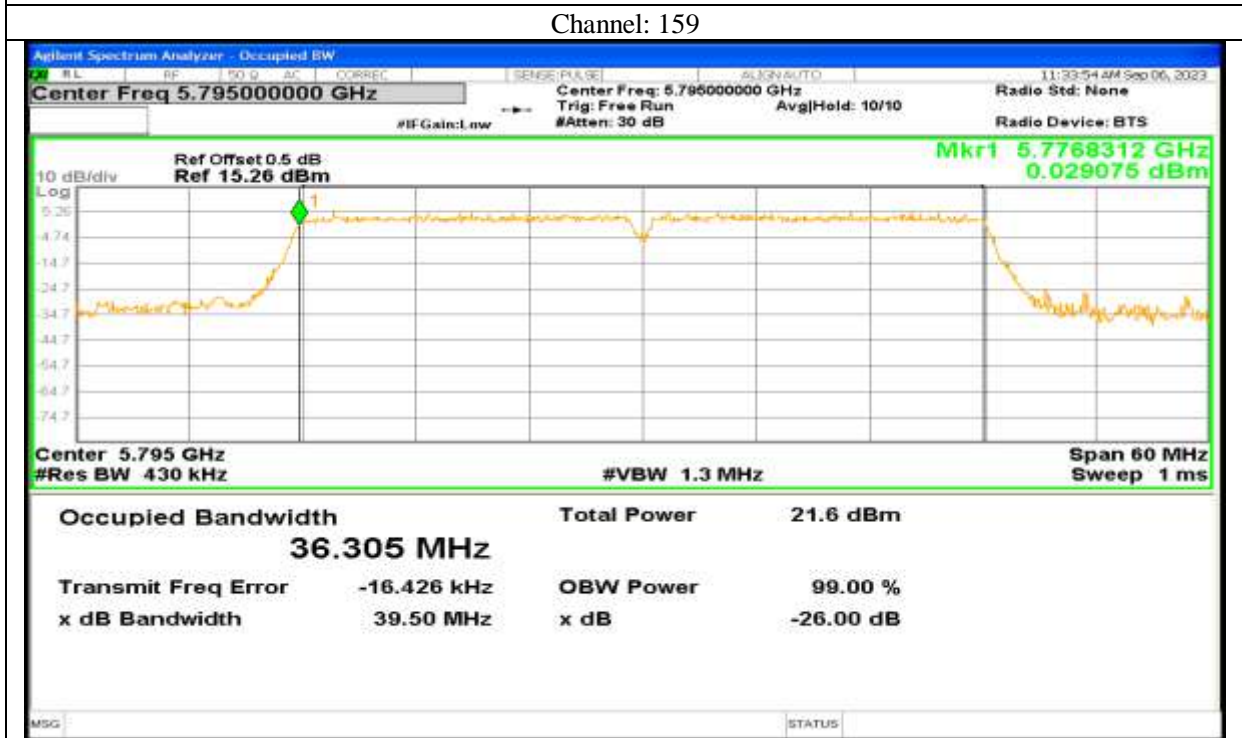
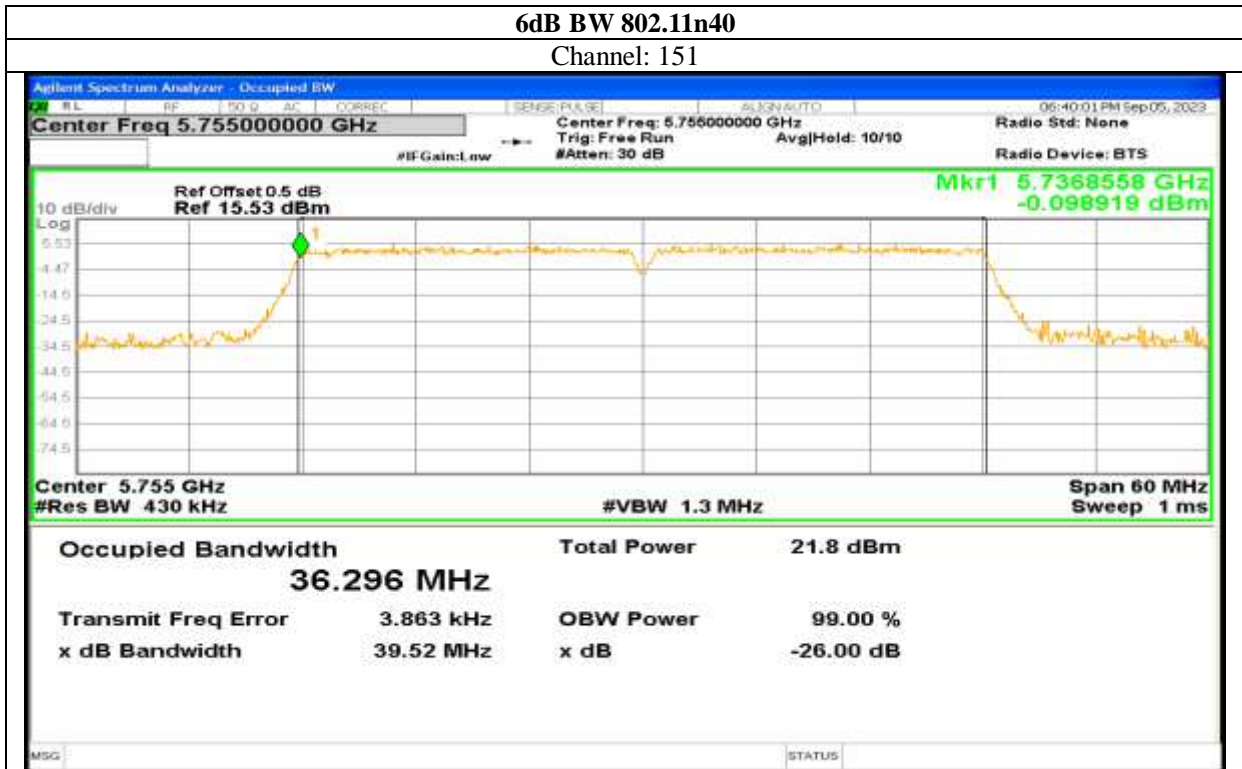

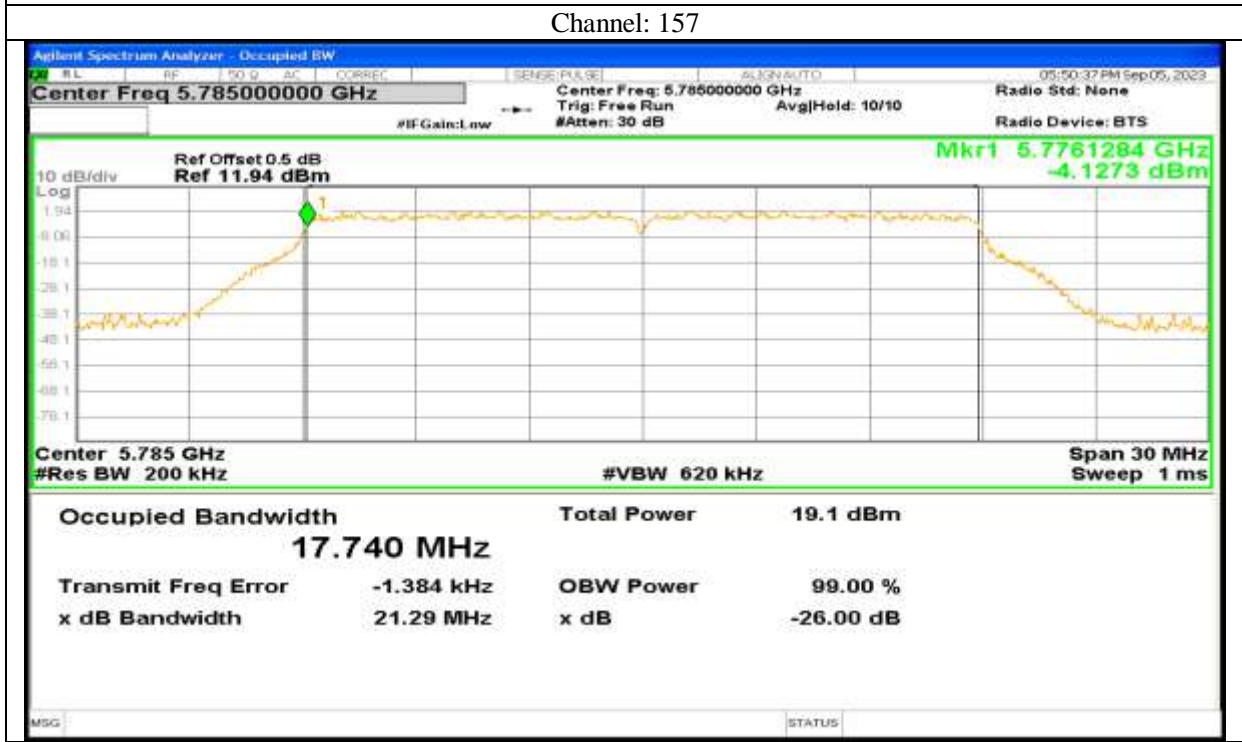
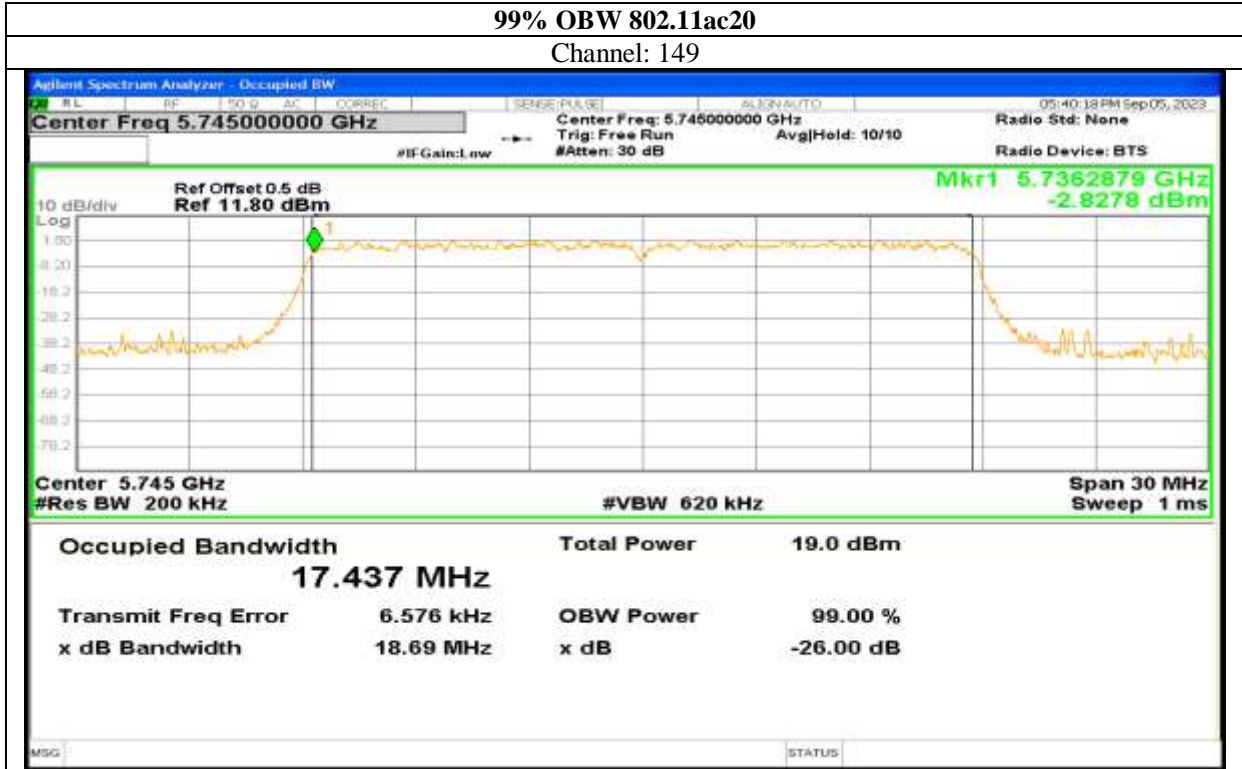

Report No.: AAEMT/RF/230809-01-04

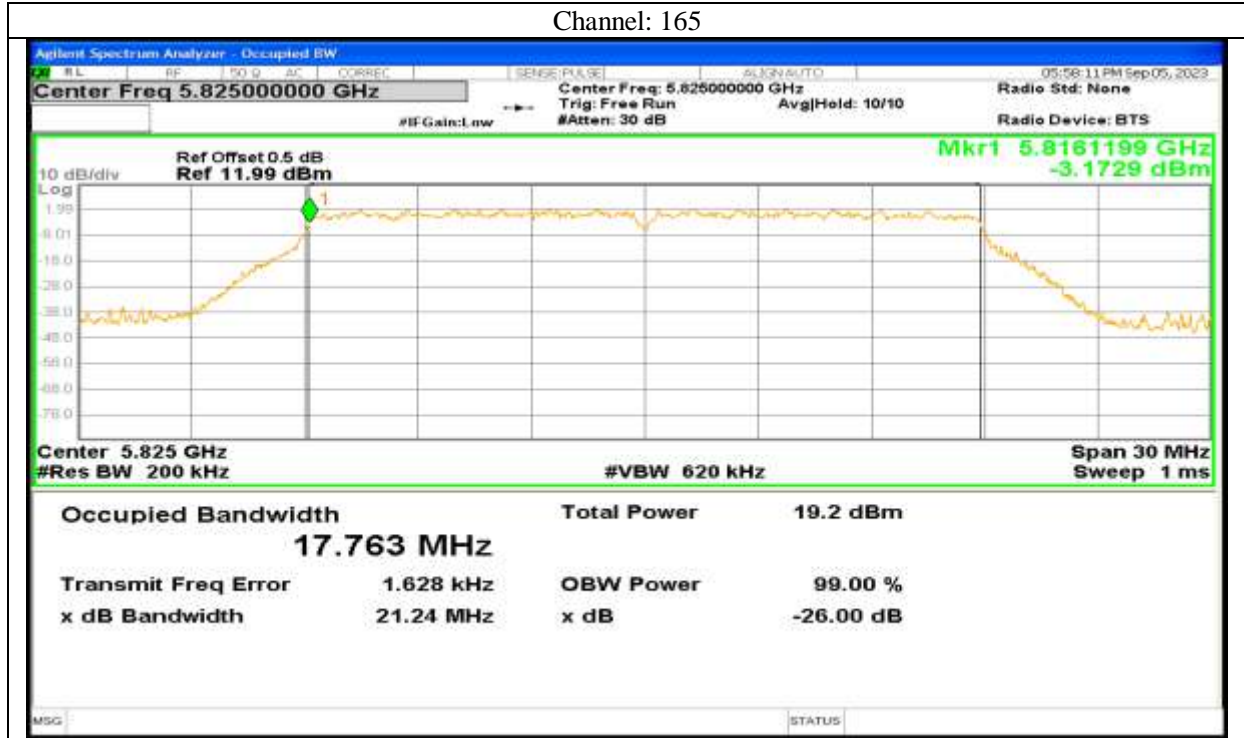

Report No.: AAEMT/RF/230809-01-04

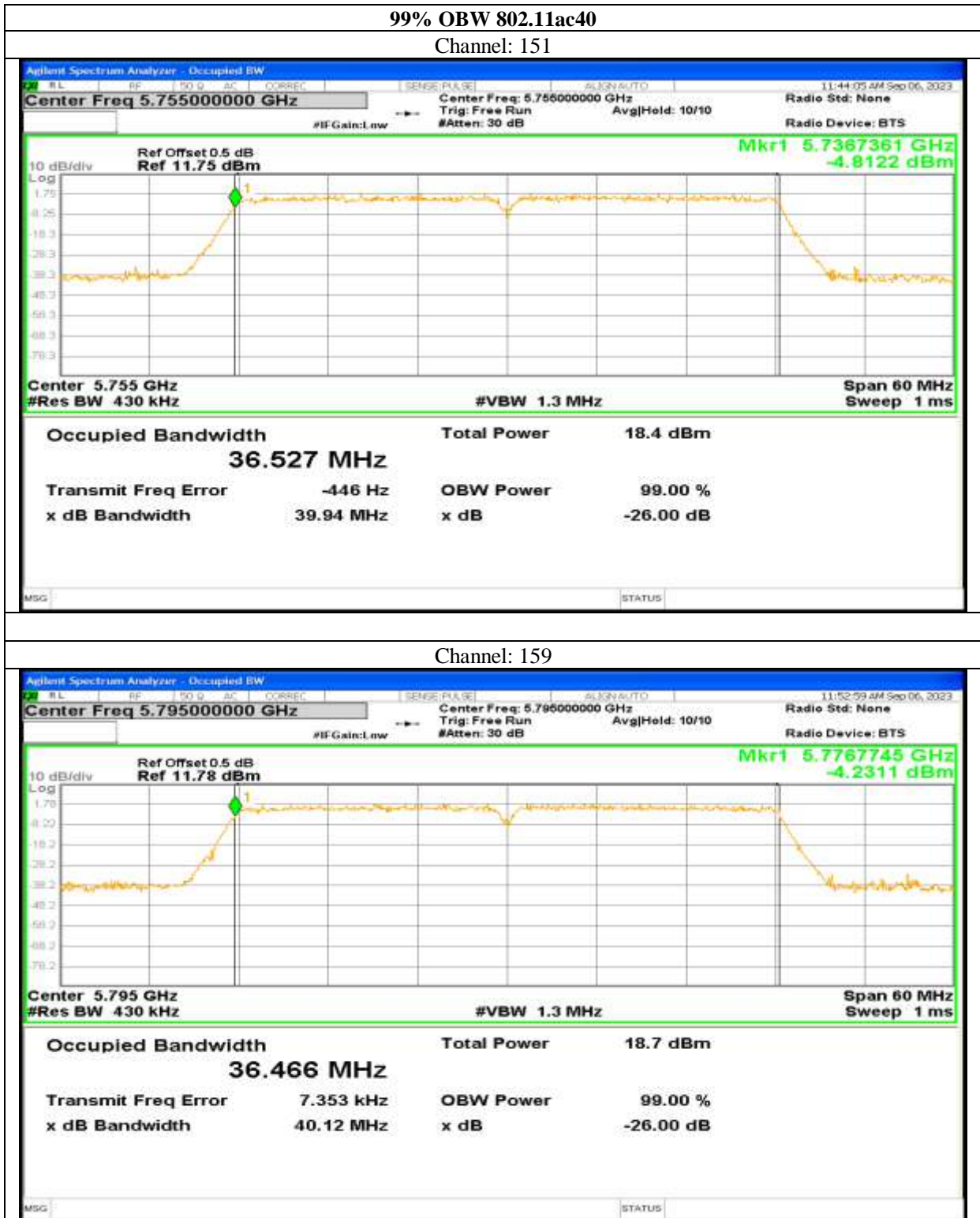

Report No.: AAEMT/RF/230809-01-04

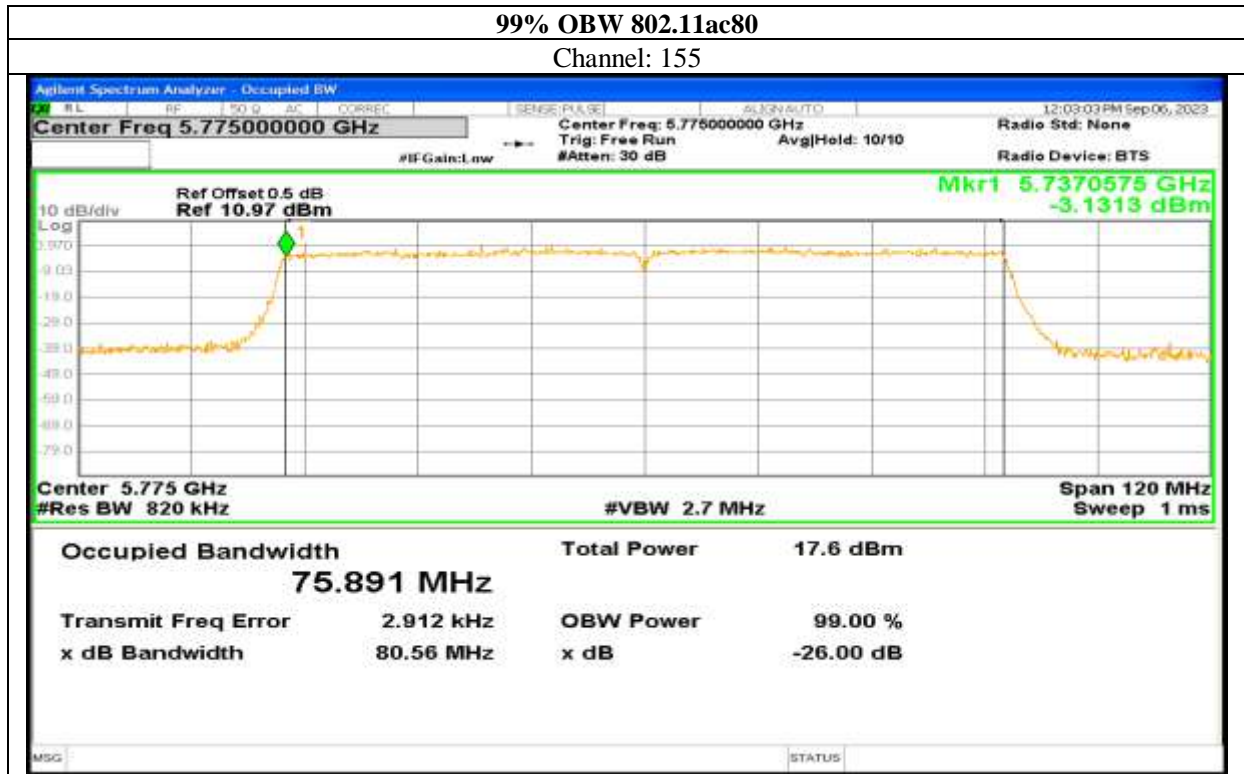

6. MAXIMUM CONDUCTED OUTPUT POWER

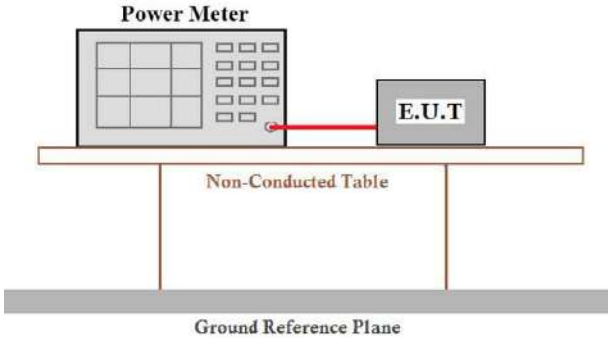
Test Requirement:	FCC Part15 E Section 15.407
Test Method:	KDB 789033 D02 General UNII Test Procedures New Rules v02r01
Limit:	For the band 5.15-5.25 GHz, the maximum conducted output power over the frequency bands of operation shall not exceed 250mW. For the band 5.745-5.850 GHz, the maximum conducted output power over the frequency bands of operation shall not exceed 30dBm
Test setup:	
Test procedure:	<p style="text-align: center;">Measurement using an RF average power meter</p> <ul style="list-style-type: none"> (i) Measurements may be performed using a wideband RF power meter with a thermocouple detector or equivalent if all of the conditions listed below are satisfied <ul style="list-style-type: none"> a) The EUT is configured to transmit continuously or to transmit with a constant duty cycle. b) At all times when the EUT is transmitting, it must be transmitting at its maximum power control level. c) The integration period of the power meter exceeds the repetition period of the transmitted signal by at least a factor of five. (ii) If the transmitter does not transmit continuously, measure the duty cycle, x, of the transmitter output signal as described in section B). (iii) Measure the average power of the transmitter. This measurement is an average over both the on and off periods of the transmitter. (iv) Adjust the measurement in dBm by adding $10 \log(1/x)$ where x is the duty cycle (e.g., $10 \log(1/0.25)$ if the duty cycle is 25 percent).
Test Instruments:	Refer to section 3 for details
Test mode:	Refer to section 6 for details

6.1. TEST RESULT

CH. No.	Frequency (MHz)	Output Power (dBm)			Limit(dBm)	Result
		802.11a	802.11n (HT20)	802.11ac (VHT20)		
36	5180.00	23.46	21.62	18.12	23.98	Pass
40	5200.00	23.34	21.65	17.81	23.98	Pass
48	5240.00	23.19	21.41	17.67	23.98	Pass
149	5745.00	23.33	25.07	19.91	30	Pass
157	5785.00	23.47	25.11	20.18	30	Pass
165	5825.00	23.64	25.32	20.24	30	Pass

CH. No.	Frequency (MHz)	Output Power (dBm)		Limit(dBm)	Result
		802.11n (HT40)	802.11ac (VHT40)		
38	5190.00	20.92	17.78	23.98	Pass
46	5230.00	20.81	17.82	23.98	Pass
151	5755.00	23.30	19.92	30	Pass
159	5795.00	23.25	20.23	30	Pass

CH. No.	Frequency (MHz)	Output Power (dBm)	Limit(dBm)	Result
		802.11ac(VHT80)		
42	5210.00	17.36	23.98	Pass
155	5775.00	19.71	30	Pass

Report No.: AAEMT/RF/230809-01-04

7. Band Edges Measurement

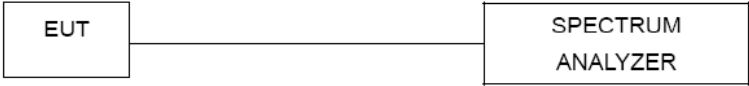
Test Requirement:	FCC Part15 E Section 15.407 and 5.205
Test Method:	ANSI C63.10:2013
Limit:	<p>Undesirable emission limits:</p> <p>(1) For transmitters operating in the 5.15-5.25 GHz band: all emissions outside of the 5.15-5.35 GHz band shall not exceed an EIRP of -27 dBm/MHz.</p> <p>(2) For transmitters operating in the 5.25-5.35 GHz band: all emissions outside of the 5.15-5.35 GHz band shall not exceed an EIRP of -27 dBm/MHz. Devices operating in the 5.25-5.35 GHz band that generate emissions in the 5.15-5.25 GHz band must meet all applicable technical requirements for operation in the 5.15-5.25 GHz band (including indoor use) or alternatively meet an out-of-band emission EIRP limit of -27 dBm/MHz in the 5.15-5.25 GHz band.</p> <p>(3) For transmitters operating in the 5.47-5.725 GHz band: all emissions outside of the 5.47-5.725 GHz band shall not exceed an EIRP of -27 dBm/MHz.</p>
Test Procedure:	<p>a. The Transmitter output of EUT was connected to the spectrum analyzer. Equipment mode: Spectrum analyzer Detector function: Peak mode SPAN: 100MHz RBW: 1 MHz VBW: 1 MHz Sweep time= Auto.</p> <p>b. Using Peak Search to read the peak power of Carrier frequencies after Maximum Hold function is completed.</p> <p>c. Find the next peak frequency outside the operation frequency band.</p>
Test setup:	 <pre> graph LR EUT[EUT] --- SA[SPECTRUM ANALYZER] </pre>
Test results:	Pass

Remark:

Report No.: AAEMT/RF/230809-01-04

7.1. TEST RESULT

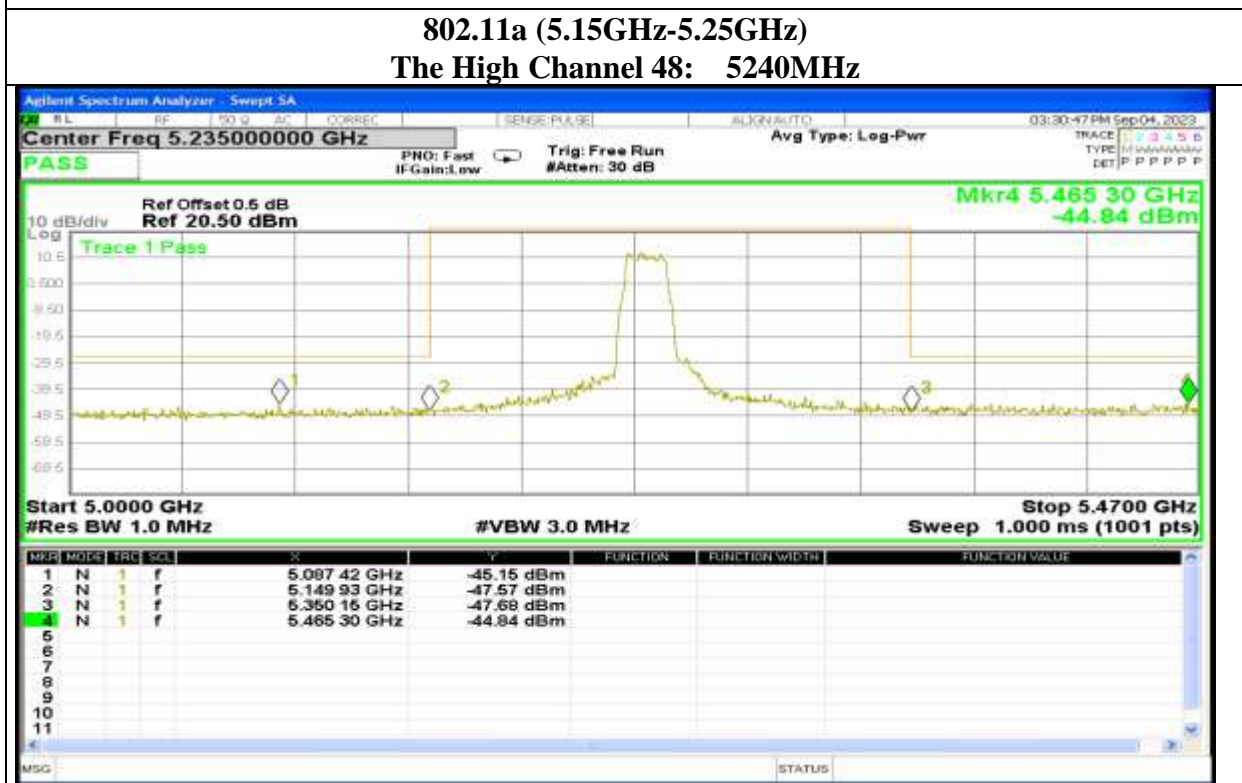

Report No.: AAEMT/RF/230809-01-04

802.11a (5.725GHz-5.85GHz)
The Low Channel 149: 5745MHz

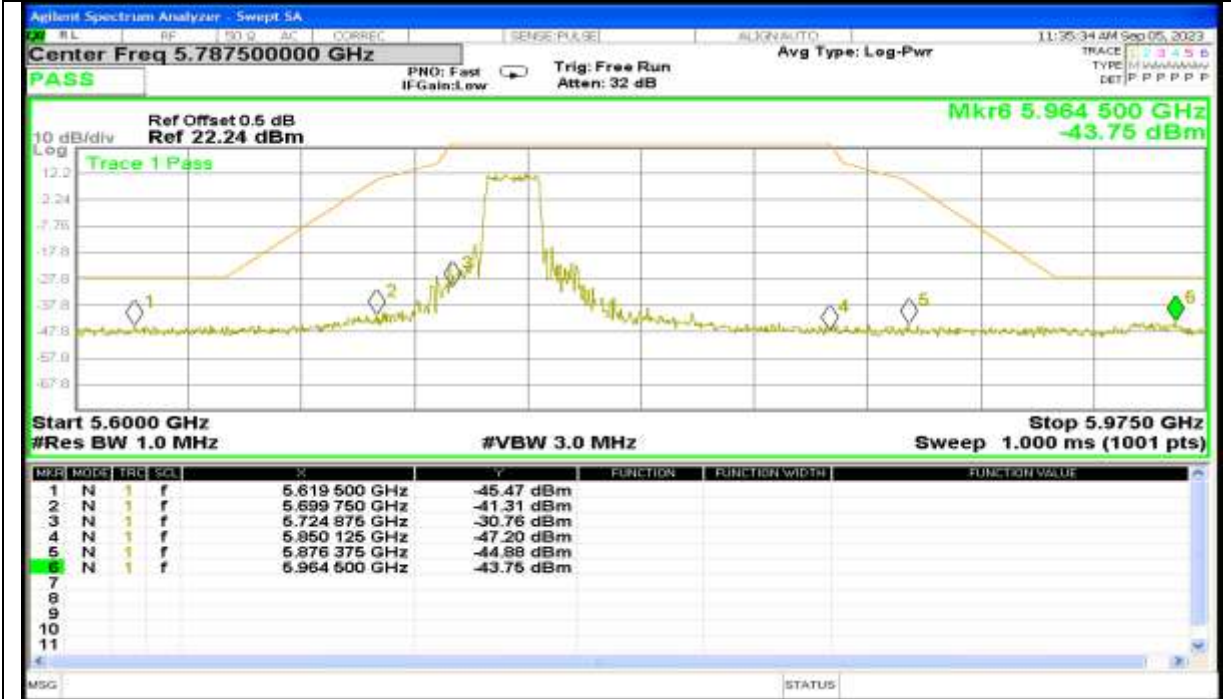

802.11a (5.725GHz-5.85GHz)
The High Channel 165: 5825MHz



Report No.: AAEMT/RF/230809-01-04

**802.11n(20M) (5.15GHz-5.25GHz)
The Lowest Channel 36: 5180MHz**

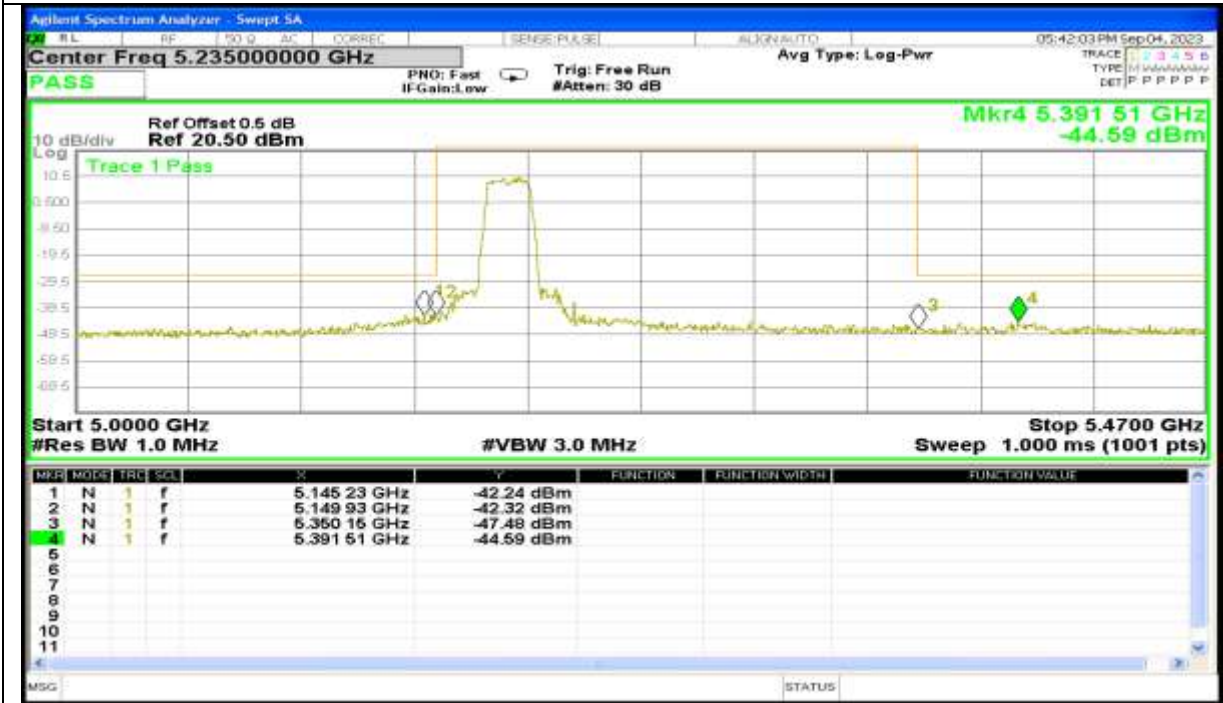

**802.11n(20M) (5.15GHz-5.25GHz)
The High Channel 48: 5240MHz**

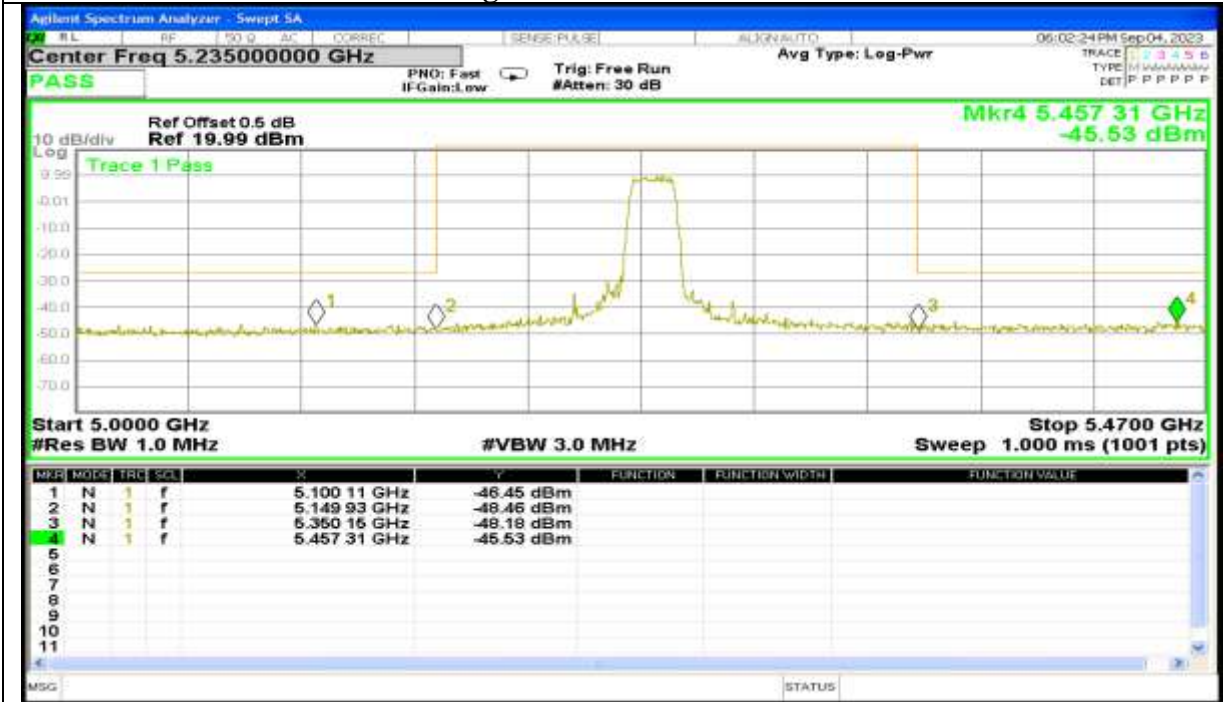

Report No.: AAEMT/RF/230809-01-04

802.11n(20M) (5.725GHz-5.85GHz)
The Low Channel 149: 5745MHz



802.11n(20M) (5.725GHz-5.85GHz)
The High Channel 165: 5825MHz



Report No.: AAEMT/RF/230809-01-04

**802.11ac(20M) (5.15GHz-5.25GHz)
The Lowest Channel 36: 5180MHz**

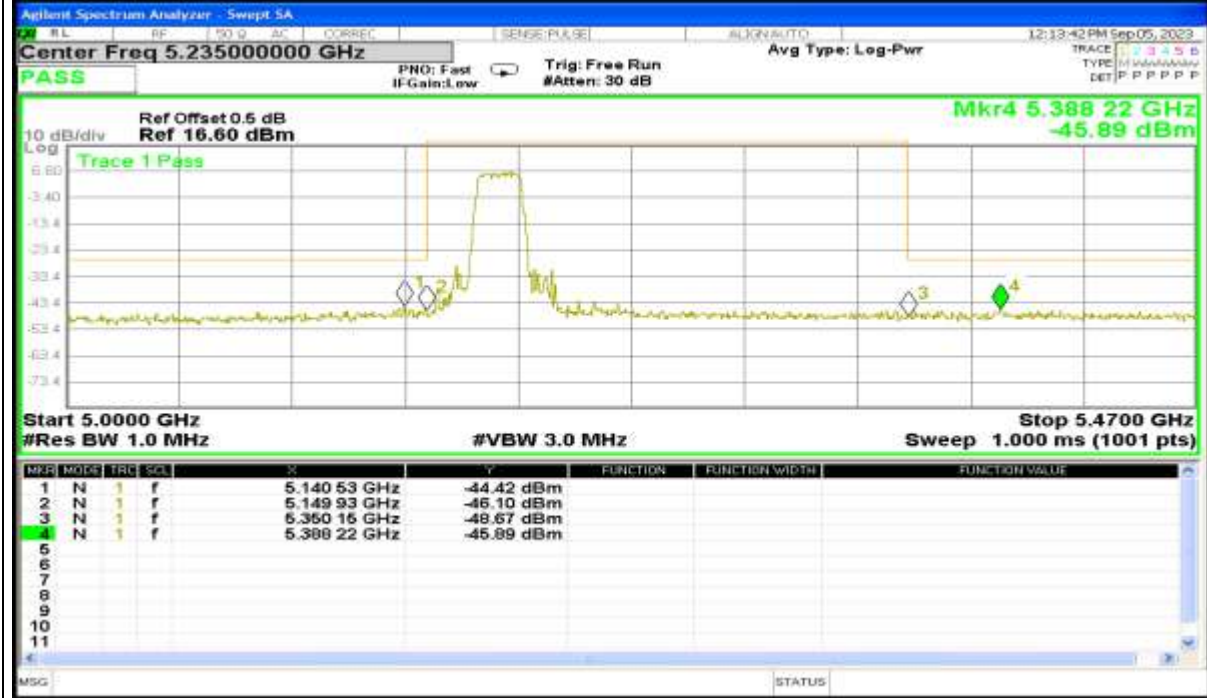

**802.11ac(20M) (5.15GHz-5.25GHz)
The High Channel 48: 5240MHz**



Report No.: AAEMT/RF/230809-01-04

802.11ac(20M) (5.725GHz-5.85GHz)
The Low Channel 149: 5745MHz

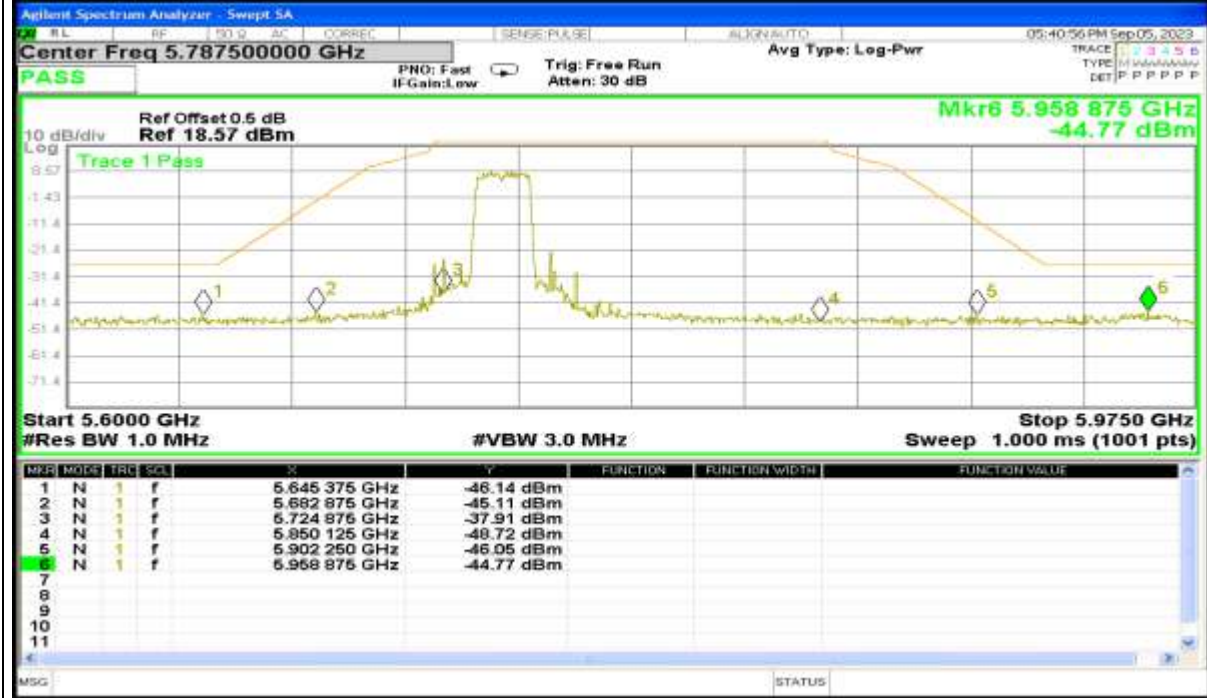

802.11ac(20M) (5.725GHz-5.85GHz)
The High Channel 165: 5825MHz



Report No.: AAEMT/RF/230809-01-04

**802.11n(40M) (5.15GHz-5.25GHz)
The Lowest Channel 38: 5190MHz**

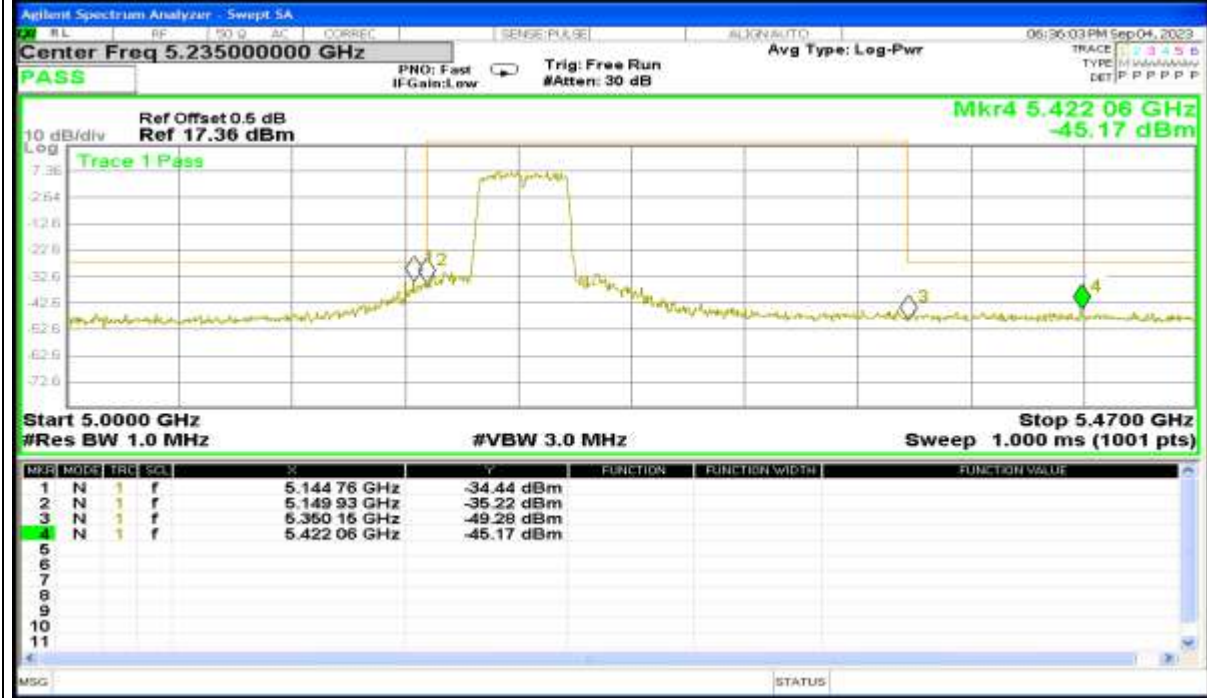

**802.11n(40M) (5.15GHz-5.25GHz)
The High Channel 46: 5230MHz**



Report No.: AAEMT/RF/230809-01-04

802.11n(40M) (5.725GHz-5.85GHz)
The Lowest Channel 151: 5755MHz

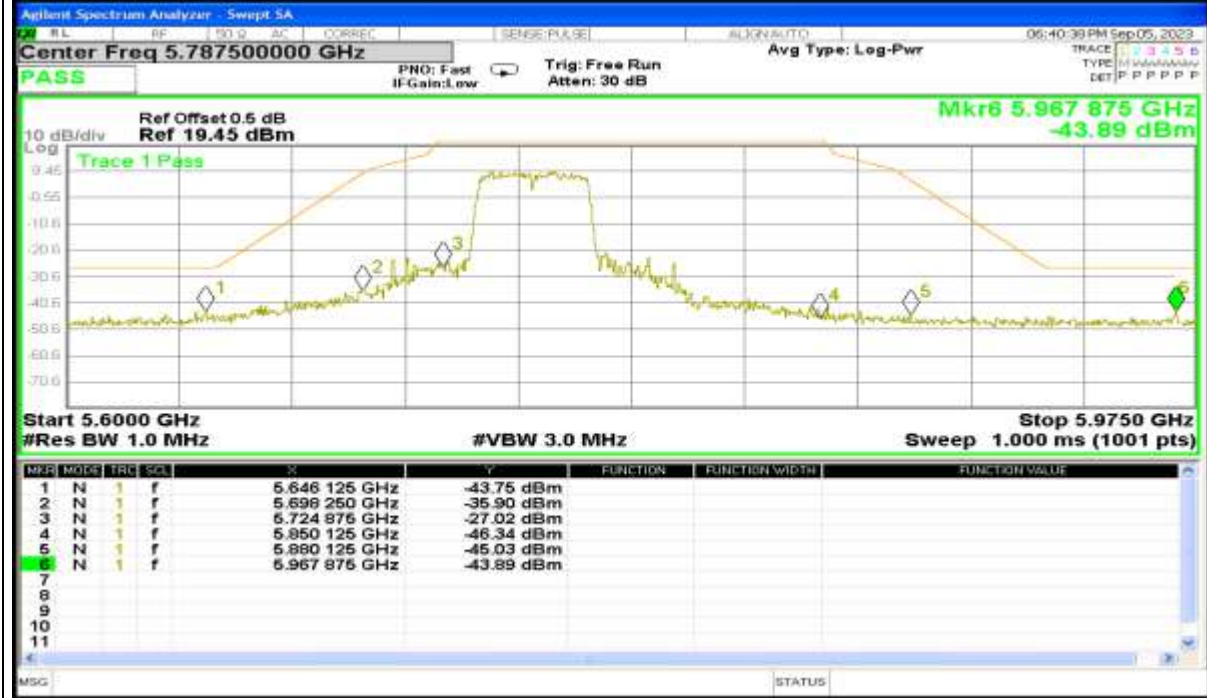

802.11n(40M) (5.725GHz-5.85GHz)
The High Channel 159: 5795MHz



Report No.: AAEMT/RF/230809-01-04

**802.11ac(40M) (5.15GHz-5.25GHz)
The Lowest Channel 38: 5190MHz**

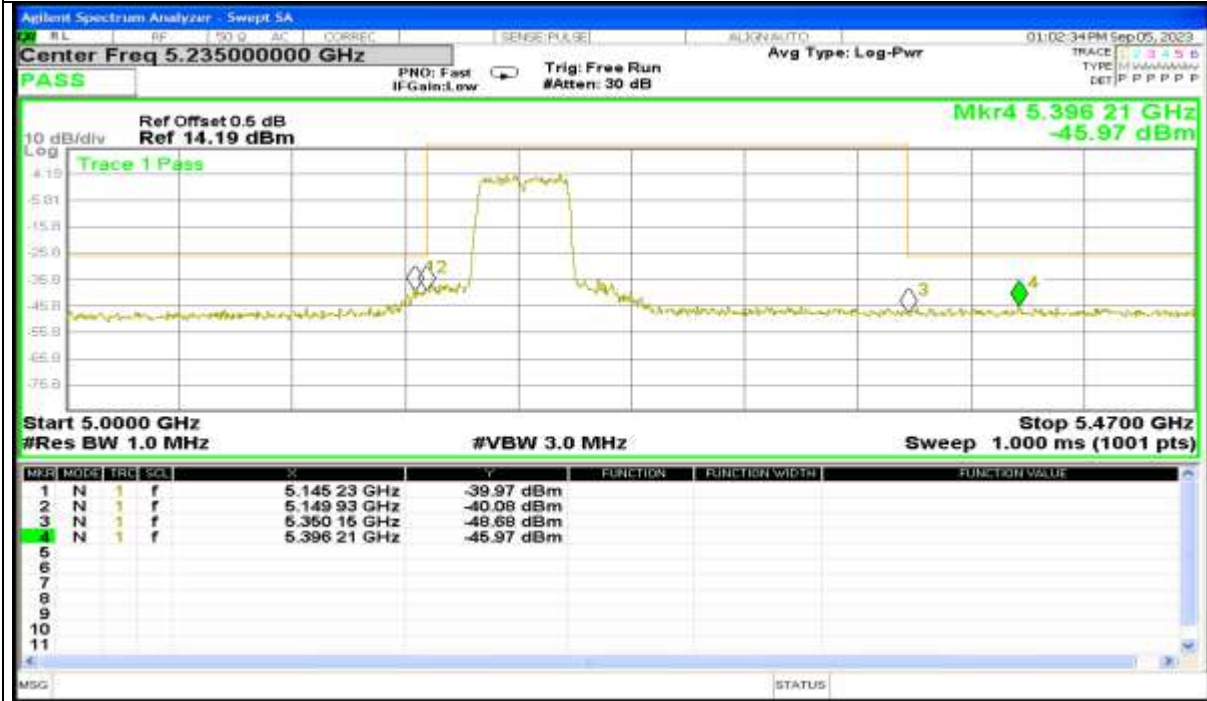

**802.11ac(40M) (5.15GHz-5.25GHz)
The High Channel 46: 5230MHz**

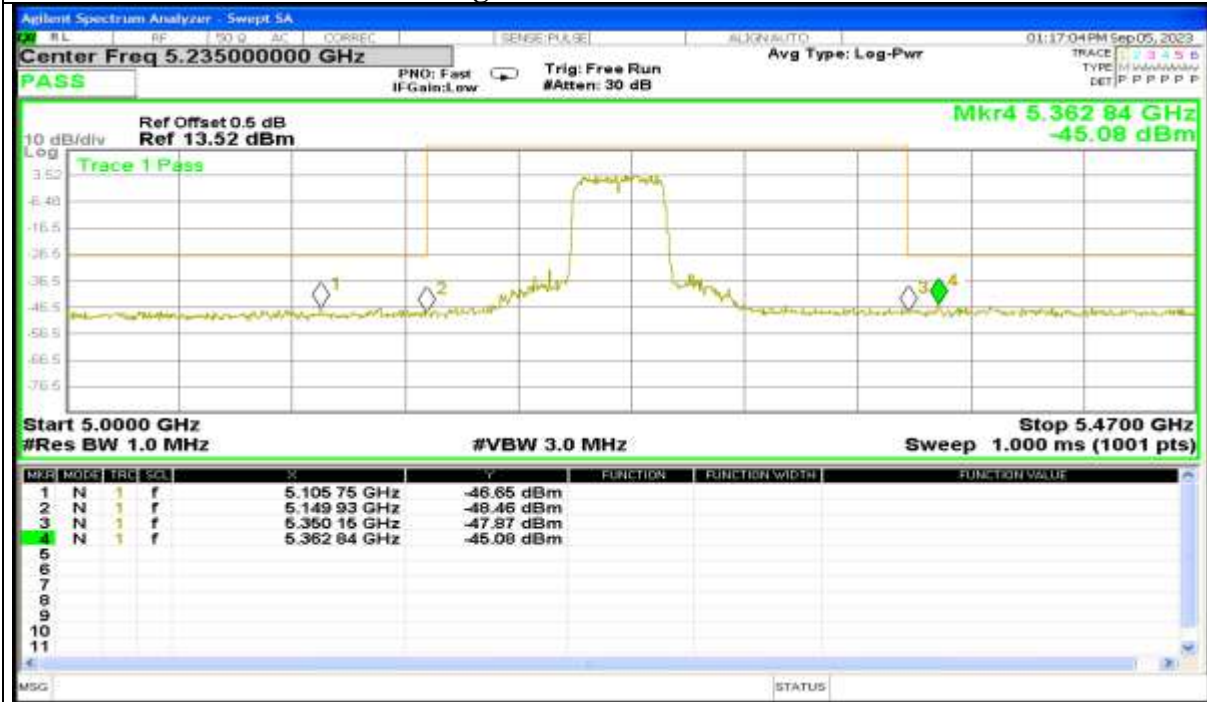

Report No.: AAEMT/RF/230809-01-04

**802.11ac(40M) (5.725GHz-5.85GHz)
The Lowest Channel 151: 5755MHz**

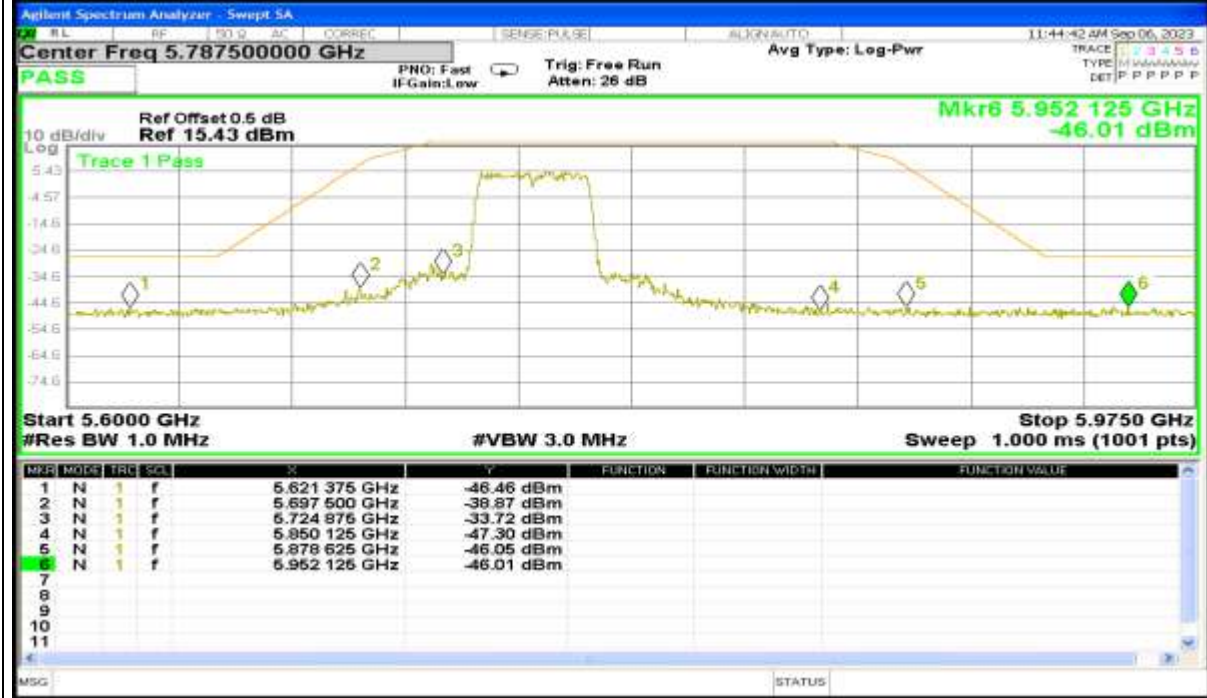

**802.11ac(40M) (5.725GHz-5.85GHz)
The High Channel 159: 5795MHz**



Report No.: AAEMT/RF/230809-01-04

**802.11ac(80M) (5.15GHz-5.25GHz)
The Lowest Channel 42: 5210MHz**

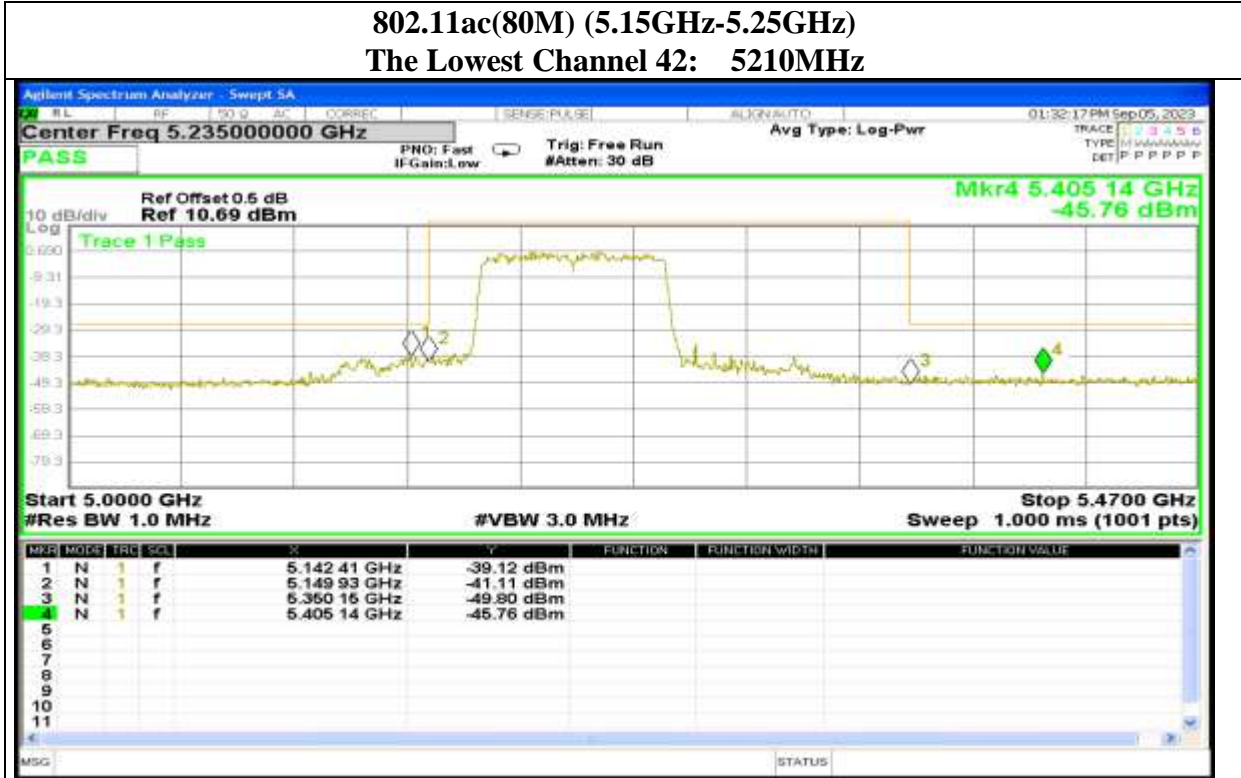

**802.11ac(80M) (5.725GHz-5.85GHz)
The High Channel 155: 5775MHz**

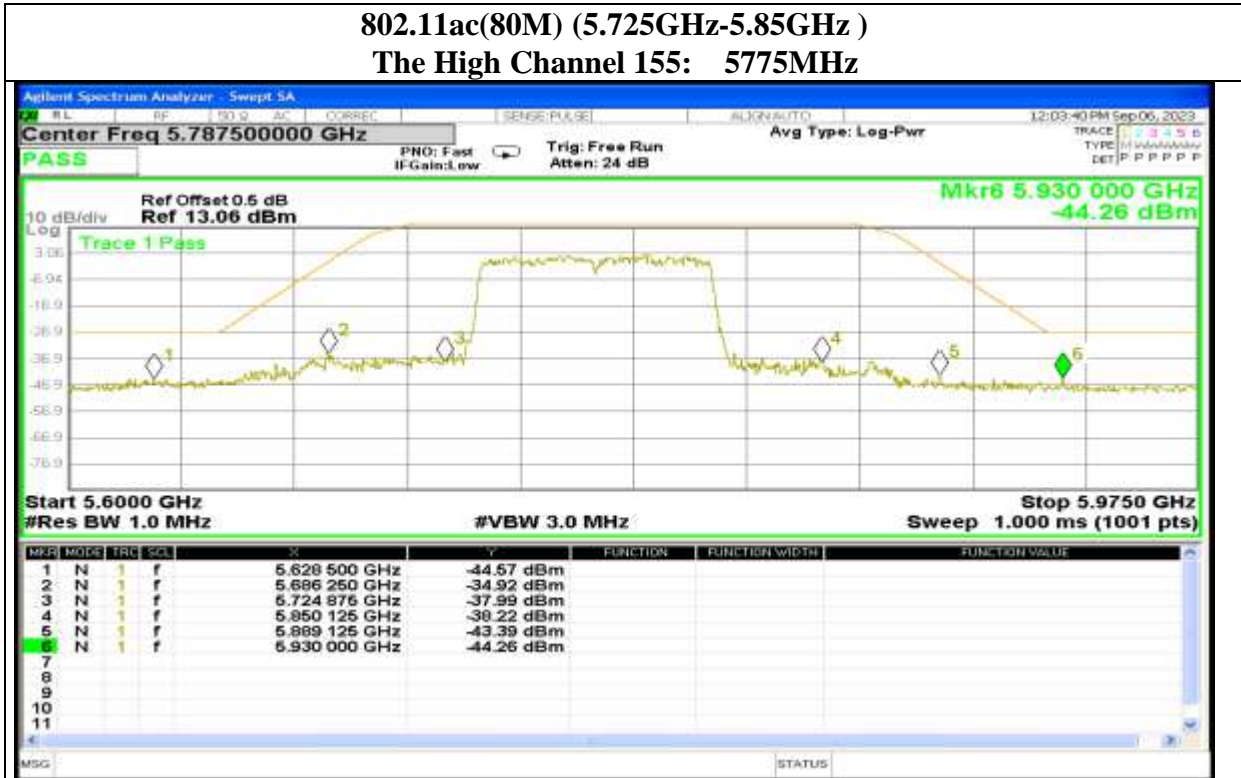

8. RADIATED EMISSION MEASUREMENT

8.1. Block diagram of test setup

In 3m Anechoic Chamber Test Setup Diagram for 9KHz-30MHz

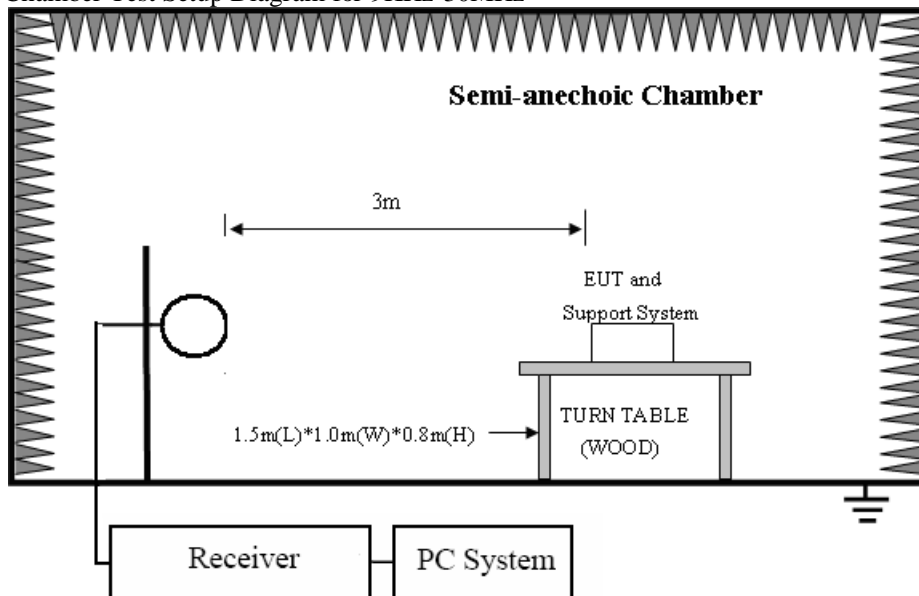

In 3m Anechoic Chamber Test Setup Diagram for 30MHz-1GHz

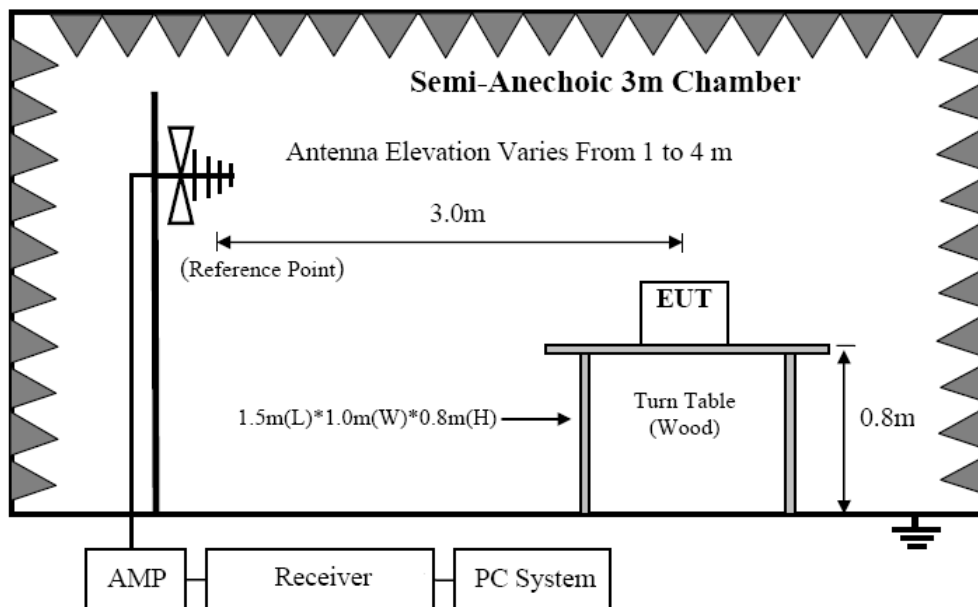

Report No.: AAEMT/RF/230809-01-04

In 3m Anechoic Chamber Test Setup Diagram for frequency above 1GHz

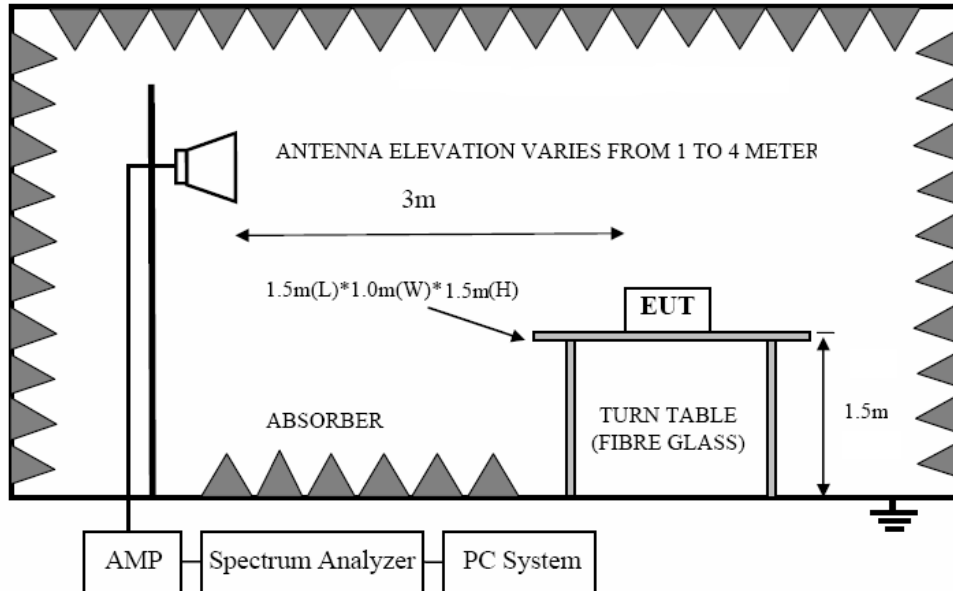

Note: For harmonic emissions test a appropriate high pass filter was inserted in the input port of AMP.

8.2. Limit

9.3.1 FCC 15.205 Restricted frequency band

MHz	MHz	MHz	GHz
0.090 - 0.110	16.42 - 16.423	399.9 - 410	4.5 - 5.15
¹ 0.495 - 0.505	16.69475 - 16.69525	608 - 614	5.35 - 5.46
2.1735 - 2.1905	16.80425 - 16.80475	960 - 1240	7.25 - 7.75
4.125 - 4.128	25.5 - 25.67	1300 - 1427	8.025 - 8.5
4.17725 - 4.17775	37.5 - 38.25	1435 - 1626.5	9.0 - 9.2
4.20725 - 4.20775	73 - 74.6	1645.5 - 1646.5	9.3 - 9.5
6.215 - 6.218	74.8 - 75.2	1660 - 1710	10.6 - 12.7
6.26775 - 6.26825	108 - 121.94	1718.8 - 1722.2	13.25 - 13.4
6.31175 - 6.31225	123 - 138	2200 - 2300	14.47 - 14.5
8.291 - 8.294	149.9 - 150.05	2310 - 2390	15.35 - 16.2
8.362 - 8.366	156.52475 - 156.52525	2483.5 - 2500	17.7 - 21.4
8.37625 - 8.38675	156.7 - 156.9	2690 - 2900	22.01 - 23.12
8.41425 - 8.41475	162.0125 - 167.17	3260 - 3267	23.6 - 24.0
12.29 - 12.293	167.72 - 173.2	3332 - 3339	31.2 - 31.8
12.51975 - 12.52025	240 - 285	3345.8 - 3358	36.43 - 36.5
12.57675 - 12.57725	322 - 335.4	3600 - 4400	(²)

9.3.2. FCC 15.209 Limit.

FREQUENCY MHz	DISTANCE Meters	FIELD STRENGTHS LIMIT	
		μV/m	dB(μV)/m
0.009 ~ 0.490	300	2400/F(KHz)	67.6-20log(F)
0.490 ~ 1.705	30	24000/F(KHz)	87.6-20log(F)
1.705 ~ 30.0	30	30	29.54
30 ~ 88	3	100	40.0
88 ~ 216	3	150	43.5
216 ~ 960	3	200	46.0
960 ~ 1000	3	500	54.0
Above 1000	3	74.0 dB(μV)/m (Peak) 54.0 dB(μV)/m (Average)	

Note: (1) The emission limits shown in the above table are based on measurements employing a CISPR QP detector except for the frequency bands 9-90KHz, 110-490KHz and above 1000MHz. Radiated emissions limits in these three bands are based on measurements employing an average detector.

(2) At frequencies below 30MHz, measurement may be performed at a distance closer then that specified, and the limit at closer measurement distance can be extrapolated by below formula:

$$\text{Limit}_{3m}(\text{dBuV/m}) = \text{Limit}_{30m}(\text{dBuV/m}) + 40\text{Log}(30m/3m)$$

9.3.3. Limit for this EUT

All the emissions appearing within 15.205 restricted frequency bands shall not exceed the limits shown in 15.209, all the other emissions shall be at least 30dB below the fundamental emissions, or comply with 15.209 limits.

8.3. Test Procedure

- (1) EUT was placed on a non-metallic table, 80 cm above the ground plane inside a semi-anechoic chamber.
- (2) Setup EUT and assistant system according clause 2.4 and 7.2
- (3) Test antenna was located 3m(except 18GHz-40GHz was 1m) from the EUT on an adjustable mast, and the antenna used as below table.

Test frequency range	Test antenna used
9KHz-30MHz	Active Loop antenna
30MHz-1GHz	Bilog Broadband Antenna
1GHz-18GHz	Double Ridged Horn Antenna(1GHz-18GHz)
18GHz-40GHz	Horn Antenna(18GHz-40GHz)

According ANSI C63.10:2013 clause 6.4.4.2 and 6.5.3, for measurements below 30 MHz, the loop antenna was positioned with its plane vertical from the EUT and rotated about its vertical axis for maximum response at each azimuth position around the EUT. And the loop antenna also be positioned with its plane horizontal at the specified distance from the EUT. The center of the loop is 1 m above the ground. for measurement above 30MHz, the Trilog Broadband Antenna or Horn Antenna was located 3m from EUT, Measurements were made with the antenna positioned in both the horizontal and vertical planes of Polarization, and the measurement antenna was varied from 1 m to 4 m. in height above the reference ground plane to obtain the maximum signal strength.

- (4) Below pre-scan procedure was first performed in order to find prominent frequency spectrum radiated emissions from 9KHz to 25GHz:
 - (a) Scanning the peak frequency spectrum with the antenna specified in step (3), and the EUT was rotated 360 degree, the antenna height was varied from 1m to 4m(Except loop antenna, it's fixed 1m above ground.)
 - (b) Change work frequency or channel of device if practicable.
 - (c) Change modulation type of device if practicable.
 - (d) new battery is used during testing
 - (e) Rotated EUT though three orthogonal axes to determine the attitude of EUT arrangement produces highest emissions.

Spectrum frequency from 9KHz to 25GHz (tenth harmonic of fundamental frequency) was investigated, and no any obvious emission were detected from 18GHz to 25GHz, so below final test was performed with frequency range from 9KHz to 18GHz.

- (5) For final emissions measurements at each frequency of interest, the EUT was rotated and the antenna height was varied between 1m and 4m in order to maximize the emission. Measurements in both horizontal and vertical polarities were made and the data was recorded. In order to find the maximum emission, the relative positions of equipments and all of the interface cables were changed according to ANSI C63.10 2013 on Radiated Emission test.
- (6) The emissions from 9KHz to 1GHz were measured based on CISPR QP detector except for the frequency bands 9-90KHz, 110-490KHz, for emissions from 9KHz-90KHz, 110KHz-490KHz and above 1GHz were measured based on average detector, for emissions above 1GHz, peak emissions also be measured and need comply with Peak limit.
- (7) The emissions from 9KHz to 1GHz, QP or average values were measured with EMI receiver with below RBW

Frequency band	RBW
9KHz-150KHz	200Hz
150KHz-30MHz	9KHz
30MHz-1GHz	120KHz

- (8) For emissions above 1GHz, both Peak and Average level were measured with Spectrum Analyzer, and the RBW is set at 1MHz, VBW is set at 3MHz for Peak measure; RBW is set at 1MHz, VBW is set at 10Hz for Average measure(according ANSI C63.10:2013 clause 4.2.3.2.3 procedure for average measure). Peak detector is used for Peak and AV measurement both.

According to KDB 789033 v02r01 section G) 1) (d), for For measurements above 1000 MHz @ 3m distance, the limit of field strength is computed as follows:

$$E[\text{dBuV/m}] = \text{EIRP}[\text{dBm}] + 95.2;$$

For example, if EIRP = -27dBm

$$E[\text{dBuV/m}] = -27 + 95.2 = 68.2\text{dBuV/m}.$$

8.4. Test result(Below 30MHz)

EUT:	Driveri	Model Name. :	D-450
Temperature:	25.4 °C	Relative Humidity:	53%
Distance:	3m	Test Power:	AC 110V/60Hz
Polarization:	--	Test Result:	Pass
Test Mode:	Keeping TX mode	Test By:	Aman

Freq. (MHz)	Reading (dBuV/m)	Limit (dBuV/m)	Margin (dB)	State P/F
--	--	--	--	P
--	--	--	--	P

Note:

The amplitude of spurious emissions which are attenuated by more than 20dB below the permissible value has no need to be reported.

Distance extrapolation factor = 20 log (specific distance/test distance)(dB);

Limit line = specific limits(dBuv) + distance extrapolation factor.

Note: N/A

Report No.: AAEMT/RF/230809-01-04

TEST RESULTS (Between 30M – 1000 MHz)

EUT:	Driveri	Model Name. :	D-450
Temperature:	25.4 °C	Relative Humidity:	53%
Distance:	3m	Test Power:	AC 110V/60Hz
Polarization:	Vertical	Test Result:	Pass
Standard:	(RE) FCC PART 15E	Test By:	Aman
Test Mode:	Keeping TX mode (5.180GHz)		

Report No.: AAEMT/RF/230809-01-04

Test at Channel 36 (5.180 GHz) in transmitting status

30 MHz~1 GHz Spurious Emissions .Quasi-Peak Measurement

Vertical:

Peak scan

Level (dBμV/m)

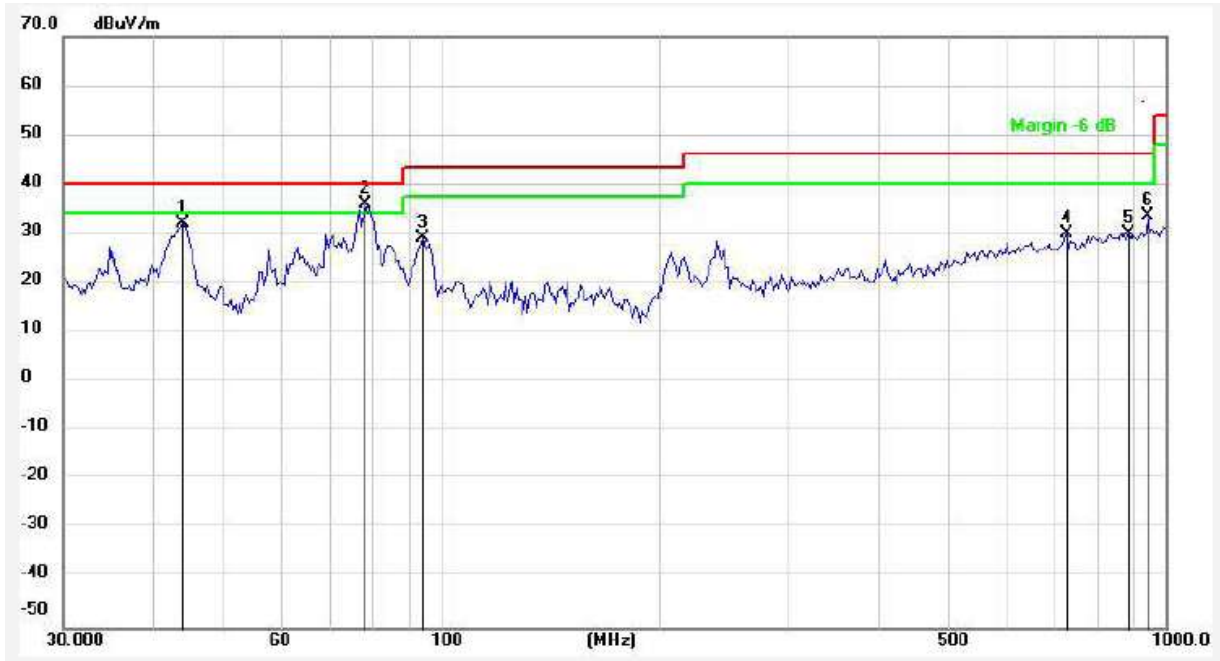

No.	Frequency (MHz)	Factor (dBuV/m)	Reading (dBuV)	Level (dBuV/m)	Limit (dBuV/m)	Margin (dB)	Detector
1	43.8451	-11.74	43.74	32.00	40.00	-8.00	QP
2	78.5644	-16.17	52.04	35.87	40.00	-4.13	QP
3	94.3135	-12.11	41.02	28.91	43.50	-14.59	QP
4	728.8971	0.73	29.14	29.87	46.00	-16.13	QP
5	887.3978	3.08	26.86	29.94	46.00	-16.06	QP
6	945.3336	3.78	29.89	33.67	46.00	-12.33	QP

The test result is calculated as the following:

- (1) Result = Reading + Correct Factor
- (2) Correct Factor = Antenna Factor + Cable Loss – Amplifier Gain + Attenuator
- (3) Margin = Result - Limit

Report No.: AAEMT/RF/230809-01-04

EUT:	Driveri	Model Name. :	D-450
Temperature:	25.4 °C	Relative Humidity:	53%
Distance:	3m	Test Power:	AC 110V/60Hz
Polarization:	Horizontal	Test Result:	Pass
Standard:	(RE)FCC PART 15E	Test By:	Aman
Test Mode:	Keeping TX mode (5.180GHz)		

Horizontal:

Peak scan

Level (dBµV/m)

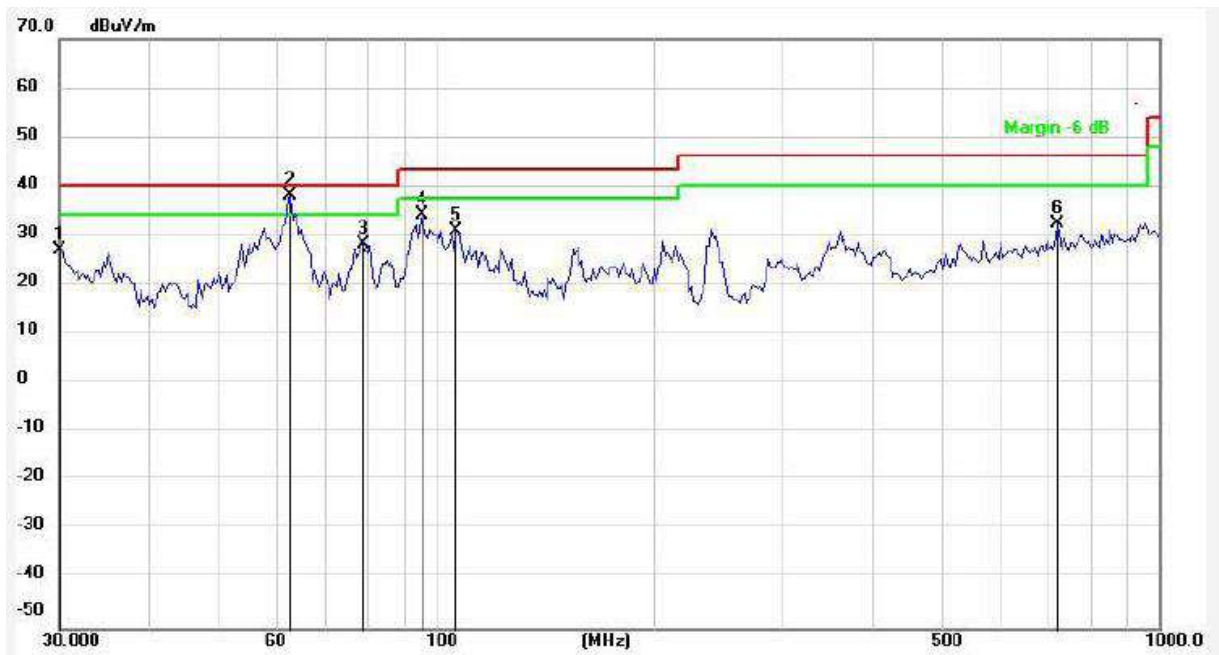

No.	Frequency (MHz)	Factor (dBµV/m)	Reading (dBµV)	Level (dBµV/m)	Limit (dBµV/m)	Margin (dB)	Detector
1	30.2115	-11.21	38.24	27.03	40.00	-12.97	QP
2	62.7432	-11.38	49.57	38.19	40.00	-1.81	QP
3	79.1185	-14.16	42.41	28.25	40.00	-11.75	QP
4	95.6485	-9.93	44.03	34.10	43.50	-9.40	QP
5	106.2811	-9.87	40.69	30.82	43.50	-12.68	QP
6	723.7930	2.65	29.77	32.42	46.00	-13.58	QP

The test result is calculated as the following:

(4) Result = Reading + Correct Factor

(5) Correct Factor = Antenna Factor + Cable Loss – Amplifier Gain + Attenuator

(6) Margin = Result – Limit

Report No.: AAEMT/RF/230809-01-04

EUT:	Driveri	Model Name. :	D-450
Temperature:	25.4 °C	Relative Humidity:	53%
Distance:	3m	Test Power:	AC 110V/60Hz
Polarization:	Vertical	Test Result:	Pass
Standard:	(RE) FCC PART 15E	Test By:	Aman
Test Mode:	Keeping TX mode (5.745GHz)		

Report No.: AAEMT/RF/230809-01-04

Test at Channel 149 (5.745 GHz) in transmitting status

30 MHz~1 GHz Spurious Emissions .Quasi-Peak Measurement

Vertical:

Peak scan

Level (dBμV/m)

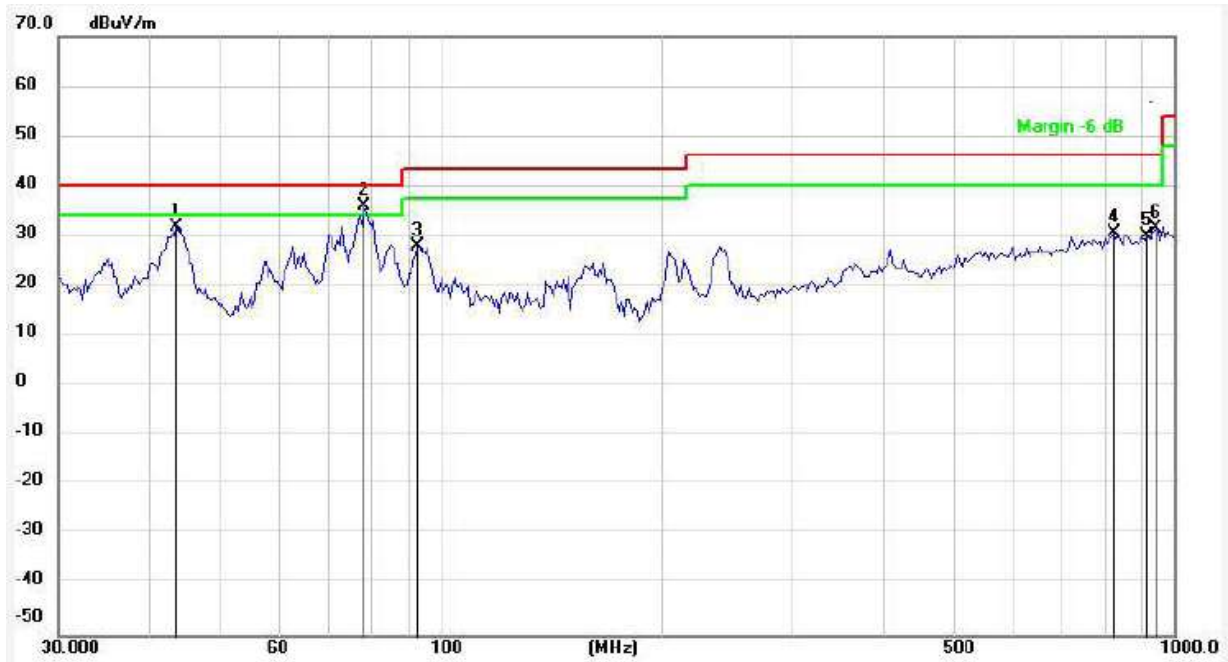

No.	Frequency (MHz)	Factor (dBuV/m)	Reading (dBuV)	Level (dBuV/m)	Limit (dBuV/m)	Margin (dB)	Detector
1	43.5380	-11.74	43.58	31.84	40.00	-8.16	QP
2	78.5644	-16.17	52.04	35.87	40.00	-4.13	QP
3	92.9974	-12.30	40.06	27.76	43.50	-15.74	QP
4	827.1794	2.18	28.24	30.42	46.00	-15.58	QP
5	919.1315	3.48	26.55	30.03	46.00	-15.97	QP
6	945.3336	3.78	27.72	31.50	46.00	-14.50	QP

The test result is calculated as the following:

- (1) Result = Reading + Correct Factor
- (2) Correct Factor = Antenna Factor + Cable Loss – Amplifier Gain + Attenuator
- (3) Margin = Result - Limit

EUT:	Driveri	Model Name. :	D-450
Temperature:	25.4 °C	Relative Humidity:	53%
Distance:	3m	Test Power:	AC 110V/60Hz
Polarization:	Horizontal	Test Result:	Pass
Standard:	(RE)FCC PART 15E	Test By:	Aman
Test Mode:	Keeping TX mode (5.745GHz)		

Horizontal:

Peak scan

Level (dBμV/m)

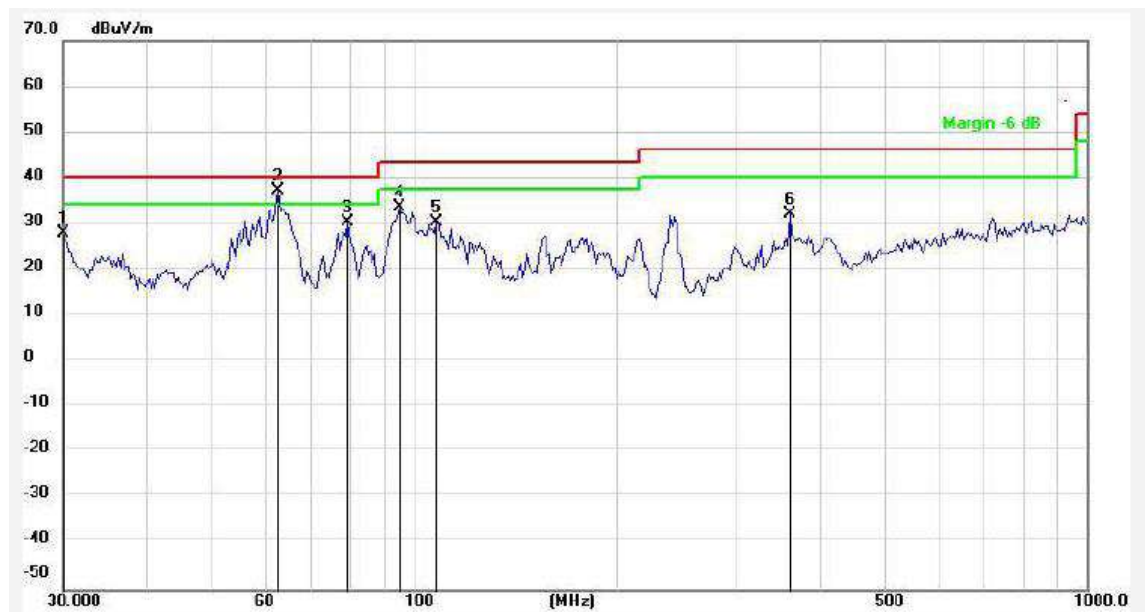

No.	Frequency (MHz)	Factor (dBuV/m)	Reading (dBuV)	Level (dBuV/m)	Limit (dBuV/m)	Margin (dB)	Detector
1	30.0000	-11.22	38.97	27.75	40.00	-12.25	QP
2	62.7432	-11.38	48.40	37.02	40.00	-2.98	QP
3	79.6764	-14.16	44.38	30.22	40.00	-9.78	QP
4	94.9787	-10.02	43.52	33.50	43.50	-10.00	QP
5	107.7854	-10.00	40.23	30.23	43.50	-13.27	QP
6	360.9774	-4.71	36.63	31.92	46.00	-14.08	QP

The test result is calculated as the following:

(4) Result = Reading + Correct Factor

(5) Correct Factor = Antenna Factor + Cable Loss – Amplifier Gain + Attenuator

(6) Margin = Result – Limit

Report No.: AAEMT/RF/230809-01-04

TEST RESULTS (Between 1000M – 18000 MHz)

EUT:	Driveri	Model Name. :	D-450
Temperature:	25.4 °C	Relative Humidity:	53%
Distance:	3m	Test Power:	AC 110V/60Hz
Polarization:	Vertical	Test Result:	Pass
Standard:	(RE)FCC PART 15E	Test By:	Aman
Test Mode:	Keeping TX mode (5.180GHz)		

Report No.: AAEMT/RF/230809-01-04

Test at Channel 36 (5.180 GHz) in transmitting status

30 MHz~1 GHz Spurious Emissions .Quasi-Peak Measurement

Vertical:

Peak scan

Level (dBμV/m)

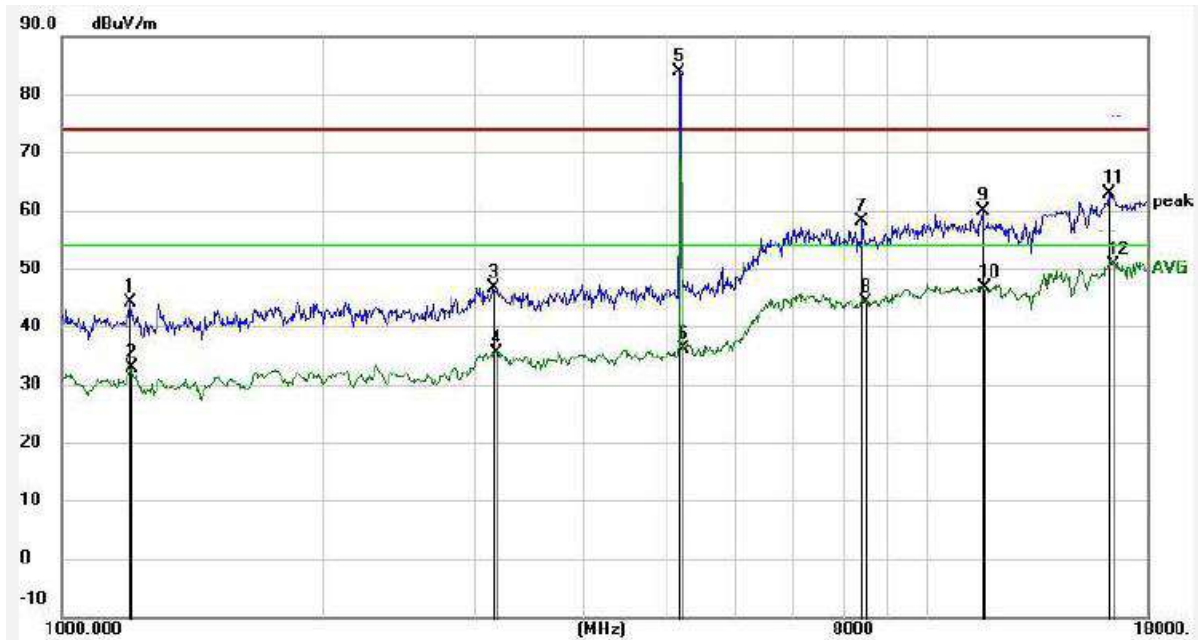

No.	Frequency (MHz)	Factor (dBuV/m)	Reading (dBuV)	Level (dBuV/m)	Limit (dBuV/m)	Margin (dB)	Detector
1	1199.726	-5.83	49.95	44.12	74.00	-29.88	peak
2	1203.199	-5.82	38.58	32.76	54.00	-21.24	AVG
3	3150.237	0.09	46.63	46.72	74.00	-27.28	peak
4	3177.672	0.14	35.29	35.43	54.00	-18.57	AVG
5	5179.049	3.87	80.06	83.93	74.00	9.93	peak
6	5209.075	3.91	32.22	36.13	54.00	-17.87	AVG
7	8416.583	12.74	45.45	58.19	74.00	-15.81	peak
8	8465.379	12.79	31.35	44.14	54.00	-9.86	AVG
9	11600.350	16.21	43.73	59.94	74.00	-14.06	peak
10	11633.928	16.18	30.37	46.55	54.00	-7.45	AVG
11	16221.189	18.16	44.72	62.88	74.00	-11.12	peak
12	16362.457	19.05	31.62	50.67	54.00	-3.33	AVG

Note: Marker 5 is the intentional frequency from EUT, Hence considered as pass.

The test result is calculated as the following:

- (1) Result = Reading + Correct Factor
- (2) Correct Factor = Antenna Factor + Cable Loss – Amplifier Gain + Attenuator
- (3) Margin = Result - Limit

Report No.: AAEMT/RF/230809-01-04

EUT:	Driveri	Model Name. :	D-450
Temperature:	25.4 °C	Relative Humidity:	53%
Distance:	3m	Test Power:	AC 110V/60Hz
Polarization:	Horizontal	Test Result:	Pass
Standard:	(RE)FCC PART 15E	Test By:	Aman
Test Mode:	Keeping TX mode (5.180GHz)		

Horizontal:

Peak scan

Level (dBµV/m)

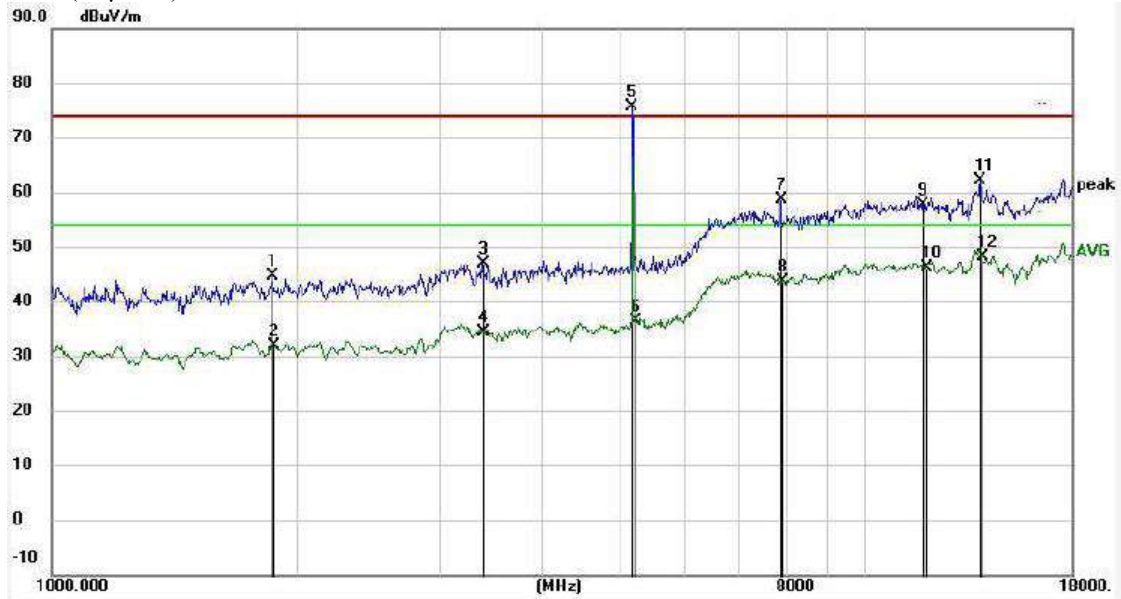

No.	Frequency (MHz)	Factor (dBµV/m)	Reading (dBµV)	Level (dBµV/m)	Limit (dBµV/m)	Margin (dB)	Detector
1	1866.977	-2.59	47.26	44.67	74.00	-29.33	peak
2	1872.381	-2.56	34.56	32.00	54.00	-22.00	AVG
3	3386.297	0.46	46.48	46.94	74.00	-27.06	peak
4	3386.297	0.46	33.84	34.30	54.00	-19.70	AVG
5	5179.049	3.87	71.80	75.67	74.00	1.67	peak
6	5209.075	3.91	32.40	36.31	54.00	-17.69	AVG
7	7875.254	12.57	46.18	58.75	74.00	-15.25	peak
8	7943.838	12.41	31.18	43.59	54.00	-10.41	AVG
9	11803.280	16.02	41.71	57.73	74.00	-16.27	peak
10	11906.073	15.91	30.26	46.17	54.00	-7.83	AVG
11	13877.076	19.82	42.35	62.17	74.00	-11.83	peak
12	13957.529	19.90	28.30	48.20	54.00	-5.80	AVG

Note: Marker 5 is intentionally radiated frequency from the EUT.

The test result is calculated as the following:

- (4) Result = Reading + Correct Factor
- (5) Correct Factor = Antenna Factor + Cable Loss – Amplifier Gain + Attenuator
- (6) Margin = Result - Limit

Report No.: AAEMT/RF/230809-01-04

EUT:	Driveri	Model Name. :	D-450
Temperature:	25.4 °C	Relative Humidity:	53%
Distance:	3m	Test Power:	AC 110V/60Hz
Polarization:	Vertical	Test Result:	Pass
Standard:	(RE)FCC PART 15E	Test By:	Aman
Test Mode:	Keeping TX mode (5.745GHz)		

Report No.: AAEMT/RF/230809-01-04

Test at Channel 149 (5.745 GHz) in transmitting status

30 MHz~1 GHz Spurious Emissions .Quasi-Peak Measurement

Vertical:

Peak scan

Level (dBμV/m)

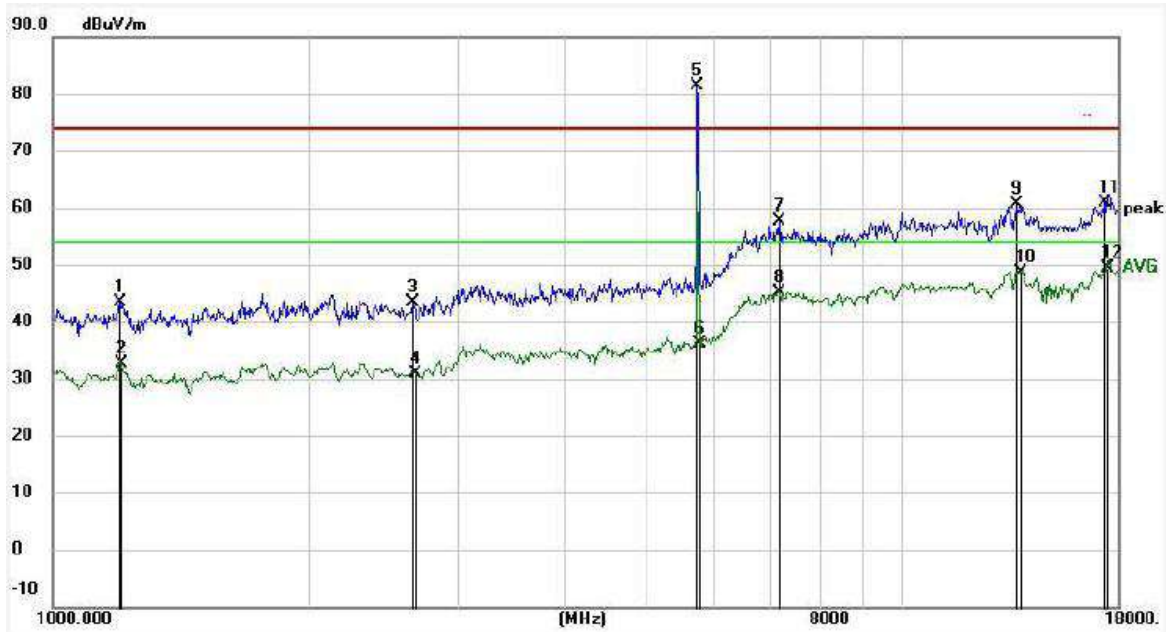

No.	Frequency (MHz)	Factor (dBuV/m)	Reading (dBuV)	Level (dBuV/m)	Limit (dBuV/m)	Margin (dB)	Detector
1	1199.726	-5.83	49.16	43.33	74.00	-30.67	peak
2	1203.199	-5.82	38.41	32.59	54.00	-21.41	AVG
3	2656.330	-0.96	44.29	43.33	74.00	-30.67	peak
4	2671.731	-0.93	31.70	30.77	54.00	-23.23	AVG
5	5746.982	4.88	76.51	81.39	74.00	7.39	peak
6	5780.300	4.96	31.11	36.07	54.00	-17.93	AVG
7	7179.527	13.40	44.11	57.51	74.00	-16.49	peak
8	7179.527	13.40	31.67	45.07	54.00	-8.93	AVG
9	13677.969	19.62	41.11	60.73	74.00	-13.27	peak
10	13797.088	19.74	28.86	48.60	54.00	-5.40	AVG
11	17336.202	21.62	39.33	60.95	74.00	-13.05	peak
12	17436.709	21.83	27.67	49.50	54.00	-4.50	AVG

Note: Marker 5 is the intentional frequency from EUT, Hence considered as pass.

The test result is calculated as the following:

- (1) Result = Reading + Correct Factor
- (2) Correct Factor = Antenna Factor + Cable Loss – Amplifier Gain + Attenuator
- (3) Margin = Result - Limit

Report No.: AAEMT/RF/230809-01-04

EUT:	Driveri	Model Name. :	D-450
Temperature:	25.4 °C	Relative Humidity:	53%
Distance:	3m	Test Power:	AC 110V/60Hz
Polarization:	Horizontal	Test Result:	Pass
Standard:	(RE)FCC PART 15E	Test By:	Aman
Test Mode:	Keeping TX mode (5.745GHz)		

Horizontal:

Peak scan

Level (dBµV/m)

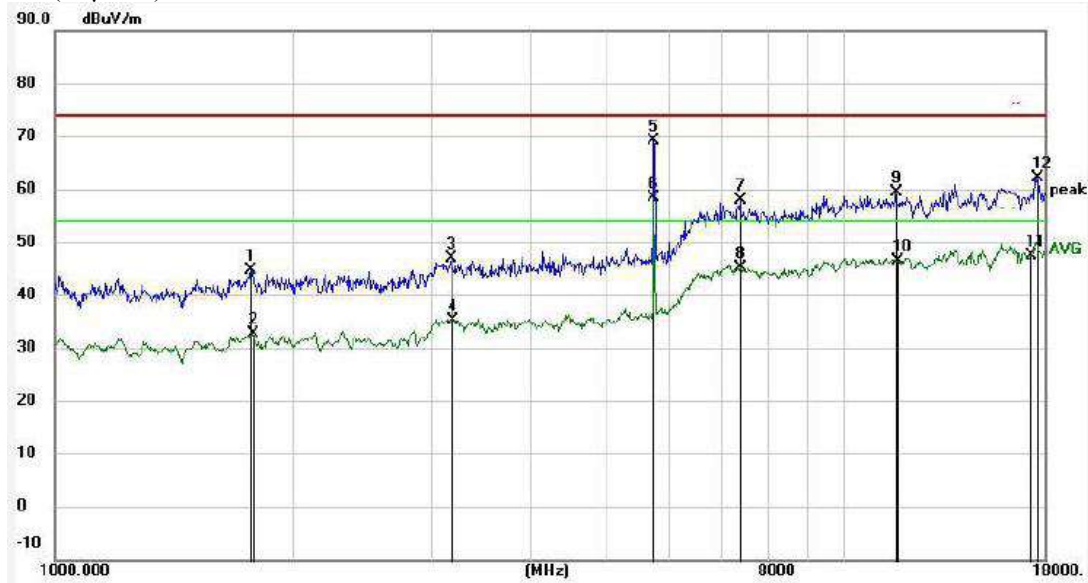

No.	Frequency (MHz)	Factor (dBµV/m)	Reading (dBµV)	Level (dBµV/m)	Limit (dBµV/m)	Margin (dB)	Detector
1	1772.327	-3.19	47.71	44.52	74.00	-29.48	peak
2	1777.458	-3.16	35.72	32.56	54.00	-21.44	AVG
3	3177.672	0.14	46.80	46.94	74.00	-27.06	peak
4	3196.094	0.17	35.01	35.18	54.00	-18.82	AVG
5	5746.982	4.88	64.17	69.05	74.00	-4.95	peak
6	5746.982	4.88	53.38	58.26	54.00	4.26	AVG
7	7390.070	13.43	44.57	58.00	74.00	-16.00	peak
8	7390.070	13.43	31.71	45.14	54.00	-8.86	AVG
9	11633.928	16.18	43.17	59.35	74.00	-14.65	peak
10	11701.375	16.11	30.19	46.30	54.00	-7.70	AVG
11	17286.166	21.52	25.87	47.39	54.00	-6.61	AVG
12	17537.798	21.94	40.12	62.06	74.00	-11.94	peak

Note: Marker 5 & 6 is intentionally radiated frequency from the EUT.

The test result is calculated as the following:

(4) Result = Reading + Correct Factor

(5) Correct Factor = Antenna Factor + Cable Loss – Amplifier Gain + Attenuator

(6) Margin = Result - Limit

Report No.: AAEMT/RF/230809-01-04

The field strength is calculated by adding the Antenna Factor. Cable Factor & Preamplifier. The basic equation with a sample calculation is as follows:

Final Test Level =Receiver Reading + Antenna Factor + Cable Factor –Preamplifier Factor.

Average measurement was not performed if peak level lower than average limit.

No any other emissions level very low which are attenuated less than 20dB below the limit.

According to 15.31(o), The amplitude of spurious emissions from intentional radiators and emissions from unintentional radiators which are attenuated more than 20 dB below the permissible value need not be reported unless specifically required elsewhere in this Part.

Hence there no other emissions have been reported.

9. POWER LINE CONDUCTED EMISSION

9.1. Block diagram of test setup

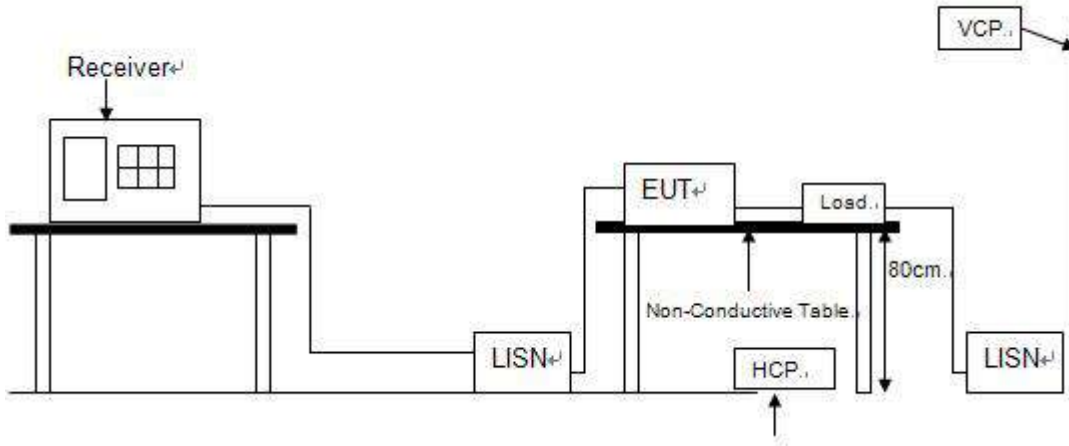

9.2. Power Line Conducted Emission Limits

Frequency	Quasi-Peak Level dB(μV)	Average Level dB(μV)
150kHz ~ 500kHz	66 ~ 56*	56 ~ 46*
500kHz ~ 5MHz	56	46
5MHz ~ 30MHz	60	50

Note 1: * Decreasing linearly with logarithm of frequency.

Note 2: The lower limit shall apply at the transition frequencies.

Report No.: AAEMT/RF/230809-01-04

9.3. Test Procedure

The EUT and Support equipment, if needed, were put placed on a non-metallic table, 80cm above the ground plane.

Configuration EUT to simulate typical usage as described in clause 2.4 and test equipment as described in clause 10.2 of this report.

All I/O cables were positioned to simulate typical actual usage as per ANSI C63.4.

All support equipment power received from a second LISN.

Emissions were measured on each current carrying line of the EUT using an EMI Test Receiver connected to the LISN powering the EUT.

The Receiver scanned from 150 kHz to 30MHz for emissions in each of the test modes.

During the above scans, the emissions were maximized by cable manipulation.

The test mode(s) described in clause 2.4 were scanned during the preliminary test.

After the preliminary scan, we found the test mode producing the highest emission level.

The EUT configuration and worse cable configuration of the above highest emission levels were recorded for reference of the final test.

EUT and support equipment were set up on the test bench as per the configuration with highest emission level in the preliminary test.

A scan was taken on both power lines, Neutral and Line, recording at least the six highest emissions.

Emission frequency and amplitude were recorded into a computer in which correction factors were used to calculate the emission level and compare reading to the applicable limit.

The test data of the worst-case condition(s) was recorded.

The bandwidth of test receiver is set at 9 KHz.

9.4. Test Result

PASS. (See below detailed test result)

Note1: All emissions not reported below are too low against the prescribed limits.

Note2: “-----” means peak detection; “-----” means average detection

Report No.: AAEMT/RF/230809-01-04

EUT:	Driveri	Model Name. :	D-450
Temperature:	25.8°C	Relative Humidity:	52%
Probe:	Line	Test Power:	AC 110V/60Hz
Test Mode:	TX	Test Result:	Pass
Standard:	(CE)FCC PART 15 E_QP		

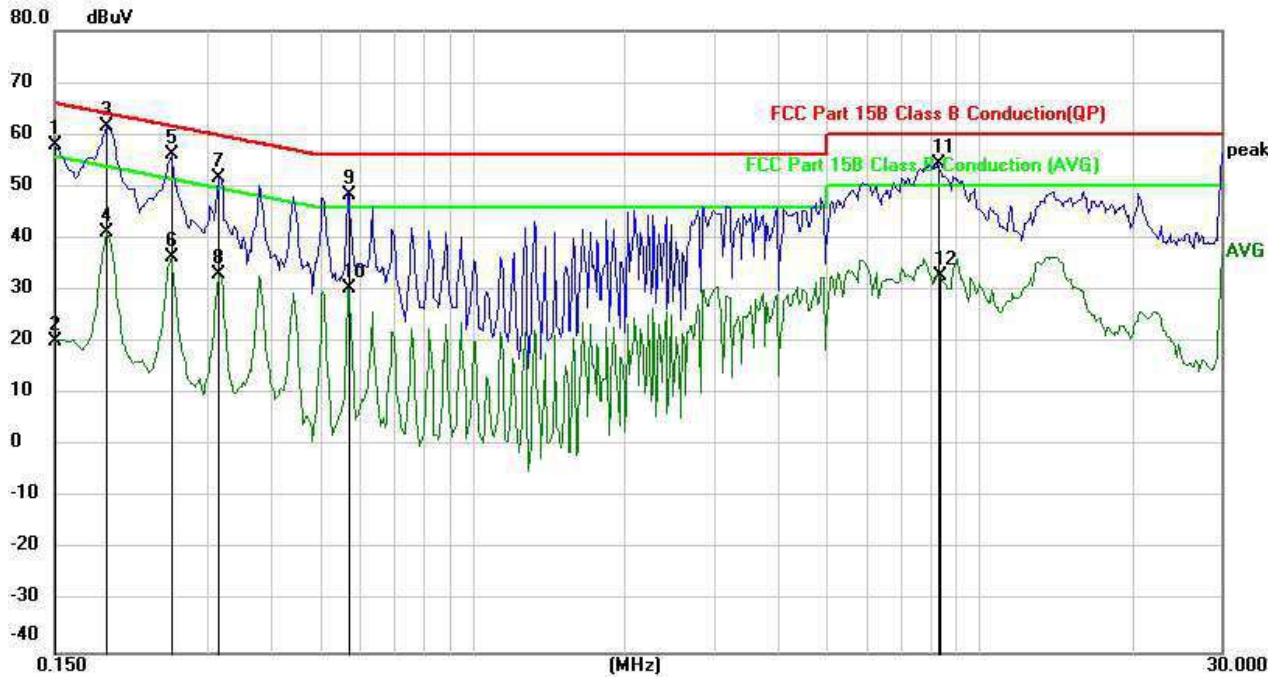

No.	Mk.	Freq.	Reading Level	Correct Factor	Measurement	Limit	Over	Detector
		MHz	dBuV	dB	dBuV	dBuV	dB	
1		0.1499	46.34	11.75	58.09	66.00	-7.91	QP
2		0.1499	8.42	11.75	20.17	56.00	-35.83	AVG
3	*	0.1900	49.45	11.97	61.42	64.03	-2.61	QP
4		0.1901	29.23	11.97	41.20	54.03	-12.83	AVG
5		0.2550	45.97	10.19	56.16	61.59	-5.43	QP
6		0.2550	26.24	10.19	36.43	51.59	-15.16	AVG
7		0.3150	41.22	10.56	51.78	59.84	-8.06	QP
8		0.3165	22.35	10.58	32.93	49.80	-16.87	AVG
9		0.5695	37.63	10.81	48.44	56.00	-7.56	QP
10		0.5695	19.58	10.81	30.39	46.00	-15.61	AVG
11		8.3000	43.32	10.99	54.31	60.00	-5.69	QP
12		8.3670	21.70	10.99	32.69	50.00	-17.31	AVG

The test result is calculated as the following:

- (1) Result = Reading + Correct Factor
- (2) Correct Factor = (LISN, ISN, PLC or Current Probe) Factor + Cable Loss + Attenuator
- (3) Margin = Result - Limit

Report No.: AAEMT/RF/230809-01-04

EUT:	Driveri	Model Name. :	D-450
Temperature:	25.8°C	Relative Humidity:	52%
Probe:	Neutral	Test Power:	AC 110V/60Hz
Test Mode:	TX	Test Result:	Pass
Standard:	(CE)FCC PART 15 E_QP		

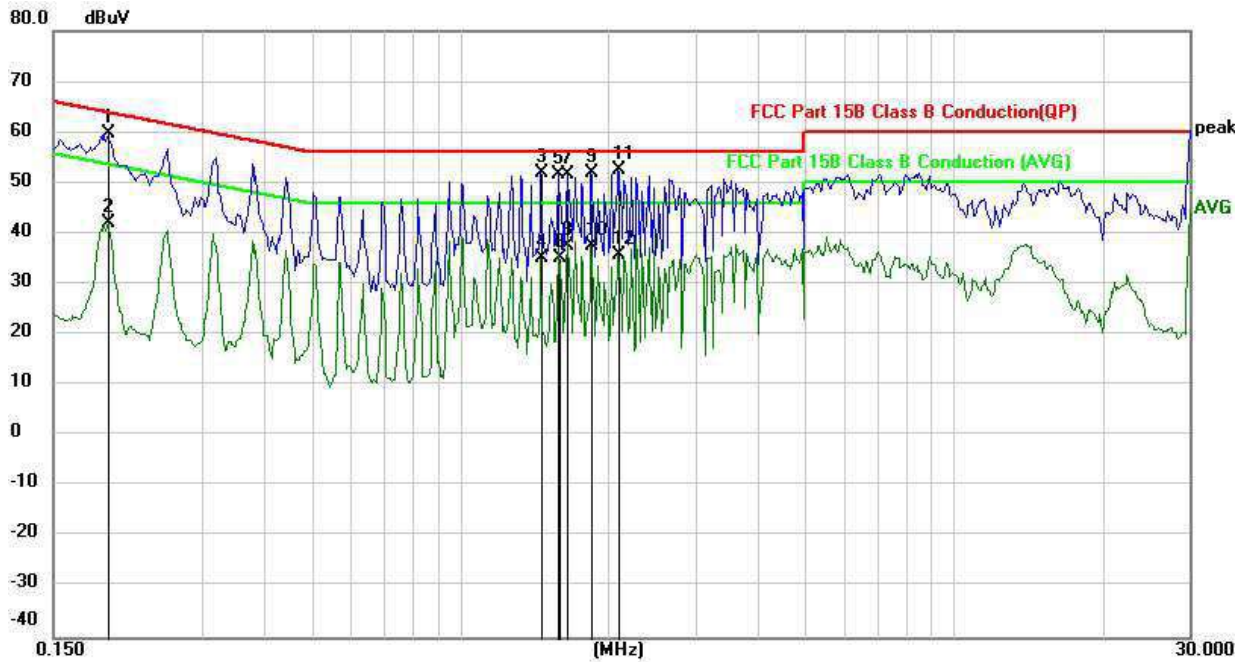

No.	Mk.	Freq. MHz	Reading Level dBuV	Correct Factor dB	Measure- ment dBuV	Limit dBuV	Over dB	Detector
1		0.1932	47.80	11.86	59.66	63.89	-4.23	QP
2		0.1932	30.27	11.86	42.13	53.89	-11.76	AVG
3		1.4596	40.96	10.90	51.86	56.00	-4.14	QP
4		1.4596	24.30	10.90	35.20	46.00	-10.80	AVG
5		1.5800	40.81	10.90	51.71	56.00	-4.29	QP
6		1.5900	24.24	10.90	35.14	46.00	-10.86	AVG
7		1.6493	40.83	10.90	51.73	56.00	-4.27	QP
8		1.6532	26.73	10.90	37.63	46.00	-8.37	AVG
9		1.8400	40.94	10.90	51.84	56.00	-4.16	QP
10		1.8400	26.51	10.90	37.41	46.00	-8.59	AVG
11	*	2.0899	41.69	10.90	52.59	56.00	-3.41	QP
12		2.0899	24.88	10.90	35.78	46.00	-10.22	AVG

The test result is calculated as the following:

- (1) Result = Reading + Correct Factor
- (2) Correct Factor = (LISN, ISN, PLC or Current Probe) Factor + Cable Loss + Attenuator
- (3) Margin = Result – Limit

10. CONDUCTED SPURIOUS EMISSIONS

Test Requirement: FCC Part 15 C section 15.407

(d) In any 100 kHz bandwidth outside the frequency band in which the spread spectrum or digitally modulated intentional radiator is operating. the radio frequency power that is produced by the intentional radiator shall be at least 20 dB below that in the 100 kHz bandwidth within the band that contains the highest level of the desired power. Based on either an RF conducted or a radiated measurement. Provided the transmitter demonstrates compliance with the peak conducted power limits.

Test Method: ANSI C63.10: Clause 6.7

Test Status: Pre-Scan has been conducted to determine the worst-case mode from all possible combinations between available modulations, data rates and antenna ports (if EUT with antenna diversity architecture). Following channel(s) was (were) selected for the final test as listed below.
Pre-test the EUT under 2 modes: power-supplied by using the AC adapter and power-supplied by using internal battery. After pre-testing, we found the worst case is the test mode of EUT power-supplied by using internal battery.

Test Configuration:

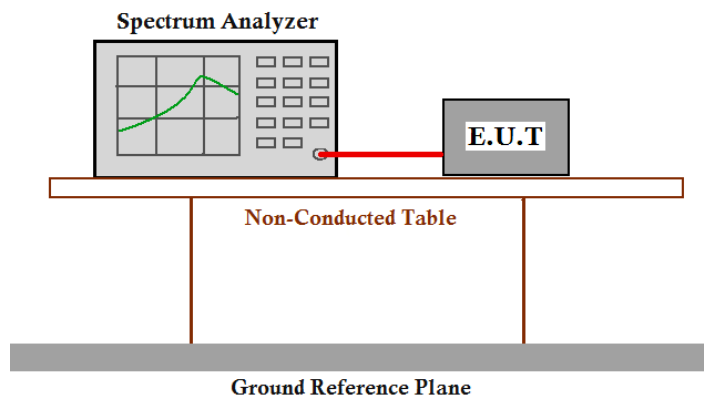

Test Procedure:

1. Remove the antenna from the EUT and then connect a low RF cable from the antenna port to the spectrum analyzer or power meter.
2. Set the spectrum analyzer: RBW=100 KHz, VBW = 300KHz. Sweep = auto; Detector Function = Peak. Trace = Max Hold, Scan up through 10th harmonic.
3. Measure the Conducted Spurious Emissions of the test frequency with special test status.
4. Repeat until all the test status is investigated.
5. Report the worse case.

Result plot as follows:

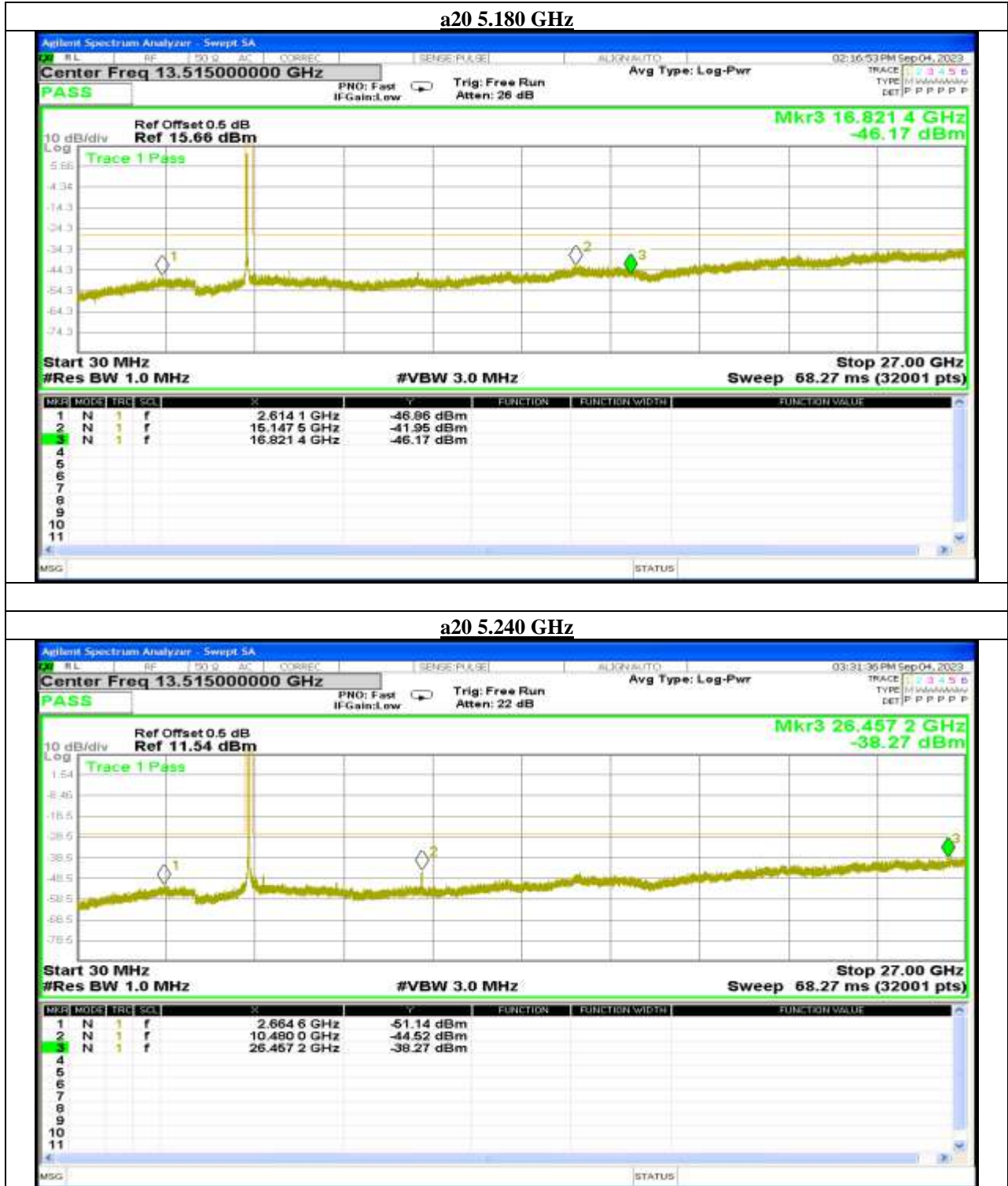

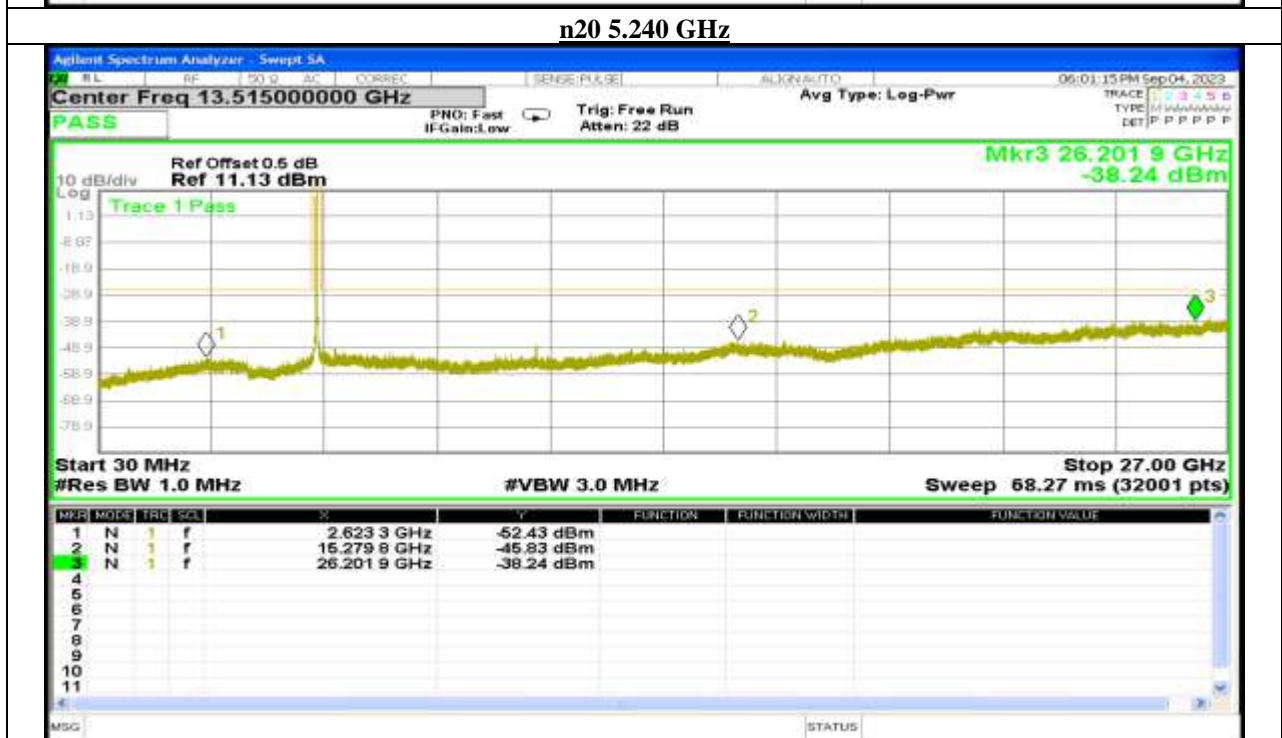
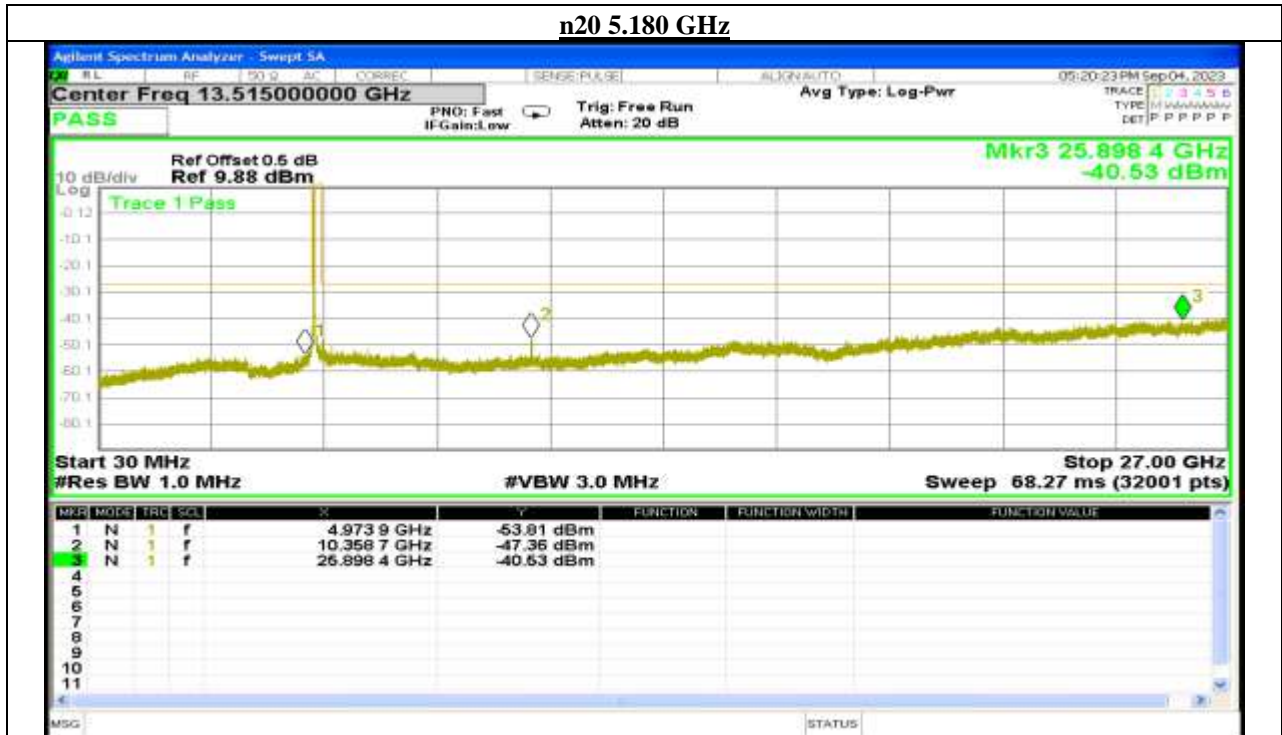

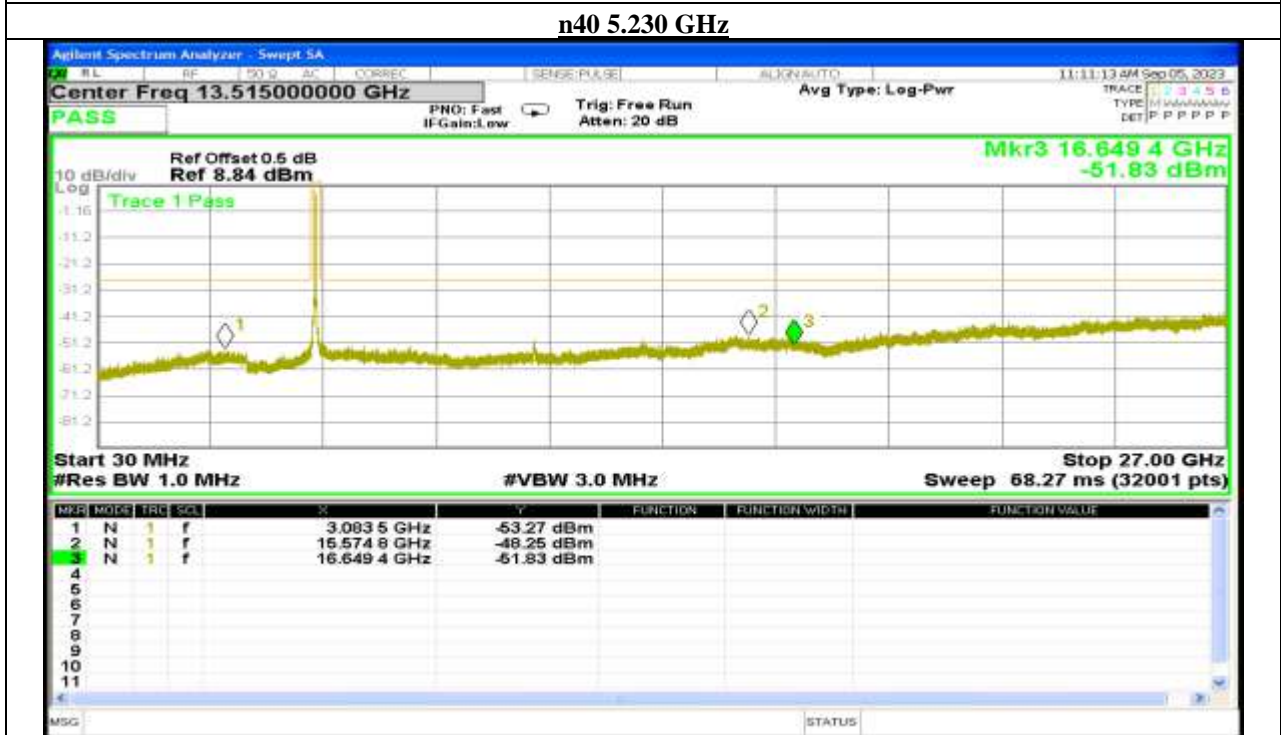
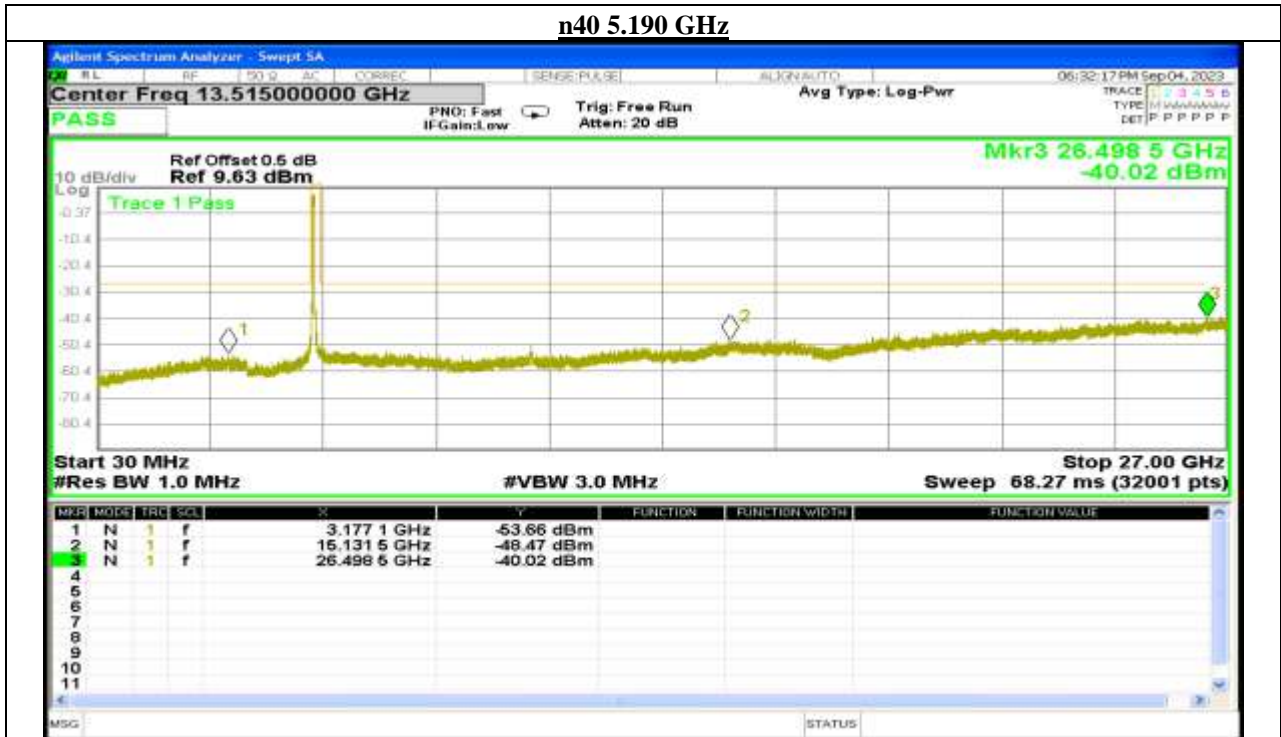

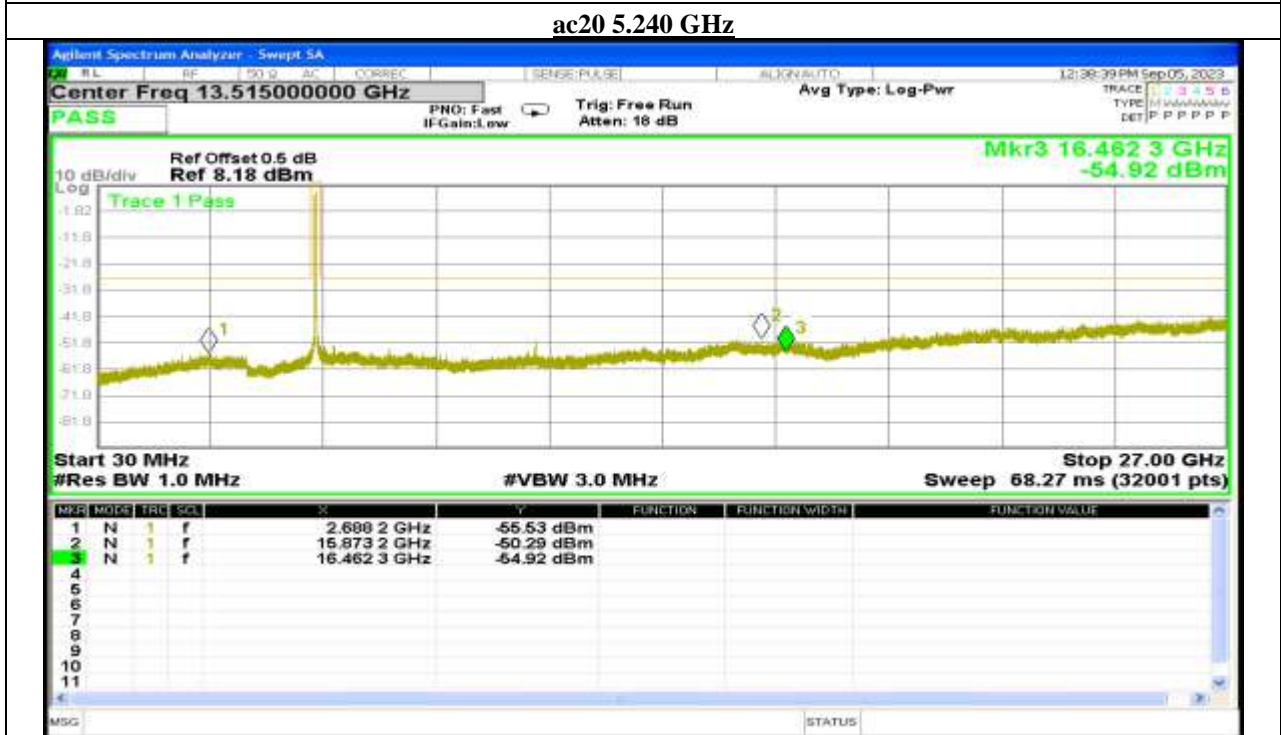
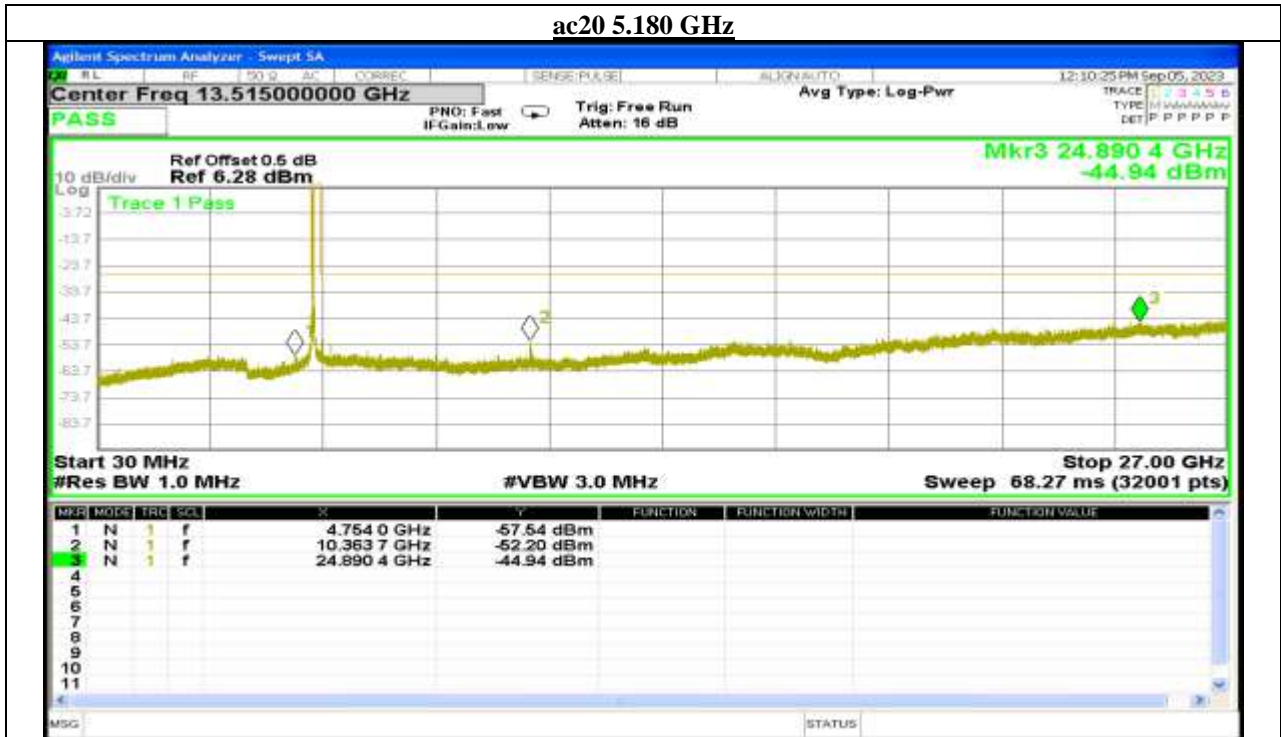

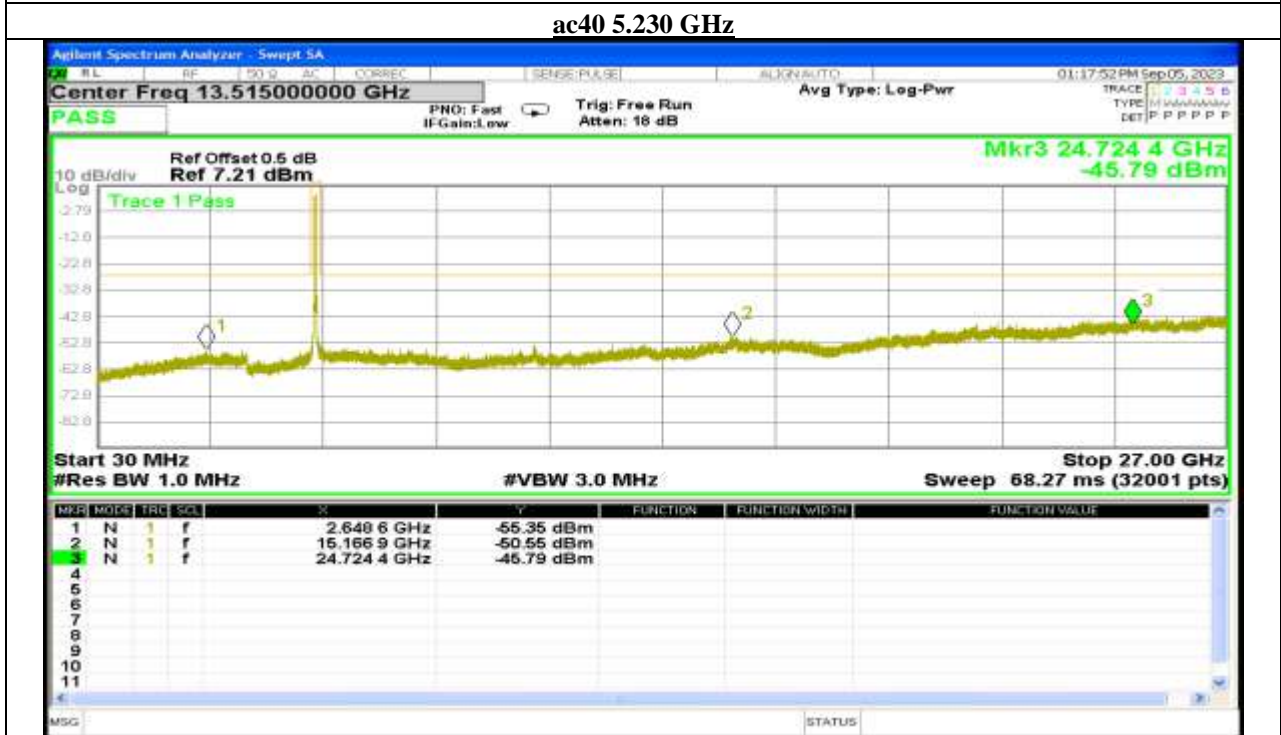
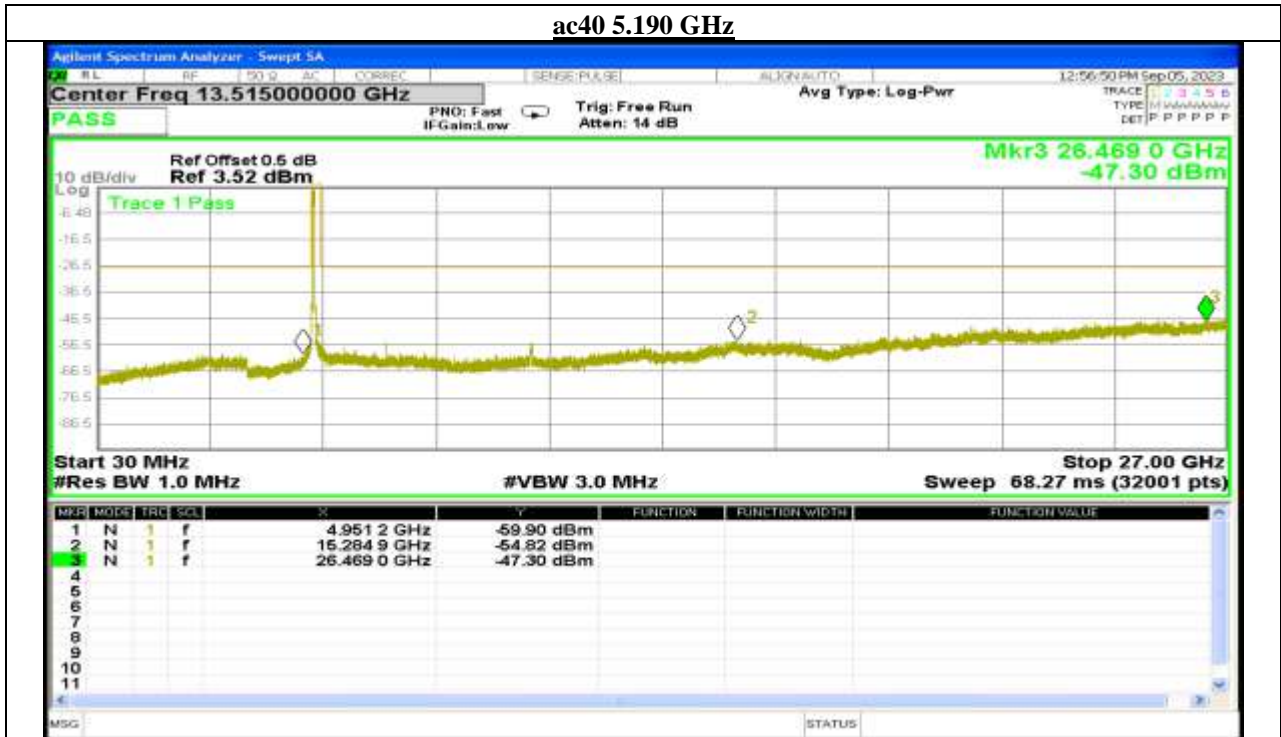



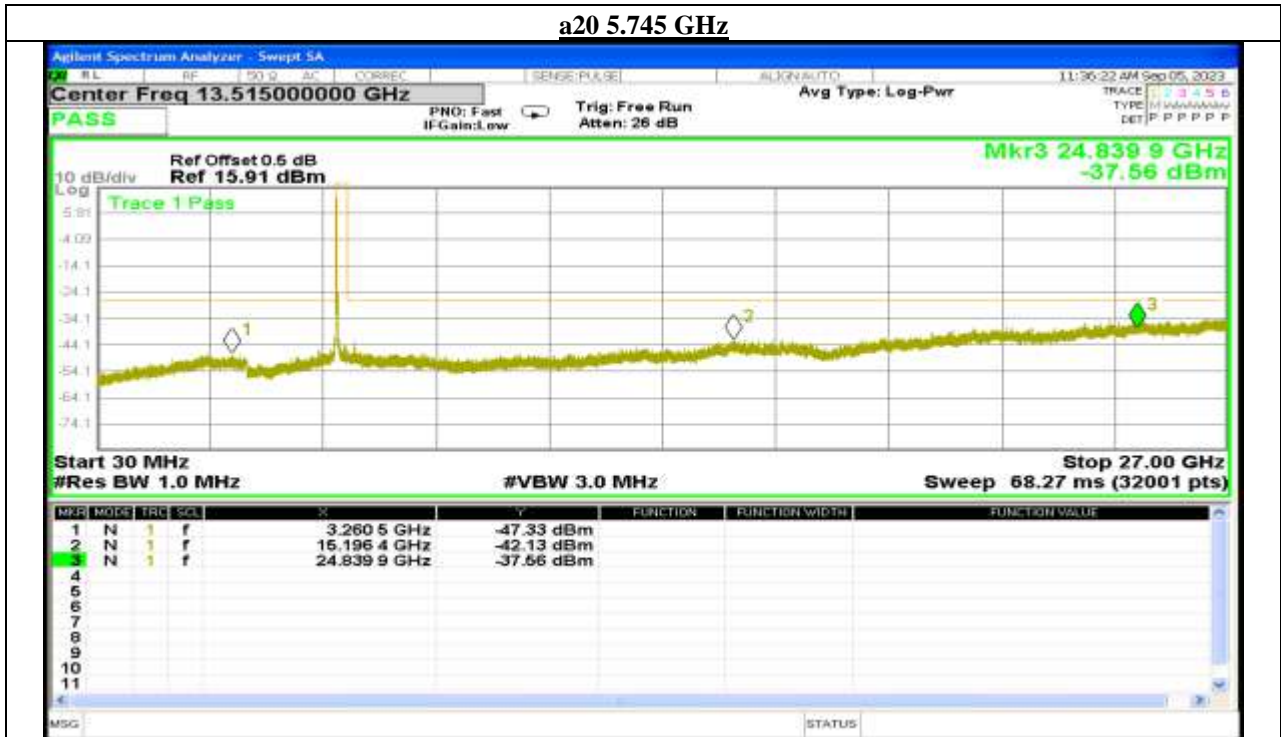

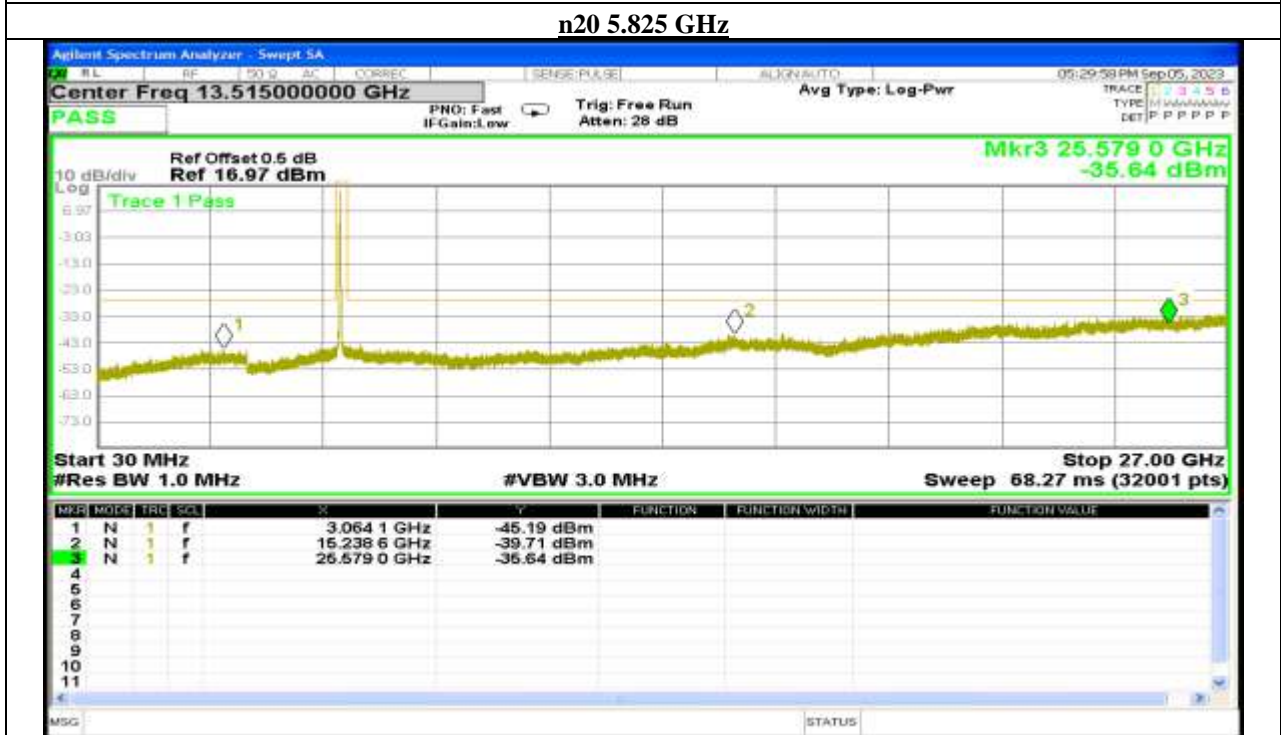
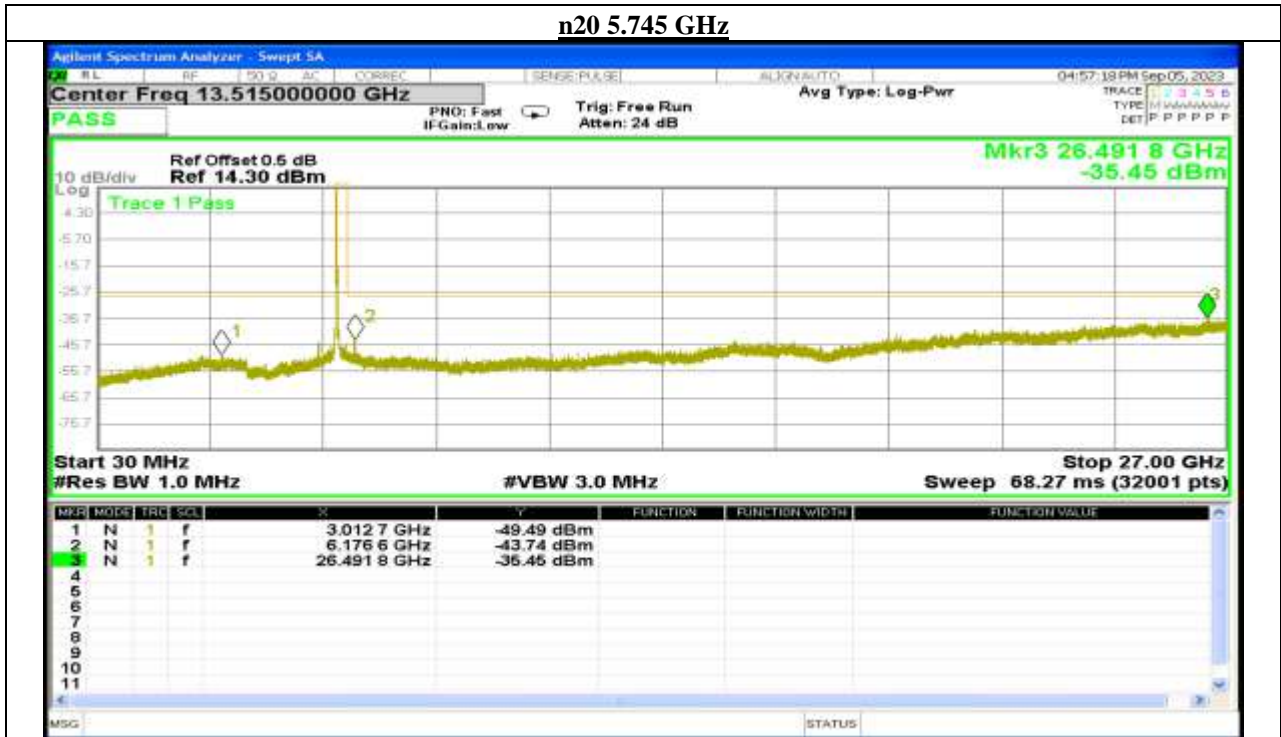

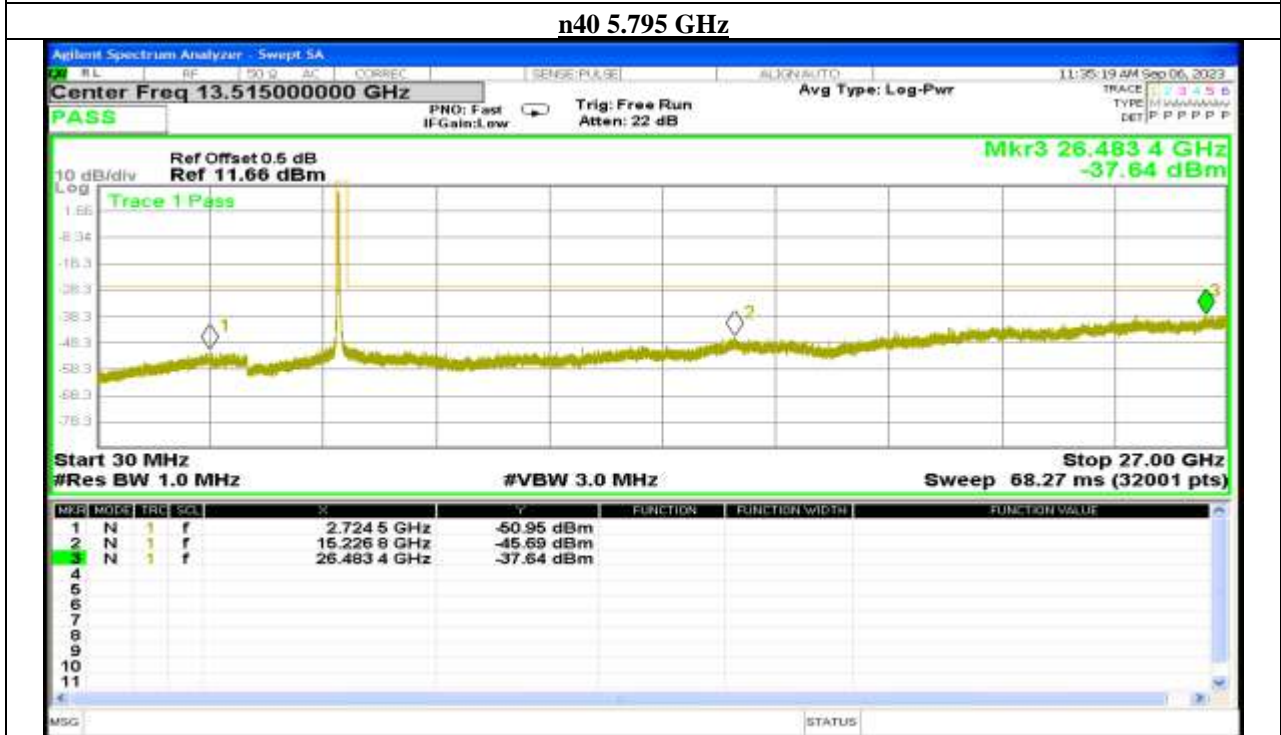
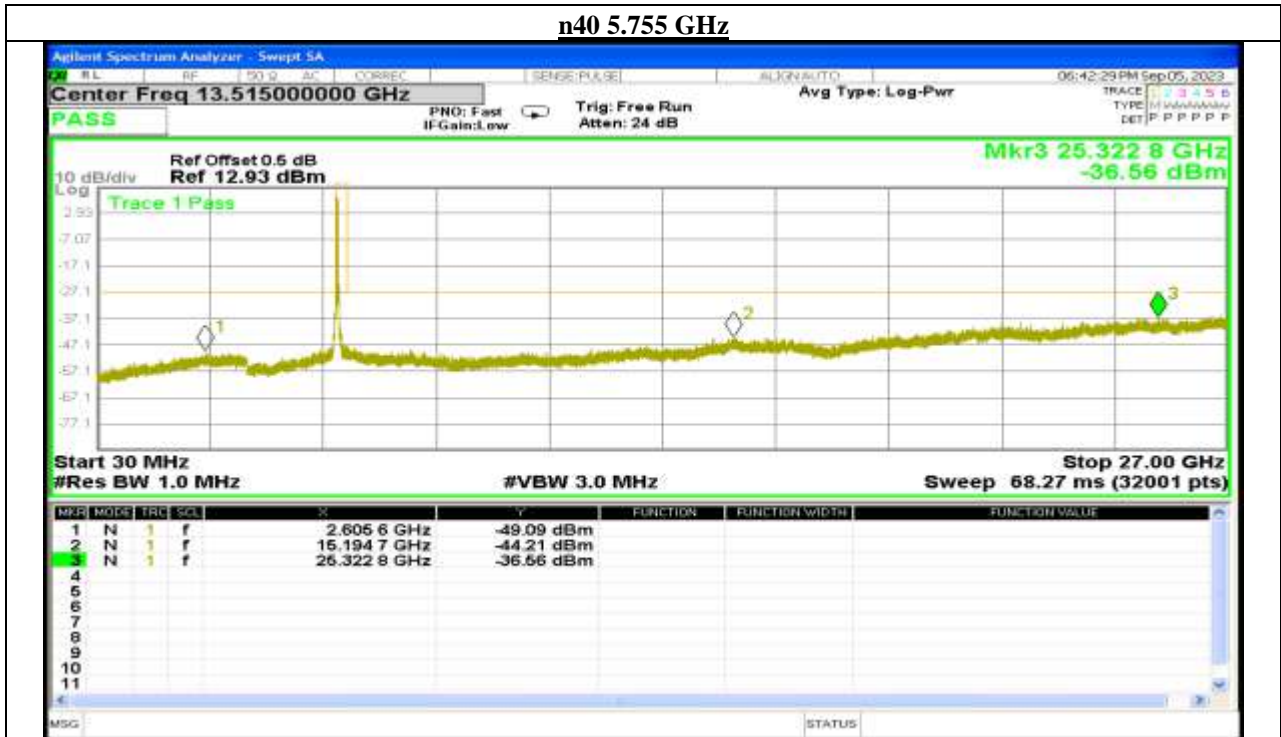

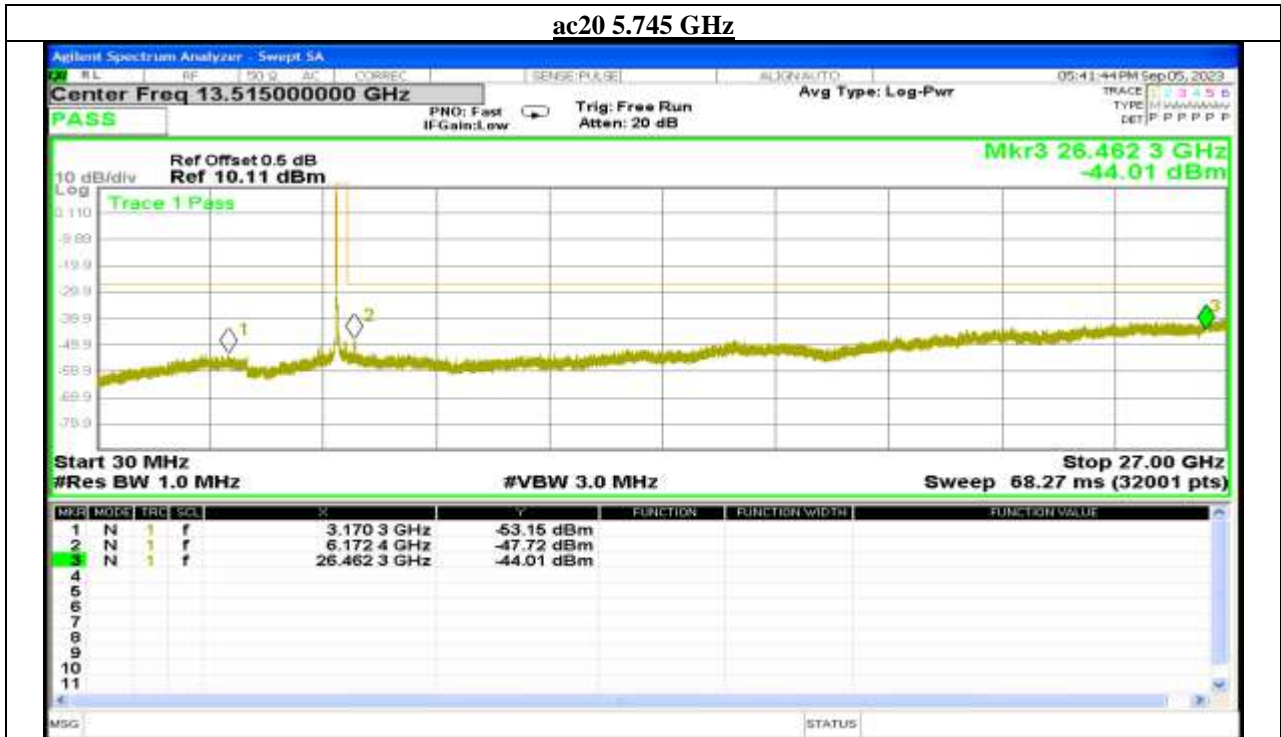

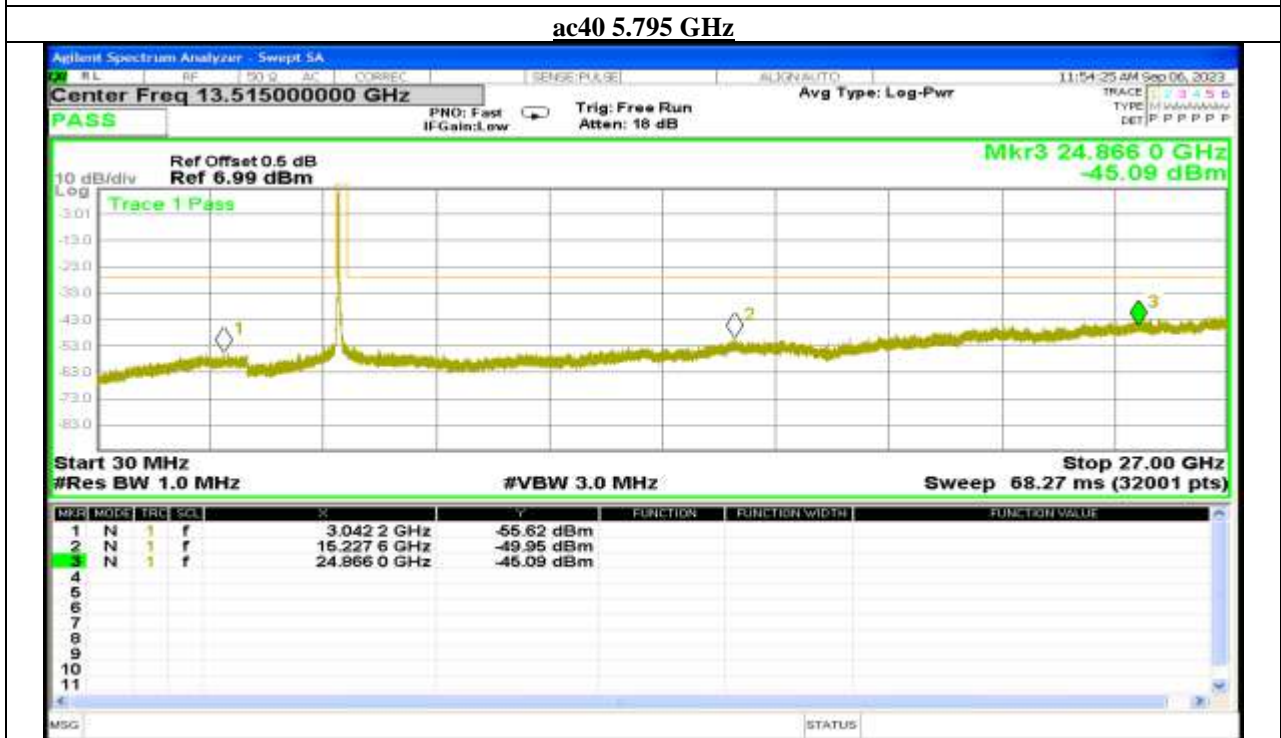
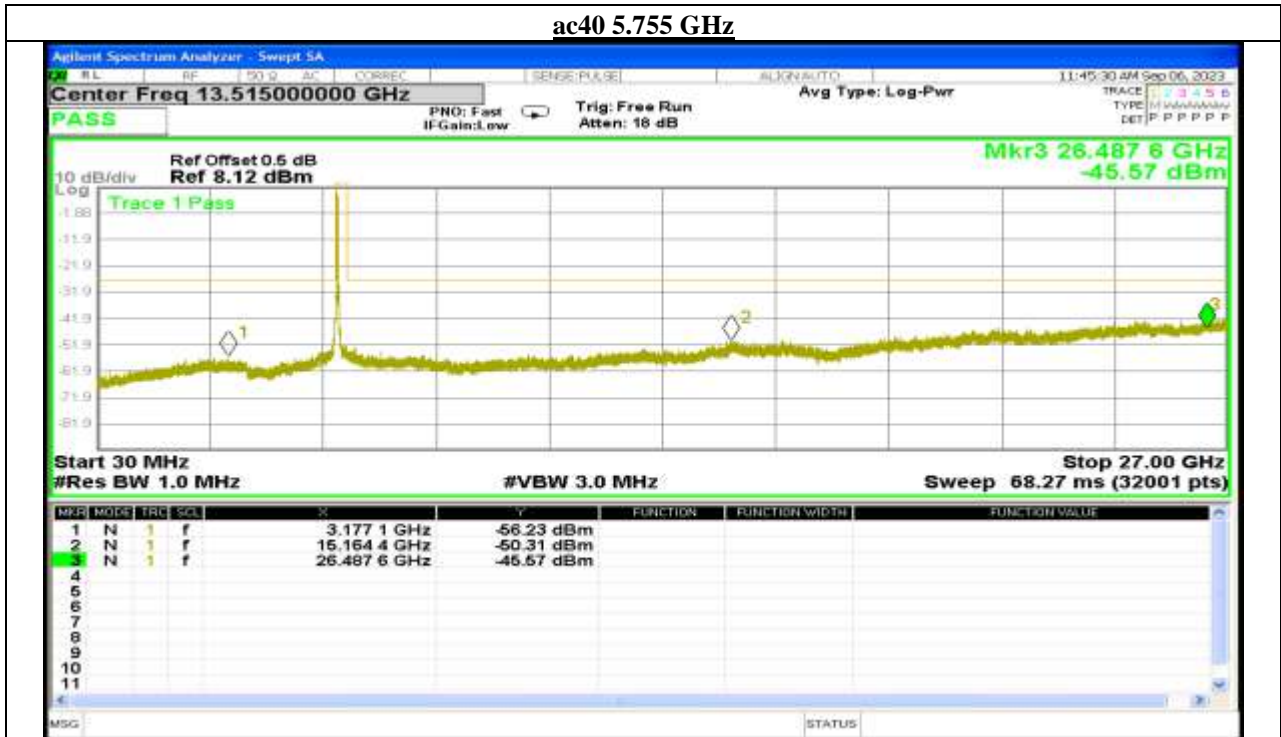

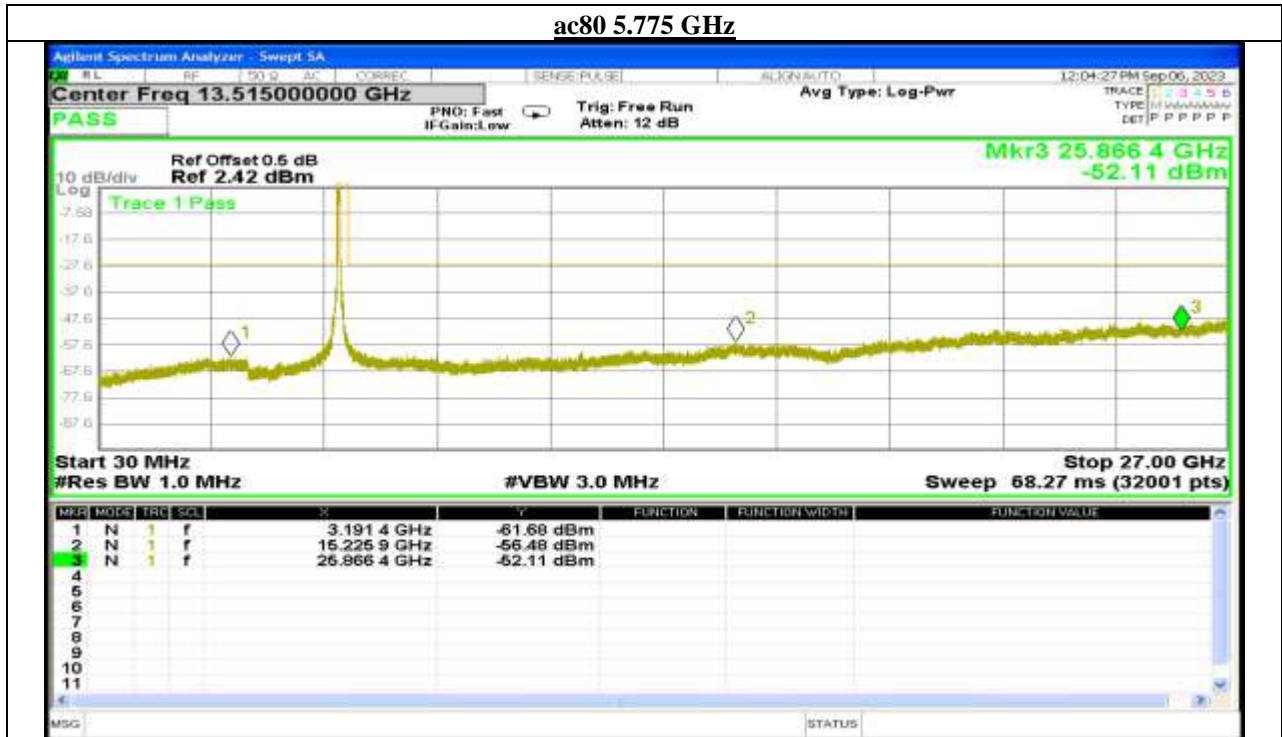

Report No.: AAEMT/RF/230809-01-04

11. ANTENNA REQUIREMENTS

11.1. Limit

15.203 requirement: For intentional device, according to 15.203: an intentional radiator shall be designed to ensure that no antenna other than that furnished by the responsible party shall be used with the device.

11.2. EUT ANTENNA

The antennas used for this product are Flexible PCB Antenna and that no antenna other than that furnished by the responsible party shall be used with the device, the maximum peak gain of the transmit antenna is -1.8 dBi. and the antenna connector is designed with permanent attachment and no consideration of replacement. Therefore the EUT is considered sufficient to comply with the provision.



****End of Report****