

FCC Test Report

(Part 27)

Client Information:

Applicant: Netradyne Inc

Applicant add.: 9191 Towne Centre Drive Suite 200, San Diego, CA 92122

Product Information:

EUT Name: Driveri

Model No.: D-215

Brand Name:



FCC ID: 2AM8R-D215

Standards: FCC PART 27

AA Electro Magnetic Test Laboratory Private Limited

Add.: Plot No 174, Udyog Vihar - Phase 4, Sector 18,
Gurgaon, Haryana, India

Date of Receipt: Sep. 01, 2021

Date of Test: Oct. 05~ Oct. 07, 2021

Date of Issue: Nov. 23, 2021

Test Result: Pass

This device described above has been tested by AA Electro Magnetic Test Laboratory Private Limited, and the test results show that the equipment under test (EUT) is in compliance with the FCC requirements. And it is applicable only to the tested sample identified in the report.

*This test report must not be used by the client to claim product endorsement by any agency of the U.S. government.

Declaration of Conformity: Declaration of conformity of the results is based as per the standard limits

Prepared By: (+ signature) Abhinav Kumar



Reviewed & Approved by: (+ signature)

Dr. Lenin Raja (Authorized Representative) (/ lenin83/)

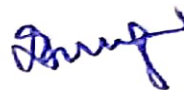

1 Contents

	Page
COVER PAGE	
1 CONTENTS	2
2 TEST SUMMARY	3
2.1 COMPLIANCE WITH FCC PART 24 SUBPART E	3
2.2 MEASUREMENT UNCERTAINTY	5
2.3 TEST LOCATION	5
3 TEST FACILITY	6
3.1 DEVIATION FROM STANDARD	6
3.2 ABNORMALITIES FROM STANDARD CONDITIONS	6
4 GENERAL INFORMATION	7
4.1 GENERAL DESCRIPTION OF EUT	7
4.2 EUT PERIPHERAL LIST	10
4.3 TEST PERIPHERAL LIST	10
5 EQUIPMENTS LIST FOR ALL TEST ITEMS	11
5.1 OUTPUT POWER MEASUREMENT	13
5.2 FREQUENCY STABILITY MEASUREMENT	17
5.3 OCCUPIED BANDWIDTH MEASUREMENT	19
5.4 BAND EDGE MEASUREMENT	25
5.5 PEAK TO AVERAGE RATIO	28
5.6 CONDUCTED SPURIOUS EMISSIONS	33
5.7 RADIATED EMISSION MEASUREMENT	33

2 Test Summary

2.1 Compliance with FCC Part 27

Applied Standard: FCC Part 27 & Part 2 (LTE 4)			
FCC Clause	Test Item	Result	Remarks
2.1046 27.50(d)(4)	Maximum Peak Output Power	Pass	Meet the requirement of limit.
2.1047	Modulation Characteristics	Pass	Meet the requirement.
2.1055 27.54	Frequency Stability	Pass	Meet the requirement of limit.
2.1049 27.53(h)	Occupied Bandwidth	Pass	Meet the requirement of limit.
27.50(d)(5)	Peak to Average Ratio	Pass	Meet the requirement of limit.
27.53(h)	Band Edge Measurements	Pass	Meet the requirement of limit.
2.1051 27.53(h)	Conducted Spurious Emissions	Pass	Meet the requirement of limit.
2.1053 27.53(h)	Radiated Spurious Emissions	Pass	Meet the requirement of limit. Minimum passing margin is -17.57 dB at 6842.80 MHz.

Applied Standard: FCC Part 27 & Part 2 (LTE 12)			
FCC Clause	Test Item	Result	Remarks
2.1046 27.50(c)(10)	Maximum Peak Output Power	Pass	Meet the requirement of limit.
2.1047	Modulation Characteristics	Pass	Meet the requirement.
2.1055 27.54	Frequency Stability	Pass	Meet the requirement of limit.
2.1049	Occupied Bandwidth	Pass	Meet the requirement of limit.
27.50(d)(5)	Peak to Average Ratio	Pass	Meet the requirement of limit.
27.53(g)	Band Edge Measurements	Pass	Meet the requirement of limit.
2.1051 27.53(g)	Conducted Spurious Emissions	Pass	Meet the requirement of limit.

Report No.: AAEMT/EMC/210901-01-07

2.1053 27.53(g)	Radiated Spurious Emissions	Pass	Meet the requirement of limit. Minimum passing margin is -32.40 dB at 1430.60 MHz.
--------------------	-----------------------------	------	--



2.2 Measurement Uncertainty

All measurements involve certain levels of uncertainties, the following measurements uncertainty Levels have estimated based on standards, the maximum value of the uncertainty as below:

No.	Item	Uncertainty
1	Conducted Emission Test	2.82dB
2	Radiated Emission Test	2.79dB

2.3 Test Location

All tests were performed at:

AA Electro Magnetic Test Laboratory Private Limited

Plot No 174, Udyog Vihar - Phase 4, Sector 18, Gurgaon, Haryana, India

Tel.: +91-0124-4235350

3 Test Facility

The test facility is recognized, certified or accredited by the following organizations:

ILAC / NABL Accreditation No.: TC-8597

Three 3m Semi-Anechoic Chamber, 1 full-Anechoic chamber and 2 Shielding Rooms of AA Electro Magnetic Test Laboratory Private Limited have been registered by National Accreditation Board for Testing and Calibration Laboratories (NABL).

ILAC –A2LA Accreditation No.: 5593.01

Three 3m Semi-Anechoic Chamber, 1 full-Anechoic chamber and 2 Shielding Rooms of AA Electro Magnetic Test Laboratory Private Limited have been registered American Association of Laboratory Accreditation (A2LA).

FCC- Recognition No.: 137777

Three 3m Semi-Anechoic Chamber, 1 full-Anechoic chamber and 2 Shielding Rooms of AA Electro Magnetic Test Laboratory Private Limited have been registered by Federal Communications Commission (FCC).

ISED Recognition No.: 26046

Three 3m Semi-Anechoic Chamber, 1 full-Anechoic chamber and 2 Shielding Rooms of AA Electro Magnetic Test Laboratory Private Limited have been registered by Institute for Social and Economic Development (ISED).

VCCI- Registration No: 4053

Three 3m Semi-Anechoic Chamber, 1 full-Anechoic chamber and 2 Shielding Rooms of AA Electro Magnetic Test Laboratory Private Limited have been registered by Voluntary Control Council for Interference (VCCI).

TEC Designation No.: IND063

Three 3m Semi-Anechoic Chamber, 1 full-Anechoic chamber and 2 Shielding Rooms of AA Electro Magnetic Test Laboratory Private Limited have been registered by Telecommunication Engineering (TEC) Center.

BIS Recognition No: 816586

BIS recognized as per CRS scheme for IT electronics, LED control gears, Lamp, Inverter / UPS are recognized as per LRS 2020.

3.1 Deviation from standard

None

3.2 Abnormalities from standard conditions

None

4 General Information

4.1 General Description of EUT

Manufacturer:	Netradyne Inc	
Manufacturer Address:	9191 Towne Centre Drive Suite 200, San Diego, CA 92122	
EUT Name:	Driveri	
Model No:	D-215	
Brand Name:		
Derivative model No.:	N/A	
Frequency Range:	LTE Band 4 Channel Bandwidth: 10MHz	1715 MHz ~ 1750 MHz
	LTE Band 12 Channel Bandwidth: 10MHz	704 MHz ~ 711 MHz
Modulation Technology:	LTE Band 4,12 : QPSK	
Antenna Gain(dBi):	2.5dBi	
H/W No.:	501-1-01549 A2	
S/W No.:	4.5.8.rc.1	
Power Supply Range:	Input: 12VDC 3A	
Condition of Sample on receipt:	Good	
Note:		
	1.	For a more detailed features description, please refer to the manufacturer's specifications or the User's Manual.

4.2 EUT channels and frequencies list:

LTE BAND 4

EUT Configure	Test Item	Available Channel	Tested Channel	Channel Bandwidth	Modulation
-	EIRP	20000 to 20350	20000, 20175, 20350	10 MHz	QPSK
-	Frequency Stability	20000 to 20350	20000,20350	10 MHz	QPSK
-	Occupied Bandwidth	20000 to 20350	20000, 20175, 20350	10 MHz	QPSK
-	Peak to Average Ratio	20000 to 20350	20000, 20175, 20350	10 MHz	QPSK

EUT Configure	Test Item	Available Channel	Tested Channel	Channel Bandwidth	Modulation
-	Band Edge	20000 to 20350	20000	10 MHz	QPSK
			20350	10 MHz	QPSK
-	Conducted Emission	20000 to 20350	20000, 20175, 20350	10 MHz	QPSK
-	Radiated Emission	20000 to 20350	20000, 20175, 20350	10 MHz	QPSK

LTE BAND 12

EUT Configure	Test Item	Available Channel	Tested Channel	Channel Bandwidth	Modulation
-	EIRP	23060 to 23130	23060, 23095, 23130	10MHz	QPSK
-	Frequency Stability	23060 to 23130	23060,23130	10MHz	QPSK
-	Occupied Bandwidth	23060 to 23130	23060, 23095, 23130	10MHz	QPSK
-	Peak to Average Ratio	23060 to 23130	23060, 23095, 23130	10MHz	QPSK

EUT Configure	Test Item	Available Channel	Tested Channel	Channel Bandwidth	Modulation
-	Band Edge	23060 to 23130	23060	10MHz	QPSK
			23130	10MHz	QPSK
-	Conducted Emission	23060 to 23130	23017, 23095, 23173	10MHz	QPSK
-	Radiated Emission	23060 to 23130	23017, 23095, 23173	10MHz	QPSK

4.3 EUT Peripheral List

No .	Equipment	Manufacturer	Model No.	Serial No.	Power cord	signal cable
1.	Power Adaptor	Netradyne Inc.	N/A	D-210-A D3	N/A	N/A

4.4 Test Peripheral List

No .	Equipment	Manufacturer	Model No.	Serial No.	Power cord	signal cable
1	DC Power Supply	JUNKE	N/A	JK15040K	20181126-43	2m Unshielded Cable
2.	Laptop	DELL	N/A	Latitude E7240	6SJ2T02	2m unshielded

5 Equipments List for All Test Items

No	Test Equipment	Manufacturer	Model No	Serial No	Cal. Date	Cal. Due Date
1	EMI TEST Receiver	Spectrum Analyzer	FSP40	101163	2020/12/11	2022/12/10
2	Loop antenna	DAZE Beijing	ZN30900C	18052	2020/01/29	2022/01/28
3	Hi power horn antenna	DAZE Beijing	ZN30700	18012	2020/01/30	2022/01/29
4	Horn antenna	DAZE Beijing	ZN30702	18006	2020/01/30	2022/01/29
5	Horn antenna	DAZE Beijing	ZN30703	18005	2020/01/30	2022/01/29
6	Preamplifier	KELIANDA	LNA-0009295	-	2021/01/13	2022/01/13
7	Preamplifier	KELIANDA	CF-00218	-	2021/01/13	2022/01/13
8	Bi conical Antenna	DAZE Beijing	ZN30505C	17038	2020/01/28	2022/01/29
9	EMI-RECEIVER	Schwarzbeck	FCKL	1528194	2021/01/13	2022/01/13
10	Spectrum Analyzer	ADVANTEST	R3361	-	2021/01/13	2022/01/13
11	LISN	Kyoritsu	KNW-407	8-1789-5	2021/01/13	2022/01/13
12	Network-LISN	Schwarzbeck	NNBM8125	81251314	2021/01/13	2022/01/13
13	Network-LISN	Schwarzbeck	NNBM8125	81251315	2021/01/13	2022/01/13
14	PULSELIMITER	Rohde and Schwarz	ESH3-Z2	100681	2020/05/13	2021/05/12
15	50ΩCoaxialSwitch	DAIWA	1565157	-	2020/05/13	2021/05/12
16	50ΩCoaxialSwitch	-	-	-	2020/05/13	2021/05/12
17	Wireless signal power meter	DARE!!	RPR3006W	RFSW190220	2021/01/13	2022/01/13
18	Signal Generator	KEYSIGHT	N5181A	512071	2021/01/13	2022/01/13

Report No.: AAEMT/EMC/210901-01-07

19	RF Vector Signal Generator	Keysight	N5182B	512094	2021/01/13	2022/01/13
20	Spectrum analyzer	R&S	FSV-40N	101385	2021/01/13	2022/01/13
21	Radio Communication Tester	R&S	CMW 500	124589	2020/5/15	2021/5/14
22	Signal Generator	R&S	SMP02	837017/004 836593/005	2020/5/15	2021/5/14
23	DC Power Supply	Guanker	JK15040K	TNC/ET/C/0 01/15	2020/2/2	2022/2/1
24	Pro. Temp & Humi. chamber	MENTEK	MHP-150-1C	MAA081125 01	2020/2/2	2022/2/1
25	Attenuators	AGILENT	8494B	-	-	-
26	Attenuators	AGILENT	8495B	-	-	-

5.1 Output Power Measurement

5.1.1 LIMITS OF OUTPUT POWER MEASUREMENT

Fixed, mobile, and portable (hand-held) stations operating in the 1710–1755 MHz band and mobile and portable stations operating in the 1695-1710 MHz and 1755-1780 MHz bands are limited to 1 watt EIRP

Portable stations (hand-held devices) operating in the 746-757 MHz, 776-788 MHz and 805-806 MHz band are limited to 3 watts ERP

Portable stations (hand-held device) operating in the 600 MHz uplink band and the 698-746 MHz band, and fixed and mobile stations in the 600 MHz uplink band are limited to 3 watts ERP

5.1.2 TEST PROCEDURES

EIRP/ ERP Measurement:

- a. All measurements were done at low, middle and high operational frequency range. RBW and VBW is 10 MHz for LTE mode.
- b. Substitution method is used for E.I.R.P measurement. In the semi-anechoic chamber, EUT placed on the 0.8 m (below or equal 1 GHz) and/or 1.5 m (above 1 GHz) height of Turn Table, rotated the table around 360 degrees to search the maximum radiation power and receiver antenna shall be rotated vertical and horizontal polarization and moved height from 1 m to 4 m to find the maximum polar radiated power. The “Read Value” is the spectrum reading the maximum power value.
- c. The substitution horn antenna is substituted for EUT at the same position and signals generator export the CW signal to the substitution antenna via a tx cable. Rotated the Turn Table and moved receiving antenna to find the maximum radiation power. Adjust output power level of S.G to get a Value of spectrum reading equal to “Read Value” of step b. Record the power level of S.G.
- d. $EIRP = \text{Output power level of S.G} - \text{TX cable loss} + \text{Antenna gain of substitution horn}$. E.R.P power can be calculated form E.I.R.P power by subtracting the gain of dipole, $E.R.P \text{ power} = E.I.R.P \text{ power} - 2.15 \text{ dB}$.

CONDUCTED POWER MEASUREMENT:

- a. The EUT was set up for the maximum power with LTE link data modulation and link up with simulator.
- b. Set the EUT to transmit under low, middle and high channel and record the power level shown on simulator.

5.1.3 TEST SETUP

EIRP/ERP Measurement:

<Radiated Emission below or equal 1 GHz>

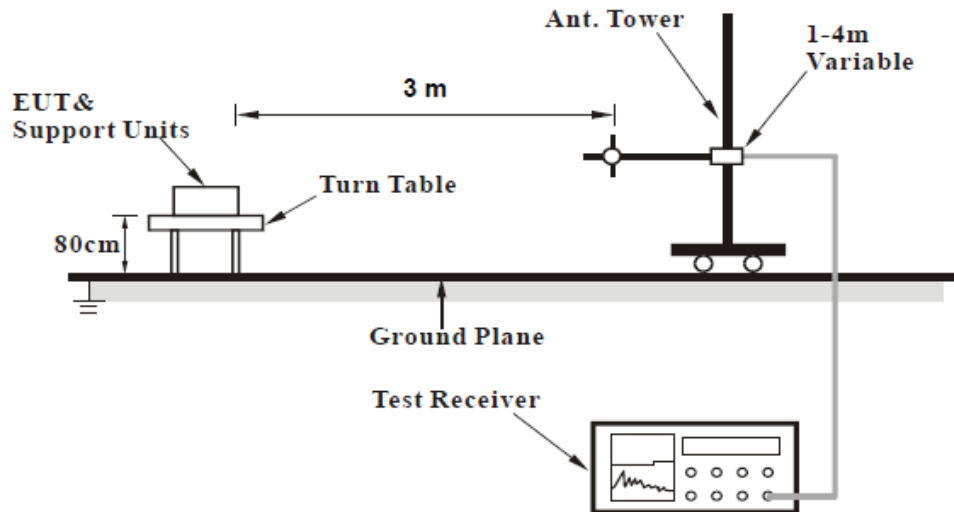

<Radiated Emission above 1 GHz>

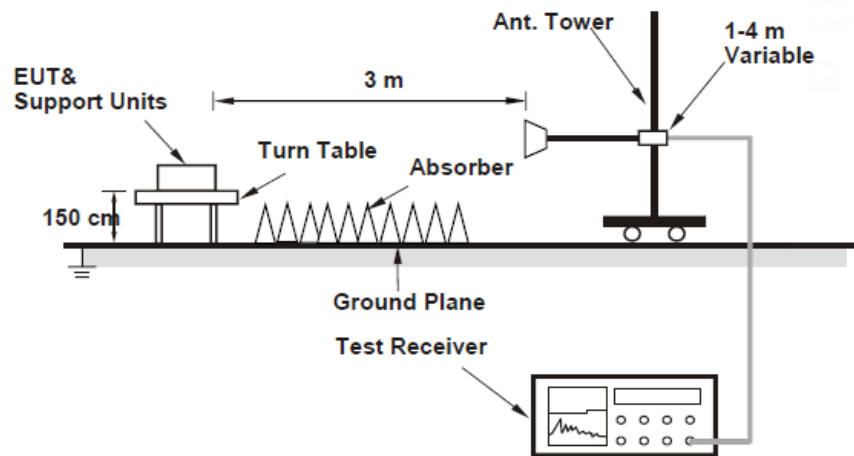

CONDUCTED POWER MEASUREMENT:

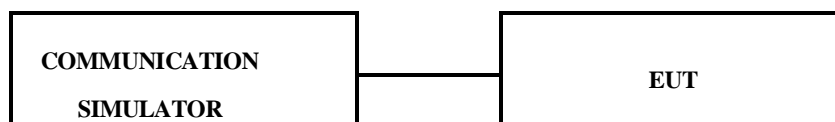

5.1.4 Test results

Conducted Output Power (dBm)

Band 4

LTE Band 4				
Modulation	Bandwidth	Channels	Frequency (MHz)	Tx Average (dBm)
QPSK	10MHz	20000	1715	23.93
		20175	1732.5	25.39
		20350	1750	25.29

Band 12

LTE Band 12				
Modulation	Bandwidth	Channels	Frequency (MHz)	Tx Average (dBm)
QPSK	10MHz	23060	704	26.66
		23095	707.5	25.86
		23130	711	26.31

ERP Power (dBm)

LTE Band 12							
Channel Bandwidth: 10 MHz / QPSK							
Plane	Channel	Frequency (MHz)	Reading (dBm)	Correction Factor (dB)	ERP (dBm)	ERP (mW)	Polarization (H/V)
X	23060	704	-3.19	30.36	25.02	317.69	H
	23095	707.5	-3.23	30.17	24.79	301.30	
	23130	711	-3.44	30.17	24.58	287.08	
	23060	704	-11.76	32.03	18.12	64.86	V
	23095	707.5	-12.05	31.98	17.78	59.98	
	23130	711	-12.30	32.06	17.61	57.68	

Note: ERP (dBm) = Reading (dBm) + Correction Factor (dB) – 2.15

LTE Band 4							
Channel Bandwidth: 10 MHz / QPSK							
Plane	Channel	Frequency (MHz)	Reading (dBm)	Correction Factor (dB)	EIRP (dBm)	EIRP (mW)	Polarization (H/V)
X	20000	1715	-8.48	36.45	27.97	626.61	H
	20175	1732.5	-8.66	36.80	28.14	651.63	
	20350	1750	-9.12	36.94	27.82	605.34	
	20000	1715	-14.00	37.28	23.28	212.81	V
	20175	1732.5	-14.11	37.63	23.52	224.91	
	20350	1750	-14.66	37.64	22.98	198.61	

Note: EIRP (dBm) = Reading (dBm) + Correction Factor (dB)

5.2 FREQUENCY STABILITY MEASUREMENT

5.2.1 LIMITS OF FREQUENCY STABILITY MEASUREMENT

The frequency stability shall be sufficient to ensure that the fundamental emissions stay within the authorized bands of operation.

5.2.2 TEST PROCEDURE

- a. Device is placed at the oven room. The oven room could control the temperatures and humidity. Power warm up is at least 15 min and power applied should perform before recording frequency error.
- b. EUT is connected the external power supply to control the DC input power. The test voltage range is from minimum to maximum working voltage. Each step shall be record the frequency error rate.
- c. The temperature range step is 10 degrees in this test items. All temperature levels shall be hold the $\pm 0.5^{\circ}\text{C}$ during the measurement testing. The each temperature step shall be at least 0.5 hours, consider the EUT could be test under the stability condition.

NOTE: The frequency error was recorded frequency error from the communication simulator.

5.2.3 TEST SETUP

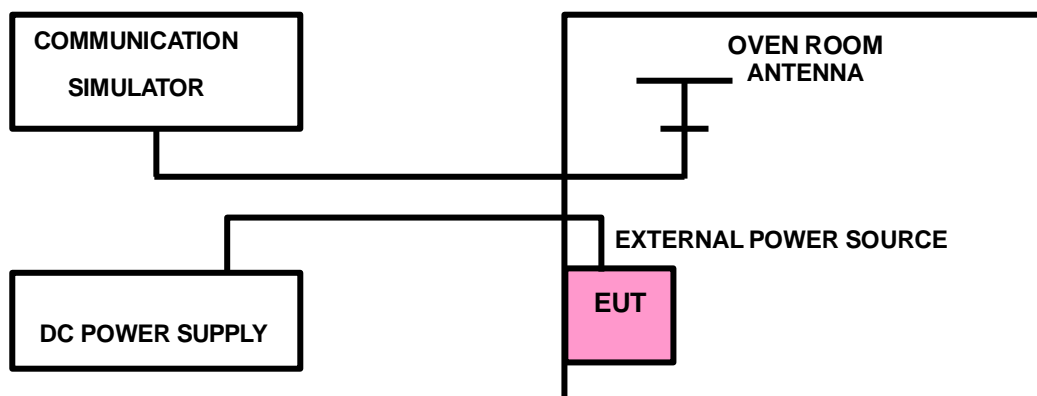

5.2.4 TEST RESULTS

Frequency Error vs. Temperature

Temp. (°C)	LTE Band 4			
	Channel Bandwidth: 10 MHz			
	Low Channel		High Channel	
	Frequency (MHz)	Frequency Error (ppm)	Frequency (MHz)	Frequency Error (ppm)
-20	1715.45780	0.002	1750.35790	0.001
20	1715.55380	-0.002	1750.35790	-0.001
50	1715.45780	-0.002	1750.35790	-0.001

Temp. (°C)	LTE Band 12			
	Channel Bandwidth: 10 MHz			
	Low Channel		High Channel	
	Frequency (MHz)	Frequency Error (ppm)	Frequency (MHz)	Frequency Error (ppm)
-20	704.45780	0.002	711.35790	0.001
20	704.45380	-0.002	711.35690	-0.001
50	704.45780	-0.002	711.35790	-0.001

5.3 OCCUPIED BANDWIDTH MEASUREMENT

5.3.1 Limits of Occupied Bandwidth Measurement

The width of a frequency band such that, below the lower and above the upper frequency limits, the mean powers emitted are each equal to a specified percentage 0.5 % of the total mean power of a given emission.

5.3.2 TEST PROCEDURES

- a. The conducted occupied bandwidth used the power splitter via EUT RF power connector between simulation base station and spectrum analyzer.
- b. Use OBW measurement function of Spectrum analyzer to measure 99 % occupied bandwidth.

5.3.3 TEST SETUP

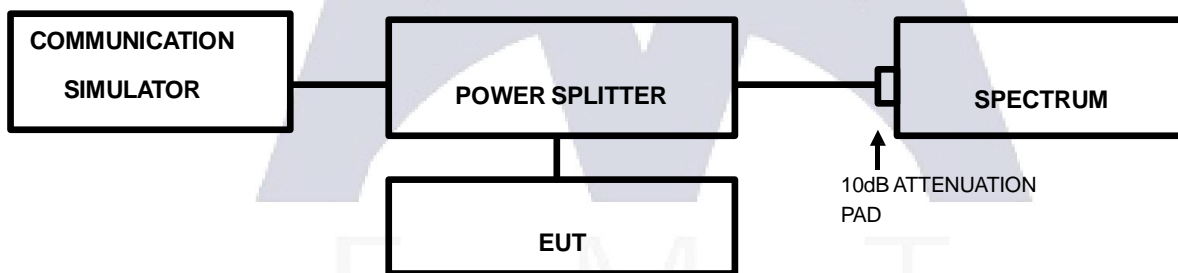

5.3.4 TEST RESULTS

LTE Band 4		
Channel Bandwidth: 10 MHz		
Channel	Frequency (MHz)	99 % Occupied Bandwidth (MHz)
		QPSK
20000	1715	2.431
20175	1732.5	2.402
20350	1750	2.431

LTE Band 12		
Channel Bandwidth: 10 MHz		
Channel	Frequency (MHz)	99 % Occupied Bandwidth
		QPSK
23060	704	2.460
23095	707.5	2.749
23130	711	2.547

Band 4

1715MHz

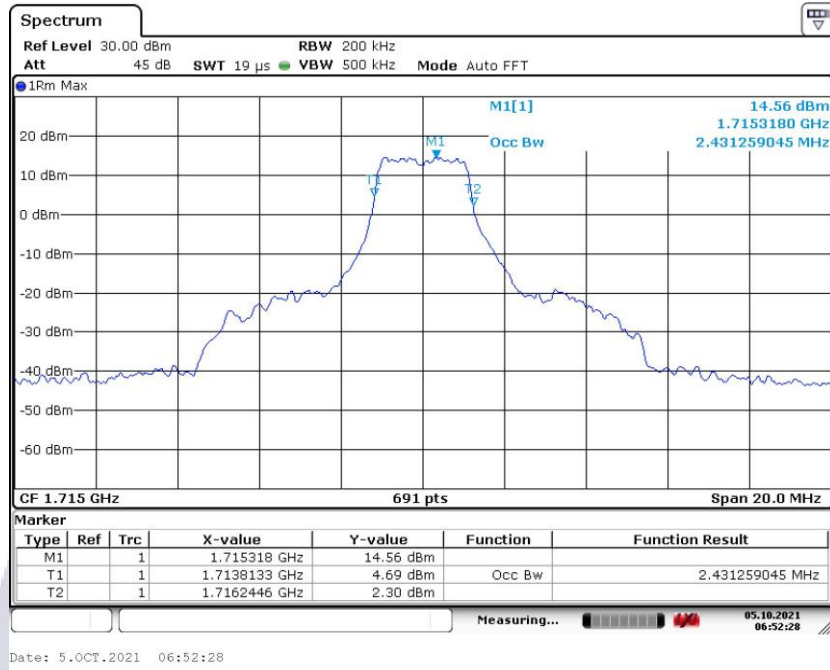

1732.5MHz

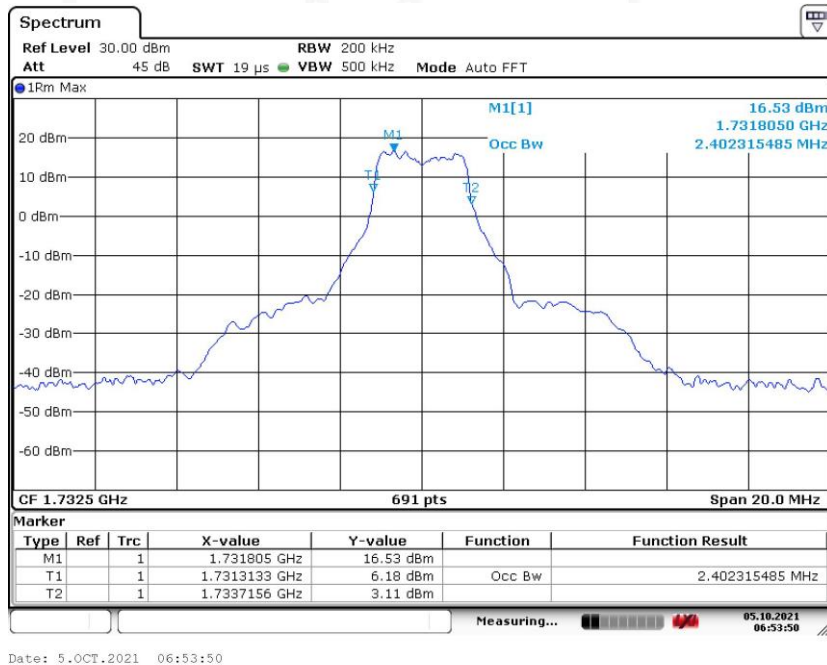

1750MHz

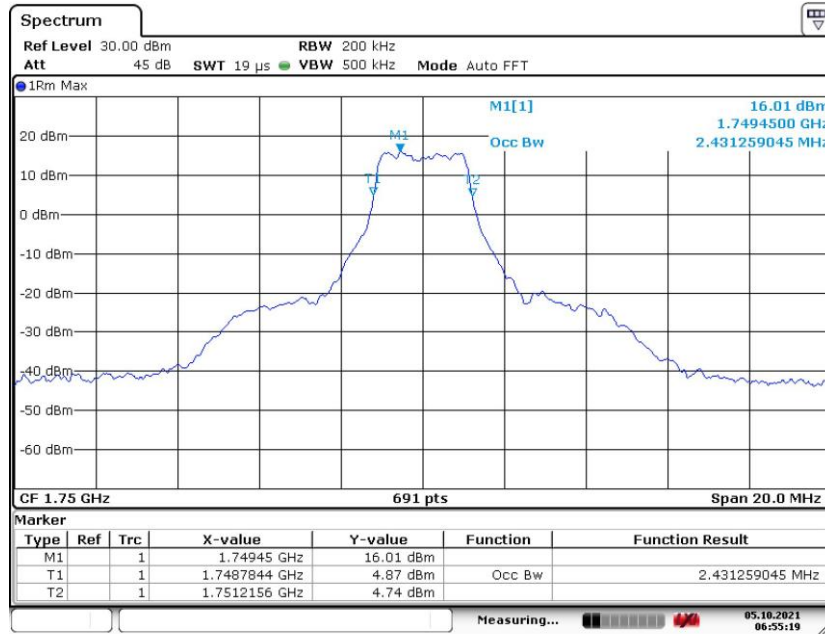

Date: 5.OCT.2021 06:55:19



Band 12

704MHz

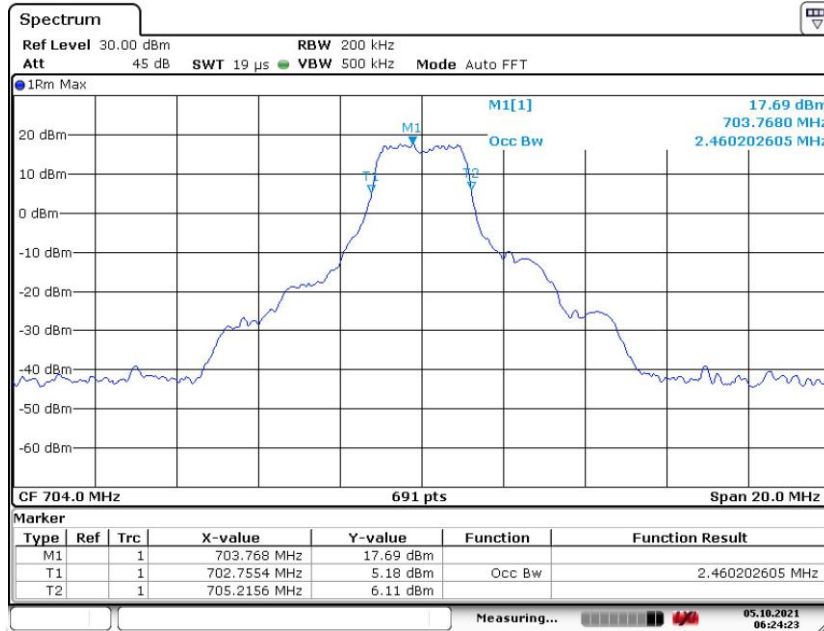

Date: 5.OCT.2021 06:24:23

707.5MHz

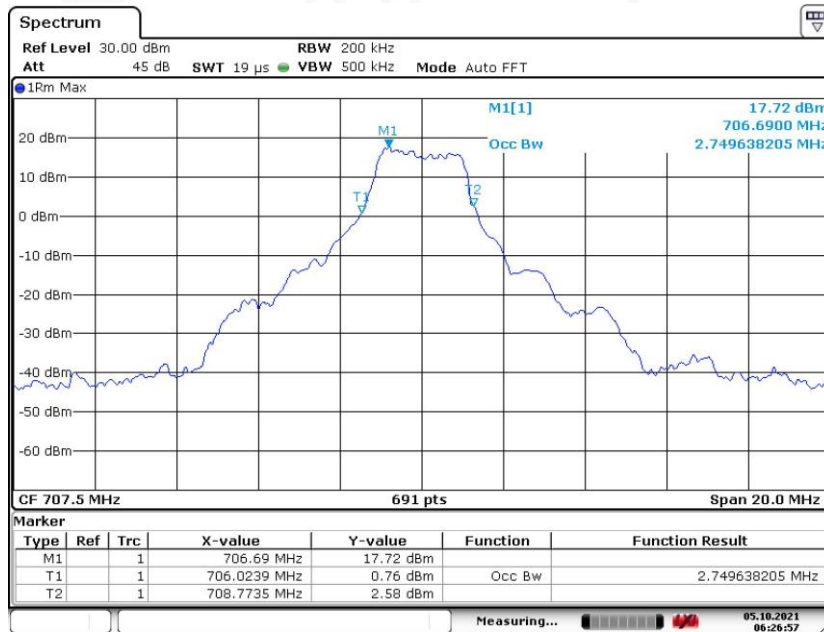

Date: 5.OCT.2021 06:26:57

711MHz

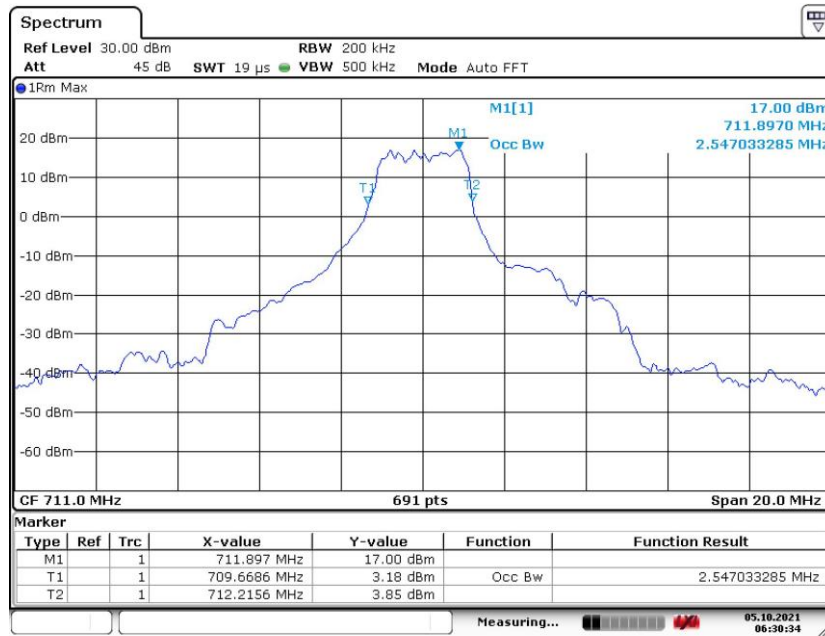

Date: 5.OCT.2021 06:30:34



5.4 BAND EDGE MEASUREMENT

5.4.1 LIMITS OF BAND EDGE MEASUREMENT

For operations in the 698-787 MHz band, the power of any emission outside a licensee's frequency band(s) of operation shall be attenuated below the transmitter power (P) within the licensed band(s) of operation, measured in watts, by at least $43 + 10 \log (P)$ dB. Compliance with this provision is based on the use of measurement instrumentation employing a resolution bandwidth of 100 kilohertz or greater.

However, in the 100 kilohertz bands immediately outside and adjacent to a licensee's frequency block, a resolution bandwidth of at least 30 kHz may be employed.

For operations in the 746-758 MHz band and the 776-788 MHz band, the power of any emission outside a licensee's frequency band(s) of operation shall be attenuated below the transmitter power (P) within the licensed band(s) of operation, measured in watts, by at least $43 + 10 \log (P)$ dB.

On all frequencies between 763-775 MHz and 793-805 MHz, by a factor no less than $65 + 10 \log (P)$ dB in a 6.25 kHz band segment, for mobile and portable stations.

For operations in the 1710–1755 MHz bands, the power of any emission outside a licensee's frequency block shall be attenuated below the transmitter power (P) by at least $43 + 10 \log (P)$ dB.

5.4.2 TEST SETUP

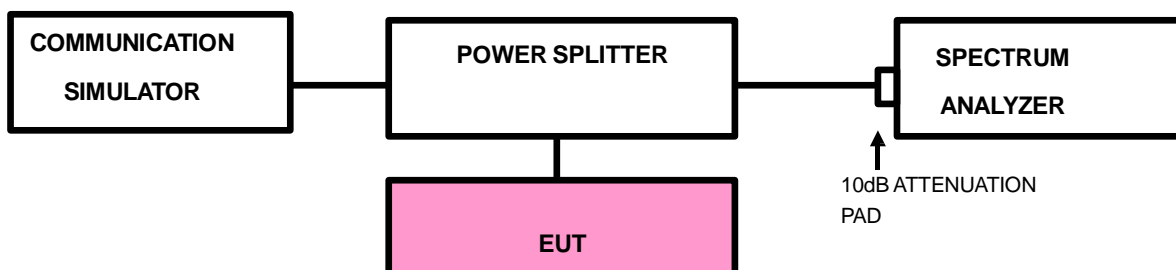

5.4.3 TEST PROCEDURES

- a. All measurements were done at low and high operational frequency range.
- b. The center frequency of spectrum is the band edge frequency and span is 1~5 MHz. RBW of the spectrum is 20 KHz and VBW of the spectrum is 100 kHz. (LTE bandwidth 1.4MHz)
- c. Record the max trace plot into the test report.

6.5.4. TEST RESULTS

LTE Band 4

Channel Bandwidth: 10 MHz

1715MHz

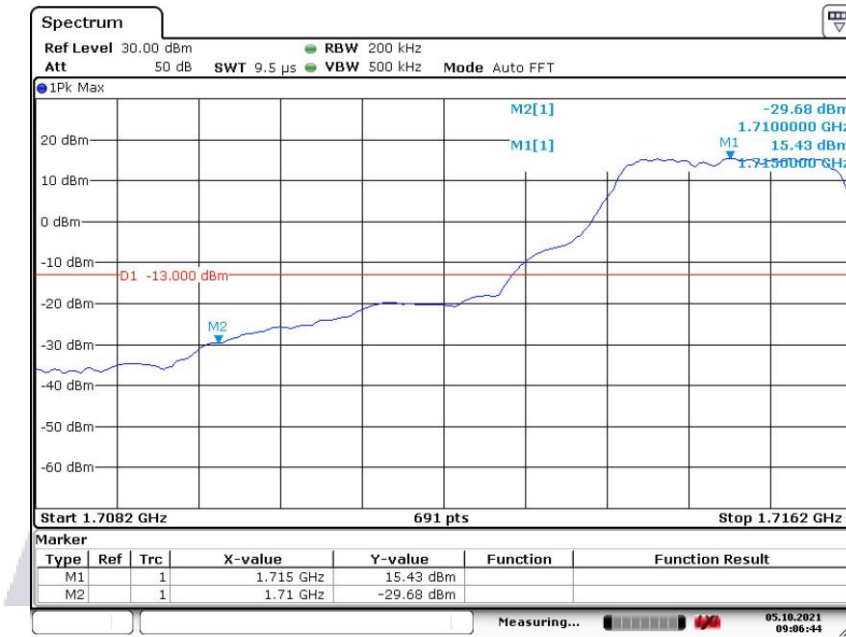

1750MHz

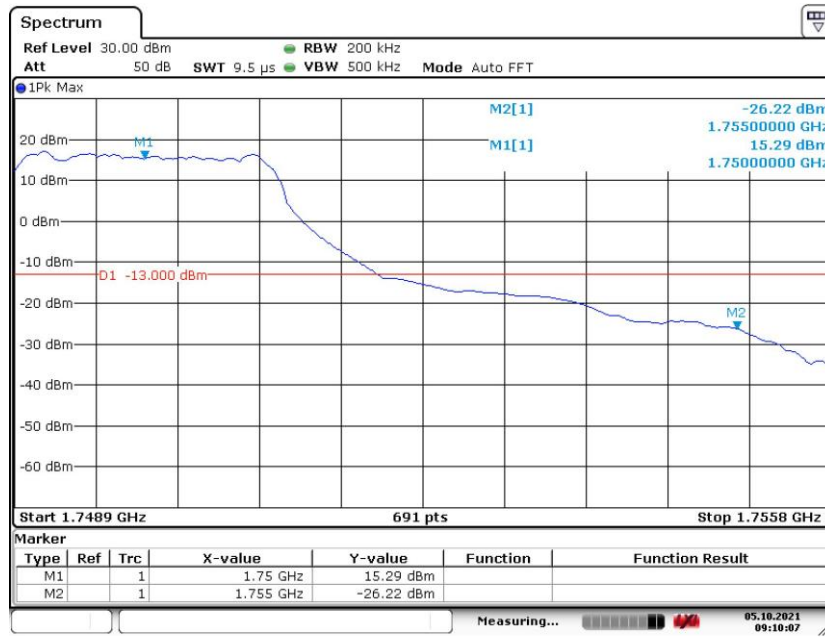

LTE Band 12

Channel Bandwidth: 10 MHz

704MHz

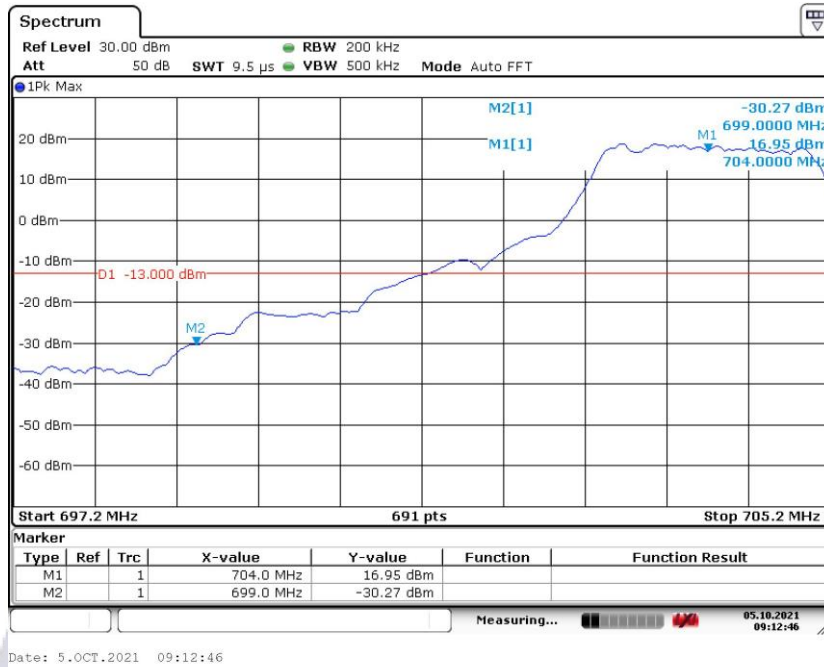

711MHz

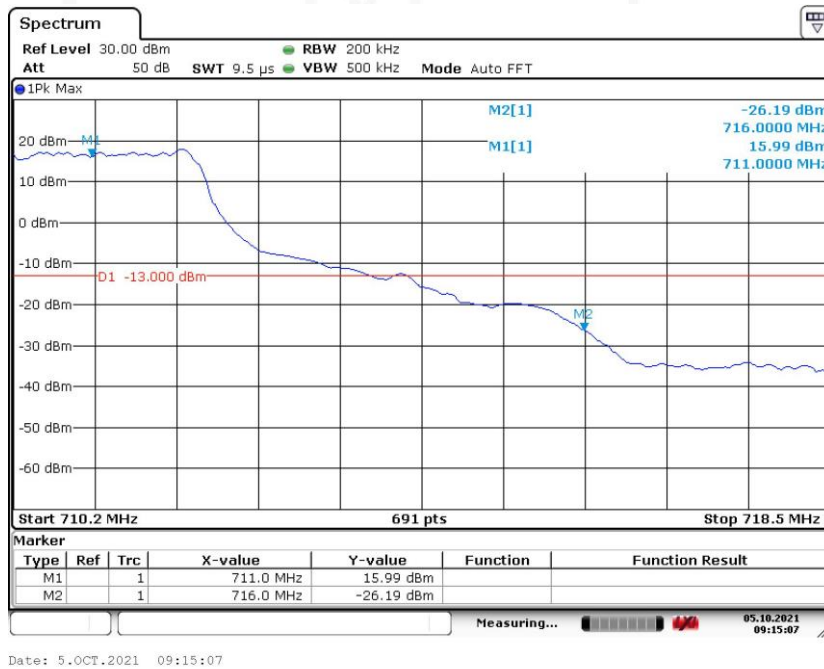

5.5 PEAK TO AVERAGE RATIO

5.3.5 Limits of Peak to Average Ratio Measurement

In measuring transmissions in this band using an average power technique, the peak to-average ratio (PAR) of the transmission may not exceed 13 dB.

5.3.6 Test Setup

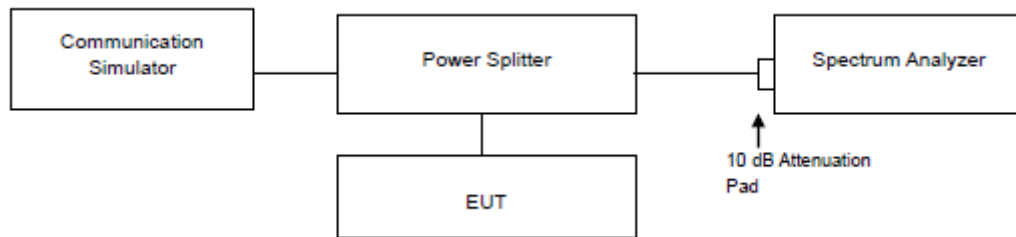

5.3.7 Test Procedures

1. Set resolution/measurement bandwidth \geq signal's occupied bandwidth;
2. Set the number of counts to a value that stabilizes the measured CCDF curve;
3. Record the maximum PAPR level associated with a probability of 0.1 %.

5.3.8 Test Result

LTE Band 4		
Channel Bandwidth: 10 MHz		
Channel	Frequency (MHz)	Peak to Average Ratio
		QPSK
20000	1715	8.18
20175	1732.5	5.25
20350	1750	5.23

LTE Band 12		
Channel Bandwidth: 10 MHz		
Channel	Frequency (MHz)	Peak to Average Ratio
		QPSK
23060	704	6.58
23095	707.5	6.19
23130	711	4.49

Band 4

1715MHz



1732.5MHz

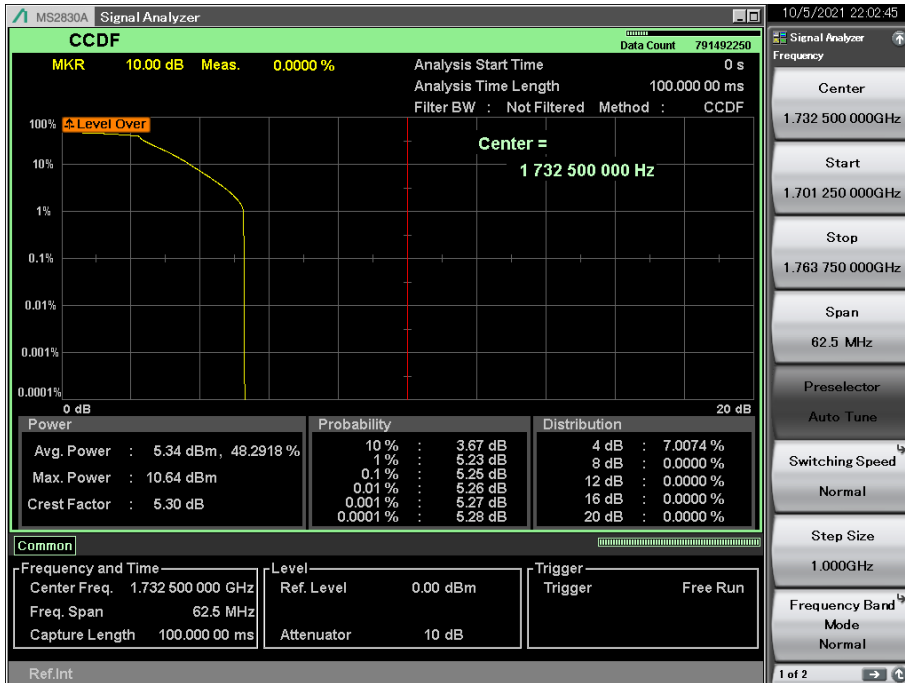

1750MHz



Band12

704MHz

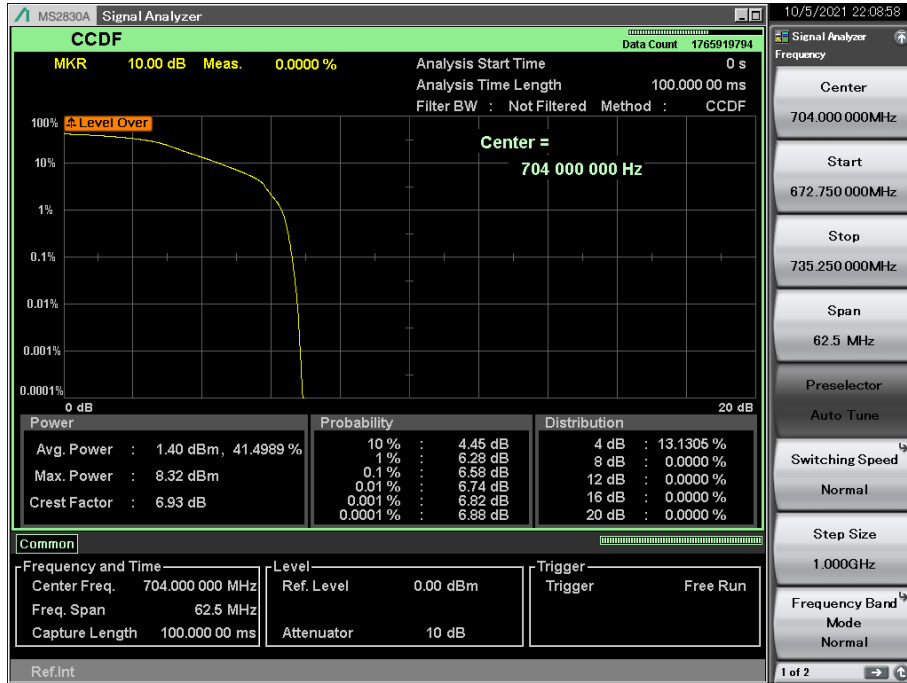

707.5MHz



711MHz



5.4 Conducted Spurious Emissions

5.4.1 Limits of Conducted Spurious Emissions Measurement

The power of any emission outside of the authorized operating frequency ranges must be attenuated below the transmitting power (P) by a factor of at least $43 + 10 \log (P)$ dB. The emission limit equal to -13 dBm.

5.4.2 Test Setup

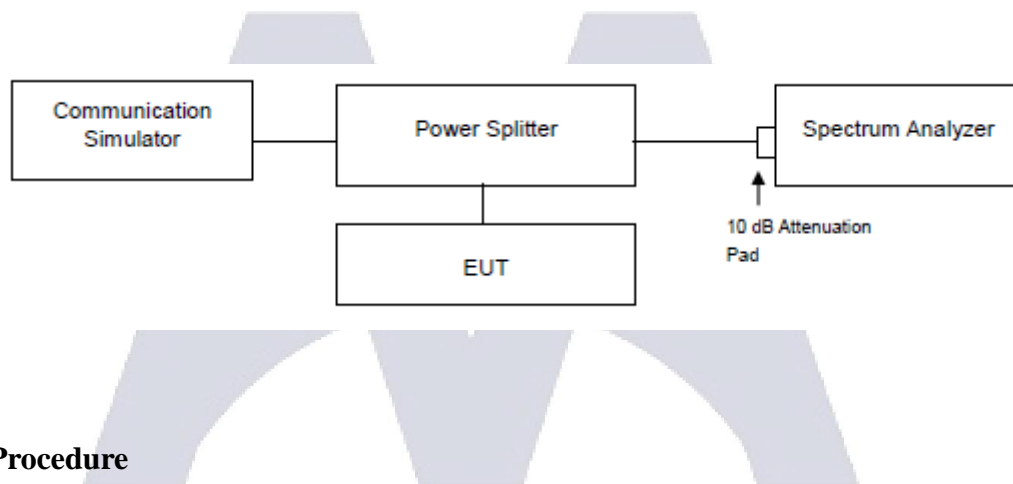

5.4.3 Test Procedure

- The EUT makes a phone call to the communication simulator. All measurements were done at low, middle and high operational frequency range.
- Measuring frequency range is from 9 kHz to 1 GHz. 10 dB attenuation pad is connected with spectrum. RBW = 100 kHz and VBW = 300 kHz is used for conducted emission measurement.
- Measuring frequency range is from 1 GHz to 27 GHz. 10 dB attenuation pad is connected with spectrum. RBW = 1 MHz and VBW = 3 MHz is used for conducted emission measurement.

5.4.4 Test Results

LTE Band 4

Channel Bandwidth: 10 MHz

1715MHz

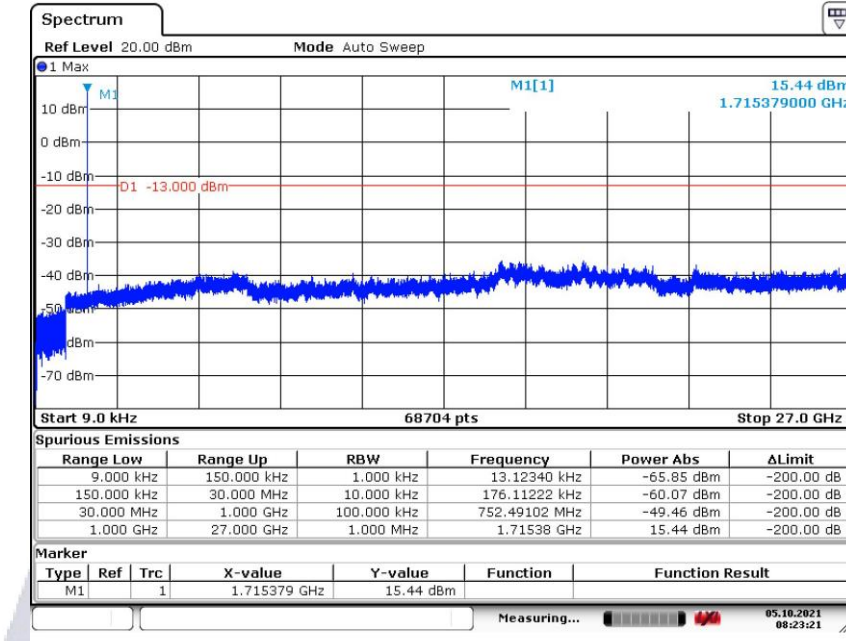

Date: 5.OCT.2021 08:23:21

1732.5MHz

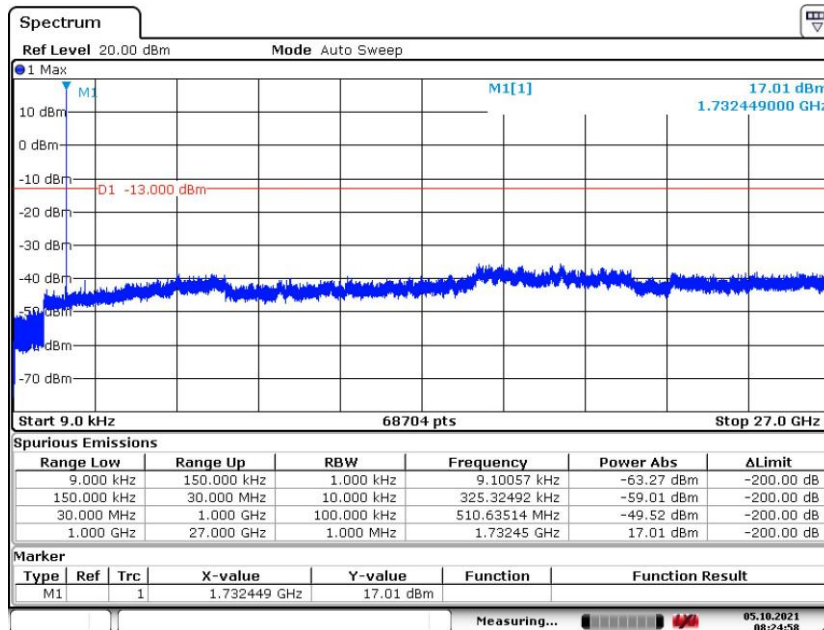

Date: 5.OCT.2021 08:24:58

1750MHz

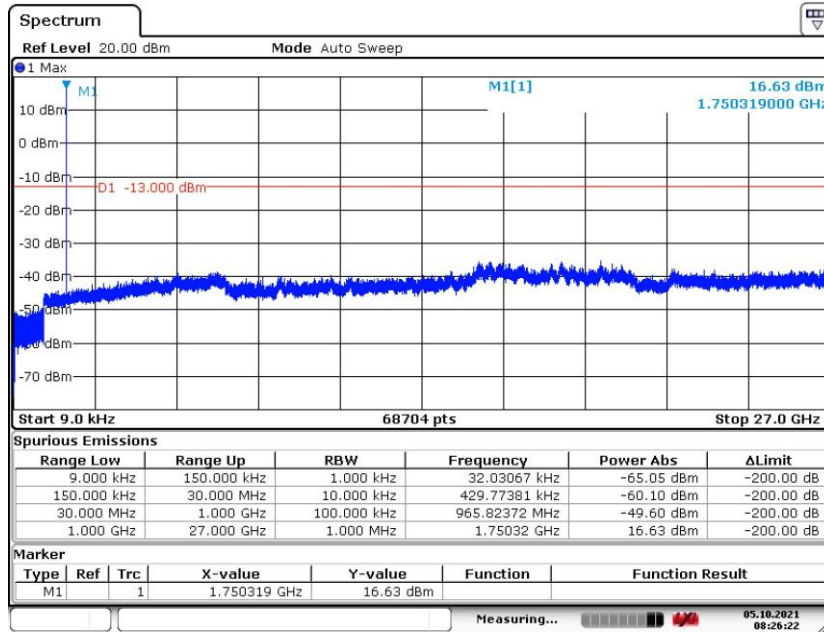

LTE Band 12
Channel Bandwidth: 10 MHz

704MHz

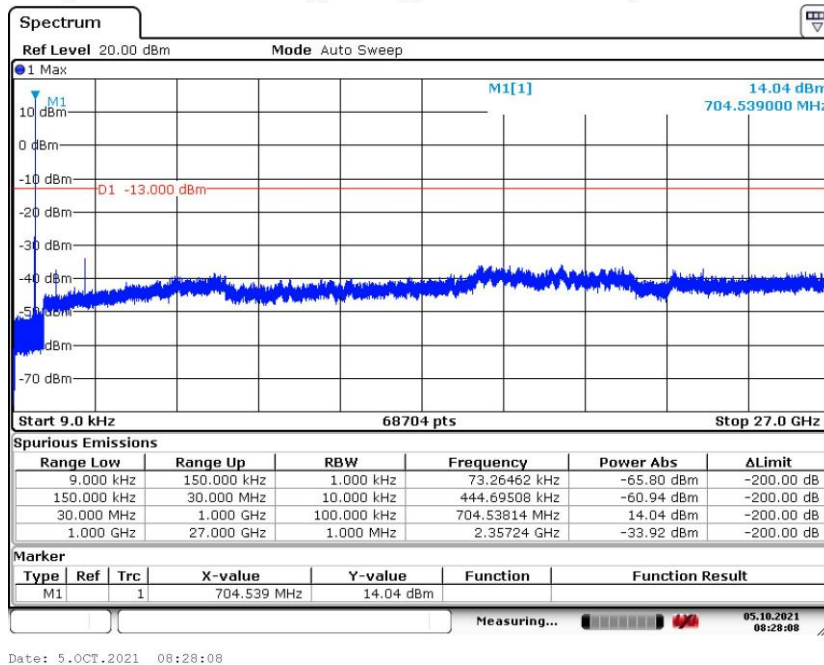

707.5MHz

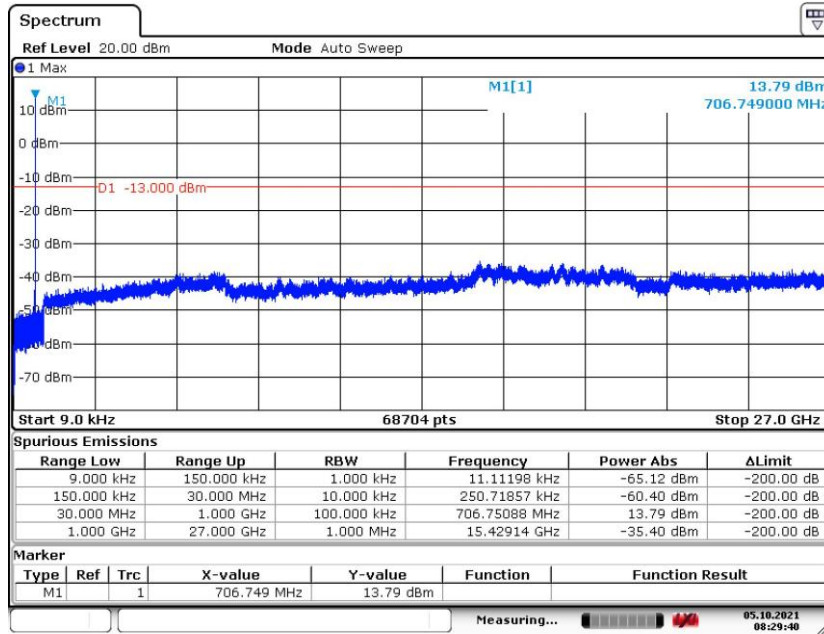

Date: 5.OCT.2021 08:29:40

711MHz

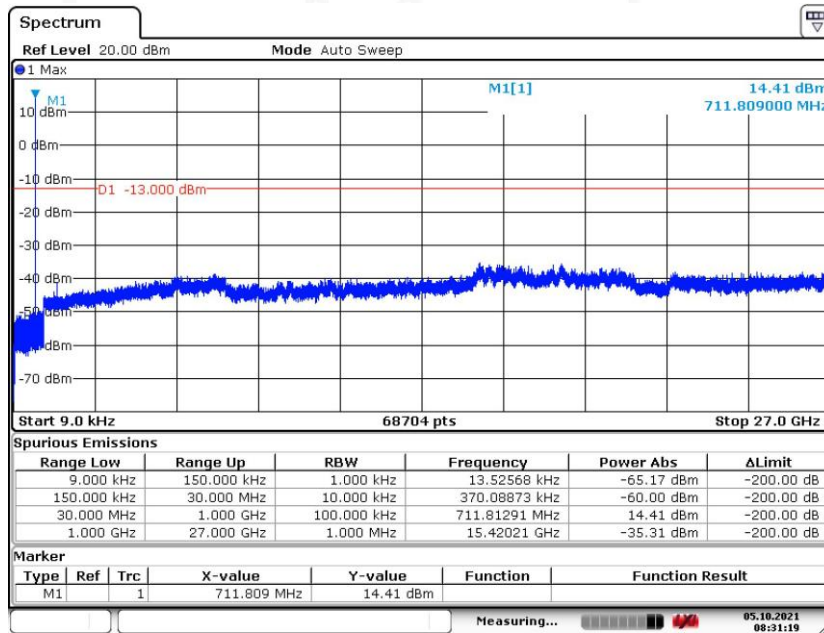

Date: 5.OCT.2021 08:31:18

5.5 Radiated Emission Measurement

5.5.1 Limits of Radiated Emission Measurement

The power of any emission outside of the authorized operating frequency ranges must be attenuated below the transmitting power (P) by a factor of at least $43 + 10 \log (P)$ dB. The emission limit is equal to -13 dBm.

5.5.2 Test Procedure

1. Substitution method is used for E.I.R.P measurement. In the semi-anechoic chamber, EUT placed on the 0.8 m (below or equal 1 GHz) and/or 1.5 m (above 1 GHz) height of Turn Table, rotated the table around 360 degrees to search the maximum radiation power and receiver antenna shall be rotated vertical and horizontal polarization and moved height from 1 m to 4 m to find the maximum polar radiated power. The “Read Value” is the spectrum reading the maximum power value.
2. The substitution horn antenna is substituted for EUT at the same position and signals generator export the CW signal to the substitution antenna via a TX cable. Rotated the Turn Table and moved receiving antenna to find the maximum radiation power. Adjust output power level of S.G to get a Value of spectrum reading equal to “Read Value” of step a. Record the power level of S.G.
3. $EIRP = \text{Output power level of S.G} - \text{TX cable loss} + \text{Antenna gain}$
4. E.R.P power can be calculated form E.I.R.P power by subtracting the gain of dipole, $E.R.P \text{ power} = E.I.R.P \text{ power} - 2.15 \text{ dB}$

NOTE: The resolution bandwidth and video bandwidth of test receiver/spectrum analyzer is 1 MHz/3 MHz.

4.5.1 Deviation from Test Standard

No deviation.

5.5.3 Test Setup

<Radiated Emission below or equal 1 GHz>

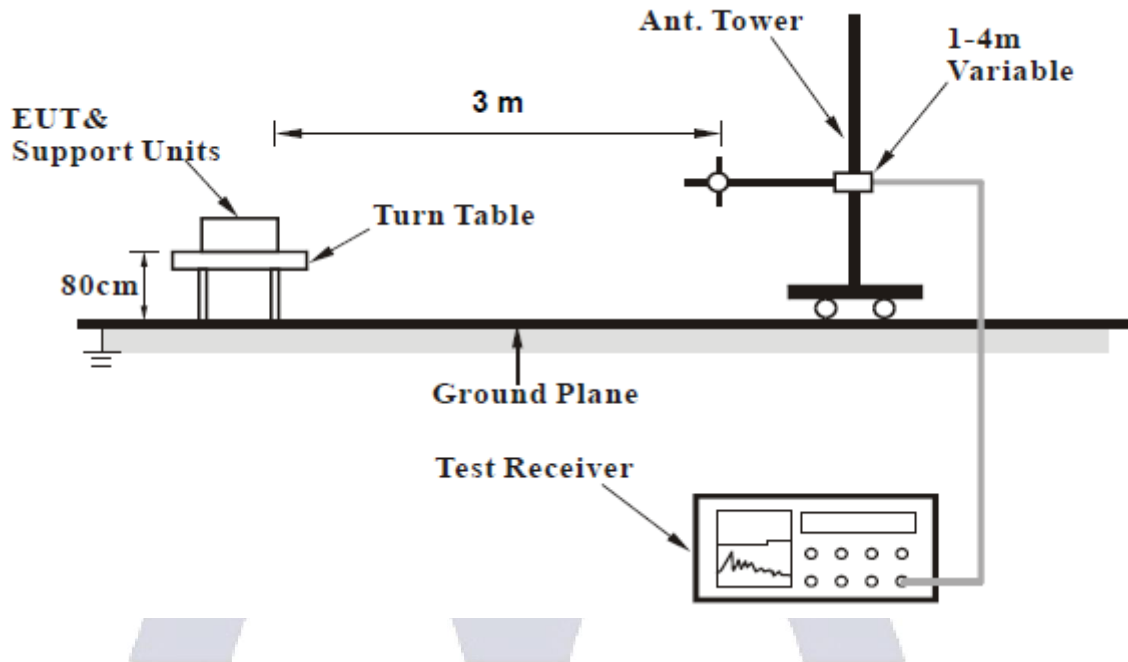

<Radiated Emission above 1 GHz>

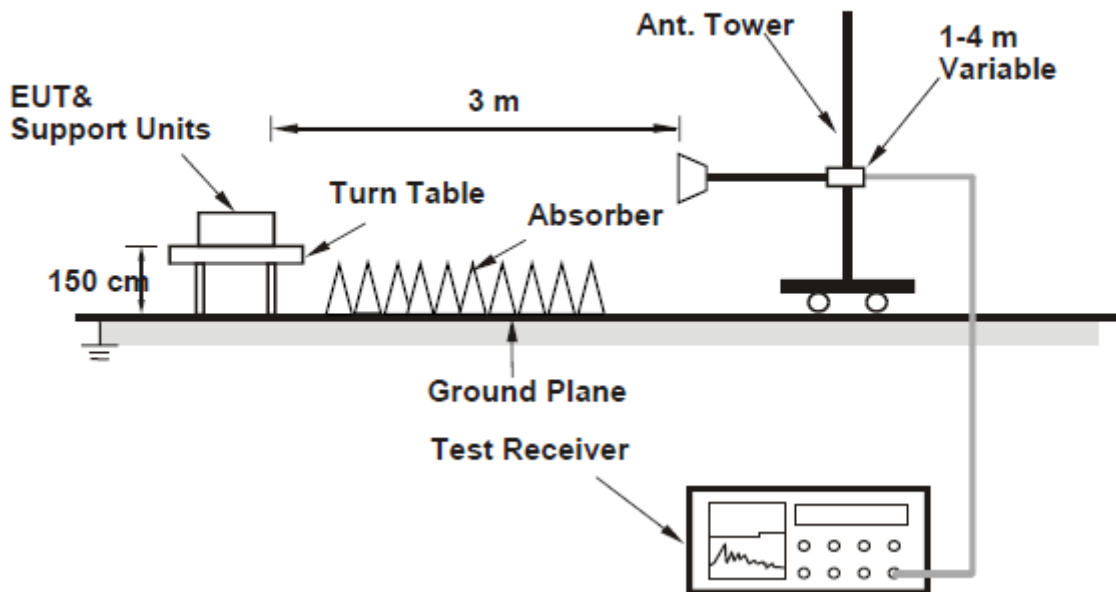

5.5.4 Test Results

LTE Band 4

Channel Bandwidth: 10 MHz/QPSK

1715MHz

Vertical

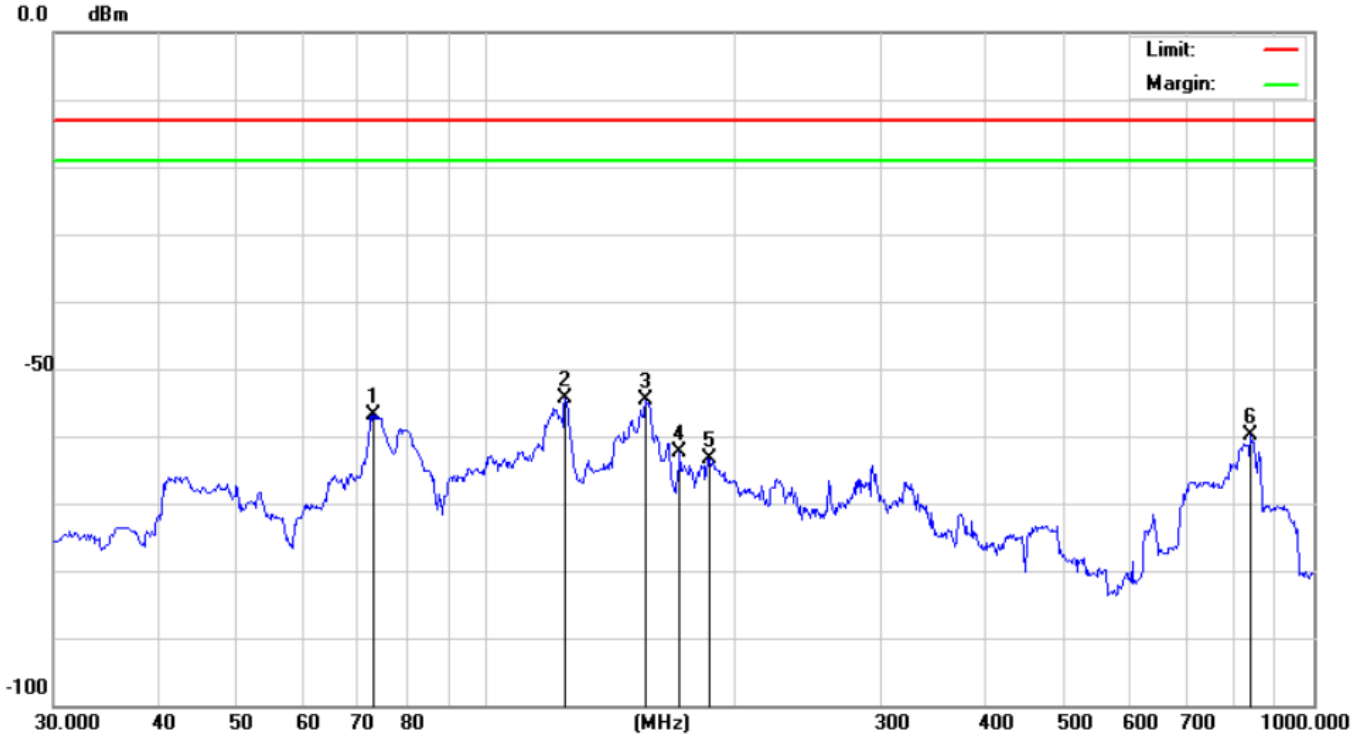

No.	Mk.	Freq. MHz	Reading Level dBm	Correct Factor dB	Measure- ment dBm	Limit dB	Over dB	Detector
1		73.1025	-39.16	-17.65	-56.81	-13.00	-43.81	QP
2	*	124.5690	-38.18	-16.11	-54.29	-13.00	-41.29	QP
3		156.0997	-38.89	-15.77	-54.66	-13.00	-41.66	QP
4		171.6200	-46.66	-15.61	-62.27	-13.00	-49.27	QP
5		186.1699	-48.26	-15.10	-63.36	-13.00	-50.36	QP
6		839.9500	-60.20	0.25	-59.95	-13.00	-46.95	QP

LTE Band 4

Channel Bandwidth: 10 MHz/QPSK

1715MHz

Horizontal

0.0 dBm



No.	Mk.	Freq. MHz	Reading Level dBm	Correct Factor dB	Measure- ment dBm	Limit dB	Over dB	Detector
1		73.1025	-38.16	-17.65	-55.81	-13.00	-42.81	QP
2	*	124.5690	-37.18	-16.11	-53.29	-13.00	-40.29	QP
3		156.0997	-39.39	-15.77	-55.16	-13.00	-42.16	QP
4		171.6200	-45.66	-15.61	-61.27	-13.00	-48.27	QP
5		186.1699	-46.76	-15.10	-61.86	-13.00	-48.86	QP
6		839.9500	-58.20	0.25	-57.95	-13.00	-44.95	QP

LTE Band 4

Channel Bandwidth: 10 MHz/QPSK

1715MHz

Vertical

0.0 dBm

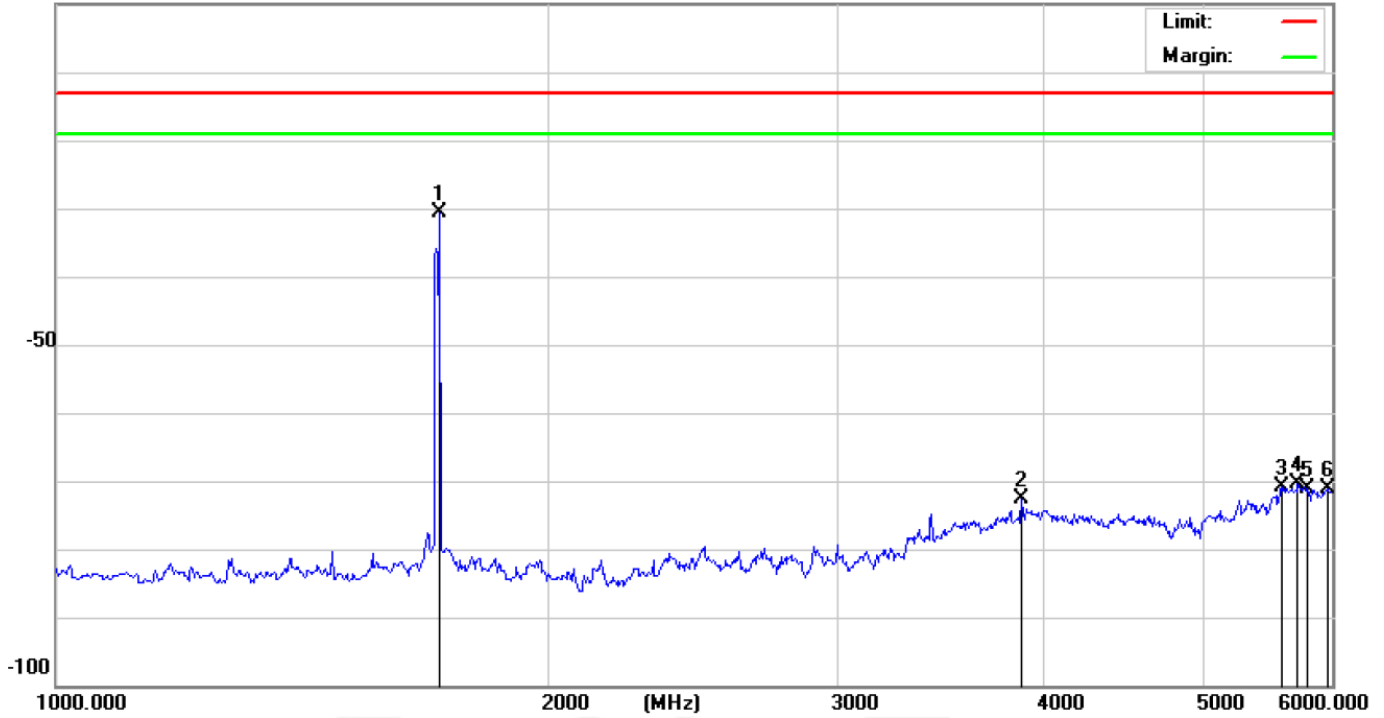

No.	Mk.	Freq. MHz	Reading Level dBm	Correct Factor dB	Measure- ment dBm	Limit dB	Over dB	Detector
1	*	1715.000	-21.62	-8.90	-30.52	-13.00	-17.52	peak
2		3880.000	-66.99	-5.57	-72.56	-13.00	-59.56	peak
3		5595.000	-67.01	-3.83	-70.84	-13.00	-57.84	peak
4		5725.000	-66.99	-3.49	-70.48	-13.00	-57.48	peak
5		5805.000	-67.81	-3.27	-71.08	-13.00	-58.08	peak
6		5965.000	-68.29	-2.84	-71.13	-13.00	-58.13	peak

LTE Band 4

Channel Bandwidth: 10 MHz/QPSK

1715MHz

Horizontal

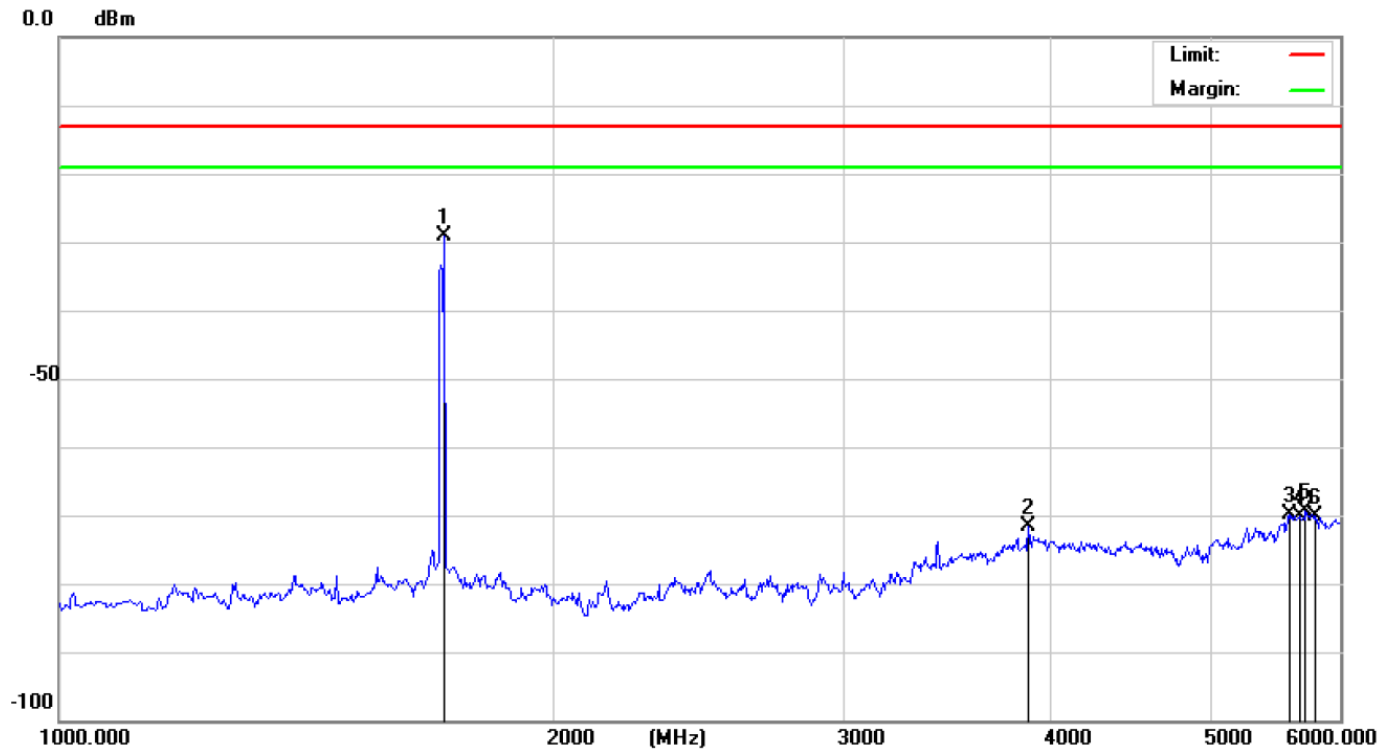

No.	Mk.	Freq. MHz	Reading Level dBm	Correct Factor dB	Measure- ment dBm	Limit dB	Over dB	Detector
1	*	1715.000	-20.12	-8.90	-29.02	-13.00	-16.02	peak
2		3880.000	-65.99	-5.57	-71.56	-13.00	-58.56	peak
3		5595.000	-66.01	-3.83	-69.84	-13.00	-56.84	peak
4		5675.000	-66.56	-3.62	-70.18	-13.00	-57.18	peak
5		5725.000	-65.99	-3.49	-69.48	-13.00	-56.48	peak
6		5805.000	-66.81	-3.27	-70.08	-13.00	-57.08	peak

LTE Band 4

Channel Bandwidth: 10 MHz/QPSK

1715MHz

Vertical

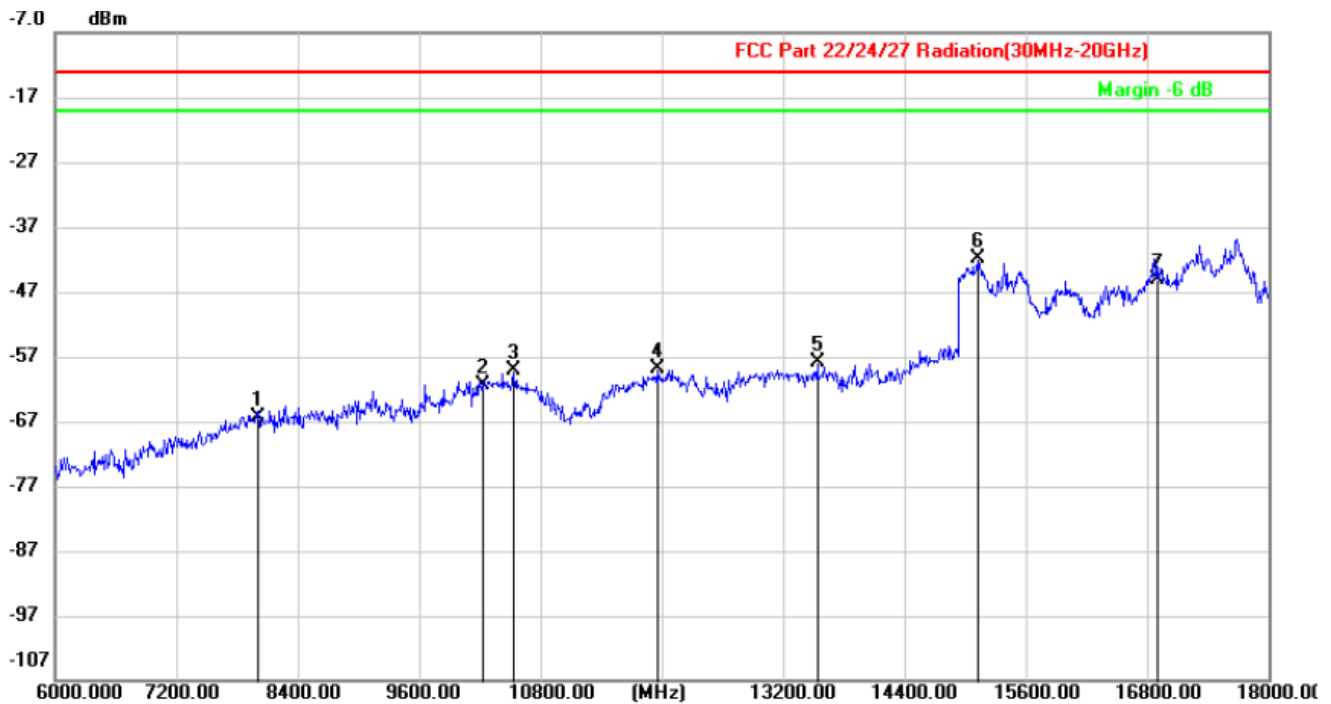

No.	Mk.	Freq. MHz	Reading Level dBm	Correct Factor dB	Measure- ment dBm	Limit dBm	Over dB	Detector
1		8004.000	-75.61	9.34	-66.27	-13.00	-53.27	peak
2		10224.00	-74.05	12.64	-61.41	-13.00	-48.41	peak
3		10536.00	-72.52	13.34	-59.18	-13.00	-46.18	peak
4		11952.00	-71.49	12.70	-58.79	-13.00	-45.79	peak
5		13536.00	-75.09	17.16	-57.93	-13.00	-44.93	peak
6	*	15120.00	-55.38	13.60	-41.78	-13.00	-28.78	peak
7		16908.00	-64.54	19.32	-45.22	-13.00	-32.22	peak

LTE Band 4

Channel Bandwidth: 10 MHz/QPSK

1715MHz

Horizontal



No.	Mk.	Freq. MHz	Reading Level dBm	Correct Factor dB	Measure- ment dBm	Limit dBm	Over dB	Detector
1		7428.000	-75.84	8.11	-67.73	-13.00	-54.73	peak
2		8124.000	-74.10	9.63	-64.47	-13.00	-51.47	peak
3		10536.00	-73.02	13.34	-59.68	-13.00	-46.68	peak
4		12936.00	-71.65	13.44	-58.21	-13.00	-45.21	peak
5		15084.00	-56.20	13.68	-42.52	-13.00	-29.52	peak
6	*	17676.00	-58.09	18.04	-40.05	-13.00	-27.05	peak

LTE Band 4

Channel Bandwidth: 10 MHz/QPSK

1732.5MHz

Vertical

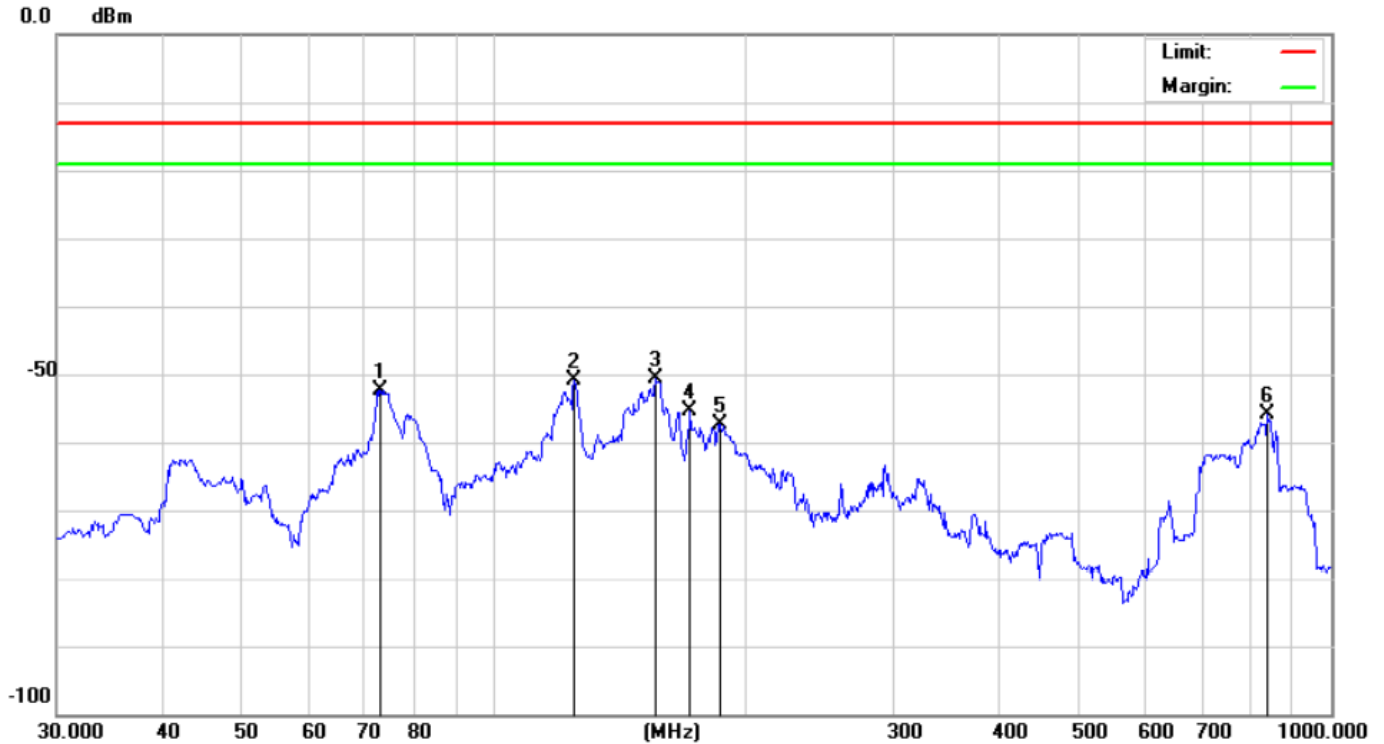

No.	Mk.	Freq. MHz	Reading Level dBm	Correct Factor dB	Measure- ment dBm	Limit dB	Over dB	Detector
1		73.1025	-34.66	-17.65	-52.31	-13.00	-39.31	QP
2		124.5690	-34.68	-16.11	-50.79	-13.00	-37.79	QP
3	*	156.0997	-34.89	-15.77	-50.66	-13.00	-37.66	QP
4		171.6200	-39.66	-15.61	-55.27	-13.00	-42.27	QP
5		186.1699	-42.26	-15.10	-57.36	-13.00	-44.36	QP
6		839.9500	-56.20	0.25	-55.95	-13.00	-42.95	QP

LTE Band 4

Channel Bandwidth: 10 MHz/QPSK

1732.5MHz

Horizontal

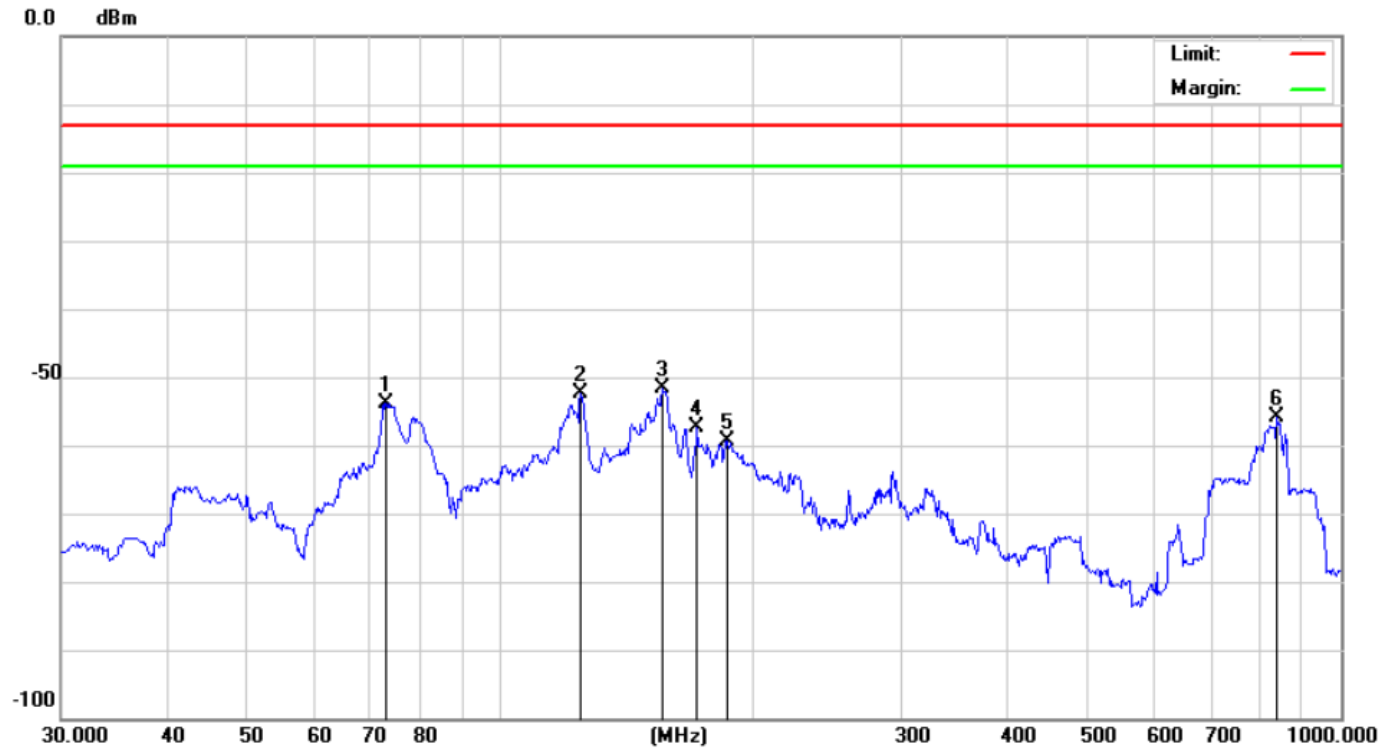

No.	Mk.	Freq. MHz	Reading Level dBm	Correct Factor dB	Measure- ment dBm	Limit dB	Over dB	Detector
1		73.1025	-36.16	-17.65	-53.81	-13.00	-40.81	QP
2		124.5690	-36.18	-16.11	-52.29	-13.00	-39.29	QP
3	*	156.0997	-35.89	-15.77	-51.66	-13.00	-38.66	QP
4		171.6200	-41.66	-15.61	-57.27	-13.00	-44.27	QP
5		186.1699	-44.26	-15.10	-59.36	-13.00	-46.36	QP
6		839.9500	-56.20	0.25	-55.95	-13.00	-42.95	QP

LTE Band 4

Channel Bandwidth: 10 MHz/QPSK

1732.5MHz

Vertical

0.0 dBm

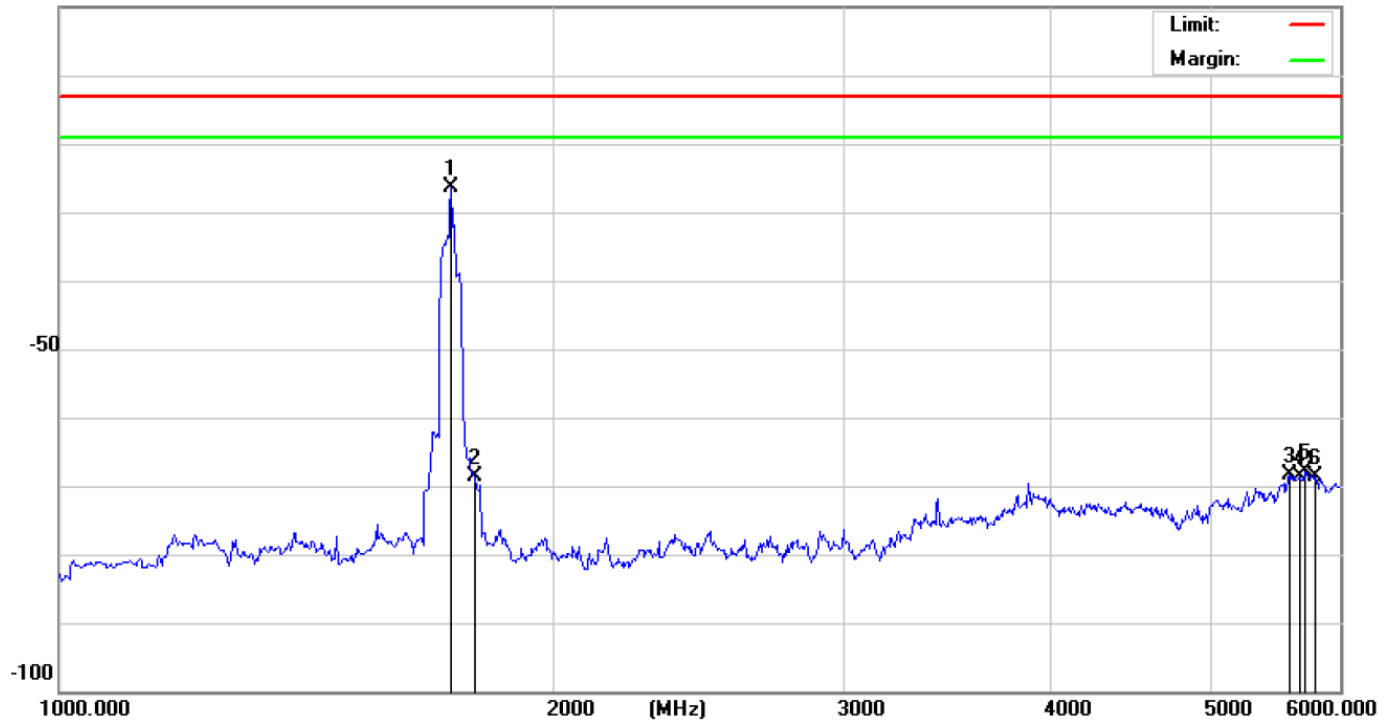

No.	Mk.	Freq. MHz	Reading Level dBm	Correct Factor dB	Measure- ment dBm	Limit dB	Over dB	Detector
1	*	1730.272	-17.53	-8.90	-26.43	-13.00	-13.43	peak
2		1790.190	-59.69	-8.92	-68.61	-13.00	-55.61	peak
3		5595.000	-64.51	-3.83	-68.34	-13.00	-55.34	peak
4		5675.000	-65.06	-3.62	-68.68	-13.00	-55.68	peak
5		5725.000	-64.49	-3.49	-67.98	-13.00	-54.98	peak
6		5805.000	-65.31	-3.27	-68.58	-13.00	-55.58	peak

LTE Band 4

Channel Bandwidth: 10 MHz/QPSK

1732.5MHz

Horizontal

0.0 dBm

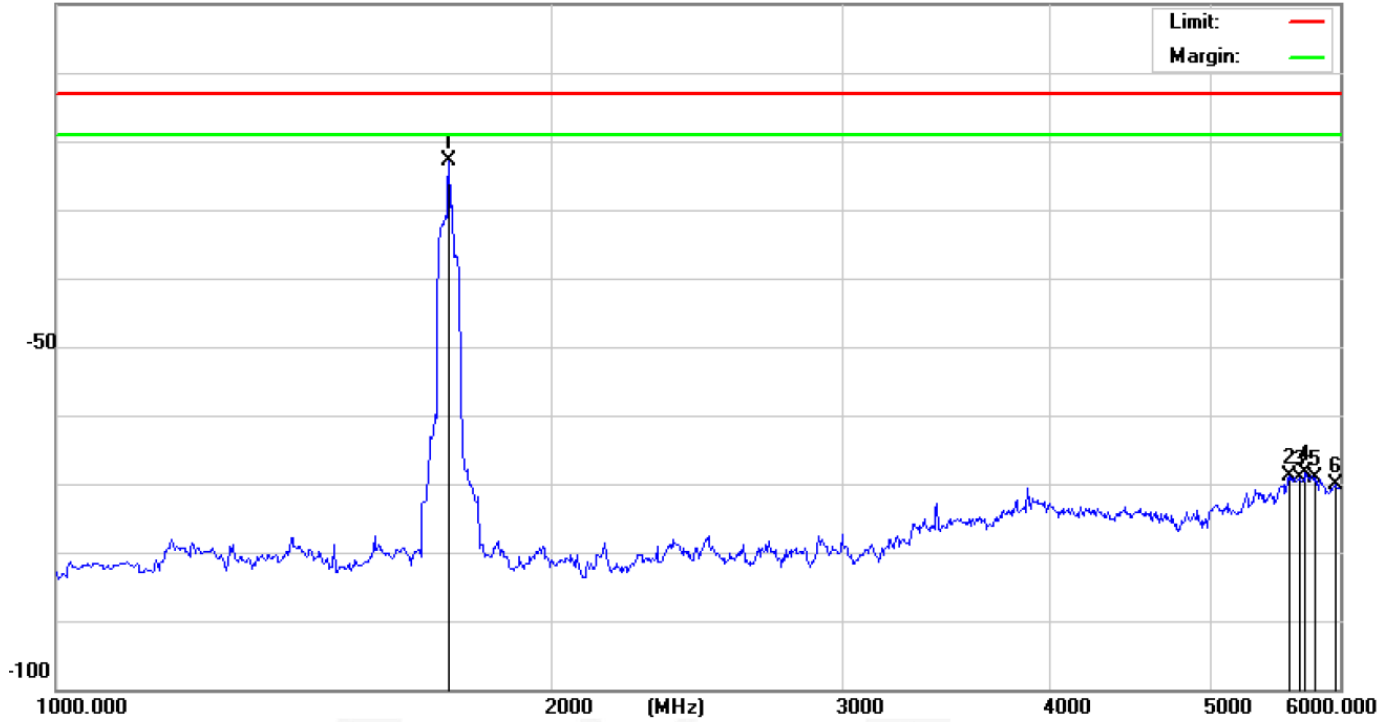

No.	Mk.	Freq. MHz	Reading Level dBm	Correct Factor dB	Measure- ment dBm	Limit dB	Over dB	Detector
1	*	1730.272	-14.03	-8.90	-22.93	-13.00	-9.93	peak
2		5595.000	-65.01	-3.83	-68.84	-13.00	-55.84	peak
3		5675.000	-65.56	-3.62	-69.18	-13.00	-56.18	peak
4		5725.000	-64.99	-3.49	-68.48	-13.00	-55.48	peak
5		5805.000	-65.81	-3.27	-69.08	-13.00	-56.08	peak
6		5965.000	-67.29	-2.84	-70.13	-13.00	-57.13	peak

LTE Band 4

Channel Bandwidth: 10 MHz/QPSK

1732.5MHz

Vertical

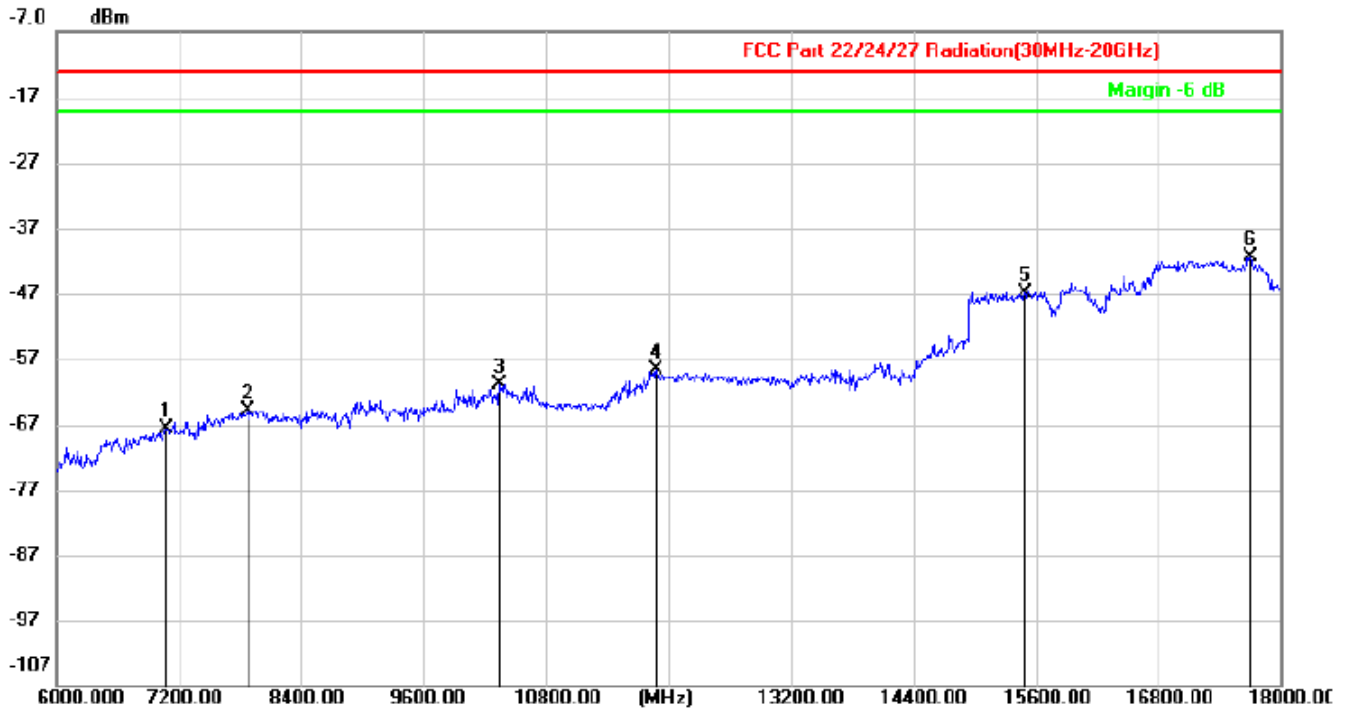

No.	Mk.	Freq. MHz	Reading Level dBm	Correct Factor dB	Measure- ment dBm	Limit dBm	Over dB	Detector
1		7080.000	-74.67	7.15	-67.52	-13.00	-54.52	peak
2		7872.000	-73.96	9.07	-64.89	-13.00	-51.89	peak
3		10344.00	-73.81	13.01	-60.80	-13.00	-47.80	peak
4		11880.00	-71.42	12.86	-58.56	-13.00	-45.56	peak
5		15492.00	-59.49	12.67	-46.82	-13.00	-33.82	peak
6	*	17700.00	-59.20	17.73	-41.47	-13.00	-28.47	peak

LTE Band 4

Channel Bandwidth: 10 MHz/QPSK

1732.5MHz

Horizontal

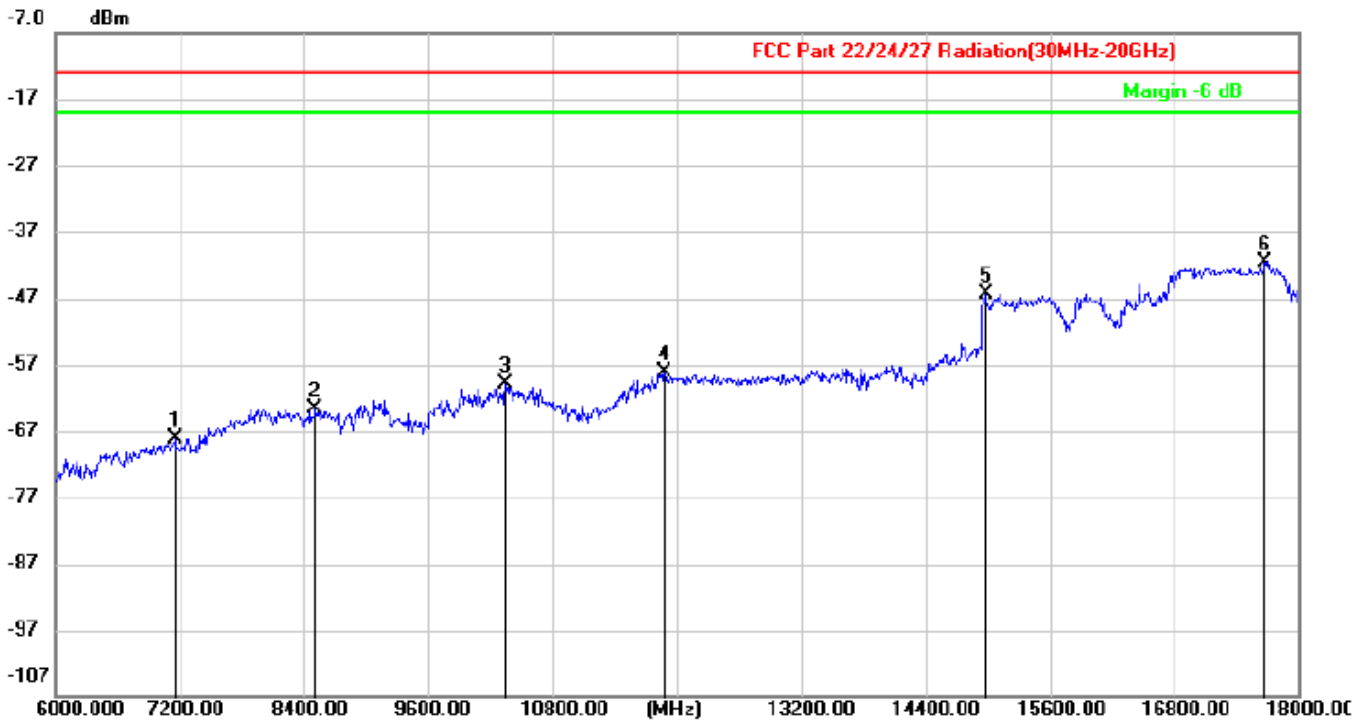

No.	Mk.	Freq. MHz	Reading Level dBm	Correct Factor dB	Measure- ment dBm	Limit dBm	Over dB	Detector
1		7152.000	-75.57	7.35	-68.22	-13.00	-55.22	peak
2		8508.000	-74.24	10.62	-63.62	-13.00	-50.62	peak
3		10344.00	-72.81	13.01	-59.80	-13.00	-46.80	peak
4		11880.00	-70.92	12.86	-58.06	-13.00	-45.06	peak
5		14976.00	-60.28	13.94	-46.34	-13.00	-33.34	peak
6	*	17676.00	-59.60	18.04	-41.56	-13.00	-28.56	peak

LTE Band 4

Channel Bandwidth: 10 MHz/QPSK

1750MHz

Vertical

0.0 dBm

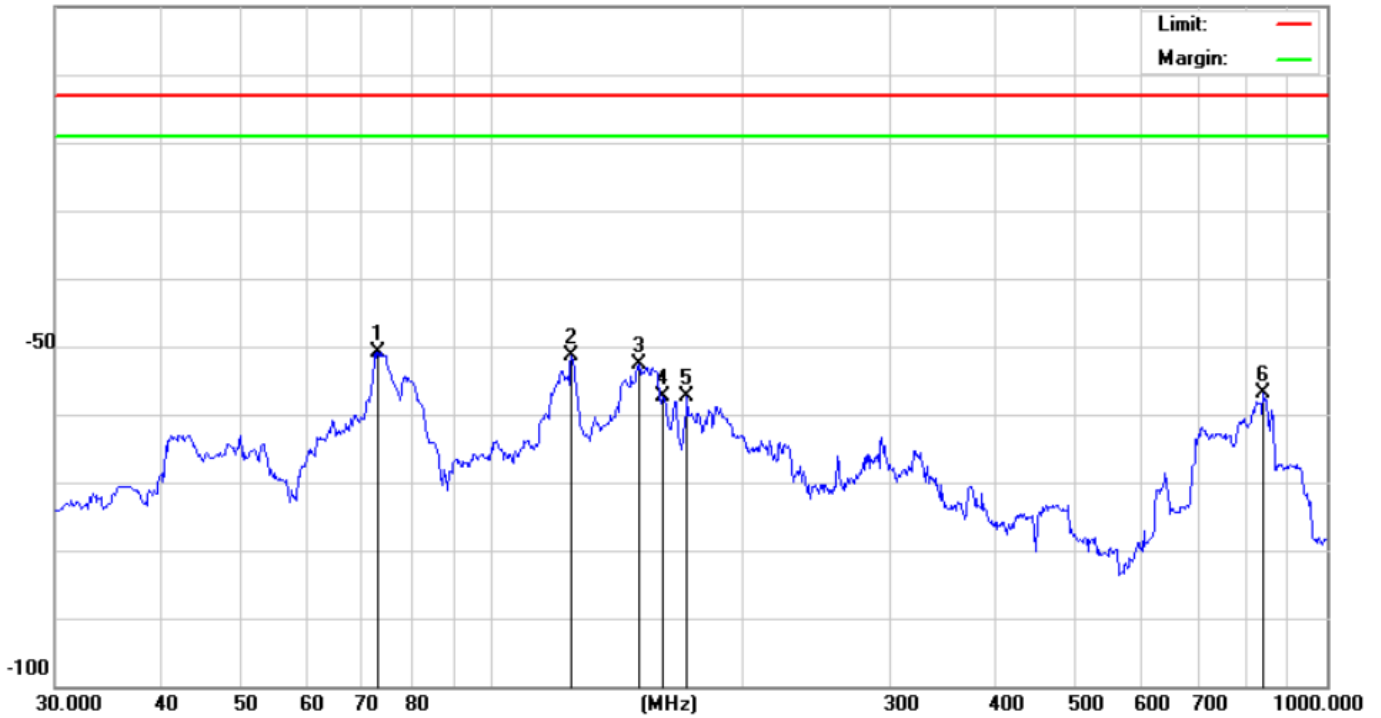

No.	Mk.	Freq. MHz	Reading Level dBm	Correct Factor dB	Measure- ment dBm	Limit dB	Over dB	Detector
1	*	73.1025	-33.16	-17.65	-50.81	-13.00	-37.81	QP
2		124.5690	-35.18	-16.11	-51.29	-13.00	-38.29	QP
3		150.2800	-37.07	-15.60	-52.67	-13.00	-39.67	QP
4		160.3454	-41.41	-15.89	-57.30	-13.00	-44.30	QP
5		171.6200	-41.66	-15.61	-57.27	-13.00	-44.27	QP
6		839.9500	-57.20	0.25	-56.95	-13.00	-43.95	QP

LTE Band 4

Channel Bandwidth: 10 MHz/QPSK

1750MHz

Horizontal

0.0 dBm



No.	Mk.	Freq. MHz	Reading Level dBm	Correct Factor dB	Measure- ment dBm	Limit dB	Over dB	Detector
1	*	73.1025	-32.16	-17.65	-49.81	-13.00	-36.81	QP
2		124.5690	-35.18	-16.11	-51.29	-13.00	-38.29	QP
3		150.2800	-36.07	-15.60	-51.67	-13.00	-38.67	QP
4		160.3454	-40.41	-15.89	-56.30	-13.00	-43.30	QP
5		171.6200	-40.66	-15.61	-56.27	-13.00	-43.27	QP
6		839.9500	-56.20	0.25	-55.95	-13.00	-42.95	QP

LTE Band 4

Channel Bandwidth: 10 MHz/QPSK

1750MHz

Vertical

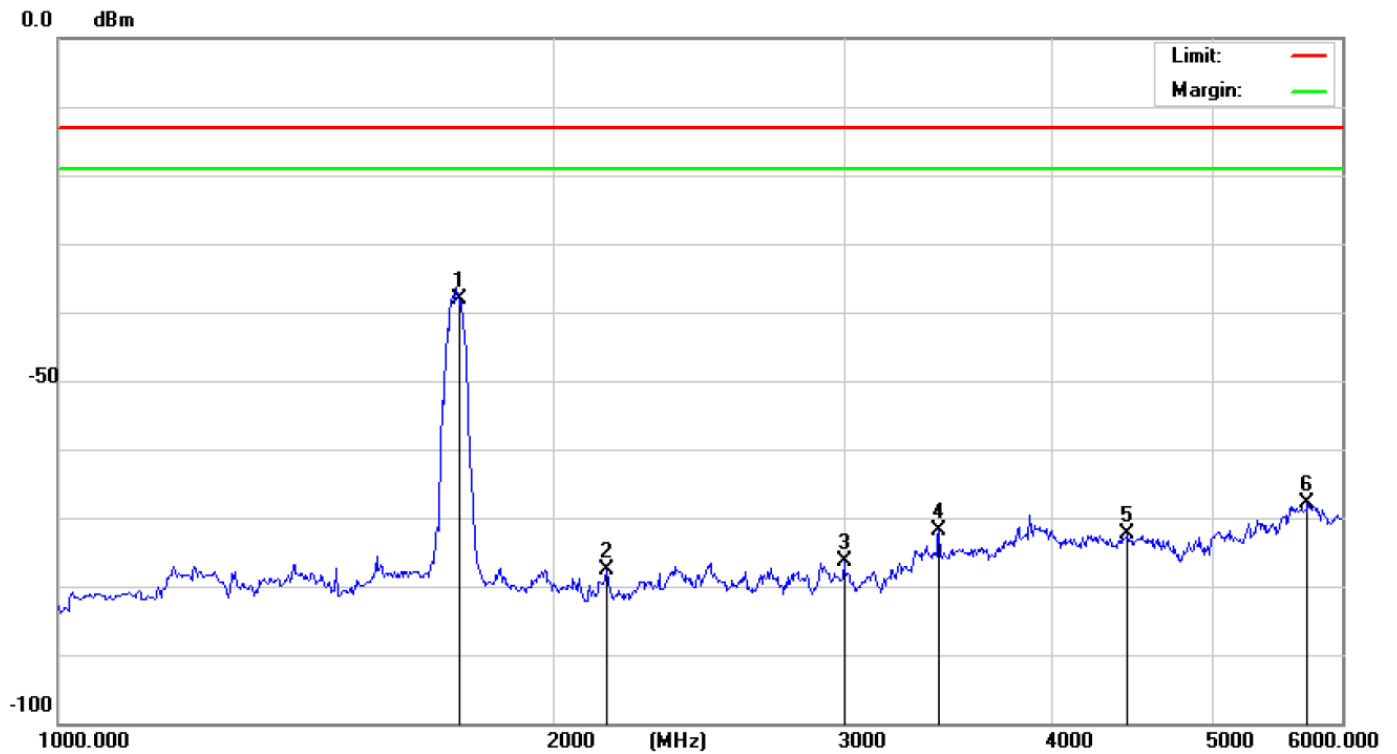

No.	Mk.	Freq. MHz	Reading Level dBm	Correct Factor dB	Measure- ment dBm	Limit dB	Over dB	Detector
1	*	1750.000	-29.29	-8.91	-38.20	-13.00	-25.20	peak
2		2150.000	-68.57	-9.17	-77.74	-13.00	-64.74	peak
3		2995.000	-67.15	-9.13	-76.28	-13.00	-63.28	peak
4		3420.000	-64.80	-7.03	-71.83	-13.00	-58.83	peak
5		4450.000	-65.46	-6.96	-72.42	-13.00	-59.42	peak
6		5725.000	-64.49	-3.49	-67.98	-13.00	-54.98	peak

LTE Band 4

Channel Bandwidth: 10 MHz/QPSK

1750MHz

Horizontal

0.0 dBm

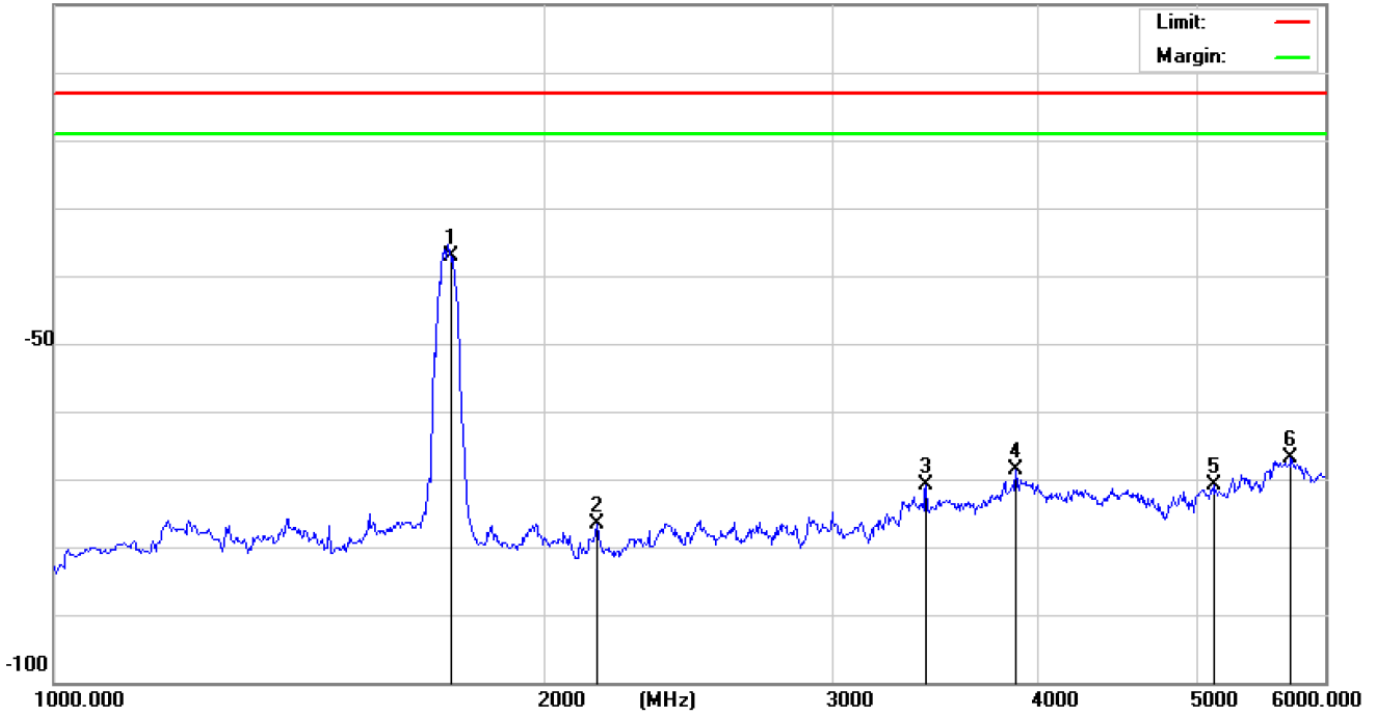

No.	Mk.	Freq. MHz	Reading Level dBm	Correct Factor dB	Measure- ment dBm	Limit dB	Over dB	Detector
1	*	1750.000	-28.29	-8.91	-37.20	-13.00	-24.20	peak
2		2150.000	-67.57	-9.17	-76.74	-13.00	-63.74	peak
3		3420.000	-63.80	-7.03	-70.83	-13.00	-57.83	peak
4		3880.000	-62.99	-5.57	-68.56	-13.00	-55.56	peak
5		5130.000	-63.05	-7.83	-70.88	-13.00	-57.88	peak
6		5725.000	-63.49	-3.49	-66.98	-13.00	-53.98	peak

LTE Band 4

Channel Bandwidth: 10 MHz/QPSK

1750MHz

Vertical



No.	Mk.	Freq. MHz	Reading Level dBm	Correct Factor dB	Measure- ment dBm	Limit dBm	Over dB	Detector
1		7056.000	-76.86	7.08	-69.78	-13.00	-56.78	peak
2		8508.000	-75.74	10.62	-65.12	-13.00	-52.12	peak
3		9924.000	-73.87	11.29	-62.58	-13.00	-49.58	peak
4		12036.00	-70.08	12.57	-57.51	-13.00	-44.51	peak
5		14988.00	-58.15	13.92	-44.23	-13.00	-31.23	peak
6	*	17688.00	-58.84	17.89	-40.95	-13.00	-27.95	peak

LTE Band 4

Channel Bandwidth: 10 MHz/QPSK

1750MHz

Horizontal

-7.0 dBm

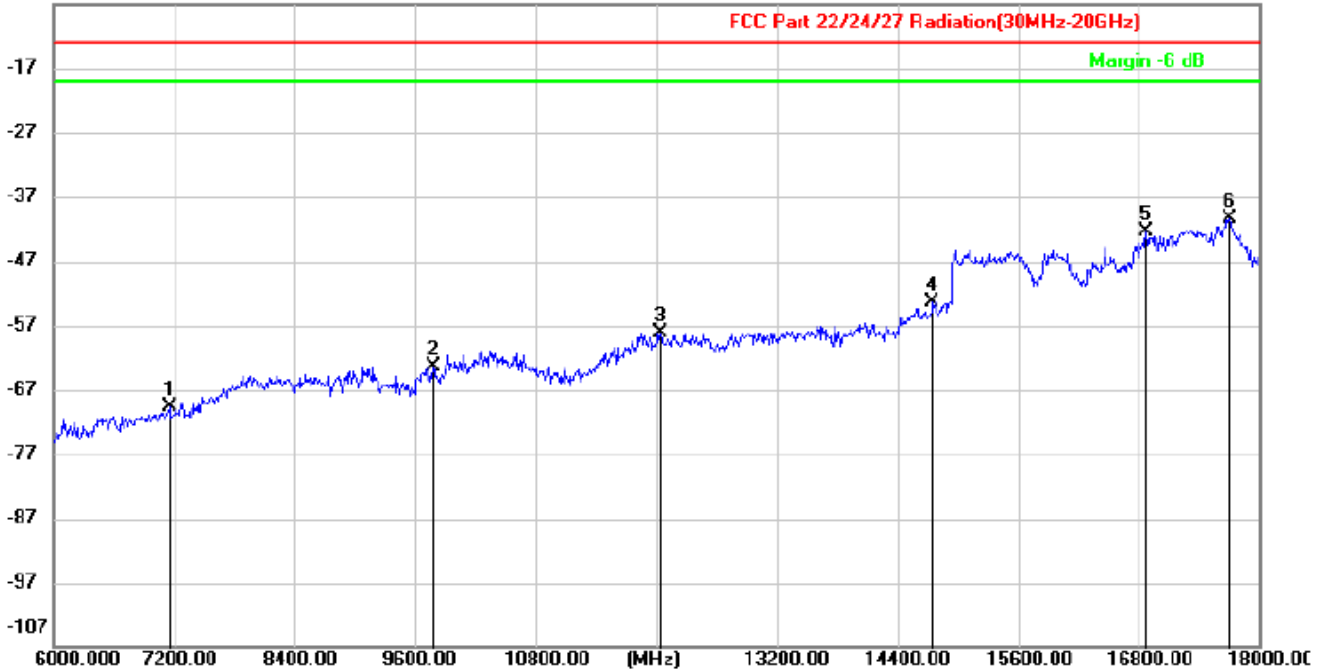

No.	Mk.	Freq. MHz	Reading Level dBm	Correct Factor dB	Measure- ment dBm	Limit dBm	Over dB	Detector
1		7152.000	-77.07	7.35	-69.72	-13.00	-56.72	peak
2		9780.000	-73.47	10.02	-63.45	-13.00	-50.45	peak
3		12036.00	-70.58	12.57	-58.01	-13.00	-45.01	peak
4		14748.00	-67.95	14.46	-53.49	-13.00	-40.49	peak
5		16872.00	-61.64	19.23	-42.41	-13.00	-29.41	peak
6	*	17700.00	-58.20	17.73	-40.47	-13.00	-27.47	peak

LTE Band 12

Channel Bandwidth: 10 MHz/QPSK

704MHz

Vertical



No.	Mk.	Freq. MHz	Reading Level dBm	Correct Factor dB	Measure- ment dBm	Limit dB	Over dB	Detector
1		35.8200	-50.92	-15.96	-66.88	-13.00	-53.88	peak
2		73.6500	-44.40	-17.65	-62.05	-13.00	-49.05	peak
3		227.8798	-47.57	-13.73	-61.30	-13.00	-48.30	peak
4		470.3799	-53.37	-6.76	-60.13	-13.00	-47.13	peak
5	*	704.0000	-25.13	-2.25	-27.38	-13.00	-14.38	peak
6		929.1900	-52.67	2.53	-50.14	-13.00	-37.14	peak

LTE Band 12

Channel Bandwidth: 10 MHz/QPSK

704MHz

Horizontal



No.	Mk.	Freq. MHz	Reading Level dBm	Correct Factor dB	Measure- ment dBm	Limit dB	Over dB	Detector
1		35.8200	-50.42	-15.96	-66.38	-13.00	-53.38	peak
2		73.6500	-43.40	-17.65	-61.05	-13.00	-48.05	peak
3		227.8798	-46.57	-13.73	-60.30	-13.00	-47.30	peak
4		470.3799	-51.37	-6.76	-58.13	-13.00	-45.13	peak
5	*	704.0000	-27.13	-2.25	-29.38	-13.00	-16.38	peak
6		929.1900	-51.67	2.53	-49.14	-13.00	-36.14	peak

LTE Band 12

Channel Bandwidth: 10 MHz/QPSK

704MHz

Vertical

-7.0 dBm

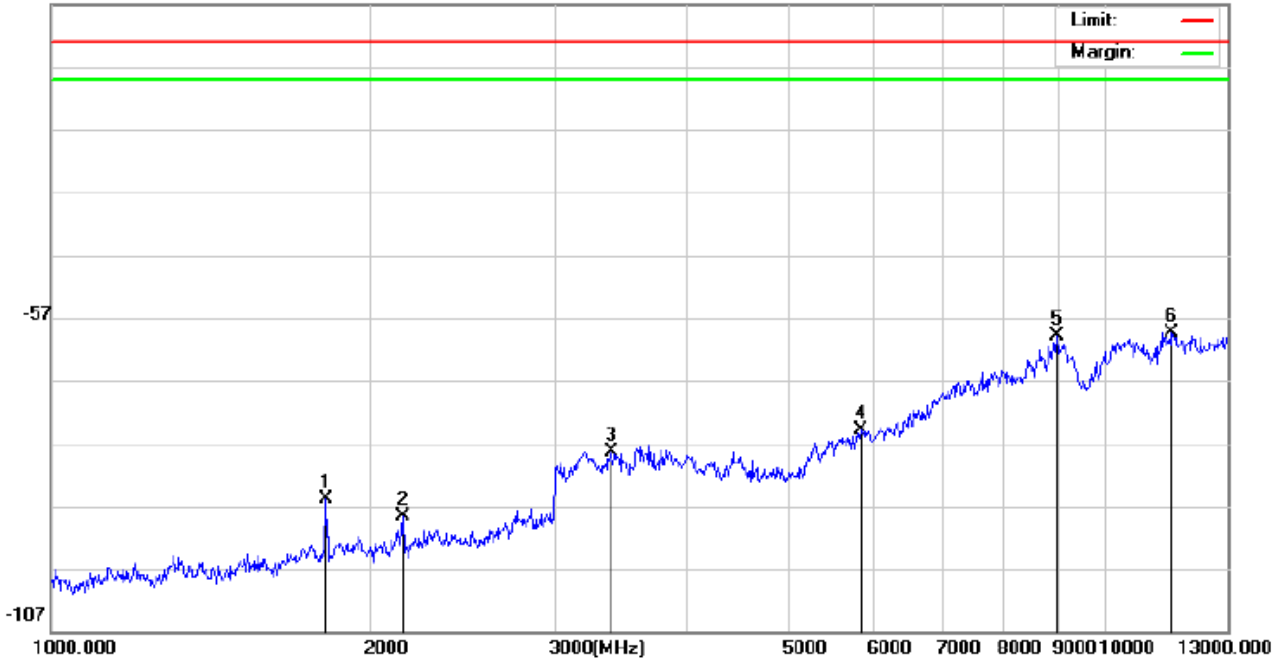

No.	Mk.	Freq. MHz	Reading Level dBm	Correct Factor dB	Measure- ment dBm	Limit dB	Over dB	Detector
1		1822.480	-75.38	-10.52	-85.90	-13.00	-72.90	peak
2		2153.124	-79.74	-8.84	-88.58	-13.00	-75.58	peak
3		3390.291	-73.53	-4.80	-78.33	-13.00	-65.33	peak
4		5839.733	-75.59	0.69	-74.90	-13.00	-61.90	peak
5		8962.343	-74.17	14.21	-59.96	-13.00	-46.96	peak
6	*	11523.59	-73.02	13.67	-59.35	-13.00	-46.35	peak

LTE Band 12

Channel Bandwidth: 10 MHz/QPSK

704MHz

Horizontal

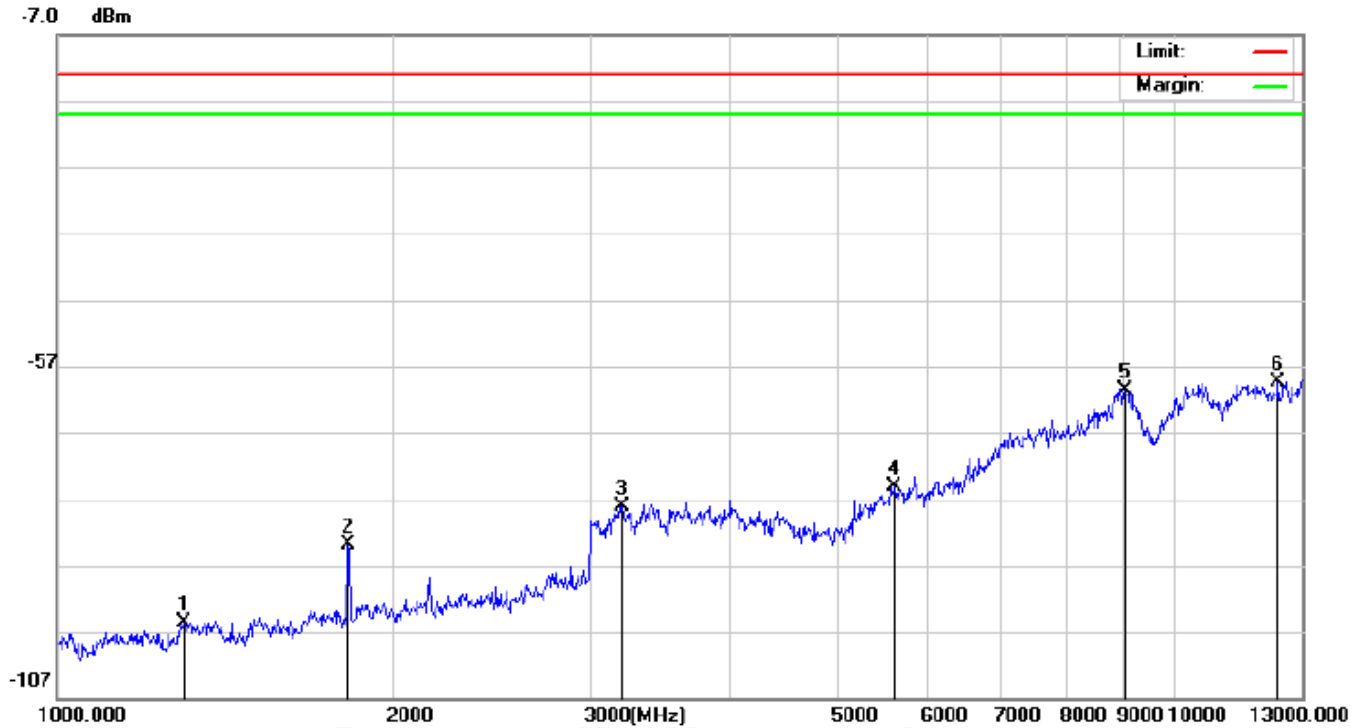

No.	Mk.	Freq. MHz	Reading Level dBm	Correct Factor dB	Measure- ment dBm	Limit dB	Over dB	Detector
1		1299.039	-82.12	-13.44	-95.56	-13.00	-82.56	peak
2		1822.480	-73.29	-10.52	-83.81	-13.00	-70.81	peak
3		3204.279	-72.73	-5.36	-78.09	-13.00	-65.09	peak
4		5619.321	-75.38	0.19	-75.19	-13.00	-62.19	peak
5		9031.573	-74.60	14.09	-60.51	-13.00	-47.51	peak
6	*	12381.64	-71.64	12.34	-59.30	-13.00	-46.30	peak

LTE Band 12

Channel Bandwidth: 10 MHz/QPSK

707.5MHz

Vertical

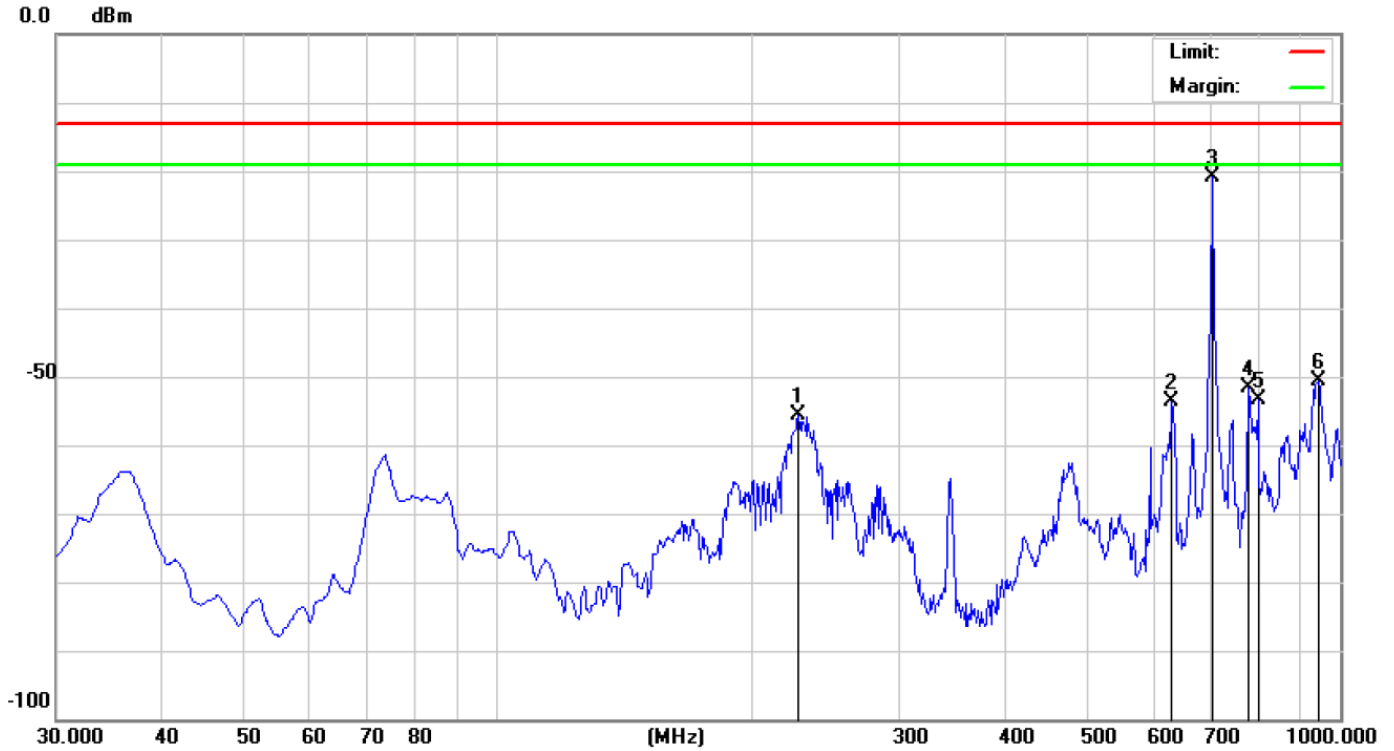

No.	Mk.	Freq. MHz	Reading Level dBm	Correct Factor dB	Measure- ment dBm	Limit dB	Over dB	Detector
1		227.8797	-41.82	-13.73	-55.55	-13.00	-42.55	peak
2		632.3700	-50.41	-3.32	-53.73	-13.00	-40.73	peak
3	*	707.0596	-18.54	-2.22	-20.76	-13.00	-7.76	peak
4		780.7798	-50.05	-1.48	-51.53	-13.00	-38.53	peak
5		801.1499	-52.09	-1.25	-53.34	-13.00	-40.34	peak
6		943.7400	-53.14	2.52	-50.62	-13.00	-37.62	peak

LTE Band 12

Channel Bandwidth: 10 MHz/QPSK

707.5MHz

Horizontal

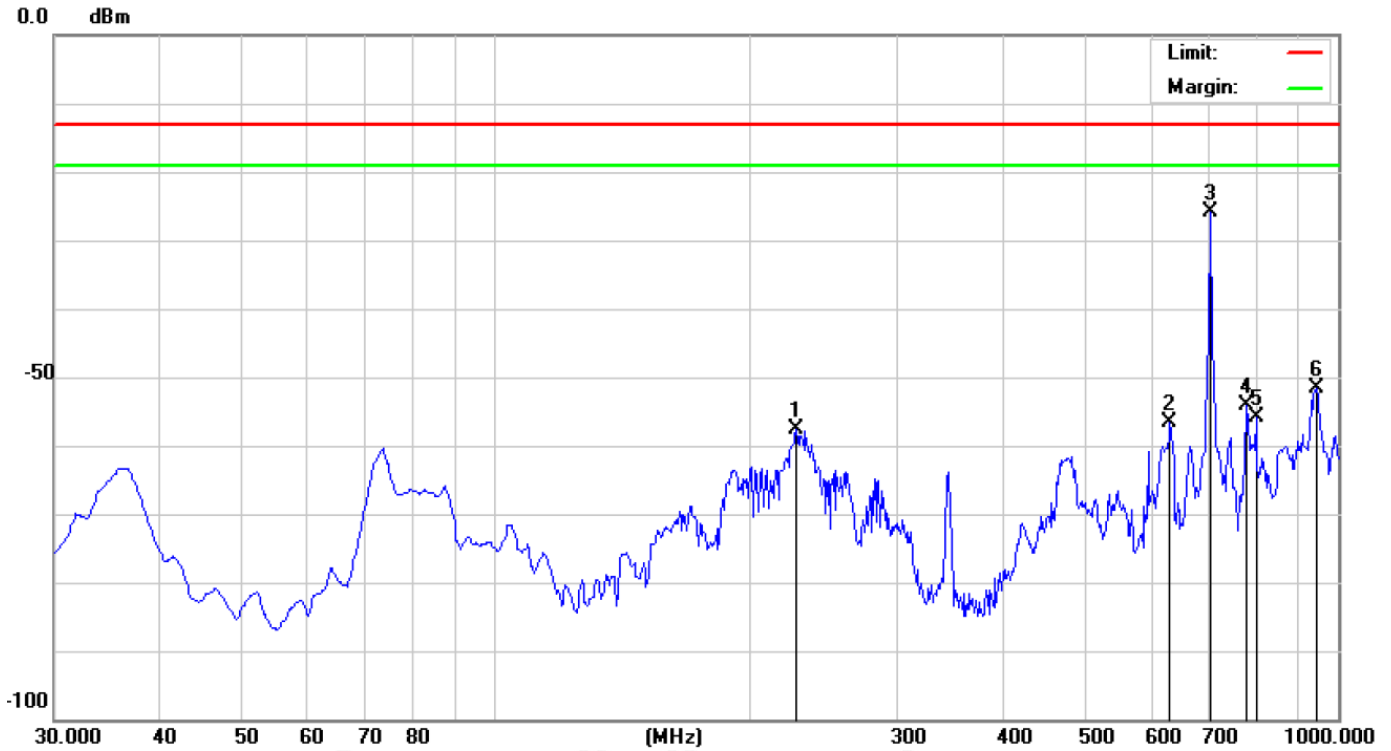

No.	Mk.	Freq. MHz	Reading Level dBm	Correct Factor dB	Measure- ment dBm	Limit dB	Over dB	Detector
1		227.8797	-43.82	-13.73	-57.55	-13.00	-44.55	peak
2		632.3700	-53.41	-3.32	-56.73	-13.00	-43.73	peak
3	*	707.0596	-23.54	-2.22	-25.76	-13.00	-12.76	peak
4		780.7798	-52.55	-1.48	-54.03	-13.00	-41.03	peak
5		801.1499	-54.59	-1.25	-55.84	-13.00	-42.84	peak
6		943.7400	-54.14	2.52	-51.62	-13.00	-38.62	peak

LTE Band 12

Channel Bandwidth: 10 MHz/QPSK

707.5MHz

Vertical

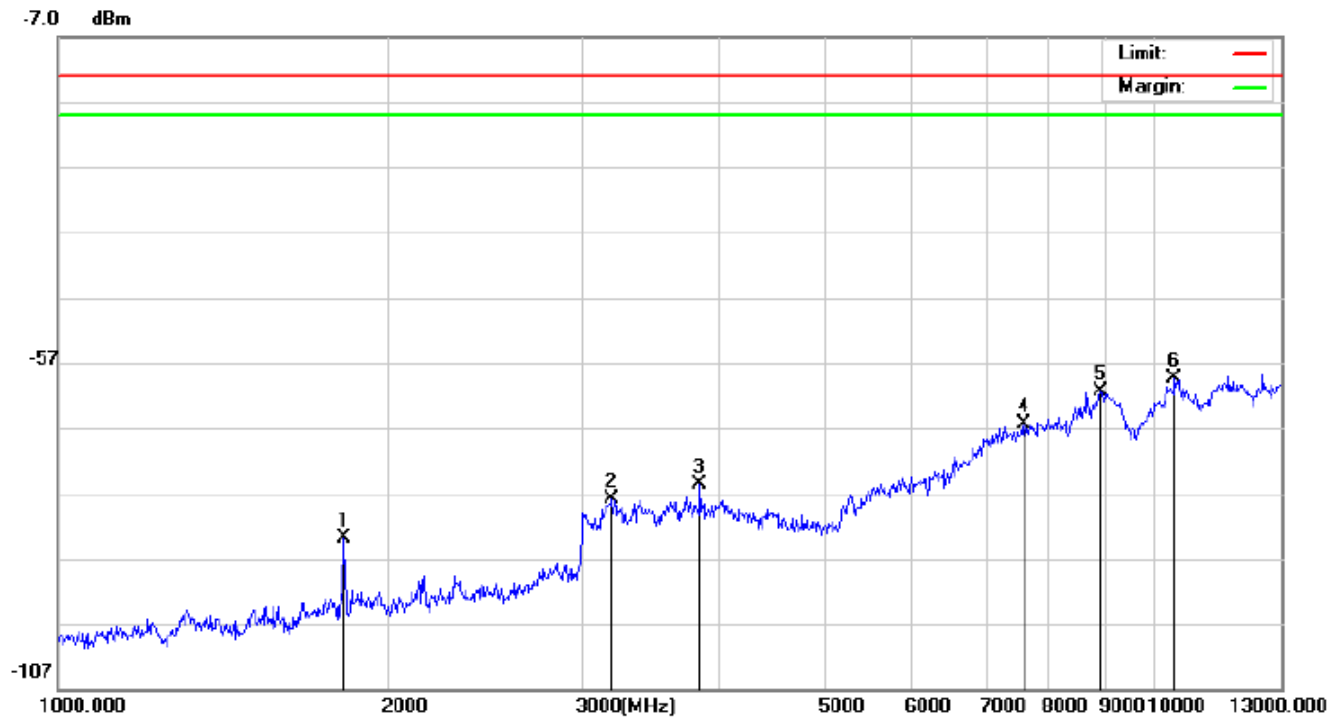

No.	Mk.	Freq. MHz	Reading Level dBm	Correct Factor dB	Measure- ment dBm	Limit dB	Over dB	Detector
1		1822.480	-73.44	-10.52	-83.96	-13.00	-70.96	peak
2		3196.070	-72.46	-5.38	-77.84	-13.00	-64.84	peak
3		3844.326	-71.93	-3.79	-75.72	-13.00	-62.72	peak
4		7586.042	-74.84	8.49	-66.35	-13.00	-53.35	peak
5		8893.644	-74.97	13.68	-61.29	-13.00	-48.29	peak
6	*	10399.92	-72.45	13.17	-59.28	-13.00	-46.28	peak

LTE Band 12

Channel Bandwidth: 10 MHz/QPSK

707.5MHz

Horizontal

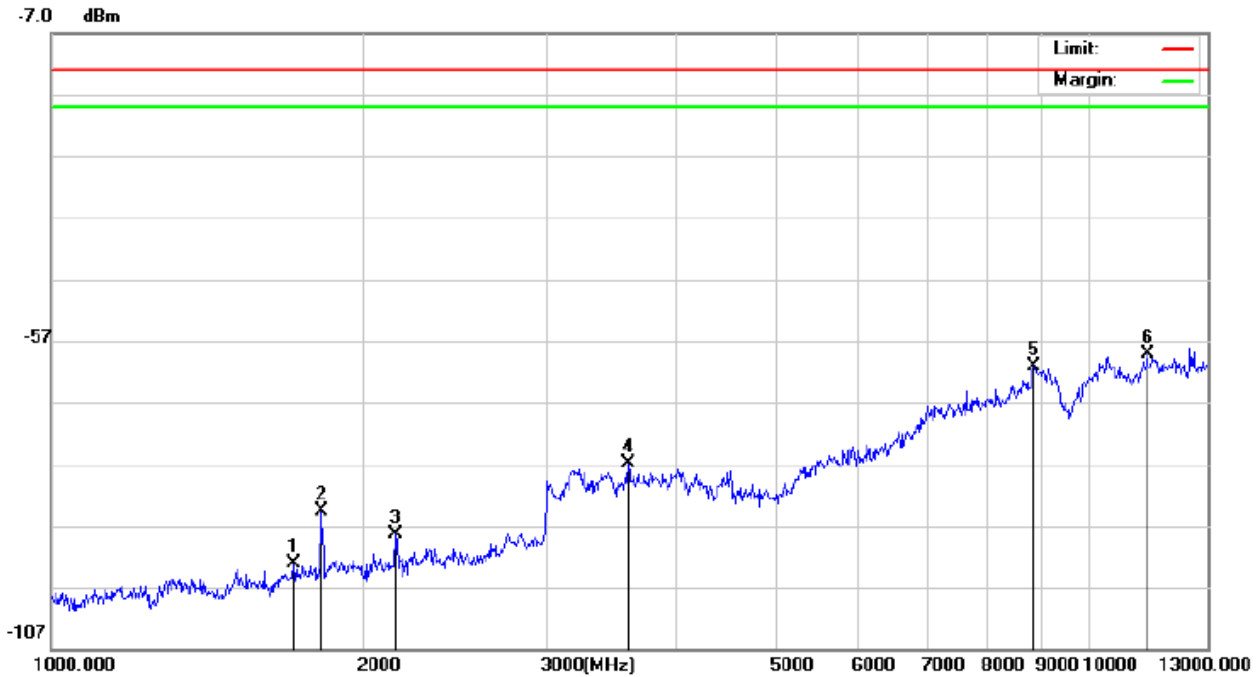

No.	Mk.	Freq. MHz	Reading Level dBm	Correct Factor dB	Measure- ment dBm	Limit dB	Over dB	Detector
1		1713.674	-81.88	-11.15	-93.03	-13.00	-80.03	peak
2		1822.480	-74.12	-10.52	-84.64	-13.00	-71.64	peak
3		2147.609	-79.50	-8.86	-88.36	-13.00	-75.36	peak
4		3596.315	-72.55	-4.28	-76.83	-13.00	-63.83	peak
5		8848.137	-74.38	13.32	-61.06	-13.00	-48.06	peak
6	*	11376.75	-72.32	13.20	-59.12	-13.00	-46.12	peak

LTE Band 12

Channel Bandwidth: 10 MHz/QPSK

711MHz

Vertical



No.	Mk.	Freq. MHz	Reading Level dBm	Correct Factor dB	Measure- ment dBm	Limit dB	Over dB	Detector
1		456.8000	-51.46	-7.11	-58.57	-13.00	-45.57	peak
2	*	710.9400	-21.80	-2.18	-23.98	-13.00	-10.98	peak
3		738.1000	-54.43	-1.91	-56.34	-13.00	-43.34	peak
4		789.5099	-55.65	-1.40	-57.05	-13.00	-44.05	peak
5		875.8400	-60.08	1.65	-58.43	-13.00	-45.43	peak
6		945.6798	-48.99	2.51	-46.48	-13.00	-33.48	peak

LTE Band 12

Channel Bandwidth: 10 MHz/QPSK

711MHz

Horizontal

0.0 dBm



No.	Mk.	Freq. MHz	Reading Level dBm	Correct Factor dB	Measure- ment dBm	Limit dB	Over dB	Detector
1		641.1000	-53.93	-3.19	-57.12	-13.00	-44.12	peak
2	*	710.9400	-23.80	-2.18	-25.98	-13.00	-12.98	peak
3		738.1000	-52.43	-1.91	-54.34	-13.00	-41.34	peak
4		789.5099	-53.65	-1.40	-55.05	-13.00	-42.05	peak
5		875.8400	-59.08	1.65	-57.43	-13.00	-44.43	peak
6		945.6798	-49.99	2.51	-47.48	-13.00	-34.48	peak

LTE Band 12

Channel Bandwidth: 10 MHz/QPSK

711MHz

Vertical

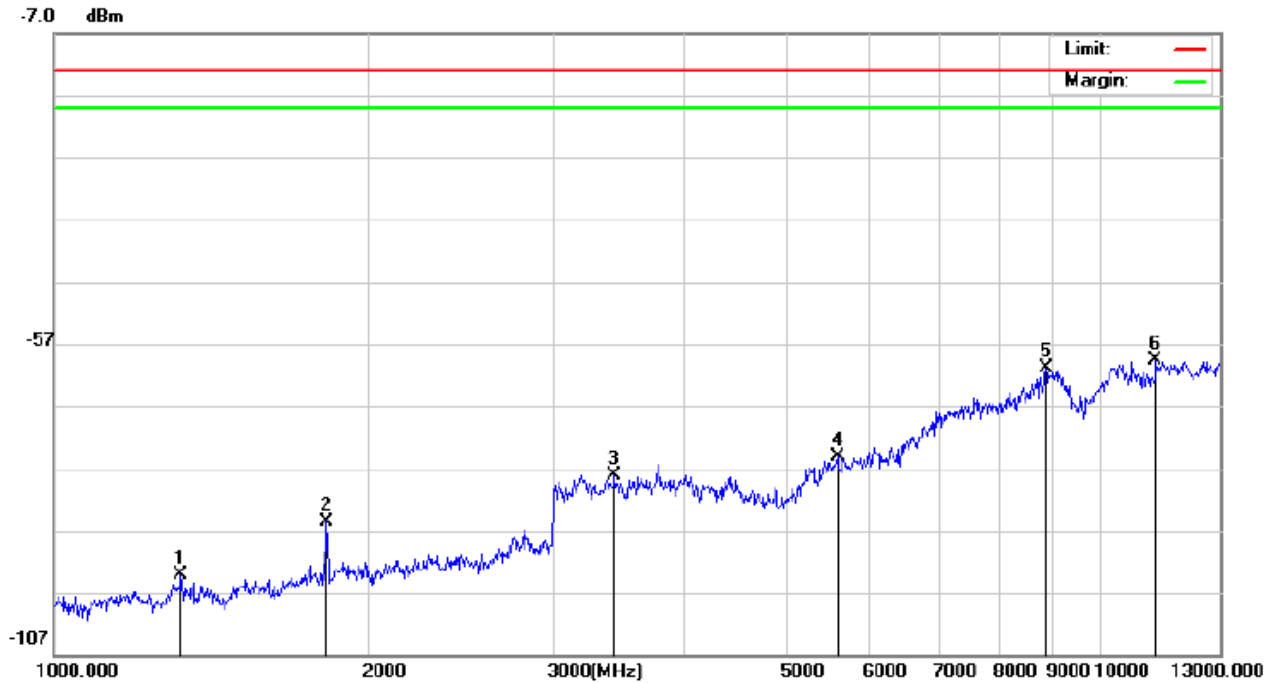

No.	Mk.	Freq. MHz	Reading Level dBm	Correct Factor dB	Measure- ment dBm	Limit dB	Over dB	Detector
1		1322.574	-80.83	-13.32	-94.15	-13.00	-81.15	peak
2		1822.480	-75.18	-10.52	-85.70	-13.00	-72.70	peak
3		3434.051	-73.57	-4.67	-78.24	-13.00	-65.24	peak
4		5604.927	-75.30	0.17	-75.13	-13.00	-62.13	peak
5		8870.861	-74.35	13.49	-60.86	-13.00	-47.86	peak
6	*	11289.54	-72.47	12.84	-59.63	-13.00	-46.63	peak

LTE Band 12

Channel Bandwidth: 10 MHz/QPSK

711MHz

Horizontal

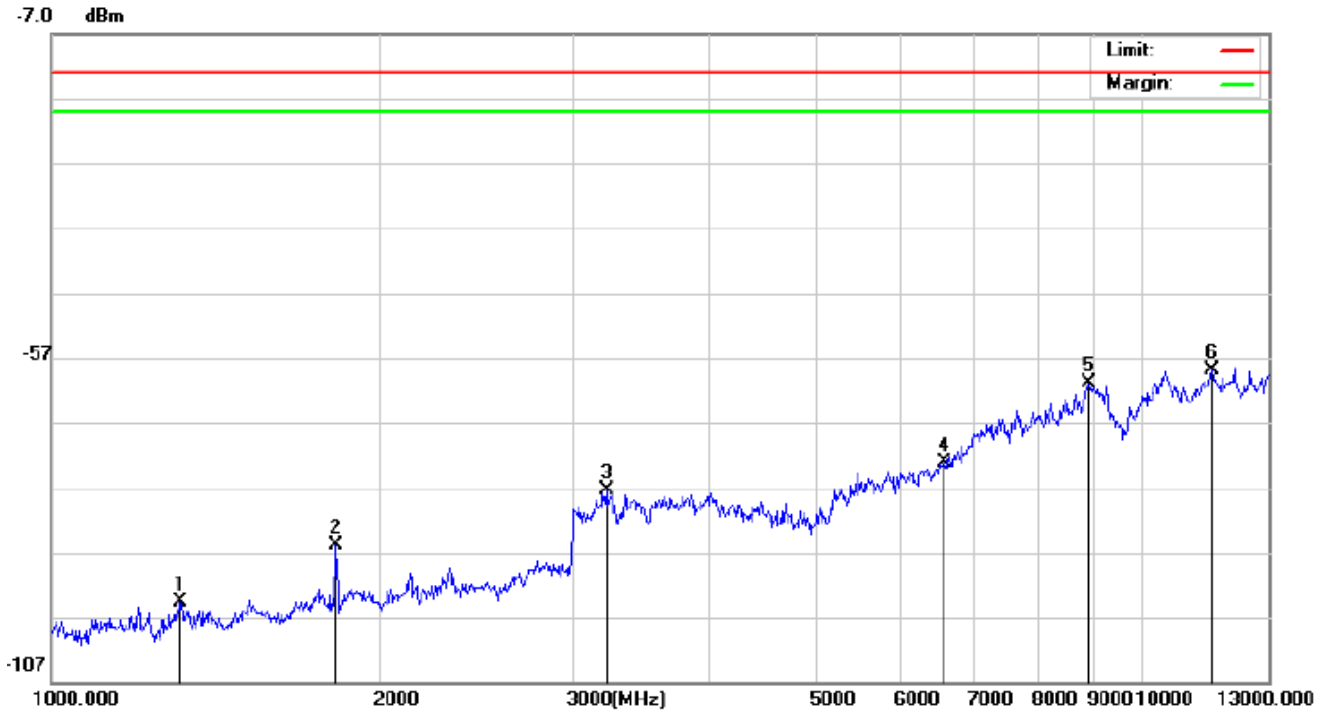

No.	Mk.	Freq. MHz	Reading Level dBm	Correct Factor dB	Measure- ment dBm	Limit dB	Over dB	Detector
1		1312.436	-81.27	-13.37	-94.64	-13.00	-81.64	peak
2		1822.480	-75.34	-10.52	-85.86	-13.00	-72.86	peak
3		3220.759	-72.00	-5.31	-77.31	-13.00	-64.31	peak
4		6571.045	-76.32	3.14	-73.18	-13.00	-60.18	peak
5		8893.644	-74.67	13.68	-60.99	-13.00	-47.99	peak
6	*	11553.19	-72.43	13.61	-58.82	-13.00	-45.82	peak

**** END OF REPORT****