



# KSIGN (Guangdong) Testing Co., Ltd.

West Side of 1/F., Building C, Zone A, Fuyuan New Factory, Jiujiu Industrial Park,  
Minzhu, Shatou, Shajing, Bao'an District, Shenzhen, Guangdong, People's Republic of China  
Tel.: + (86)755-29852678 Fax: + (86)755-29852397 E-mail: info@gdksign.cn Website: www.gdksign.com

## TEST REPORT

**Report No.** .....: **KS2102S00365E04**

**FCC ID**.....: **2AM8GCHAMELEONH**

**Applicant**.....: **GUANGZHOU LIE DUN ELECTRONICS TECHNOLOGY CO. LIMITED**

**Address**.....: No.4 plant of No.43 South International Trade Avenue, Hualong Town, Panyu District, Guangzhou, Guangdong, China

**Manufacturer**.....: **GUANGZHOU LIE DUN ELECTRONICS TECHNOLOGY CO. LIMITED**

**Address**.....: No.4 plant of No.43 South International Trade Avenue, Hualong Town, Panyu District, Guangzhou, Guangdong, China

**Product Name**.....: **Chameleon-H**

**Trade Mark**.....: CHAMELEON

**Model/Type reference**.....: E9XG-A05-M

**Listed Model(s)** .....: /

**Standard**.....: **FCC CFR Title 47 Part 15 Subpart C Section 15.247**

**Date of receipt of test sample**....: Mar. 02, 2021

**Date of testing**.....: Mar. 02, 2021~ Mar. 17, 2021

**Date of issue**.....: Mar. 17, 2021

**Test Result**.....: **Pass**

**Compiled by:**  
(Printed name+signature) Rory Huang

**Supervised by:**  
(Printed name+signature) Eder Zhan

**Approved by:**  
(Printed name+signature) Cary Luo



**Testing Laboratory Name**.....: **KSIGN(Guangdong) Testing Co., Ltd.**

**Address**.....: West Side of 1/F., Building C, Zone A, Fuyuan New Factory, Jiujiu Industrial Park, Minzhu, Shatou, Shajing, Bao'an District, Shenzhen, Guangdong, People's Republic of China

This test report may be duplicated completely for legal use with the approval of the applicant. It should not be reproduced except in full, without the written approval of our laboratory. The client should not use it to claim product endorsement by KSIGN. The test results in the report only apply to the tested sample. The test report shall be invalid without all the signatures of testing engineers, reviewer and approver. Any objections must be raised to KSIGN within 15 days since the date when the report is received. It will not be taken into consideration beyond this limit. The test report merely correspond to the test sample.



**TABLE OF CONTENTS****Page**

<b>1. TEST SUMMARY.....</b>	<b>3</b>
1.1. TEST STANDARDS.....	3
1.2. REPORT VERSION.....	3
1.3. TEST DESCRIPTION.....	4
1.4. TEST FACILITY.....	5
1.5. MEASUREMENT UNCERTAINTY.....	6
1.6. ENVIRONMENTAL CONDITIONS.....	6
<b>2. GENERAL INFORMATION.....</b>	<b>7</b>
2.1. GENERAL DESCRIPTION OF EUT.....	7
2.2. OPERATION STATE.....	8
2.3. MEASUREMENT INSTRUMENTS LIST.....	9
2.5. TEST SOFTWARE.....	9
<b>3. TEST ITEM AND RESULTS.....</b>	<b>10</b>
3.1. ANTENNA REQUIREMENT.....	10
3.2. PEAK OUTPUT POWER.....	11
3.3. POWER SPECTRAL DENSITY.....	14
3.4. 6dB BANDWIDTH.....	17
3.5. BAND EDGE AND SPURIOUS EMISSION (CONDUCTED).....	21
3.6. BAND EDGE EMISSIONS(RADIATED).....	24
3.7. SPURIOUS EMISSION (RADIATED).....	29
3.8. CONDUCTED EMISSION.....	40
<b>4. EUT TEST PHOTOS.....</b>	<b>43</b>
<b>5. PHOTOGRAPHS OF EUT CONSTRUCTIONAL.....</b>	<b>45</b>



## 1. TEST SUMMARY

### 1.1. Test Standards

The tests were performed according to following standards:

**FCC Rules Part 15.247:** Operation within the bands of 902-928MHz, 2400-2483.5MHz, and 5725-5850MHz.

**KDB 558074 D01** : The measurement guidance provided herein is applicable only to Digital Transmission System (DTS) devices operating in the 902-928 MHz. 2400-2483.5 MHz and/or 5725-5850 MHz bands under § 15.247 of the FCC rules (Title 47 of the Code of Federal Regulations)

**ANSI C63.10-2013:** American National Standard for Testing Unlicensed Wireless Devices.

### 1.2. Report version

Revised No.	Date of issue	Description
01	Mar. 17, 2021	Original



### 1.3. Test Description

FCC Part 15 Subpart C(15.247)			
Test Item	Standard Section	Result	Test Engineer
	FCC		
Antenna Requirement	15.203	Pass	Rory Huang
Conducted Emission	15.207	Pass	Rory Huang
Restricted Bands	15.205	Pass	Rory Huang
Peak Output Power	15.247(b)	Pass	Rory Huang
Band Edge Emissions	15.247(d)	Pass	Rory Huang
Power Spectral Density	15.247(e)	Pass	Rory Huang
Radiated Emission	15.205&15.209	Pass	Rory Huang
6dB Bandwidth	15.247(a)(2)	Pass	Rory Huang
Spurious RF Conducted Emission	15.247(d)	Pass	Rory Huang

Note:

The measurement uncertainty is not included in the test result.



## 1.4. Test Facility

### Address of the report laboratory

#### **KSIGN(Guangdong) Testing Co., Ltd.**

West Side of 1/F., Building C, Zone A, Fuyuan New Factory, Jiujiu Industrial Park, Minzhu, Shatou, Shajing, Bao'an District, Shenzhen, Guangdong, People's Republic of China

### Laboratory accreditation

The test facility is recognized, certified, or accredited by the following organizations:

#### **CNAS-Lab Code: L13261**

KSIGN(Guangdong) Testing Co., Ltd. has been assessed and proved to be in Compliance with CNAS-CL01 Accreditation Criteria for Testing and Calibration Laboratories (identical to ISO/IEC17025: 2017 General Requirements) for the Competence of Testing and Calibration Laboratories.

#### **A2LA-Lab Cert. No.: 5457.01**

KSIGN(Guangdong) Testing Co., Ltd. EMC Laboratory has been accredited by A2LA for technical competence in the field of electrical testing, and proved to be in compliance with ISO/IEC 17025:2017 General Requirements for the Competence of Testing and Calibration Laboratories and any additional program requirements in the identified field of testing.

#### **IC Registration No.: CN0096**

The 3m alternate test site of KSIGN(Guangdong) Testing Co., Ltd. EMC Laboratory has been registered by Certification and Engineer Bureau of Industry Canada for the performance of with Registration NO.: CN0096

#### **FCC-Registration No.: CN1272**

KSIGN(Guangdong) Testing Co., Ltd. EMC Laboratory has been registered and fully described in a report filed with the (FCC) Federal Communications Commission. The acceptance letter from the FCC is maintained in our files.



### 1.5. Measurement Uncertainty

The data and results referenced in this document are true and accurate. The reader is cautioned that there may be errors within the calibration limits of the equipment and facilities. The measurement uncertainty was calculated for all measurements listed in this test report acc. to TR-100028-01” Electromagnetic compatibility and Radio spectrum Matters (ERM);Uncertainties in the measurement of mobile radio equipment characteristics; Part 1” and TR-100028-02 “Electromagnetic compatibility and Radio spectrum Matters (ERM);Uncertainties in the measurement of mobile radio equipment characteristics; Part 2 “ and is documented in the KSIGN(Guangdong) Testing Co., Ltd. system acc. to DIN EN ISO/IEC 17025. Furthermore, component and process variability of devices similar to that tested may result in additional deviation. The manufacturer has the sole responsibility of continued compliance of the device. Below is the best measurement capability for KSIGN(Guangdong) Testing Co., Ltd.

Test Items	Measurement Uncertainty	Notes
Transmitter power conducted	0.42 dB	(1)
Transmitter power Radiated	2.14 dB	(1)
Conducted spurious emissions 9kHz~40GHz	1.60 dB	(1)
Radiated spurious emissions 9kHz~40GHz	2.20 dB	(1)
Conducted Emissions 9kHz~30MHz	3.20 dB	(1)
Radiated Emissions 30~1000MHz	4.70 dB	(1)
Radiated Emissions 1~18GHz	5.00 dB	(1)
Radiated Emissions 18~40GHz	5.54 dB	(1)
Occupied Bandwidth	2.80 dB	(1)

**Note (1):** This uncertainty represents an expanded uncertainty expressed at approximately the 95% confidence level using a coverage factor of k=1.96.

### 1.6. Environmental conditions

During the measurement the environmental conditions were within the listed ranges:

Temperature:	15~35°C
Relative Humidity:	30~60 %
Air Pressure:	950~1050mba



## 2. GENERAL INFORMATION

### 2.1. General Description of EUT

Test Sample Number 1:	1-1-1(Normal Sample),1-1-2(Engineering Sample )
Product Name:	Chameleon-H
Trade Mark:	CHAMELEON
Model/Type reference:	E9XG-A05-M
Listed Model(s):	/
Model Difference:	/
Power supply(Adapter):	AC/DC ADAPTER MODEL:AD018A120150UV INPUT:100-240V~ 50/60Hz 0.5A Max OUTPUT:DC 12V1.5A
Power supply(Battery):	DC 3.7V 10000mAh 37Wh
Hardware version:	V1.0
Software version:	V1.0.0
<b>Bluetooth V5.0</b>	
Modulation:	GFSK
Operation frequency:	2402MHz~2480MHz
Max Peak Output Power:	-5.57 dBm
Channel number:	40
Channel separation:	2MHz
Antenna type:	FPC Antenna
Antenna gain:	1.0 dBi



## 2.2. Operation state

Operation Frequency List: The EUT has been tested under typical operating condition. The Applicant provides communication tools software to control the EUT for staying in continuous transmitting and receiving mode for testing. BT BLE, 40 channels are provided to the EUT. Channels 00/19/39 were selected for testing.

Operation Frequency List:

Channel	Frequency (MHz)
<b>00</b>	<b>2402</b>
01	2404
⋮	⋮
<b>19</b>	<b>2440</b>
20	2442
21	2444
⋮	⋮
38	2478
<b>39</b>	<b>2480</b>

Note: The display in grey were the channel selected for testing.

Test mode

NO.	TEST MODE DESCRIPTION
1	Low channel TX (2402MHz)
2	Middle channel TX (2440MHz)
3	High channel TX (2480MHz)

Note:

1. Only the result of the worst case was recorded in the report, if no other cases..
2. The test software is the SecureCRTSecure\_V7.0.0.326 which can set the EUT into the individual test modes.



### 2.3. Measurement Instruments List

Tonscend JS0806-2 Test system					
Item	Test Equipment	Manufacturer	Model No.	Serial No.	Cal. Until
1	Spectrum Analyzer	R&S	FSV40-N	101798	04/07/2022
2	Vector Signal Generator	Agilent	N5182A	MY50142520	04/07/2022
3	Analog Signal Generator	HP	83752A	3344A00337	04/07/2022
4	Power Sensor	Agilent	E9304A	MY50390009	04/07/2022
5	Power Sensor	Agilent	E9300A	MY41498315	04/07/2022
6	Wideband Radio Communication Tester	R&S	CMW500	157282	04/07/2022
7	Climate Chamber	Angul	AGNH80L	1903042120	04/07/2022
8	Dual Output DC Power Supply	Agilent	E3646A	MY40009992	04/07/2022
9	RF Control Unit	Tonscend	JS0806-2	/	04/07/2022

Transmitter spurious emissions & Receiver spurious emissions					
Item	Test Equipment	Manufacturer	Model No.	Serial No.	Cal. Until
1	EMI Test Receiver	R&S	ESR	102525	04/07/2021
2	High Pass Filter	Chengdu E-Microwave	OHF-3-18-S	0E01901038	03/27/2021
3	High Pass Filter	Chengdu E-Microwave	OHF-6.5-18-S	0E01901039	03/27/2021
4	Spectrum Analyzer	HP	8593E	3831U02087	04/07/2021
5	Ultra-Broadband logarithmic period Antenna	Schwarzbeck	VULB 9163	01230	03/29/2023
6	Loop Antenna	Beijin ZHINAN	ZN30900C	18050	03/25/2021
7	Spectrum Analyzer	R&S	FSV40-N	101798	04/07/2021
8	Horn Antenna	Schwarzbeck	BBHA 9120 D	2023	03/29/2023
9	Pre-Amplifier	Schwarzbeck	BBV 9745	9745#129	04/07/2021
10	Pre-Amplifier	EMCI	EMC051835SE	980662	04/07/2021

Item	Test Equipment	Manufacturer	Model No.	Serial No.	Cal. Until
1	LISN	R&S	ENV432	1326.6105.02	03/28/2021
2	EMI Test Receiver	R&S	ESR	102524	04/06/2021
3	Manual RF Switch	JS TOYO	/	MSW-01/002	04/06/2021

Note:

1)The Cal. Interval was one year.

2)The cable loss has calculated in test result which connection between each test instruments.

### 2.5. Test Software

Software name	Model	Version
Conducted emission Measurement Software	EZ-EMC	EMC-Con 3A1.1
Radiated emission Measurement Software	EZ-EMC	FA-03A.2.RE
Bluetooth and WIFI Test System	JS1120-3	2.5.77.0418



### 3. TEST ITEM AND RESULTS

#### 3.1. Antenna requirement

##### Requirement

##### **FCC CFR Title 47 Part 15 Subpart C Section 15.203:**

An intentional radiator shall be designed to ensure that no antenna other than that furnished by the responsible party shall be used with the device. The use of a permanently attached antenna or of an antenna that uses a unique coupling to the intentional radiator, the manufacturer may design the unit so that a broken antenna can be replaced by the user, but the use of a standard antenna jack or electrical connector is prohibited.

##### **FCC CFR Title 47 Part 15 Subpart C Section 15.247(c) (1)(i):**

(i) Systems operating in the 2400~2483.5 MHz band that is used exclusively for fixed. Point-to-point operations may employ transmitting antennas with directional gain greater than 6dBi provided the maximum conducted output power of the intentional radiator is reduced by 1 dB for every 3 dB that the directional gain of the antenna exceeds 6dBi.

##### Test Result

The directional gain of the antenna less than 6dBi, please refer to the EUT internal photographs antenna photo.

Note: The antenna is permanently fixed to the EUT



### 3.2. Peak Output Power

**Limit**

Test Item	Limit	Frequency Range(MHz)
Peak Output Power	1 Watt or 30 dBm	2400~2483.5

**Test Configuration**

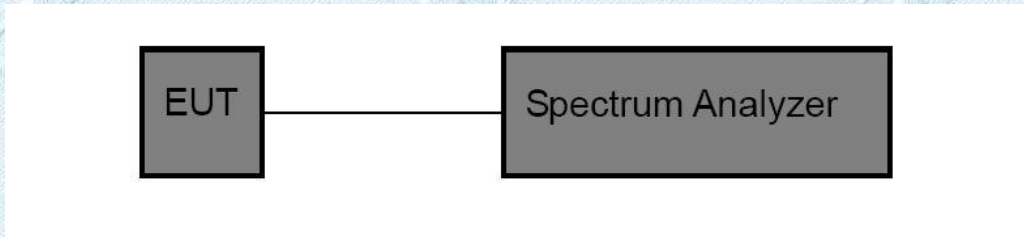

**Test Procedure**

1. Connect EUT RF Output port to the Spectrum Analyzer through an RF attenuator..
2. Spectrum Setting:  
 Peak Detector:  $RBW \geq DTS \text{ Bandwidth}$ ,  $VBW \geq 3 * RBW$ .  
 Sweep time=Auto.  
 Detector= Peak.  
 Trace mode= Maxhold.  
 Allow trace to fully stabilize. Then use the peak marker function to determine the maximum amplitude level.

**Test Mode**

Please refer to the clause 2.2.

**Test Result**

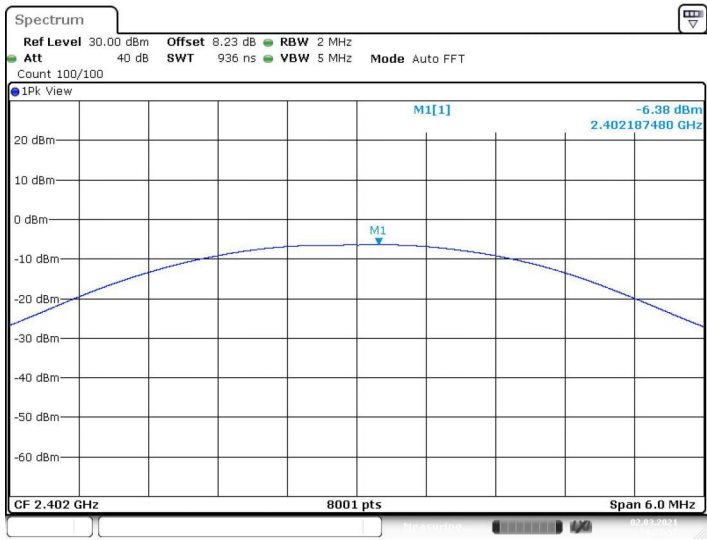

**GFSK**

<b>Test Mode:</b>	BLE Mode		
<b>Channel frequency (MHz)</b>	<b>Test Result (dBm)</b>	<b>Limit (dBm)</b>	
2402	-6.38	<b>30</b>	
2440	-5.57		
2480	-8.77		
<b>BLE Mode</b>			
<b>2402 MHz</b>			
			



BLE Mode

2440 MHz

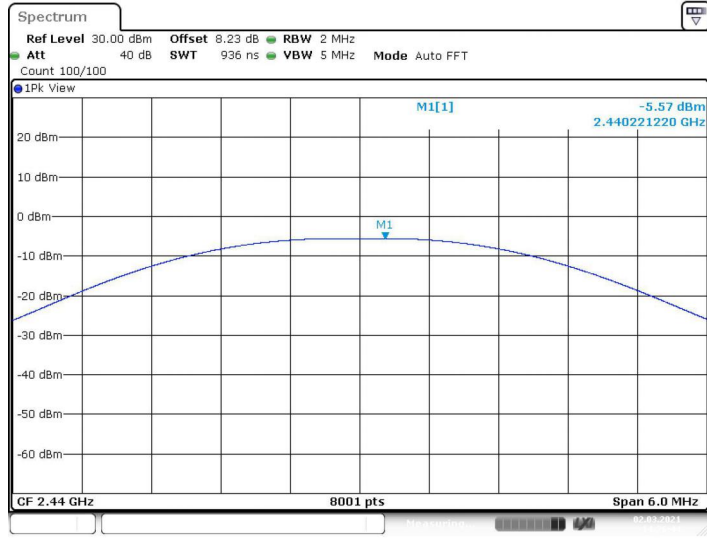

Date: 2.MAR.2021 14:26:44

BLE Mode

2480 MHz

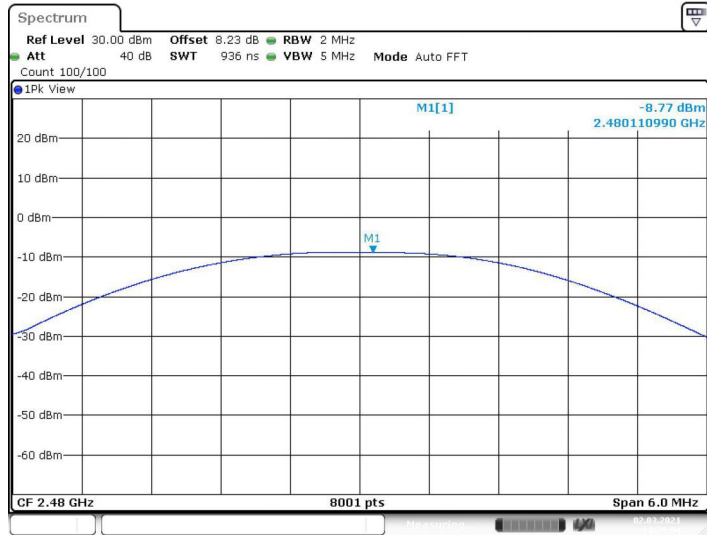

Date: 2.MAR.2021 14:29:55



### 3.3. Power Spectral Density

**Limit**

FCC Part 15 Subpart C(15.247)		
Test Item	Limit	Frequency Range(MHz)
Power Spectral Density	8dBm(in any 3 kHz)	2400~2483.5

**Test Configuration**

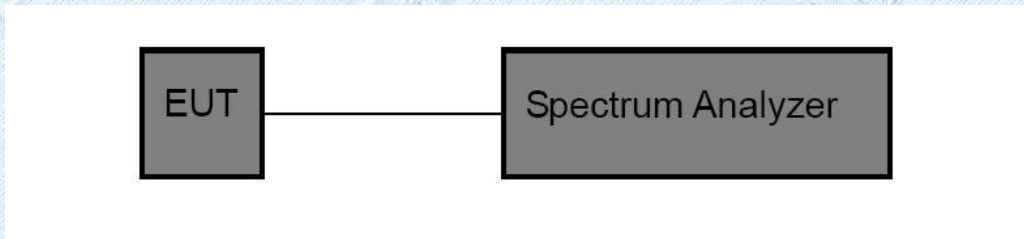

**Test Procedure**

1. Connect EUT RF Output port to the Spectrum Analyzer through an RF attenuator.
2. The EUT was directly connected to the Spectrum Analyzer and antenna output port as show in the block diagram above. The measurement according to section 10.b-6.ii of KDB 558074 D01 DTS Meas Guidance v05r02.
3. Spectrum Setting:
  - Set analyser center frequency to DTS channel center frequency.
  - Set the span to 1.5 times the DTS bandwidth.
  - Set the RBW to: 10 kHz
  - Set the VBW to: 30 kHz
  - Detector: peak
  - Sweep time: auto
  - Allow trace to fully stabilize. Then use the peak marker function to determine the maximum amplitude level.

**Test Mode**

Please refer to the clause 2.2.

**Test Result**

Note:

$$\text{Power Density(dBm/3kHz)} = \text{Power Density(dBm/10kHz)} - 10 \cdot \text{Log}(10/3)$$



**GFSK**

<b>Test Mode:</b>	BLE Mode		
Channel Frequency (MHz)	Power Density (dBm/10kHz)	Power Density (dBm/3kHz)	Limit (dBm)
2402	-17.23	-22.46	8dBm/3kHz
2440	-16.15	-21.38	
2480	-19.54	-24.77	

**BLE Mode**

**2402 MHz**

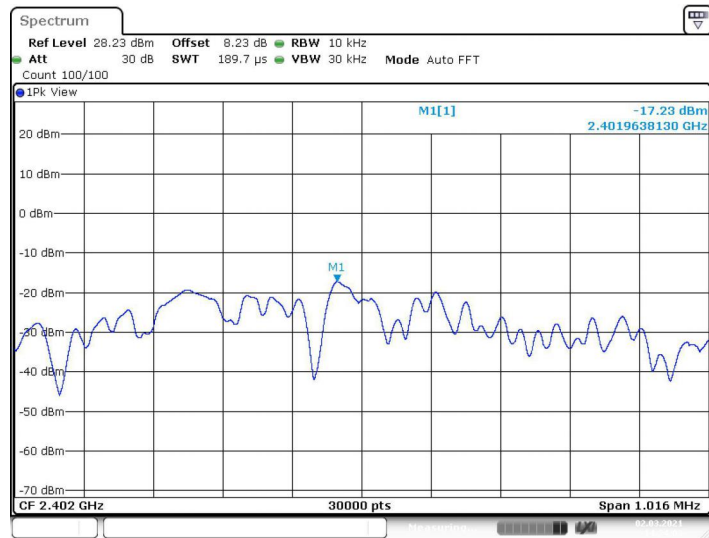

Date: 2.MAR.2021 14:24:03



**BLE Mode**

**2440 MHz**

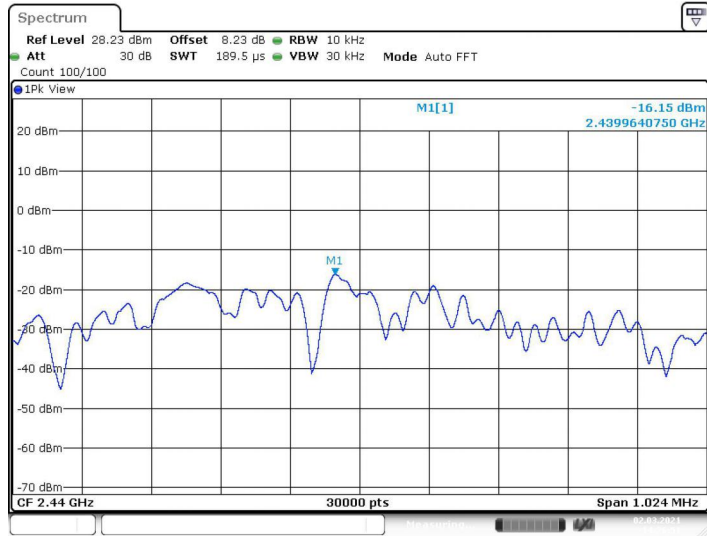

Date: 2.MAR.2021 14:26:50

**BLE Mode**

**2480 MHz**

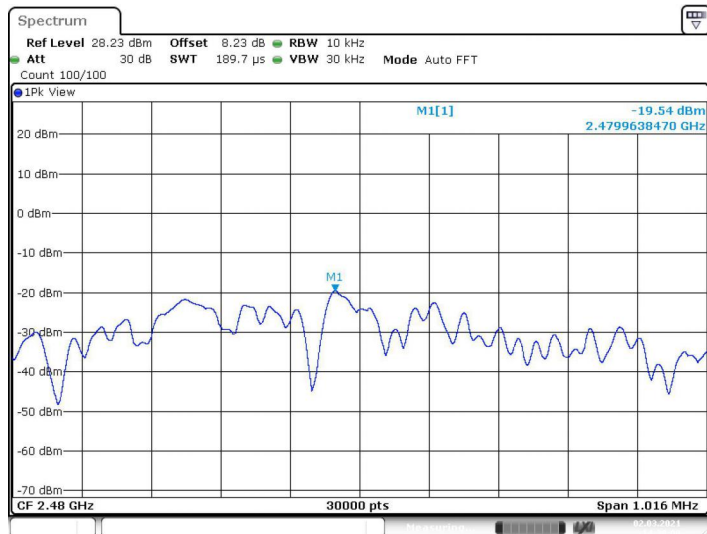

Date: 2.MAR.2021 14:30:01



### 3.4. 6dB Bandwidth

**Limit**

Test Item	Limit	Frequency Range(MHz)
Bandwidth	>=500 KHz (6dB bandwidth)	2400~2483.5

**Test Configuration**

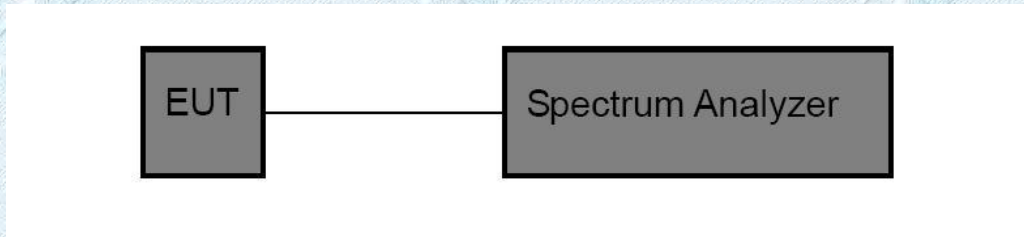

**Test Procedure**

1. Connect EUT RF Output port to the Spectrum Analyzer through an RF attenuator.
2. The 6dB bandwidth is defined as the total spectrum the power of which is higher than peak power minus 6dB.
3. The occupied bandwidth is the frequency bandwidth such that, below its lower and above its upper frequency limits, the mean powers are each equal to 0.5% of the total mean power of the given emission.
4. Spectrum Setting:
  - 6dB bandwidth:
    - (1) Set RBW = 100 kHz.
    - (2) Set the video bandwidth (VBW) ≥ 3 RBW.
    - (3) Detector = Peak.
    - (4) Trace mode = Max hold.
    - (5) Sweep = Auto couple.
    - (6) Allow the trace to stabilize.
  - (7) Measure the maximum width of the emission that is constrained by the frequencies associated with the two outermost amplitude points (upper and lower frequencies) that are attenuated by 6 dB relative to the maximum level measured in the fundamental emission.

NOTE: The EUT was set to continuously transmitting in each mode and low, Middle and high channel for the test.

**Test Mode**

Please refer to the clause 2.2.

**Test Results**



GFSK

Test Mode:	BLE Mode		
Channel frequency (MHz)	6dB Bandwidth (MHz)	99% Bandwidth (MHz)	Limit (MHz)
2402	0.508	1.055	≥0.5
2440	0.512	1.055	
2480	0.508	1.067	

BLE Mode

2402 MHz  
6dB Bandwidth

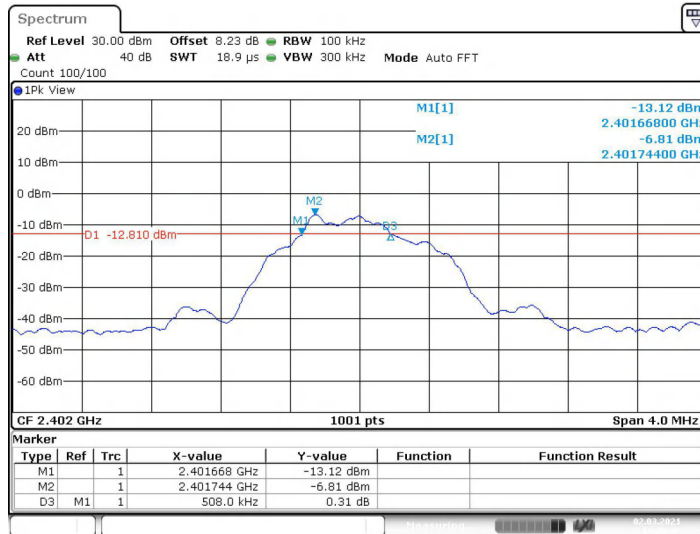

Date: 2.MAR.2021 14:23:39

99% Bandwidth

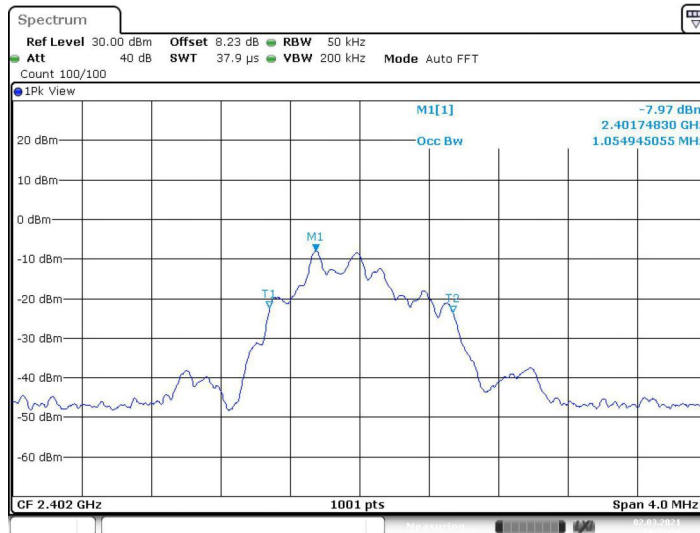

Date: 2.MAR.2021 14:23:50



### BLE Mode

### 2440 MHz 6dB Bandwidth

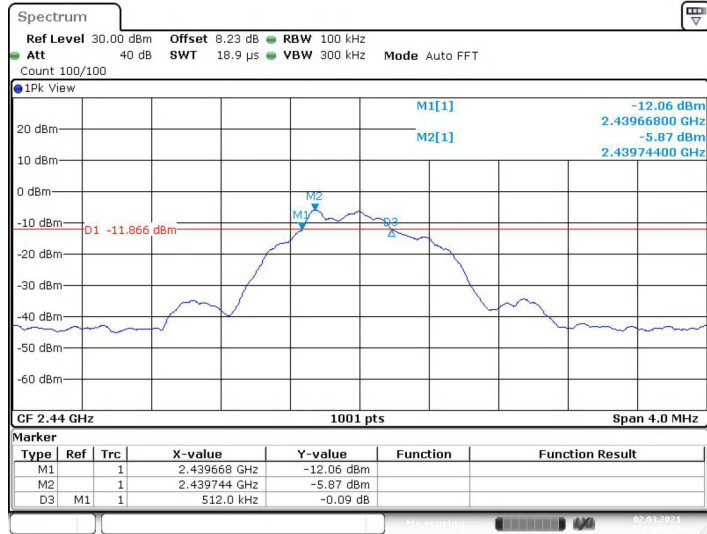

Date: 2.MAR.2021 14:26:27

### 99% Bandwidth



Date: 2.MAR.2021 14:26:37



### BLE Mode

### 2480 MHz 6dB Bandwidth

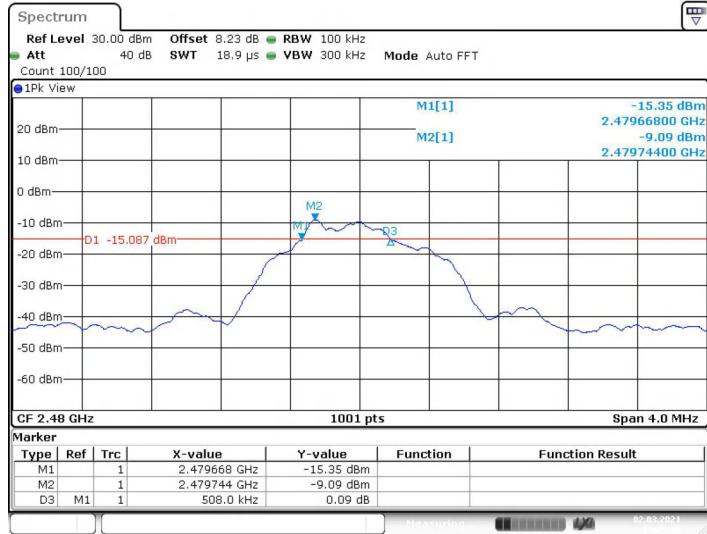

Date: 2.MAR.2021 14:29:37

### 99% Bandwidth

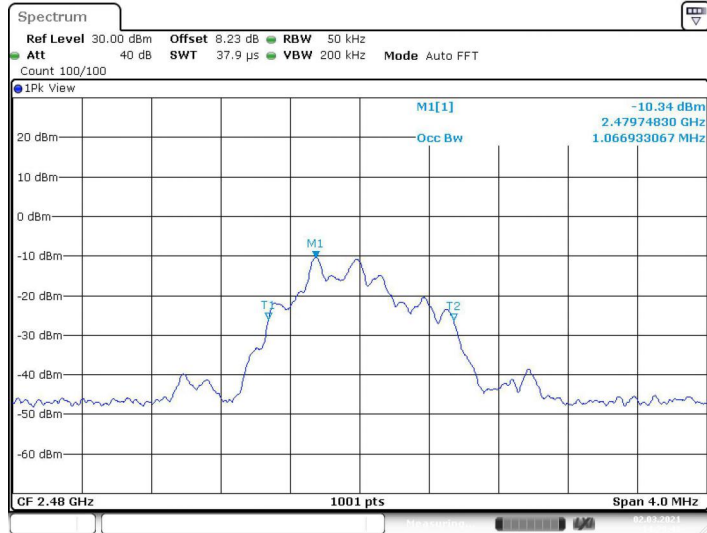

Date: 2.MAR.2021 14:29:48



### 3.5. Band edge and Spurious Emission (conducted)

#### Limit

#### **FCC CFR Title 47 Part 15 Subpart C Section 15.247 (d):**

In any 100 kHz bandwidth outside the frequency band in which the spread spectrum intentional radiator is operating, the radio frequency power that is produced by the intentional radiator shall be at least 20 dB below that in the 100 kHz bandwidth within the band that contains the highest level of the desired power, based on either an RF conducted or a radiated measurement.

#### **Test Configuration**

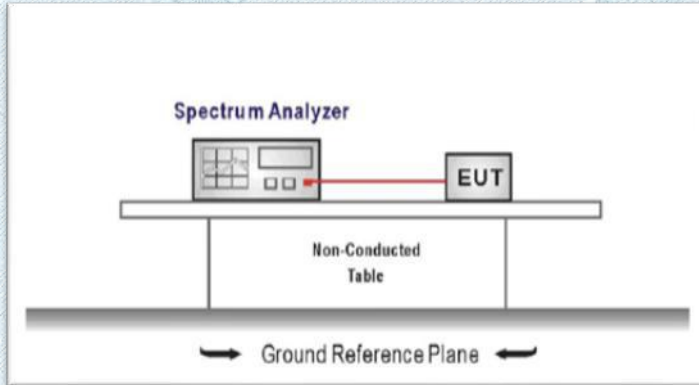

#### **Test Procedure**

1. Connect EUT RF Output port to the Spectrum Analyzer through an RF attenuator.
2. Spectrum Setting:
  - RBW=100KHz
  - VBW=300KHz.
  - Detector function: Peak.
  - Trace: Max hold.
  - Sweep = Auto couple.

Allow the trace to stabilize.

#### **Test Mode**

Please refer to the clause 2.2.



**Test Results**

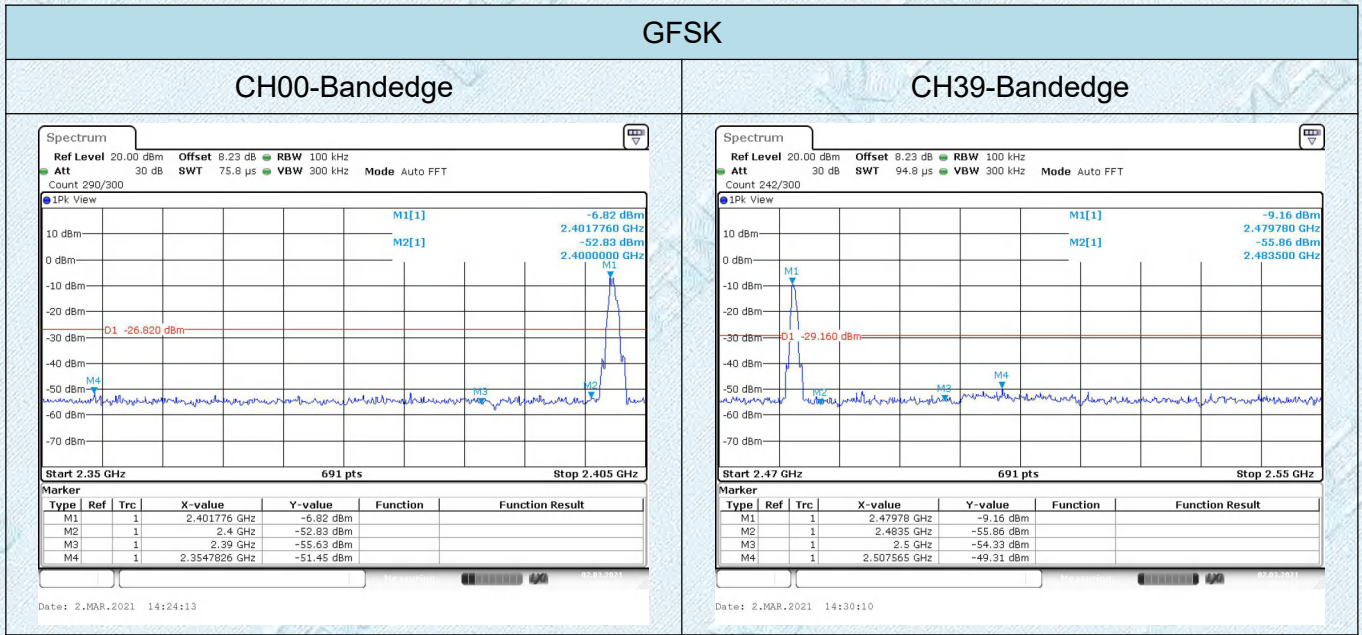



GFSK

CH00-SE

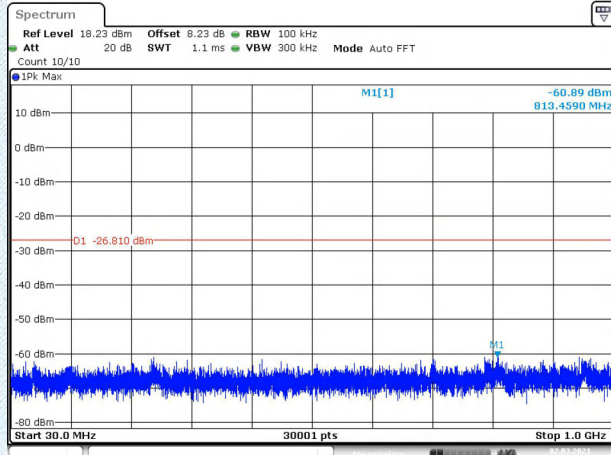

Date: 2.MAR.2021 14:25:17

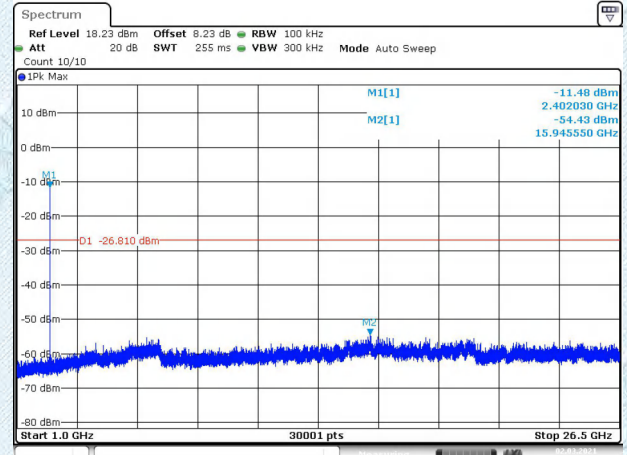

Date: 2.MAR.2021 14:25:40

CH19-SE

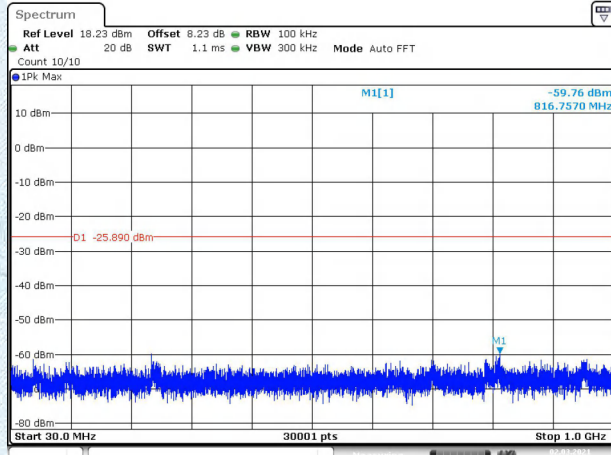

Date: 2.MAR.2021 14:27:01

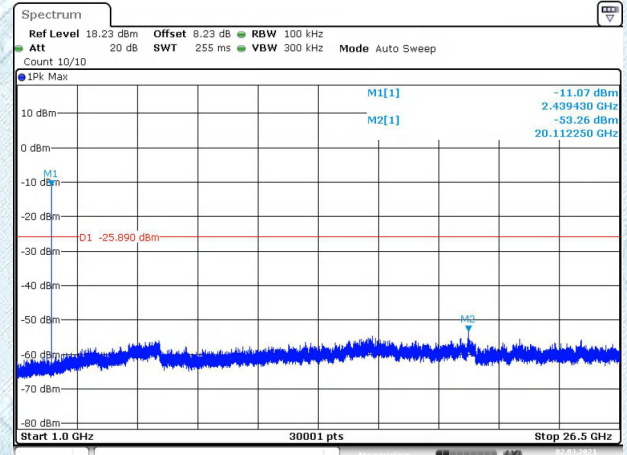

Date: 2.MAR.2021 14:27:24

CH39-SE

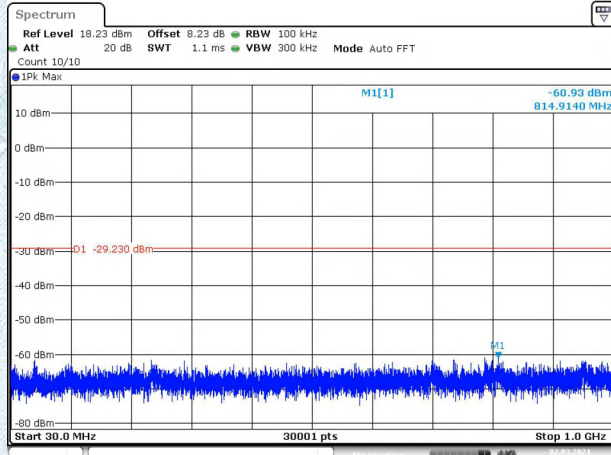

Date: 2.MAR.2021 14:35:26

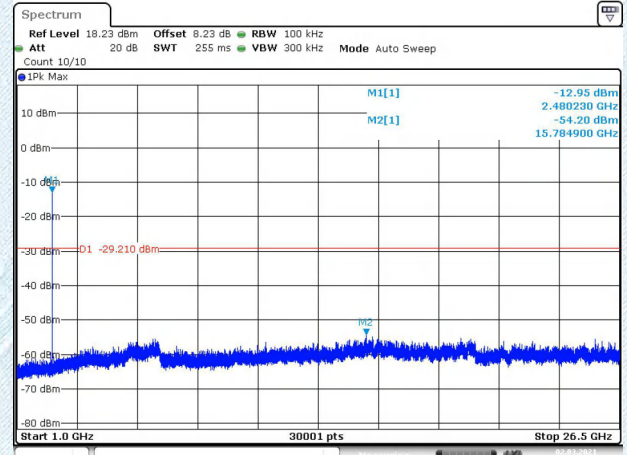

Date: 2.MAR.2021 14:31:36



### 3.6. Band Edge Emissions(Radiated)

**Limit**

Restricted Frequency Band (MHz)	(dBuV/m)(at 3m)	
	Peak	Average
2310 ~2390	74	54
2483.5 ~2500	74	54

**Note: All restriction bands have been tested, only the worst case is reported.**

**Test Configuration**

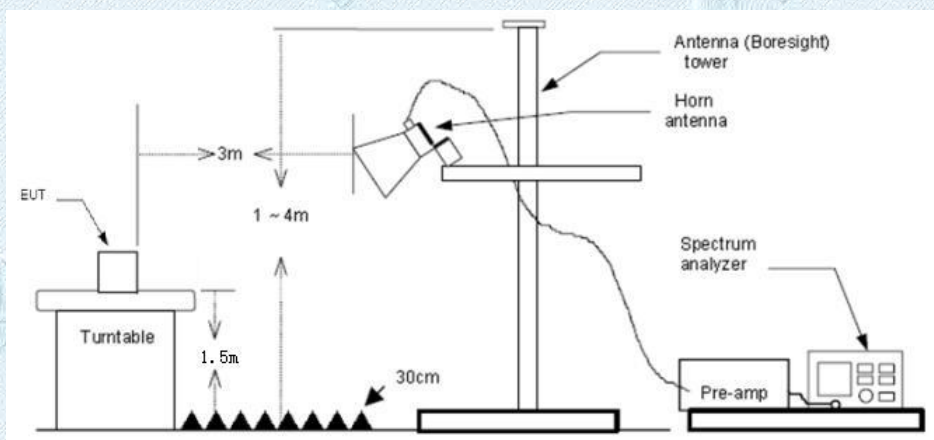

**Test Procedure**

1. The EUT was setup and tested according to ANSI C63.10:2013 requirements.
2. The EUT is placed on a turn table which is 1.5 meter above ground. The turn table is rotated 360 degrees to determine the position of the maximum emission level.
3. The EUT was positioned such that the distance from antenna to the EUT was 3 meters.
4. The antenna is scanned from 1 meter to 4 meters to find out the maximum emission level. This is repeated for both horizontal and vertical polarization of the antenna. In order to find the maximum emission, all of the interface cables were manipulated according to ANSI C63.10:2013 on radiated measurement.
5. The receiver set as follow:  
 RBW=1MHz, VBW=3MHz PEAK detector for Peak value.  
 RBW=1MHz, VBW=10Hz with PEAK Detector for Average Value.

**Test Mode**

Please refer to the clause 2.2.

**Test Results**

Note:

- (1)Measurement = Reading level + Correct Factor
- (2)Correct Factor=Antenna Factor + Cable Loss -Preamplifier Factor



Test Voltage	DC 3.7V
Ant. Pol.:	Horizontal
Test Mode:	TX BLE Mode 2402MHz

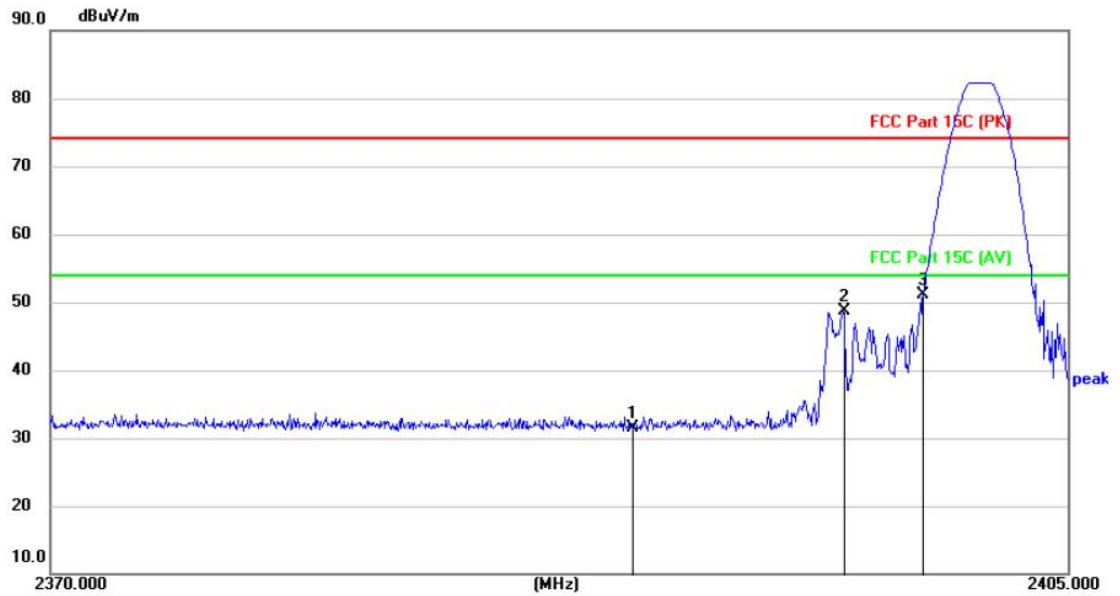

No. Mk.	Freq. MHz	Reading Level (dBuV)	Correct Factor (dB/m)	Measure- ment (dBuV/m)	Limit (dBuV/m)	Over (dB)	Detector
1	2390.000	42.45	-10.92	31.53	74.00	-42.47	peak
2	2397.227	59.63	-10.92	48.71	74.00	-25.29	peak
3 *	2400.000	61.97	-10.92	51.05	74.00	-22.95	peak

Emission Level= Read Level+ Correct Factor



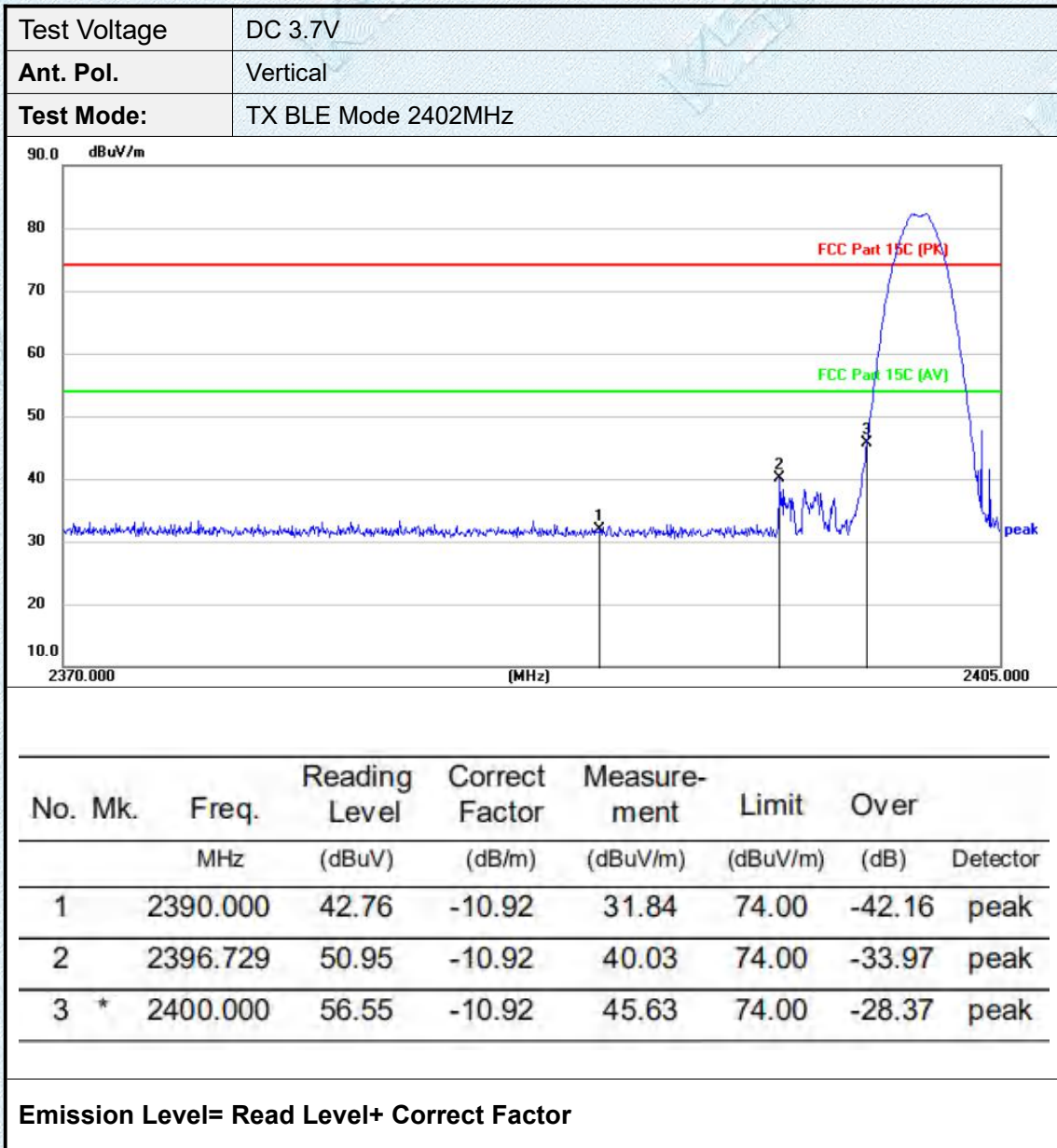



Test Voltage	DC 3.7V
Ant. Pol.	Horizontal
Test Mode:	TX BLE Mode 2480 MHz

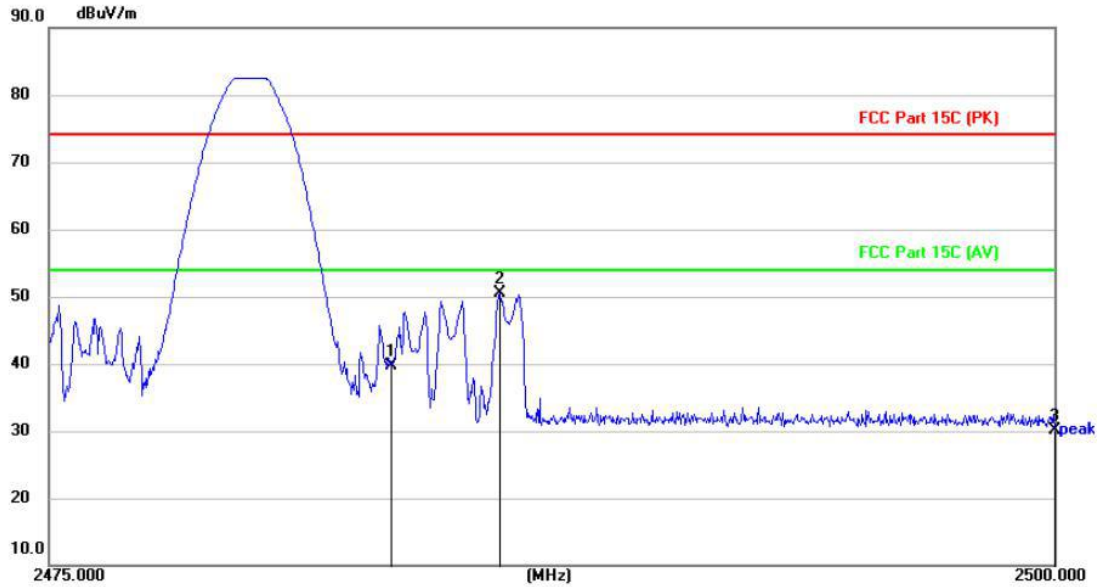

No.	Mk.	Freq. MHz	Reading Level (dBuV)	Correct Factor (dB/m)	Measure- ment (dBuV/m)	Limit (dBuV/m)	Over (dB)	Detector
1		2483.500	50.64	-10.88	39.76	74.00	-34.24	peak
2	*	2486.177	61.35	-10.88	50.47	74.00	-23.53	peak
3		2500.000	40.91	-10.88	30.03	74.00	-43.97	peak

Emission Level= Read Level+ Correct Factor



Test Voltage	DC 3.7V
Ant. Pol.	Vertical
Test Mode:	TX BLE Mode 2480 MHz

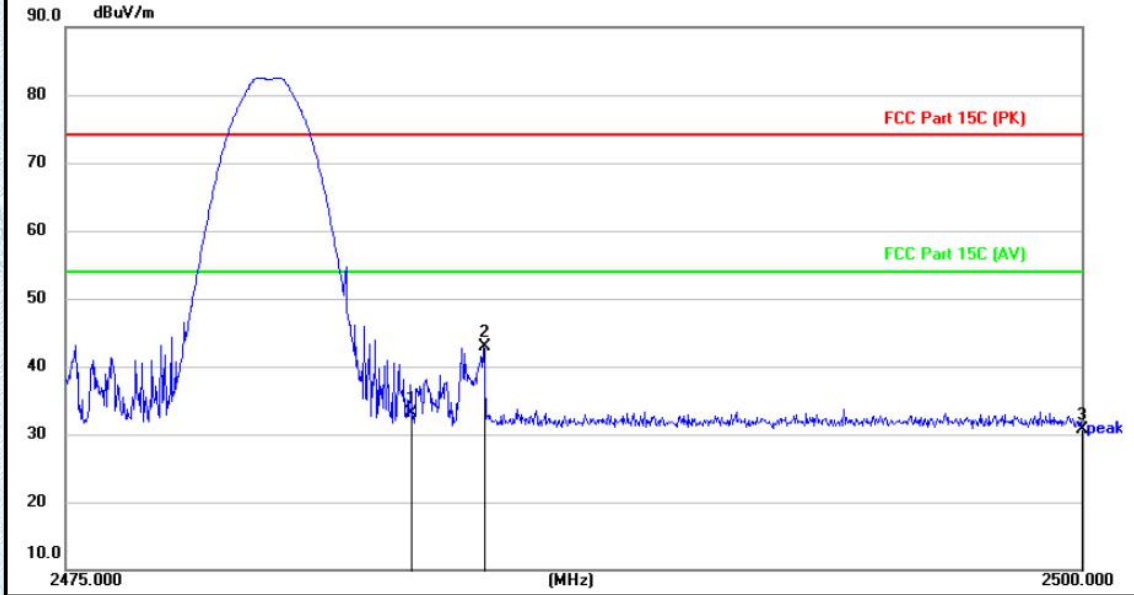

No.	Mk.	Freq. MHz	Reading Level (dBuV)	Correct Factor (dB/m)	Measure- ment (dBuV/m)	Limit (dBuV/m)	Over (dB)	Detector
1		2483.500	43.92	-10.88	33.04	74.00	-40.96	peak
2	*	2485.245	53.69	-10.88	42.81	74.00	-31.19	peak
3		2500.000	41.50	-10.88	30.62	74.00	-43.38	peak

**Emission Level= Read Level+ Correct Factor**



### 3.7. Spurious Emission (Radiated)

Limit

**Radiated Emission Limits (9 kHz~1000 MHz)**

Frequency (MHz)	Field Strength (microvolt/meter)	Measurement Distance (meters)
0.009~0.490	2400/F(KHz)	300
0.490~1.705	24000/F(KHz)	30
1.705~30.0	30	30
30~88	100	3
88~216	150	3
216~960	200	3
Above 960	500	3

**Radiated Emission Limit (Above 1000MHz)**

Frequency (MHz)	Distance Meters(at 3m)	
	Peak	Average
Above 1000	74	54

**Note:**

- (1) The tighter limit applies at the band edges.
- (2) Emission Level (dBuV/m)=20log Emission Level (uV/m).

Test Configuration

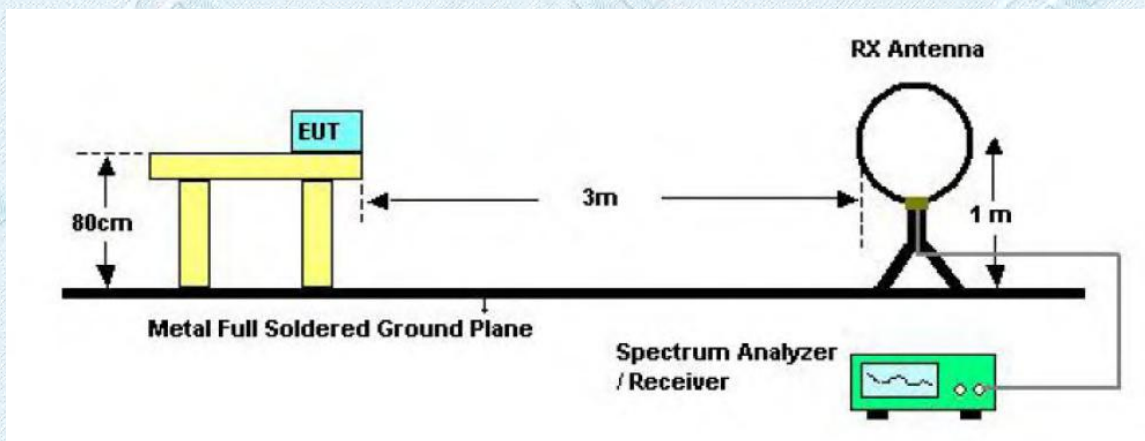

Below 30MHz Test Setup



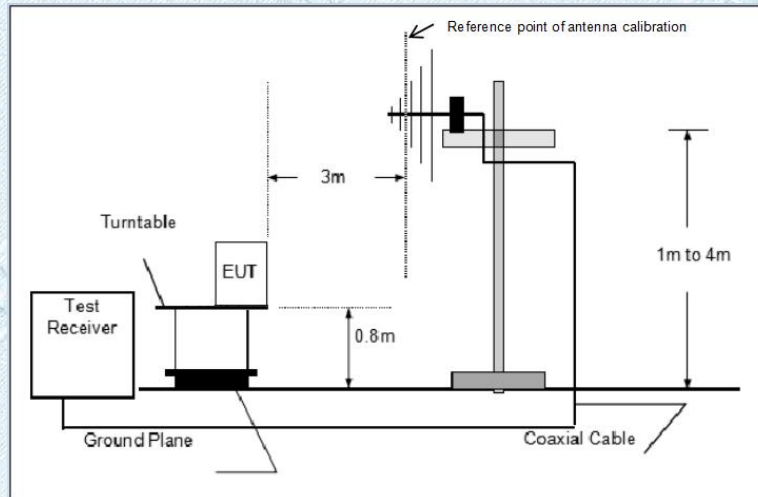

Below 1000MHz Test Setup

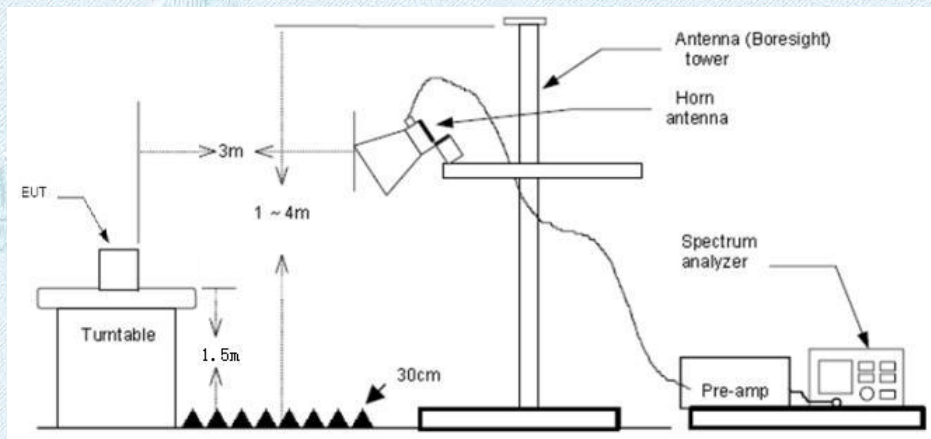

Above 1GHz Test Setup

**Test Procedure**

1. The EUT was setup and tested according to ANSI C63.10:2013
2. The EUT is placed on a turn table which is 0.8 meter above ground for below 1 GHz, and 1.5 m for above 1 GHz. The turn table is rotated 360 degrees to determine the position of the maximum emission level.
3. The EUT was set 3 meters from the receiving antenna, which was mounted on the top of a variable height antenna tower.
4. For each suspected emission, the EUT was arranged to its worst case and then tune the Antenna tower (from 1 m to 4 m) and turntable (from 0 degree to 360 degrees) to find the maximum reading. A pre-amp and a high pass filter are used for the test in order to get better signal level to comply with the guidelines.
5. Set to the maximum power setting and enable the EUT transmit continuously.
6. Use the following spectrum analyzer settings
  - (1) Span shall wide enough to fully capture the emission being measured;
  - (2) Below 1 GHz:  
 RBW=120 kHz, VBW=300 kHz, Sweep=auto, Detector function=peak, Trace=max hold;  
 If the emission level of the EUT measured by the peak detector is 3 dB lower than the applicable limit, the peak emission level will be reported. Otherwise, the emission measurement will be repeated using the quasi-peak detector and reported.
  - (3) From 1 GHz to 10<sup>th</sup> harmonic:  
 RBW=1MHz, VBW=3MHz Peak detector for Peak value.  
 RBW=1MHz, VBW=10Hz Peak detector for Peak value.



**Test Mode**

Please refer to the clause 2.2.

**Test Result****9 KHz~30 MHz and 18GHz~25GHz**

From 9 KHz~30 MHz and 18GHz~25GHz: Conclusion: PASS

Note:

- 1) Measurement = Reading level + Correct Factor  
Correct Factor=Antenna Factor + Cable Loss -Preamplifier Factor
- 2) The peak level is lower than average limit(54 dBuV/m), this data is the too weak instrument of signal is unable to test.
- 3) The emission levels of other frequencies are very lower than the limit and not show in test report.
- 4) The amplitude of spurious emissions which are attenuated by more than 20dB below the permissible value has no need to be reported.
- 5) Pre-scan CH00, CH19 and CH39 modulation, and found the GFSK\_CH00 which it is worse case for 30MHz-1GHz , so only show the test data for worse case.

**BELOW 30MHZ**

No emission found between lowest internal used/generated frequencies to 30MHz.



30MHz-1GHz

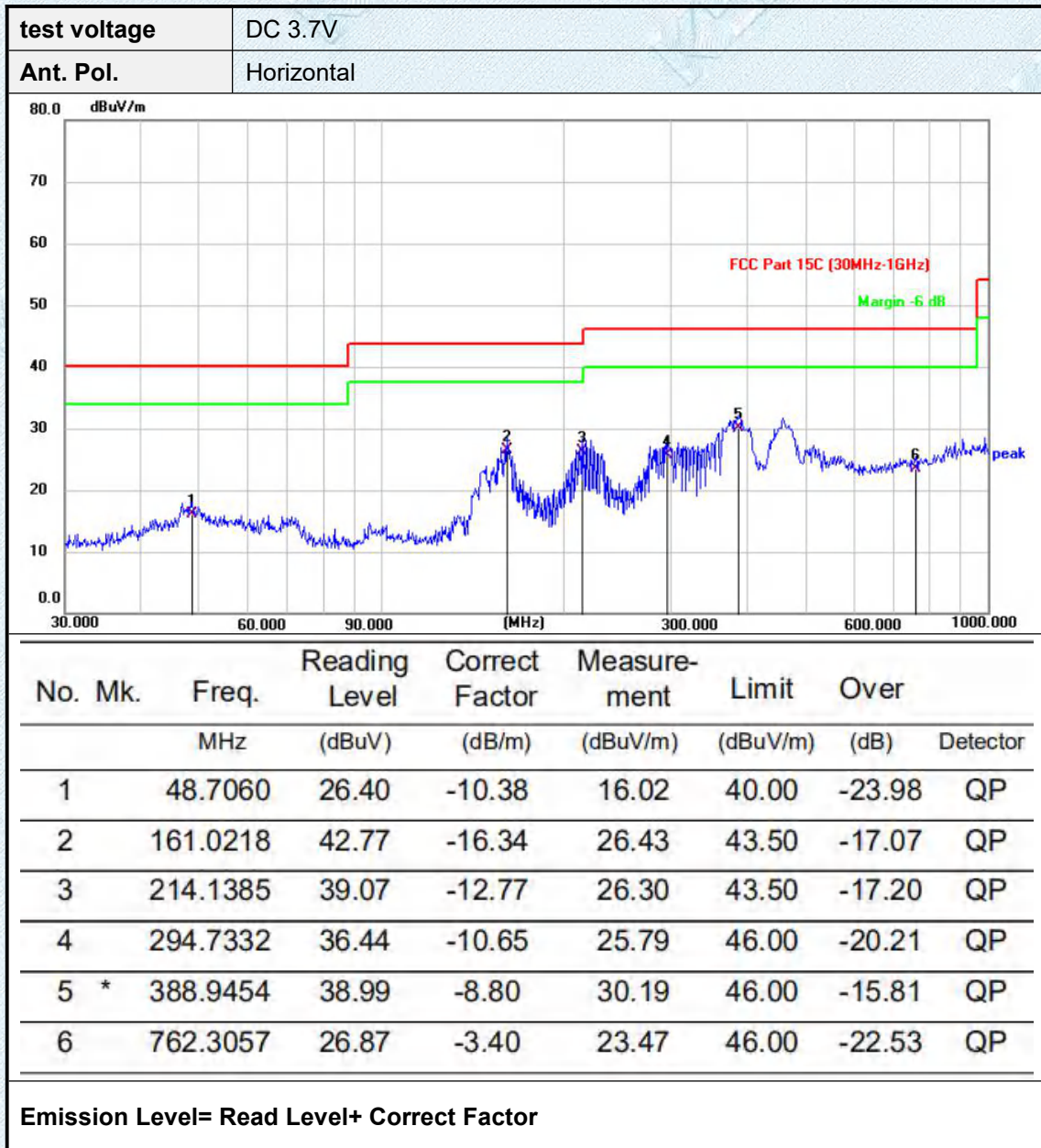



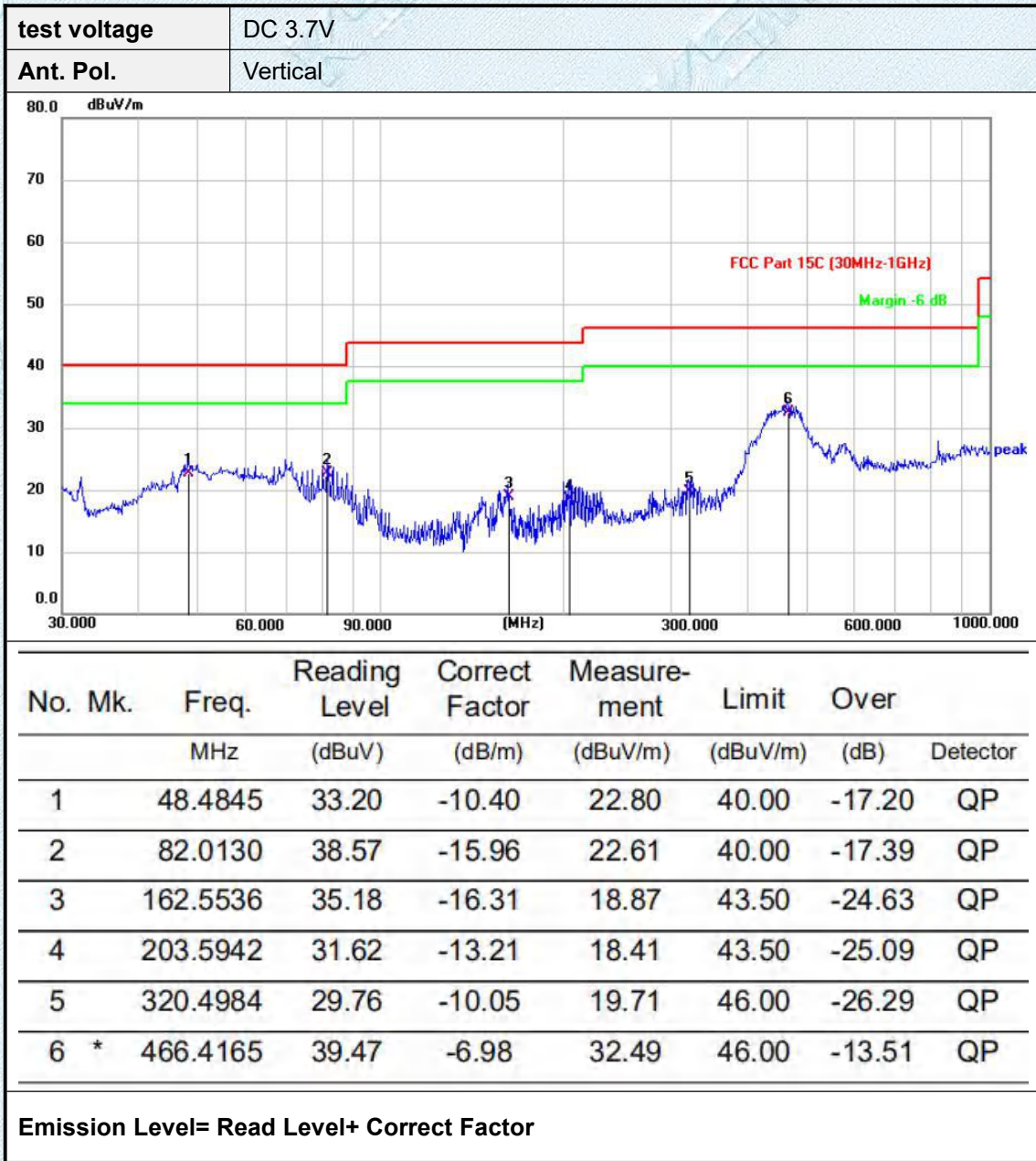



Adobe 1GHz

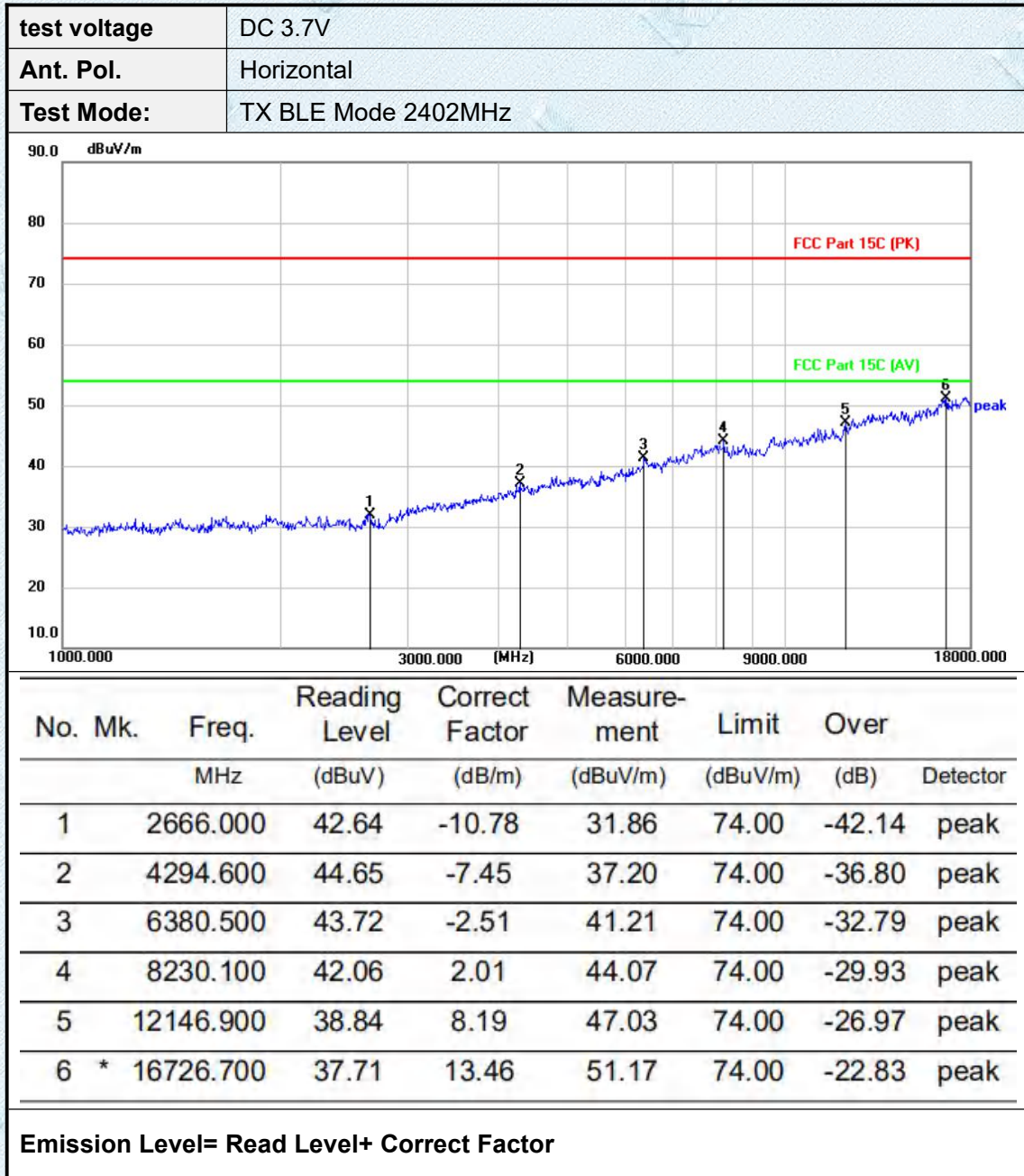



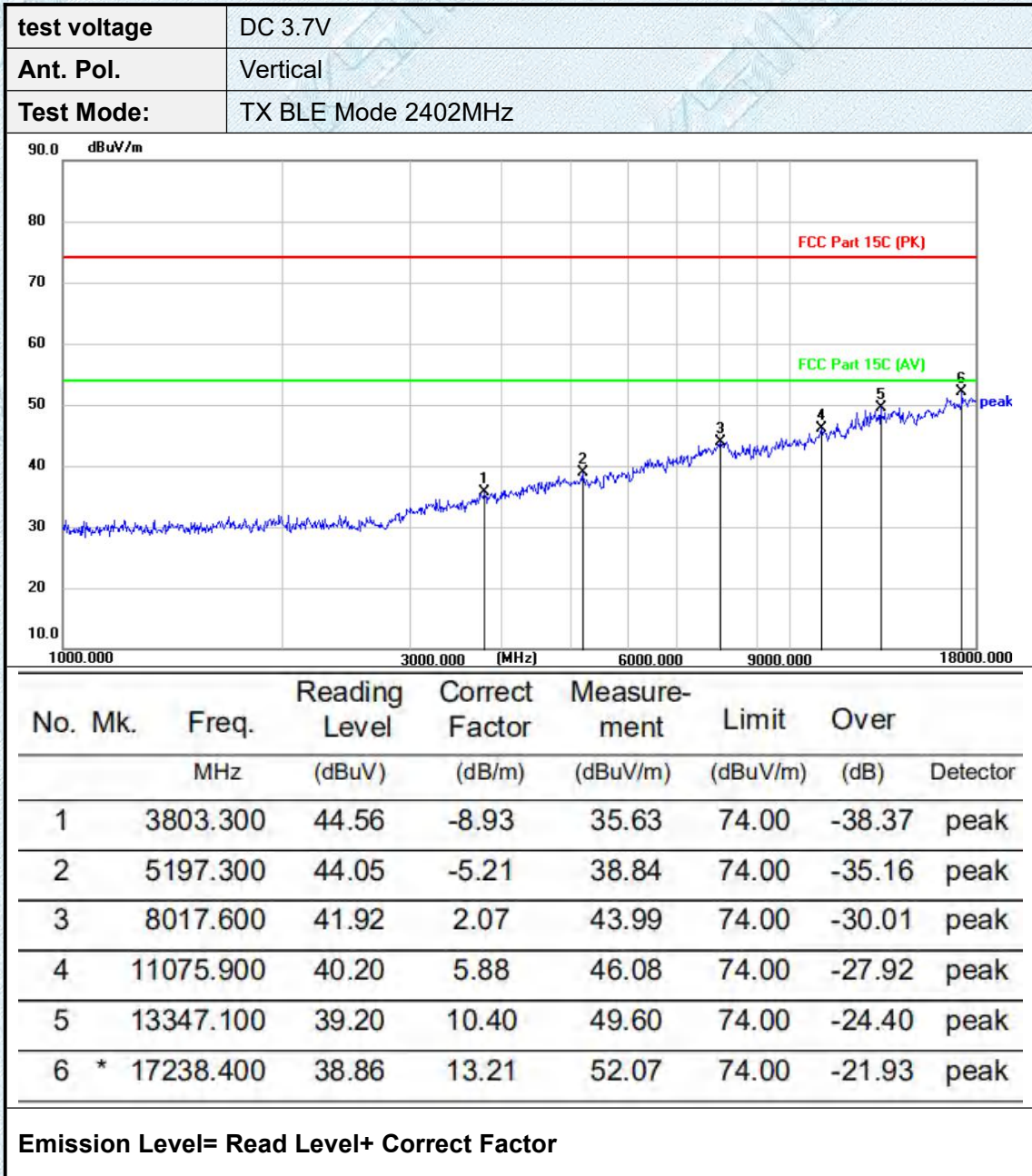



<b>test voltage</b>	DC 3.7V
<b>Ant. Pol.</b>	Horizontal
<b>Test Mode:</b>	TX BLE Mode 2440MHz

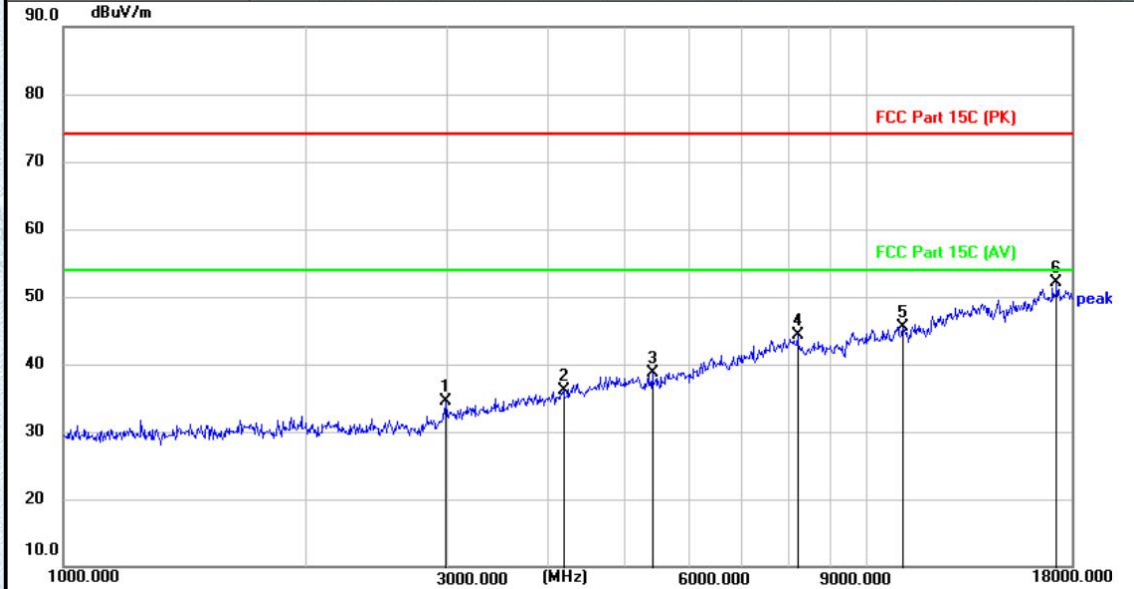

No.	Mk.	Freq. MHz	Reading Level (dBuV)	Correct Factor (dB/m)	Measure- ment (dBuV/m)	Limit (dBuV/m)	Over (dB)	Detector
1		2994.100	45.04	-10.60	34.44	74.00	-39.56	peak
2		4201.100	43.92	-7.76	36.16	74.00	-37.84	peak
3		5409.800	43.82	-5.02	38.80	74.00	-35.20	peak
4		8216.500	42.38	2.02	44.40	74.00	-29.60	peak
5		11096.300	39.59	5.93	45.52	74.00	-28.48	peak
6	*	17286.000	38.85	13.23	52.08	74.00	-21.92	peak

**Emission Level= Read Level+ Correct Factor**



<b>test voltage</b>	DC 3.7V
<b>Ant. Pol.</b>	Vertical
<b>Test Mode:</b>	TX BLE Mode 2440MHz

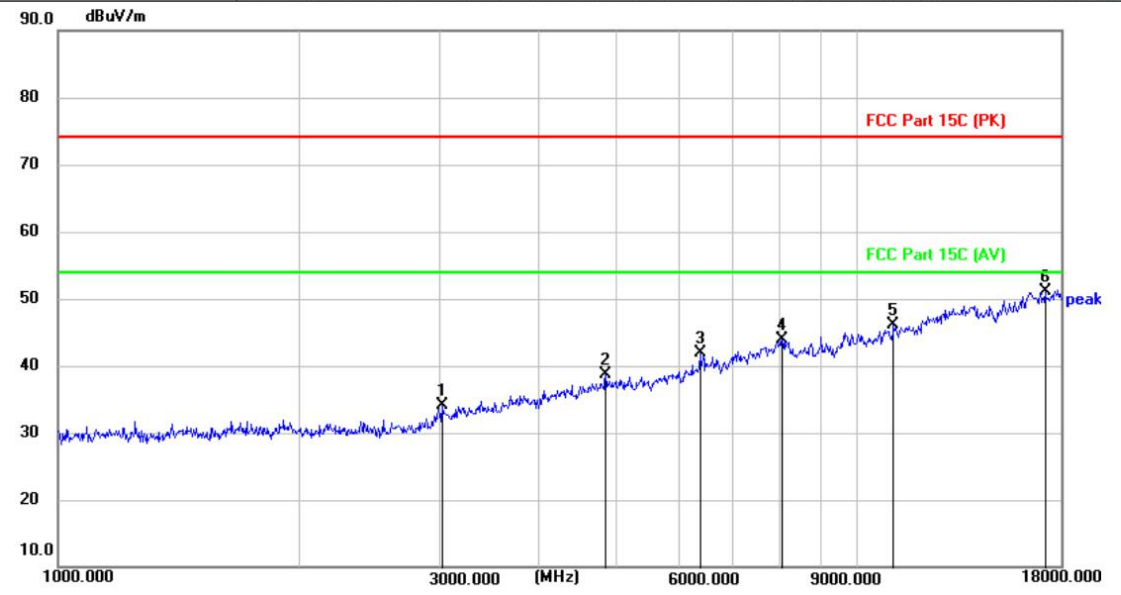

No.	Mk.	Freq. MHz	Reading Level (dBuV)	Correct Factor (dB/m)	Measure- ment (dBuV/m)	Limit (dBuV/m)	Over (dB)	Detector
1		3028.100	44.58	-10.54	34.04	74.00	-39.96	peak
2		4847.100	44.54	-5.80	38.74	74.00	-35.26	peak
3		6368.600	44.54	-2.55	41.99	74.00	-32.01	peak
4		8061.800	41.77	2.06	43.83	74.00	-30.17	peak
5		11108.200	40.14	5.96	46.10	74.00	-27.90	peak
6	*	17221.400	37.86	13.19	51.05	74.00	-22.95	peak

Emission Level= Read Level+ Correct Factor



<b>test voltage</b>	DC 3.7V
<b>Ant. Pol.</b>	Horizontal
<b>Test Mode:</b>	TX BLE Mode 2480MHz

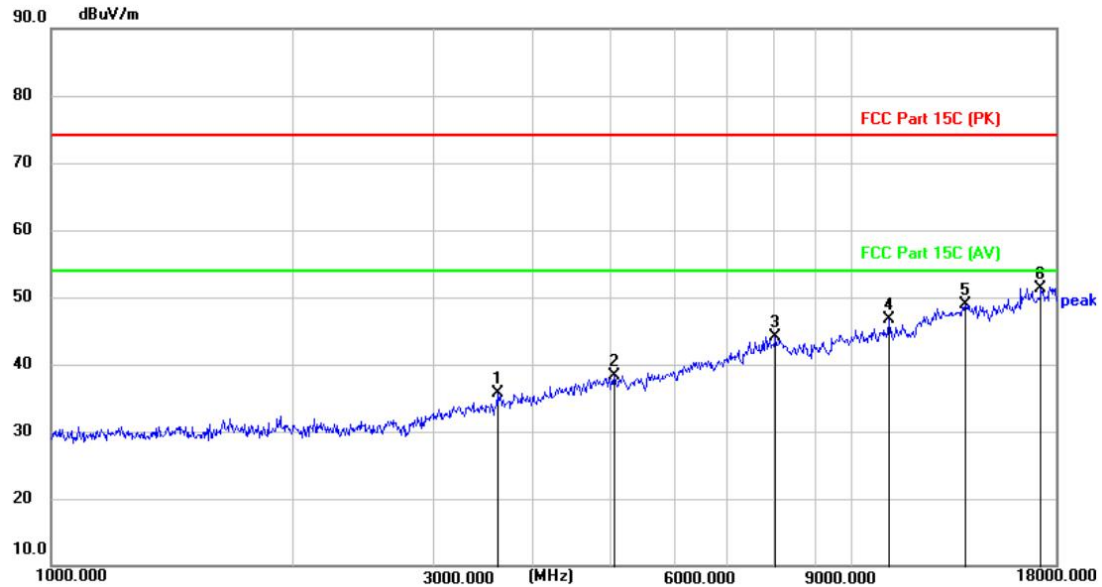

No.	Mk.	Freq. MHz	Reading Level (dBuV)	Correct Factor (dB/m)	Measure- ment (dBuV/m)	Limit (dBuV/m)	Over (dB)	Detector
1		3609.500	45.16	-9.41	35.75	74.00	-38.25	peak
2		5056.200	43.59	-5.33	38.26	74.00	-35.74	peak
3		8056.700	42.05	2.05	44.10	74.00	-29.90	peak
4		11140.500	40.70	6.03	46.73	74.00	-27.27	peak
5		13897.900	37.84	11.11	48.95	74.00	-25.05	peak
6	*	17236.700	38.07	13.21	51.28	74.00	-22.72	peak

Emission Level= Read Level+ Correct Factor



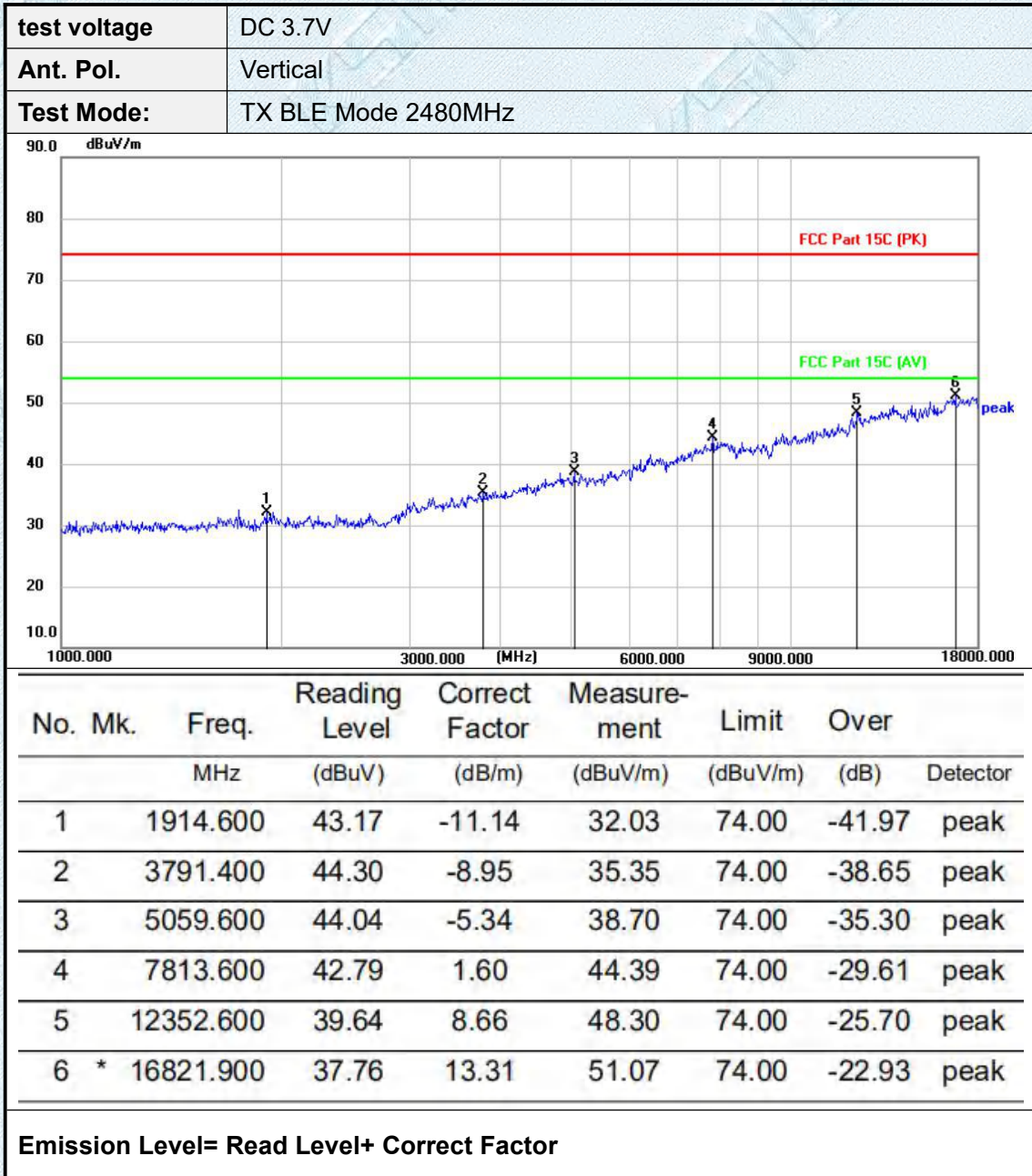



### 3.8. Conducted Emission

**Limit**

**Conducted Emission Test Limit**

Frequency	Maximum RF Line Voltage (dB $\mu$ V)	
	Quasi-peak Level	Average Level
150kHz~500kHz	66 ~ 56 *	56 ~ 46 *
500kHz~5MHz	56	46
5MHz~30MHz	60	50

Notes:

- (1) \*Decreasing linearly with logarithm of the frequency.
- (2) The lower limit shall apply at the transition frequencies.
- (3) The limit decrease in line with the logarithm of the frequency in the range of 0.15 to 0.50MHz.

**Test Configuration**

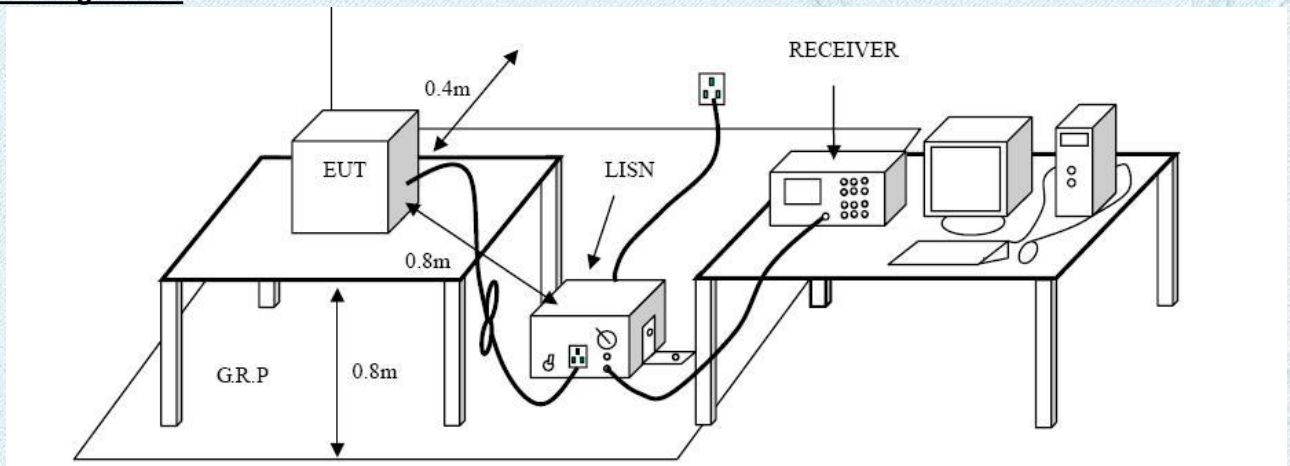

**Test Procedure**

1. The EUT was setup according to ANSI C63.10:2013 requirements.
2. The EUT was placed on a platform of nominal size, 1 m by 1.5 m, raised 80 cm above the conducting ground plane. The vertical conducting plane was located 40 cm to the rear of the EUT. All other surfaces of EUT were at least 80 cm from any other grounded conducting surface.
3. The EUT and simulators are connected to the main power through a line impedances stabilization network (LISN). The LISN provides a 50ohm /50uH coupling impedance for the measuring equipment. The peripheral devices are also connected to the main power through a LISN. (Please refer to the block diagram of the test setup and photographs)
4. Each current-carrying conductor of the EUT power cord, except the ground (safety) conductor, was individually connected through a LISN to the input power source.
5. The excess length of the power cord between the EUT and the LISN receptacle were folded back and forth at the center of the lead to form a bundle not exceeding 40 cm in length.
6. Conducted Emissions were investigated over the frequency range from 0.15MHz to 30MHz using a receiver bandwidth of 9 kHz.
7. During the above scans, the emissions were maximized by cable manipulation.

**Test Mode:**

Please refer to the clause 2.2.

**Test Results**



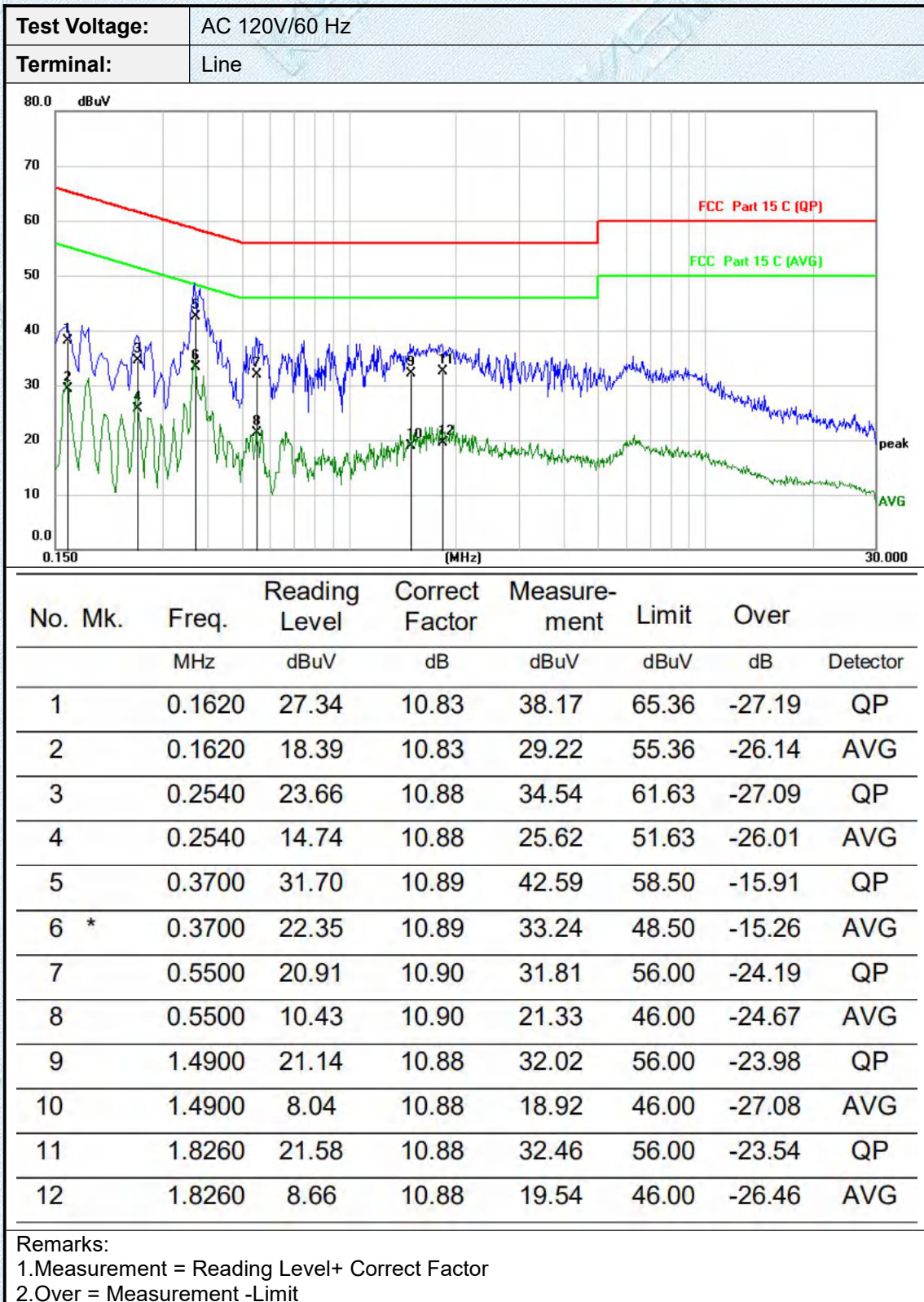



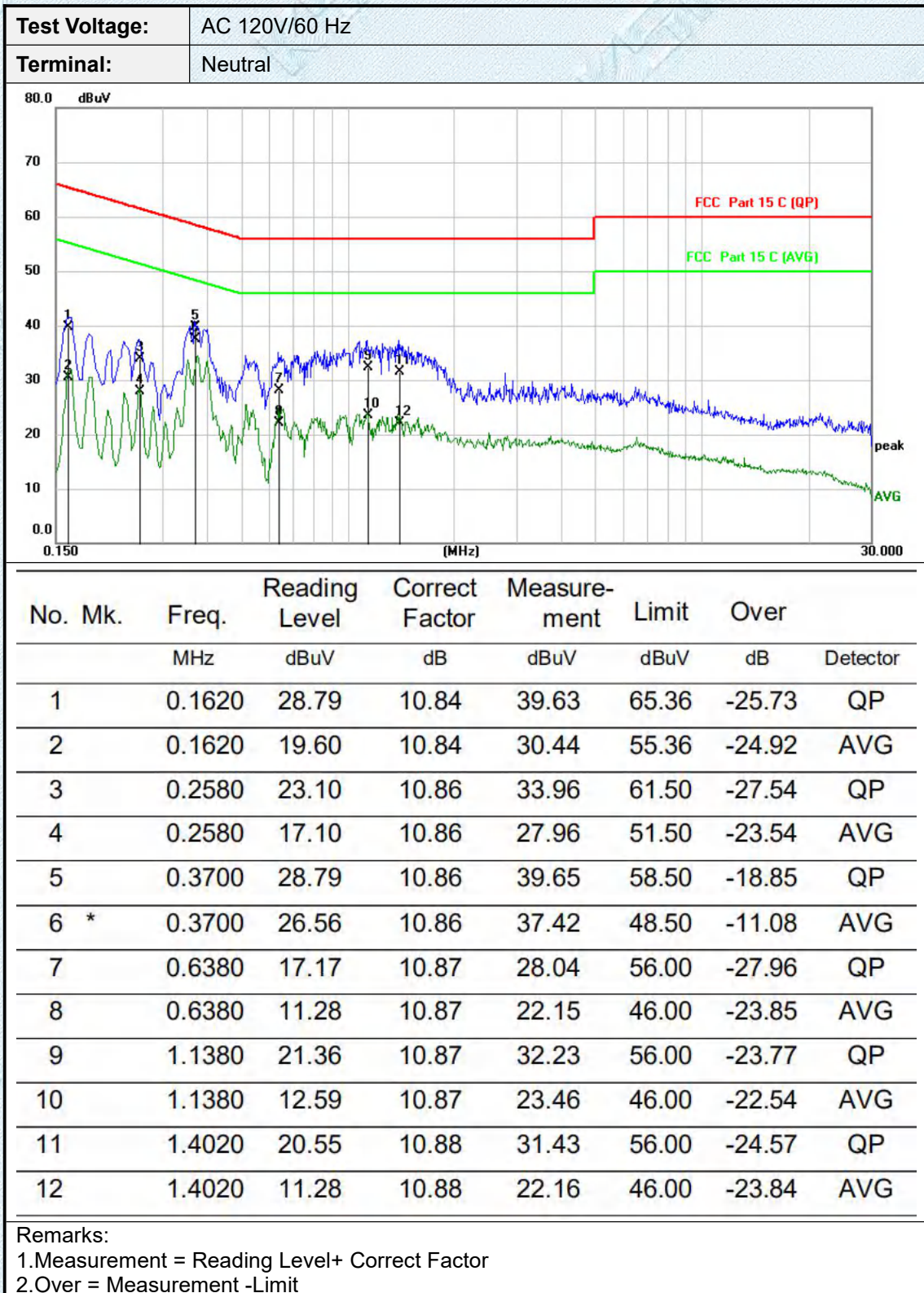



## 4.EUT TEST PHOTOS

Radiated Measurement (Below 1GHz)



Radiated Measurement (Above 1GHz)

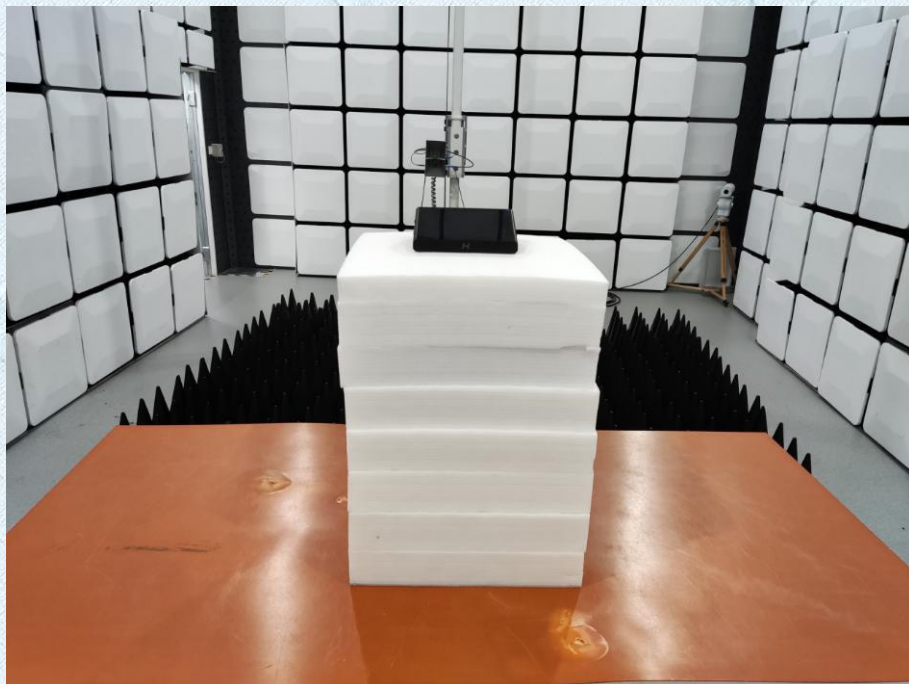



RF Conducted



CONDUCTED EMISSION TEST SETUP

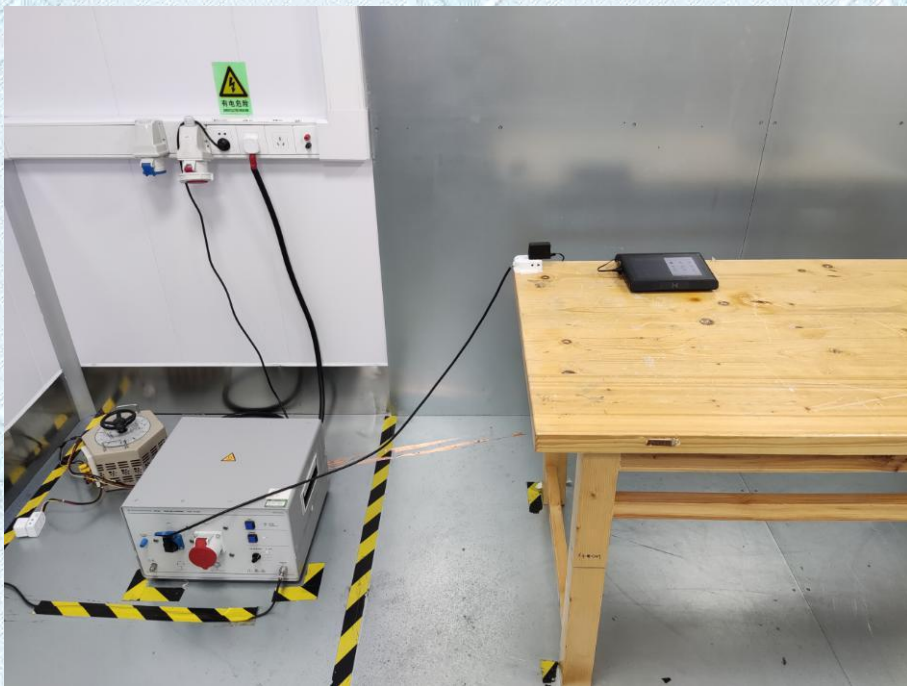



## 5.PHOTOGRAPHS OF EUT CONSTRUCTIONAL

Please refer to External Photographs and Internal Photographs

\*\*\*\*\*THE END\*\*\*\*\*