



# FCC Radio Test Report

## FCC ID: 2AM8GCHAMELEON8

### Original Grant

**Report No.** : TB-FCC164423  
**Applicant** : Guangzhou Lie Dun Electronics Technology CO.,Ltd  
**Equipment Under Test (EUT)**  
**EUT Name** : RUGGEDIZED TABLET  
**Model No.** : 8-DUAL  
**Series Model No.** : 8-MICRO, 8-SINGLE, 8-SINGLE+, 8-SLAP  
**Brand Name** : CHAMELEON  
**Receipt Date** : 2019-02-27  
**Test Date** : 2019-03-04 to 2019-06-25  
**Issue Date** : 2019-06-25  
**Standards** : FCC Part 2  
FCC Part 22 Subpart H, FCC Part 24 Subpart E  
ANSI/TIAC63.26: 2015  
**Conclusions** : **PASS**

In the configuration tested, the EUT complied with the standards specified above,  
The EUT technically complies with the FCC requirements

**Test/Witness Engineer** :  Jason Xu  
**Engineer Supervisor** :  Ivan Su  
**Engineer Manager** :  Ray Lai



This report details the results of the testing carried out on one sample. The results contained in this test report do not relate to other samples of the same product. The manufacturer should ensure that all products in series production are in conformity with the product sample detailed in the report.

---

---

## Contents

<b>CONTENTS</b> .....	<b>2</b>
<b>1. GENERAL INFORMATION ABOUT EUT</b> .....	<b>5</b>
1.1 Client Information.....	5
1.2 General Description of EUT (Equipment Under Test) .....	5
1.3 Block Diagram Showing the Configuration of System Tested.....	6
1.4 Description of Support Units .....	6
1.5 Description of Test Mode.....	7
1.6 Measurement Uncertainty .....	8
1.7 Test Facility.....	8
<b>2. TEST SUMMARY</b> .....	<b>9</b>
<b>3. TEST EQUIPMENT</b> .....	<b>10</b>
<b>4. FREQUENCY STABILITY</b> .....	<b>11</b>
4.1 Test Standard and Requirement .....	11
4.2 Test Setup.....	11
4.3 Test Procedure.....	12
4.4 EUT Operating Condition .....	12
4.5 Test Data.....	12
<b>5. CONDUCTED RF OUTPUT POWER</b> .....	<b>13</b>
5.1 Test Standard and Limit.....	13
5.2 Test Setup.....	13
5.3 Test Procedure.....	13
5.4 EUT Operating Condition .....	13
5.5 Test Data.....	13
<b>6. PEAK-AVERAGE RATIO</b> .....	<b>14</b>
6.1 Test Standard and Limit.....	14
6.2 Test Setup.....	14
6.3 Test Procedure.....	14
6.4 EUT Operating Condition .....	14
6.5 Test Data.....	14
<b>7. RADIATED OUTPUT POWER</b> .....	<b>15</b>
7.1 Test Standard and Limit.....	15
7.2 Test Setup.....	15
7.3 Test Procedure.....	16
7.4 EUT Operating Condition .....	16
7.5 Test Data.....	16
<b>8. OCCUPIED BANDWIDTH</b> .....	<b>17</b>
8.1 Test Standard and Limit.....	17
8.2 Test Setup.....	17
8.3 Test Procedure.....	17

---

8.4 EUT Operating Condition .....	18
8.5 Test Data.....	18
<b>9. CONDUCTED OUT OF BAND EMISSIONS.....</b>	<b>19</b>
9.1 Test Standard and Limit.....	19
9.2 Test Setup.....	19
9.3 Test Procedure.....	19
9.4 EUT Operating Condition .....	19
9.5 Test Data.....	19
<b>10. BAND EDGE TEST .....</b>	<b>20</b>
10.1 Test Standard and Limit .....	20
10.2 Test Setup.....	20
10.3 Test Procedure.....	20
10.4 EUT Operating Condition .....	20
10.5 Test Data.....	20
<b>11. RADIATED OUT BAND OF EMISSIONS.....</b>	<b>21</b>
11.1 Test Standard and Limit .....	21
11.2 Test Setup.....	21
11.3 Test Procedure.....	21
11.4 EUT Operating Condition .....	22
11.5 Test Data.....	22
<b>ATTACHMENT A--FREQUENCY STABILITY .....</b>	<b>23</b>
<b>ATTACHMENT B--CONDUCTED RF OUTPUT POWER .....</b>	<b>25</b>
<b>ATTACHMENT C--PEAK-AVERAGE RATIO .....</b>	<b>27</b>
<b>ATTACHMENT D-- RADIATED OUTPUT POWER.....</b>	<b>29</b>
<b>ATTACHMENT E--OCCUPIED BANDWIDTH.....</b>	<b>30</b>
<b>ATTACHMENT F--CONDUCTED OUT OF BAND EMISSIONS.....</b>	<b>39</b>
<b>ATTACHMENT G-- BAND EDGE TEST.....</b>	<b>51</b>
<b>ATTACHMENT H--RADIATED OUT BAND OF EMISSIONS .....</b>	<b>55</b>



# 1. General Information about EUT

## 1.1 Client Information

<b>Applicant</b>	:	Guangzhou Lie Dun Electronics Technology CO.,Ltd
<b>Address</b>	:	No.4 plant of No.43 South International Trade Avenue, Hualong Town, Panyu District, Guangzhou, Guangdong, China
<b>Manufacturer</b>	:	Guangzhou Lie Dun Electronics Technology CO.,Ltd
<b>Address</b>	:	No.4 plant of No.43 South International Trade Avenue, Hualong Town, Panyu District, Guangzhou, Guangdong, China

## 1.2 General Description of EUT (Equipment Under Test)

<b>EUT Name</b>	:	RUGGEDIZED TABLET
<b>Models No.</b>	:	8-DUAL, 8-MICRO, 8-SINGLE, 8-SINGLE+, 8-SLAP
<b>Model Difference</b>	:	All these models are identical in the same PCB, layout and electrical circuit, the only difference is model name for commercial.
<b>Product Description</b>	:	Frequency Bands: UMTS FDD Band II; UMTS FDD Band V
	:	UMTS Band II Power:      Cond:22.55 dBm    ERP:21.58 dBm
	:	UMTS Band V Power:      Cond:21.97 dBm    EIRP:21.25 dBm
	:	Antenna Gain:              1.5 dB FPC Antenna
	:	Modulation Type:          UMTS:QPSK
<b>FCC Operating Frequency</b>	:	UMTS Band II: 1852.40MHz-1907.60MHz UMTS Band V:826.40MHz-846.60MHz
<b>Emission Designator</b>	:	UMTS Band II: 4M78F9W UMTS Band V: 4M75F9W
<b>Power Rating</b>	:	Adapter(B036-125): Input: AC 100-240V, 50/60Hz, 1.2A max Output: DC 12V, 3A DC 7.6V by 7600mAh rechargeable Li-ion battery.
<b>Software Version</b>	:	Windows Pro
<b>Hardware Version</b>	:	V12
<b>Connecting I/O Port(S)</b>	:	Please refer to the User's Manual

**Note:**

For a more detailed features description, please refer to the manufacturer's specifications or the User's Manual.

### 1.3 Block Diagram Showing the Configuration of System Tested

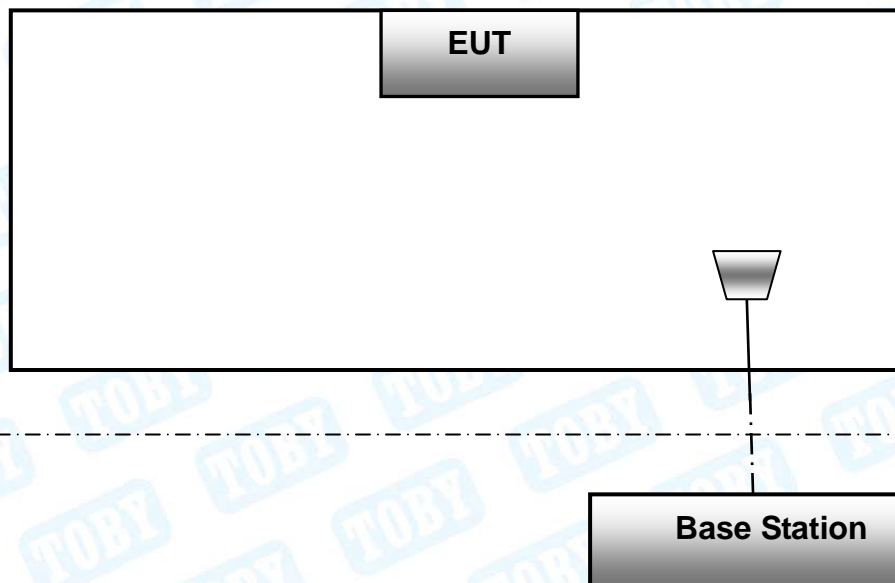

The above block diagram of setup is the normal mode. And more detail please refer to the test setup of each test item of bellow.

### 1.4 Description of Support Units

The EUT has been tested as an independent unit.

## 1.5 Description of Test Mode

To investigate the maximum EMI emission characteristics generates from EUT, the test system was pre-scanning tested base on the consideration of following EUT operation mode or test configuration mode which possible have effect on EMI emission level. Each of these EUT operation mode(s) or test configuration mode(s) mentioned follow was evaluated respectively.

During all testing, EUT is link mode with base station at maximum power level. The spurious emission measurements were carried out in semi-anechoic chamber with 3-meter test range. Frequency range investigated for radiated emission as below:

1. 9kHz~10GHz for UMTS Band V.
2. 9kHz~20GHz for UMTS Band II.

Test Channel		
Mode	Channel	Frequency(MHz)
UMTS Band V	4132	826.40
	4183	836.60
	4233	846.60
UMTS Band II	9262	1852.40
	9400	1880.00
	9538	1907.60
Test Mode		Description
HSDPA UMTS Band V		highest , middle, lowest channels
HSUPA UMTS Band V		highest , middle, lowest channels
HSDPA UMTS Band II		highest , middle, lowest channels
HSUPA UMTS Band II		highest , middle, lowest channels

**Note:**

- (1) The measurements are performed at the highest, middle, lowest available channels.
- (2) During the testing procedure, the EUT is in link mode with base station emulator at maximum power level in each test mode.
- (3) The EUT has HSDPA, HSUPA functions in UMTS band II and UMTS band V, and after pre-testing, RMC mode is the worst case for all the emission tests.
- (4) The EUT is considered a portable unit; it was pre-tested on the positioned of each 3 axis, X-plane, Y-plane and Z-plane. The worst case was found positioned on Z-plane as the normal use. Therefore only the test data of this Z-plane was used for radiated emission measurement test.

## 1.6 Measurement Uncertainty

Test Item	Parameters	Expanded Uncertainty ( $U_{Lab}$ )
Conducted Emission	Level Accuracy: 9kHz~150kHz	$\pm 3.42$ dB
	150kHz to 30MHz	$\pm 3.42$ dB
Radiated Emission	Level Accuracy: 9kHz to 30 MHz	$\pm 4.60$ dB
Radiated Emission	Level Accuracy: 30MHz to 1000 MHz	$\pm 4.40$ dB
Radiated Emission	Level Accuracy: Above 1000MHz	$\pm 4.20$ dB

## 1.7 Test Facility

The testing was performed by the Shenzhen Toby Technology Co., Ltd., in their facilities located at: 1A/F., Bldg.6, Yusheng Industrial Zone, The National Road No.107 Xixiang Section 467, Xixiang, Bao'an, Shenzhen, Guangdong, China.

At the time of testing, the following bodies accredited the Laboratory:

### **CNAS (L5813)**

The Laboratory has been accredited by CNAS to ISO/IEC 17025: 2005 General Requirements for the Competence of Testing and Calibration Laboratories for the competence in the field of testing. And the Registration No.: CNAS L5813.

### **A2LA Certificate No.: 4750.01**

The laboratory has been accredited by American Association for Laboratory Accreditation(A2LA) to ISO/IEC 17025: 2005 General Requirements for the Competence of Testing and Calibration Laboratories for the technical competence in the field of Electrical Testing. And the A2LA Certificate No.: 4750.01.FCC Accredited Test Site Number: 854351.

### **IC Registration No.: (11950A-1)**

The Laboratory has been registered by Certification and Engineering Bureau of Industry Canada for radio equipment testing. The site registration: Site# 11950A-1.



## 2. Test Summary

Test Standards and Test Results			
Standard	Document Title		
FCC Part 2 (10-1-05 Edition)	Frequency Allocations and Radio Treaty Matters; General Rules and Regulations		
FCC Part 22 (10-1-05 Edition)	Public Mobile Services		
FCC Part 24 (10-1-05 Edition)	Personal Communications Services		
Standard Section	Test Item	Judgment	Remark
2.1046	Conducted RF Output Power	PASS	N/A
24.232(d)	Peak-Average Ratio	PASS	N/A
2.1049; 22.917; 24.238	99% & -26 dB Occupied Bandwidth	PASS	N/A
2.1055; 22.355; 24.235	Frequency Stability	PASS	N/A
2.1051; 2.1057; 22.917; 24.238	Conducted Out of Band Emissions	PASS	N/A
2.1051; 2.1057; 22.917; 24.238	Band Edge	PASS	N/A
22.913; 24.238	Transmitter Radiated Power (EIRP/ERP)	PASS	N/A
2.1053; 2.1057; 22.917; 24.238	Radiated Out of Band Emissions	PASS	N/A
<b>Note:</b> N/A is an abbreviation for Not Applicable.			

### 3. Test Equipment

Conducted Emission Test					
Equipment	Manufacturer	Model No.	Serial No.	Last Cal.	Cal. Due Date
EMI Test Receiver	Rohde & Schwarz	ESCI	100321	Jul.18, 2018	Jul. 17, 2019
RF Switching Unit	Compliance Direction Systems Inc	RSU-A4	34403	Jul.18, 2018	Jul. 17, 2019
AMN	SCHWARZBECK	NNBL 8226-2	8226-2/164	Jul.18, 2018	Jul. 17, 2019
LISN	Rohde & Schwarz	ENV216	101131	Jul.18, 2018	Jul. 17, 2019
Radiation Emission Test					
Equipment	Manufacturer	Model No.	Serial No.	Last Cal.	Cal. Due Date
Spectrum Analyzer	Agilent	E4407B	MY45106456	Jul.18, 2018	Jul. 17, 2019
EMI Test Receiver	Rohde & Schwarz	ESPI	100010/007	Jul.18, 2018	Jul. 17, 2019
Bilog Antenna	ETS-LINDGREN	3142E	00117537	Jan. 27, 2019	Jan. 26, 2020
Bilog Antenna	ETS-LINDGREN	3142E	00117542	Jan. 27, 2019	Jan. 26, 2020
Horn Antenna	ETS-LINDGREN	3117	00143207	Mar.03, 2019	Mar. 02, 2020
Horn Antenna	ETS-LINDGREN	3117	00143209	Mar.03, 2019	Mar. 02, 2020
Loop Antenna	SCHWARZBECK	FMZB 1519 B	1519B-059	Jul. 14, 2018	Jul.13, 2019
Pre-amplifier	Sonoma	310N	185903	Mar.04, 2019	Mar. 03, 2020
Pre-amplifier	HP	8449B	3008A00849	Mar.03, 2019	Mar. 02, 2020
Cable	HUBER+SUHNER	100	SUCOFLEX	Mar.03, 2019	Mar. 02, 2020
Positioning Controller	ETS-LINDGREN	2090	N/A	N/A	N/A
Antenna Conducted Emission					
Equipment	Manufacturer	Model No.	Serial No.	Last Cal.	Cal. Due Date
Spectrum Analyzer	Agilent	E4407B	MY45106456	Jul.18, 2018	Jul. 17, 2019
Spectrum Analyzer	Rohde & Schwarz	ESCI	100010/007	Jul.18, 2018	Jul. 17, 2019
MXA Signal Analyzer	Agilent	N9020A	MY49100060	Sep. 15, 2018	Sep. 14, 2019
Vector Signal Generator	Agilent	N5182A	MY50141294	Sep. 15, 2018	Sep. 14, 2019
Analog Signal Generator	Agilent	N5181A	MY50141953	Sep. 15, 2018	Sep. 14, 2019
RF Power Sensor	DARE!! Instruments	RadiPowerRPR3006W	17I00015SNO26	Sep. 15, 2018	Sep. 14, 2019
	DARE!! Instruments	RadiPowerRPR3006W	17I00015SNO29	Sep. 15, 2018	Sep. 14, 2019
	DARE!! Instruments	RadiPowerRPR3006W	17I00015SNO31	Sep. 15, 2018	Sep. 14, 2019
	DARE!! Instruments	RadiPowerRPR3006W	17I00015SNO33	Sep. 15, 2018	Sep. 14, 2019

## 4. Frequency Stability

### 4.1 Test Standard and Requirement

#### 4.1.1 Test Standard

FCC Part 2.1055

FCC Part 22.355

FCC Part 24.235

#### 4.1.2 Requirement

According to FCC section 22.355 and FCC section 24.235, the frequency stability shall be sufficient to ensure that the fundamental emission stays within the authorized frequency block. According to FCC section 2.1055, the test conditions are:

(1) Temperature:

The temperature is varied from  $-30^{\circ}\text{C}$  to  $+50^{\circ}\text{C}$  at intervals of not more than  $10^{\circ}\text{C}$ .

(2) Primary Supply Voltage:

For hand carried battery powered equipment, the primary supply voltage is reduced to the battery operating end point which shall be specified by the manufacture. The supply voltage shall be measured at input to the cable normally provide with the equipment, or at the power supply terminals if cables are not normally provided.

### 4.2 Test Setup

For Temperature Test:

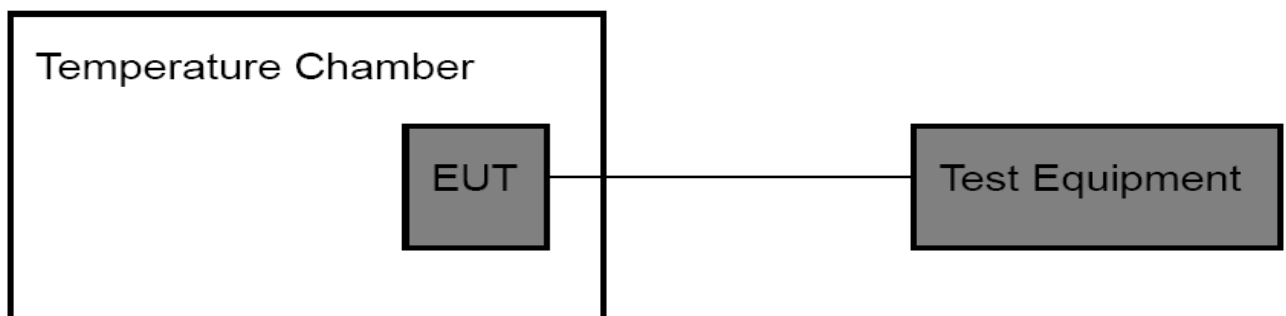

For Voltage Test:

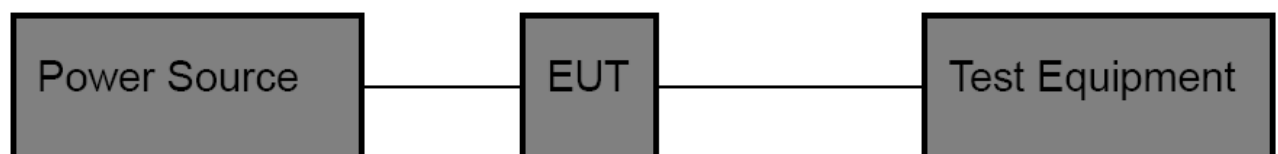

### 4.3 Test Procedure

Test Procedures for Temperature Variation:

- (1) The EUT was set up in the thermal chamber and connected with the base station.
- (2) With power off, the temperature was decreased to  $-30^{\circ}\text{C}$  and the EUT was stabilized for three hours. Power was applied and the maximum change in frequency was recorded within one minute.
- (3) With power off, the temperature was raised in  $10^{\circ}\text{C}$  set up to  $50^{\circ}\text{C}$  and the EUT was stabilized for three hours. Power was applied and the maximum change in frequency was recorded within one minute.
- (4) If the EUT cannot be turned on at  $-30^{\circ}\text{C}$ , the testing lowest temperature will be raised in  $10^{\circ}\text{C}$  step until the EUT can be turned on.

Test Procedures for Voltage Variation:

- (1) The EUT was placed in a temperature chamber at  $25 \pm 5^{\circ}\text{C}$  and connected with the base station.
- (2) Reduce the input voltage to specify extreme voltage variation ( $\pm 15\%$ ) and endpoint, record the maximum frequency change.
- (3) The variation in frequency was measured for the worst case.

### 4.4 EUT Operating Condition

The Equipment Under Test was set to Communication with the Base Station.

### 4.5 Test Data

Please refer to the Attachment A.

## 5. Conducted RF Output Power

### 5.1 Test Standard and Limit

#### 5.1.1 Test Standard

FCC Part 2: 2.1046

FCC Part 22H : 22.913 (a)

FCC Part 24E: 24.232 (c)

#### 5.1.2 Test Limit

GSM850/UMTS Band V	PCS 1900/UMTS Band II
38.5 dBm (ERP)	33 dBm (EIRP)

### 5.2 Test Setup

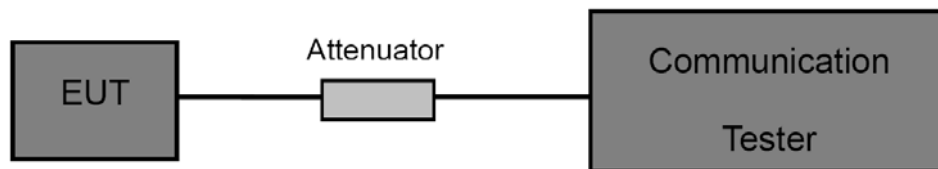

### 5.3 Test Procedure

- (1) The EUT is coupled to the Base Station with the suitable Attenuator, the path loss is calibrated to correct the reading.
- (2) A call is set up by the Base Station to the generic call set up procedure.
- (3) Set EUT at maximum power level through base station by power level command.
- (4) Then read record the power value from the Base Station in dBm.

### 5.4 EUT Operating Condition

The EUT was continuously connected with the Base station and transmitting in the max power during the test.

### 5.5 Test Data

Please refer to the Attachment B.

## 6. Peak-Average Ratio

### 6.1 Test Standard and Limit

#### 6.1.1 Test Standard

FCC Part 24E: 24.232 (d)

#### 6.1.2 Test Limit

### PCS 1900 /UMTS Band II

The peak-to-average ratio (PAR) of the transmission may not exceed 13 dB.

### 6.2 Test Setup

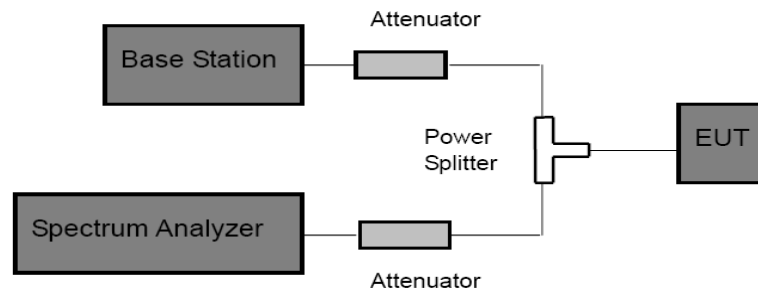

### 6.3 Test Procedure

According with KDB 971168

- (1) The signal analyzer's CCDF measurement profile is enabled.
- (2) Frequency = carrier center frequency.
- (3) Measurement BW > Emission bandwidth of signal.
- (4) The signal analyzer was set to collect one million samples to generate the CCDF curve.
- (5) The measurement interval was set depending on the type of signal analyzed. For continuous signals (>98% duty cycle), the measurement interval was set to 1ms. For burst transmissions, the spectrum analyzer is set to use an internal "RF Burst" trigger that is synced with an incoming pulse and the measurement interval is set to less than the duration of the "on time" of one burst to ensure that energy is only captured during a time in which of the transmitter is operating at maximum power.

### 6.4 EUT Operating Condition

The EUT was continuously connected with the Base station and transmitting in the max power during the test.

### 6.5 Test Data

Please refer to the Attachment C.

# 7. Radiated Output Power

## 7.1 Test Standard and Limit

- 7.1.1 Test Standard
  - FCC Part 22H: 22.913 (a)
  - FCC Part 24E: 24.232 (c)

7.1.2 Test Limit  
 According to FCC Part 22.913 (a), the ERP of Cellular mobile transmitters must not exceed 7 Watts(38.5 dBm).

According to FCC Part 24.232 (c), the Mobile/portable stations are limited to 2 Watts(33 dBm) EIRP peak power.

Cellular Band		PCS Band	
GSM 850	UMTS Band V	PCS 1900	UMTS Band II
38.5 dBm (ERP)		33 dBm (EIRP)	

## 7.2 Test Setup

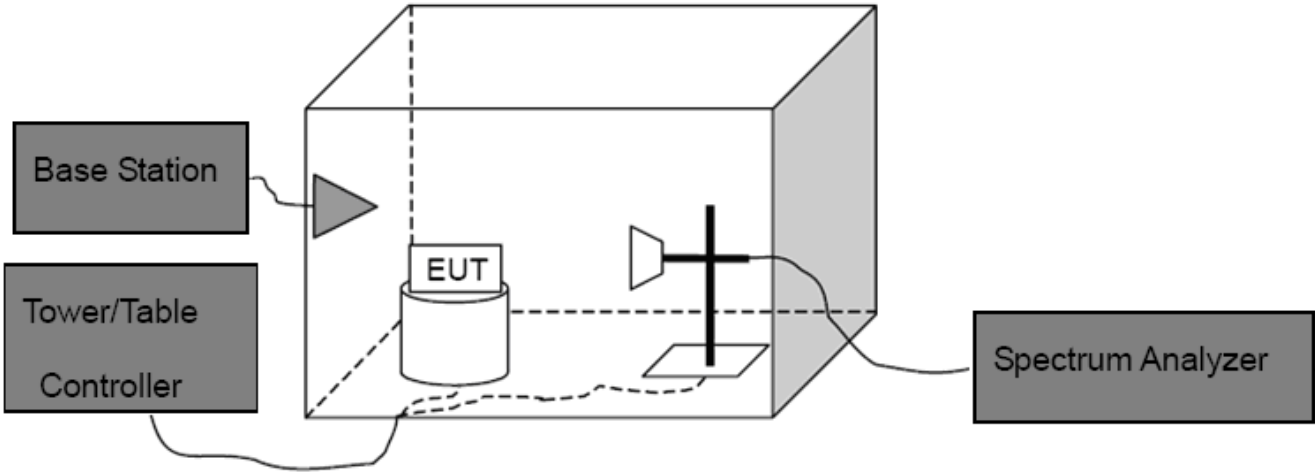

Above 1G

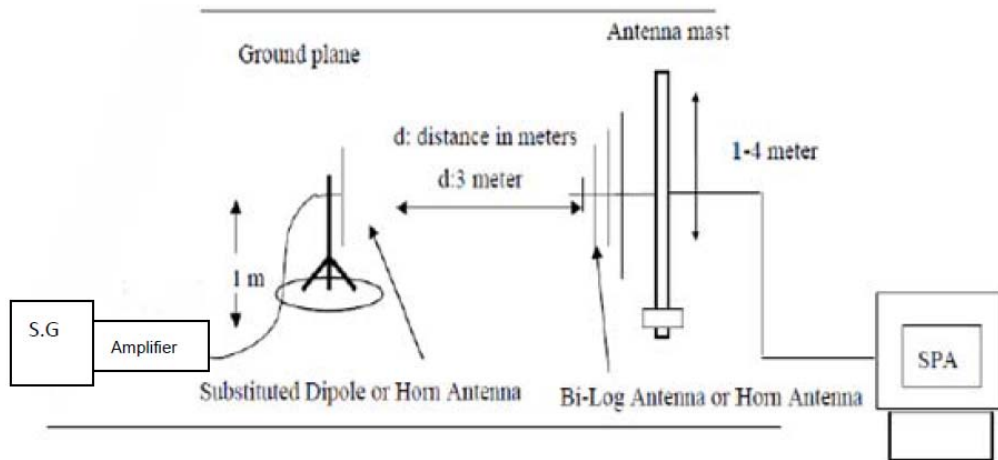

## Substituted Method

### 7.3 Test Procedure

- (1) The EUT was placed on a non-conductive rotating platform with 0.8 meter height in an anechoic chamber. The radiated emission at the fundamental frequency was measured at 3 m with a test antenna and a spectrum analyzer with RBW=3 MHz, VBW=3 MHz and peak detector settings.
- (2) During the measurement, the EUT was enforced in maximum power and linked with the Base Station. The highest was recorded from analyzer power level (LVT) from the 360 degrees rotation of the turntable and the test antenna raised and lowered over a range from 1 to 4 meters in both horizontally and vertically polarized orientations.
- (3) Effective Isotropic Radiated Power (EIRP) was measured by substitution method according to C63.26. The EUT was replaced by dipole antenna (for frequency below 1 GHz) or Horn antenna (for frequency above 1 GHz) at same location with same polarize of receiver antenna and then a known power of each measure frequency from S.G. was applied into the dipole antenna or Horn antenna through a TX cable, and then recorded the maximum Analyzer reading through raised and lowered the test antenna.

**Note:** In test, the S.G. Connect the Pre-amplifier (Sonoma 310N Pre-amplifier for frequency below 1 GHz, HP 8449B Pre-amplifier for frequency above 1 GHz)

Then the EUT's EIRP and ERP was calculated with the correction factor:

$$\text{ERP} = \text{S.G. Level} + \text{Antenna Gain Cord. (dBd)} - \text{Cable Loss (dB)}$$

$$\text{EIRP} = \text{S.G. Level} + \text{Antenna Gain Cord. (dBi)} - \text{Cable Loss (dB)}$$

### 7.4 EUT Operating Condition

The EUT was continuously connected with the Base station and transmitting in the max power during the test.

### 7.5 Test Data

Please refer to the Attachment D.



## 8. Occupied Bandwidth

### 8.1 Test Standard and Limit

#### 8.1.1 Test Standard

FCC Part 2: 2.1049

FCC Part 22H : 22.913 (a)

FCC Part 24E: 24.232 (c)

#### 8.1.2 Test Requirement

According to FCC section 2.1049, the occupied bandwidth is the frequency bandwidth such that below its lower and above its upper frequency limits, the mean powers radiated are each equal to 0.5 percent of the total mean power radiated by a given emission.

Occupied bandwidth is also known as 99% power and -26dBC occupied bandwidths.

### 8.2 Test Setup

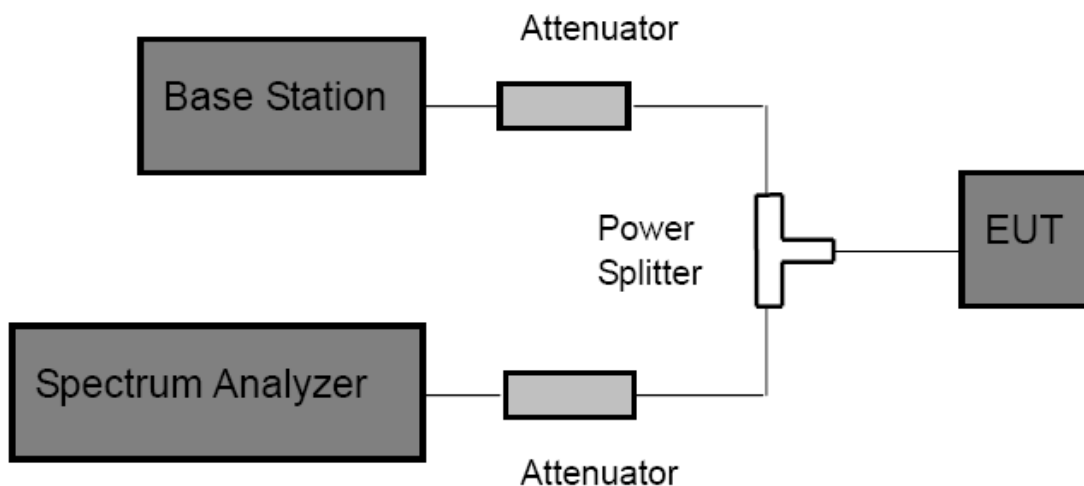

### 8.3 Test Procedure

- (1) The EUT was directly connected to the spectrum analyzer and Base station via power splitter as show in the block diagram above.
- (2) The resolution bandwidth of the Spectrum Analyzer is set to at least 1% of the occupied bandwidth.
- (3) The low, middle and the high channels are selected to perform tests respectively.
- (4) Set the frequency range of the Spectrum Analyzer suitably to capture the waveform; search peak; make a line whose value is 26dB lower than the peak; mark two points which the line intersected the waveform at; finally record the delta of the two points as the occupied bandwidth and the plot.
- (5) Set the Spectrum Analyzer Occupied bandwidth function to measure the 99% occupied bandwidth.

## 8.4 EUT Operating Condition

The EUT was continuously connected with the Base station and transmitting in the max power during the test.

## 8.5 Test Data

Please refer to the Attachment E.

## 9. Conducted Out of Band Emissions

### 9.1 Test Standard and Limit

#### 9.1.1 Test Standard

FCC Part 2: 2.1051, 2.1057

FCC Part 22H: 22.917(a)

FCC Part 24E: 24.238(a)

#### 9.1.2 Test Limit

The power of any emission outside of the authorized operating frequency ranges must be attenuated below the transmitting power(P) by a factor of at least  $43+10\log(P)$  dB. For all power levels +30 dBm to 0 dBm, this becomes a constant specification limit of -13 dBm.

### 9.2 Test Setup

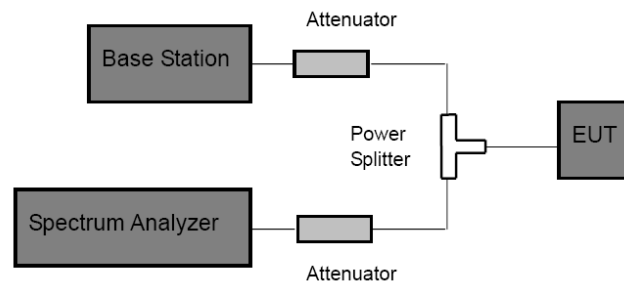

### 9.3 Test Procedure

- (1) The EUT was directly connected to the spectrum analyzer and Base station via power splitter as show in the block diagram above.
- (2) Spectrum Setting:  
Frequency bellow 1 GHz: RBW=100 kHz, VBW=300 kHz.  
Frequency above 1 GHz: RBW=1 MHz, VBW=3 MHz.
- (3) The low, middle and high channels of each band and mode's spurious emissions for 30 MHz to 10<sup>th</sup> Harmonic were measured by Spectrum analyzer.

### 9.4 EUT Operating Condition

The EUT was continuously connected with the Base station and transmitting in the max power during the test.

### 9.5 Test Data

Please refer to the Attachment F.

## 10. Band Edge Test

### 10.1 Test Standard and Limit

#### 10.1.1 Test Standard

FCC Part 2: 2.1051, 2.1057

FCC Part 22H: 22.917(a)

FCC Part 24E: 24.238(a)

#### 10.1.2 Test Limit

The power of any emission outside of the authorized operating frequency ranges must be attenuated below the transmitting power(P) by a factor of at least  $43+10\log(P)$  dB. For all power levels +30 dBm to 0 dBm, this becomes a constant specification limit of -13 dBm.

### 10.2 Test Setup

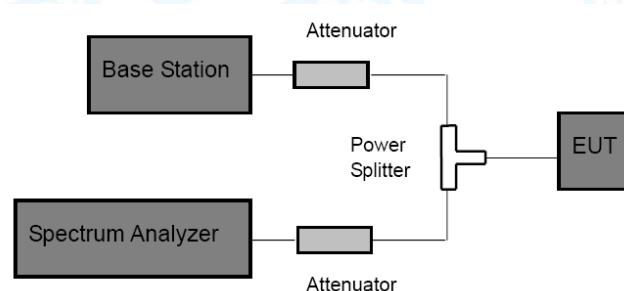

### 10.3 Test Procedure

(1) The EUT was directly connected to the spectrum analyzer and Base station via power splitter as show in the block diagram above.

(2) Spectrum Setting:

GSM and PCS:  $RBW \geq 1\%$  26db bandwidth,  $VBW=3$  RBW, Span 1 MHz, Detector: Peak Mode.

WCDMA:  $RBW \geq 1\%$  26db bandwidth,  $VBW=3$  RBW, Span 10 MHz, Detector: Peak Mode.

(3) The band edges of low and high channels for the highest RF powers were measured.

### 10.4 EUT Operating Condition

The EUT was continuously connected with the Base station and transmitting in the max power during the test.

### 10.5 Test Data

Please refer to the Attachment G.

## 11. Radiated Out Band of Emissions

### 11.1 Test Standard and Limit

#### 11.1.1 Test Standard

FCC Part 2: 2.1053, 2.1057

FCC Part 22H: 22.917

FCC Part 24E: 24.238

#### 11.1.2 Test Limit

The power of any emission outside of the authorized operating frequency ranges must be attenuated below the transmitting power(P) by a factor of at least  $43+10\log(P)$  dB. For all power levels +30 dBm to 0 dBm, this becomes a constant specification limit of -13 dBm.

### 11.2 Test Setup

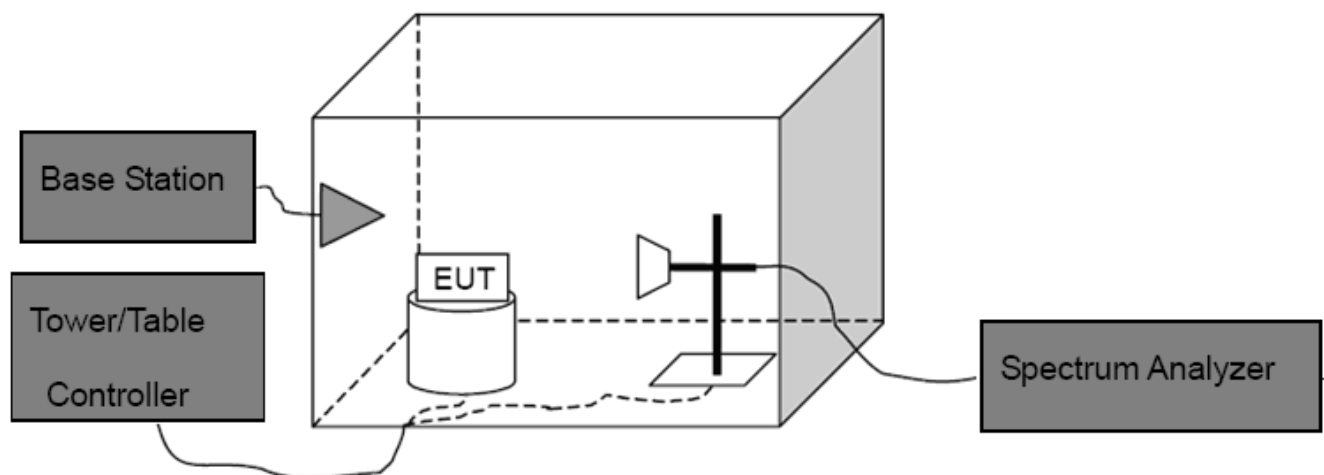

### 11.3 Test Procedure

- (1) The test system setup as show in the block diagram above.
- (2) The EUT was placed on an non-conductive rotating platform in an anechoic chamber. The radiated spurious emissions from 30MHz to 10<sup>th</sup> harmonious of fundamental frequency were measured at 3 m with a test antenna and a spectrum analyzer with RBW=1 MHz, VBW=1 MHz, peak detector settings.
- (3) During the measurement, the EUT was enforced in maximum power and linked with a base station. All the spurious emissions at 3m were measured by rotation of the turntable and the test antenna raised and lowered over a range from 1 to 4 meters in both horizontally and vertically polarized orientations.
- (4) When found the maximum level of emissions from the EUT. Remove the EUT and replace it with substitution antenna. A signal generator was connected to the substitution antenna by a non-radiating cable. The absolute levels of the spurious emissions were measured by the substitution.

Spurious emissions in dB=10 log(TX power in Watts/0.001)-the absolute level  
Spurious attenuation limit in dB=43+10 log(power out in Watts)

#### 11.4 EUT Operating Condition

The EUT was continuously connected with the Base station and transmitting in the max power during the test.

#### 11.5 Test Data

Please refer to the Attachment H.

## Attachment A--Frequency Stability

### Temperature Variation

Temperature Variation UMTS Band V (CH 4183)		
Temperature (°C)	HSDPA Mode	
	Freq. Dev. (Hz)	Deviation (ppm)
-30	19	0.023
-20	15	0.018
-10	18	0.022
0	16	0.019
10	17	0.020
20	15	0.018
30	19	0.023
40	16	0.019
50	20	0.024
60	21	0.025
<b>Limit</b>	<b>2.5 (ppm)</b>	
<b>Result</b>	<b>PASS</b>	

Temperature Variation UMTS Band II (CH 9400)		
Temperature (°C)	HSDPA Mode	
	Freq. Dev. (Hz)	Deviation (ppm)
-30	21	0.011
-20	16	0.009
-10	20	0.011
0	19	0.010
10	23	0.012
20	17	0.009
30	19	0.010
40	22	0.012
50	20	0.011
60	14	0.007
<b>Limit</b>	<b>2.5 (ppm)</b>	
<b>Result</b>	<b>PASS</b>	

### Voltage Variation

Voltage Variation UMTS Band V (CH 4182)		
Voltage (V)	HSDPA Mode	
	Freq. Dev. (Hz)	Deviation (ppm)
DC 6.8	22	0.026
DC 7.6	24	0.029
DC 7.8	23	0.027
<b>Limit</b>	<b>2.5 (ppm)</b>	
<b>Result</b>	<b>PASS</b>	

Voltage Variation UMTS Band II (CH 9400)		
Voltage (V)	HSDPA Mode	
	Freq. Dev. (Hz)	Deviation (ppm)
DC 6.8	25	0.013
DC 7.6	24	0.013
DC 7.8	20	0.011
<b>Limit</b>	<b>2.5 (ppm)</b>	
<b>Result</b>	<b>PASS</b>	



## Attachment B--Conducted RF Output Power

UMTS Band V				
Mode	Channel	Frequency (MHz)	Conducted Power (dBm)	Conducted Power (W)
HSDPA Subtest 1	4132	826.4	21.85	0.153
	4183	836.6	21.96	0.157
	4233	846.6	21.97	0.157
HSDPA Subtest 2	4132	826.4	21.24	0.133
	4183	836.6	21.17	0.131
	4233	846.6	21.25	0.133
HSDPA Subtest 3	4132	826.4	20.69	0.117
	4183	836.6	20.77	0.119
	4233	846.6	20.85	0.122
HSDPA Subtest 4	4132	826.4	20.16	0.104
	4183	836.6	20.33	0.108
	4233	846.6	20.41	0.110
HSUPA Subtest 1	4132	826.4	21.31	0.135
	4183	836.6	21.40	0.138
	4233	846.6	21.46	0.140
HSUPA Subtest 2	4132	826.4	21.05	0.127
	4183	836.6	21.16	0.131
	4233	846.6	21.08	0.128
HSUPA Subtest 3	4132	826.4	20.96	0.125
	4183	836.6	20.84	0.121
	4233	846.6	20.72	0.118
HSUPA Subtest 4	4132	826.4	20.16	0.104
	4183	836.6	20.08	0.102
	4233	846.6	20.15	0.104
HSUPA Subtest 5	4132	826.4	19.98	0.100
	4183	836.6	19.74	0.094
	4233	846.6	19.84	0.096

UMTS Band II				
Mode	Channel	Frequency (MHz)	Conducted Power (dBm)	Conducted Power (W)
HSDPA Subtest 1	9262	1852.4	22.16	0.164
	9400	1880.0	22.00	0.158
	9538	1907.6	21.87	0.154
HSDPA Subtest 2	9262	1852.4	21.23	0.133
	9400	1880.0	21.16	0.131
	9538	1907.6	21.09	0.129
HSDPA Subtest 3	9262	1852.4	20.56	0.114
	9400	1880.0	20.65	0.116
	9538	1907.6	20.72	0.118
HSDPA Subtest 4	9262	1852.4	20.15	0.104
	9400	1880.0	20.23	0.105
	9538	1907.6	20.08	0.102
HSUPA Subtest 1	9262	1852.4	22.55	0.180
	9400	1880.0	22.45	0.176
	9538	1907.6	22.42	0.175
HSUPA Subtest 2	9262	1852.4	21.84	0.153
	9400	1880.0	21.76	0.150
	9538	1907.6	21.87	0.154
HSUPA Subtest 3	9262	1852.4	21.06	0.128
	9400	1880.0	21.11	0.129
	9538	1907.6	21.29	0.135
HSUPA Subtest 4	9262	1852.4	20.85	0.122
	9400	1880.0	20.95	0.124
	9538	1907.6	20.87	0.122
HSUPA Subtest 5	9262	1852.4	20.24	0.106
	9400	1880.0	20.14	0.103
	9538	1907.6	20.54	0.113

### Attachment C--Peak-Average Ratio

UMTS Band II			
Mode	Channel	Frequency (MHz)	Peak-Average Ratio (PAR)
UMTS Band II	9262	1852.4	3.96
	9400	1880.0	3.92
	9538	1907.6	3.68
			Limit ≤ 13dB

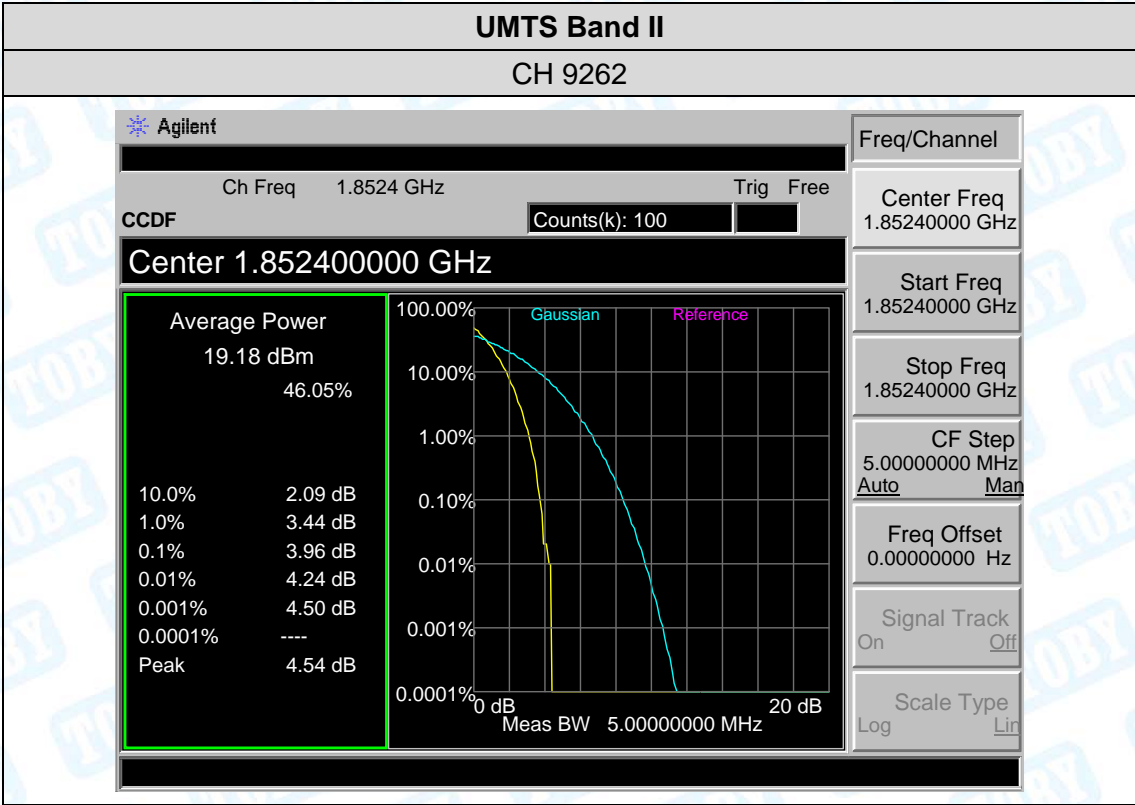

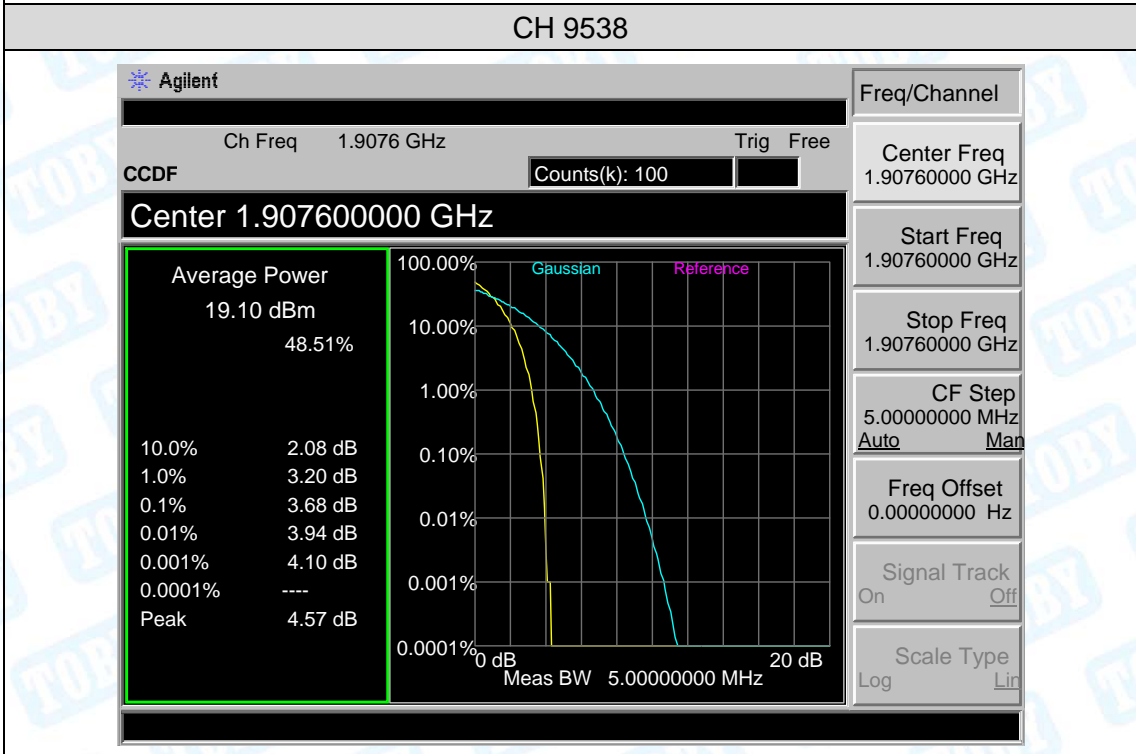
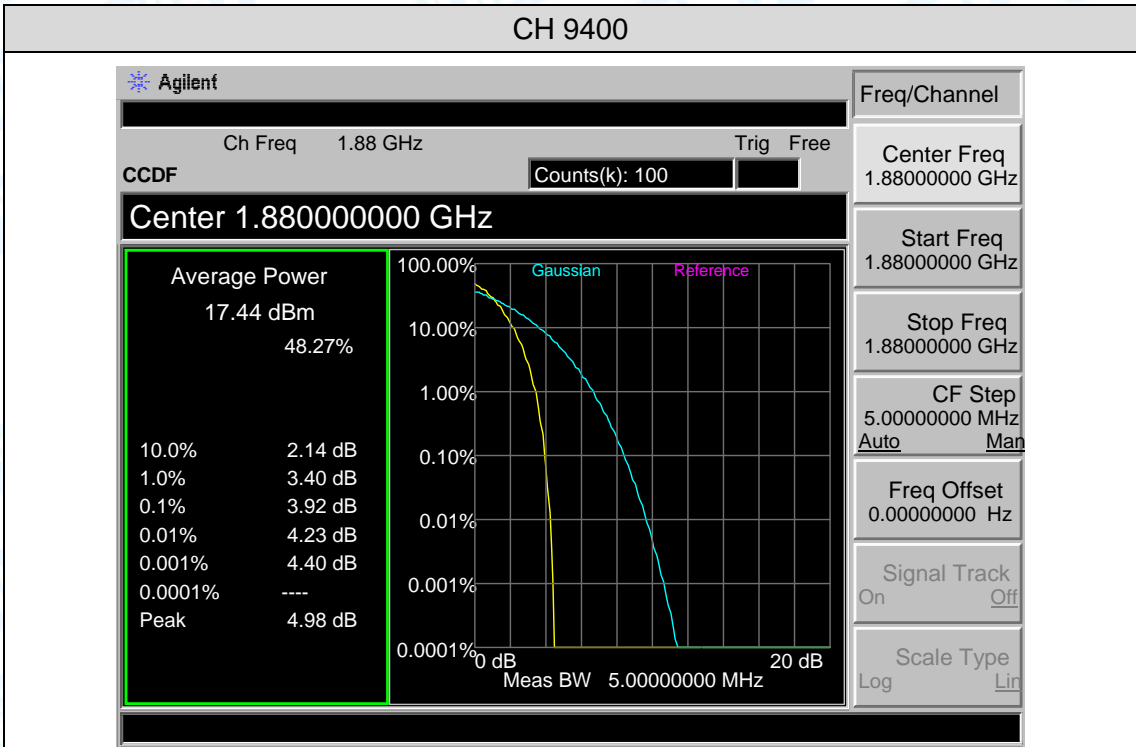

## Attachment D-- Radiated Output Power

Measurement Data (worst case)

UMTS Band V								
Mode	Channel	Frequency (MHz)	Antenna (H&V)	SG Level (dBm)	Antenna Factor (dBi)	Cable Loss (dB)	ERP Power (dBm)	ERP Power (W)
Band V HSDPA	4132	826.4	H	19.05	3.46	1.26	21.25	0.1334
			V	17.05	3.46	1.26	19.25	0.0841
	4183	836.6	H	18.40	3.82	1.26	20.96	0.1247
			V	15.80	3.82	1.26	18.36	0.0685
	4233	846.6	H	18.35	4.16	1.26	21.25	0.1334
			V	15.79	4.16	1.26	18.69	0.0740
<b>Limit</b>							<b>38.5</b>	<b>7</b>

UMTS Band II								
Mode	Channel	Frequency (MHz)	Antenna (H&V)	SG Level (dBm)	Antenna Factor (dBi)	Cable Loss (dB)	EIRP Power (dBm)	EIRP Power (W)
Band II HSDPA	9262	1852.4	H	19.16	5.01	2.59	21.58	0.1439
			V	15.83	5.01	2.59	18.25	0.0668
	9400	1880.0	H	18.65	4.82	2.59	20.88	0.1225
			V	16.01	4.82	2.59	18.24	0.0667
	9538	1907.6	H	19.42	4.45	2.59	21.28	0.1343
			V	17.18	4.45	2.59	19.04	0.0802
<b>Limit</b>							<b>33</b>	<b>2</b>

## Attachment E--Occupied Bandwidth

UMTS Band V				
Mode	Channel	Frequency (MHz)	99% OBW (MHz)	-26dB Bandwidth (MHz)
Band V HSDPA	4132	826.4	4.1289	4.684
	4183	836.6	4.1390	4.751
	4233	846.6	4.1121	4.747
Band V HSUPA	4132	826.4	4.1669	4.749
	4183	836.6	4.1175	4.660
	4233	846.6	4.1341	4.709
UMTS Band II				
Mode	Channel	Frequency (MHz)	99% OBW (MHz)	-26dB Bandwidth (MHz)
Band II HSDPA	9262	1852.4	4.1508	4.730
	9400	1880.0	4.1685	4.746
	9538	1907.6	4.1341	4.745
Band II HSUPA	9262	1852.4	4.1553	4.753
	9400	1880.0	4.1440	4.769
	9538	1907.6	4.1811	4.780

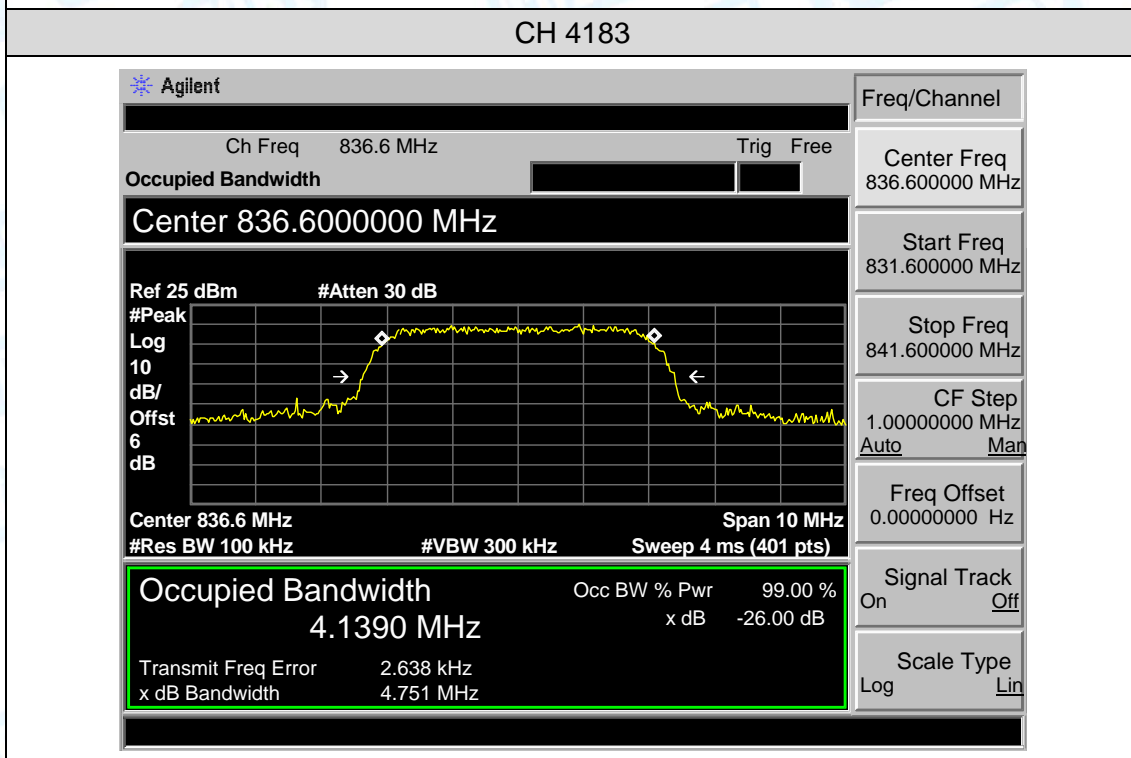
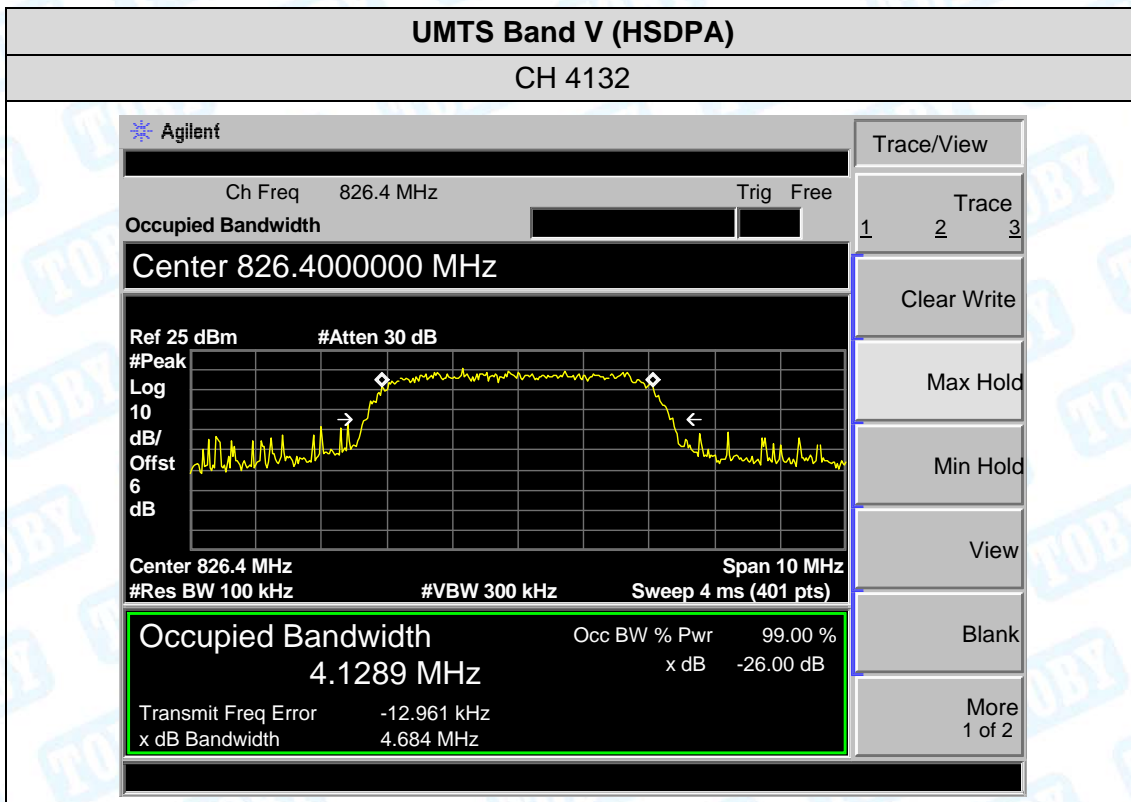

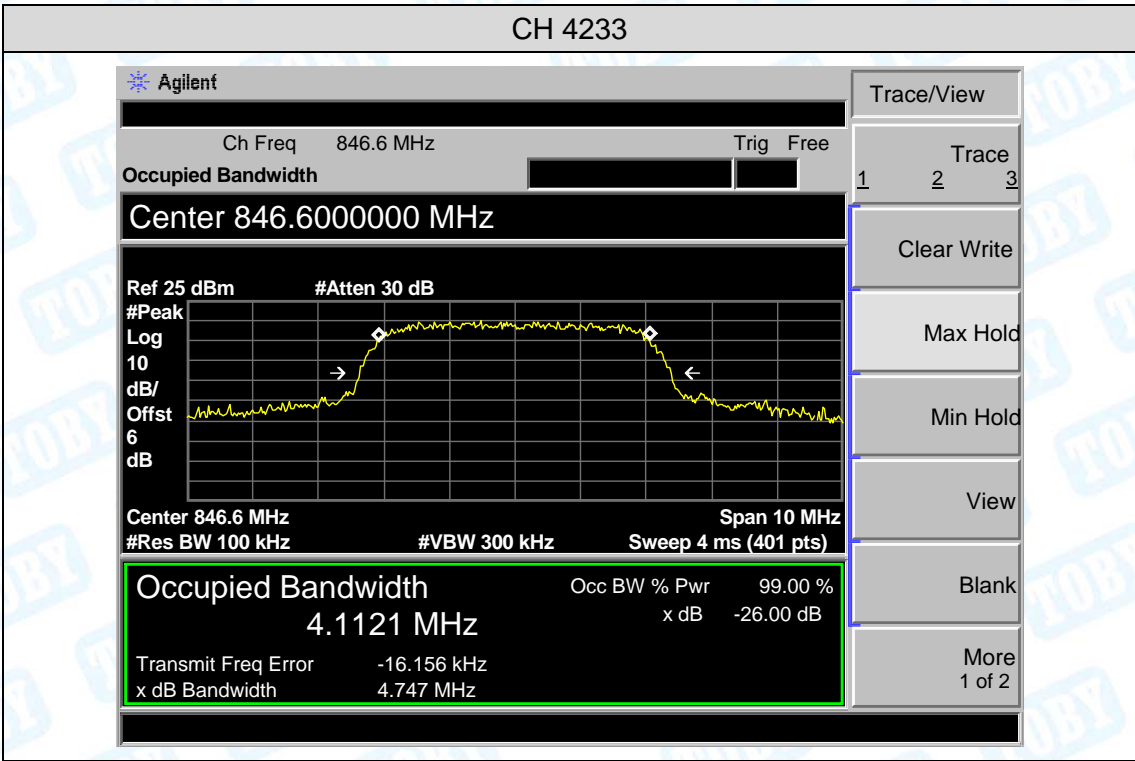



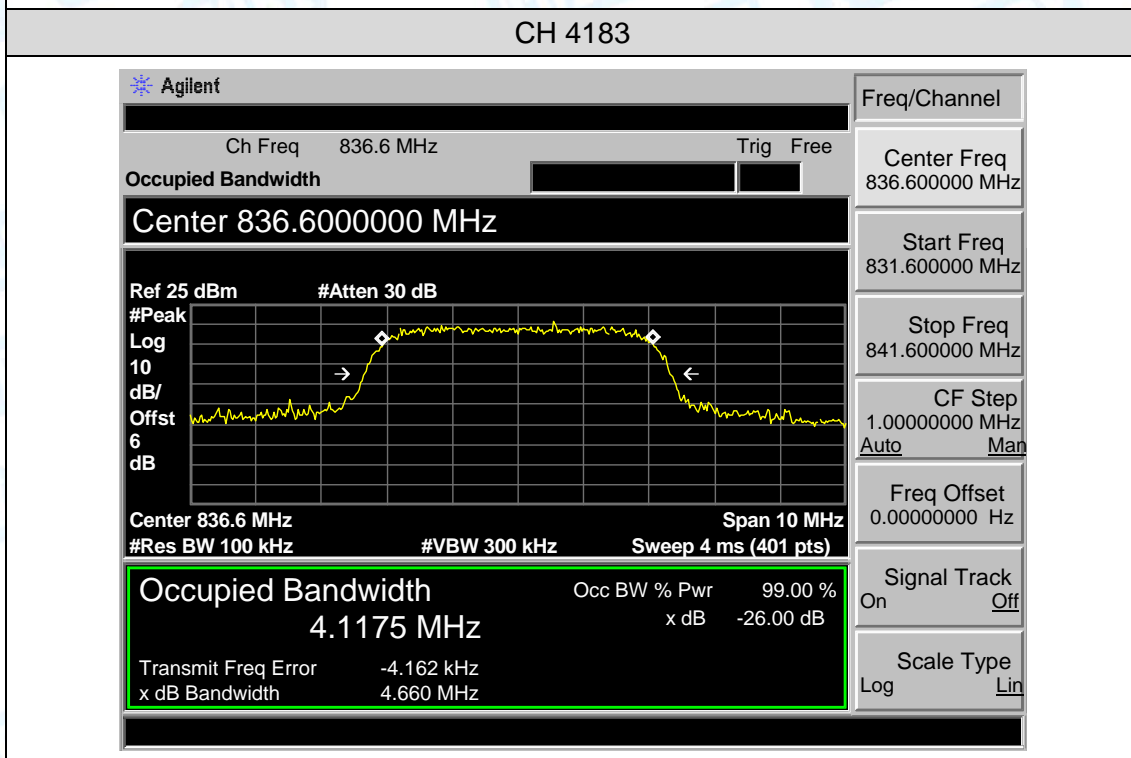
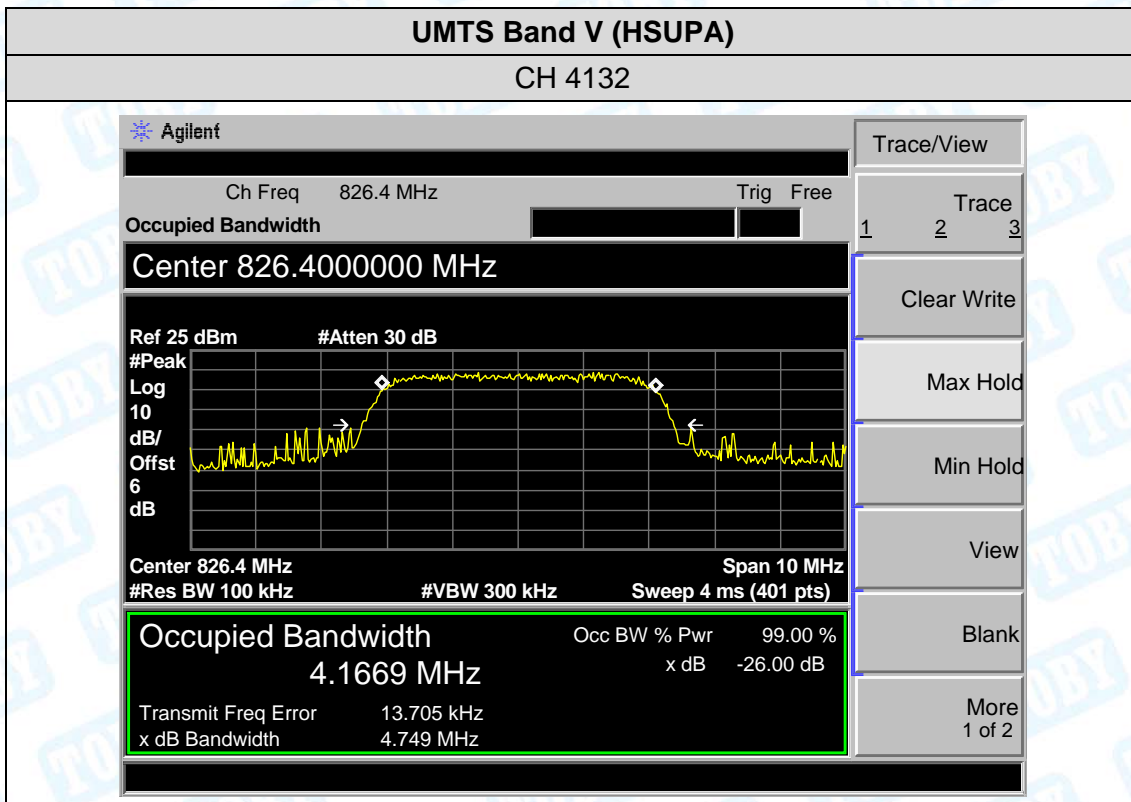

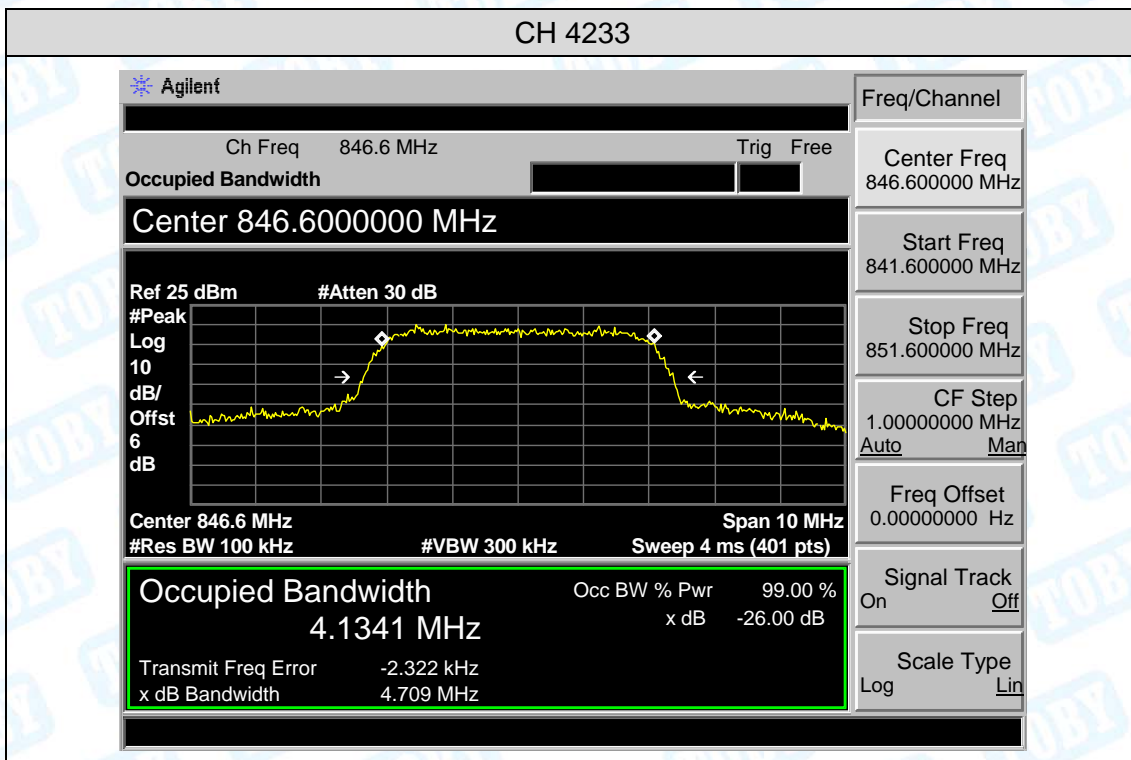

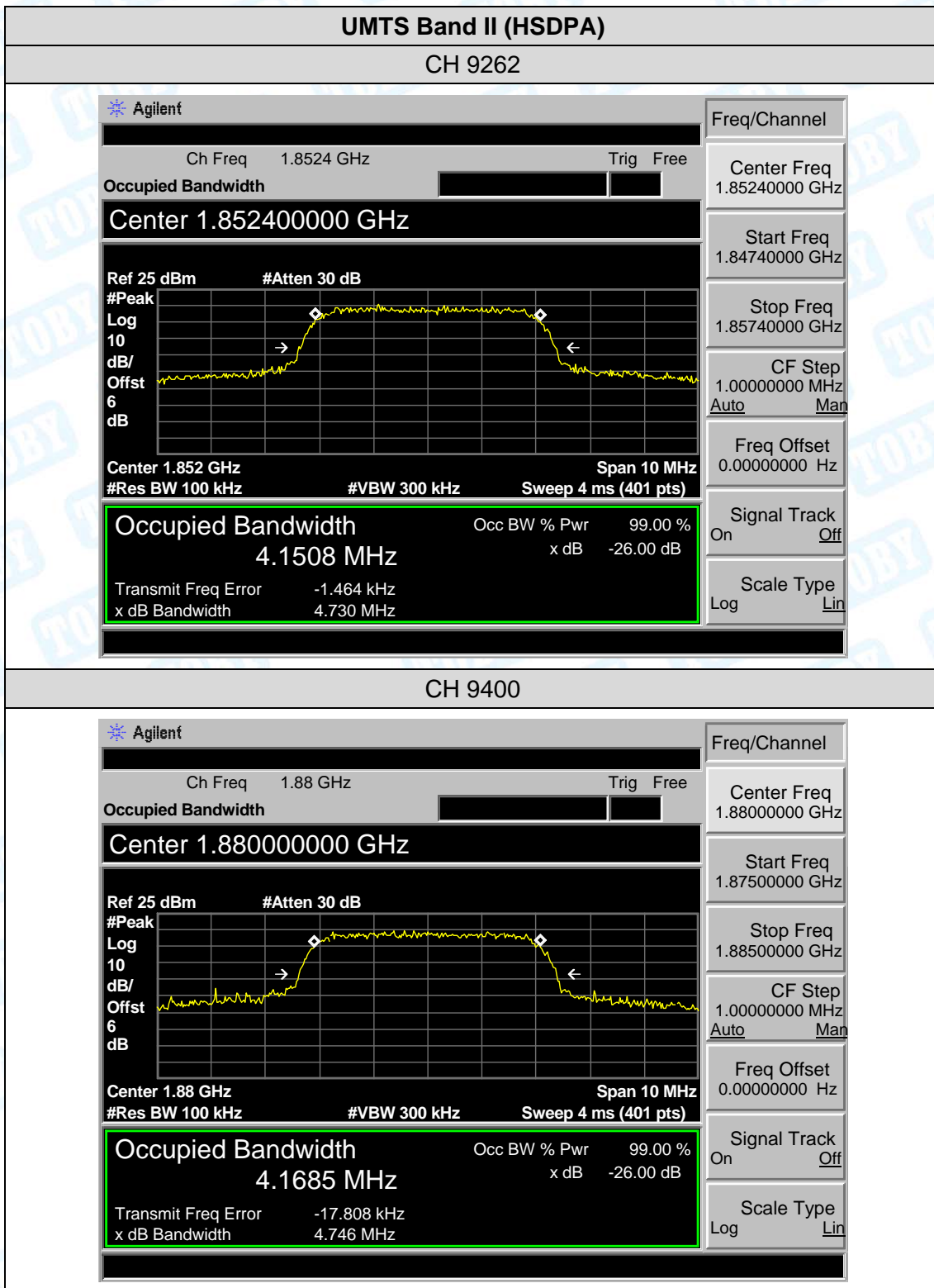

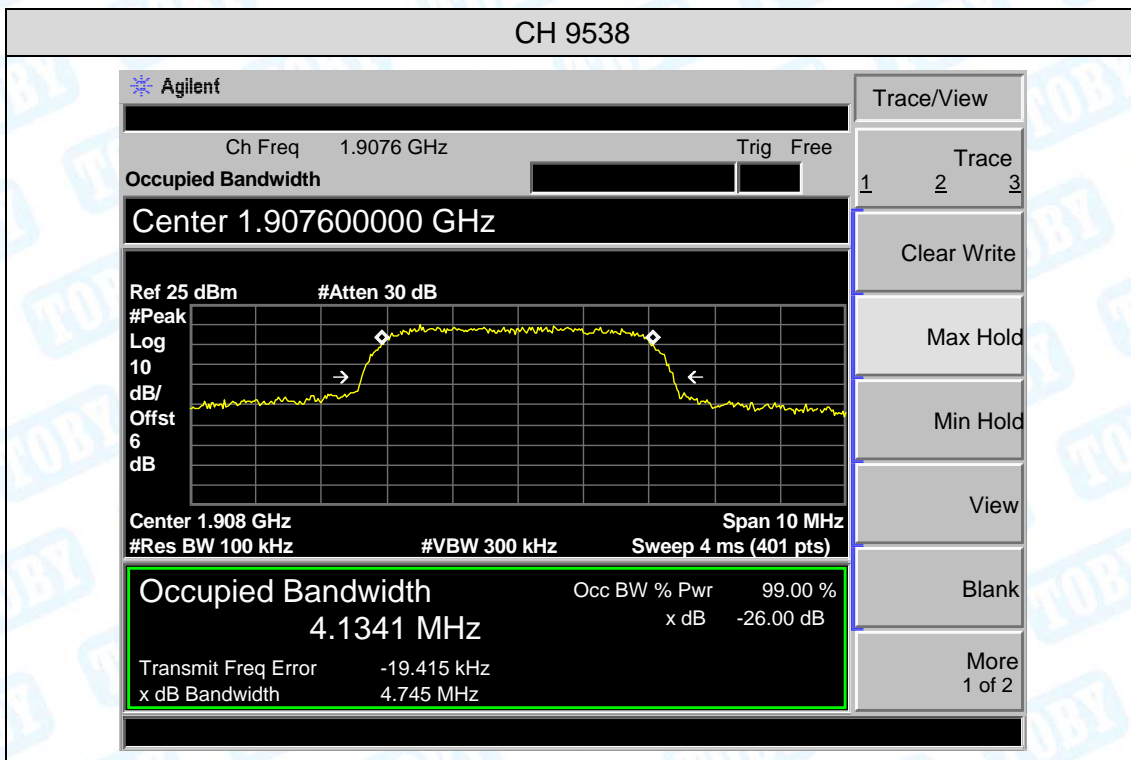

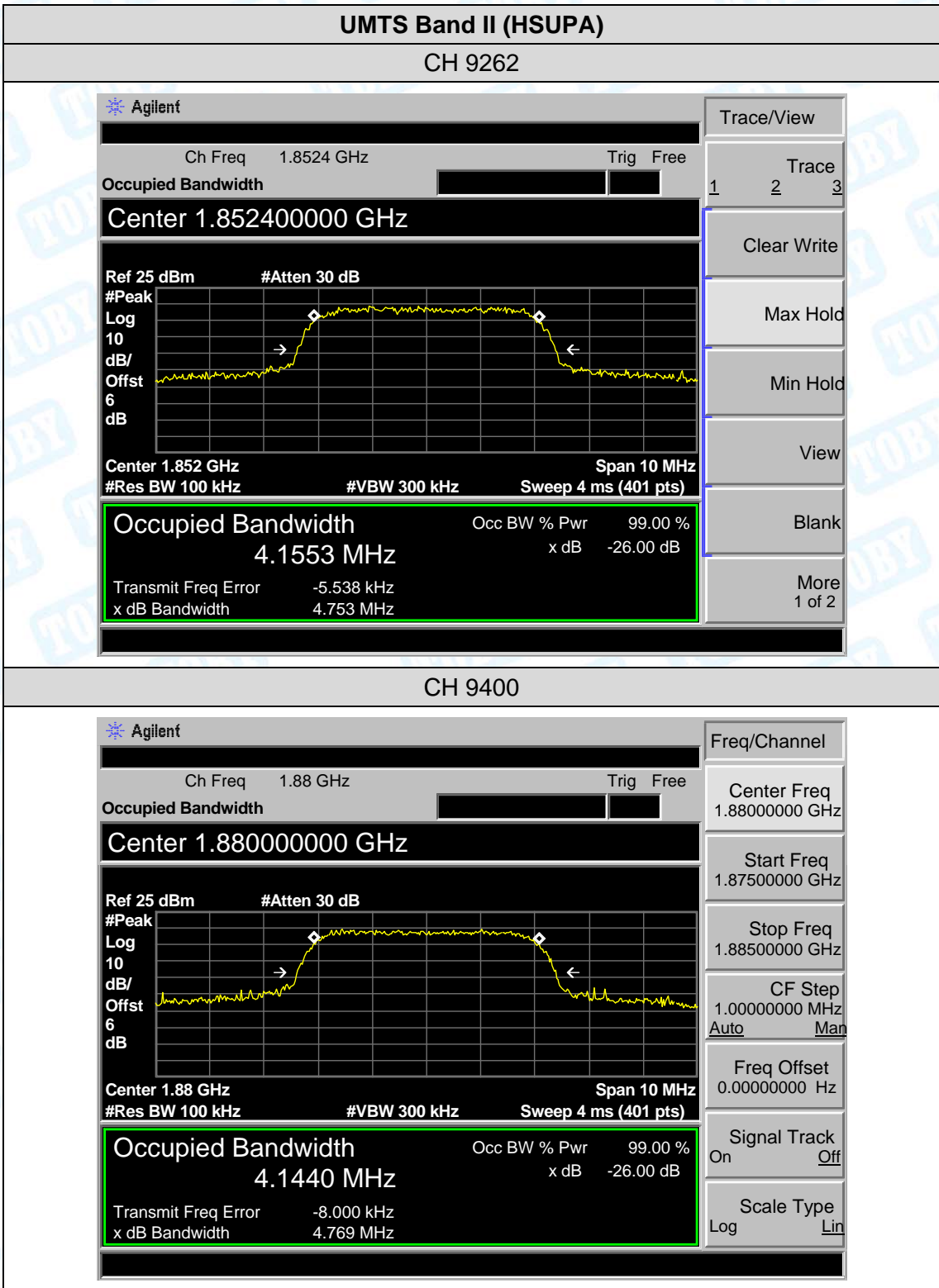

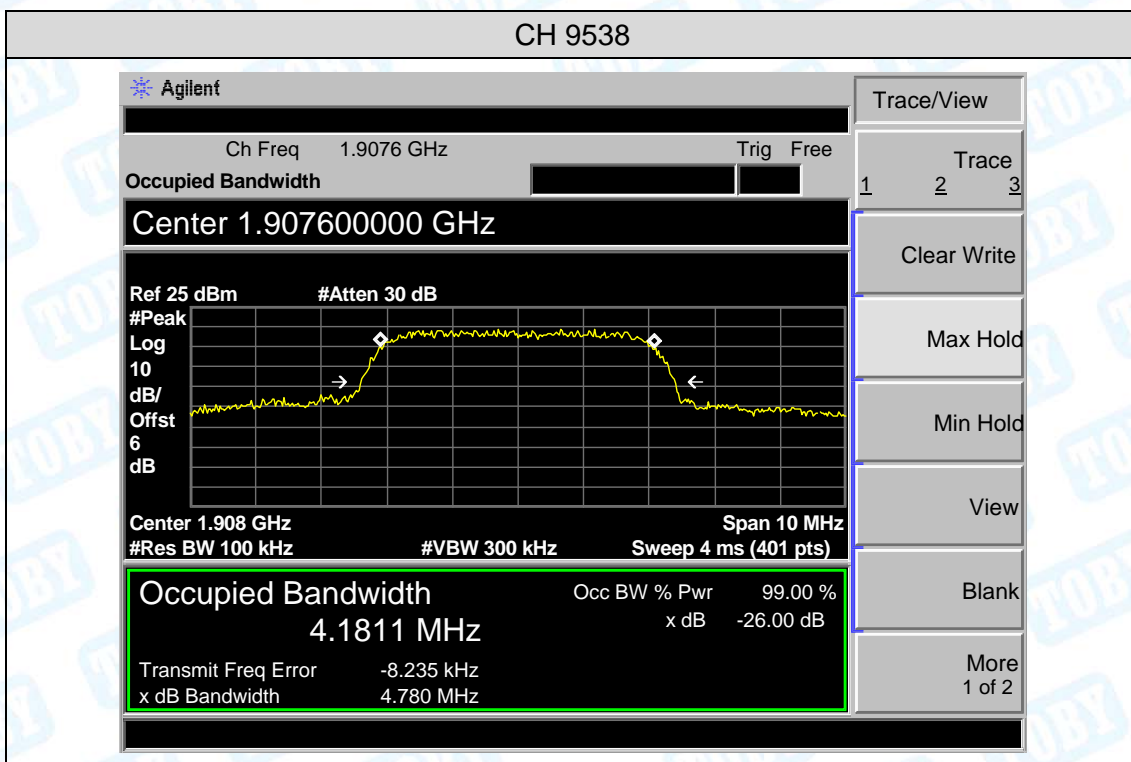

## Attachment F--Conducted Out of Band Emissions

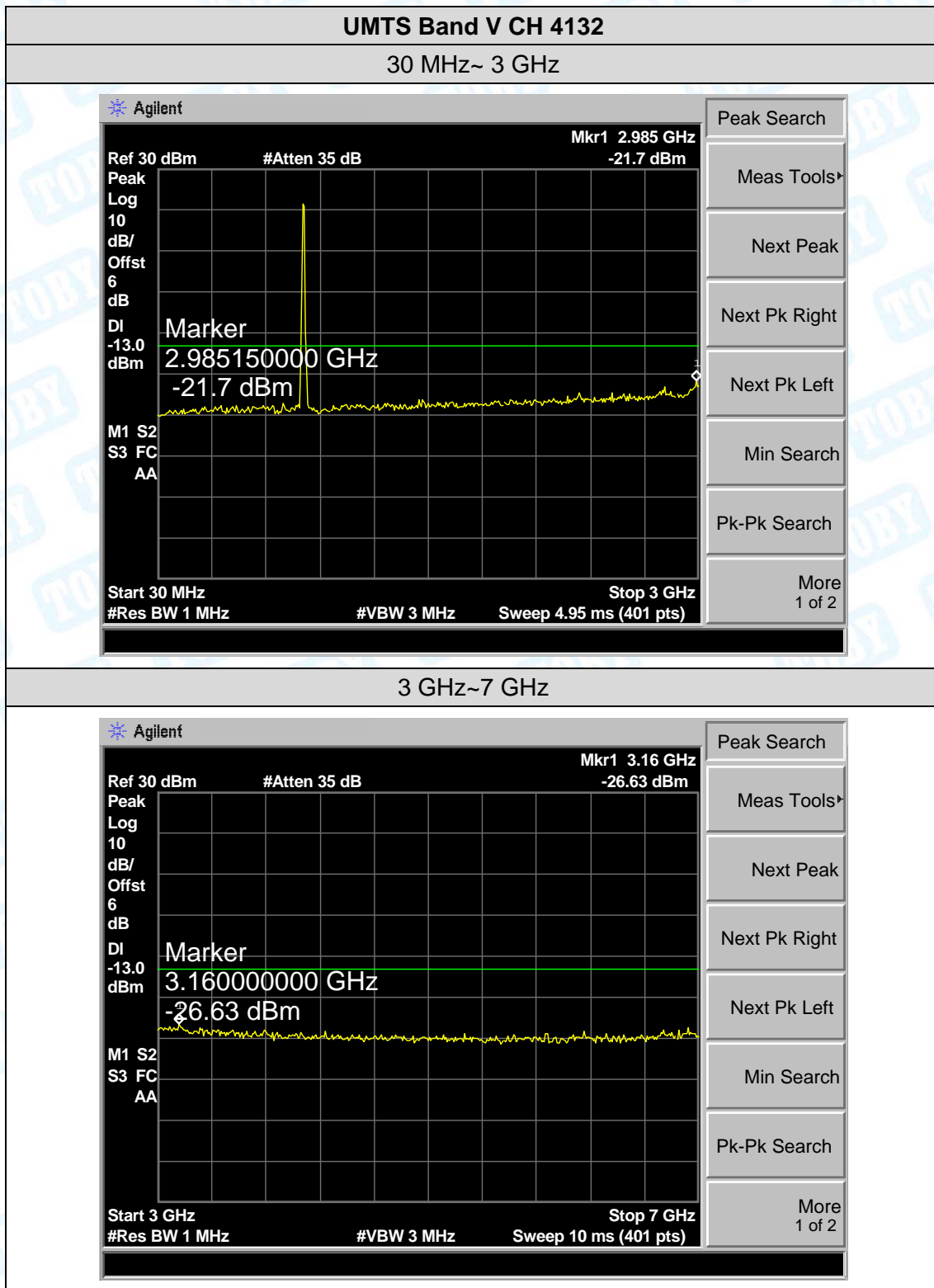

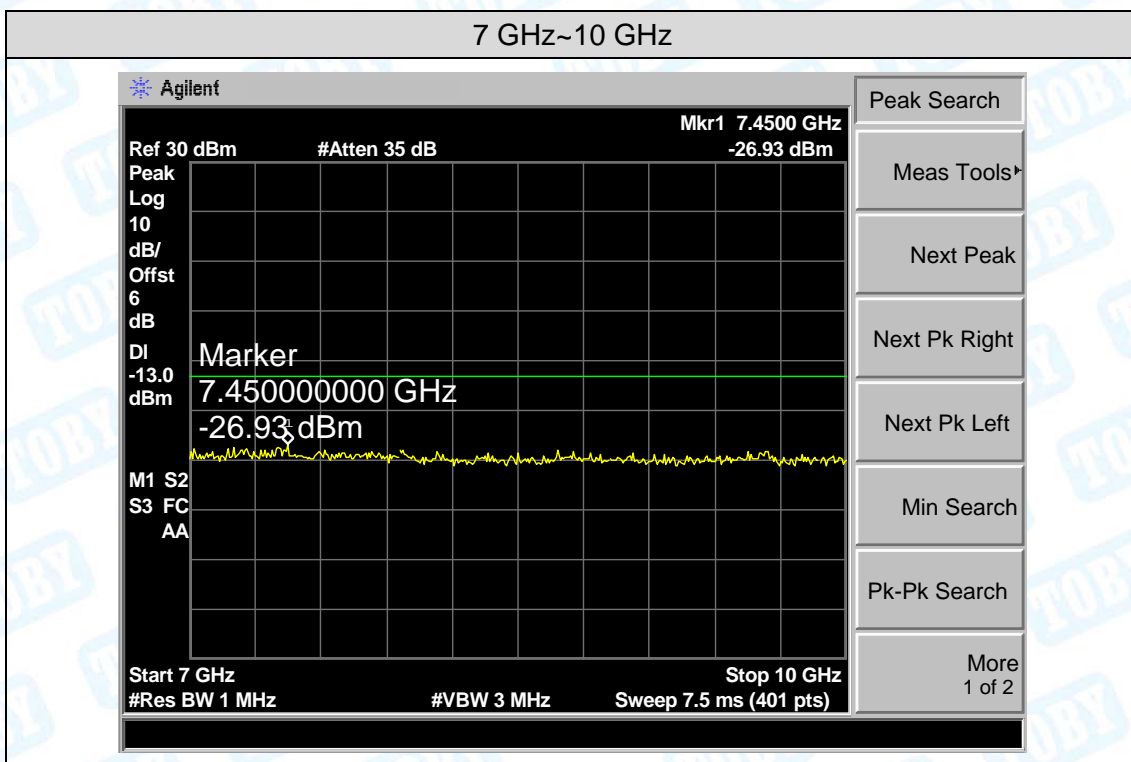



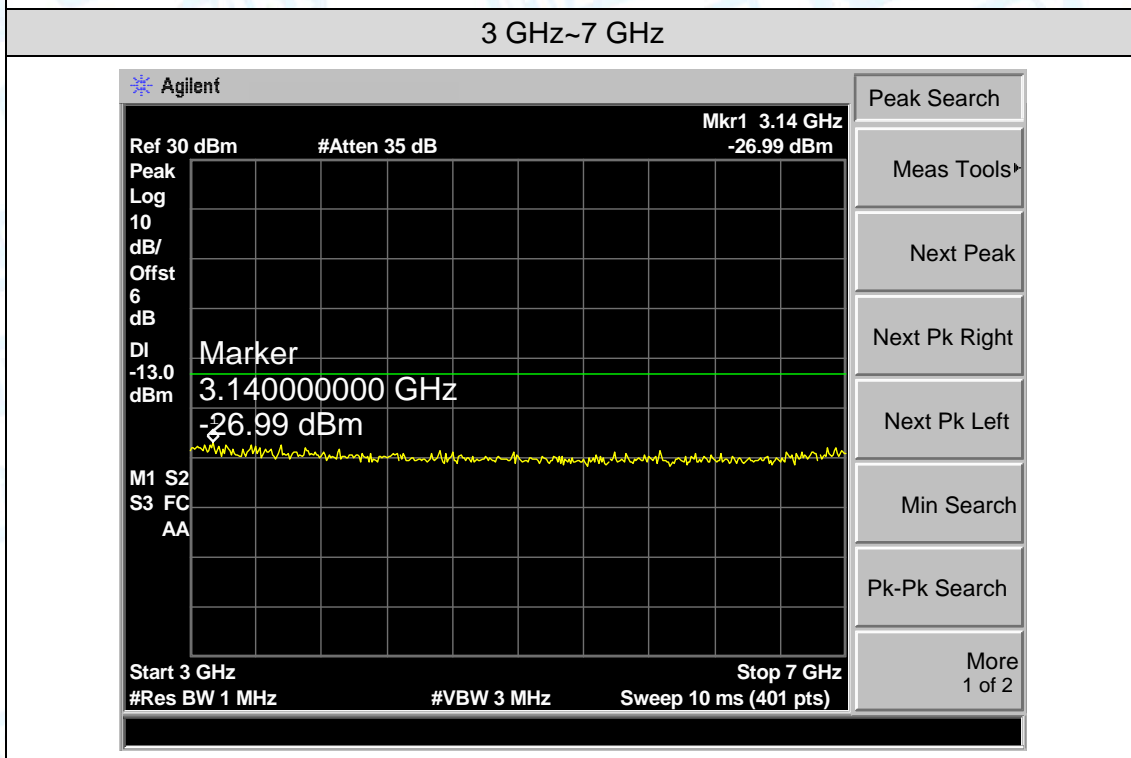
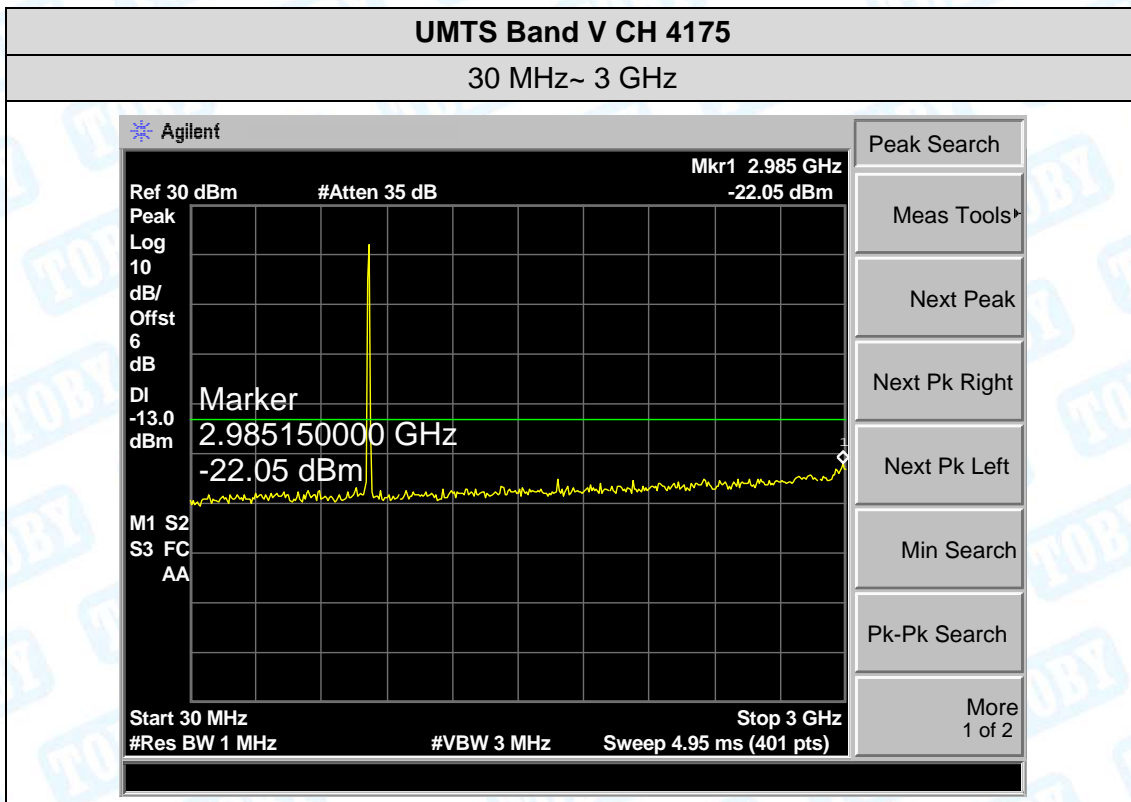

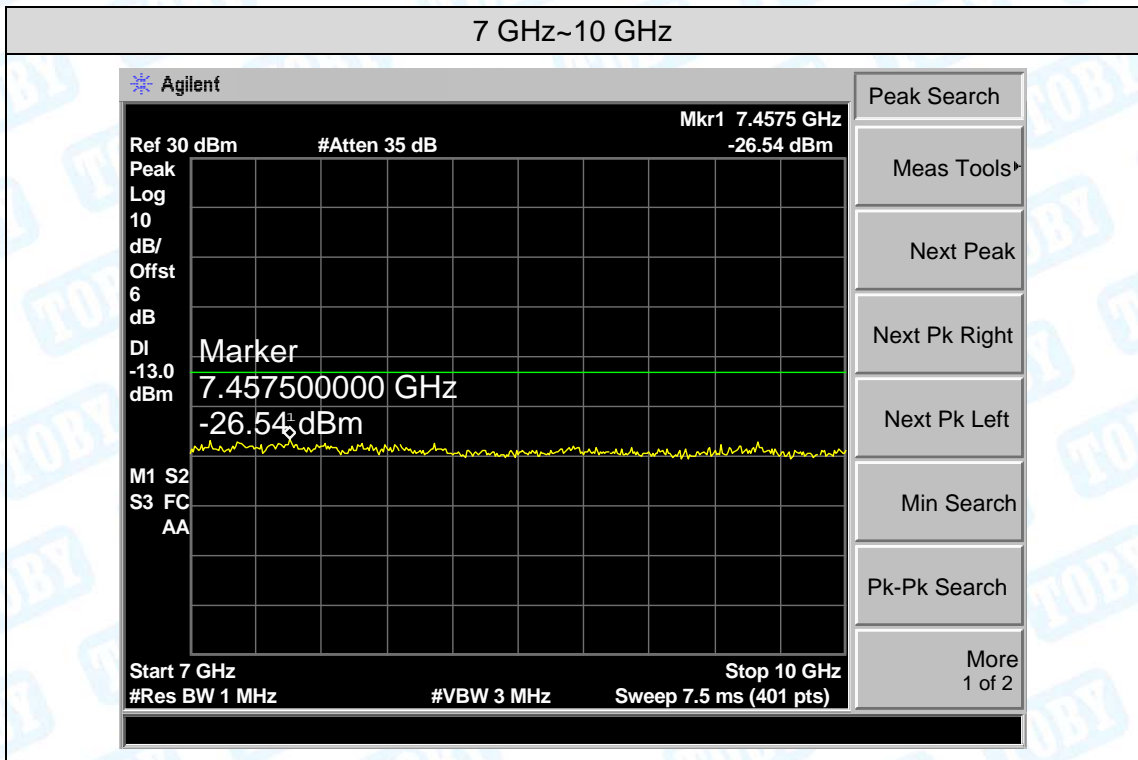

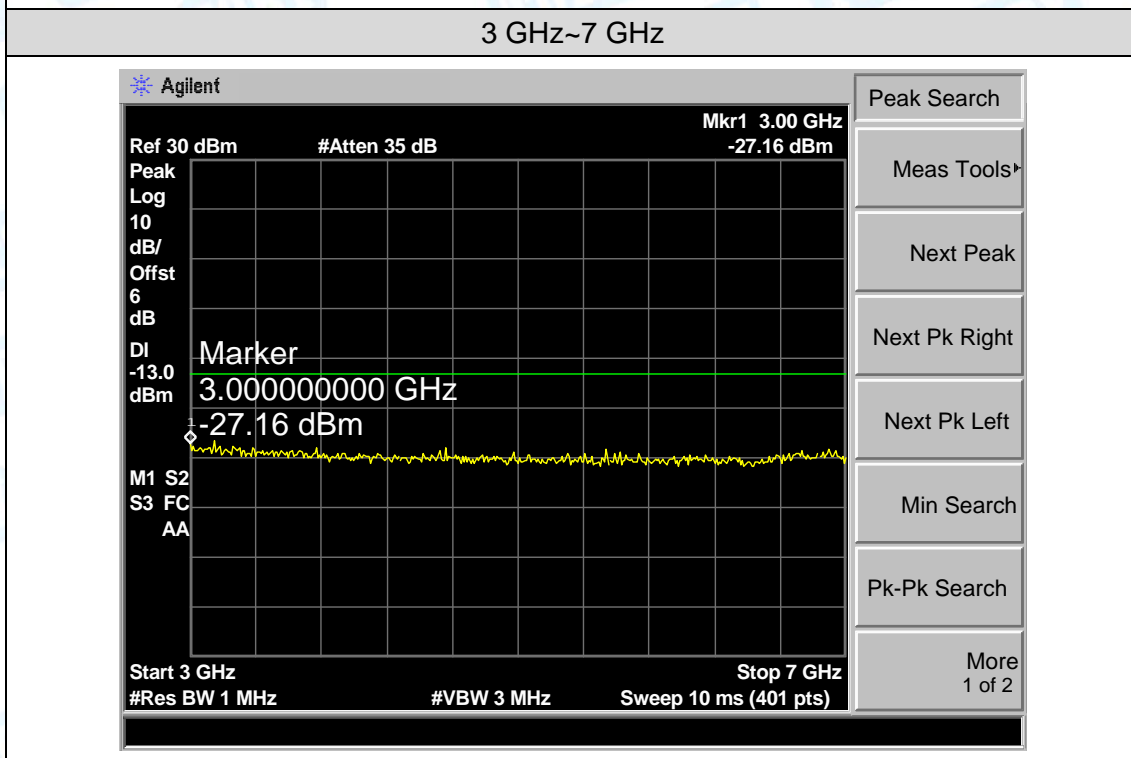
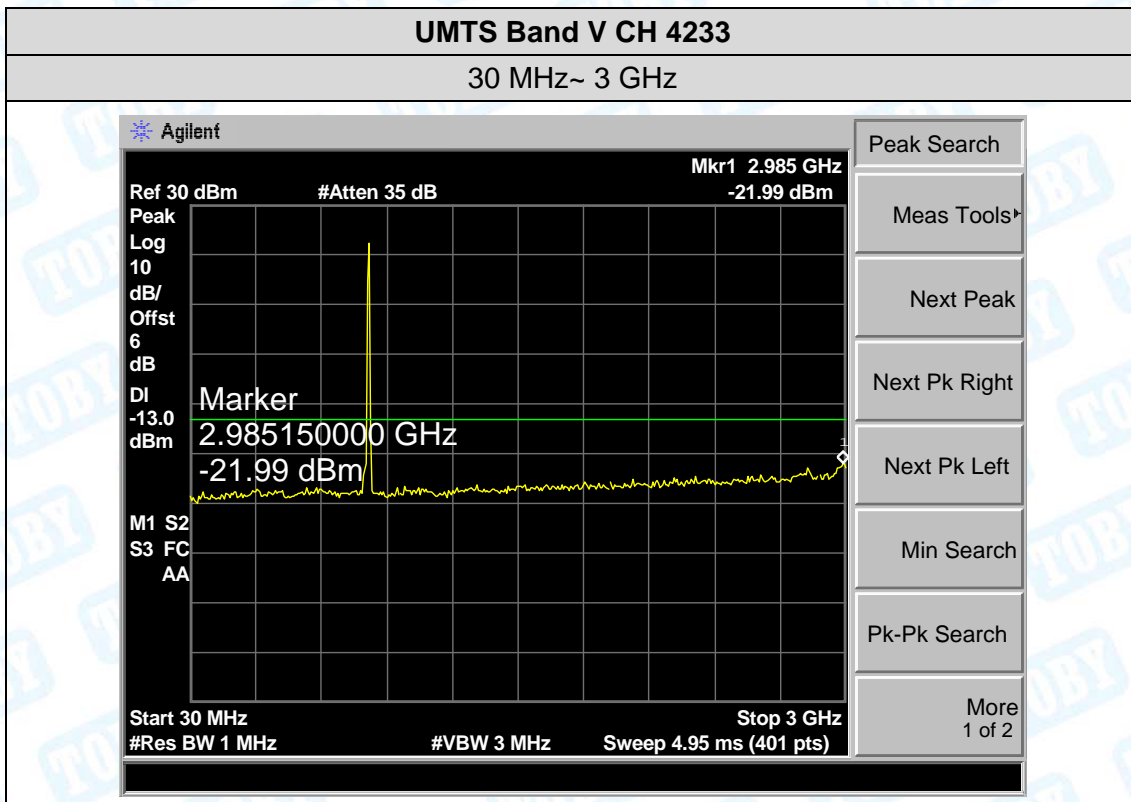

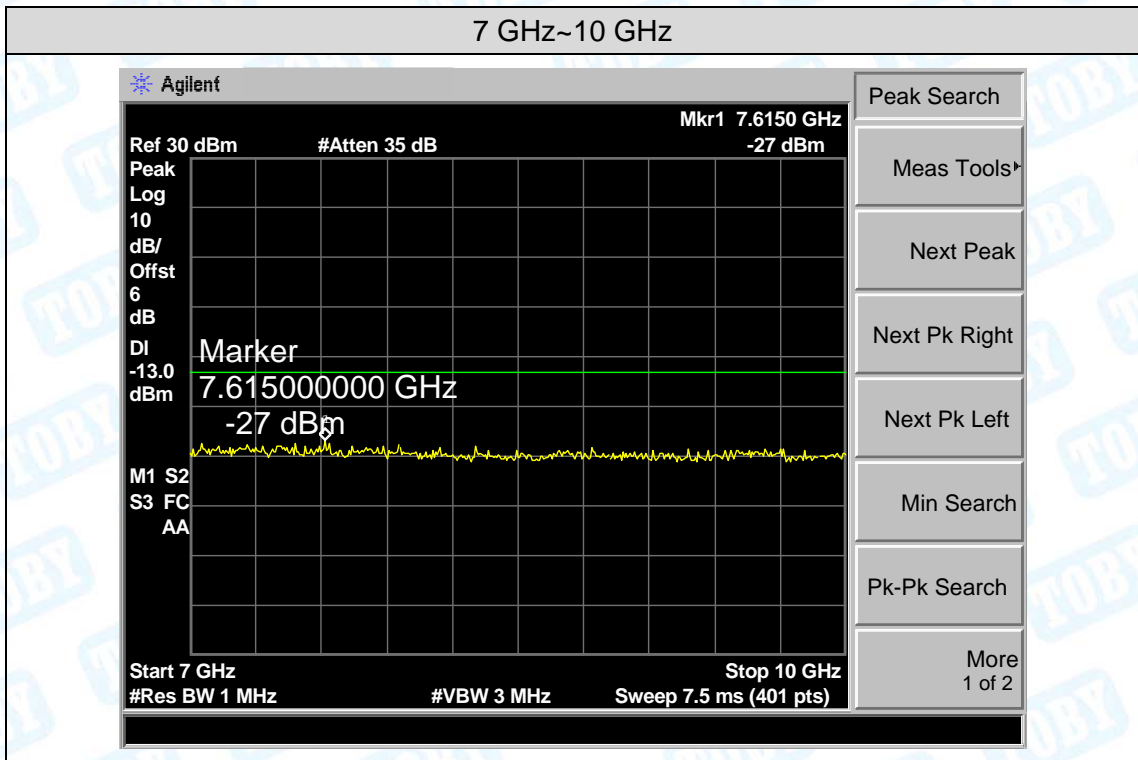

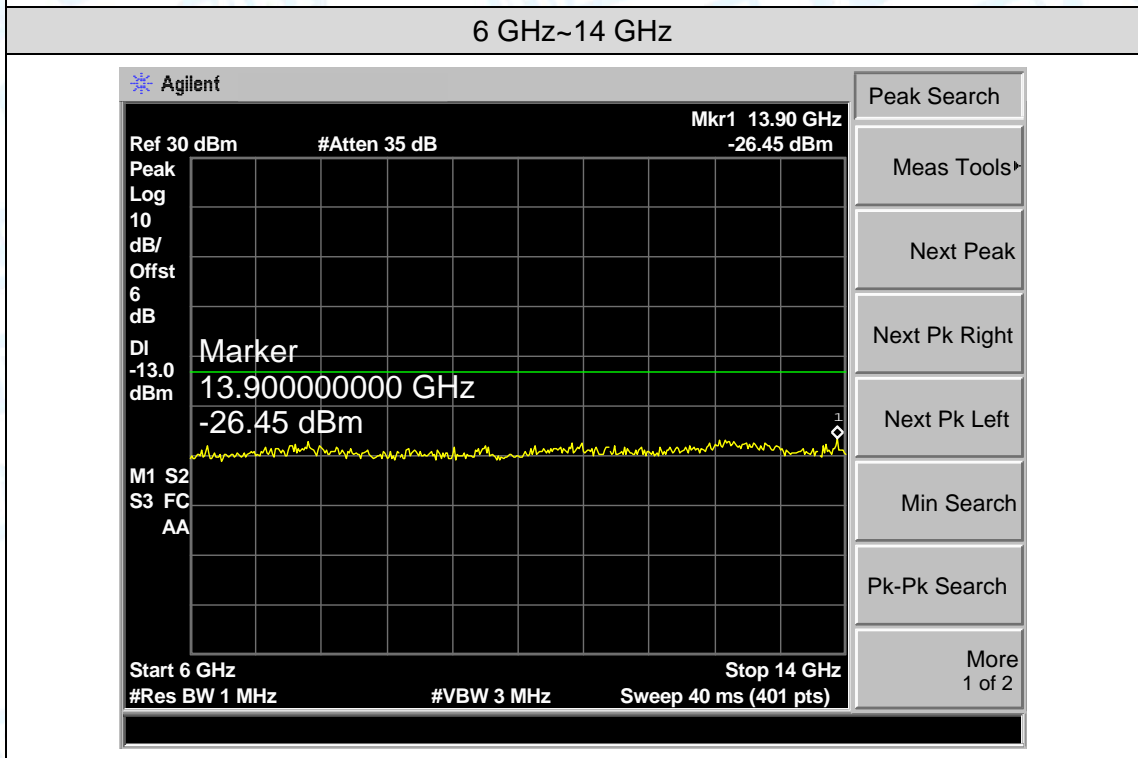
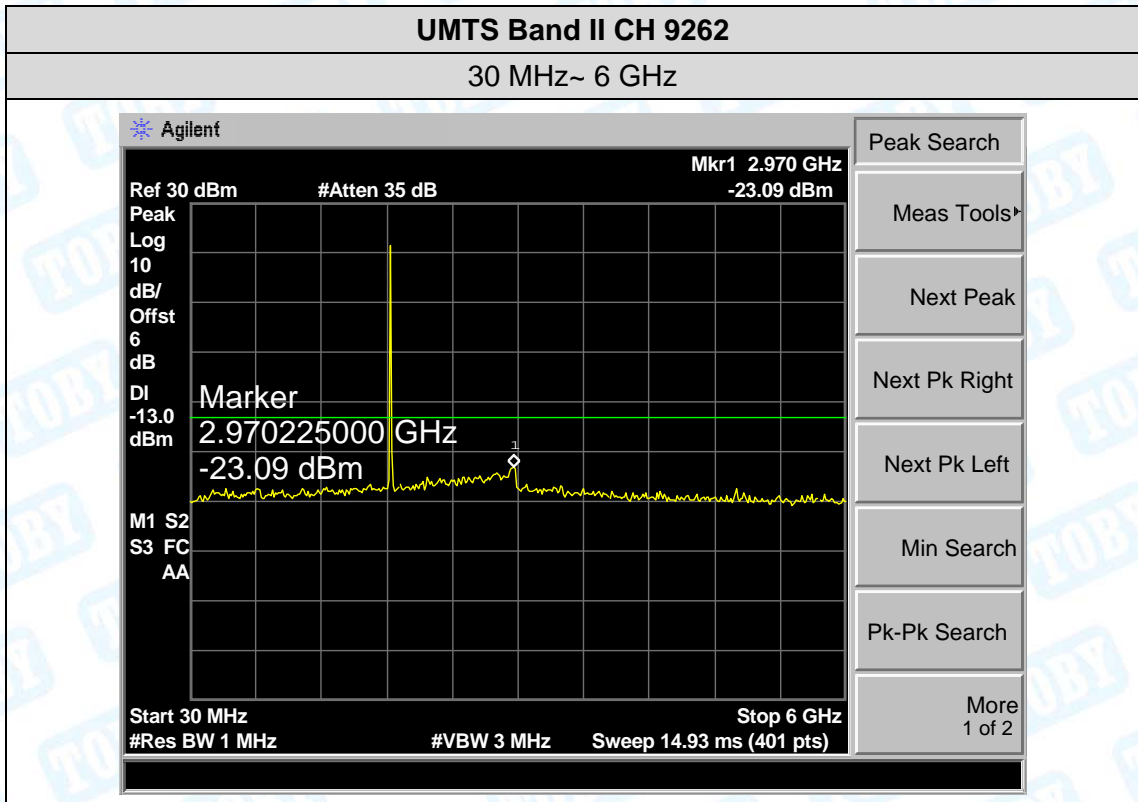

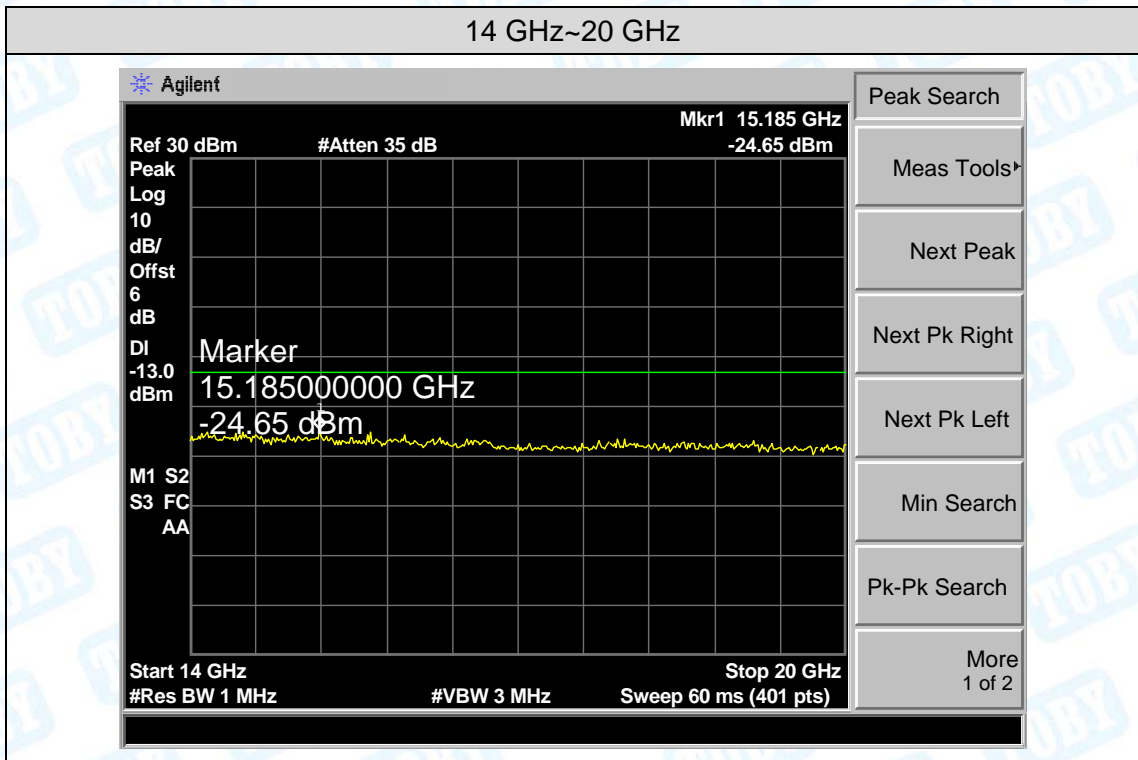

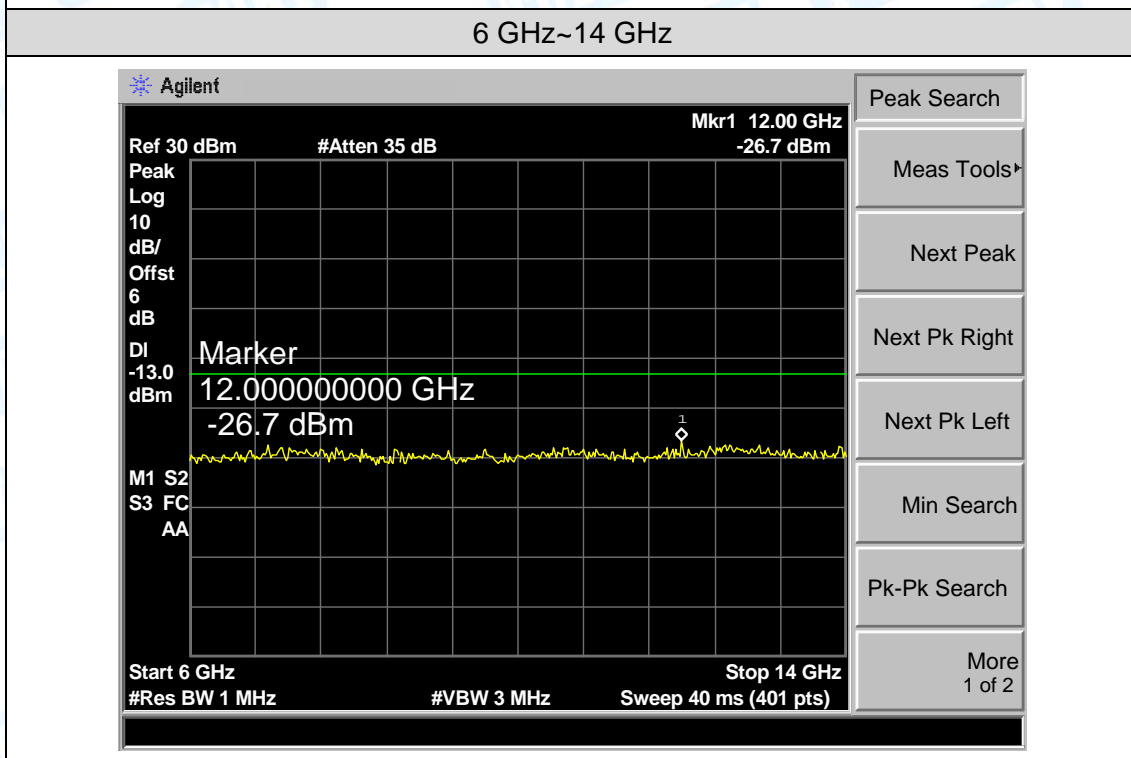
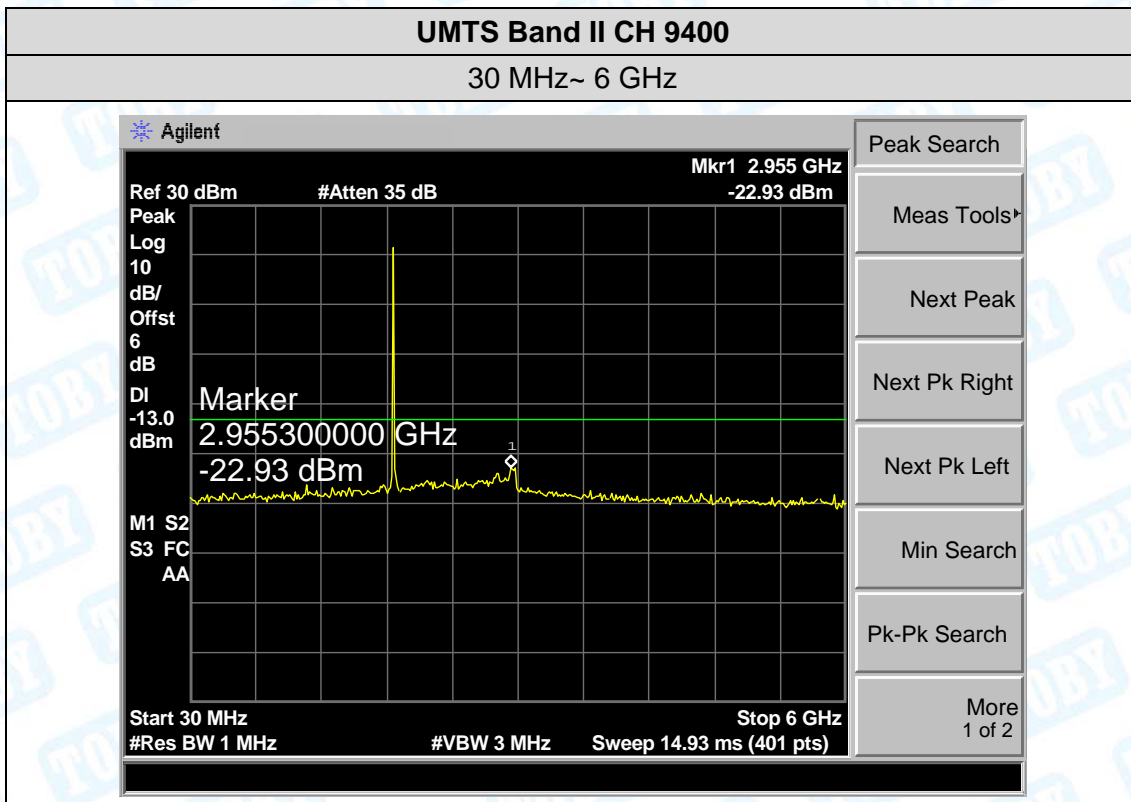

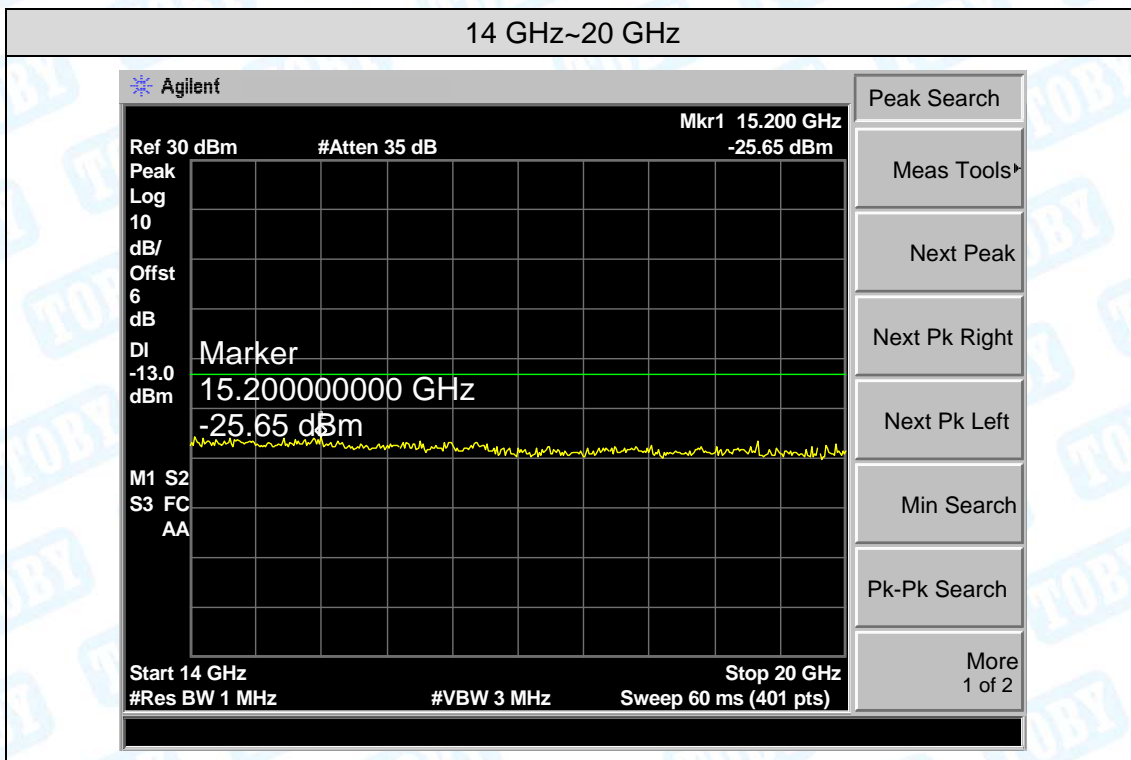



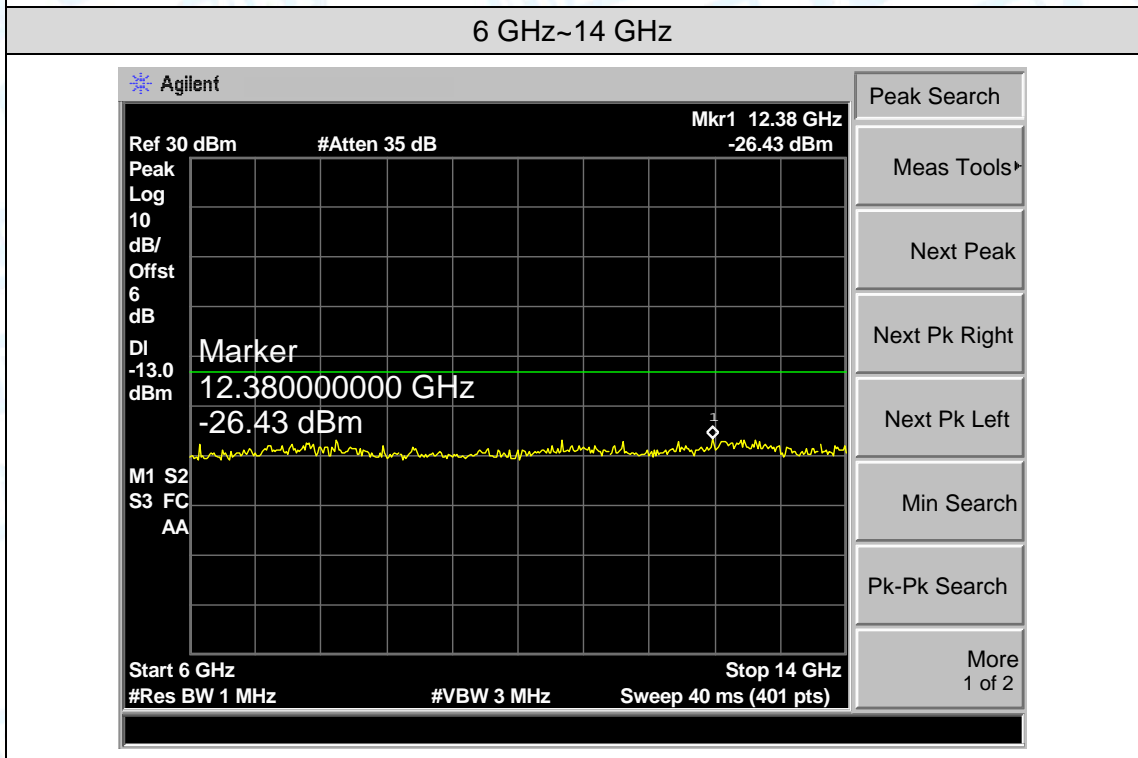
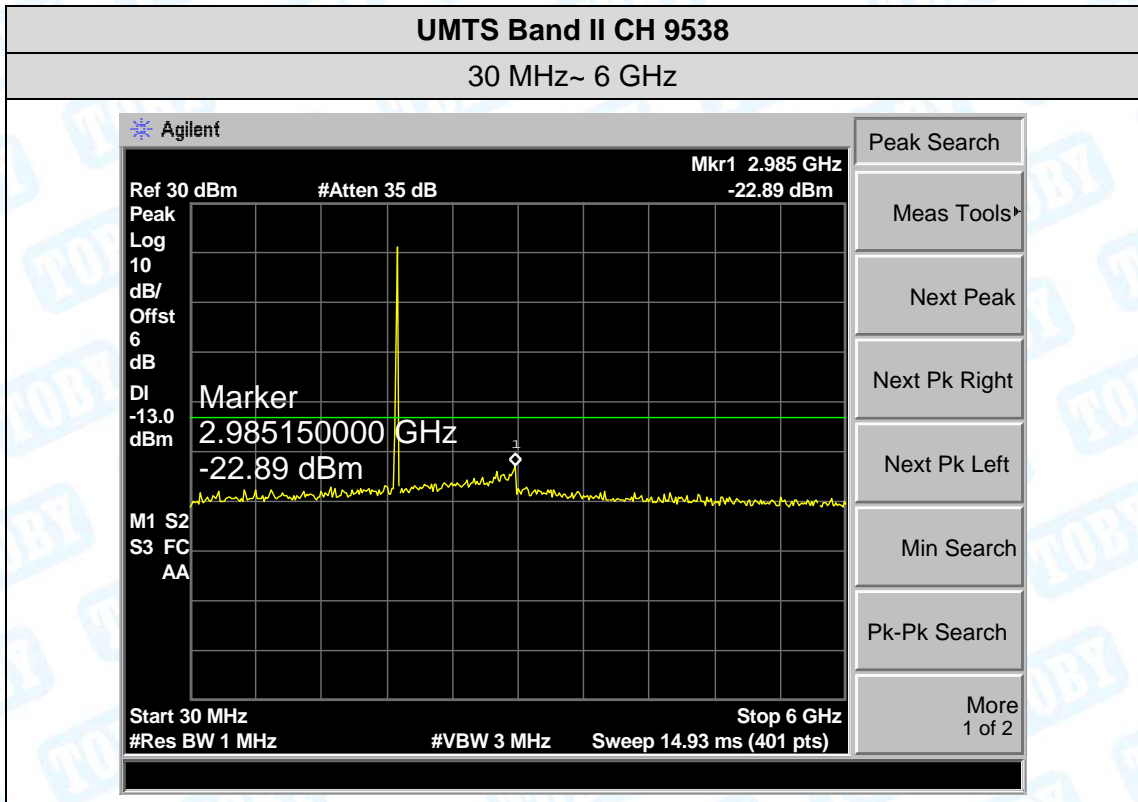

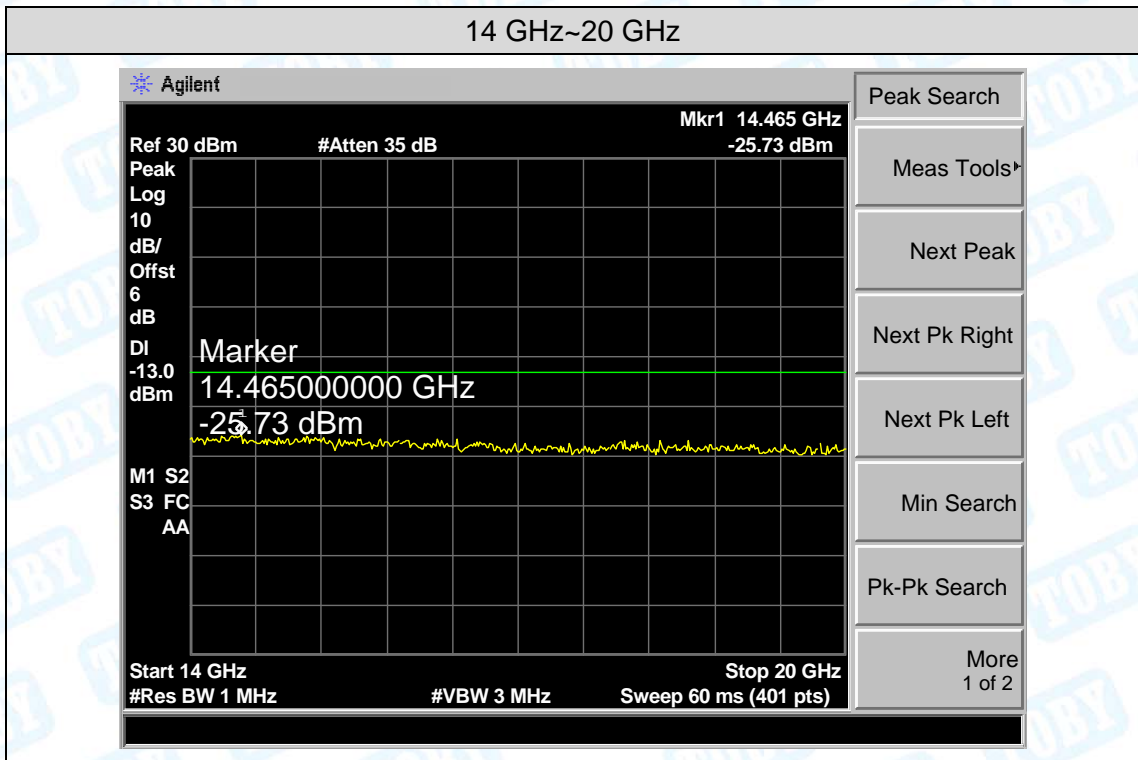

## Attachment G-- Band Edge Test

Test Mode:	UMTS Band V 12.2k HSDPA
------------	-------------------------

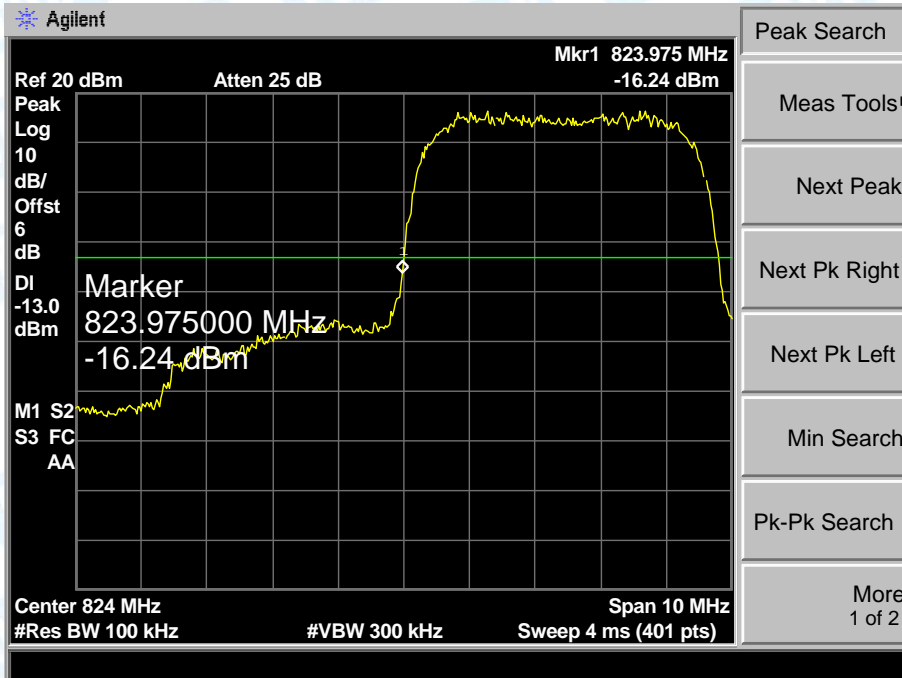

Lowest channel

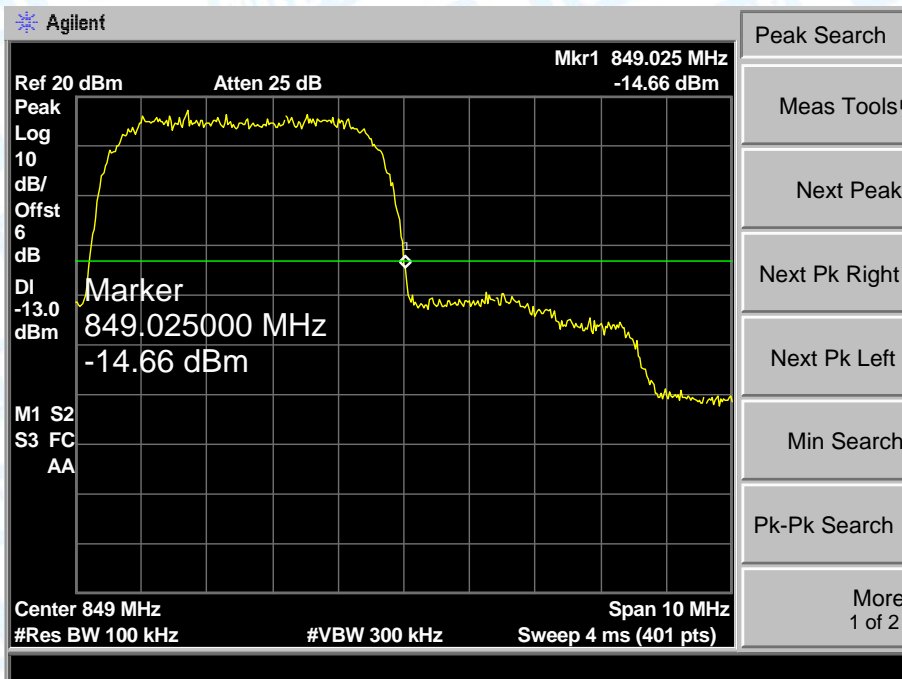

Highest channel

Test Mode: UMTS Band V 12.2k HSUPA

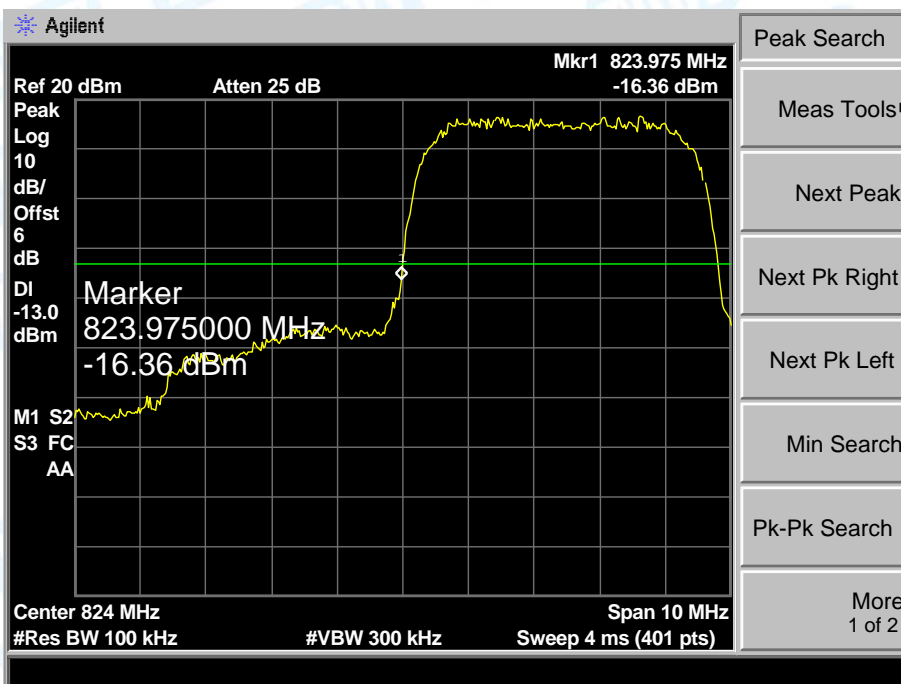

Lowest channel

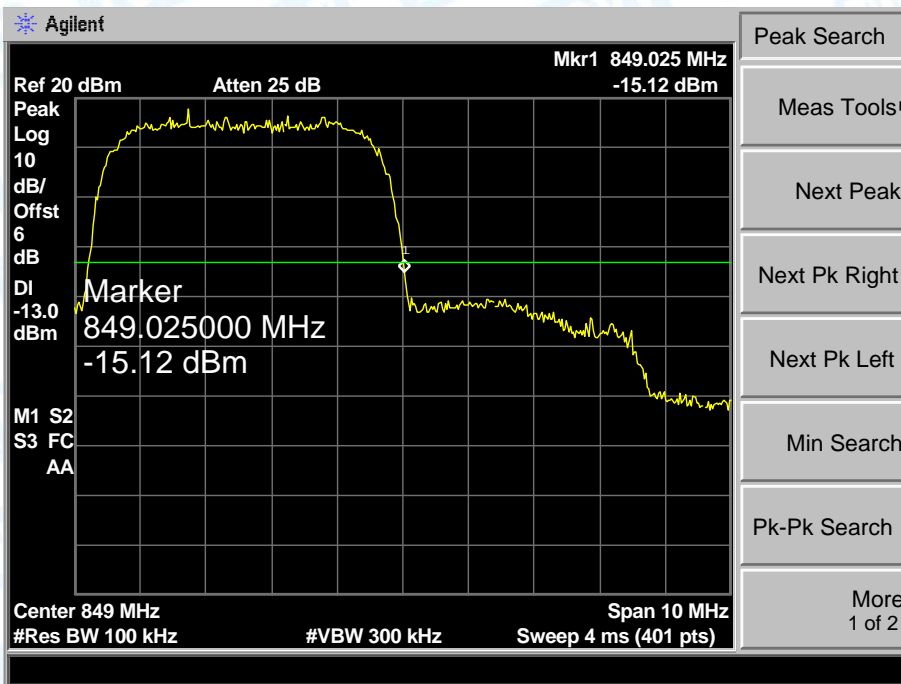

Highest channel

Test Mode:	UMTS Band II 12.2k HSDPA
------------	--------------------------

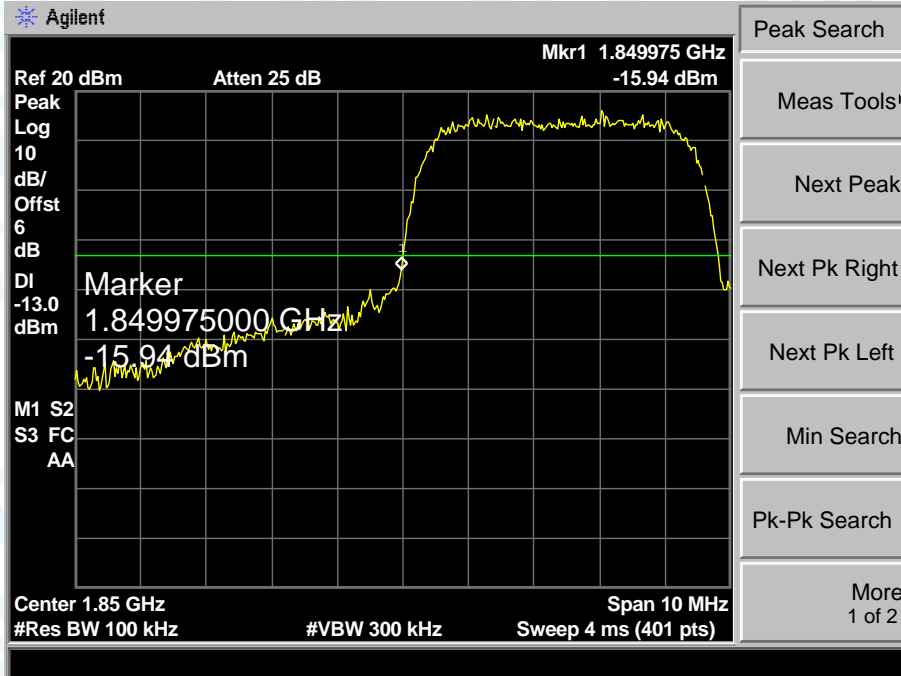

Lowest channel

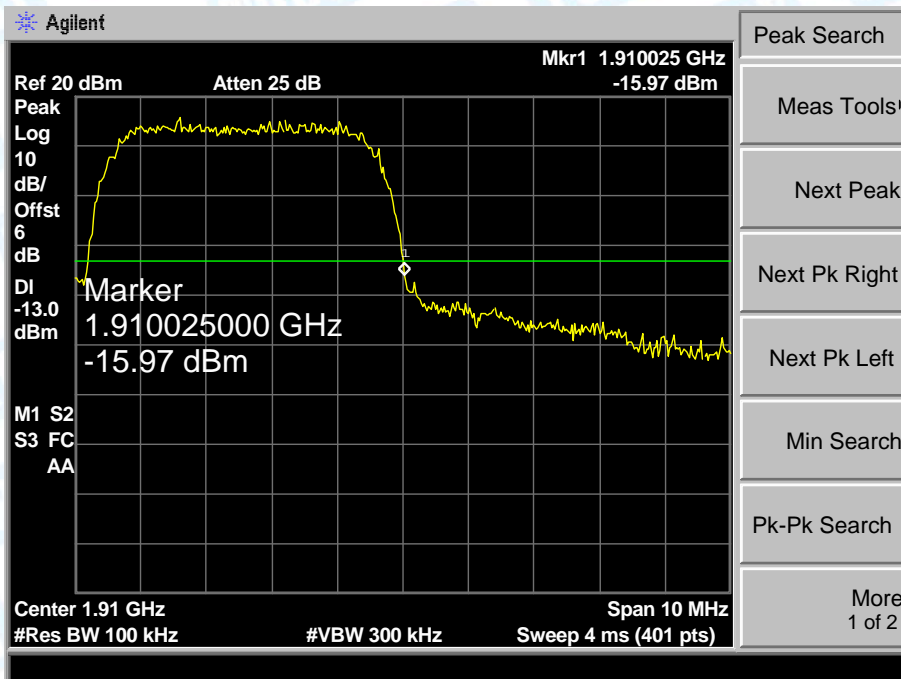

Highest channel

Test Mode:	UMTS Band II 12.2k HSUPA
------------	--------------------------

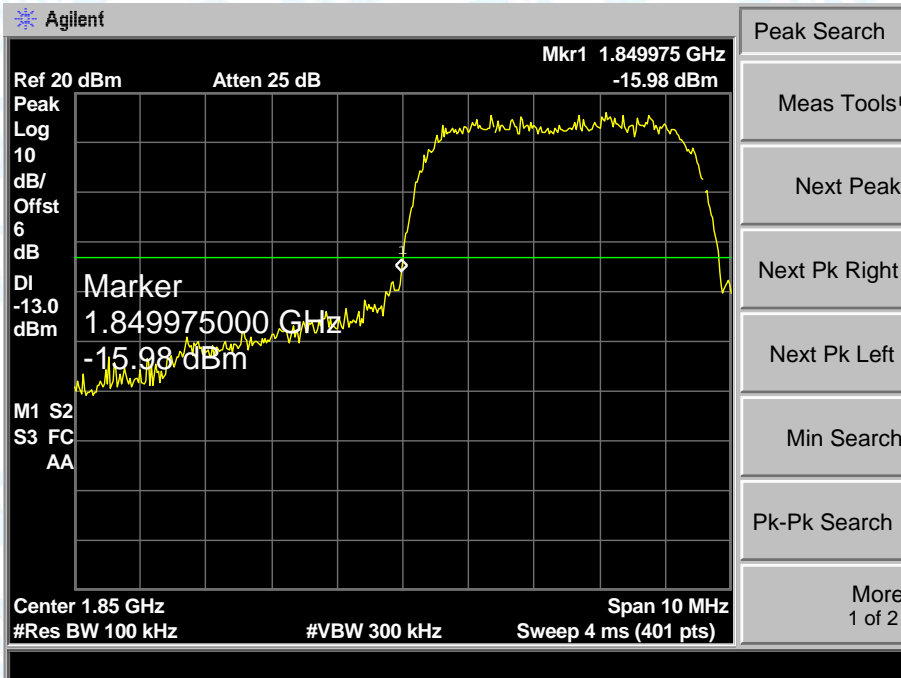

Lowest channel

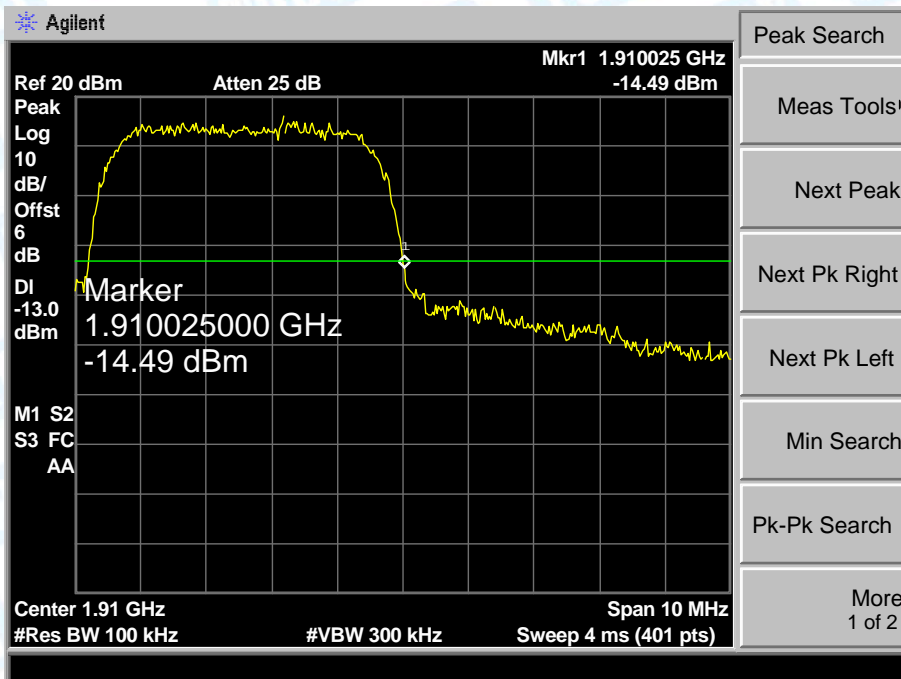

Highest channel

## Attachment H--Radiated Out Band of Emissions

Measurement Data (worst case)

Test mode: UMTS Band V HSDPA							
Channel: Middle		Date of Test: 2019-04-15					
Frequency (MHz)	Spurious Emission					Limit (dBm)	Result
	Polarization (H&V)	Read Level (dBm)	Antenna Correct Factor (dBi)	Cable Loss (dB)	Emission Level (dBm)		
1673.20	Horizontal	-35.13	7.49	3.97	-23.67	-13.00	Pass
2509.80	H	-37.47	7.03	5.05	-25.39		
3346.40	H	-44.90	12.48	5.98	-26.44		
4183.00	H	---	---	---	---		
5019.60	H	---	---	---	---		
5856.20	H	---	---	---	---		
1673.20	Vertical	-34.35	8.02	3.97	-22.36	-13.00	Pass
2509.80	V	-40.10	10.47	5.05	-24.58		
3346.40	V	-49.77	16.92	5.98	-26.87		
4183.00	V	---	---	---	---		
5019.60	V	---	---	---	---		
5856.20	V	---	---	---	---		
Test mode: UMTS Band V HSUPA							
Channel: Middle		Date of Test: 2019-04-15					
Frequency (MHz)	Spurious Emission					Limit (dBm)	Result
	Polarization (H&V)	Read Level (dBm)	Antenna Correct Factor (dBi)	Cable Loss (dB)	Emission Level (dBm)		
1673.20	Horizontal	-36.01	7.49	3.97	-24.55	-13.00	Pass
2509.80	H	-38.66	7.03	5.05	-26.58		
3346.40	H	-46.71	12.48	5.98	-28.25		
4183.00	H	---	---	---	---		
5019.60	H	---	---	---	---		
5856.20	H	---	---	---	---		
1673.20	Vertical	-35.57	8.02	3.97	-23.58	-13.00	Pass
2509.80	V	-42.04	10.47	5.05	-26.52		
3346.40	V	-51.55	16.92	5.98	-28.65		
4183.00	V	---	---	---	---		
5019.60	V	---	---	---	---		
5856.20	V	---	---	---	---		
Remark: 1, The testing has been conformed to $10 \times 836.6\text{MHz} = 8,366\text{MHz}$ . 2, All other emissions more than 30 dB below the limit. 3, Emission Level= Read Level+ Antenna Correct Factor +Cable Loss							

Test mode: UMTS Band II HSDPA							
Channel: Middle			Date of Test: 2019-04-15				
Frequency (MHz)	Spurious Emission					Limit (dBm)	Result
	Polarization (H&V)	Read Level (dBm)	Antenna Correct Factor (dBi)	Cable Loss (dB)	Emission Level (dBm)		
3760.00	Horizontal	-44.36	14.70	6.12	-23.54	-13.00	Pass
5640.00	H	-47.16	13.67	7.86	-25.63		
7520.00	H	-51.16	14.27	9.54	-27.35		
9400.00	H	---	---	---	---		
11280.00	H	---	---	---	---		
13160.00	H	---	---	---	---		
3760.00	Vertical	-44.75	15.81	6.12	-22.82	-13.00	Pass
5640.00	V	-45.94	13.80	7.86	-24.28		
7520.00	V	-49.81	13.40	9.54	-26.87		
9400.00	V	---	---	---	---		
11280.00	V	---	---	---	---		
13160.00	V	---	---	---	---		
Test mode: UMTS Band II HSUPA							
Channel: Middle			Date of Test: 2019-04-15				
Frequency (MHz)	Spurious Emission					Limit (dBm)	Result
	Polarization (H&V)	Read Level (dBm)	Antenna Correct Factor (dBi)	Cable Loss (dB)	Emission Level (dBm)		
3760.00	Horizontal	-45.07	14.70	6.12	-24.25	-13.00	Pass
5640.00	H	-47.48	13.67	7.86	-25.95		
7520.00	H	-53.02	14.27	9.54	-29.21		
9400.00	H	---	---	---	---		
11280.00	H	---	---	---	---		
13160.00	H	---	---	---	---		
3760.00	Vertical	-45.48	15.81	6.12	-23.55	-13.00	Pass
5640.00	V	-48.51	13.80	7.86	-26.85		
7520.00	V	-52.48	13.40	9.54	-29.54		
9400.00	V	---	---	---	---		
11280.00	V	---	---	---	---		
13160.00	V	---	---	---	---		
Remark: 1, The testing has been conformed to $10 \times 1880.0\text{MHz} = 18,800\text{MHz}$ . 2, All other emissions more than 30 dB below the limit. 3, Emission Level= Read Level+ Antenna Correct Factor +Cable Loss							

-----End of the Report-----