

FCC Radio Test Report

FCC ID: 2AM8GCHAMELEON8

Original Grant

Report No. : TB-FCC164422
Applicant : Guangzhou Lie Dun Electronics Technology CO.,Ltd
Equipment Under Test (EUT)
EUT Name : RUGGEDIZED TABLET
Model No. : 8-DUAL
Series Model No. : 8-MICRO, 8-SINGLE, 8-SINGLE+, 8-SLAP
Brand Name : CHAMELEON
Receipt Date : 2019-02-27
Test Date : 2019-03-04 to 2019-06-25
Issue Date : 2019-06-25
Standards : FCC Part 15, Subpart E 15.407
Test Method : ANSI C63.10: 2013
Conclusions : **PASS**

In the configuration tested, the EUT complied with the standards specified above,
The EUT technically complies with the FCC and IC requirements

Test/Witness Engineer : *Jason xu* Jason Xu

Test/Witness Engineer : *Ivan Su* Ivan Su

Approved & Authorized : *Ray Lai* Ray Lai



This report details the results of the testing carried out on one sample. The results contained in this test report do not relate to other samples of the same product. The manufacturer should ensure that all products in series production are in conformity with the product sample detailed in the report.

Contents

CONTENTS.....	2
1. GENERAL INFORMATION ABOUT EUT	5
1.1 Client Information.....	5
1.2 General Description of EUT (Equipment Under Test)	5
1.3 Block Diagram Showing the Configuration of System Tested.....	7
1.4 Description of Support Units	7
1.5 Description of Test Mode.....	8
1.6 Description of Test Software Setting	9
1.7 Test Facility.....	10
2. TEST SUMMARY	11
3. TEST EQUIPMENT.....	12
4. CONDUCTED EMISSION TEST	13
4.1 Test Standard and Limit.....	13
4.2 Test Setup.....	13
4.3 Test Procedure	14
4.4 EUT Operating Mode	14
4.5 Test Data.....	14
5. RADIATED EMISSION TEST	15
5.1 Test Standard and Limit.....	15
5.2 Test Setup.....	16
5.3 Test Procedure.....	18
5.4 EUT Operating Condition	18
5.5 Test Data.....	18
6. BAND EDGE EMISSIONS	19
6.1 Test Standard and Limit.....	19
6.2 Test Setup.....	19
6.3 Test Procedure.....	20
6.4 EUT Operating Condition	20
6.5 Test Data.....	20
7. BANDWIDTH TEST.....	21
7.1 Test Standard and Limit.....	21
7.2 Test Setup.....	21
7.3 Test Procedure.....	21
7.4 EUT Operating Condition	22
7.5 Test Data.....	22
8. OUTPUT POWER TEST.....	23
8.1 Test Standard and Limit.....	23
8.2 Test Setup.....	23
8.3 Test Procedure.....	23

8.4 EUT Operating Condition	23
8.5 Test Date.....	23
9. POWER SPECTRAL DENSITY TEST	24
9.1 Test Standard and Limit.....	24
9.2 Test Setup.....	24
9.3 Test Procedure.....	24
9.4 EUT Operating Condition	25
9.5 Test Data.....	25
10. FREQUENCY STABILITY MEASUREMENT	26
10.1 Test Standard and Limit	26
10.2 Test Setup.....	26
10.3 Test Procedure.....	26
10.4 EUT Operating Condition	26
11. ANTENNA REQUIREMENT.....	27
11.1 Standard Requirement.....	27
11.2 Antenna Connected Construction	27
11.3 Result.....	27
ATTACHMENT A-- CONDUCTED EMISSION TEST DATA	28
ATTACHMENT B-- RADIATED EMISSION TEST DATA	30
ATTACHMENT C-- RESTRICTED BANDS REQUIREMENT AND BAND-EDGE TEST DATA	88
ATTACHMENT D--BANDWIDTH TEST DATA	156
ATTACHMENT E-- PEAK OUTPUT POWER TEST DATA.....	200
ATTACHMENT F-- POWER SPECTRAL DENSITY TEST DATA.....	209
ATTACHMENT G----FREQUENCY STABILITY MEASUREMENT DATA.....	233

Revision History

Report No.	Version	Description	Issued Date
TB-FCC164422	Rev.01	Initial issue of report	2019-06-25

1. General Information about EUT

1.1 Client Information

Applicant	:	Guangzhou Lie Dun Electronics Technology CO.,Ltd
Address	:	No.4 plant of No.43 South International Trade Avenue, Hualong Town, Panyu District, Guangzhou, Guangdong, China
Manufacturer	:	Guangzhou Lie Dun Electronics Technology CO.,Ltd
Address	:	No.4 plant of No.43 South International Trade Avenue, Hualong Town, Panyu District, Guangzhou, Guangdong, China

1.2 General Description of EUT (Equipment Under Test)

EUT Name	:	RUGGEDIZED TABLET															
Models No.	:	8-DUAL, 8-MICRO, 8-SINGLE, 8-SINGLE+, 8-SLAP															
Model Difference	:	All these models are identical in the same PCB, layout and electrical circuit, the only difference is model name for commercial.															
Product Description	:	Operation Frequency: U-NII-1: 5180MHz~5240MHz U-NII-3: 5745MHz~5825MHz															
	:	RF Output Power:	<table border="1"> <thead> <tr> <th>U-NII-1:</th> <th>U-NII-3:</th> </tr> </thead> <tbody> <tr> <td>802.11a: 6.98dBm</td> <td>802.11a: 6.95dBm</td> </tr> <tr> <td>802.11n(HT20): 6.87dBm</td> <td>802.11n(HT20): 6.90dBm</td> </tr> <tr> <td>802.11n(HT40): 6.82dBm</td> <td>802.11n(HT40): 6.80dBm</td> </tr> <tr> <td>802.11ac(20): 6.86dBm</td> <td>802.11ac(20): 6.81dBm</td> </tr> <tr> <td>802.11ac(40): 6.88dBm</td> <td>802.11ac(40): 6.86dBm</td> </tr> <tr> <td>802.11ac(80): 6.71dBm</td> <td>802.11ac(80): 6.83dBm</td> </tr> </tbody> </table>	U-NII-1:	U-NII-3:	802.11a: 6.98dBm	802.11a: 6.95dBm	802.11n(HT20): 6.87dBm	802.11n(HT20): 6.90dBm	802.11n(HT40): 6.82dBm	802.11n(HT40): 6.80dBm	802.11ac(20): 6.86dBm	802.11ac(20): 6.81dBm	802.11ac(40): 6.88dBm	802.11ac(40): 6.86dBm	802.11ac(80): 6.71dBm	802.11ac(80): 6.83dBm
	U-NII-1:	U-NII-3:															
	802.11a: 6.98dBm	802.11a: 6.95dBm															
	802.11n(HT20): 6.87dBm	802.11n(HT20): 6.90dBm															
802.11n(HT40): 6.82dBm	802.11n(HT40): 6.80dBm																
802.11ac(20): 6.86dBm	802.11ac(20): 6.81dBm																
802.11ac(40): 6.88dBm	802.11ac(40): 6.86dBm																
802.11ac(80): 6.71dBm	802.11ac(80): 6.83dBm																
:	Antenna Gain:	see note(3)															
:	Modulation Type:	802.11a: OFDM (QPSK, BPSK, 16QAM) 802.11n: OFDM (QPSK, BPSK, 16QAM, 64QAM) 802.11ac: OFDM (QPSK, BPSK, 16QAM, 64QAM, 256QAM)															
:	Bit Rate of Transmitter:	802.11a: 6/9/12/18/24/36/48/54 Mbps 802.11n: up to 150Mbps 802.11ac: at most 433.3 Mbps															
Power Rating	:	Adapter(B036-125): Input: AC 100-240V, 50/60Hz, 1.2A max Output: DC 12V, 3A DC 7.6V by 7600mAh rechargeable Li-ion battery.															
Software Version	:	Windows Pro															

Hardware Version	:	V12
Connecting I/O Port(S)	:	Please refer to the User's Manual
Note: More detailed features description, please refer to the manufacturer's specifications or the User's Manual.		

Note:

(1) This Test Report is FCC Part 15, Subpart E(15.407) for 802.11a/n/ac, the test procedure follows the KDB 789033 D02 General U-NII Test Procedures New Rules v02r01.

(2) Channel List:

5G Band 5150~5250 MHz (U-NII-1)				
Frequency Band	Channel No.	Frequency	Channel No.	Frequency
5180~5240 MHz Band 1	36	5180 MHz	44	5220 MHz
	38	5190 MHz	46	5230 MHz
	40	5200 MHz	48	5240 MHz
	42	5210 MHz		
Remark: For 20 MHz Bandwidth, use channel 36, 40, 44, 48. For 40 MHz Bandwidth, use channel 38, 46. For 80 MHz Bandwidth, use channel 42.				
5G Band 5745~5825 MHz(U-NII-3)				
Frequency Band	Channel No.	Frequency	Channel No.	Frequency
5745~5825 MHz Band 4	149	5745 MHz	157	5785 MHz
	151	5755 MHz	159	5795 MHz
	153	5765 MHz	161	5805 MHz
	155	5775 MHz	165	5825 MHz
Remark: For 20 MHz Bandwidth, use channel 149, 153, 157, 161, 165. For 40 MHz Bandwidth, use channel 151, 159. For 80 MHz Bandwidth, use channel 155.				

(3) Antenna information:

Mode	TX Antenna (s)	Remark		
802.11a	1	The worst case is Main ANT. TX		
802.11n (HT20)	2	Main ANT. + Aux ANT.		
802.11n (HT40)	2	Main ANT. + Aux ANT.		
802.11ac (20)	2	Main ANT. + Aux ANT.		
802.11ac (40)	2	Main ANT. + Aux ANT.		
802.11ac (80)	2	Main ANT. + Aux ANT.		
Antenna	Brand	Model Name	Type	Antenna Gain(dBi)
Main ANT.	N/A	N/A	FPC	2
Main ANT.	N/A	N/A	FPC	2

Note:For MIMO mode: Directional gain=Gain(Ant1)+Gain(Ant1)=5.01 dBi in 802.11 n/ac has MIMO mode.

1.3 Block Diagram Showing the Configuration of System Tested

Charging +TX Mode

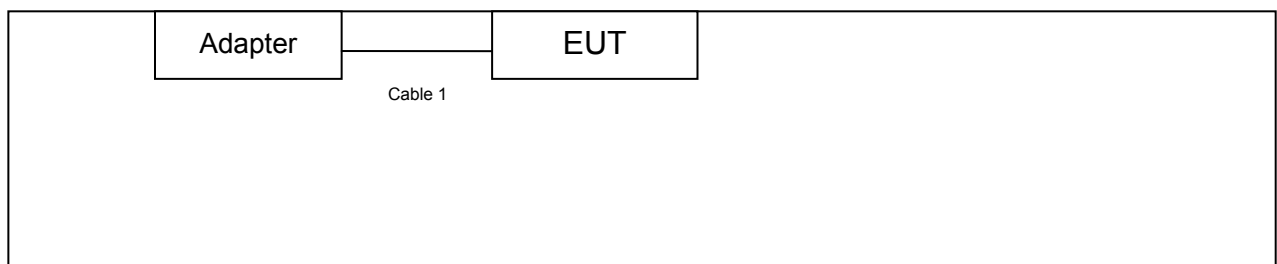

TX Mode

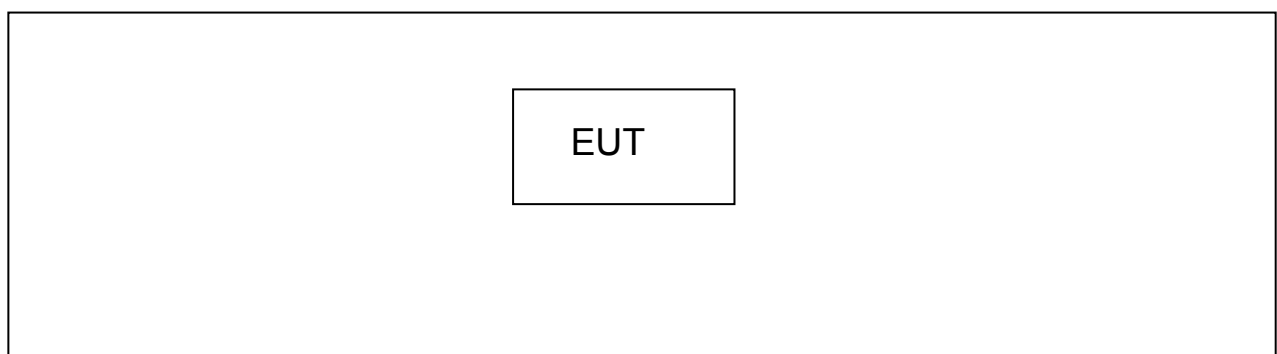

1.4 Description of Support Units

The EUT has been test as an independent unit.

1.5 Description of Test Mode

To investigate the maximum EMI emission characteristics generates from EUT, the test system was pre-scanning tested base on the consideration of following EUT operation mode or test configuration mode which possible have effect on EMI emission level. Each of these EUT operation mode(s) or test configuration mode(s) mentioned follow was evaluated respectively.

For Conducted Test		
Final Test Mode	Description	
Mode 1	TX 802.11a Mode	
For Radiated Test		
Test Band	Final Test Mode	Description
U-NII-1	Mode 2	TX Mode 802.11a Mode Channel 36/40/48
	Mode 3	TX Mode 802.11n(HT20) Mode Channel 36/40/48
	Mode 4	TX Mode 802.11n(HT40) Mode Channel 38/46
	Mode 5	TX Mode 802.11ac(20) Mode Channel 36/40/48
	Mode 6	TX Mode 802.11ac(40) Mode Channel 38/46
	Mode 7	TX Mode 802.11ac(80) Mode Channel 42
U-NII-3	Mode 8	TX Mode 802.11a Mode Channel 149/157/165
	Mode 9	TX Mode 802.11n(HT20) Mode Channel 149/157/165
	Mode 10	TX Mode 802.11n(HT40) Mode Channel 151/159
	Mode 11	TX Mode 802.11ac(20) Mode Channel 149/157/165
	Mode 12	TX Mode 802.11ac(40) Mode Channel 151/159
	Mode 13	TX Mode 802.11ac(80) Mode Channel 155

Note:

- (1) For all test, we have verified the construction and function in typical operation. And all the test modes were carried out with the EUT in transmitting operation in maximum power with all kinds of data rate.

According to ANSI C63.10 standards, the measurements are performed at the highest, middle, lowest available channels, and the worst case data rate as follows:

- 802.11a Mode: OFDM (6 Mbps)
- 802.11n (HT20) Mode: MCS 8
- 802.11n (HT40) Mode: MCS 8
- 802.11a(20) Mode: MCS 1/Nss2
- 802.11a(40) Mode: MCS 1/Nss2
- 802.11a(80) Mode: MCS 1/Nss2

- (2) During the testing procedure, the continuously transmitting with the maximum power mode was programmed by the customer.
- (3) The EUT is considered a mobile unit; in normal use it was positioned on X-plane. The worst case was found positioned on X-plane. Therefore only the test data of this X-plane was used for radiated emission measurement test.

1.6 Description of Test Software Setting

During testing channel & Power controlling software provided by the customer was used to control the operating channel as well as the output power level. The RF output power selection is for the setting of RF output power expected by the customer and is going to be fixed on the firmware of the final end product power parameters of WLAN.

Test Software Version	DRTU		
U-NII-1			
Mode:	5180MHz	5200MHz	5240MHz
IEEE 802.11a	DEF	DEF	DEF
IEEE 802.11n (HT20)	DEF	DEF	DEF
IEEE 802.11ac (20)	DEF	DEF	DEF
Mode:	5190MHz	5230MHz	
IEEE 802.11n (HT40)	DEF	DEF	
IEEE 802.11ac (40)	DEF	DEF	
Mode:	5210MHz		
IEEE 802.11ac (80)	DEF		
U-NII-3			
Mode:	5745MHz	5785MHz	5825MHz
IEEE 802.11a	DEF	DEF	DEF
IEEE 802.11n (HT20)	DEF	DEF	DEF
IEEE 802.11ac (20)	DEF	DEF	DEF
Mode:	5755MHz	5795MHz	
IEEE 802.11n (HT40)	DEF	DEF	
IEEE 802.11ac (40)	DEF	DEF	
Mode:	5775MHz		
IEEE 802.11ac (80)	DEF		

1.7 Test Facility

The testing was performed by the Shenzhen Toby Technology Co., Ltd., in their facilities located at:1A/F., Bldg.6, Yusheng Industrial Zone, The National Road No.107 Xixiang Section 467, Xixiang, Bao'an, Shenzhen, Guangdong, China.

At the time of testing, the following bodies accredited the Laboratory:

CNAS (L5813)

The Laboratory has been accredited by CNAS to ISO/IEC 17025: 2005 General Requirements for the Competence of Testing and Calibration Laboratories for the competence in the field of testing. And the Registration No.: CNAS L5813.

A2LA Certificate No.: 4750.01

The laboratory has been accredited by American Association for Laboratory Accreditation(A2LA) to ISO/IEC 17025: 2005 General Requirements for the Competence of Testing and Calibration Laboratories for the technical competence in the field of Electrical Testing. And the A2LA Certificate No.: 4750.01.FCC Accredited Test Site Number: 854351.

IC Registration No.: (11950A-1)

The Laboratory has been registered by Certification and Engineering Bureau of Industry Canada for radio equipment testing. The site registration: Site# 11950A-1.

2. Test Summary

FCC Part 15 Subpart E(15.407)/RSS-210 Issue 9				
Standard Section		Test Item	Judgment	Remark
FCC	IC			
15.203	/	Antenna Requirement	PASS	N/A
15.207	RSS-GEN 7.2.4	Conducted Emission	PASS	N/A
15.407(b)	RSS-GEN 7.2.2	Band Edge Emissions	PASS	N/A
15.407(a)	RSS-24 A.9.2	26dB Bandwidth&99% Bandwidth	PASS	N/A
15.407(e)	RSS-210 A.9.2	6dB Bandwidth(only for UNII-3)	PASS	N/A
15.407(a)	RSS-210 A.9.2	Peak Output Power	PASS	N/A
15.407(a)	RSS-210 A.9.2	Power Spectral Density	PASS	N/A
15.407(b)	RSS-210 A.9.2	Transmitter Radiated Spurious Emission	PASS	N/A
15.407(a)	RSS-210 A.9.2	Peak Excursion	PASS	N/A
15.407(g)	RSS-210 A.9.2	Frequency Stability	PASS	N/A
Note: "/" for no requirement for this test item. N/A is an abbreviation for Not Applicable.				

3. Test Equipment

Conducted Emission Test					
Equipment	Manufacturer	Model No.	Serial No.	Last Cal.	Cal. Due Date
EMI Test Receiver	Rohde & Schwarz	ESCI	100321	Jul.18, 2018	Jul. 17, 2019
RF Switching Unit	Compliance Direction Systems Inc	RSU-A4	34403	Jul.18, 2018	Jul. 17, 2019
AMN	SCHWARZBECK	NNBL 8226-2	8226-2/164	Jul.18, 2018	Jul. 17, 2019
LISN	Rohde & Schwarz	ENV216	101131	Jul.18, 2018	Jul. 17, 2019
Radiation Emission Test					
Equipment	Manufacturer	Model No.	Serial No.	Last Cal.	Cal. Due Date
Spectrum Analyzer	Agilent	E4407B	MY45106456	Jul.18, 2018	Jul. 17, 2019
EMI Test Receiver	Rohde & Schwarz	ESPI	100010/007	Jul.18, 2018	Jul. 17, 2019
Spectrum Analyzer	Rohde & Schwarz	FSVR	1311.006K40-100 945-DH	Feb. 10, 2019	Feb. 09, 2020
Bilog Antenna	ETS-LINDGREN	3142E	00117537	Jan. 27, 2019	Jan. 26, 2020
Bilog Antenna	ETS-LINDGREN	3142E	00117542	Jan. 27, 2019	Jan. 26, 2020
Horn Antenna	ETS-LINDGREN	3117	00143207	Mar.03, 2019	Mar. 02, 2020
Horn Antenna	ETS-LINDGREN	3117	00143209	Mar.03, 2019	Mar. 02, 2020
Loop Antenna	SCHWARZBECK	FMZB 1519 B	1519B-059	Jul. 14, 2018	Jul.13, 2019
Pre-amplifier	Sonoma	310N	185903	Mar.04, 2019	Mar. 03, 2020
Pre-amplifier	HP	8449B	3008A00849	Mar.03, 2019	Mar. 02, 2020
Cable	HUBER+SUHNER	100	SUCOFLEX	Mar.03, 2019	Mar. 02, 2020
Positioning Controller	ETS-LINDGREN	2090	N/A	N/A	N/A
Antenna Conducted Emission					
Equipment	Manufacturer	Model No.	Serial No.	Last Cal.	Cal. Due Date
Spectrum Analyzer	Agilent	E4407B	MY45106456	Jul.18, 2018	Jul. 17, 2019
Spectrum Analyzer	Rohde & Schwarz	ESCI	100010/007	Jul.18, 2018	Jul. 17, 2019
MXA Signal Analyzer	Agilent	N9020A	MY49100060	Sep. 15, 2018	Sep. 14, 2019
Vector Signal Generator	Agilent	N5182A	MY50141294	Sep. 15, 2018	Sep. 14, 2019
Analog Signal Generator	Agilent	N5181A	MY50141953	Sep. 15, 2018	Sep. 14, 2019
RF Power Sensor	DARE!! Instruments	RadiPowerRPR3006W	17I00015SNO26	Sep. 15, 2018	Sep. 14, 2019
	DARE!! Instruments	RadiPowerRPR3006W	17I00015SNO29	Sep. 15, 2018	Sep. 14, 2019
	DARE!! Instruments	RadiPowerRPR3006W	17I00015SNO31	Sep. 15, 2018	Sep. 14, 2019
	DARE!! Instruments	RadiPowerRPR3006W	17I00015SNO33	Sep. 15, 2018	Sep. 14, 2019

4. Conducted Emission Test

4.1 Test Standard and Limit

4.1.1 Test Standard

FCC Part 15.207

4.1.2 Test Limit

Conducted Emission Test Limit

Frequency	Maximum RF Line Voltage (dB μ V)	
	Quasi-peak Level	Average Level
150kHz~500kHz	66 ~ 56 *	56 ~ 46 *
500kHz~5MHz	56	46
5MHz~30MHz	60	50

Notes:

(1) *Decreasing linearly with logarithm of the frequency.

(2) The lower limit shall apply at the transition frequencies.

(3) The limit decrease in line with the logarithm of the frequency in the range of 0.15 to 0.50MHz.

4.2 Test Setup

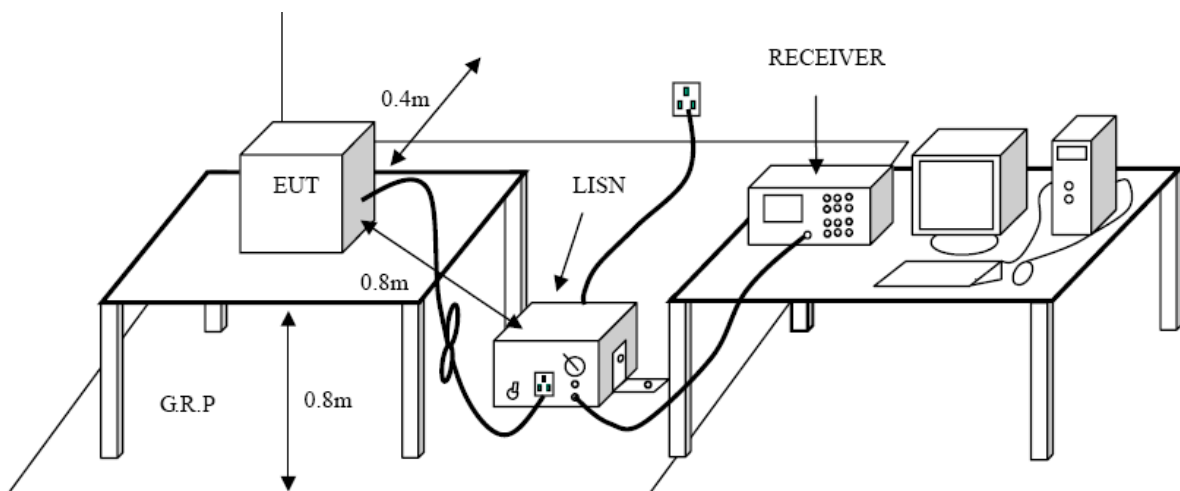

4.3 Test Procedure

The EUT was placed 0.8 meters from the horizontal ground plane with EUT being connected to the power mains through a line impedance stabilization network (LISN). All other support equipments powered from additional LISN(s). The LISN provide 50 Ohm/50uH of coupling impedance for the measuring instrument.

Interconnecting cables that hang closer than 40 cm to the ground plane shall be folded back and forth in the center forming a bundle 30 to 40 cm long.

I/O cables that are not connected to a peripheral shall be bundled in the center. The end of the cable may be terminated, if required, using the correct terminating impedance. The overall length shall not exceed 1 m.

LISN at least 80 cm from nearest part of EUT chassis.

The bandwidth of EMI test receiver is set at 9kHz, and the test frequency band is from 0.15MHz to 30MHz.

4.4 EUT Operating Mode

Please refer to the description of test mode.

4.5 Test Data

Please refer to the Attachment A.

5. Radiated Emission Test

5.1 Test Standard and Limit

5.1.1 Test Standard

FCC Part 15.209

5.1.2 Test Limit

Radiated Emission Limits (9kHz~1000MHz)

Frequency (MHz)	Field Strength (microvolt/meter)	Measurement Distance (meters)
0.009~0.490	2400/F(KHz)	300
0.490~1.705	24000/F(KHz)	30
1.705~30.0	30	30
30~88	100	3
88~216	150	3
216~960	200	3
Above 960	500	3

Radiated Emission Limit (Above 1000MHz)

Frequency (MHz)	Distance of 3m (dBuV/m)	
	Peak	Average
Above 1000	74	54

Note:

- (1) The tighter limit applies at the band edges.
- (2) Emission Level(dBuV/m)=20log Emission Level(uV/m)

Limits of unwanted emission out of the restricted bands

Frequency (MHz)	EIRP Limits (dBm)	Equivalent Field Strength at 3m (dBuV/m)
5150~5250	-27	68.3
5250~5350	-27	68.3
5470~5725	-27	68.3
5725~5825	-27(Note 2)	68.3
	10(Note 2)	105.3
	15.6(Note 2)	110.9
	27(Note 2)	122.3

NOTE:

1, The following formula is used to convert the equipment isotropic radiated power (eirp) to field strength:

$$E = \frac{1000000\sqrt{30P}}{3} \text{ uV/m, where P is the eirp (Watts)}$$

2, According to FCC 16-24, All emissions shall be limited to a level of -27 dBm/MHz at 75 MHz or more above or below the band edge increasing linearly to 10 dBm/MHz at 25 MHz above or below the band edge, and from 25MHz above or below the band edge increasing linearly to a level of 15.6 dBm/MHz at 5 MHz above or below the band edge, and from 5 MHz above or below the band edge increasing linearly to a level of 27dBm/MHz at the band edge.

5.2 Test Setup

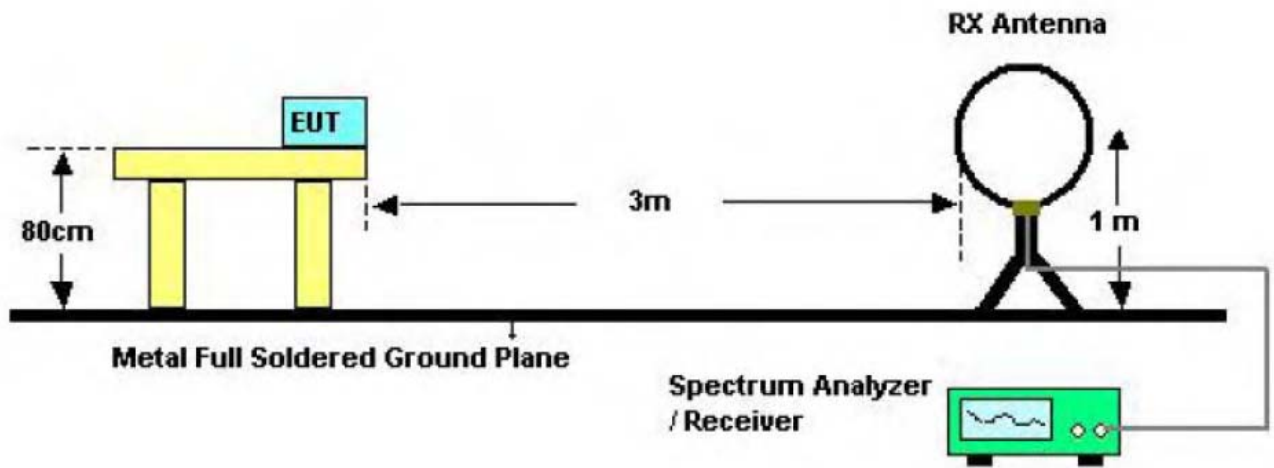

Below 30MHz Test Setup

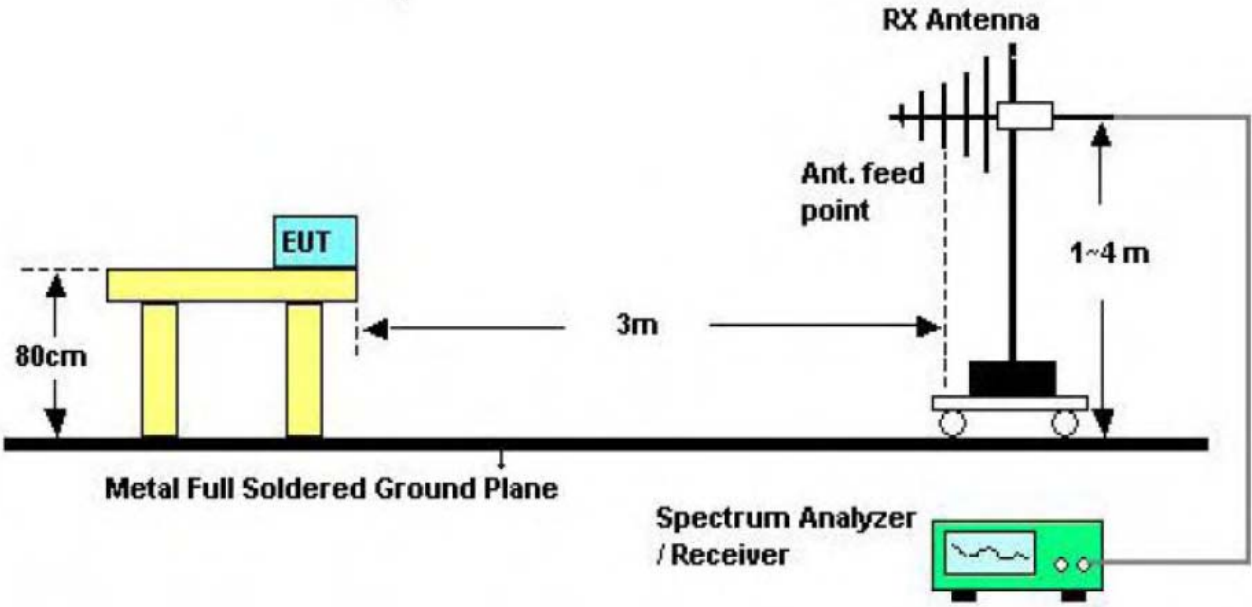

Below 1000MHz Test Setup

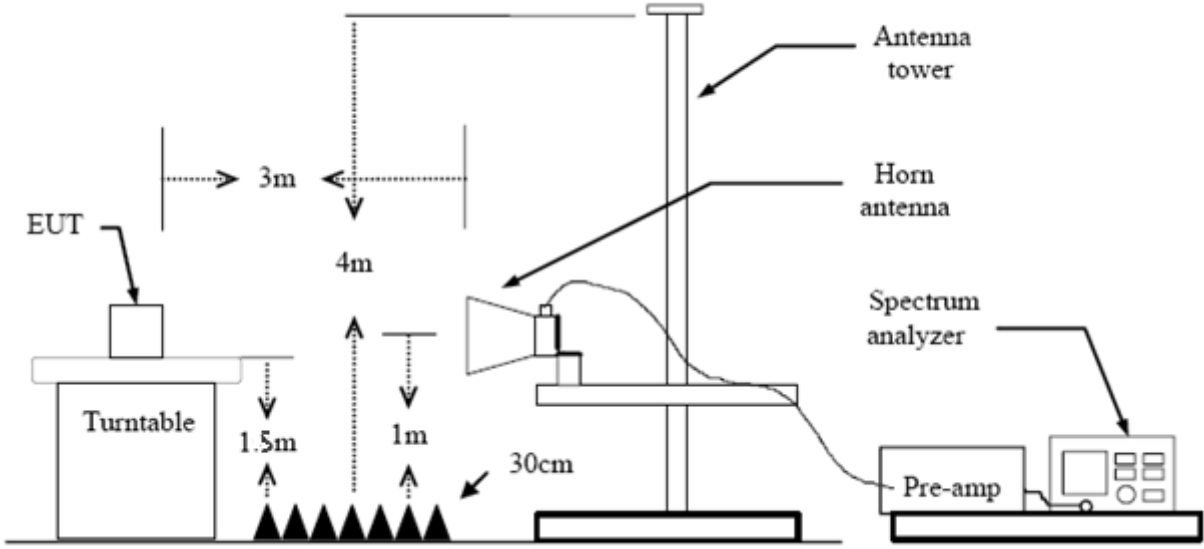

Above 1GHz Test Setup

5.3 Test Procedure

- (1) The measuring distance of 3m shall be used for measurements at frequency up to 1GHz. The EUT was placed on a rotating 0.8m high above the ground, the table was rotated 360 degrees to determine the position of the highest radiation.
- (2) Measurements at frequency above 1GHz. The EUT was placed on a rotating 1.5m high above the ground. RF absorbers covered the ground plane with a minimum area of 3.0m by 3.0m between the EUT and measurement receiver antenna. The RF absorber shall not exceed 30cm in high above the conducting floor. The table was rotated 360 degrees to determine the position of the highest radiation.
- (3) The Test antenna shall vary between 1m and 4m, Both Horizontal and Vertical antenna are set to make measurement.
- (4) The initial step in collecting conducted emission data is a spectrum analyzer peak detector mode pre-scanning the measurement frequency range. Significant peaks are then marked and then Quasi Peak detector mode re-measured.
- (5) If the Peak Mode measured value compliance with and lower than Quasi Peak Mode Limit Bellow 1 GHz, the EUT shall be deemed to meet QP Limits and then no additional QP Mode measurement performed. But the Peak Value and average value both need to comply with applicable limit above 1 GHz.
- (6) Testing frequency range below 1GHz the measuring instrument use VBW=120 kHz with Quasi-peak detection.
- (7) Testing frequency range above 1GHz the measuring instrument use RBW=1 MHz and VBW=3 MHz with Peak Detector for Peak Values, and use RBW=1 MHz and VBW=10 Hz with Peak Detector for Average Values.
- (8) For the actual test configuration, please see the test setup photo.

5.4 EUT Operating Condition

The Equipment Under Test was set to Continual Transmitting in maximum power.

5.5 Test Data

Remark: During testing above 1GHz the measuring instrument use RBW=1 MHz and VBW=3 MHz with Peak Detector for Peak Values, and use RBW=1 MHz and VBW=10 Hz with Peak Detector for Average Values.

Please refer to the Attachment B.

6. Band Edge Emissions

6.1 Test Standard and Limit

6.1.1 Test Standard

FCC Part 15.407(b)

6.1.2 Test Limit

Limits of unwanted emission out of the restricted bands

Frequency (MHz)	EIRP Limits (dBm)	Equivalent Field Strength at 3m (dBuV/m)
5150~5250	-27	68.3
5250~5350	-27	68.3
5470~5725	-27	68.3
5725~5825	-27(Note 2)	68.3
	10(Note 2)	105.3
	15.6(Note 2)	110.9
	27(Note 2)	122.3

NOTE:

1, The following formula is used to convert the equipment isotropic radiated power (eirp) to field strength:

$$E = \frac{1000000\sqrt{30P}}{3} \text{ uV/m, where P is the eirp (Watts)}$$

2, According to FCC 16-24, All emissions shall be limited to a level of -27 dBm/MHz at 75 MHz or more above or below the band edge increasing linearly to 10 dBm/MHz at 25 MHz above or below the band edge, and from 25MHz above or below the band edge increasing linearly to a level of 15.6 dBm/MHz at 5 MHz above or below the band edge, and from 5 MHz above or below the band edge increasing linearly to a level of 27dBm/MHz at the band edge.

6.2 Test Setup

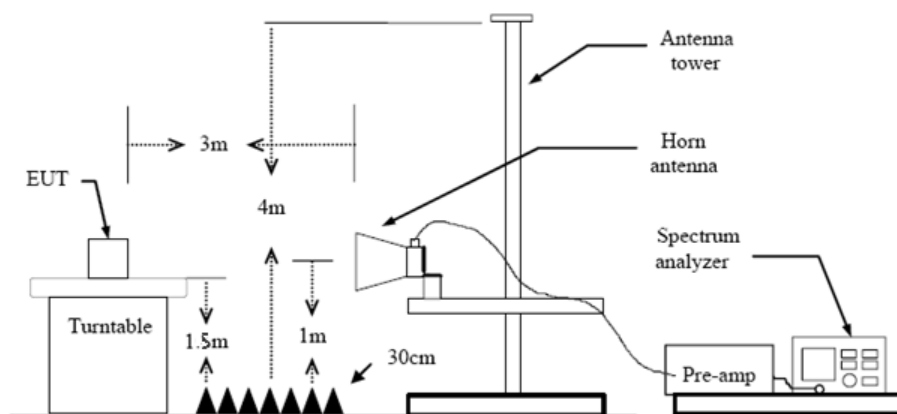

6.3 Test Procedure

- (1) The measuring distance of 3m shall be used for measurements at frequency up to 1GHz. The EUT was placed on a rotating 0.8m high above the ground, the table was rotated 360 degrees to determine the position of the highest radiation.
- (2) Measurements at frequency above 1GHz. The EUT was placed on a rotating 1.5m high above the ground. RF absorbers covered the ground plane with a minimum area of 3.0m by 3.0m between the EUT and measurement receiver antenna. The RF absorber shall not exceed 30cm in high above the conducting floor. The table was rotated 360 degrees to determine the position of the highest radiation.
- (3) The Test antenna shall vary between 1m and 4m, Both Horizontal and Vertical antenna are set to make measurement.
- (4) The initial step in collecting conducted emission data is a spectrum analyzer peak detector mode pre-scanning the measurement frequency range. Significant peaks are then marked and then Quasi Peak detector mode re-measured.
- (5) If the Peak Mode measured value compliance with and lower than Quasi Peak Mode Limit Bellow 1 GHz, the EUT shall be deemed to meet QP Limits and then no additional QP Mode measurement performed. But the Peak Value and average value both need to comply with applicable limit above 1 GHz.
- (6) Testing frequency range below 1GHz the measuring instrument use VBW=120 kHz with Quasi-peak detection.
- (7) Testing frequency range above 1GHz the measuring instrument use RBW=1 MHz and VBW=3 MHz with Peak Detector for Peak Values, and use RBW=1 MHz and VBW=10 Hz with Peak Detector for Average Values.
- (8) For the actual test configuration, please see the test setup photo.

6.4 EUT Operating Condition

The Equipment Under Test was set to Continual Transmitting in maximum power.

6.5 Test Data

Please refer to the Attachment C.

7. Bandwidth Test

7.1 Test Standard and Limit

- 7.1.1 Test Standard
FCC Part 15.407
- 7.1.2 Test Limit

FCC Part 15 Subpart C(15.407)/RSS-210		
Test Item	Limit	Frequency Range (MHz)
26 Bandwidth	N/A	5150~5250
		5250~5350
		5500~5700
6 dB Bandwidth	>500kHz	5725~5850

7.2 Test Setup

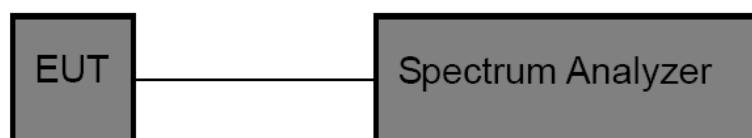

7.3 Test Procedure

- (1) The EUT was directly connected to the spectrum analyzer and antenna output port as show in the block diagram above.
- (2) The setting of the spectrum analyser as below:

26dB Bandwidth Test	
Spectrum Parameters	Setting
Attenuation	Auto
Span	>26 dB Bandwidth
RBW	Approximately 1% of the emission bandwidth
VBW	VBW>RBW
Detector	Peak
Trace	Max Hold
Sweep Time	Auto

6dB Bandwidth Test	
Spectrum Parameters	Setting
Attenuation	Auto
Span	>6 dB Bandwidth
RBW	100 kHz
VBW	VBW>=3*RBW
Detector	Peak
Trace	Max Hold
Sweep Time	Auto
99% Occupied Bandwidth Test	
Spectrum Parameters	Setting
Attenuation	Auto
RBW	1% to 5% of the OBW
VBW	≥ 3RBW
Detector	Peak
Trace	Max Hold

7.4 EUT Operating Condition

The EUT was set to continuously transmitting in each mode and low, Middle and high channel for the test.

7.5 Test Data

Please refer to the Attachment D.

8. Output Power Test

8.1 Test Standard and Limit

8.1.1 Test Standard

FCC Part 15.407 (a)

8.1.2 Test Limit

FCC Part 15 Subpart E(15.407)/RSS-210		
Test Item	Limit	Frequency Range(MHz)
Conducted Output Power	Fixed: 1 Watt (30dBm) Mobile and Portable: 250mW (24dBm)	5150~5250
	250mW (24dBm)	5250~5350
	250mW (24dBm)	5500~5700
	1 Watt (30dBm)	5725~5850

8.2 Test Setup

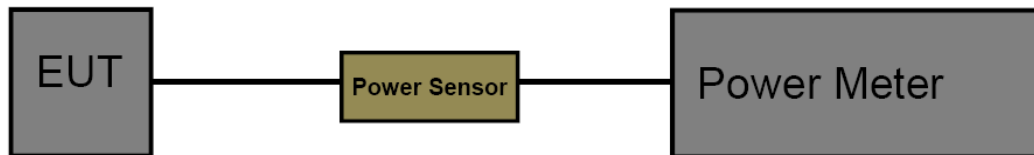

8.3 Test Procedure

The measurement is according to section 3 of KDB 789033 D02 General U-NII Test Procedures New Rules v02r01.

The EUT was connected to RF power meter via a broadband power sensor as show the block above.

8.4 EUT Operating Condition

The EUT was set to continuously transmitting in the max power during the test.

8.5 Test Date

Please refer to the Attachment E.

9. Power Spectral Density Test

9.1 Test Standard and Limit

9.1.1 Test Standard

FCC Part 15.407 (a)

9.1.2 Test Limit

FCC Part 15 Subpart E(15.407)		
Test Item	Limit	Frequency Range(MHz)
Power Spectral Density	Other than Mobile and Portable : 17dBm/MHz Mobile and Portable : 11dBm/MHz	5150~5250
	11dBm/MHz	5250~5350
	11dBm/MHz	5500~5700
	30dBm/500kHz	5725~5850

9.2 Test Setup

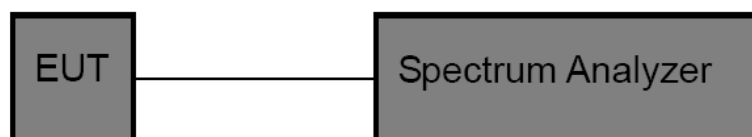

9.3 Test Procedure

The EUT was directly connected to the Spectrum Analyzer and antenna output port as show in the block diagram above. The measurement is according to KDB 789033 D02 General U-NII Test Procedures New Rules v02r01.

- (1) The EUT was directly connected to the spectrum analyzer and antenna output port as show in the block diagram above.
- (2) Set analyser centre frequency to transmitting frequency.
- (3) Set the span to encompass the entire emissions bandwidth (EBW)(alternatively, the entire 99% OBW) of the signal.
- (4) Set the RBW to: 1 MHz
- (5) Set the VBW to: 3 MHz
- (6) Detector: RMS
- (7) Trace: Max Hold
- (7) Sweep time: auto
- (8) Trace average at least 100 traces in power averaging.

- (9) Use the peak marker function to determine the maximum amplitude level within the RBW. Apply correction to the result if different RBW is used.

9.4 EUT Operating Condition

The EUT was set to continuously transmitting in each mode and low, Middle and high channel for the test.

9.5 Test Data

Please refer to the Attachment F.

10. Frequency Stability Measurement

10.1 Test Standard and Limit

10.1.1 Test Standard

FCC Part 15.407

10.1.2 Test Limit

FCC Part 15 Subpart C(15.407)		
Test Item	Limit	Frequency Range(MHz)
Peak Excursion Measurement	Specified in the user's manual, the transmitter center frequency tolerance shall be ± 20 ppm maximum for the 5 GHz band (IEEE 802.11n specification)	5150~5250
		5250~5350
		5500~5700
		5725~5850

10.2 Test Setup

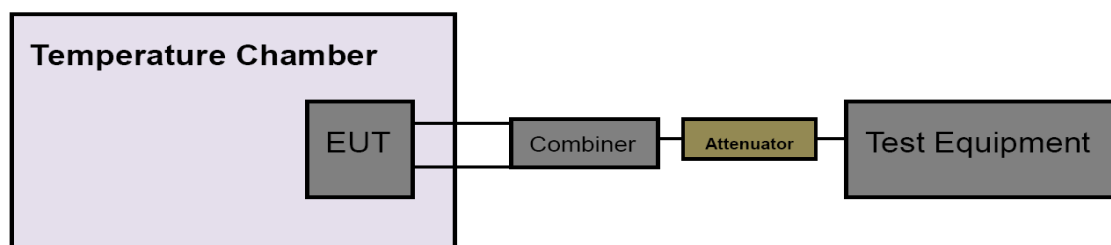

10.3 Test Procedure

The EUT was directly connected to the Spectrum Analyzer and antenna output port as show in the block diagram above.

- (1) The EUT was directly connected to the spectrum analyzer and antenna output port as show in the block diagram above.
- (2) Set analyser centre frequency to transmitting frequency.
- (3) Set the span to encompass the entire emissions bandwidth (EBW) of the signal.
- (4) Set the RBW to: 10 kHz, VBW=10 kHz with peak detector and maxhold settings.
- (5) The test extreme voltage is to change the primary supply voltage from 85 to 115 percent of the nominal value.
- (6) Extreme temperature is 0°C~50°C

10.4 EUT Operating Condition

The EUT was set to continuously transmitting in continuously un-modulation transmitting mode. Please refer to the Attachment G.

11. Antenna Requirement

11.1 Standard Requirement

11.1.1 Standard

FCC Part 15.203

11.1.2 Requirement

An intentional radiator shall be designed to ensure that no antenna other than that furnished by the responsible party shall be used with the device. The use of a permanently attached antenna or of an antenna that uses a unique coupling to the intentional radiator shall be considered sufficient to comply with the provisions of this Section. The manufacturer may design the unit so that a broken antenna can be replaced by the user, but the use of a standard antenna jack or electrical connector is prohibited.

11.2 Antenna Connected Construction

The gains of the antenna used for transmitting is 2 dBi, and the antenna de-signed with permanent attachment and no consideration of replacement. Please see the EUT photo for details.

11.3 Result

The EUT antennas are FPC Antenna. It complies with the standard requirement.

Antenna Type
<input type="checkbox"/> Permanent attached antenna
<input checked="" type="checkbox"/> Unique connector antenna
<input type="checkbox"/> Professional installation antenna

Attachment A-- Conducted Emission Test Data

Remark: All channels have been tested and Shows only the worst channels.

Temperature:	25 °C	Relative Humidity:	55%
Test Voltage:	AC 120V/60 Hz		
Terminal:	Line		
Test Mode:	AC Charging with TX 802.11a Mode CH36		
Remark:	Only worse case is reported		

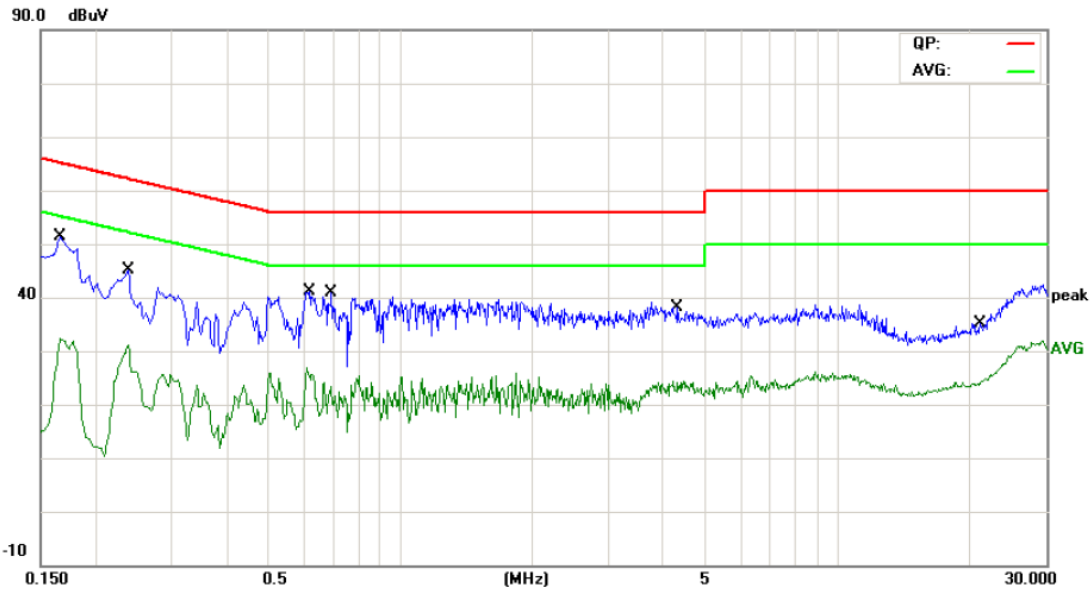

No.	Mk.	Freq.	Reading Level	Correct Factor	Measurement	Limit	Over	
		MHz	dBuV	dB	dBuV	dBuV	dB	Detector
1	*	0.1660	38.27	9.58	47.85	65.15	-17.30	QP
2		0.1660	17.84	9.58	27.42	55.15	-27.73	AVG
3		0.2380	29.53	9.58	39.11	62.16	-23.05	QP
4		0.2380	17.26	9.58	26.84	52.16	-25.32	AVG
5		0.6180	28.94	9.61	38.55	56.00	-17.45	QP
6		0.6180	15.67	9.61	25.28	46.00	-20.72	AVG
7		0.6940	27.30	9.61	36.91	56.00	-19.09	QP
8		0.6940	11.15	9.61	20.76	46.00	-25.24	AVG
9		4.3020	22.40	9.70	32.10	56.00	-23.90	QP
10		4.3020	13.33	9.70	23.03	46.00	-22.97	AVG
11		21.1820	18.49	10.56	29.05	60.00	-30.95	QP
12		21.1820	12.89	10.56	23.45	50.00	-26.55	AVG

*:Maximum data x:Over limit !:over margin

Emission Level= Read Level+ Correct Factor

Temperature:	25 °C	Relative Humidity:	55%
Test Voltage:	AC 120V/60 Hz		
Terminal:	Neutral		
Test Mode:	AC Charging with TX 802.11a Mode CH36		
Remark:	Only worse case is reported		

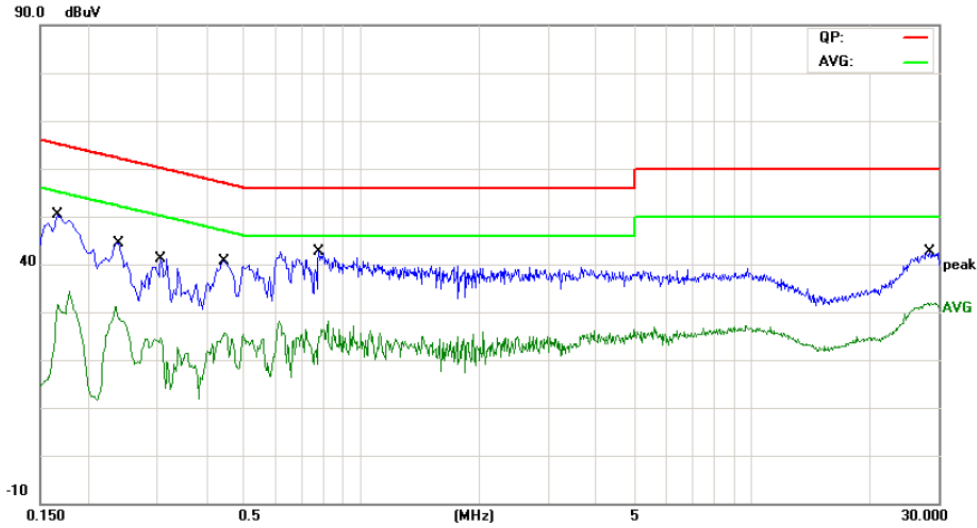

No.	Mk.	Freq. MHz	Reading Level dBuV	Correct Factor dB	Measure- ment dBuV	Limit dBuV	Over dB	Detector
1		0.1660	36.83	9.58	46.41	65.15	-18.74	QP
2		0.1660	16.21	9.58	25.79	55.15	-29.36	AVG
3		0.2380	29.70	9.58	39.28	62.16	-22.88	QP
4		0.2380	18.77	9.58	28.35	52.16	-23.81	AVG
5		0.3060	27.07	9.59	36.66	60.08	-23.42	QP
6		0.3060	13.17	9.59	22.76	50.08	-27.32	AVG
7		0.4460	26.48	9.60	36.08	56.95	-20.87	QP
8		0.4460	12.87	9.60	22.47	46.95	-24.48	AVG
9	*	0.7780	29.40	9.61	39.01	56.00	-16.99	QP
10		0.7780	14.57	9.61	24.18	46.00	-21.82	AVG
11		28.5020	25.69	10.78	36.47	60.00	-23.53	QP
12		28.5020	20.24	10.78	31.02	50.00	-18.98	AVG

*:Maximum data x:Over limit !:over margin

Emission Level= Read Level+ Correct Factor

Attachment B-- Radiated Emission Test Data

9 KHz~30 MHz

From 9 KHz to 30 MHz: Conclusion: PASS

Note: The amplitude of spurious emissions which are attenuated by more than 20dB below the permissible value has no need to be reported.

30MHz~1GHz

Temperature:	25 °C	Relative Humidity:	55%
Test Voltage:	AC 120V/60Hz		
Ant. Pol.	Horizontal		
Test Mode:	TX 802.11a Mode 5180MHz (U-NII-1)		
Remark:	Only worse case is reported		

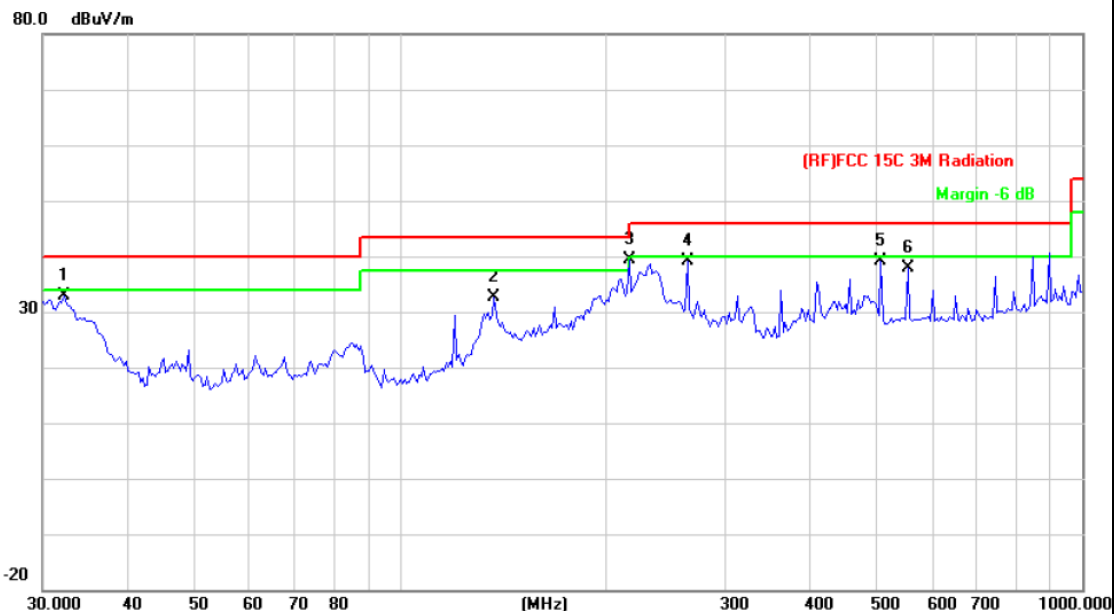

No.	Mk.	Freq. MHz	Reading Level dBuV	Correct Factor dB/m	Measure- ment dBuV/m	Limit dBuV/m	Over dB	Detector
1		32.1794	15.76	17.16	32.92	40.00	-7.08	peak
2		137.4199	23.33	9.27	32.60	43.50	-10.90	peak
3	*	216.7828	26.69	12.68	39.37	46.00	-6.63	peak
4		263.8190	24.32	14.80	39.12	46.00	-6.88	peak
5		506.4791	17.85	21.22	39.07	46.00	-6.93	peak
6		554.8251	15.32	22.59	37.91	46.00	-8.09	peak

*:Maximum data x:Over limit !:over margin

Emission Level= Read Level+ Correct Factor

Temperature:	25 °C	Relative Humidity:	55%
Test Voltage:	AC 120V/60Hz		
Ant. Pol.	Vertical		
Test Mode:	TX 802.11a Mode 5180MHz (U-NII-1)		
Remark:	Only worse case is reported.		

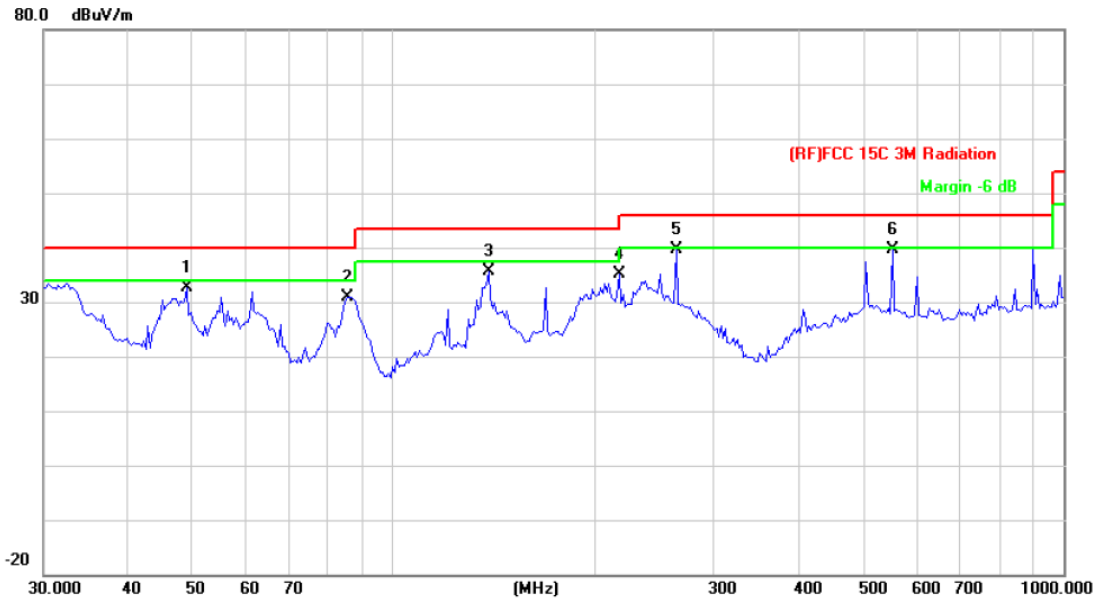

No.	Mk.	Freq. MHz	Reading Level dBuV	Correct Factor dB/m	Measure- ment dBuV/m	Limit dBuV/m	Over dB	Detector
1		49.0144	23.70	8.88	32.58	40.00	-7.42	peak
2		85.2980	21.46	9.53	30.99	40.00	-9.01	peak
3		138.3873	26.37	9.27	35.64	43.50	-7.86	peak
4		216.7828	22.49	12.68	35.17	46.00	-10.83	peak
5	*	263.8190	24.89	14.80	39.69	46.00	-6.31	peak
6		554.8251	16.92	22.59	39.51	46.00	-6.49	peak

*:Maximum data x:Over limit !:over margin

Emission Level= Read Level+ Correct Factor

5180MHz-5250MHz(U-NII-1)

Temperature:	25 °C	Relative Humidity:	55%
Test Voltage:	AC 120V/60Hz		
Ant. Pol.	Horizontal		
Test Mode:	TX 802.11a Mode 5180MHz (U-NII-1) Main Antenna		
Remark:	No report for the emission which more than 10 dB below the prescribed limit. Only worse case is reported.		

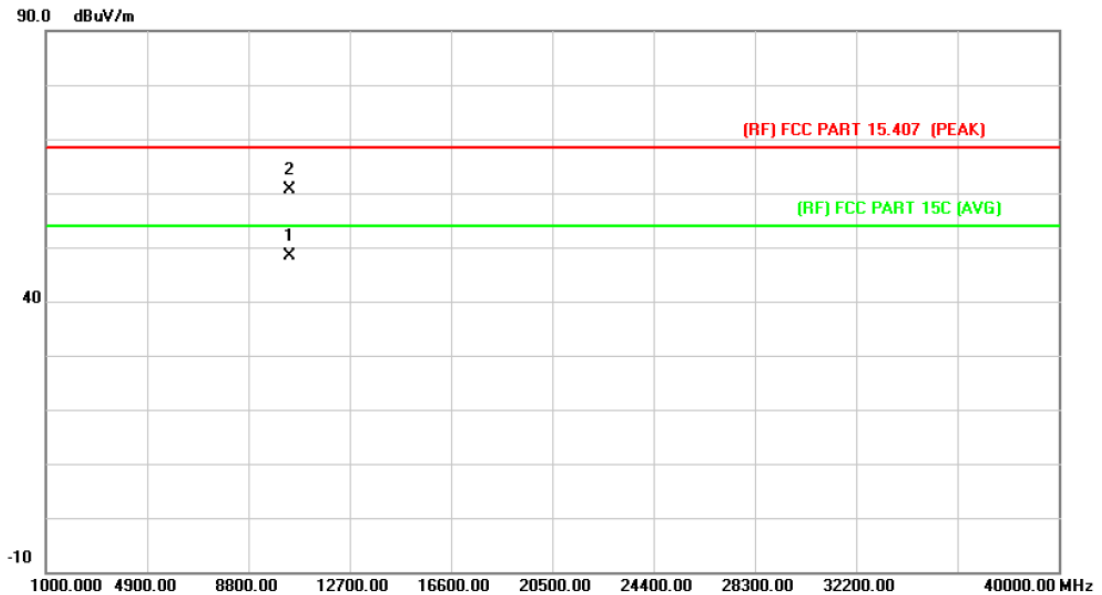

No.	Mk.	Freq.	Reading Level	Correct Factor	Measurement	Limit	Over	Detector
		MHz	dBuV	dB/m	dBuV/m	dBuV/m	dB	
1	*	10360.540	32.69	15.59	48.28	54.00	-5.72	AVG
2		10360.683	45.12	15.60	60.72	68.30	-7.58	peak

Emission Level= Read Level+ Correct Factor

Temperature:	25 °C	Relative Humidity:	55%
Test Voltage:	AC 120V/60Hz		
Ant. Pol.	Vertical		
Test Mode:	TX 802.11a Mode 5180MHz (U-NII-1) Main Antenna		
Remark:	No report for the emission which more than 10 dB below the prescribed limit. Only worse case is reported.		

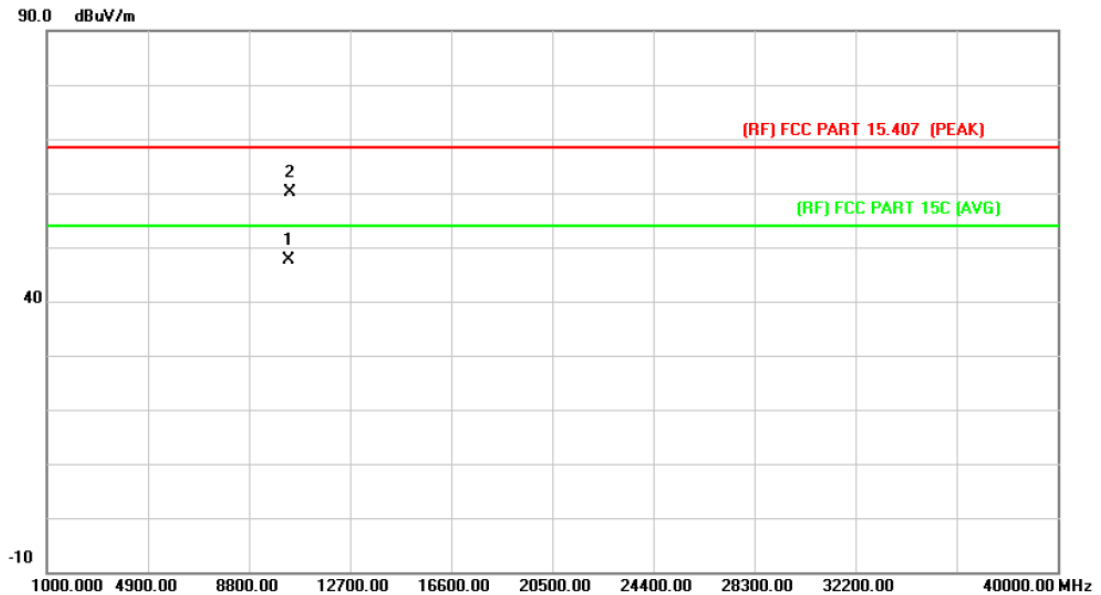

No.	Mk.	Freq.	Reading Level	Correct Factor	Measurement	Limit	Over	
		MHz	dBuV	dB/m	dBuV/m	dBuV/m	dB	Detector
1	*	10359.775	32.05	15.58	47.63	54.00	-6.37	AVG
2		10363.075	44.49	15.60	60.09	68.30	-8.21	peak

Emission Level= Read Level+ Correct Factor

Temperature:	25 °C	Relative Humidity:	55%
Test Voltage:	AC 120V/60Hz		
Ant. Pol.	Horizontal		
Test Mode:	TX 802.11a Mode 5200MHz (U-NII-1) Main+AUX Antenna		
Remark:	No report for the emission which more than 10 dB below the prescribed limit.		

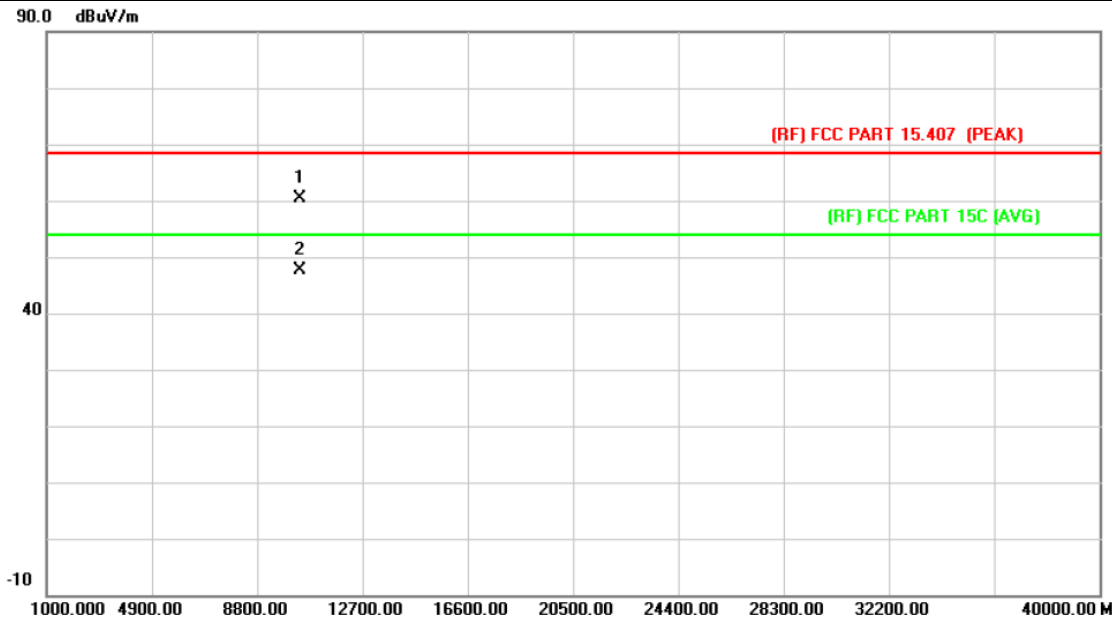

No.	Mk.	Freq. MHz	Reading Level dBuV	Correct Factor dB/m	Measure- ment dBuV/m	Limit dBuV/m	Over dB	Detector
1		10399.138	44.79	15.66	60.45	68.30	-7.85	peak
2	*	10401.440	31.88	15.66	47.54	54.00	-6.46	AVG

Emission Level= Read Level+ Correct Factor

Temperature:	25 °C	Relative Humidity:	55%
Test Voltage:	AC 120V/60Hz		
Ant. Pol.	Vertical		
Test Mode:	TX 802.11a Mode 5200MHz (U-NII-1) Main+AUX Antenna		
Remark:	No report for the emission which more than 10 dB below the prescribed limit.		

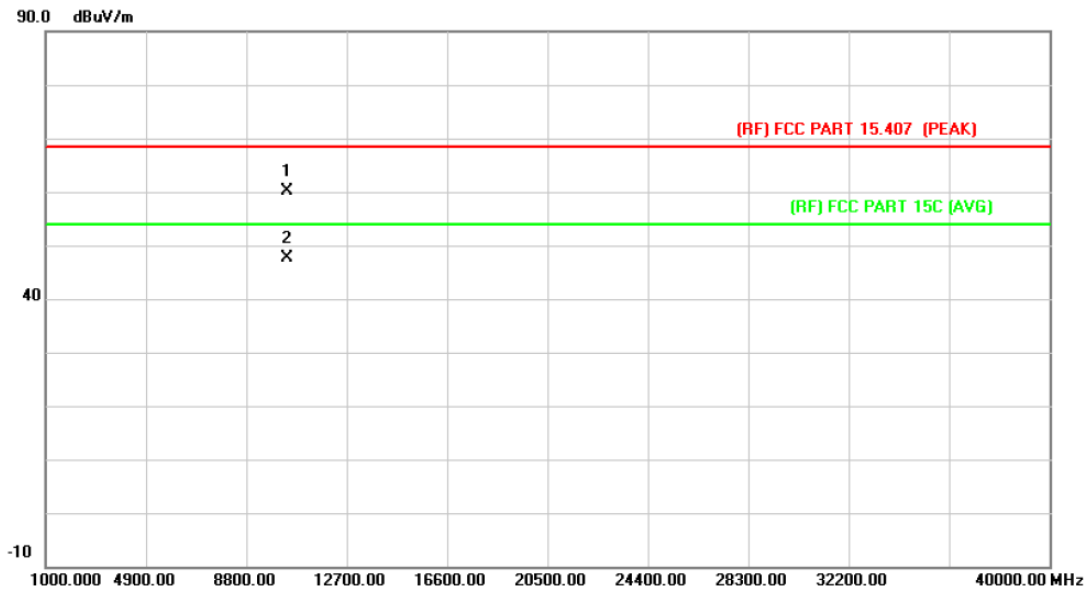

No.	Mk.	Freq. MHz	Reading Level dBuV	Correct Factor dB/m	Measure- ment dBuV/m	Limit dBuV/m	Over dB	Detector
1		10398.935	44.49	15.65	60.14	68.30	-8.16	peak
2	*	10400.712	31.92	15.66	47.58	54.00	-6.42	AVG

Emission Level= Read Level+ Correct Factor

Temperature:	25 °C	Relative Humidity:	55%
Test Voltage:	AC 120V/60Hz		
Ant. Pol.	Horizontal		
Test Mode:	TX 802.11a Mode 5240MHz (U-NII-1) Main+AUX Antenna		
Remark:	No report for the emission which more than 10 dB below the prescribed limit.		

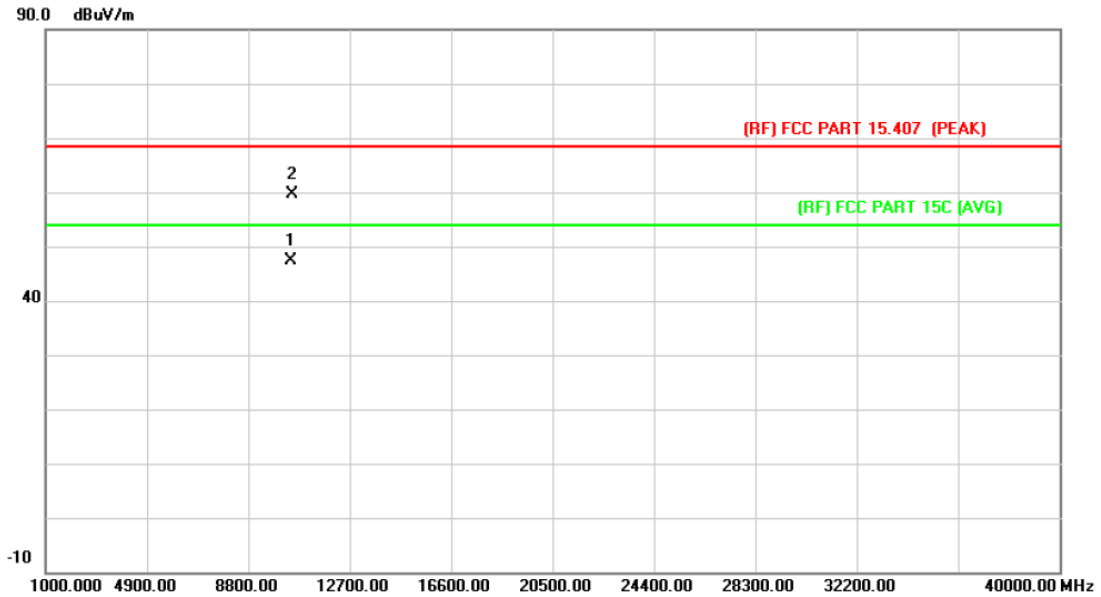

No.	Mk.	Freq.	Reading Level	Correct Factor	Measurement	Limit	Over	
		MHz	dBuV	dB/m	dBuV/m	dBuV/m	dB	Detector
1	*	10462.400	31.70	15.76	47.46	54.00	-6.54	AVG
2		10467.400	43.96	15.78	59.74	68.30	-8.56	peak

Emission Level= Read Level+ Correct Factor

Temperature:	25 °C	Relative Humidity:	55%
Test Voltage:	AC 120V/60Hz		
Ant. Pol.	Vertical		
Test Mode:	TX 802.11a Mode 5240MHz (U-NII-1) Main+AUX Antenna		
Remark:	No report for the emission which more than 10 dB below the prescribed limit.		

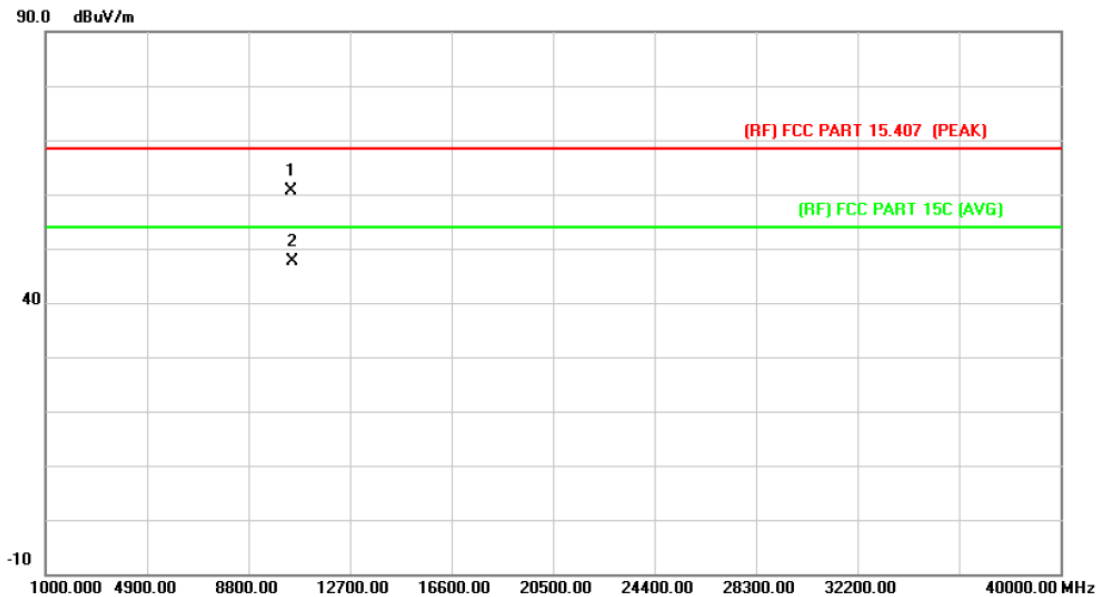

No.	Mk.	Freq.	Reading Level	Correct Factor	Measurement	Limit	Over	Detector
		MHz	dBuV	dB/m	dBuV/m	dBuV/m	dB	
1		10462.300	44.98	15.76	60.74	68.30	-7.56	peak
2	*	10475.200	31.76	15.78	47.54	54.00	-6.46	AVG

Emission Level= Read Level+ Correct Factor

Temperature:	25 °C	Relative Humidity:	55%
Test Voltage:	AC 120V/60Hz		
Ant. Pol.	Horizontal		
Test Mode:	TX 802.11n(20) Mode 5180MHz (U-NII-1) Main+AUX Antenna		
Remark:	No report for the emission which more than 10 dB below the prescribed limit.		

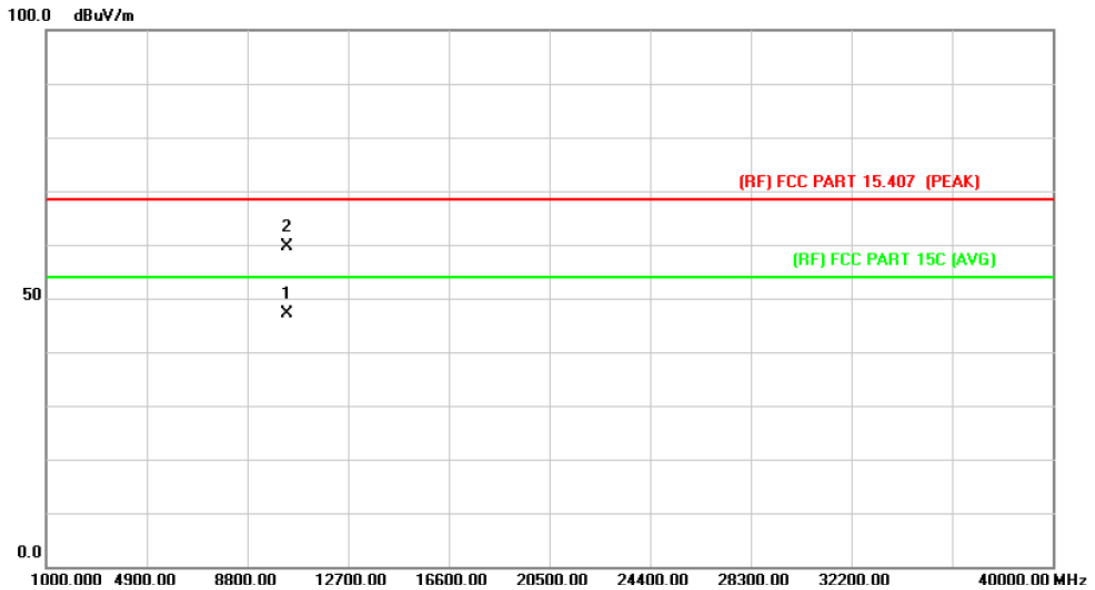

No.	Mk.	Freq.	Reading Level	Correct Factor	Measurement	Limit	Over	
		MHz	dBuV	dB/m	dBuV/m	dBuV/m	dB	Detector
1	*	10358.476	31.58	15.57	47.15	54.00	-6.85	AVG
2		10359.928	44.10	15.58	59.68	68.30	-8.62	peak

Emission Level= Read Level+ Correct Factor

Temperature:	25 °C	Relative Humidity:	55%
Test Voltage:	AC 120V/60Hz		
Ant. Pol.	Vertical		
Test Mode:	TX 802.11n(20) Mode 5180MHz (U-NII-1) Main+AUX Antenna		
Remark:	No report for the emission which more than 10 dB below the prescribed limit.		

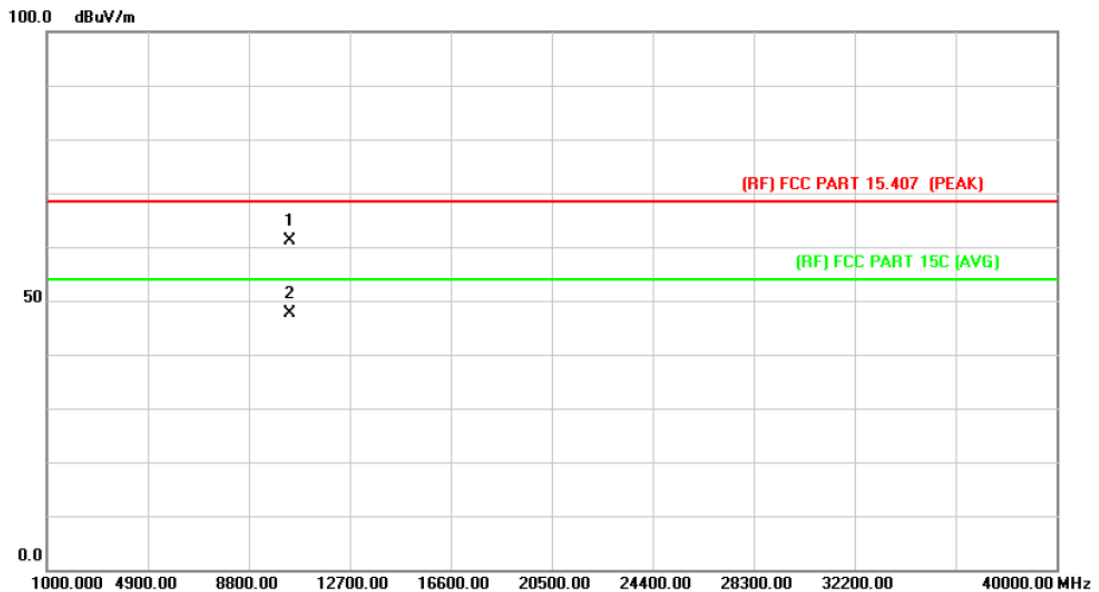

No.	Mk.	Freq.	Reading Level	Correct Factor	Measurement	Limit	Over	Detector
		MHz	dBuV	dB/m	dBuV/m	dBuV/m	dB	
1		10361.289	45.63	15.60	61.23	68.30	-7.07	peak
2	*	10365.486	31.98	15.60	47.58	54.00	-6.42	AVG

Emission Level= Read Level+ Correct Factor

Temperature:	25 °C	Relative Humidity:	55%
Test Voltage:	AC 120V/60Hz		
Ant. Pol.	Horizontal		
Test Mode:	TX 802.11n(20) Mode 5200MHz (U-NII-1) Main+AUX Antenna		
Remark:	No report for the emission which more than 10 dB below the prescribed limit.		

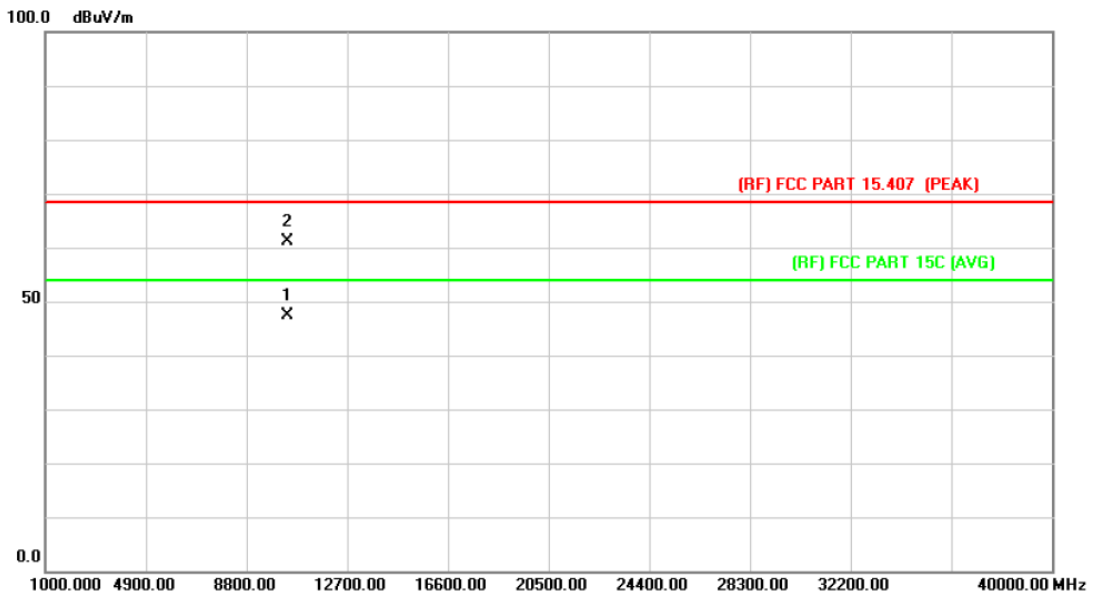

No.	Mk.	Freq.	Reading Level	Correct Factor	Measurement	Limit	Over	Detector
		MHz	dBuV	dB/m	dBuV/m	dBuV/m	dB	
1	*	10400.875	31.80	15.66	47.46	54.00	-6.54	AVG
2		10401.321	45.58	15.66	61.24	68.30	-7.06	peak

Emission Level= Read Level+ Correct Factor

Temperature:	25 °C	Relative Humidity:	55%
Test Voltage:	AC 120V/60Hz		
Ant. Pol.	Vertical		
Test Mode:	TX 802.11n(20) Mode 5200MHz (U-NII-1) Main+AUX Antenna		
Remark:	No report for the emission which more than 10 dB below the prescribed limit.		

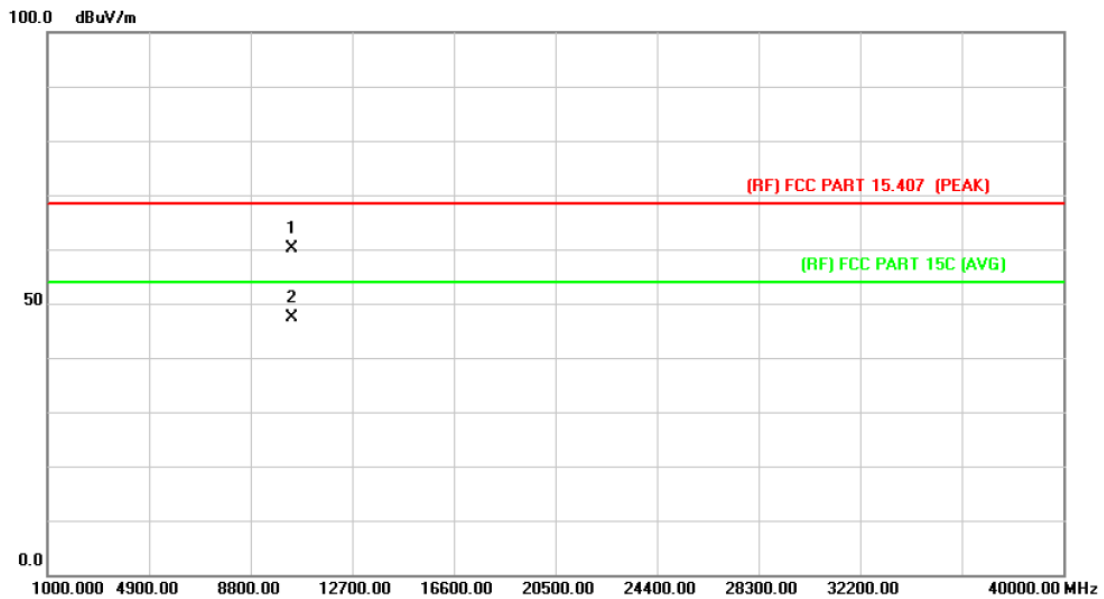

No.	Mk.	Freq. MHz	Reading Level dBuV	Correct Factor dB/m	Measure- ment dBuV/m	Limit dBuV/m	Over dB	Detector
1		10400.615	44.50	15.66	60.16	68.30	-8.14	peak
2	*	10402.238	31.61	15.66	47.27	54.00	-6.73	AVG

Emission Level= Read Level+ Correct Factor

Temperature:	25 °C	Relative Humidity:	55%
Test Voltage:	AC 120V/60Hz		
Ant. Pol.	Horizontal		
Test Mode:	TX 802.11n(20) Mode 5240MHz (U-NII-1) Main+AUX Antenna		
Remark:	No report for the emission which more than 10 dB below the prescribed limit.		

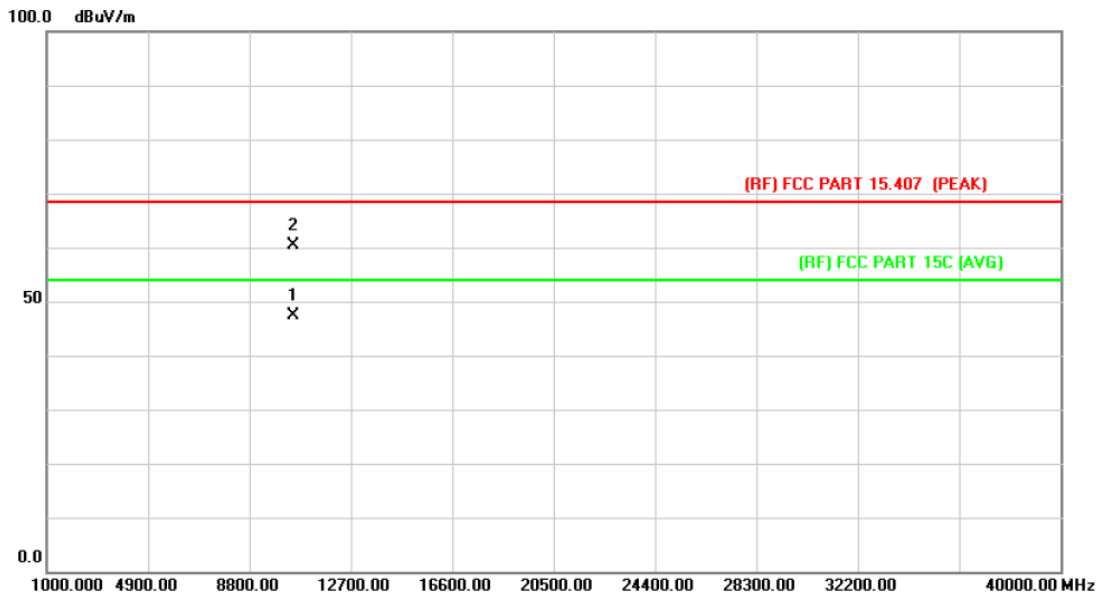

No.	Mk.	Freq.	Reading Level	Correct Factor	Measurement	Limit	Over	Detector
		MHz	dBuV	dB/m	dBuV/m	dBuV/m	dB	
1	*	10478.364	31.71	15.79	47.50	54.00	-6.50	AVG
2		10481.378	44.57	15.79	60.36	68.30	-7.94	peak

Emission Level= Read Level+ Correct Factor

Temperature:	25 °C	Relative Humidity:	55%
Test Voltage:	AC 120V/60Hz		
Ant. Pol.	Vertical		
Test Mode:	TX 802.11n(20) Mode 5240MHz (U-NII-1) Main+AUX Antenna		
Remark:	No report for the emission which more than 10 dB below the prescribed limit.		

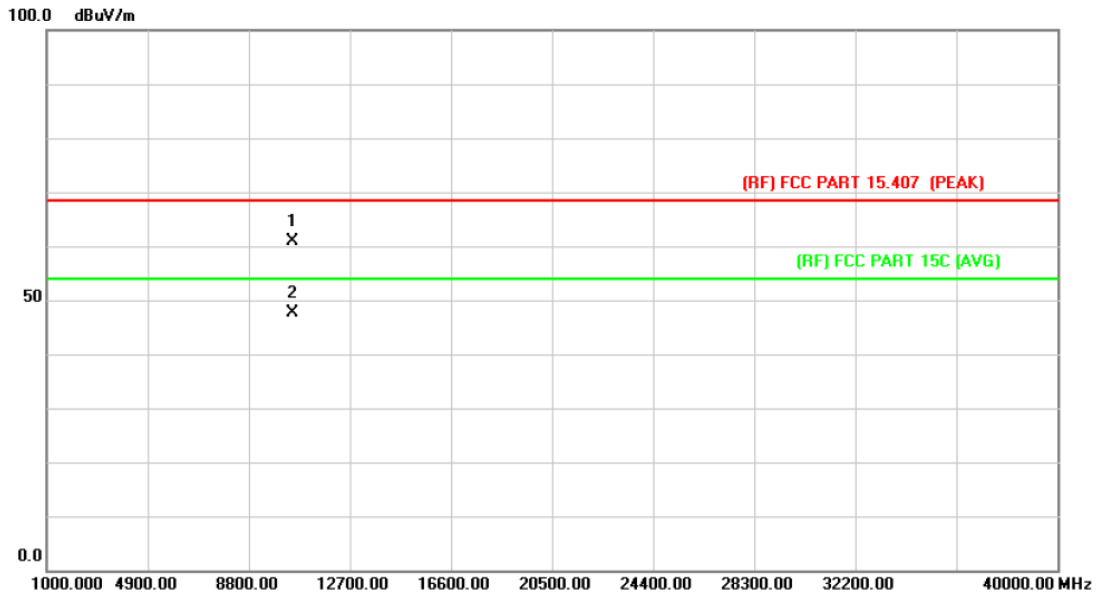

No.	Mk.	Freq.	Reading Level	Correct Factor	Measurement	Limit	Over	
		MHz	dBuV	dB/m	dBuV/m	dBuV/m	dB	Detector
1		10478.463	45.10	15.79	60.89	68.30	-7.41	peak
2	*	10480.635	31.86	15.79	47.65	54.00	-6.35	AVG

Emission Level= Read Level+ Correct Factor

Temperature:	25 °C	Relative Humidity:	55%
Test Voltage:	AC 120V/60Hz		
Ant. Pol.	Horizontal		
Test Mode:	TX 802.11ac(20) Mode 5180MHz (U-NII-1) Main+AUX Antenna		
Remark:	No report for the emission which more than 10 dB below the prescribed limit.		

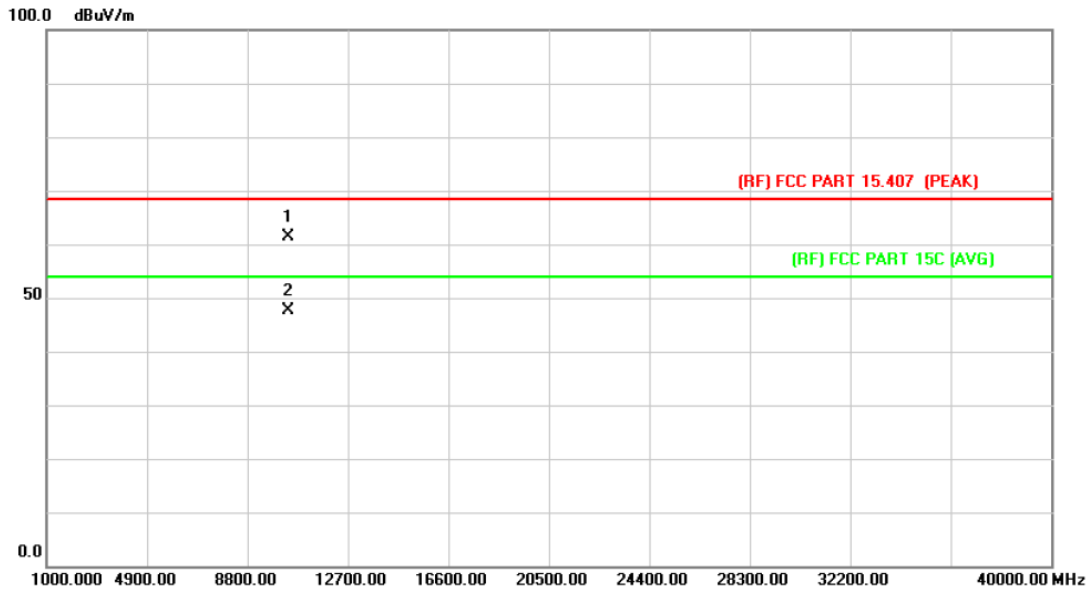

No.	Mk.	Freq.	Reading Level	Correct Factor	Measurement	Limit	Over	
		MHz	dBuV	dB/m	dBuV/m	dBuV/m	dB	Detector
1		10361.264	45.73	15.60	61.33	68.30	-6.97	peak
2	*	10364.458	32.02	15.60	47.62	54.00	-6.38	AVG

Emission Level= Read Level+ Correct Factor

Temperature:	25 °C	Relative Humidity:	55%
Test Voltage:	AC 120V/60Hz		
Ant. Pol.	Vertical		
Test Mode:	TX 802.11ac(20) Mode 5180MHz (U-NII-1) Main+AUX Antenna		
Remark:	No report for the emission which more than 10 dB below the prescribed limit.		

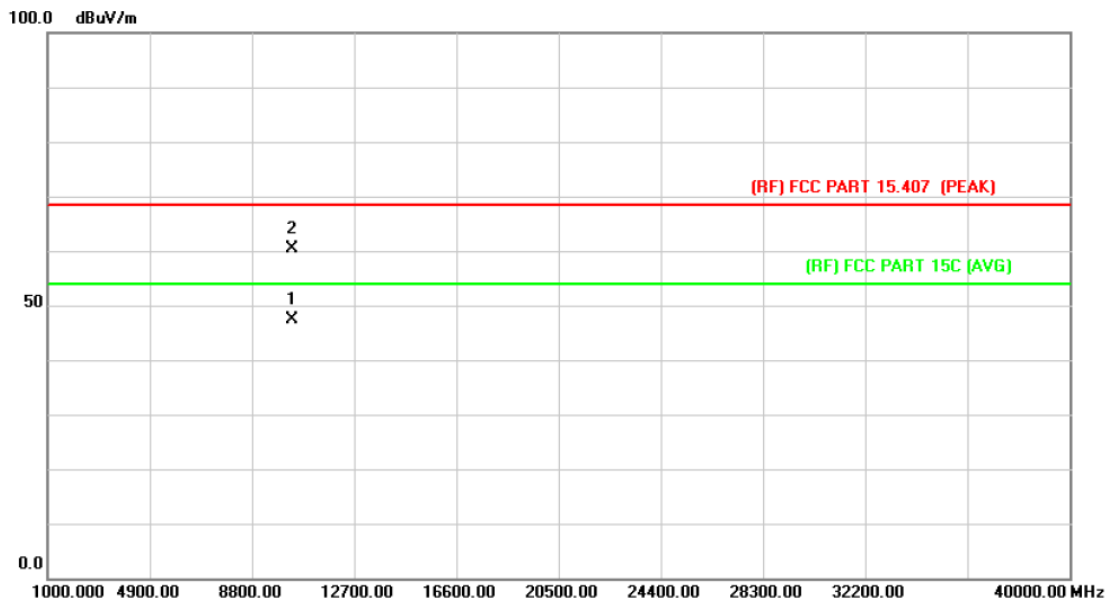

No.	Mk.	Freq.	Reading Level	Correct Factor	Measurement	Limit	Over	Detector
		MHz	dBuV	dB/m	dBuV/m	dBuV/m	dB	
1	*	10358.662	31.80	15.57	47.37	54.00	-6.63	AVG
2		10359.855	44.81	15.58	60.39	68.30	-7.91	peak

Emission Level= Read Level+ Correct Factor

Temperature:	25 °C	Relative Humidity:	55%
Test Voltage:	AC 120V/60Hz		
Ant. Pol.	Horizontal		
Test Mode:	TX 802.11ac(20) Mode 5200MHz (U-NII-1) Main+AUX Antenna		
Remark:	No report for the emission which more than 10 dB below the prescribed limit.		

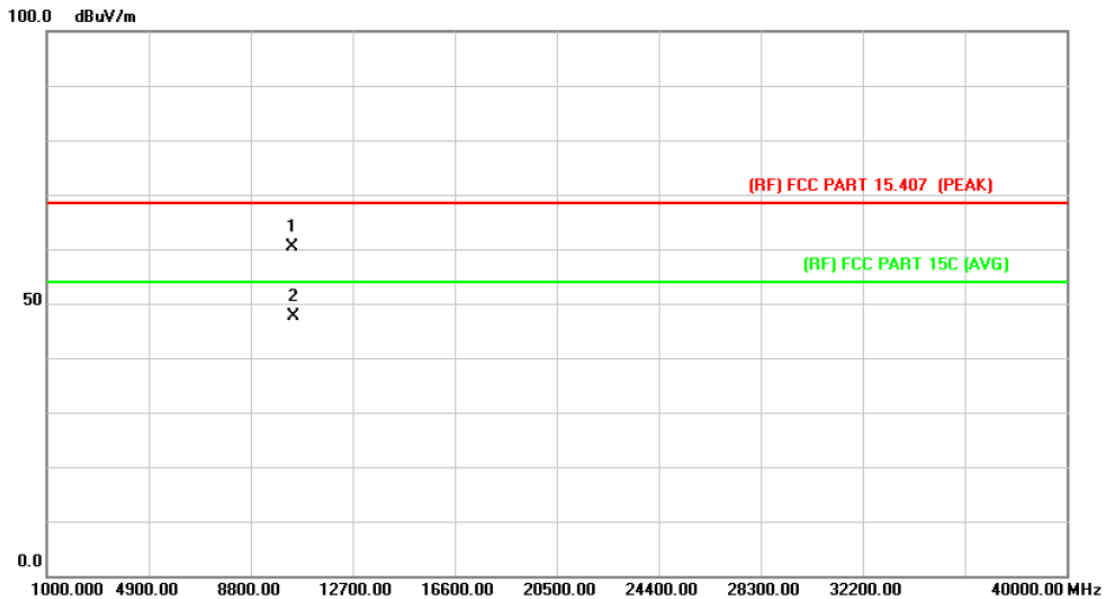

No.	Mk.	Freq. MHz	Reading Level dBuV	Correct Factor dB/m	Measure- ment dBuV/m	Limit dBuV/m	Over dB	Detector
1		10401.364	44.66	15.66	60.32	68.30	-7.98	peak
2	*	10442.207	31.83	15.73	47.56	54.00	-6.44	AVG

Emission Level= Read Level+ Correct Factor

Temperature:	25 °C	Relative Humidity:	55%
Test Voltage:	AC 120V/60Hz		
Ant. Pol.	Vertical		
Test Mode:	TX 802.11ac(20) Mode 5200MHz (U-NII-1) Main+AUX Antenna		
Remark:	No report for the emission which more than 10 dB below the prescribed limit.		

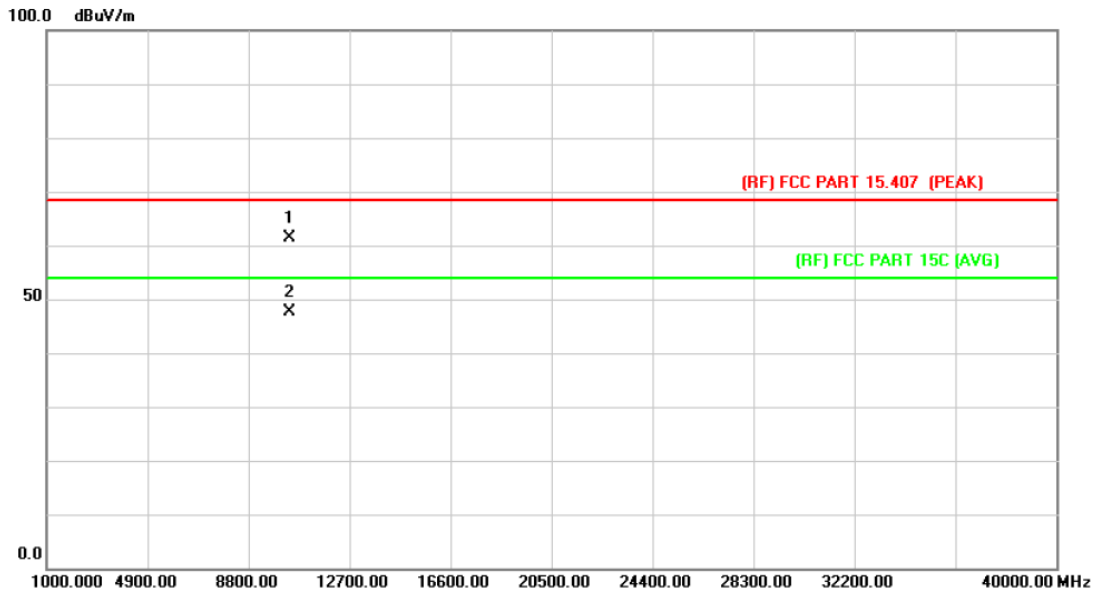

No.	Mk.	Freq. MHz	Reading Level dBuV	Correct Factor dB/m	Measure- ment dBuV/m	Limit dBuV/m	Over dB	Detector
1		10400.388	45.68	15.66	61.34	68.30	-6.96	peak
2	*	10401.813	32.02	15.66	47.68	54.00	-6.32	AVG

Emission Level= Read Level+ Correct Factor

Temperature:	25 °C	Relative Humidity:	55%
Test Voltage:	AC 120V/60Hz		
Ant. Pol.	Horizontal		
Test Mode:	TX 802.11ac(20) Mode 5240MHz (U-NII-1) Main+AUX Antenna		
Remark:	No report for the emission which more than 10 dB below the prescribed limit.		

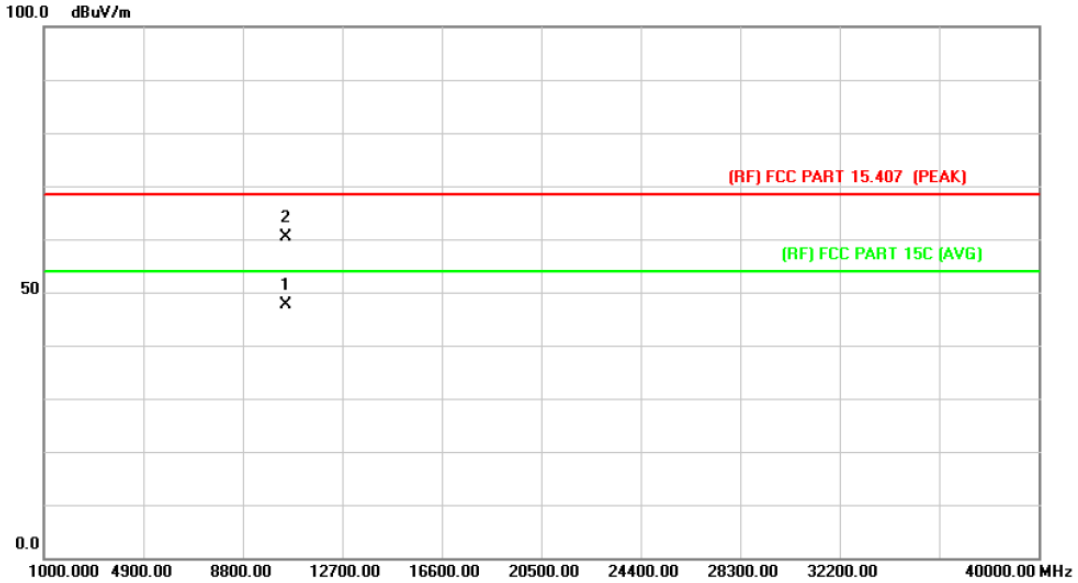

No.	Mk.	Freq.	Reading Level	Correct Factor	Measurement	Limit	Over	
		MHz	dBuV	dB/m	dBuV/m	dBuV/m	dB	Detector
1	*	10479.448	31.87	15.79	47.66	54.00	-6.34	AVG
2		10481.175	44.49	15.79	60.28	68.30	-8.02	peak

Emission Level= Read Level+ Correct Factor

Temperature:	25 °C	Relative Humidity:	55%
Test Voltage:	AC 120V/60Hz		
Ant. Pol.	Vertical		
Test Mode:	TX 802.11ac(20) Mode 5240MHz (U-NII-1) Main+AUX Antenna		
Remark:	No report for the emission which more than 10 dB below the prescribed limit.		

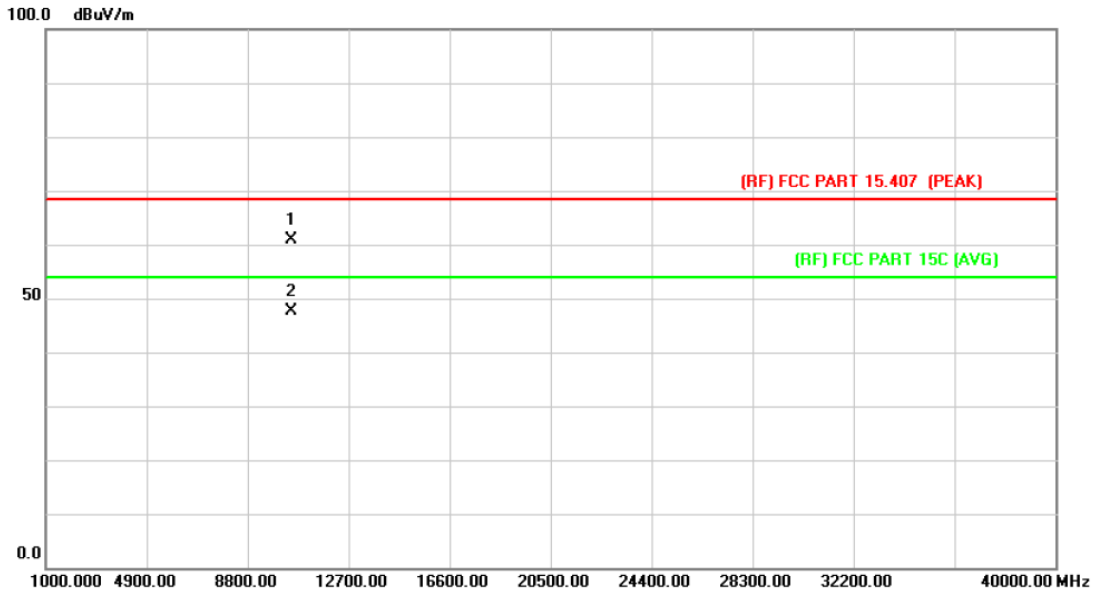

No.	Mk.	Freq. MHz	Reading Level dBuV	Correct Factor dB/m	Measure- ment dBuV/m	Limit dBuV/m	Over dB	Detector
1		10478.534	44.99	15.79	60.78	68.30	-7.52	peak
2	*	10481.228	31.81	15.79	47.60	54.00	-6.40	AVG

Emission Level= Read Level+ Correct Factor

Temperature:	25 °C	Relative Humidity:	55%
Test Voltage:	AC 120V/60Hz		
Ant. Pol.	Horizontal		
Test Mode:	TX 802.11n (40) Mode 5190MHz (U-NII-1) Main+AUX Antenna		
Remark:	No report for the emission which more than 10 dB below the prescribed limit.		

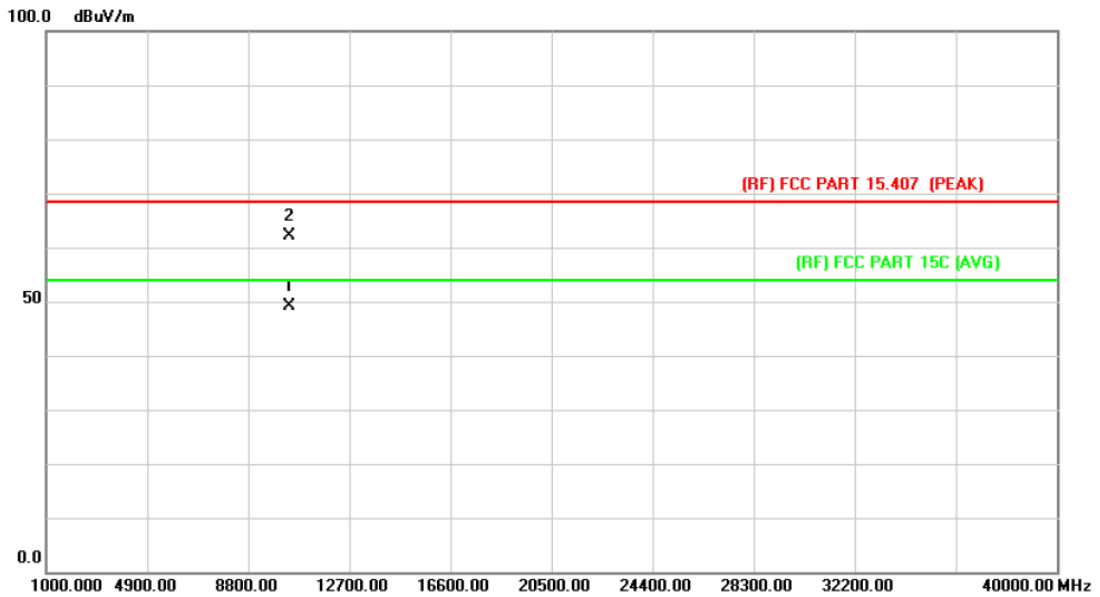

No.	Mk.	Freq.	Reading Level	Correct Factor	Measurement	Limit	Over	Detector
		MHz	dBuV	dB/m	dBuV/m	dBuV/m	dB	
1	*	10379.550	33.62	15.61	49.23	54.00	-4.77	AVG
2		10382.350	46.44	15.62	62.06	68.30	-6.24	peak

Emission Level= Read Level+ Correct Factor

Temperature:	25 °C	Relative Humidity:	55%
Test Voltage:	AC 120V/60Hz		
Ant. Pol.	Vertical		
Test Mode:	TX 802.11n (40) Mode 5190MHz (U-NII-1) Main+AUX Antenna		
Remark:	No report for the emission which more than 10 dB below the prescribed limit.		

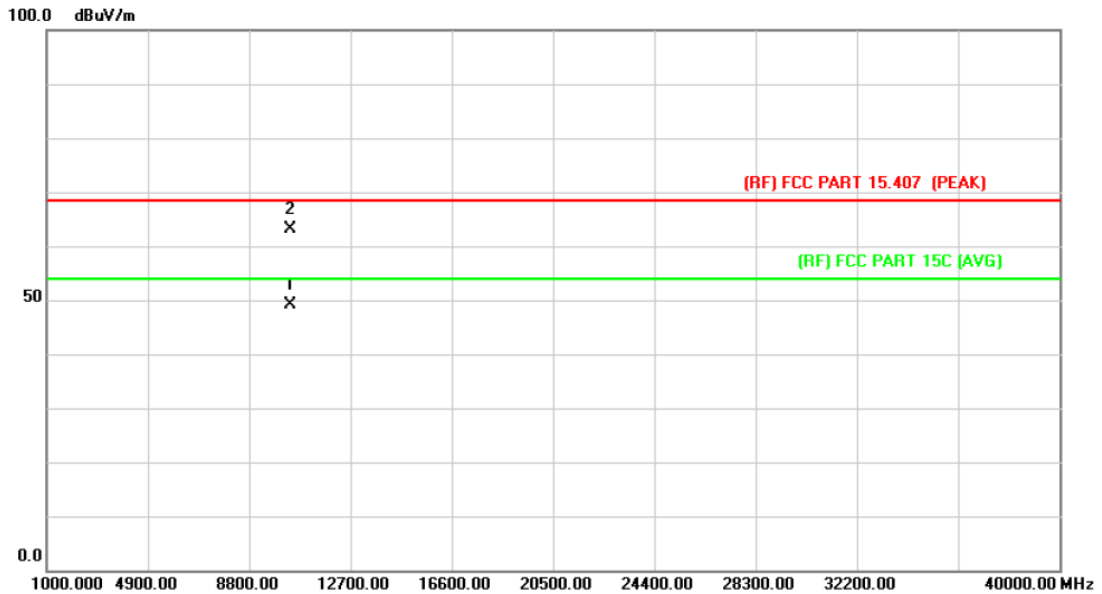

No.	Mk.	Freq.	Reading Level	Correct Factor	Measurement	Limit	Over	Detector
		MHz	dBuV	dB/m	dBuV/m	dBuV/m	dB	
1	*	10377.225	33.60	15.61	49.21	54.00	-4.79	AVG
2		10383.700	47.59	15.62	63.21	68.30	-5.09	peak

Emission Level= Read Level+ Correct Factor

Temperature:	25 °C	Relative Humidity:	55%
Test Voltage:	AC 120V/60Hz		
Ant. Pol.	Horizontal		
Test Mode:	TX 802.11n (40) Mode 5230MHz (U-NII-1) Main+AUX Antenna		
Remark:	No report for the emission which more than 10 dB below the prescribed limit.		

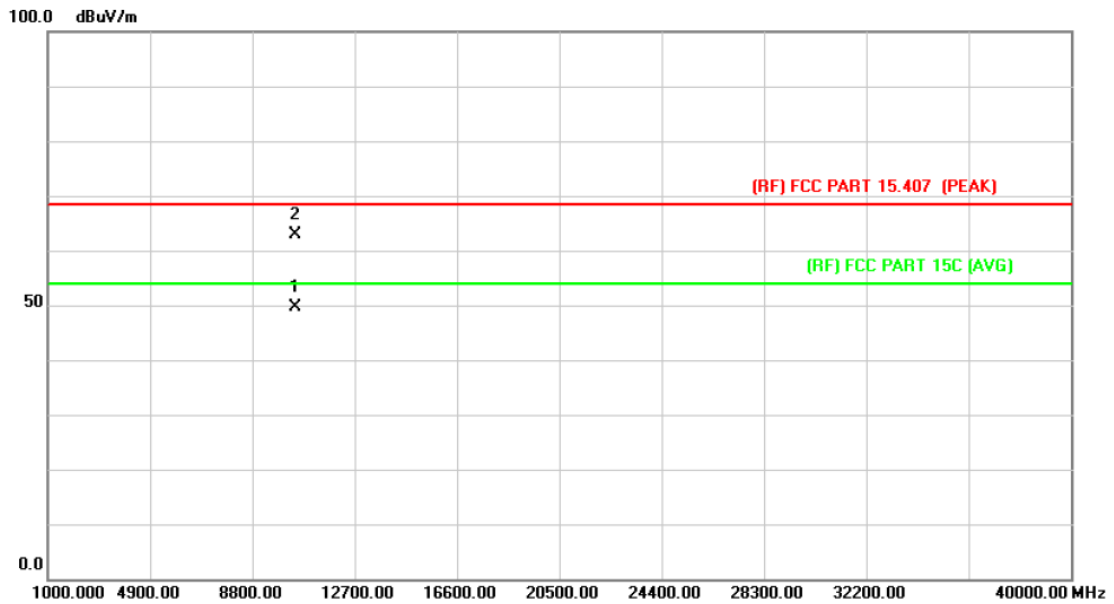

No.	Mk.	Freq.	Reading Level	Correct Factor	Measurement	Limit	Over	Detector
		MHz	dBuV	dB/m	dBuV/m	dBuV/m	dB	
1	*	10455.200	33.86	15.75	49.61	54.00	-4.39	AVG
2		10460.800	47.15	15.76	62.91	68.30	-5.39	peak

Emission Level= Read Level+ Correct Factor

Temperature:	25 °C	Relative Humidity:	55%
Test Voltage:	AC 120V/60Hz		
Ant. Pol.	Vertical		
Test Mode:	TX 802.11n (40) Mode 5230MHz (U-NII-1) Main+AUX Antenna		
Remark:	No report for the emission which more than 10 dB below the prescribed limit.		

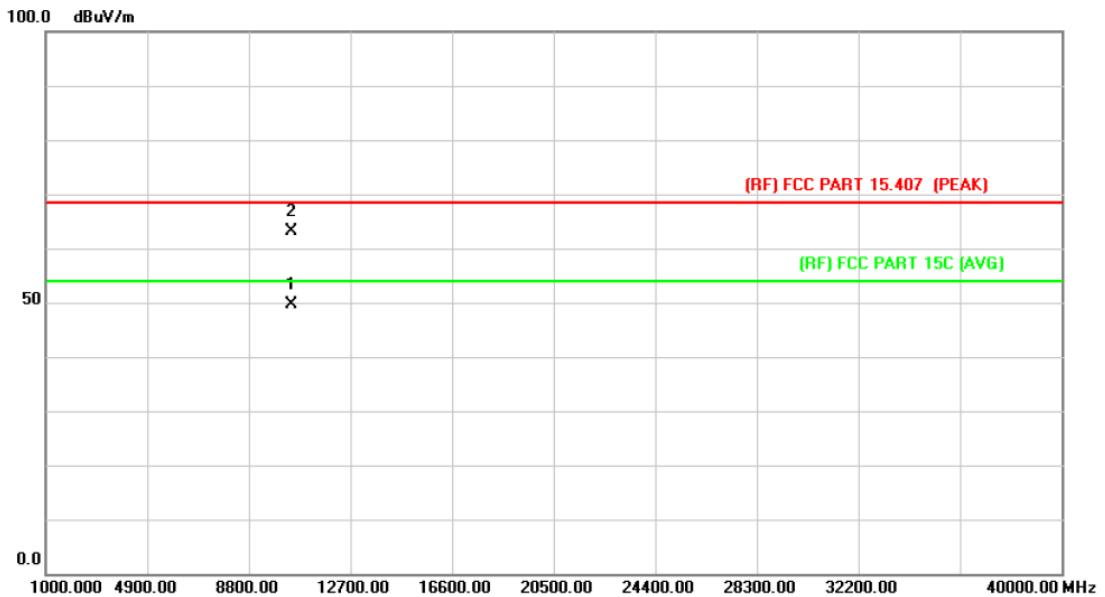

No.	Mk.	Freq.	Reading Level	Correct Factor	Measurement	Limit	Over	Detector
		MHz	dBuV	dB/m	dBuV/m	dBuV/m	dB	
1	*	10459.275	33.88	15.76	49.64	54.00	-4.36	AVG
2		10461.100	47.26	15.76	63.02	68.30	-5.28	peak

Emission Level= Read Level+ Correct Factor

Temperature:	25 °C	Relative Humidity:	55%
Test Voltage:	AC 120V/60Hz		
Ant. Pol.	Horizontal		
Test Mode:	TX 802.11ac (40) Mode 5190MHz (U-NII-1) Main+AUX Antenna		
Remark:	No report for the emission which more than 10 dB below the prescribed limit.		

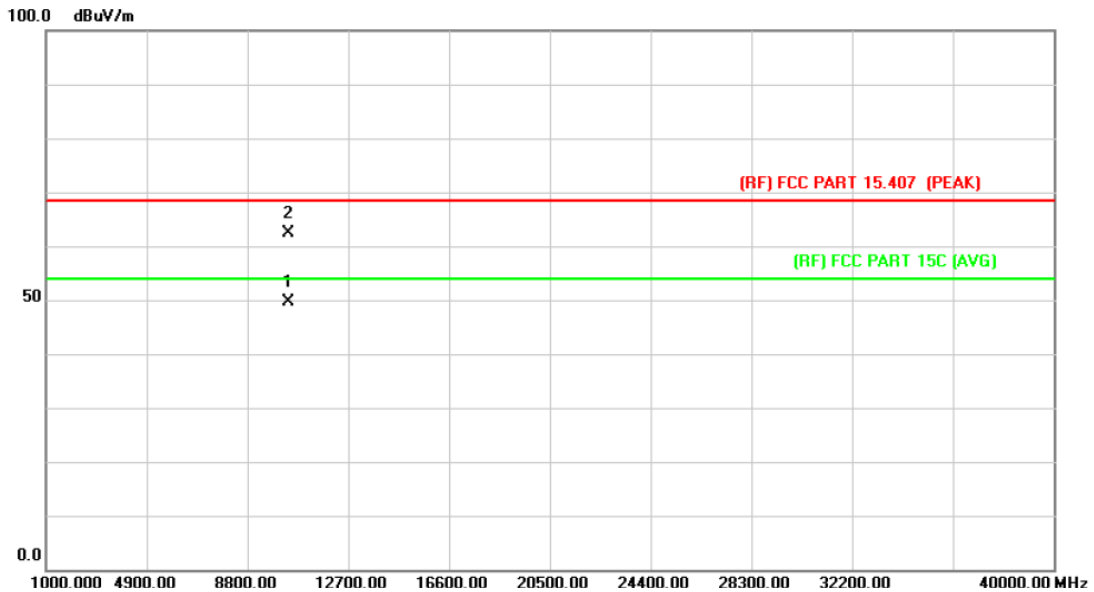

No.	Mk.	Freq.	Reading Level	Correct Factor	Measurement	Limit	Over	Detector
		MHz	dBuV	dB/m	dBuV/m	dBuV/m	dB	
1	*	10379.547	34.07	15.61	49.68	54.00	-4.32	AVG
2		10382.369	46.74	15.62	62.36	68.30	-5.94	peak

Emission Level= Read Level+ Correct Factor

Temperature:	25 °C	Relative Humidity:	55%
Test Voltage:	AC 120V/60Hz		
Ant. Pol.	Vertical		
Test Mode:	TX 802.11ac (40) Mode 5190MHz (U-NII-1)		
Remark:	No report for the emission which more than 10 dB below the prescribed limit.		

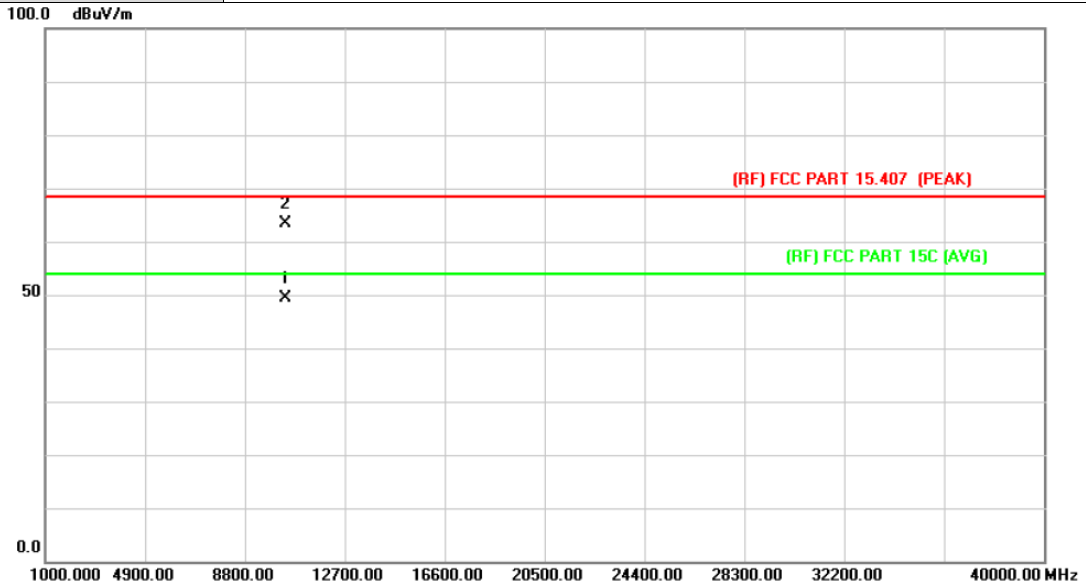

No.	Mk.	Freq.	Reading Level	Correct Factor	Measurement	Limit	Over	Detector
		MHz	dBuV	dB/m	dBuV/m	dBuV/m	dB	
1	*	10379.286	33.75	15.61	49.36	54.00	-4.64	AVG
2		10383.745	47.84	15.62	63.46	68.30	-4.84	peak

Emission Level= Read Level+ Correct Factor

Temperature:	25 °C	Relative Humidity:	55%
Test Voltage:	AC 120V/60Hz		
Ant. Pol.	Horizontal		
Test Mode:	TX 802.11ac (40) Mode 5230MHz (U-NII-1) Main+AUX Antenna		
Remark:	No report for the emission which more than 10 dB below the prescribed limit.		

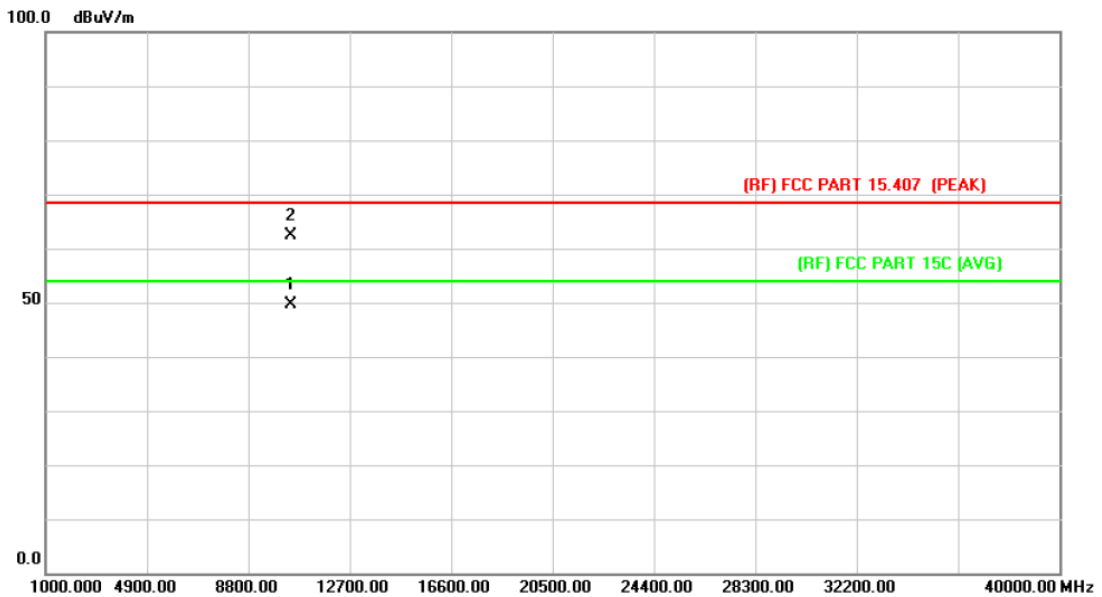

No.	Mk.	Freq.	Reading Level	Correct Factor	Measurement	Limit	Over	Detector
		MHz	dBuV	dB/m	dBuV/m	dBuV/m	dB	
1	*	10457.118	33.98	15.76	49.74	54.00	-4.26	AVG
2		10461.334	46.62	15.76	62.38	68.30	-5.92	peak

Emission Level= Read Level+ Correct Factor

Temperature:	25 °C	Relative Humidity:	55%
Test Voltage:	AC 120V/60Hz		
Ant. Pol.	Vertical		
Test Mode:	TX 802.11ac (40) Mode 5230MHz (U-NII-1) Main+AUX Antenna		
Remark:	No report for the emission which more than 10 dB below the prescribed limit.		

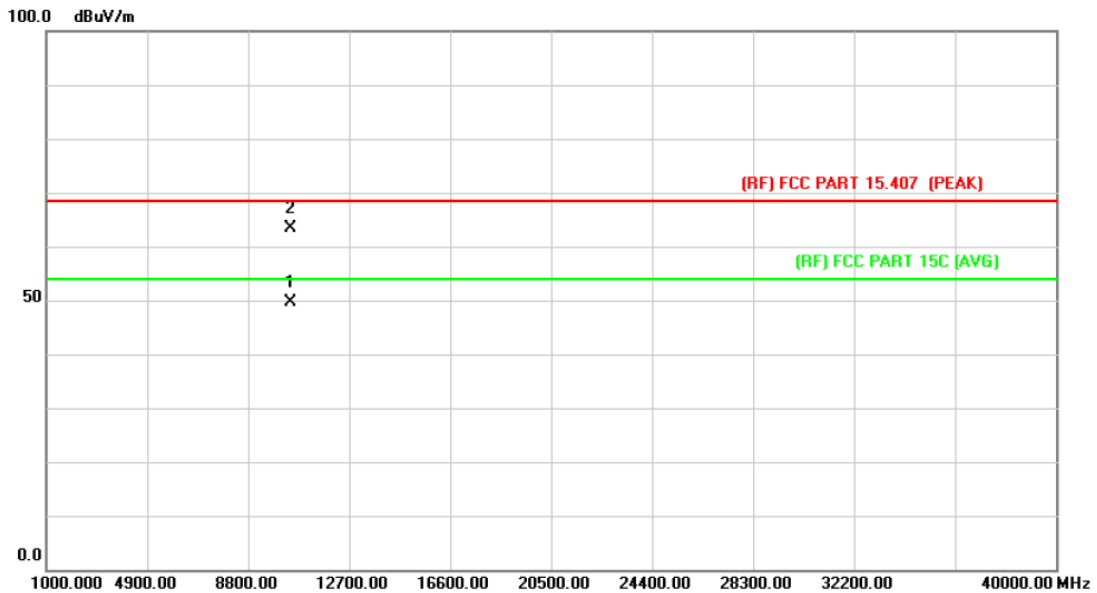

No.	Mk.	Freq. MHz	Reading Level dBuV	Correct Factor dB/m	Measure- ment dBuV/m	Limit dBuV/m	Over dB	Detector
1	*	10459.862	33.99	15.76	49.75	54.00	-4.25	AVG
2		10461.420	47.51	15.76	63.27	68.30	-5.03	peak

Emission Level= Read Level+ Correct Factor

Temperature:	25 °C	Relative Humidity:	55%
Test Voltage:	AC 120V/60Hz		
Ant. Pol.	Horizontal		
Test Mode:	TX 802.11ac (80) Mode 5210MHz (U-NII-1) Main+AUX Antenna		
Remark:	No report for the emission which more than 10 dB below the prescribed limit.		

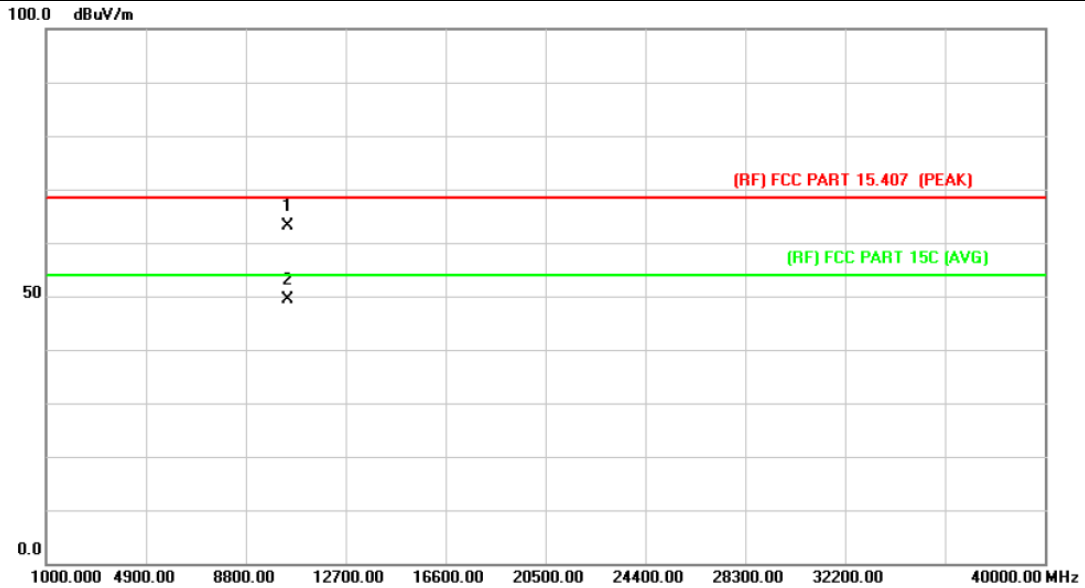

No.	Mk.	Freq.	Reading Level	Correct Factor	Measurement	Limit	Over	Detector
		MHz	dBuV	dB/m	dBuV/m	dBuV/m	dB	
1		10417.375	47.33	15.68	63.01	68.30	-5.29	peak
2	*	10424.475	33.64	15.70	49.34	54.00	-4.66	AVG

Emission Level= Read Level+ Correct Factor

Temperature:	25 °C	Relative Humidity:	55%
Test Voltage:	AC 120V/60Hz		
Ant. Pol.	Vertical		
Test Mode:	TX 802.11ac (80) Mode 5210MHz (U-NII-1) Main+AUX Antenna		
Remark:	No report for the emission which more than 10 dB below the prescribed limit.		

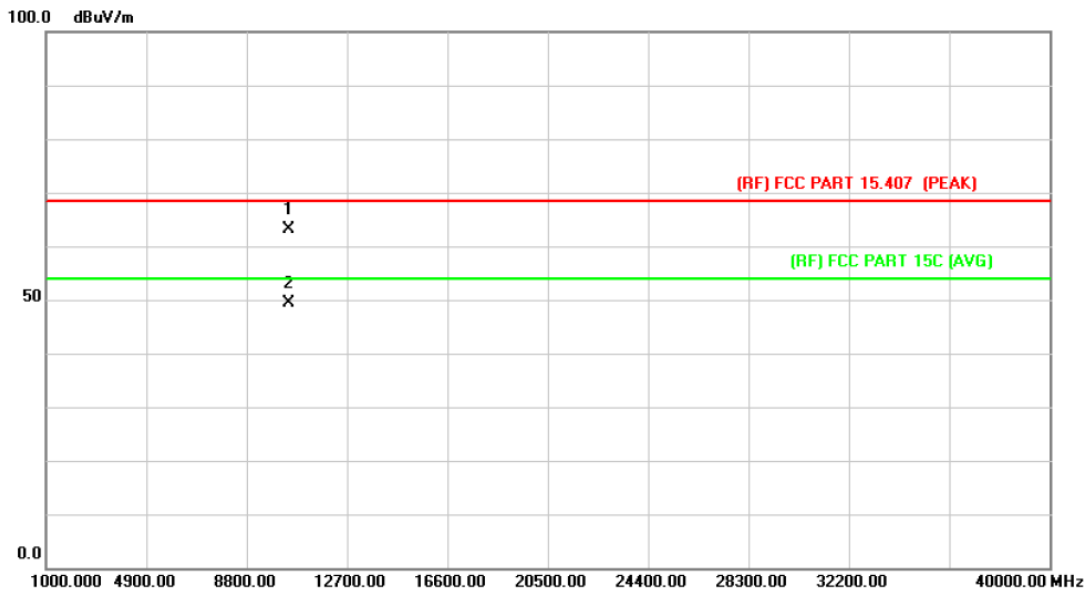

No.	Mk.	Freq. MHz	Reading Level dBuV	Correct Factor dB/m	Measure- ment dBuV/m	Limit dBuV/m	Over dB	Detector
1		10418.075	47.55	15.68	63.23	68.30	-5.07	peak
2	*	10420.950	33.70	15.69	49.39	54.00	-4.61	AVG

Emission Level= Read Level+ Correct Factor

5745MHz-5825MHz(U-NII-3)

Temperature:	25 °C	Relative Humidity:	55%
Test Voltage:	AC 120V/60Hz		
Ant. Pol.	Horizontal		
Test Mode:	TX 802.11a Mode 5745MHz (U-NII-3) Main Antenna		
Remark:	No report for the emission which more than 10 dB below the prescribed limit.		

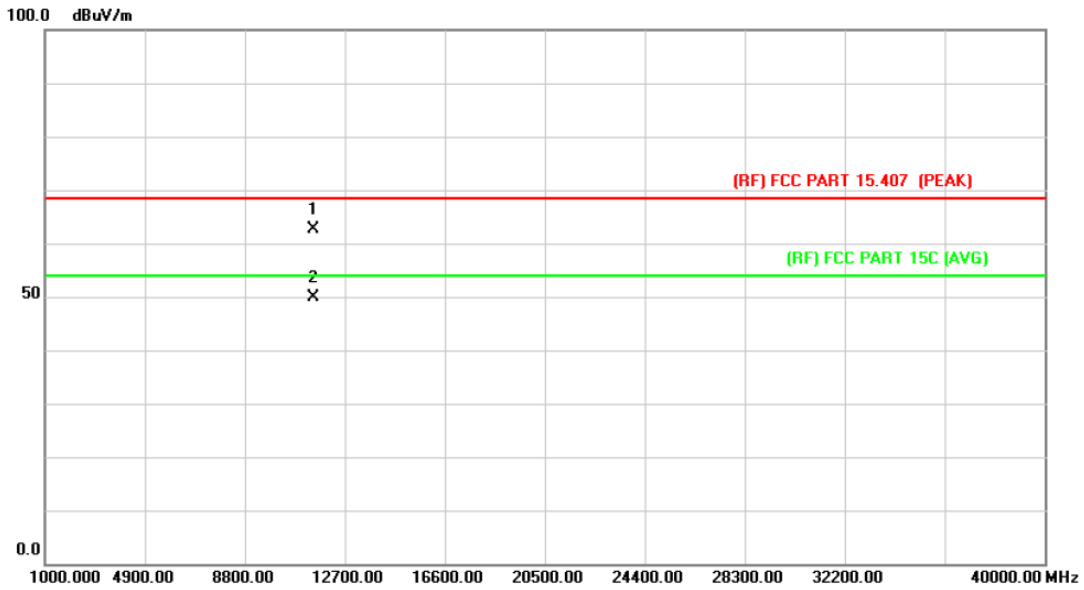

No.	Mk.	Freq.	Reading Level	Correct Factor	Measurement	Limit	Over	
		MHz	dBuV	dB/m	dBuV/m	dBuV/m	dB	Detector
1		11489.950	45.94	16.64	62.58	68.30	-5.72	peak
2	*	11490.300	33.22	16.64	49.86	54.00	-4.14	AVG

Emission Level= Read Level+ Correct Factor

Temperature:	25 °C	Relative Humidity:	55%
Test Voltage:	AC 120V/60Hz		
Ant. Pol.	Vertical		
Test Mode:	TX 802.11a Mode 5745MHz (U-NII-3) Main Antenna		
Remark:	No report for the emission which more than 10 dB below the prescribed limit.		

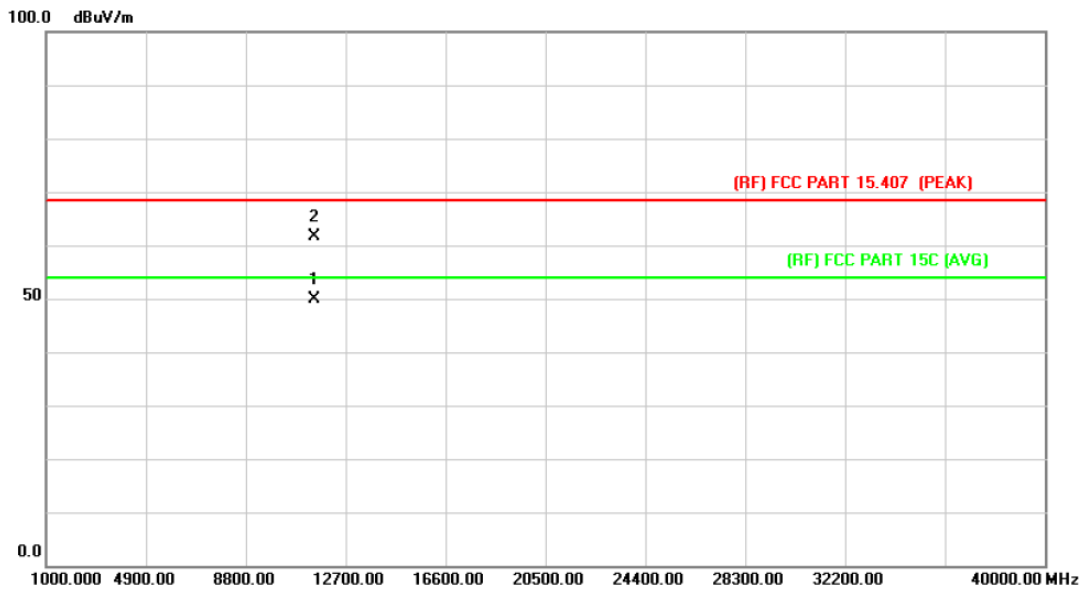

No.	Mk.	Freq.	Reading Level	Correct Factor	Measurement	Limit	Over	Detector
		MHz	dBuV	dB/m	dBuV/m	dBuV/m	dB	
1	*	11486.775	33.18	16.63	49.81	54.00	-4.19	AVG
2		11489.650	45.05	16.64	61.69	68.30	-6.61	peak

Emission Level= Read Level+ Correct Factor

Temperature:	25 °C	Relative Humidity:	55%
Test Voltage:	AC 120V/60Hz		
Ant. Pol.	Horizontal		
Test Mode:	TX 802.11a Mode 5785MHz (U-NII-3) Main Antenna		
Remark:	No report for the emission which more than 10 dB below the prescribed limit.		

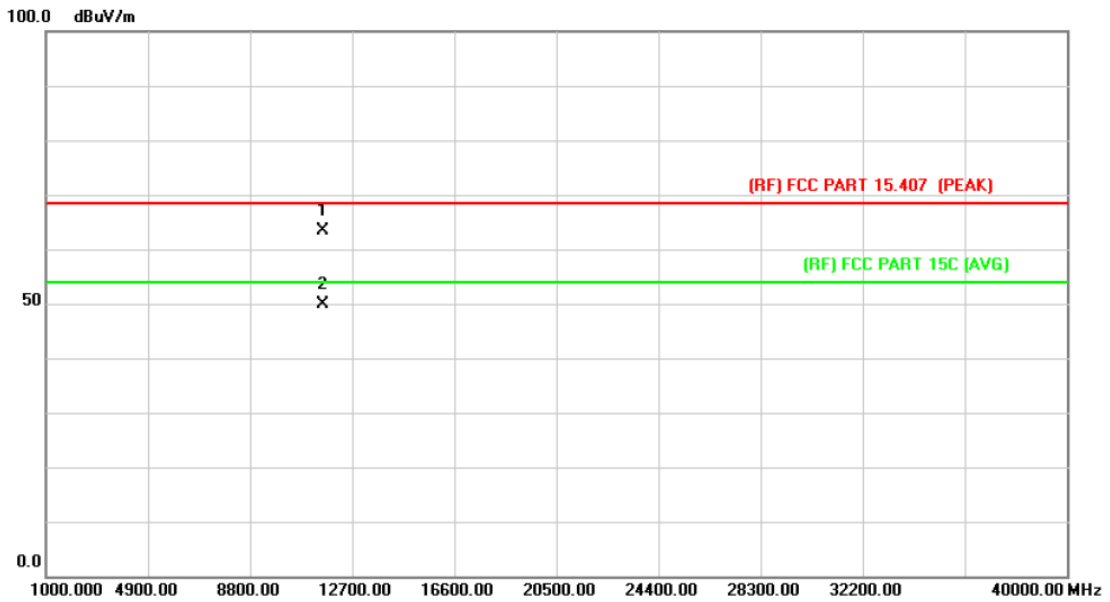

No.	Mk.	Freq.	Reading Level	Correct Factor	Measurement	Limit	Over	
		MHz	dBuV	dB/m	dBuV/m	dBuV/m	dB	Detector
1		11565.950	46.69	16.79	63.48	68.30	-4.82	peak
2	*	11568.175	33.20	16.80	50.00	54.00	-4.00	AVG

Emission Level= Read Level+ Correct Factor

Temperature:	25 °C	Relative Humidity:	55%
Test Voltage:	AC 120V/60Hz		
Ant. Pol.	Vertical		
Test Mode:	TX 802.11a Mode 5785MHz (U-NII-3) Main Antenna		
Remark:	No report for the emission which more than 10 dB below the prescribed limit.		

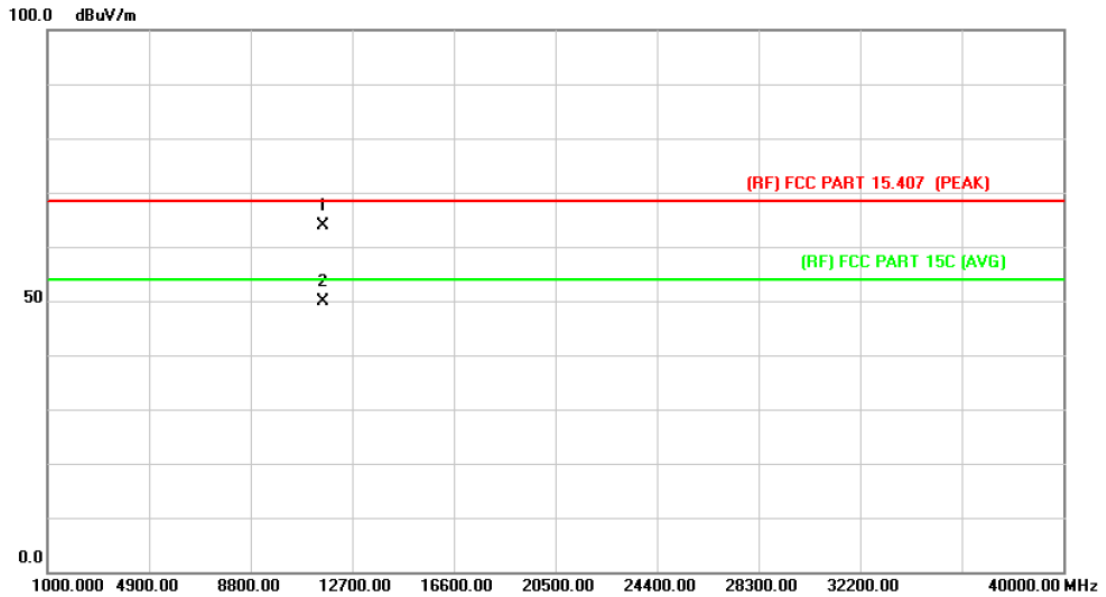

No.	Mk.	Freq.	Reading Level	Correct Factor	Measurement	Limit	Over	Detector
		MHz	dBuV	dB/m	dBuV/m	dBuV/m	dB	
1		11566.750	46.98	16.80	63.78	68.30	-4.52	peak
2	*	11570.625	33.07	16.80	49.87	54.00	-4.13	AVG

Emission Level= Read Level+ Correct Factor

Temperature:	25 °C	Relative Humidity:	55%
Test Voltage:	AC 120V/60Hz		
Ant. Pol.	Horizontal		
Test Mode:	TX 802.11a Mode 5825MHz (U-NII-3) Main Antenna		
Remark:	No report for the emission which more than 10 dB below the prescribed limit.		

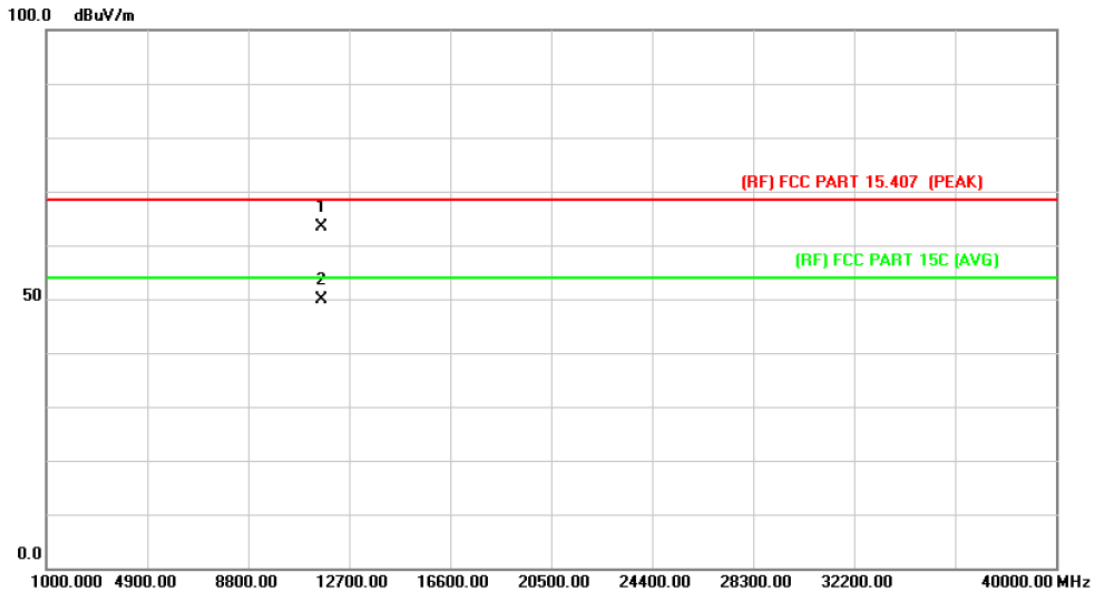

No.	Mk.	Freq. MHz	Reading Level dBuV	Correct Factor dB/m	Measure- ment dBuV/m	Limit dBuV/m	Over dB	Detector
1		11648.925	46.44	16.98	63.42	68.30	-4.88	peak
2	*	11652.150	33.01	16.99	50.00	54.00	-4.00	AVG

Emission Level= Read Level+ Correct Factor

Temperature:	25 °C	Relative Humidity:	55%
Test Voltage:	AC 120V/60Hz		
Ant. Pol.	Vertical		
Test Mode:	TX 802.11a Mode 5825MHz (U-NII-3) Main Antenna		
Remark:	No report for the emission which more than 10 dB below the prescribed limit.		

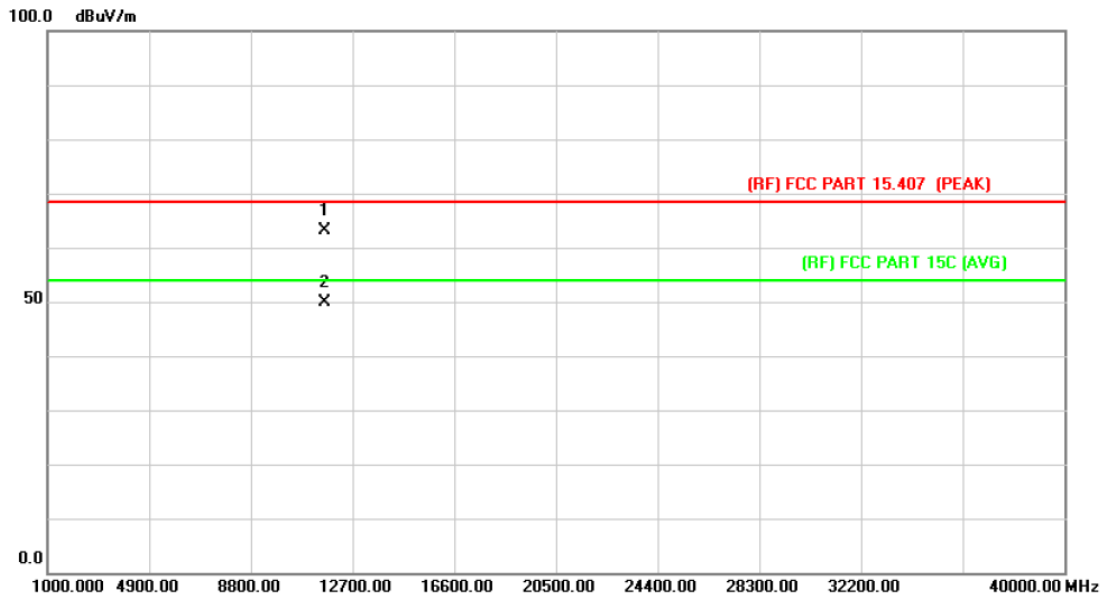

No.	Mk.	Freq.	Reading Level	Correct Factor	Measurement	Limit	Over	Detector
		MHz	dBuV	dB/m	dBuV/m	dBuV/m	dB	
1		11650.550	46.26	16.99	63.25	68.30	-5.05	peak
2	*	11651.925	32.96	16.99	49.95	54.00	-4.05	AVG

Emission Level= Read Level+ Correct Factor

Temperature:	25 °C	Relative Humidity:	55%
Test Voltage:	AC 120V/60Hz		
Ant. Pol.	Horizontal		
Test Mode:	TX 802.11n(20) Mode 5745MHz (U-NII-3) Main+AUX Antenna		
Remark:	No report for the emission which more than 10 dB below the prescribed limit.		

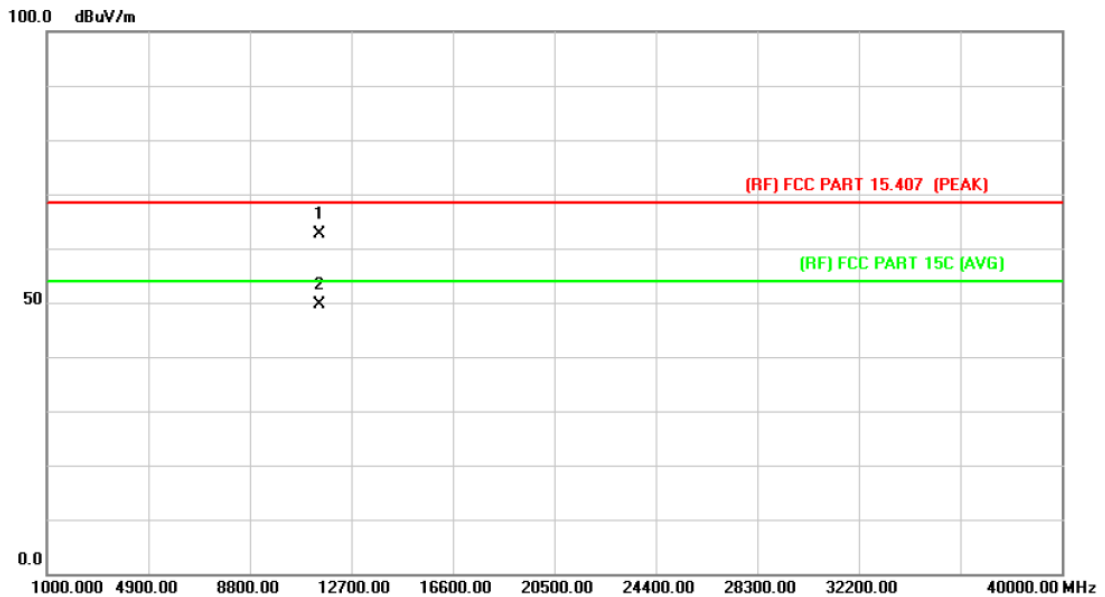

No.	Mk.	Freq.	Reading Level	Correct Factor	Measurement	Limit	Over	Detector
		MHz	dBuV	dB/m	dBuV/m	dBuV/m	dB	
1		11489.936	46.01	16.64	62.65	68.30	-5.65	peak
2	*	11493.542	32.93	16.64	49.57	54.00	-4.43	AVG

Emission Level= Read Level+ Correct Factor

Temperature:	25 °C	Relative Humidity:	55%
Test Voltage:	AC 120V/60Hz		
Ant. Pol.	Vertical		
Test Mode:	TX 802.11n(20) Mode 5745MHz (U-NII-3) Main+AUX Antenna		
Remark:	No report for the emission which more than 10 dB below the prescribed limit.		

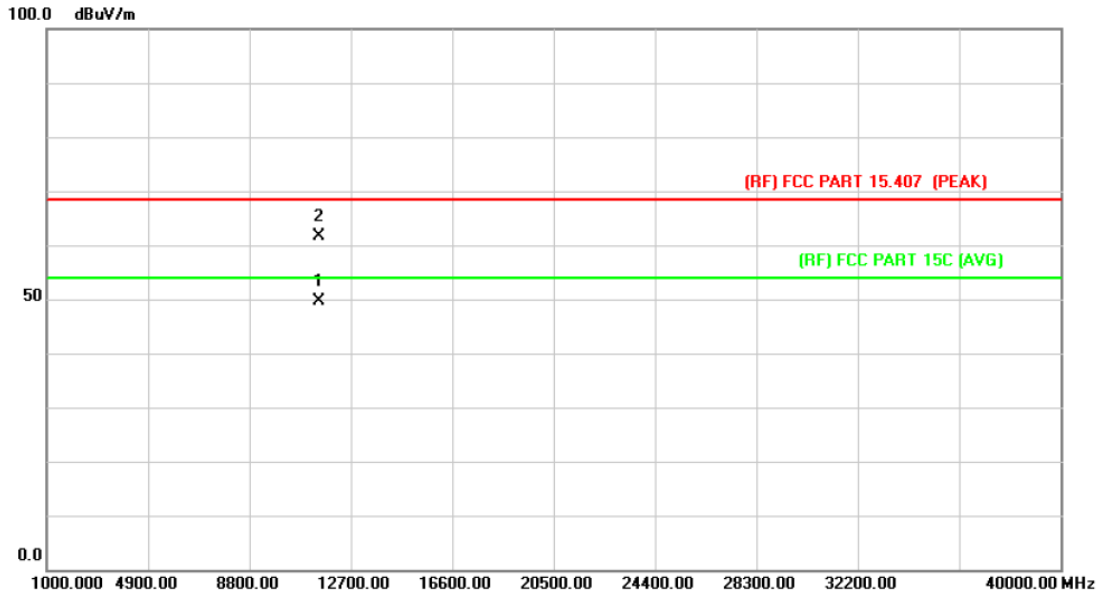

No.	Mk.	Freq.	Reading Level	Correct Factor	Measurement	Limit	Over	Detector
		MHz	dBuV	dB/m	dBuV/m	dBuV/m	dB	
1	*	11488.258	33.06	16.63	49.69	54.00	-4.31	AVG
2		11492.617	45.08	16.64	61.72	68.30	-6.58	peak

Emission Level= Read Level+ Correct Factor

Temperature:	25 °C	Relative Humidity:	55%
Test Voltage:	AC 120V/60Hz		
Ant. Pol.	Horizontal		
Test Mode:	TX 802.11n(20) Mode 5785MHz (U-NII-3) Main+AUX Antenna		
Remark:	No report for the emission which more than 10 dB below the prescribed limit.		

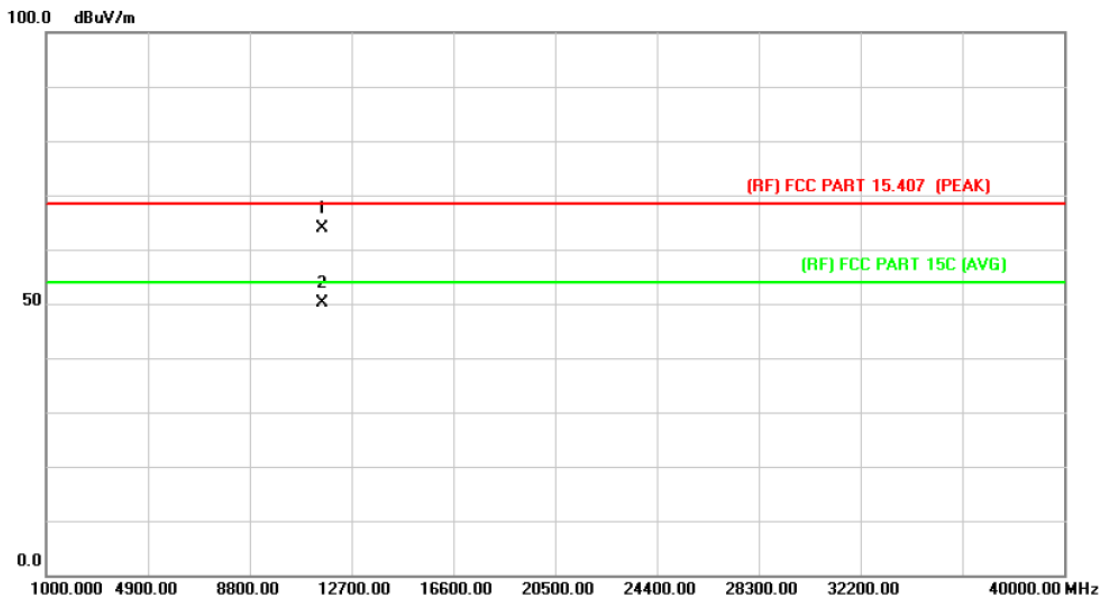

No.	Mk.	Freq.	Reading Level	Correct Factor	Measurement	Limit	Over	Detector
		MHz	dBuV	dB/m	dBuV/m	dBuV/m	dB	
1		11568.947	47.07	16.80	63.87	68.30	-4.43	peak
2	*	11571.155	33.35	16.80	50.15	54.00	-3.85	AVG

Emission Level= Read Level+ Correct Factor

Temperature:	25 °C	Relative Humidity:	55%
Test Voltage:	AC 120V/60Hz		
Ant. Pol.	Vertical		
Test Mode:	TX 802.11n(20) Mode 5785MHz (U-NII-3) Main+AUX Antenna		
Remark:	No report for the emission which more than 10 dB below the prescribed limit.		

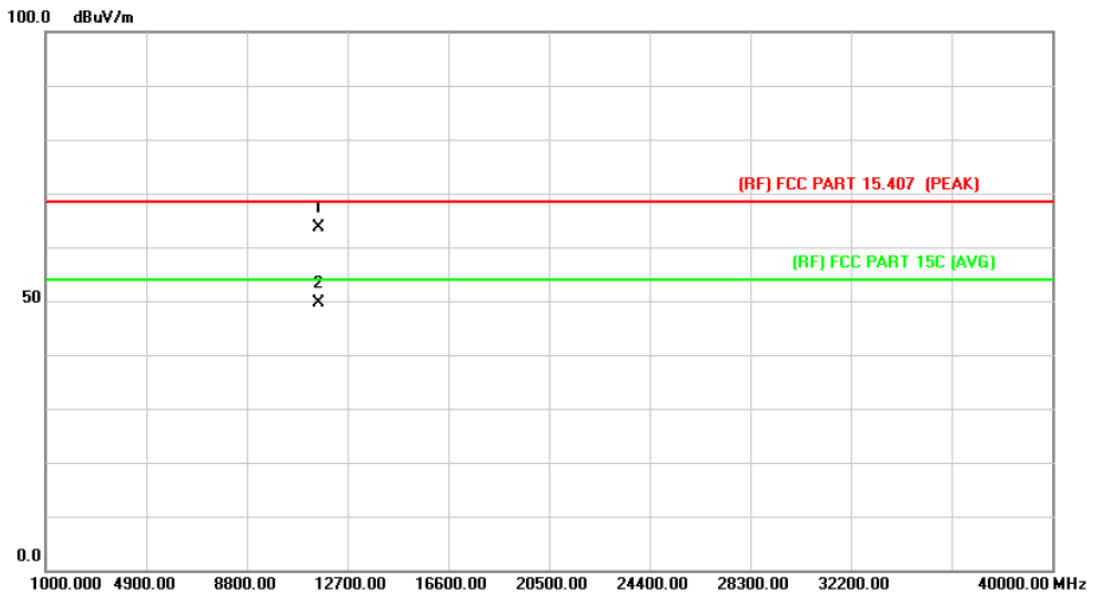

No.	Mk.	Freq. MHz	Reading Level dBuV	Correct Factor dB/m	Measure- ment dBuV/m	Limit dBuV/m	Over dB	Detector
1		11568.744	46.89	16.80	63.69	68.30	-4.61	peak
2	*	11571.671	32.88	16.80	49.68	54.00	-4.32	AVG

Emission Level= Read Level+ Correct Factor

Temperature:	25 °C	Relative Humidity:	55%
Test Voltage:	AC 120V/60Hz		
Ant. Pol.	Horizontal		
Test Mode:	TX 802.11n(20) Mode 5825MHz (U-NII-3) Main+AUX Antenna		
Remark:	No report for the emission which more than 10 dB below the prescribed limit.		

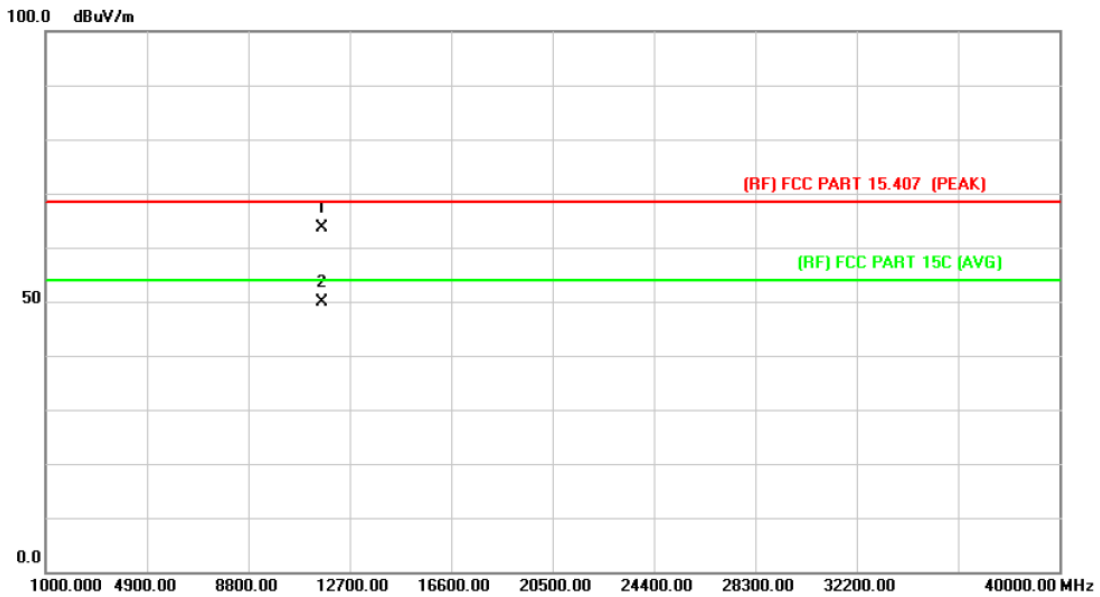

No.	Mk.	Freq. MHz	Reading Level dBuV	Correct Factor dB/m	Measure- ment dBuV/m	Limit dBuV/m	Over dB	Detector
1		11649.665	46.65	16.99	63.64	68.30	-4.66	peak
2	*	11652.264	32.89	16.99	49.88	54.00	-4.12	AVG

Emission Level= Read Level+ Correct Factor

Temperature:	25 °C	Relative Humidity:	55%
Test Voltage:	AC 120V/60Hz		
Ant. Pol.	Vertical		
Test Mode:	TX 802.11n(20) Mode 5825MHz (U-NII-3) Main+AUX Antenna		
Remark:	No report for the emission which more than 10 dB below the prescribed limit.		

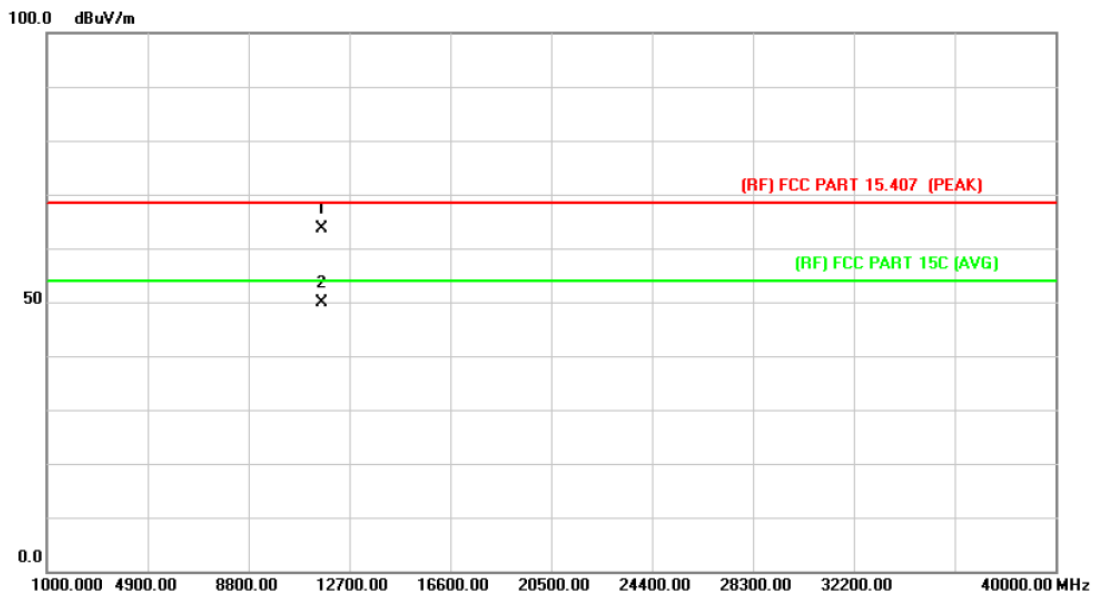

No.	Mk.	Freq. MHz	Reading Level dBuV	Correct Factor dB/m	Measure- ment dBuV/m	Limit dBuV/m	Over dB	Detector
1		11649.517	46.58	16.99	63.57	68.30	-4.73	peak
2	*	11652.486	32.99	16.99	49.98	54.00	-4.02	AVG

Emission Level= Read Level+ Correct Factor

Temperature:	25 °C	Relative Humidity:	55%
Test Voltage:	AC 120V/60Hz		
Ant. Pol.	Horizontal		
Test Mode:	TX 802.11ac(20) Mode 5745MHz (U-NII-3) Main+AUX Antenna		
Remark:	No report for the emission which more than 10 dB below the prescribed limit.		

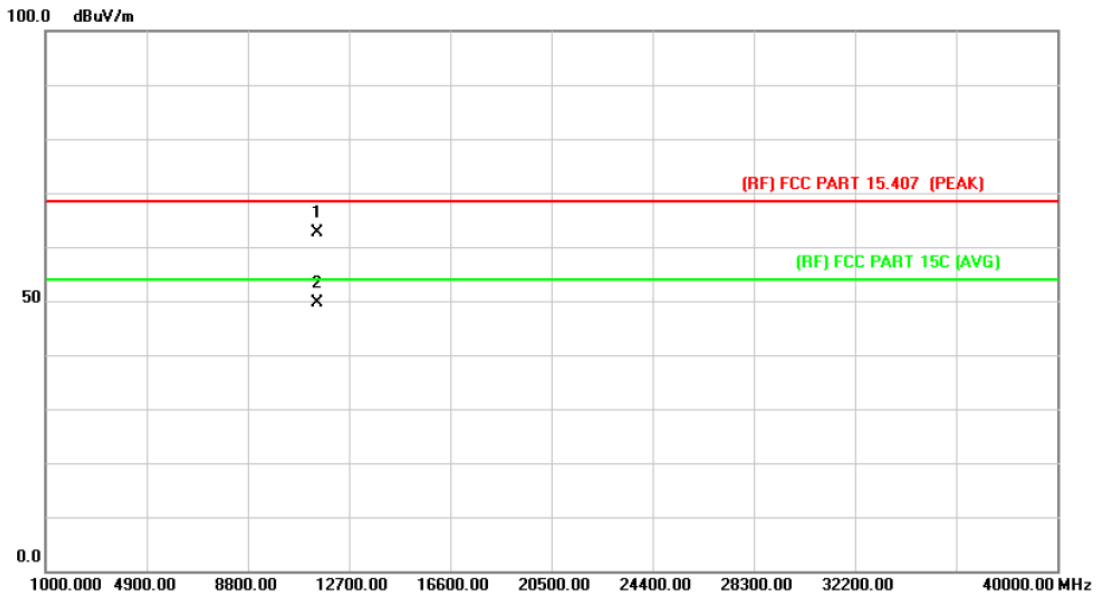

No.	Mk.	Freq.	Reading Level	Correct Factor	Measurement	Limit	Over	Detector
		MHz	dBuV	dB/m	dBuV/m	dBuV/m	dB	
1		11489.918	46.04	16.64	62.68	68.30	-5.62	peak
2	*	11493.662	32.98	16.64	49.62	54.00	-4.38	AVG

Emission Level= Read Level+ Correct Factor

Temperature:	25 °C	Relative Humidity:	55%
Test Voltage:	AC 120V/60Hz		
Ant. Pol.	Vertical		
Test Mode:	TX 802.11ac(20) Mode 5745MHz (U-NII-3) Main+AUX Antenna		
Remark:	No report for the emission which more than 10 dB below the prescribed limit.		

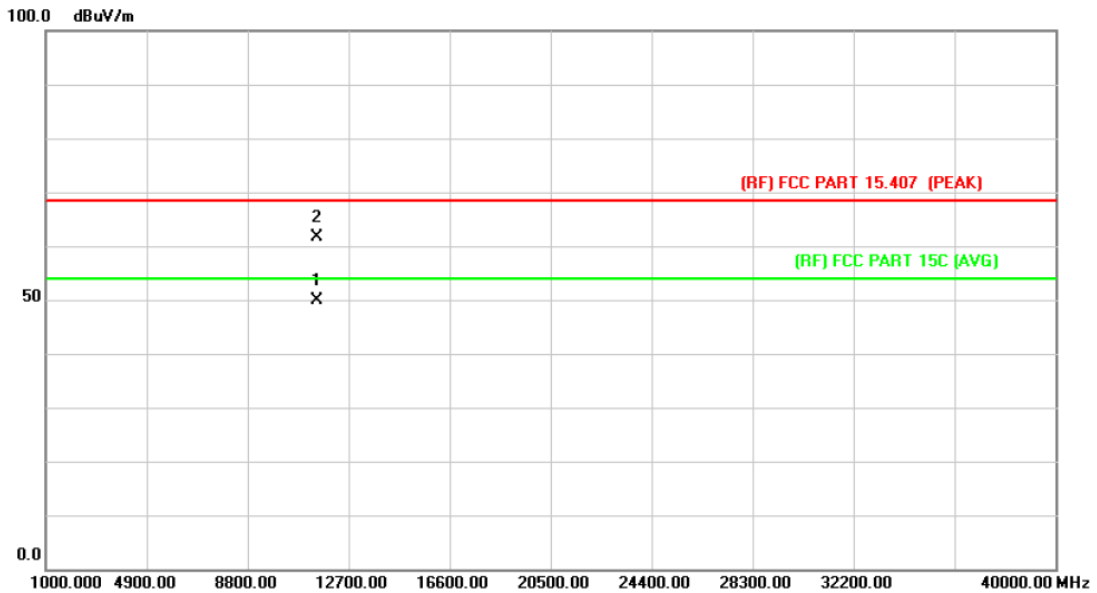

No.	Mk.	Freq. MHz	Reading Level dBuV	Correct Factor dB/m	Measure- ment dBuV/m	Limit dBuV/m	Over dB	Detector
1	*	11488.752	33.12	16.64	49.76	54.00	-4.24	AVG
2		11491.658	45.02	16.64	61.66	68.30	-6.64	peak

Emission Level= Read Level+ Correct Factor

Temperature:	25 °C	Relative Humidity:	55%
Test Voltage:	AC 120V/60Hz		
Ant. Pol.	Horizontal		
Test Mode:	TX 802.11ac(20) Mode 5785MHz (U-NII-3) Main+AUX Antenna		
Remark:	No report for the emission which more than 10 dB below the prescribed limit.		

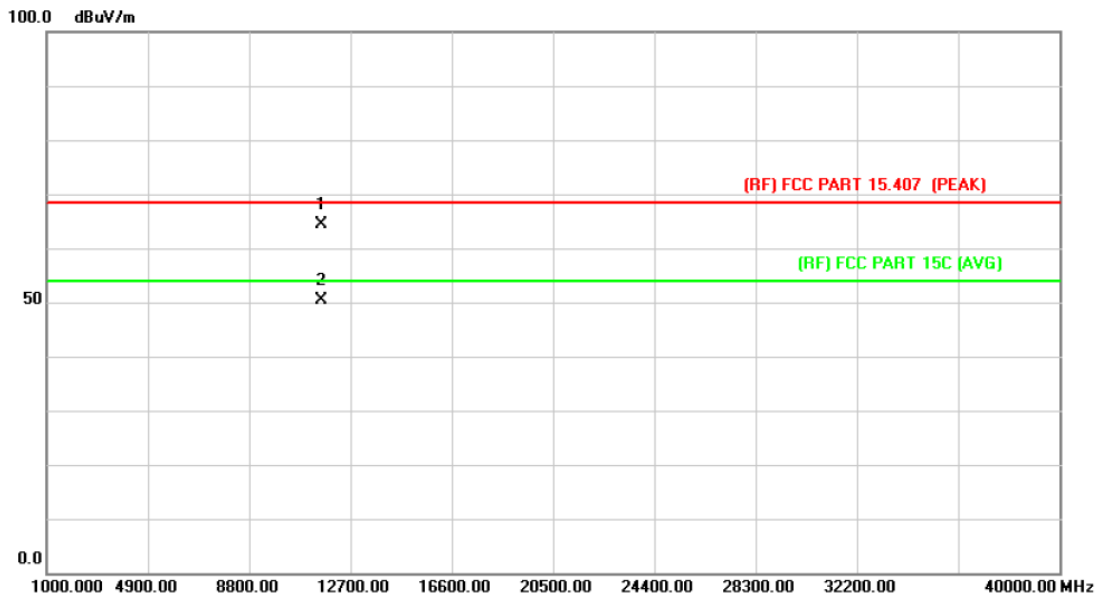

No.	Mk.	Freq.	Reading Level	Correct Factor	Measurement	Limit	Over	
		MHz	dBuV	dB/m	dBuV/m	dBuV/m	dB	Detector
1		11568.932	47.47	16.80	64.27	68.30	-4.03	peak
2	*	11571.648	33.56	16.80	50.36	54.00	-3.64	AVG

Emission Level= Read Level+ Correct Factor

Temperature:	25 °C	Relative Humidity:	55%
Test Voltage:	AC 120V/60Hz		
Ant. Pol.	Vertical		
Test Mode:	TX 802.11ac(20) Mode 5785MHz (U-NII-3) Main+AUX Antenna		
Remark:	No report for the emission which more than 10 dB below the prescribed limit.		

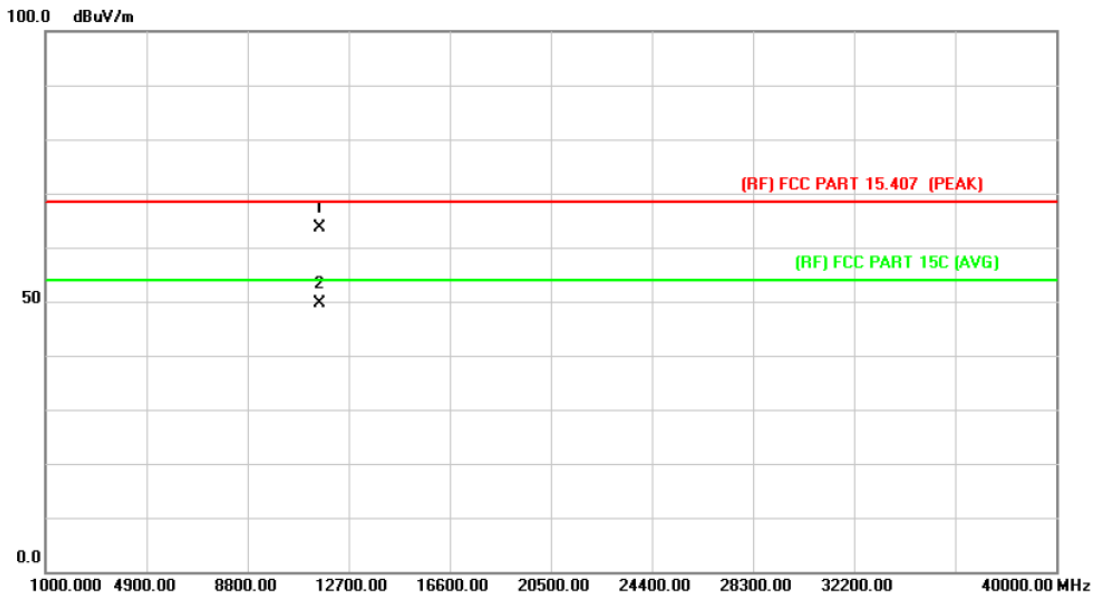

No.	Mk.	Freq. MHz	Reading Level dBuV	Correct Factor dB/m	Measure- ment dBuV/m	Limit dBuV/m	Over dB	Detector
1		11569.710	46.78	16.80	63.58	68.30	-4.72	peak
2	*	11571.826	32.93	16.80	49.73	54.00	-4.27	AVG

Emission Level= Read Level+ Correct Factor

Temperature:	25 °C	Relative Humidity:	55%
Test Voltage:	AC 120V/60Hz		
Ant. Pol.	Horizontal		
Test Mode:	TX 802.11ac(20) Mode 5825MHz (U-NII-3) Main+AUX Antenna		
Remark:	No report for the emission which more than 10 dB below the prescribed limit.		

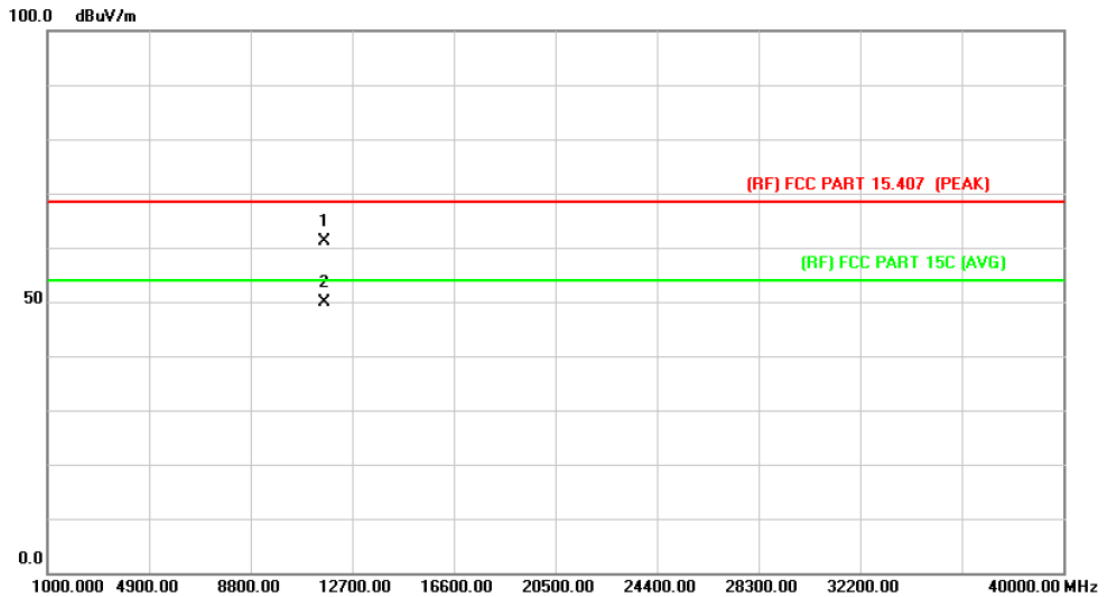

No.	Mk.	Freq.	Reading Level	Correct Factor	Measurement	Limit	Over	
		MHz	dBuV	dB/m	dBuV/m	dBuV/m	dB	Detector
1		11649.775	44.14	16.99	61.13	68.30	-7.17	peak
2	*	11652.255	32.80	16.99	49.79	54.00	-4.21	AVG

Emission Level= Read Level+ Correct Factor

Temperature:	25 °C	Relative Humidity:	55%
Test Voltage:	AC 120V/60Hz		
Ant. Pol.	Vertical		
Test Mode:	TX 802.11ac(20) Mode 5825MHz (U-NII-3) Main+AUX Antenna		
Remark:	No report for the emission which more than 10 dB below the prescribed limit.		

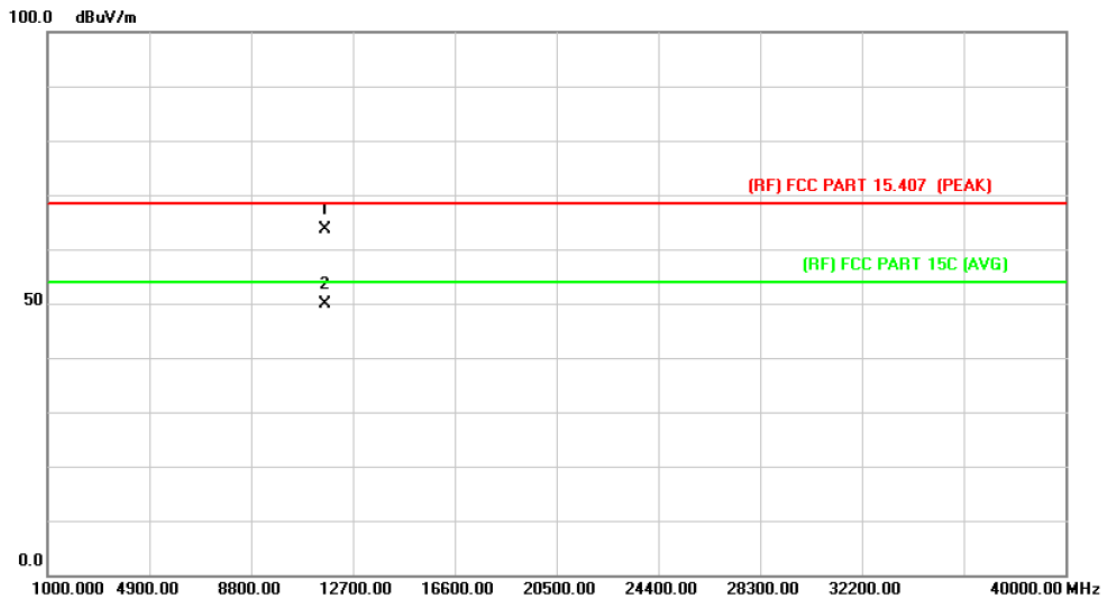

No.	Mk.	Freq.	Reading Level	Correct Factor	Measurement	Limit	Over	Detector
		MHz	dBuV	dB/m	dBuV/m	dBuV/m	dB	
1		11649.864	46.69	16.99	63.68	68.30	-4.62	peak
2	*	11652.522	32.88	16.99	49.87	54.00	-4.13	AVG

Emission Level= Read Level+ Correct Factor

Temperature:	25 °C	Relative Humidity:	55%
Test Voltage:	AC 120V/60Hz		
Ant. Pol.	Horizontal		
Test Mode:	TX 802.11n(40) Mode 5755MHz (U-NII-3) Main+AUX Antenna		
Remark:	No report for the emission which more than 10 dB below the prescribed limit.		

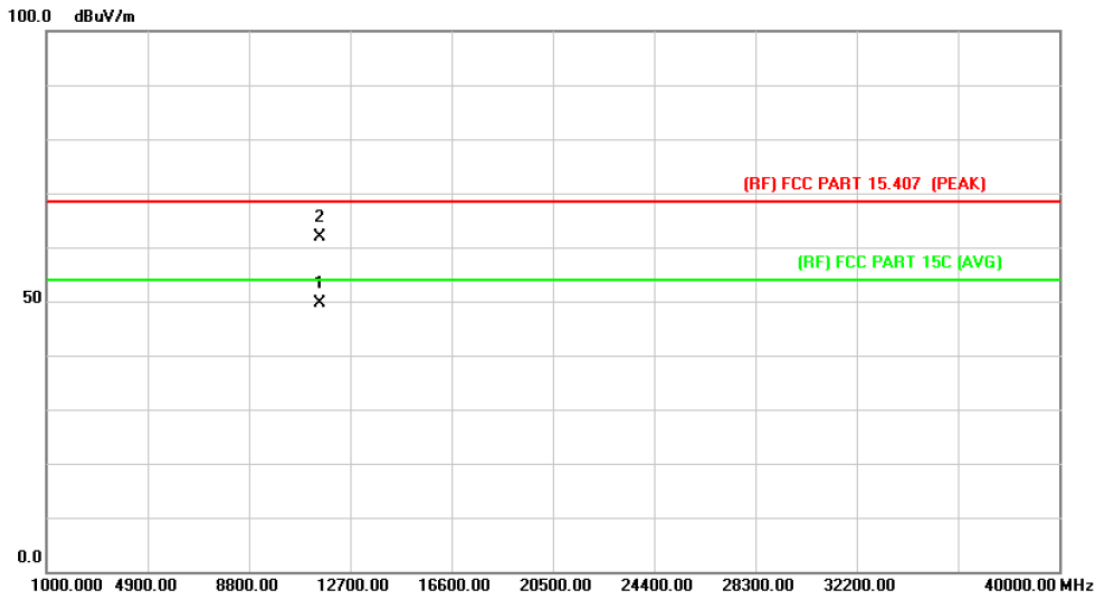

No.	Mk.	Freq.	Reading Level	Correct Factor	Measurement	Limit	Over	Detector
		MHz	dBuV	dB/m	dBuV/m	dBuV/m	dB	
1	*	11511.875	33.06	16.68	49.74	54.00	-4.26	AVG
2		11514.550	45.30	16.68	61.98	68.30	-6.32	peak

Emission Level= Read Level+ Correct Factor

Temperature:	25 °C	Relative Humidity:	55%
Test Voltage:	AC 120V/60Hz		
Ant. Pol.	Vertical		
Test Mode:	TX 802.11n(40) Mode 5755MHz (U-NII-3) Main+AUX Antenna		
Remark:	No report for the emission which more than 10 dB below the prescribed limit.		

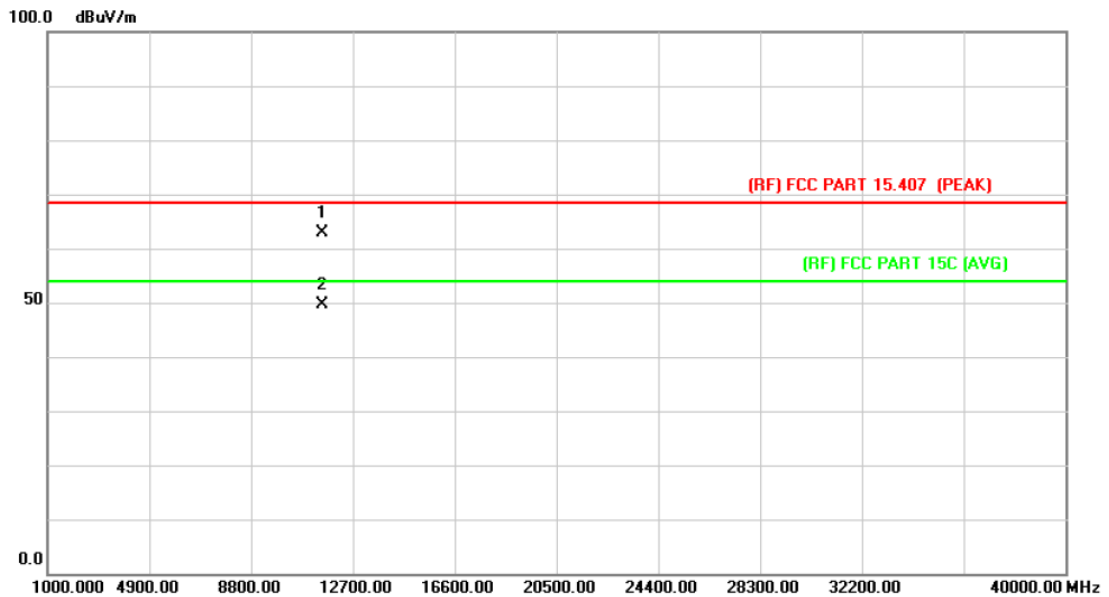

No.	Mk.	Freq. MHz	Reading Level dBuV	Correct Factor dB/m	Measure- ment dBuV/m	Limit dBuV/m	Over dB	Detector
1		11508.325	46.24	16.66	62.90	68.30	-5.40	peak
2	*	11514.550	33.05	16.68	49.73	54.00	-4.27	AVG

Emission Level= Read Level+ Correct Factor

Temperature:	25 °C	Relative Humidity:	55%
Test Voltage:	AC 120V/60Hz		
Ant. Pol.	Horizontal		
Test Mode:	TX 802.11n(40) Mode 5795MHz (U-NII-3) Main+AUX Antenna		
Remark:	No report for the emission which more than 10 dB below the prescribed limit.		

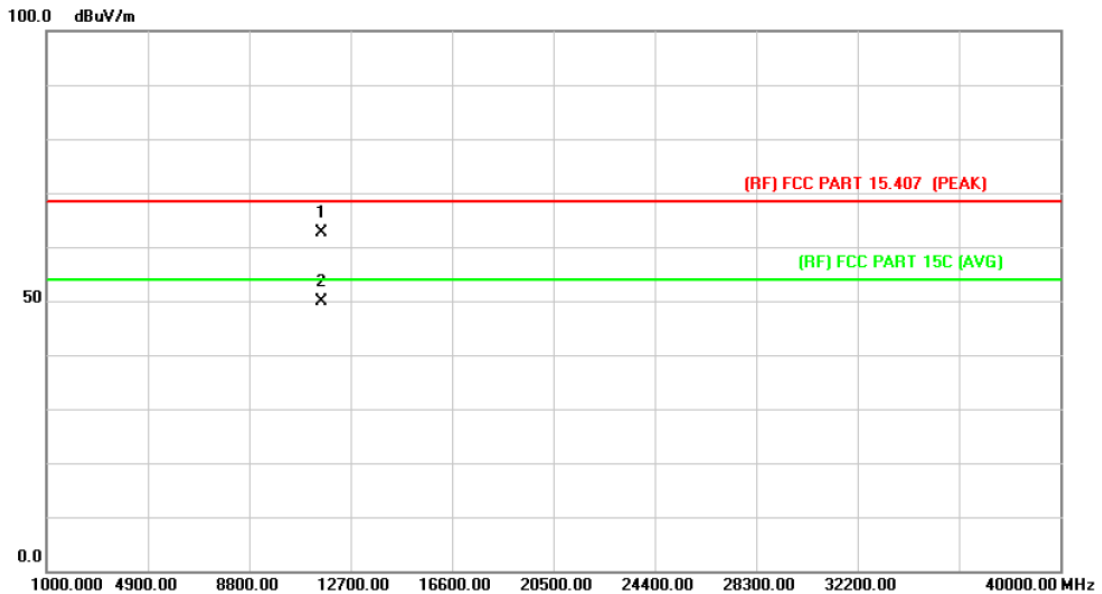

No.	Mk.	Freq.	Reading Level	Correct Factor	Measurement	Limit	Over	Detector
		MHz	dBuV	dB/m	dBuV/m	dBuV/m	dB	
1		11589.900	45.66	16.85	62.51	68.30	-5.79	peak
2	*	11591.050	33.01	16.85	49.86	54.00	-4.14	AVG

Emission Level= Read Level+ Correct Factor

Temperature:	25 °C	Relative Humidity:	55%
Test Voltage:	AC 120V/60Hz		
Ant. Pol.	Vertical		
Test Mode:	TX 802.11n(40) Mode 5795MHz (U-NII-3) Main+AUX Antenna		
Remark:	No report for the emission which more than 10 dB below the prescribed limit.		

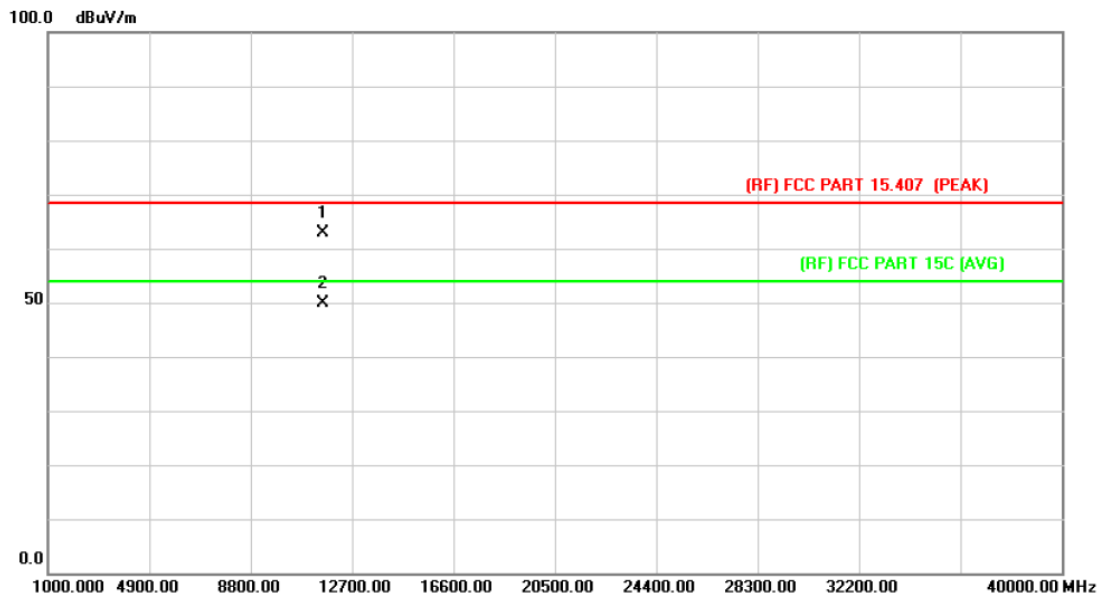

No.	Mk.	Freq.	Reading Level	Correct Factor	Measurement	Limit	Over	
		MHz	dBuV	dB/m	dBuV/m	dBuV/m	dB	Detector
1		11588.725	46.12	16.85	62.97	68.30	-5.33	peak
2	*	11590.825	33.07	16.85	49.92	54.00	-4.08	AVG

Emission Level= Read Level+ Correct Factor

Temperature:	25 °C	Relative Humidity:	55%
Test Voltage:	AC 120V/60Hz		
Ant. Pol.	Horizontal		
Test Mode:	TX 802.11ac(40) Mode 5755MHz (U-NII-3) Main+AUX Antenna		
Remark:	No report for the emission which more than 10 dB below the prescribed limit.		

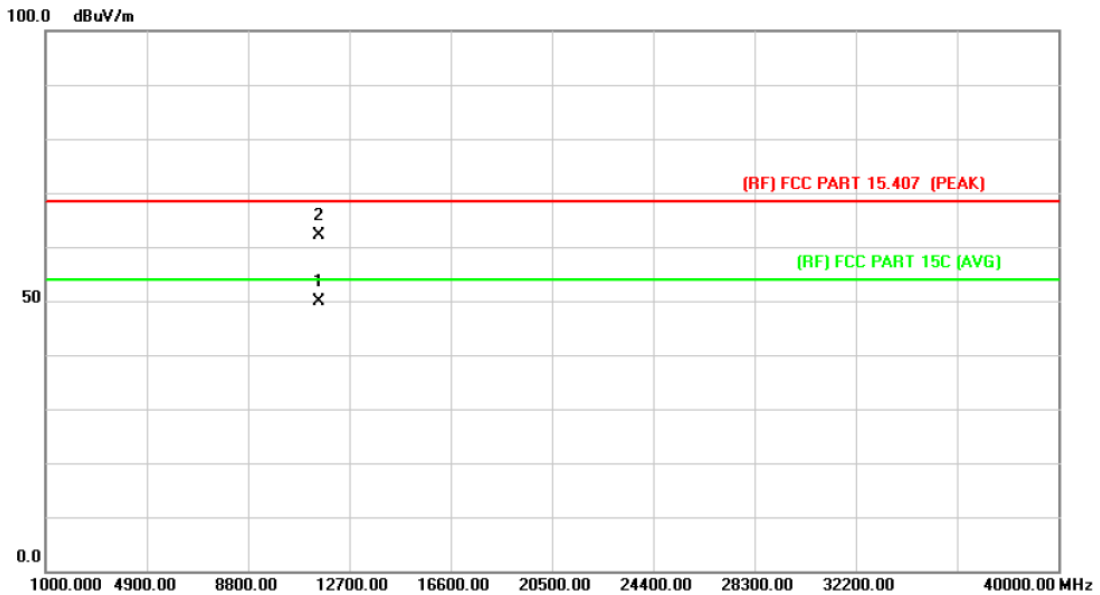

No.	Mk.	Freq.	Reading Level	Correct Factor	Measurement	Limit	Over	Detector
		MHz	dBuV	dB/m	dBuV/m	dBuV/m	dB	
1	*	11512.384	33.14	16.68	49.82	54.00	-4.18	AVG
2		11513.622	45.40	16.68	62.08	68.30	-6.22	peak

Emission Level= Read Level+ Correct Factor

Temperature:	25 °C	Relative Humidity:	55%
Test Voltage:	AC 120V/60Hz		
Ant. Pol.	Vertical		
Test Mode:	TX 802.11ac(40) Mode 5755MHz (U-NII-3) Main+AUX Antenna		
Remark:	No report for the emission which more than 10 dB below the prescribed limit.		

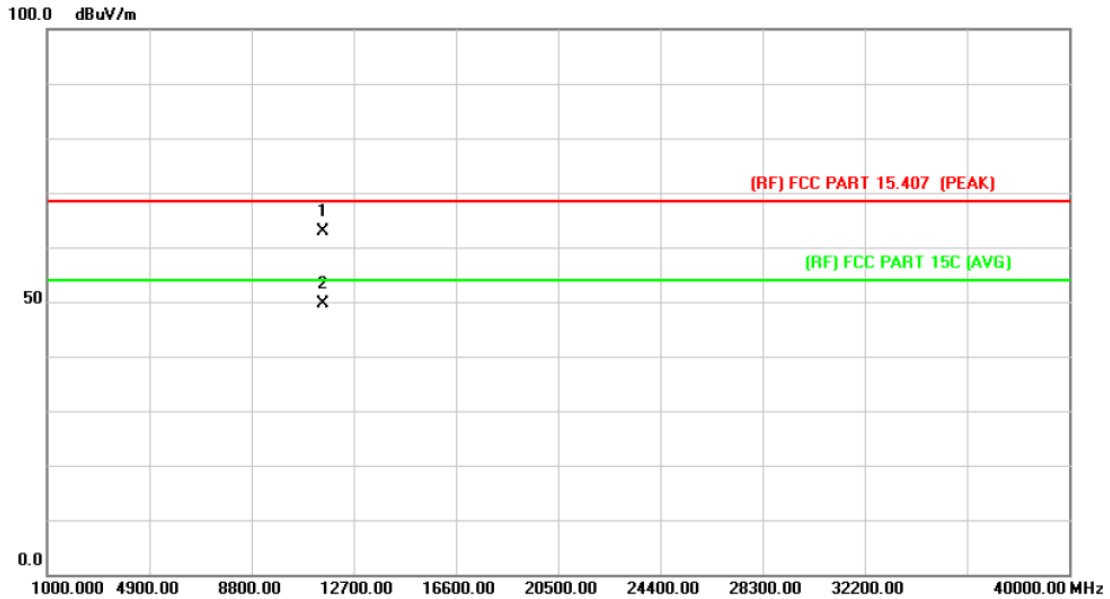

No.	Mk.	Freq. MHz	Reading Level dBuV	Correct Factor dB/m	Measure- ment dBuV/m	Limit dBuV/m	Over dB	Detector
1		11509.325	46.12	16.66	62.78	68.30	-5.52	peak
2	*	11513.322	33.04	16.68	49.72	54.00	-4.28	AVG

Emission Level= Read Level+ Correct Factor

Temperature:	25 °C	Relative Humidity:	55%
Test Voltage:	AC 120V/60Hz		
Ant. Pol.	Horizontal		
Test Mode:	TX 802.11ac(40) Mode 5795MHz (U-NII-3) Main+AUX Antenna		
Remark:	No report for the emission which more than 10 dB below the prescribed limit.		

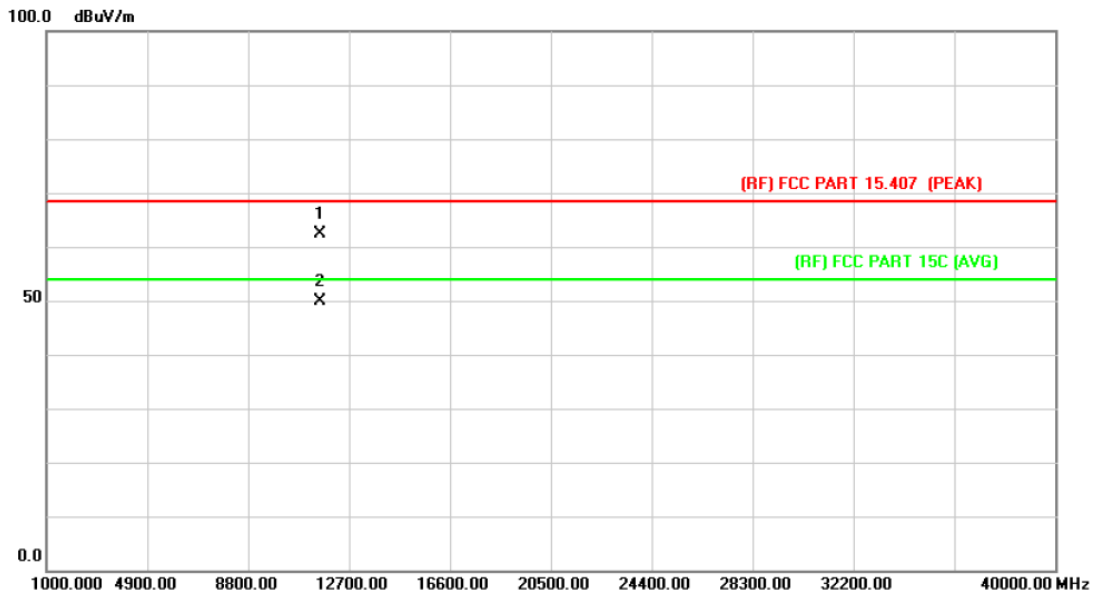

No.	Mk.	Freq.	Reading Level	Correct Factor	Measurement	Limit	Over	Detector
		MHz	dBuV	dB/m	dBuV/m	dBuV/m	dB	
1		11589.876	45.51	16.85	62.36	68.30	-5.94	peak
2	*	11591.145	33.03	16.85	49.88	54.00	-4.12	AVG

Emission Level= Read Level+ Correct Factor

Temperature:	25 °C	Relative Humidity:	55%
Test Voltage:	AC 120V/60Hz		
Ant. Pol.	Vertical		
Test Mode:	TX 802.11ac(40) Mode 5795MHz (U-NII-3) Main+AUX Antenna		
Remark:	No report for the emission which more than 10 dB below the prescribed limit.		

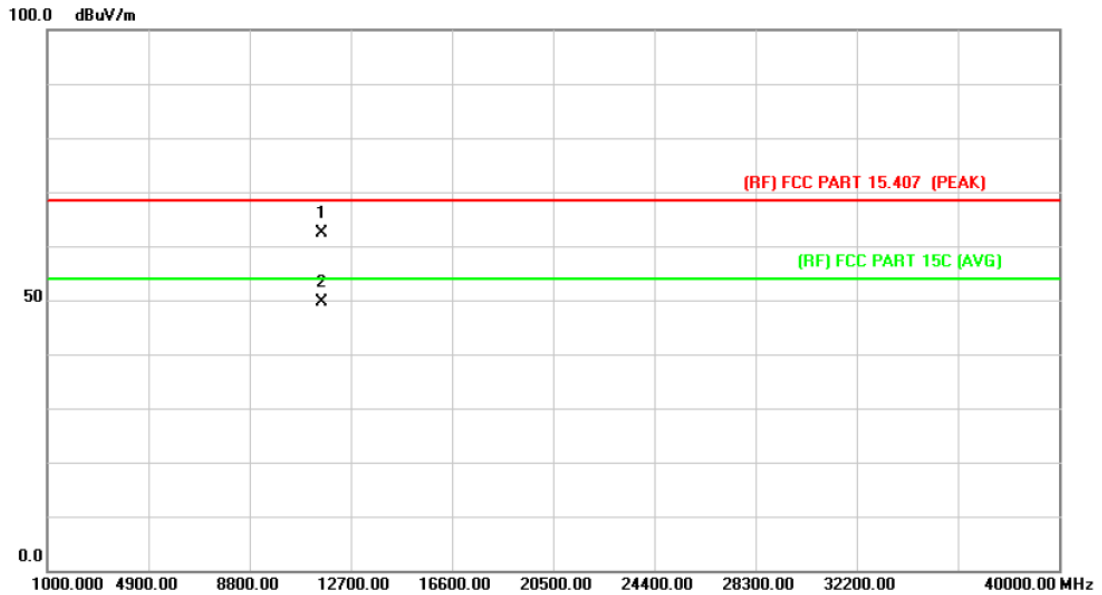

No.	Mk.	Freq.	Reading Level	Correct Factor	Measurement	Limit	Over	
		MHz	dBuV	dB/m	dBuV/m	dBuV/m	dB	Detector
1		11587.869	45.53	16.85	62.38	68.30	-5.92	peak
2	*	11591.225	32.76	16.85	49.61	54.00	-4.39	AVG

Emission Level= Read Level+ Correct Factor

Temperature:	25 °C	Relative Humidity:	55%
Test Voltage:	AC 120V/60Hz		
Ant. Pol.	Horizontal		
Test Mode:	TX 802.11ac(80) Mode 5775MHz (U-NII-3) Main+AUX Antenna		
Remark:	No report for the emission which more than 10 dB below the prescribed limit.		

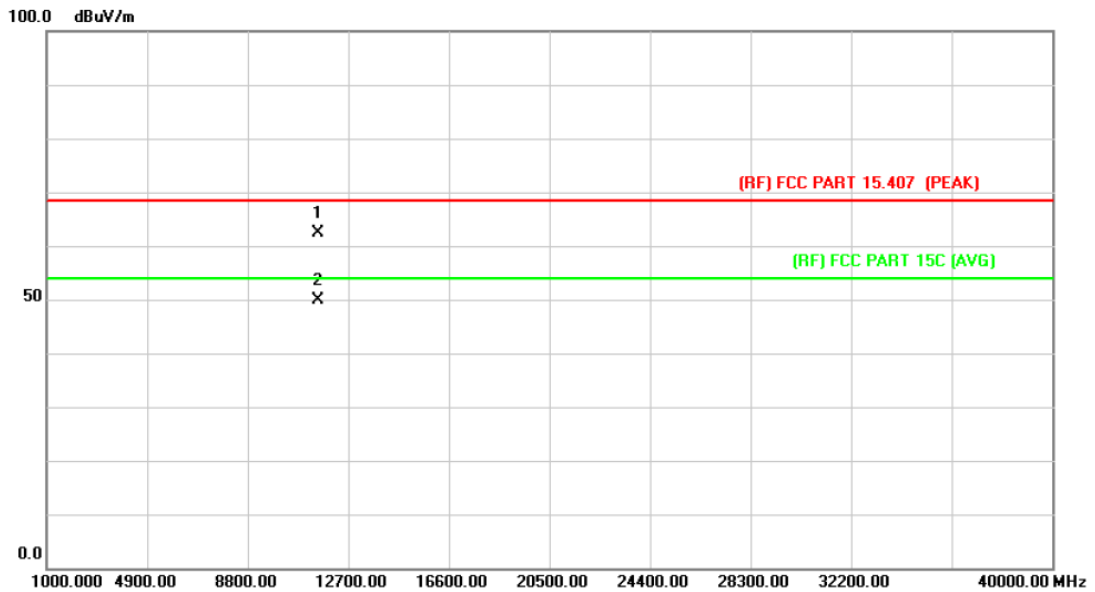

No.	Mk.	Freq. MHz	Reading Level dBuV	Correct Factor dB/m	Measure- ment dBuV/m	Limit dBuV/m	Over dB	Detector
1		11549.825	45.73	16.75	62.48	68.30	-5.82	peak
2	*	11552.125	33.12	16.75	49.87	54.00	-4.13	AVG

Emission Level= Read Level+ Correct Factor

Temperature:	25 °C	Relative Humidity:	55%
Test Voltage:	AC 120V/60Hz		
Ant. Pol.	Vertical		
Test Mode:	TX 802.11ac(80) Mode 5775MHz (U-NII-3) Main+AUX Antenna		
Remark:	No report for the emission which more than 10 dB below the prescribed limit.		

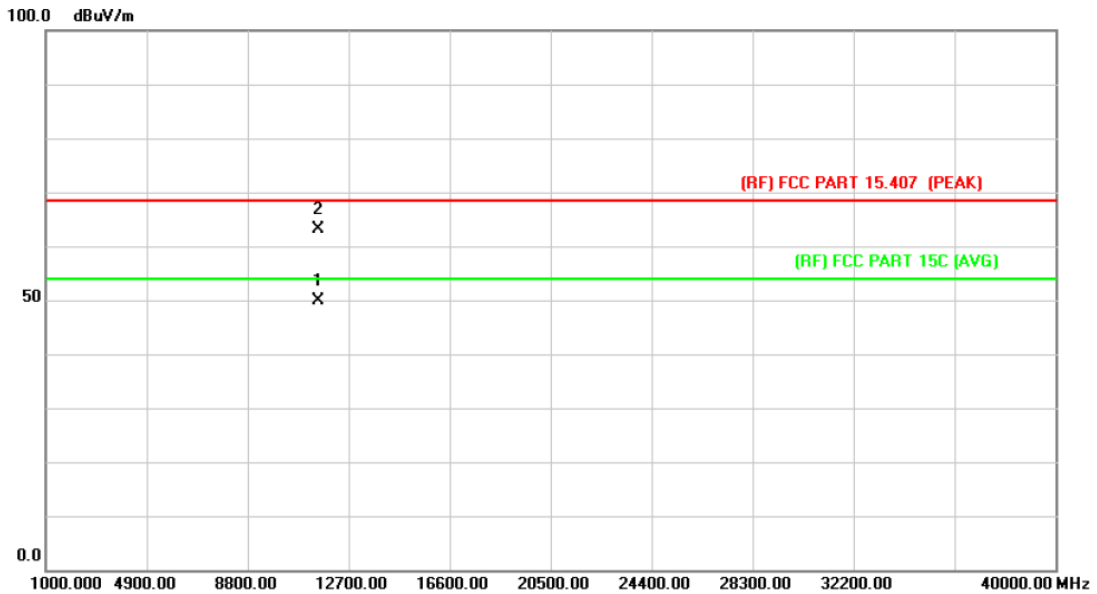

No.	Mk.	Freq.	Reading Level	Correct Factor	Measurement	Limit	Over	Detector
		MHz	dBuV	dB/m	dBuV/m	dBuV/m	dB	
1	*	11545.325	33.09	16.75	49.84	54.00	-4.16	AVG
2		11553.250	46.26	16.76	63.02	68.30	-5.28	peak

Emission Level= Read Level+ Correct Factor

Attachment C-- Restricted Bands Requirement and Band-edge Test Data

(1) Radiation Test

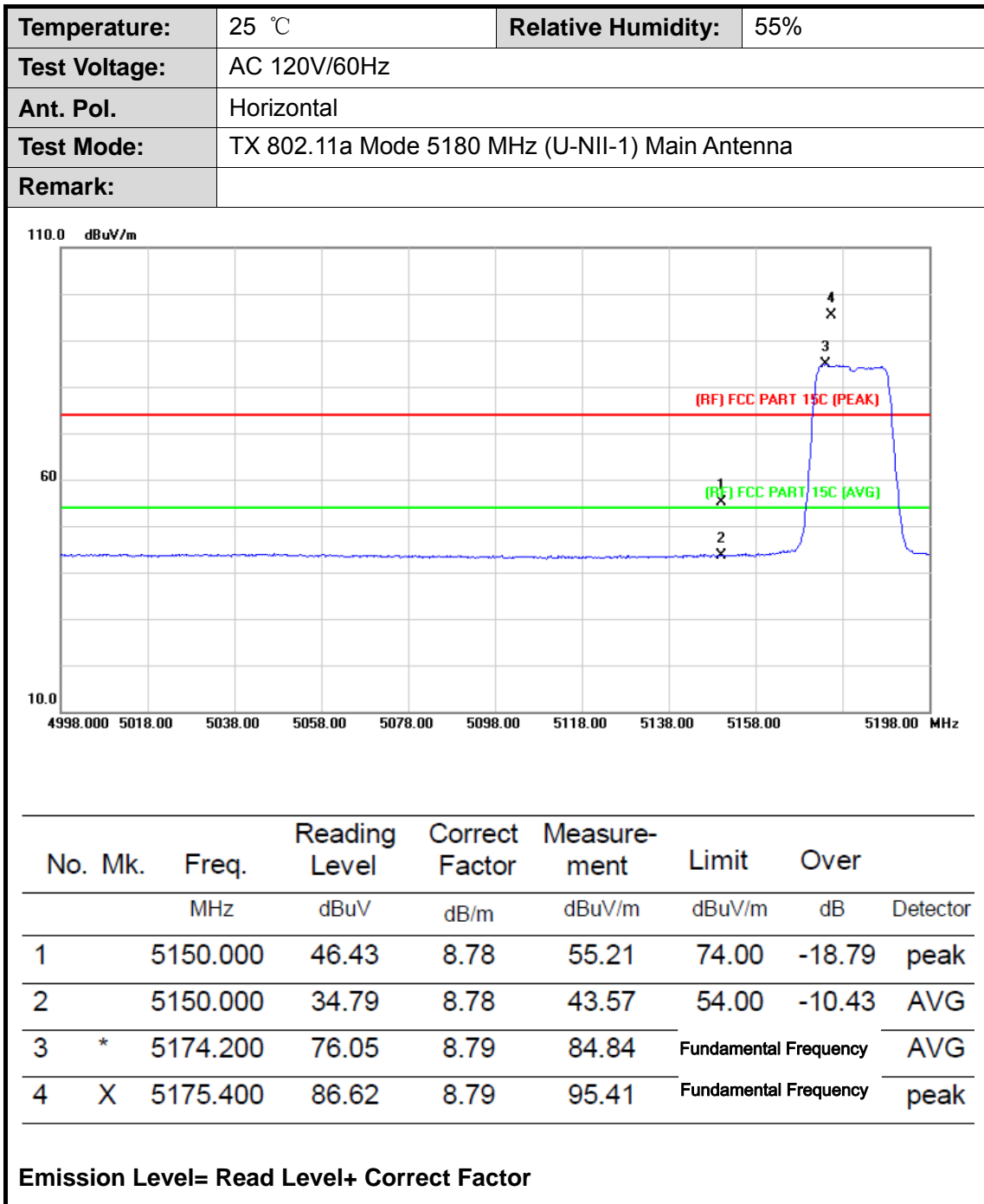

Temperature:	25 °C	Relative Humidity:	55%
Test Voltage:	AC 120V/60Hz		
Ant. Pol.	Vertical		
Test Mode:	TX 802.11a Mode 5180 MHz (U-NII-1) Main Antenna		
Remark:			

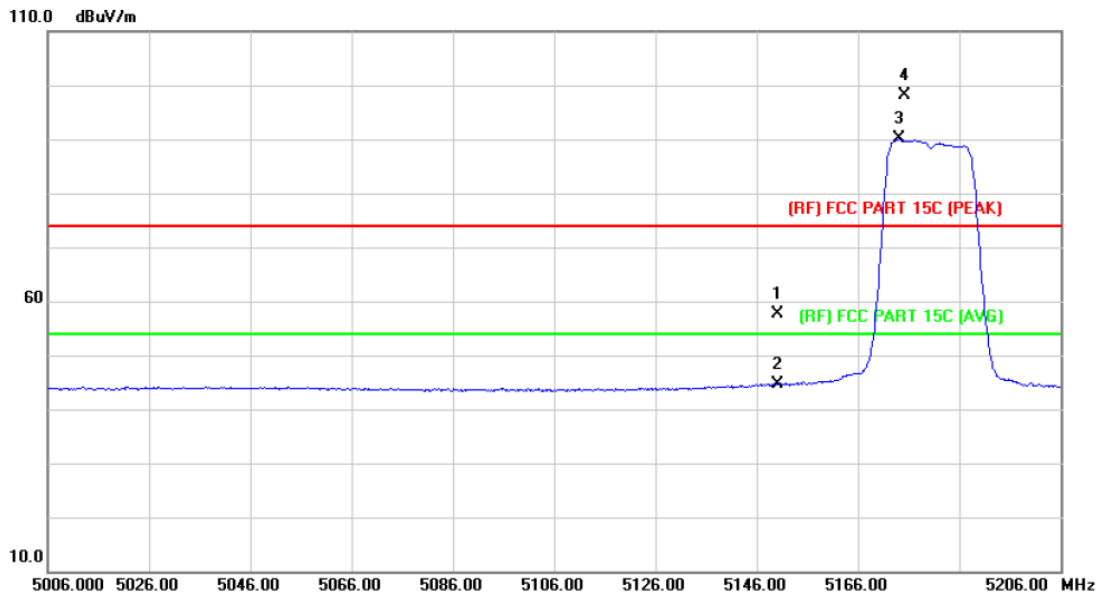

No.	Mk.	Freq. MHz	Reading Level dBuV	Correct Factor dB/m	Measure- ment dBuV/m	Limit dBuV/m	Over dB	Detector
1		5150.000	48.86	8.78	57.64	74.00	-16.36	peak
2		5150.000	35.85	8.78	44.63	54.00	-9.37	AVG
3	*	5174.200	81.25	8.79	90.04	Fundamental Frequency		AVG
4	X	5175.200	89.31	8.79	98.10	Fundamental Frequency		peak

Emission Level= Read Level+ Correct Factor

Temperature:	25 °C	Relative Humidity:	55%
Test Voltage:	AC 120V/60Hz		
Ant. Pol.	Horizontal		
Test Mode:	TX 802.11a Mode 5240 MHz (U-NII-1) Main Antenna		
Remark:			

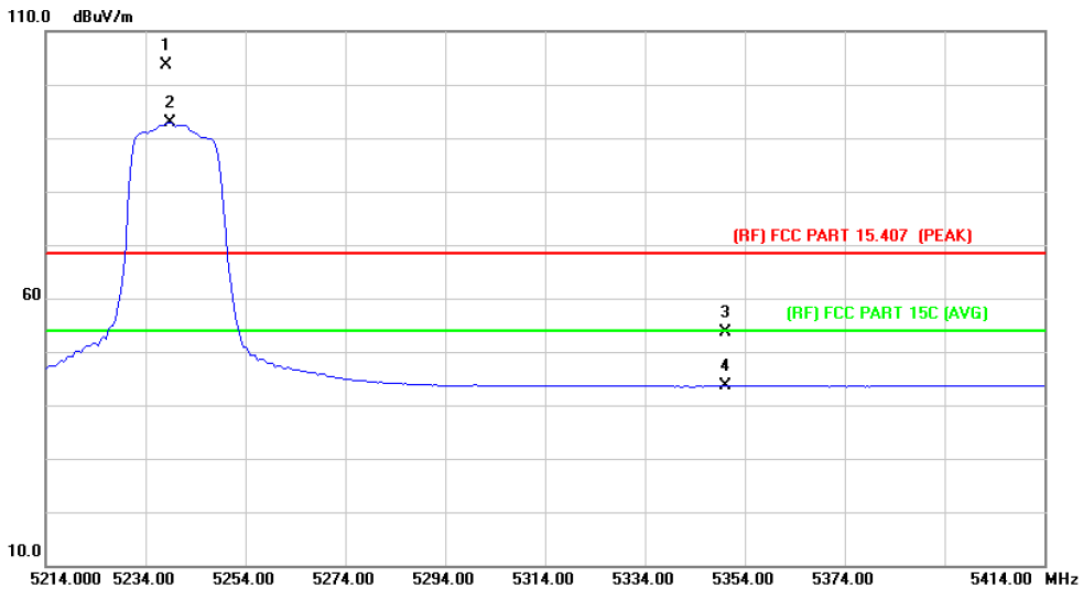

No.	Mk.	Freq. MHz	Reading Level dBuV	Correct Factor dB/m	Measure- ment dBuV/m	Limit dBuV/m	Over dB	Detector
1	X	5238.000	90.98	12.57	103.55	Fundamental Frequency		peak
2	*	5239.000	80.36	12.57	92.93	Fundamental Frequency		AVG
3		5350.000	40.88	12.78	53.66	68.30	-14.64	peak
4		5350.000	30.74	12.78	43.52	54.00	-10.48	AVG

Emission Level= Read Level+ Correct Factor

Temperature:	25 °C	Relative Humidity:	55%
Test Voltage:	AC 120V/60Hz		
Ant. Pol.	Vertical		
Test Mode:	TX 802.11a Mode 5240 MHz (U-NII-1) Main Antenna		
Remark:			

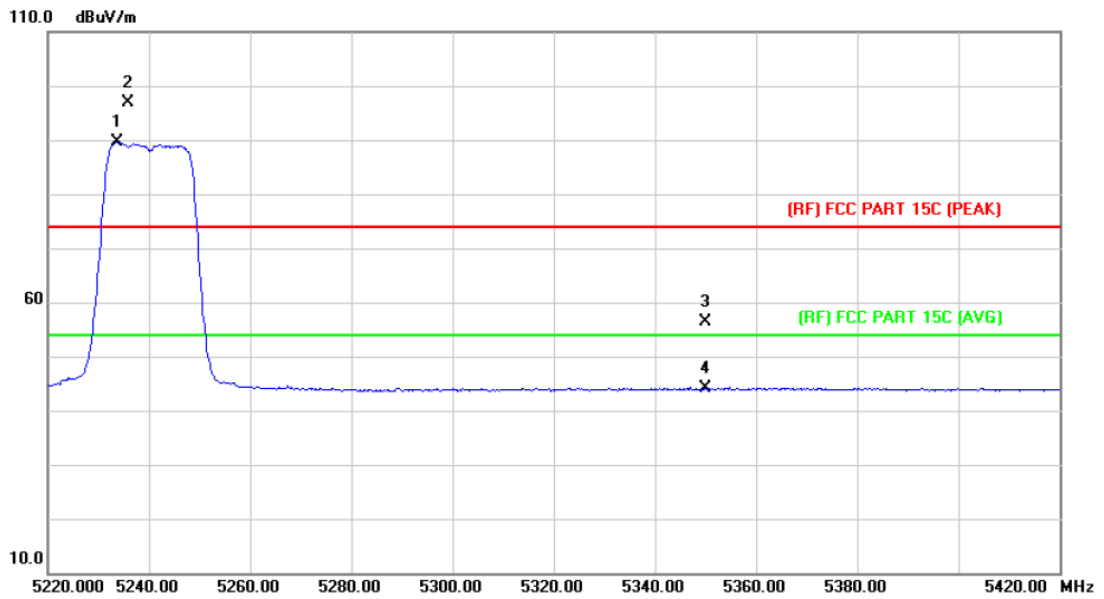

No.	Mk.	Freq.	Reading Level	Correct Factor	Measurement	Limit	Over	
		MHz	dBuV	dB/m	dBuV/m	dBuV/m	dB	Detector
1	*	5233.800	80.76	8.83	89.59	Fundamental Frequency		AVG
2	X	5235.800	88.04	8.83	96.87	Fundamental Frequency		peak
3		5350.000	47.37	8.91	56.28	74.00	-17.72	peak
4		5350.000	35.13	8.91	44.04	54.00	-9.96	AVG

Emission Level= Read Level+ Correct Factor

Temperature:	25 °C	Relative Humidity:	55%
Test Voltage:	AC 120V/60Hz		
Ant. Pol.	Horizontal		
Test Mode:	TX 802.11n(HT20) Mode 5180 MHz (U-NII-1) Main+AUX Antenna		
Remark:			

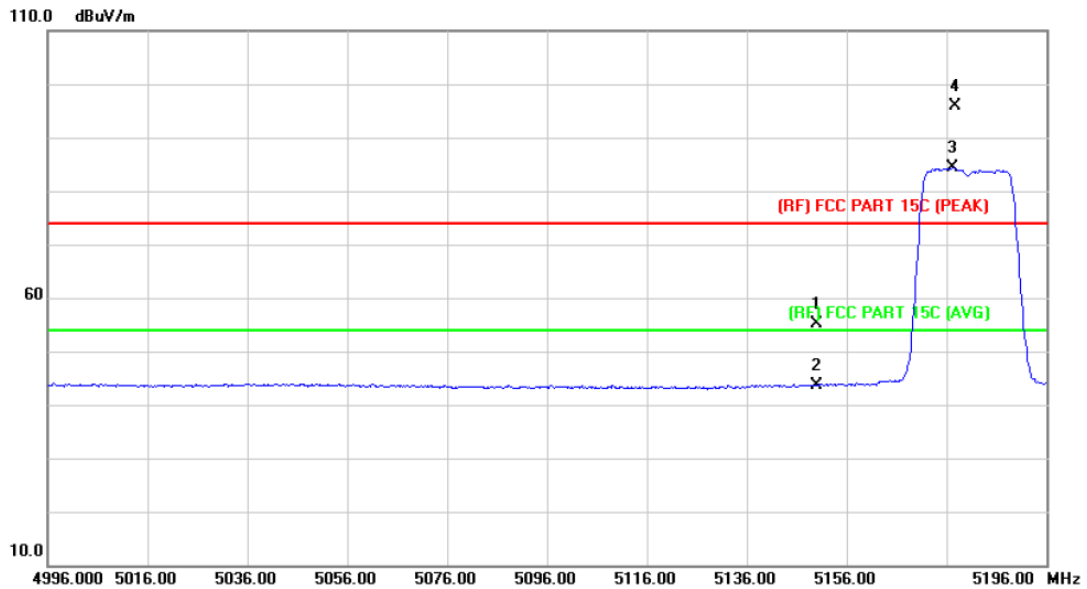

No.	Mk.	Freq. MHz	Reading Level dBuV	Correct Factor dB/m	Measure- ment dBuV/m	Limit dBuV/m	Over dB	Detector
1		5150.000	46.34	8.78	55.12	74.00	-18.88	peak
2		5150.000	34.76	8.78	43.54	54.00	-10.46	AVG
3	*	5177.200	75.49	8.79	84.28	Fundamental Frequency		AVG
4	X	5177.600	87.01	8.79	95.80	Fundamental Frequency		peak

Emission Level= Read Level+ Correct Factor

Temperature:	25 °C	Relative Humidity:	55%
Test Voltage:	AC 120V/60Hz		
Ant. Pol.	Vertical		
Test Mode:	TX 802.11n(HT20) Mode 5180 MHz (U-NII-1) Main+AUX Antenna		
Remark:			

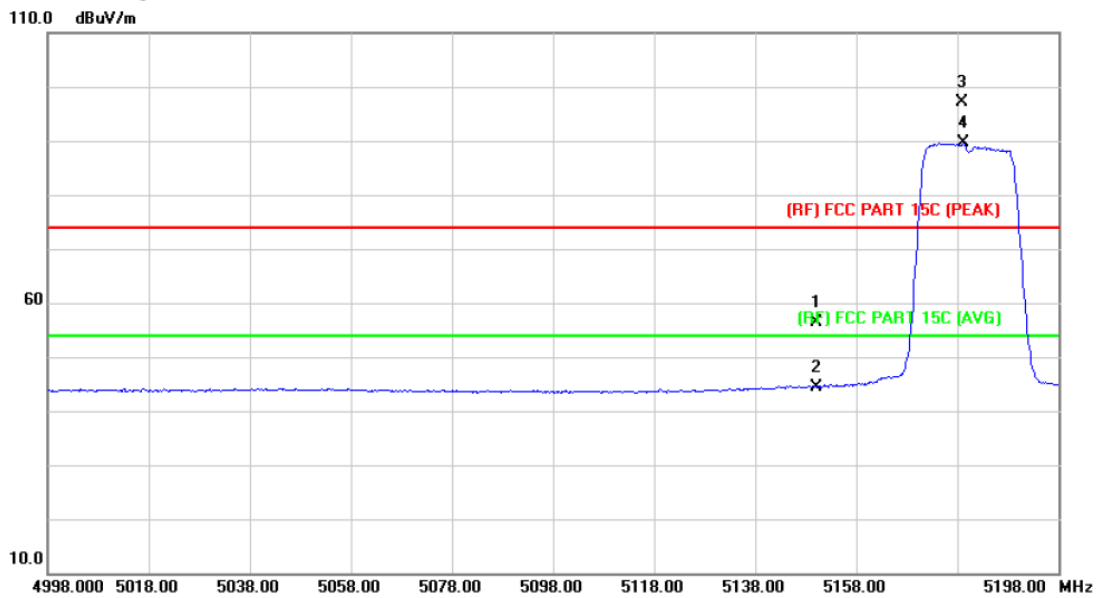

No.	Mk.	Freq.	Reading Level	Correct Factor	Measurement	Limit	Over	Detector
		MHz	dBuV	dB/m	dBuV/m	dBuV/m	dB	
1		5150.000	47.63	8.78	56.41	74.00	-17.59	peak
2		5150.000	35.70	8.78	44.48	54.00	-9.52	AVG
3	X	5179.000	88.45	8.79	97.24	Fundamental Frequency		peak
4	*	5179.200	80.76	8.79	89.55	Fundamental Frequency		AVG

Emission Level= Read Level+ Correct Factor

Temperature:	25 °C	Relative Humidity:	55%
Test Voltage:	AC 120V/60Hz		
Ant. Pol.	Horizontal		
Test Mode:	TX 802.11n(HT20) Mode 5240 MHz (U-NII-1) Main+AUX Antenna		
Remark:			

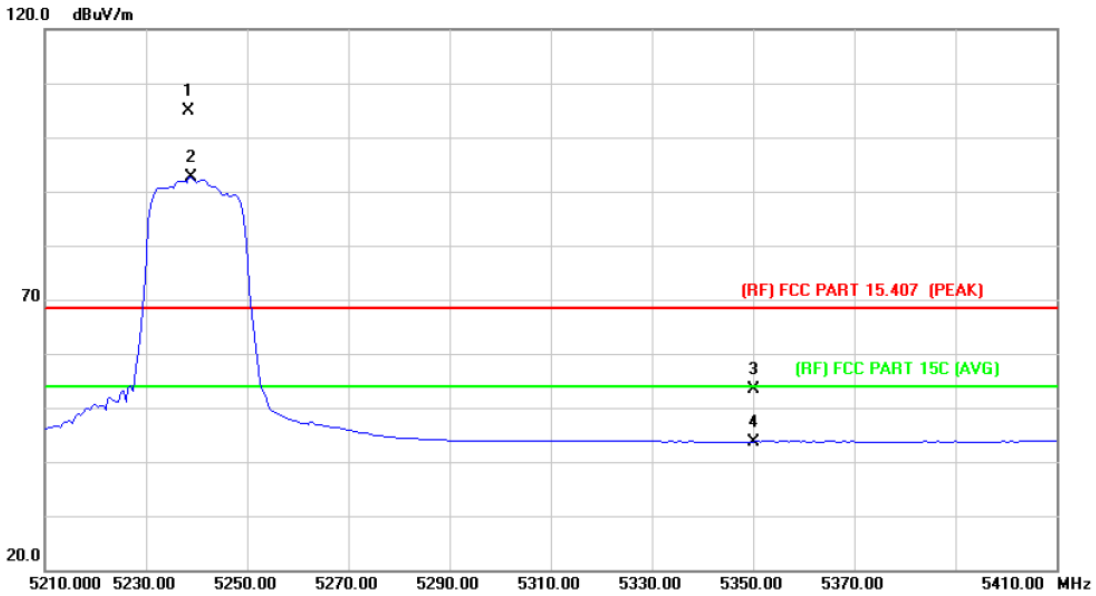

No.	Mk.	Freq. MHz	Reading Level dBuV	Correct Factor dB/m	Measure- ment dBuV/m	Limit dBuV/m	Over dB	Detector
1	X	5238.500	92.24	12.57	104.81	Fundamental Frequency		peak
2	*	5239.000	79.98	12.57	92.55	Fundamental Frequency		AVG
3		5350.000	40.72	12.78	53.50	68.30	-14.80	peak
4		5350.000	30.96	12.78	43.74	54.00	-10.26	AVG

Emission Level= Read Level+ Correct Factor

Temperature:	25 °C	Relative Humidity:	55%
Test Voltage:	AC 120V/60Hz		
Ant. Pol.	Vertical		
Test Mode:	TX 802.11n(HT20) Mode 5240 MHz (U-NII-1) Main+AUX Antenna		
Remark:			

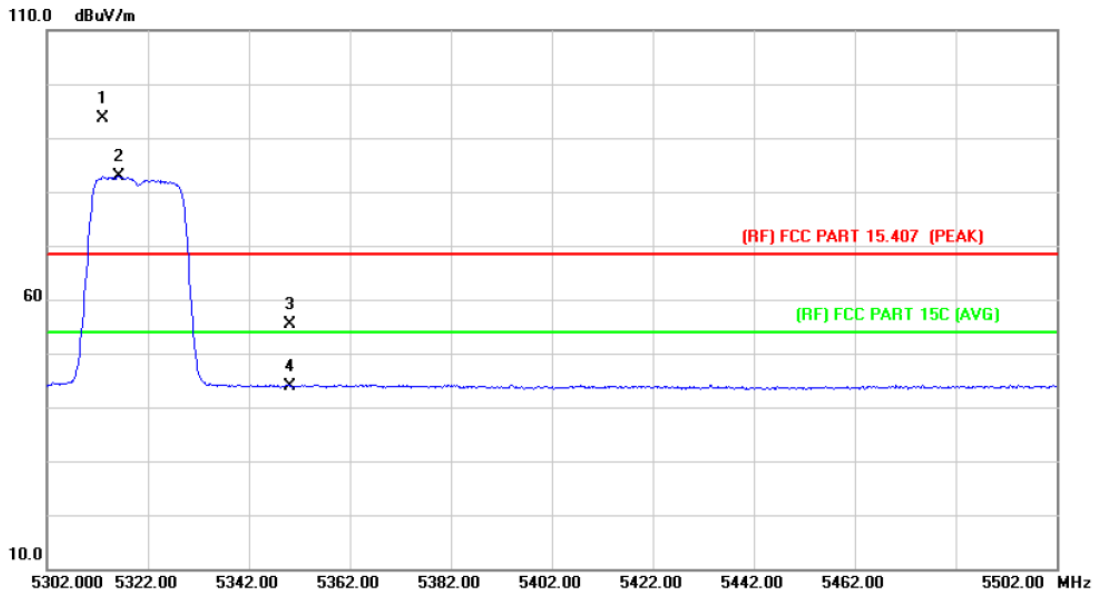

No.	Mk.	Freq. MHz	Reading Level dBuV	Correct Factor dB/m	Measure- ment dBuV/m	Limit dBuV/m	Over dB	Detector
1	X	5313.200	84.78	8.88	93.66	Fundamental Frequency		peak
2	*	5316.200	73.93	8.88	82.81	Fundamental Frequency		AVG
3		5350.000	46.43	8.91	55.34	68.30	-12.96	peak
4		5350.000	35.08	8.91	43.99	54.00	-10.01	AVG

Emission Level= Read Level+ Correct Factor

Temperature:	25 °C	Relative Humidity:	55%
Test Voltage:	AC 120V/60Hz		
Ant. Pol.	Horizontal		
Test Mode:	TX 802.11ac(VHT20) Mode 5180 MHz (U-NII-1) Main+AUX Antenna		
Remark:			

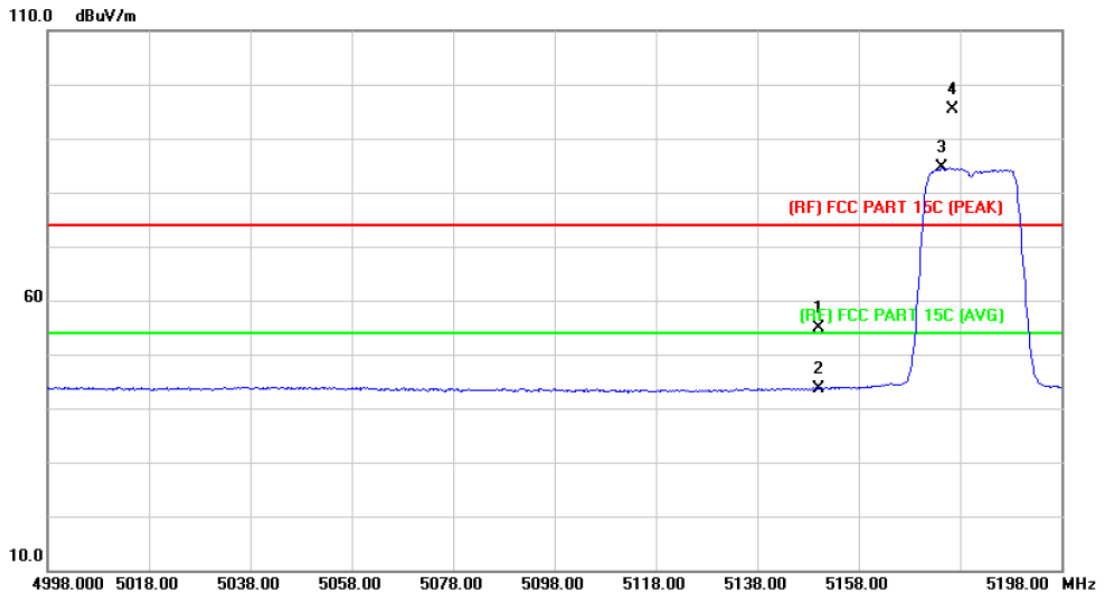

No.	Mk.	Freq. MHz	Reading Level dBuV	Correct Factor dB/m	Measure- ment dBuV/m	Limit dBuV/m	Over dB	Detector
1		5150.000	46.03	8.78	54.81	74.00	-19.19	peak
2		5150.000	34.92	8.78	43.70	54.00	-10.30	AVG
3	*	5174.400	75.76	8.79	84.55	Fundamental Frequency		AVG
4	X	5176.600	86.48	8.79	95.27	Fundamental Frequency		peak

Emission Level= Read Level+ Correct Factor

Temperature:	25 °C	Relative Humidity:	55%
Test Voltage:	AC 120V/60Hz		
Ant. Pol.	Vertical		
Test Mode:	TX 802.11ac(VHT20) Mode 5180 MHz (U-NII-1) Main+AUX Antenna		
Remark:			

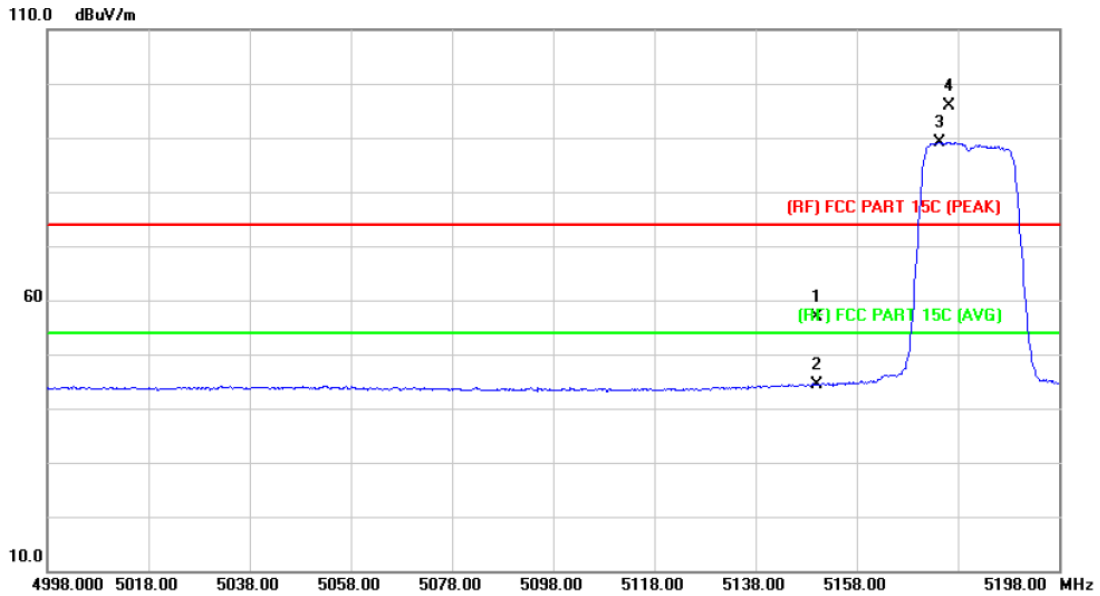

No.	Mk.	Freq. MHz	Reading Level dBuV	Correct Factor dB/m	Measure- ment dBuV/m	Limit dBuV/m	Over dB	Detector
1		5150.000	48.20	8.78	56.98	74.00	-17.02	peak
2		5150.000	35.56	8.78	44.34	54.00	-9.66	AVG
3	*	5174.400	80.38	8.79	89.17	Fundamental Frequency		AVG
4	X	5176.400	87.08	8.79	95.87	Fundamental Frequency		peak

Emission Level= Read Level+ Correct Factor

Temperature:	25 °C	Relative Humidity:	55%
Test Voltage:	AC 120V/60Hz		
Ant. Pol.	Horizontal		
Test Mode:	TX 802.11ac(VHT20) Mode 5240 MHz (U-NII-1) Main+AUX Antenna		
Remark:			

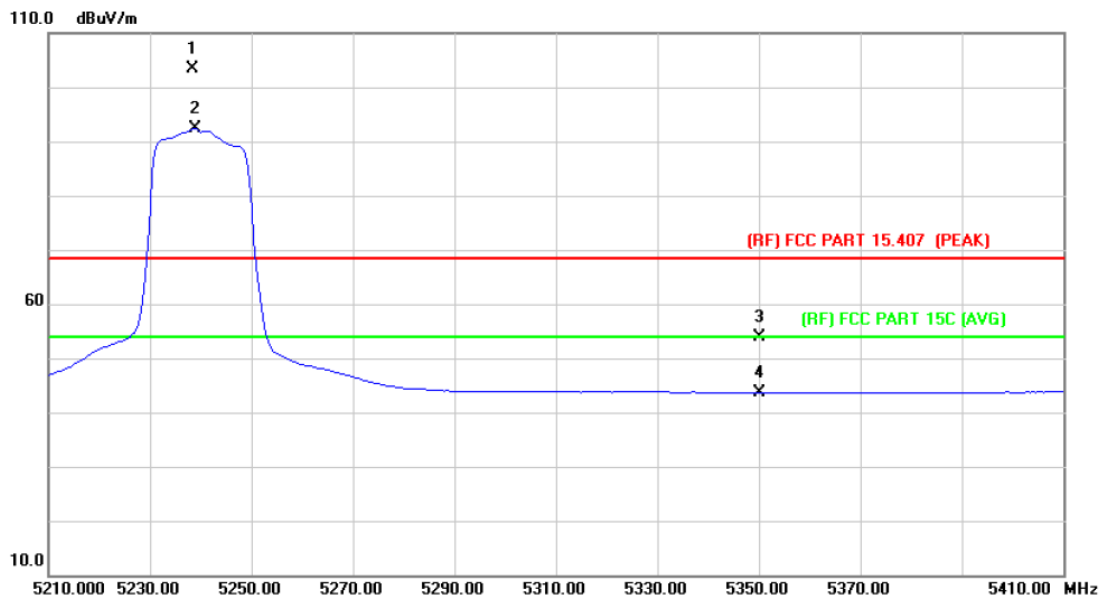

No.	Mk.	Freq.	Reading Level	Correct Factor	Measurement	Limit	Over	Detector
		MHz	dBuV	dB/m	dBuV/m	dBuV/m	dB	
1	X	5238.500	90.80	12.57	103.37	Fundamental Frequency		peak
2	*	5239.000	79.70	12.57	92.27	Fundamental Frequency		AVG
3		5350.000	41.12	12.78	53.90	68.30	-14.40	peak
4		5350.000	30.93	12.78	43.71	54.00	-10.29	AVG

Emission Level= Read Level+ Correct Factor

Temperature:	25 °C	Relative Humidity:	55%
Test Voltage:	AC 120V/60Hz		
Ant. Pol.	Vertical		
Test Mode:	TX 802.11ac(VHT20) Mode 5240 MHz (U-NII-1) Main+AUX Antenna		
Remark:			

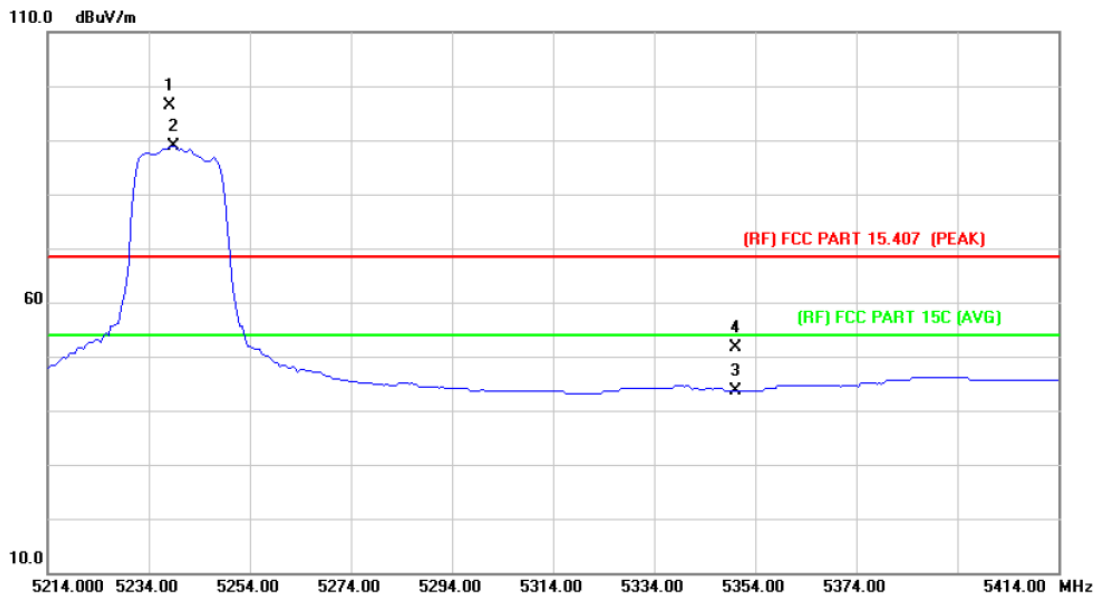

No.	Mk.	Freq. MHz	Reading Level dBuV	Correct Factor dB/m	Measure- ment dBuV/m	Limit dBuV/m	Over dB	Detector
1	*	5238.000	83.80	12.57	96.37	Fundamental Frequency		peak
2	X	5239.000	76.36	12.57	88.93	Fundamental Frequency		AVG
3		5350.000	30.93	12.78	43.71	54.00	-10.29	AVG
4		5350.000	38.86	12.78	51.64	68.30	-16.66	peak

Emission Level= Read Level+ Correct Factor

Temperature:	25 °C	Relative Humidity:	55%
Test Voltage:	AC 120V/60Hz		
Ant. Pol.	Horizontal		
Test Mode:	TX 802.11n(HT40) Mode 5190 MHz (U-NII-1) Main+AUX Antenna		
Remark:			

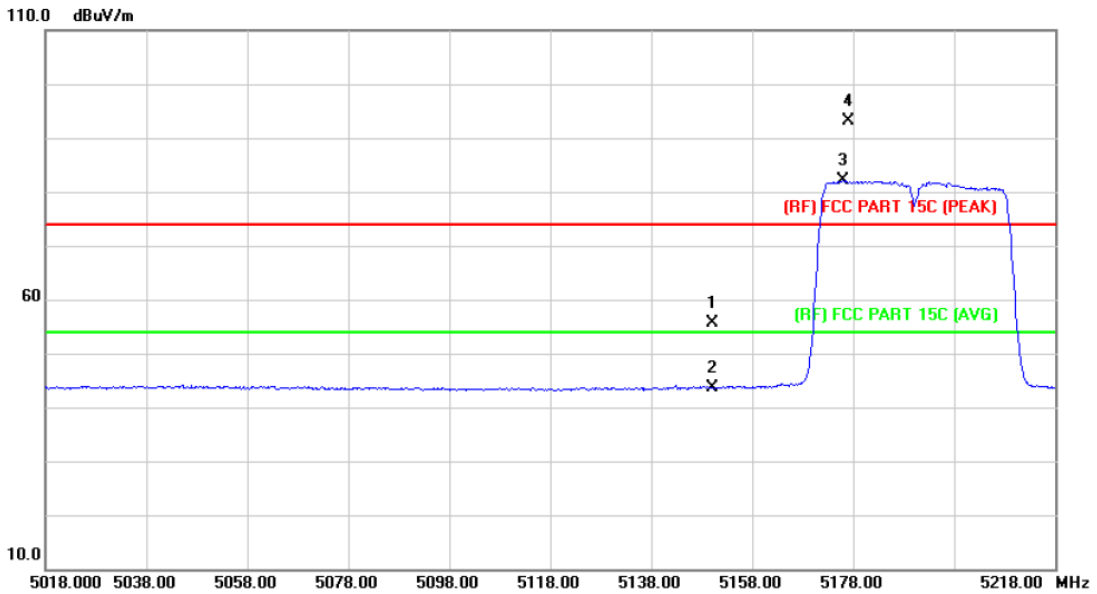

No.	Mk.	Freq.	Reading Level	Correct Factor	Measurement	Limit	Over	Detector
		MHz	dBuV	dB/m	dBuV/m	dBuV/m	dB	
1		5150.000	46.95	8.78	55.73	74.00	-18.27	peak
2		5150.000	34.89	8.78	43.67	54.00	-10.33	AVG
3	*	5176.000	73.25	8.79	82.04	Fundamental Frequency		AVG
4	X	5177.200	84.30	8.79	93.09	Fundamental Frequency		peak

Emission Level= Read Level+ Correct Factor

Temperature:	25 °C	Relative Humidity:	55%
Test Voltage:	AC 120V/60Hz		
Ant. Pol.	Vertical		
Test Mode:	TX 802.11n(HT40) Mode 5190 MHz (U-NII-1) Main+AUX Antenna		
Remark:			

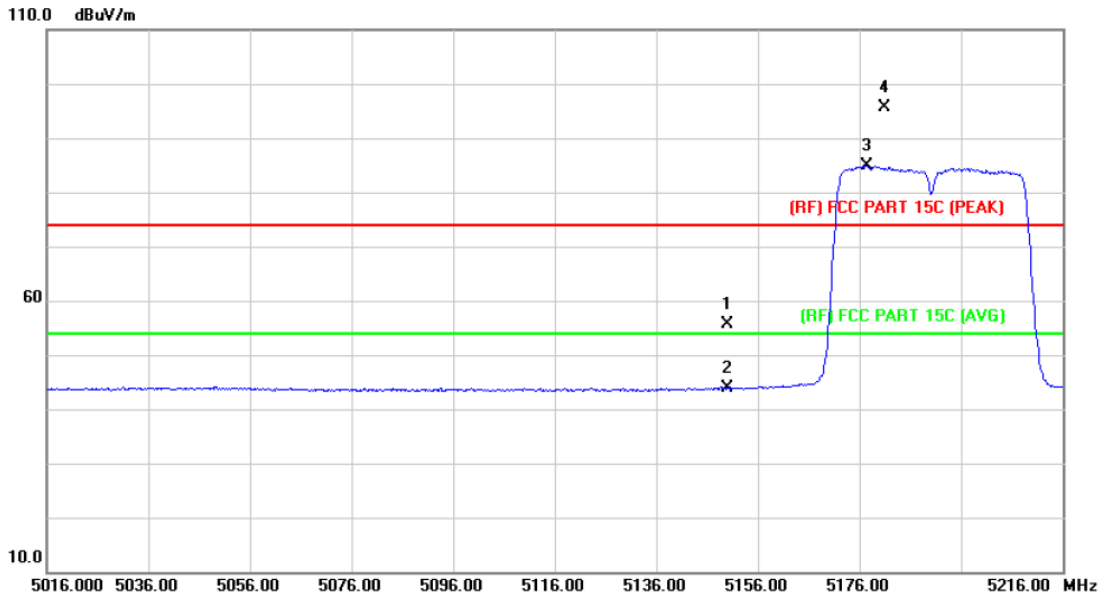

No.	Mk.	Freq. MHz	Reading Level dBuV	Correct Factor dB/m	Measure- ment dBuV/m	Limit dBuV/m	Over dB	Detector
1		5150.000	46.84	8.78	55.62	74.00	-18.38	peak
2		5150.000	35.04	8.78	43.82	54.00	-10.18	AVG
3	*	5177.400	76.12	8.79	84.91	Fundamental Frequency		AVG
4	X	5180.800	86.87	8.79	95.66	Fundamental Frequency		peak

Emission Level= Read Level+ Correct Factor

Temperature:	25 °C	Relative Humidity:	55%
Test Voltage:	AC 120V/60Hz		
Ant. Pol.	Horizontal		
Test Mode:	TX 802.11n(HT40) Mode 5230 MHz (U-NII-1) Main+AUX Antenna		
Remark:			

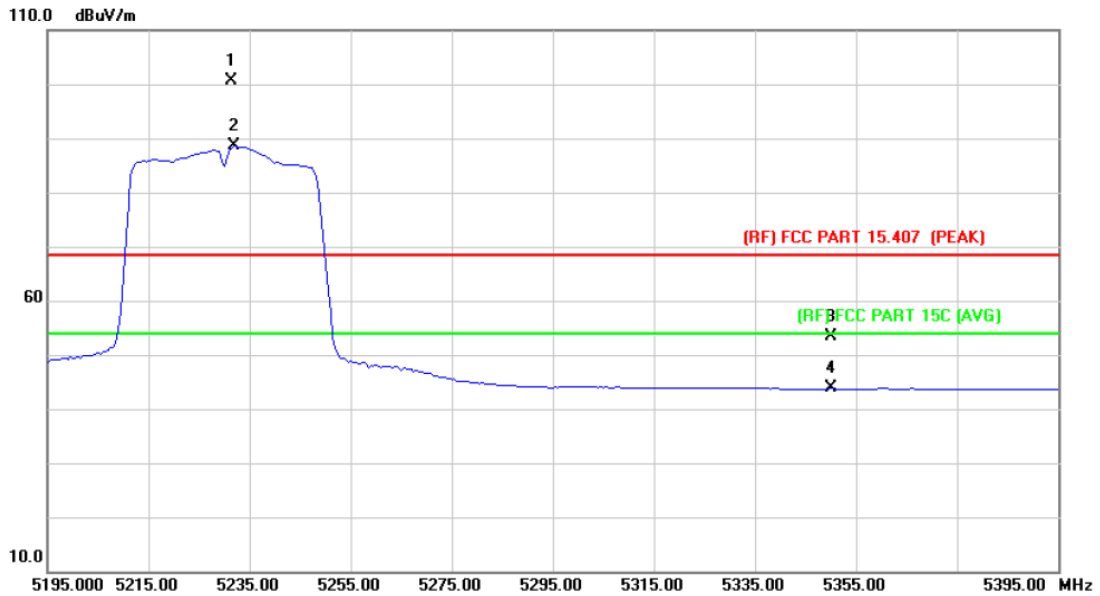

No.	Mk.	Freq. MHz	Reading Level dBuV	Correct Factor dB/m	Measure- ment dBuV/m	Limit dBuV/m	Over dB	Detector
1	X	5231.500	88.07	12.56	100.63	Fundamental Frequency		peak
2	*	5232.000	76.01	12.56	88.57	Fundamental Frequency		AVG
3		5350.000	40.52	12.78	53.30	68.30	-15.00	peak
4		5350.000	30.99	12.78	43.77	54.00	-10.23	AVG

Emission Level= Read Level+ Correct Factor

Temperature:	25 °C	Relative Humidity:	55%
Test Voltage:	AC 120V/60Hz		
Ant. Pol.	Vertical		
Test Mode:	TX 802.11n(HT40) Mode 5230 MHz (U-NII-1) Main+AUX Antenna		
Remark:			

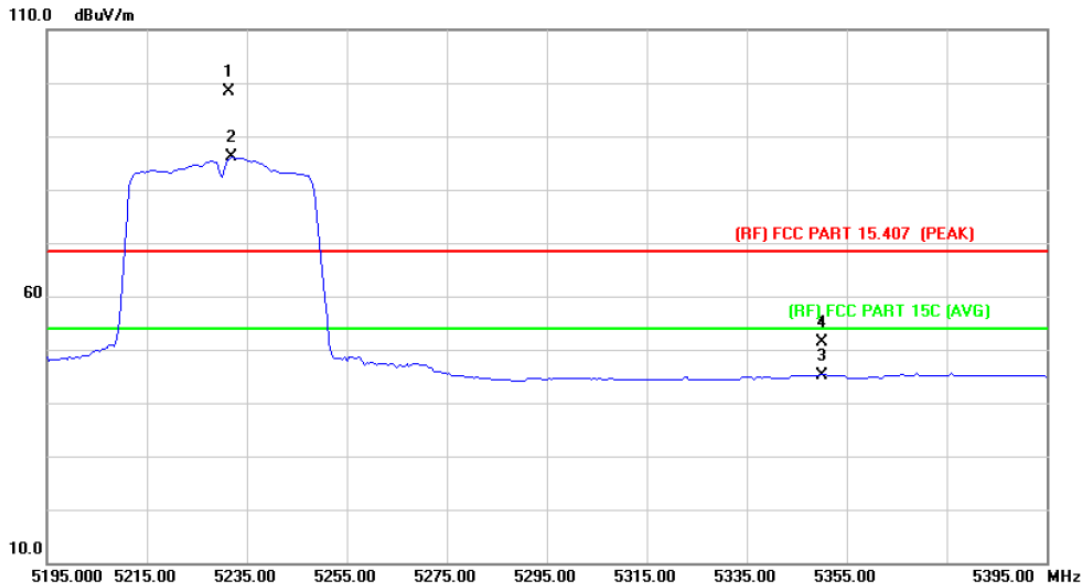

No.	Mk.	Freq. MHz	Reading Level dBuV	Correct Factor dB/m	Measure- ment dBuV/m	Limit dBuV/m	Over dB	Detector
1	*	5231.500	85.90	12.56	98.46	Fundamental Frequency		peak
2	X	5232.000	73.51	12.56	86.07	Fundamental Frequency		AVG
3		5350.000	32.38	12.78	45.16	54.00	-8.84	AVG
4		5350.000	38.53	12.78	51.31	68.30	-16.99	Peak

Emission Level= Read Level+ Correct Factor

Temperature:	25 °C	Relative Humidity:	55%
Test Voltage:	AC 120V/60Hz		
Ant. Pol.	Horizontal		
Test Mode:	TX 802.11ac(VHT40) Mode 5190 MHz (U-NII-1) Main+AUX Antenna		
Remark:			

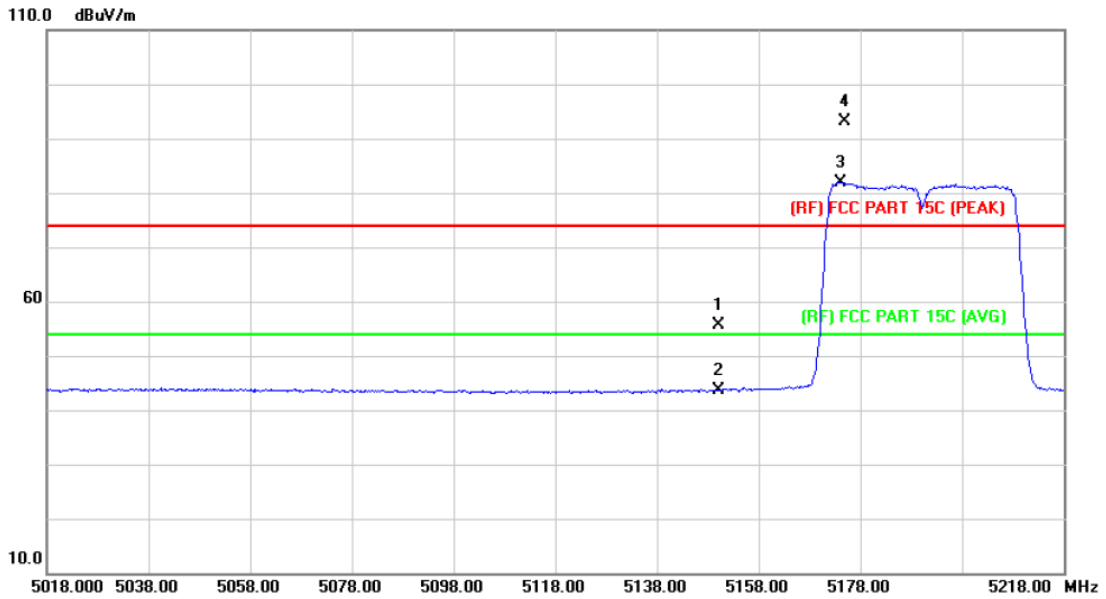

No.	Mk.	Freq. MHz	Reading Level dBuV	Correct Factor dB/m	Measure- ment dBuV/m	Limit dBuV/m	Over dB	Detector
1		5150.000	46.82	8.78	55.60	74.00	-18.40	peak
2		5150.000	34.89	8.78	43.67	54.00	-10.33	AVG
3	*	5174.000	73.06	8.79	81.85	Fundamental Frequency		AVG
4	X	5175.000	84.35	8.79	93.14	Fundamental Frequency		peak

Emission Level= Read Level+ Correct Factor

Temperature:	25 °C	Relative Humidity:	55%
Test Voltage:	AC 120V/60Hz		
Ant. Pol.	Vertical		
Test Mode:	TX 802.11ac(VHT40) Mode 5190 MHz (U-NII-1) Main+AUX Antenna		
Remark:			

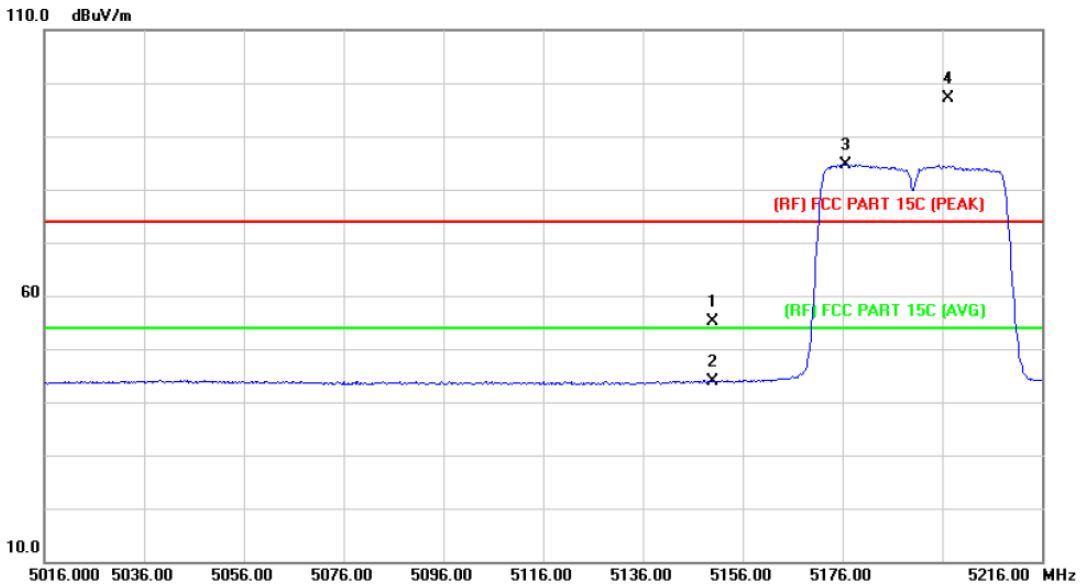

No.	Mk.	Freq.	Reading Level	Correct Factor	Measurement	Limit	Over	Detector
		MHz	dBuV	dB/m	dBuV/m	dBuV/m	dB	
1		5150.000	46.27	8.78	55.05	74.00	-18.95	peak
2		5150.000	35.03	8.78	43.81	54.00	-10.19	AVG
3	*	5176.600	75.93	8.79	84.72	Fundamental Frequency		AVG
4	X	5197.200	88.26	8.81	97.07	Fundamental Frequency		peak

Emission Level= Read Level+ Correct Factor

Temperature:	25 °C	Relative Humidity:	55%
Test Voltage:	AC 120V/60Hz		
Ant. Pol.	Horizontal		
Test Mode:	TX 802.11ac(VHT40) Mode 5230 MHz (U-NII-1) Main+AUX Antenna		
Remark:			

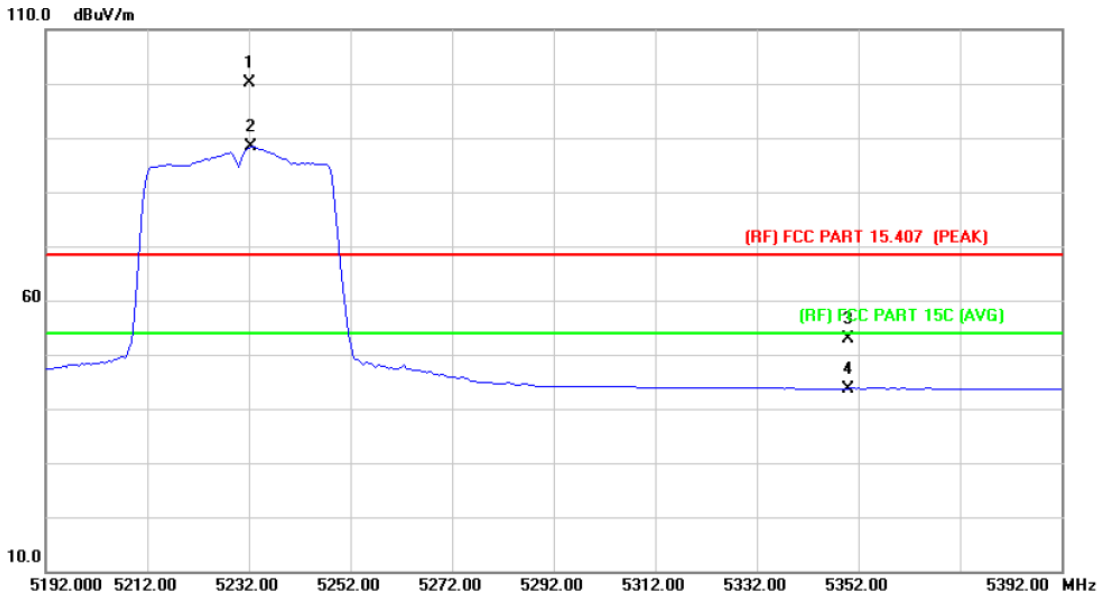

No.	Mk.	Freq. MHz	Reading Level dBuV	Correct Factor dB/m	Measure- ment dBuV/m	Limit dBuV/m	Over dB	Detector
1	X	5232.000	87.45	12.56	100.01	Fundamental Frequency		peak
2	*	5232.500	75.71	12.56	88.27	Fundamental Frequency		AVG
3		5350.000	40.12	12.78	52.90	68.30	-15.40	peak
4		5350.000	30.97	12.78	43.75	54.00	-10.25	AVG

Emission Level= Read Level+ Correct Factor

Temperature:	25 °C	Relative Humidity:	55%
Test Voltage:	AC 120V/60Hz		
Ant. Pol.	Vertical		
Test Mode:	TX 802.11ac(VHT40) Mode 5230 MHz (U-NII-1) Main+AUX Antenna		
Remark:			

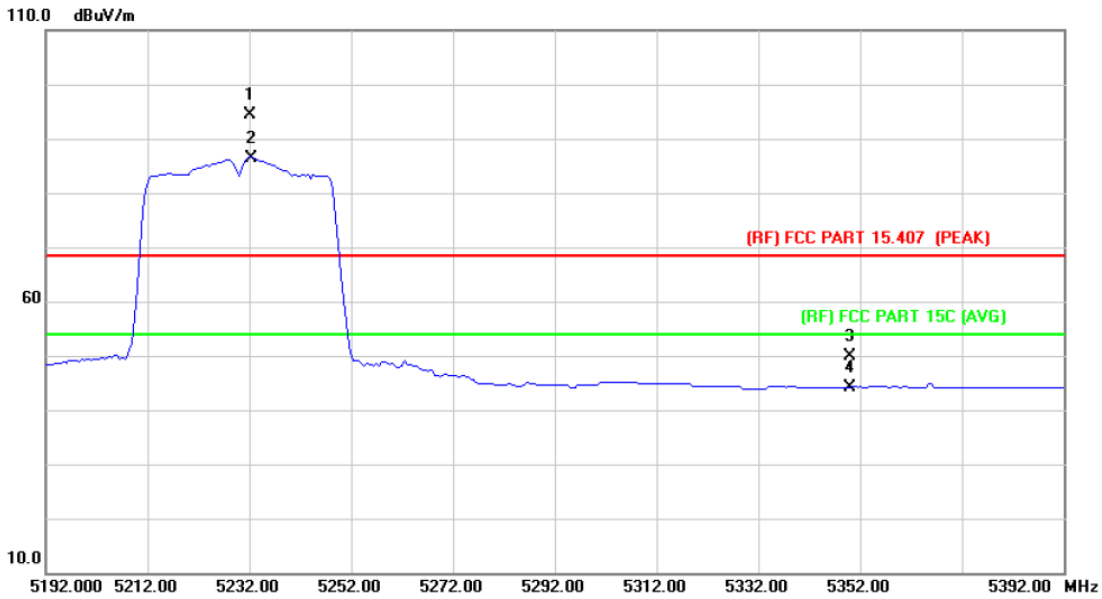

No.	Mk.	Freq. MHz	Reading Level dBuV	Correct Factor dB/m	Measure- ment dBuV/m	Limit dBuV/m	Over dB	Detector
1	X	5232.000	81.76	12.56	94.32	Fundamental Frequency		peak
2	*	5232.500	73.71	12.56	86.27	Fundamental Frequency		AVG
3		5350.000	37.13	12.78	49.91	68.30	-18.39	peak
4		5350.000	31.41	12.78	44.19	54.00	-9.81	AVG

Emission Level= Read Level+ Correct Factor

Temperature:	25 °C	Relative Humidity:	55%
Test Voltage:	AC 120V/60Hz		
Ant. Pol.	Horizontal		
Test Mode:	TX 802.11ac(VHT80) Mode 5210 MHz (U-NII-1) Main+AUX Antenna		
Remark:			

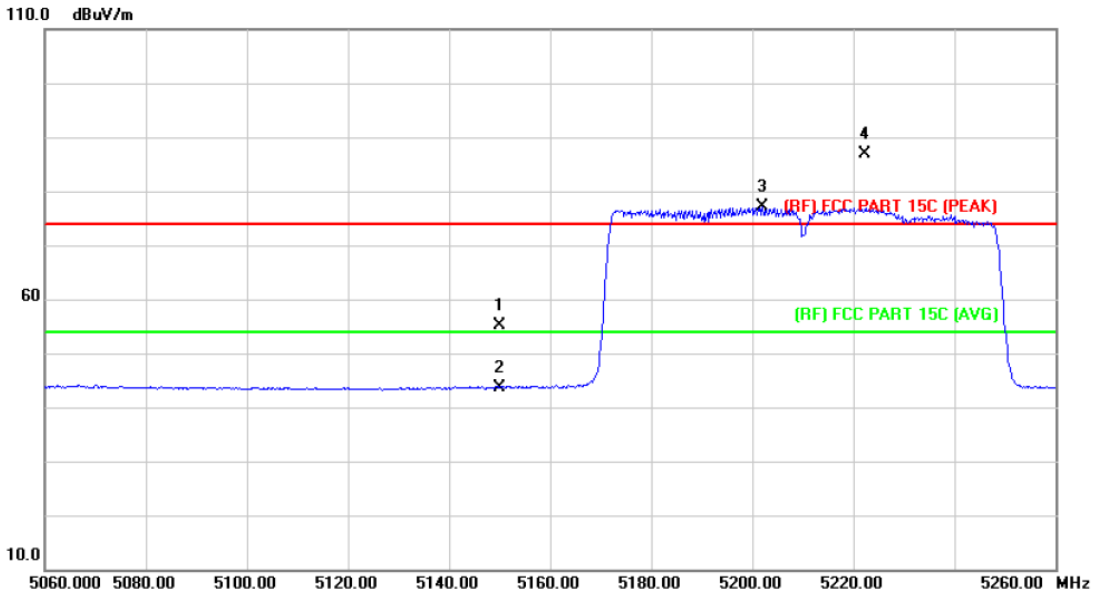

No.	Mk.	Freq.	Reading Level	Correct Factor	Measurement	Limit	Over	Detector
		MHz	dBuV	dB/m	dBuV/m	dBuV/m	dB	
1		5150.000	46.36	8.78	55.14	74.00	-18.86	peak
2		5150.000	34.94	8.78	43.72	54.00	-10.28	AVG
3	*	5202.000	68.31	8.81	77.12	Fundamental Frequency		AVG
4	X	5222.200	77.94	8.82	86.76	Fundamental Frequency		peak

Emission Level= Read Level+ Correct Factor

Temperature:	25 °C	Relative Humidity:	55%
Test Voltage:	AC 120V/60Hz		
Ant. Pol.	Vertical		
Test Mode:	TX 802.11ac(VHT80) Mode 5210 MHz (U-NII-1) Main+AUX Antenna		
Remark:			

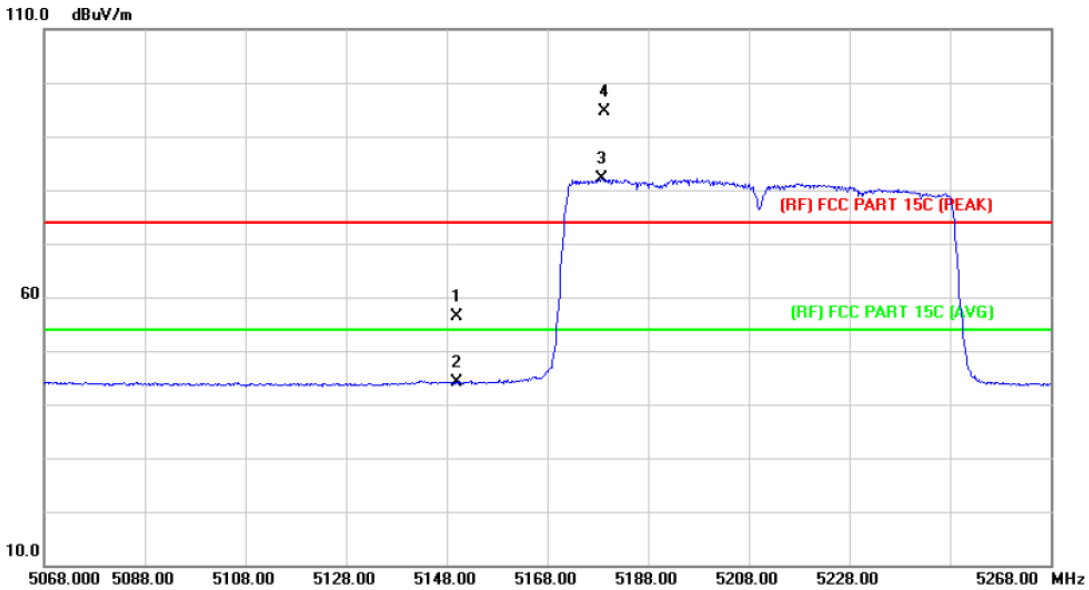

No.	Mk.	Freq. MHz	Reading Level dBuV	Correct Factor dB/m	Measure- ment dBuV/m	Limit dBuV/m	Over dB	Detector
1		5150.000	47.66	8.78	56.44	74.00	-17.56	peak
2		5150.000	35.28	8.78	44.06	54.00	-9.94	AVG
3	*	5178.800	73.32	8.79	82.11	Fundamental Frequency		AVG
4	X	5179.400	85.81	8.79	94.60	Fundamental Frequency		peak

Emission Level= Read Level+ Correct Factor

Temperature:	25 °C	Relative Humidity:	55%
Test Voltage:	AC 120V/60Hz		
Ant. Pol.	Horizontal		
Test Mode:	TX 802.11a Mode 5745 MHz (U-NII-3) Main Antenna		
Remark:			

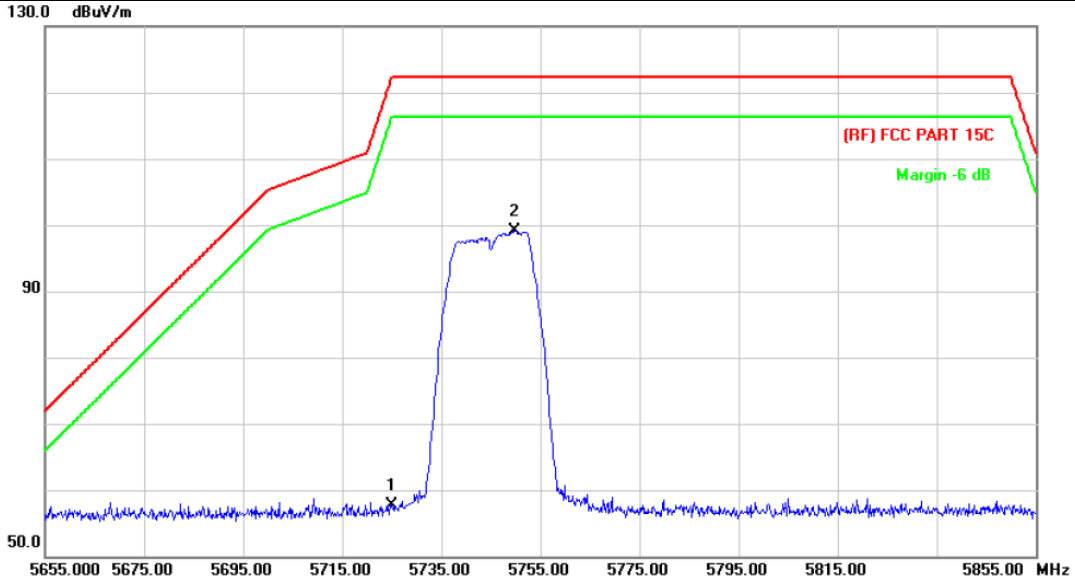

No.	Mk.	Freq. MHz	Reading Level dBuV	Correct Factor dB/m	Measure- ment dBuV/m	Limit dBuV/m	Over dB	Detector
1		5725.000	47.89	9.78	57.67	122.30	-64.63	peak
2	*	5749.800	89.27	9.84	99.11	122.30	-23.19	peak

Emission Level= Read Level+ Correct Factor

Temperature:	25 °C	Relative Humidity:	55%
Test Voltage:	AC 120V/60Hz		
Ant. Pol.	Vertical		
Test Mode:	TX 802.11a Mode 5745 MHz (U-NII-3) Main Antenna		
Remark:			

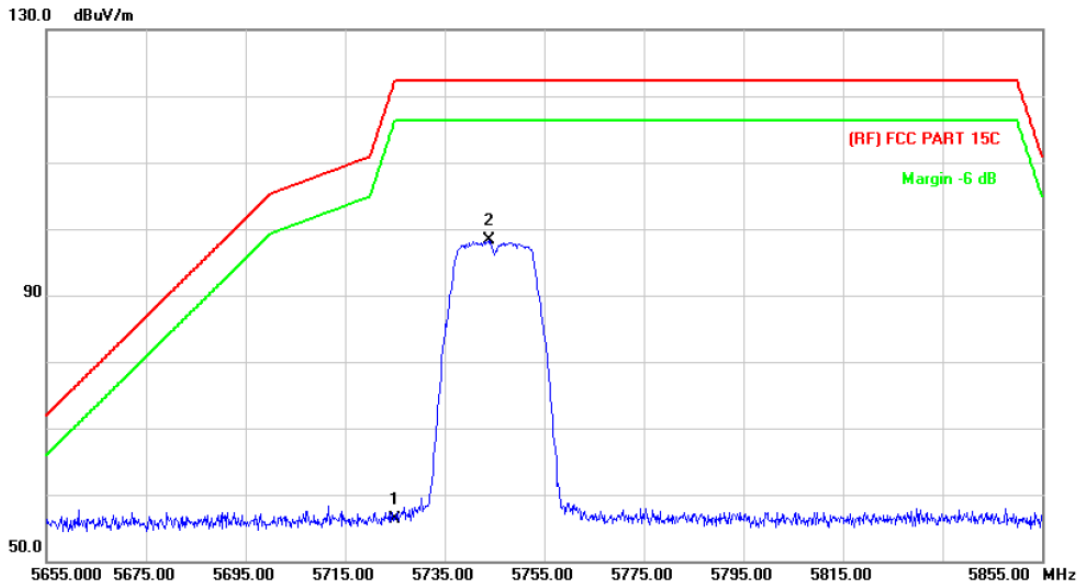

No.	Mk.	Freq. MHz	Reading Level dBuV	Correct Factor dB/m	Measure- ment dBuV/m	Limit dBuV/m	Over dB	Detector
1		5725.000	46.55	9.78	56.33	122.30	-65.97	peak
2	*	5744.000	88.45	9.83	98.28	122.30	-24.02	peak

Emission Level= Read Level+ Correct Factor

Temperature:	25 °C	Relative Humidity:	55%
Test Voltage:	AC 120V/60Hz		
Ant. Pol.	Horizontal		
Test Mode:	TX 802.11a Mode 5825 MHz (U-NII-3) Main Antenna		
Remark:			

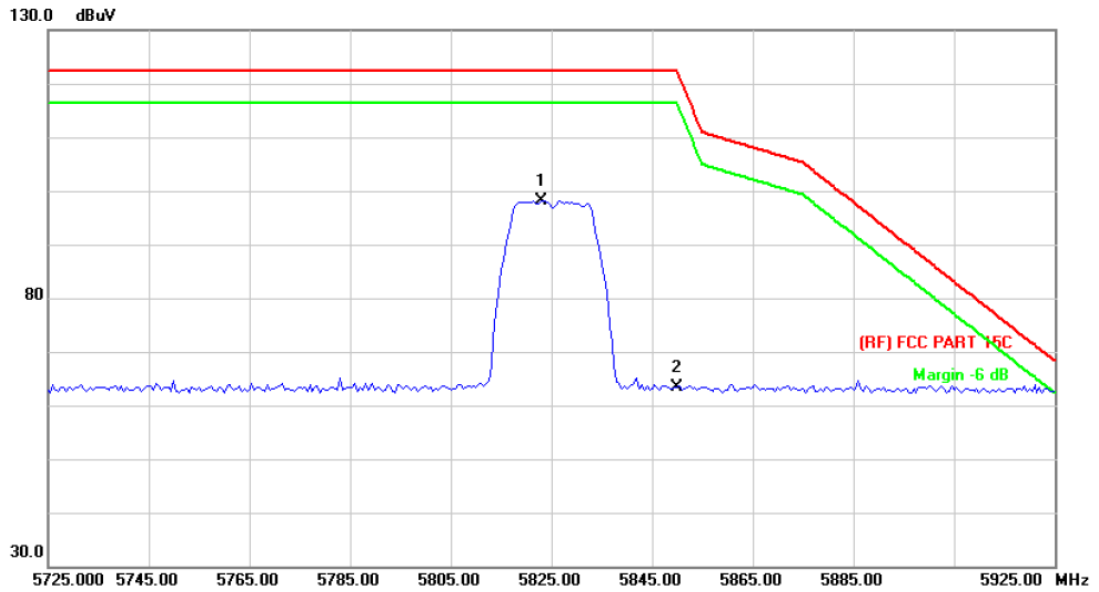

No.	Mk.	Freq. MHz	Reading Level dBuV	Correct Factor dB	Measure- ment dBuV	Limit dBuV	Over dB	Detector
1	*	5823.000	88.94	9.23	98.17	122.30	-24.13	peak
2		5850.000	54.08	9.25	63.33	122.30	-58.97	peak

Emission Level= Read Level+ Correct Factor

Temperature:	25 °C	Relative Humidity:	55%
Test Voltage:	AC 120V/60Hz		
Ant. Pol.	Vertical		
Test Mode:	TX 802.11a Mode 5825 MHz (U-NII-3) Main Antenna		
Remark:			

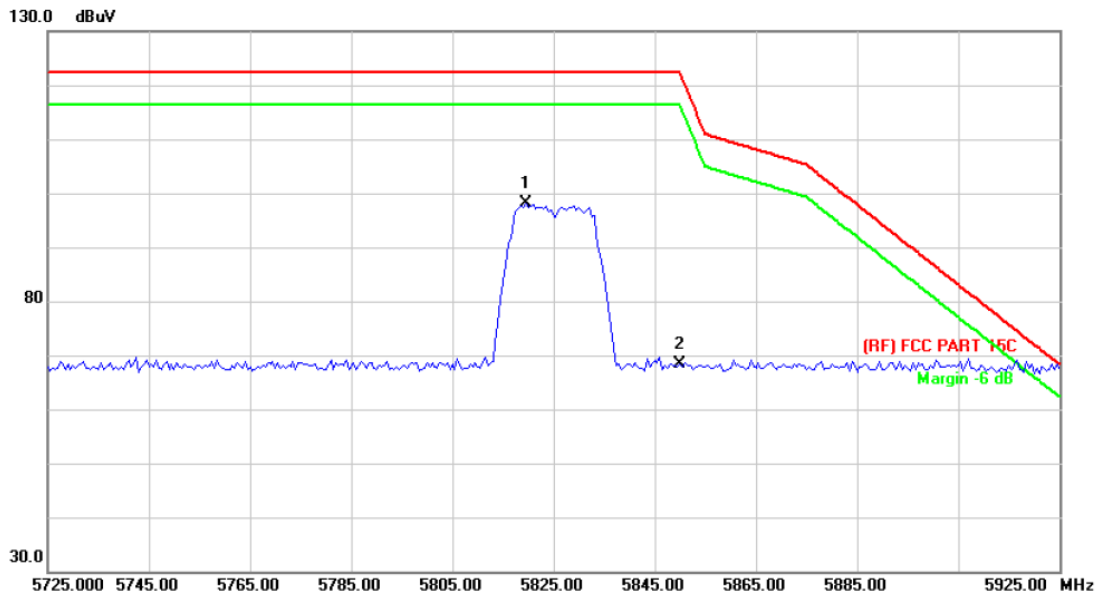

No.	Mk.	Freq.	Reading Level	Correct Factor	Measurement	Limit	Over	Detector
		MHz	dBuV	dB	dBuV	dBuV	dB	
1	*	5819.500	88.91	9.23	98.14	122.30	-24.16	peak
2		5850.000	59.16	9.25	68.41	122.30	-53.89	peak

Emission Level= Read Level+ Correct Factor

Temperature:	25 °C	Relative Humidity:	55%
Test Voltage:	AC 120V/60Hz		
Ant. Pol.	Horizontal		
Test Mode:	TX 802.11n(HT20) Mode 5745 MHz (U-NII-3) Main+AUX Antenna		
Remark:			

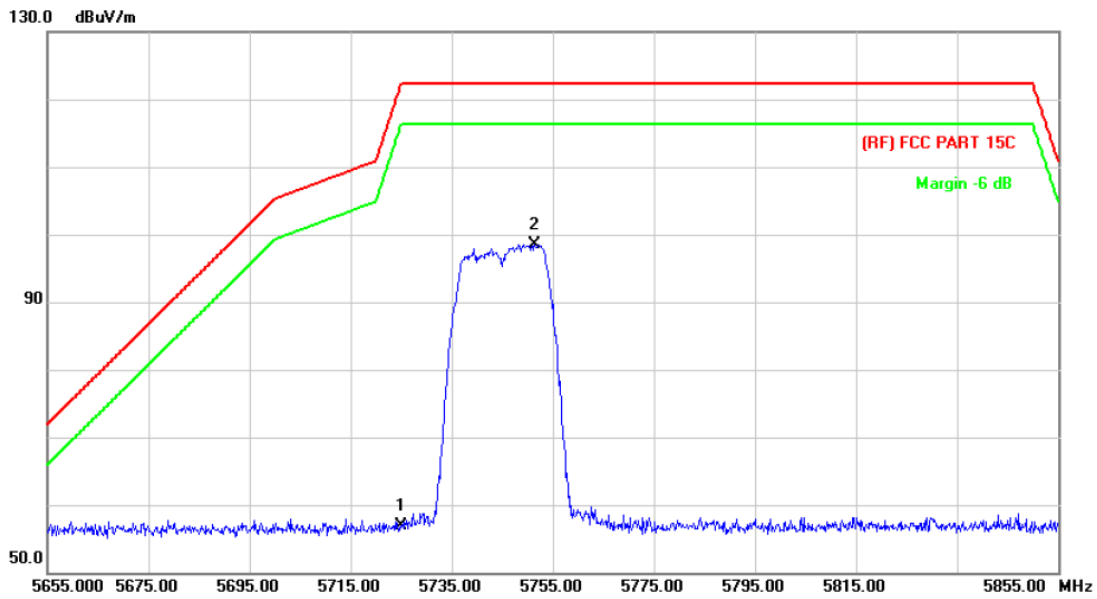

No.	Mk.	Freq. MHz	Reading Level dBuV	Correct Factor dB/m	Measure- ment dBuV/m	Limit dBuV/m	Over dB	Detector
1		5725.000	47.18	9.78	56.96	122.30	-65.34	peak
2	*	5751.400	88.68	9.85	98.53	122.30	-23.77	peak

Emission Level= Read Level+ Correct Factor

Temperature:	25 °C	Relative Humidity:	55%
Test Voltage:	AC 120V/60Hz		
Ant. Pol.	Vertical		
Test Mode:	TX 802.11n(HT20) Mode 5745 MHz (U-NII-3) Main+AUX Antenna		
Remark:			

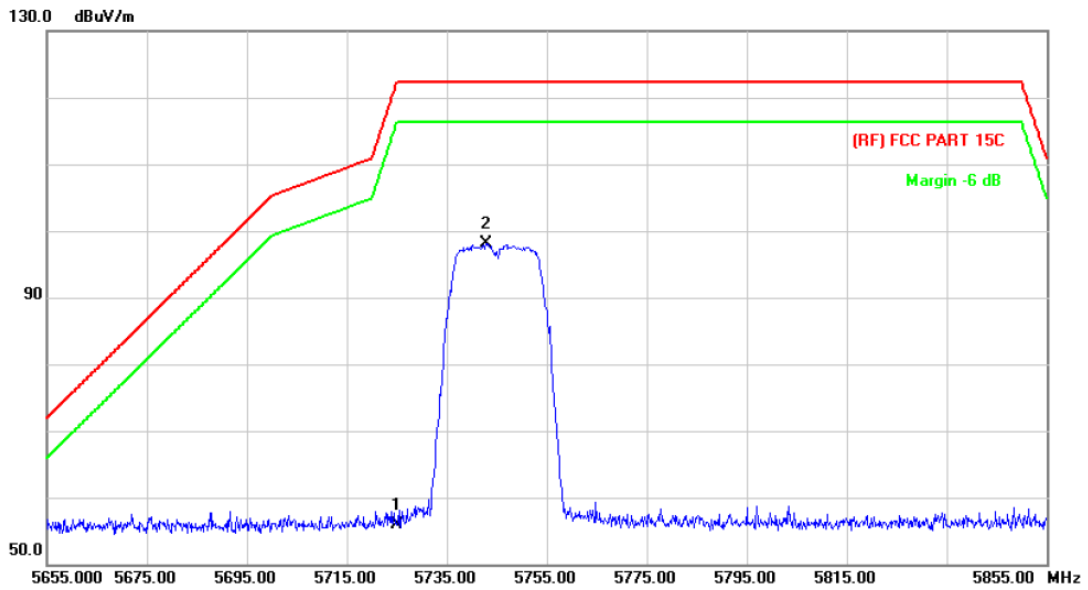

No.	Mk.	Freq.	Reading Level	Correct Factor	Measurement	Limit	Over	
		MHz	dBuV	dB/m	dBuV/m	dBuV/m	dB	Detector
1		5725.000	46.15	9.78	55.93	122.30	-66.37	peak
2	*	5742.800	88.32	9.83	98.15	122.30	-24.15	peak

Emission Level= Read Level+ Correct Factor

Temperature:	25 °C	Relative Humidity:	55%
Test Voltage:	AC 120V/60Hz		
Ant. Pol.	Horizontal		
Test Mode:	TX 802.11n(HT20) Mode 5825 MHz (U-NII-3) Main+AUX Antenna		
Remark:			

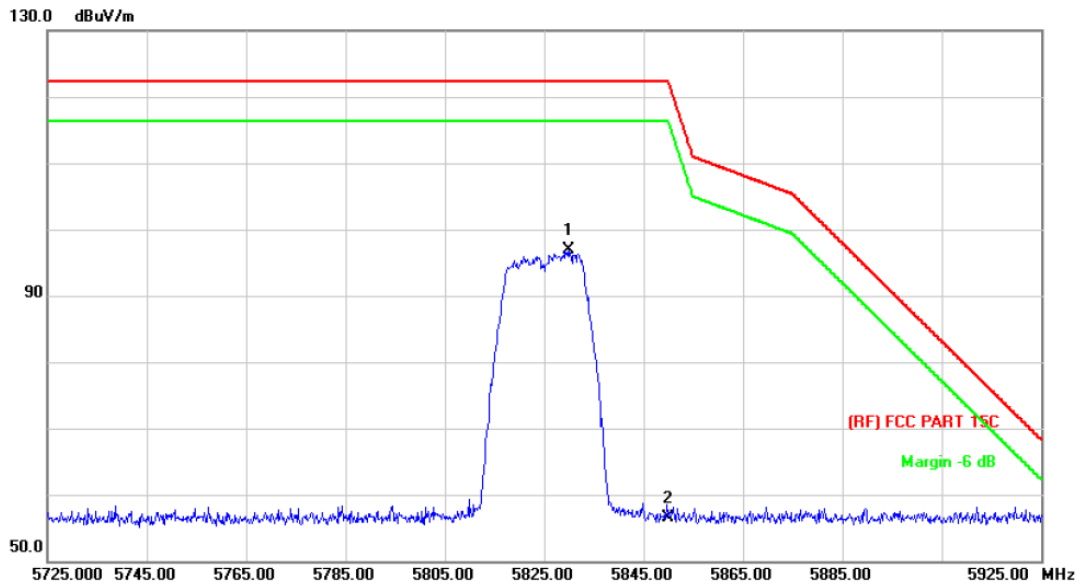

No.	Mk.	Freq.	Reading Level	Correct Factor	Measurement	Limit	Over	Detector
		MHz	dBuV	dB/m	dBuV/m	dBuV/m	dB	
1	*	5829.800	86.88	10.08	96.96	122.30	-25.34	peak
2		5850.000	46.31	10.13	56.44	122.30	-65.86	peak

Emission Level= Read Level+ Correct Factor

Temperature:	25 °C	Relative Humidity:	55%
Test Voltage:	AC 120V/60Hz		
Ant. Pol.	Vertical		
Test Mode:	TX 802.11n(HT20) Mode 5825 MHz (U-NII-3) Main+AUX Antenna		
Remark:			

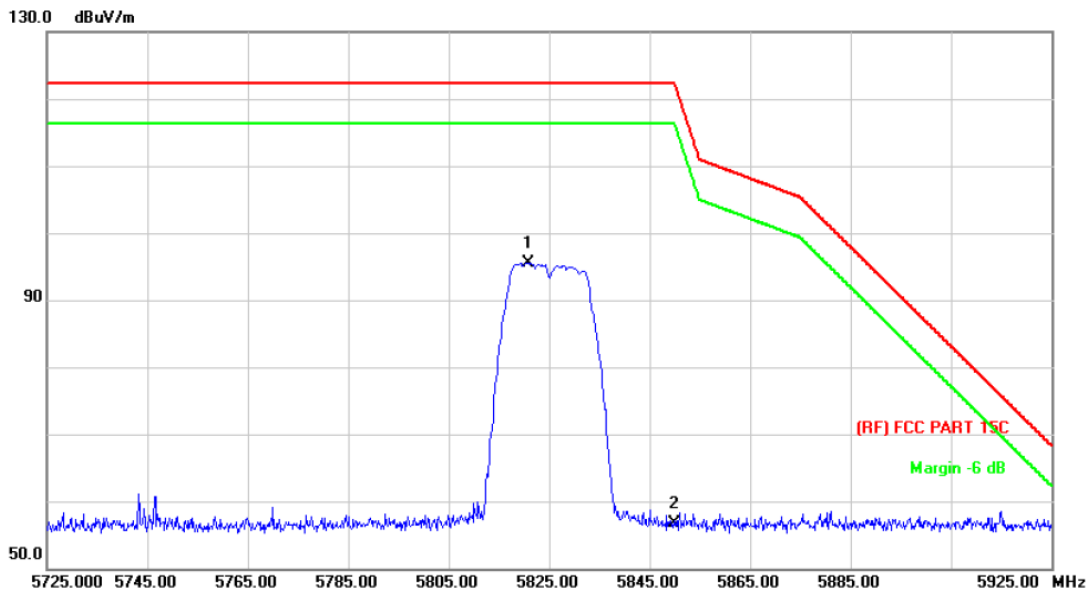

No.	Mk.	Freq.	Reading Level	Correct Factor	Measurement	Limit	Over	Detector
		MHz	dBuV	dB/m	dBuV/m	dBuV/m	dB	
1	*	5820.800	85.48	10.05	95.53	122.30	-26.77	peak
2		5850.000	46.58	10.13	56.71	122.30	-65.59	peak

Emission Level= Read Level+ Correct Factor

Temperature:	25 °C	Relative Humidity:	55%
Test Voltage:	AC 120V/60Hz		
Ant. Pol.	Horizontal		
Test Mode:	TX 802.11ac(HT20) Mode 5745 MHz (U-NII-3) Main+AUX Antenna		
Remark:			

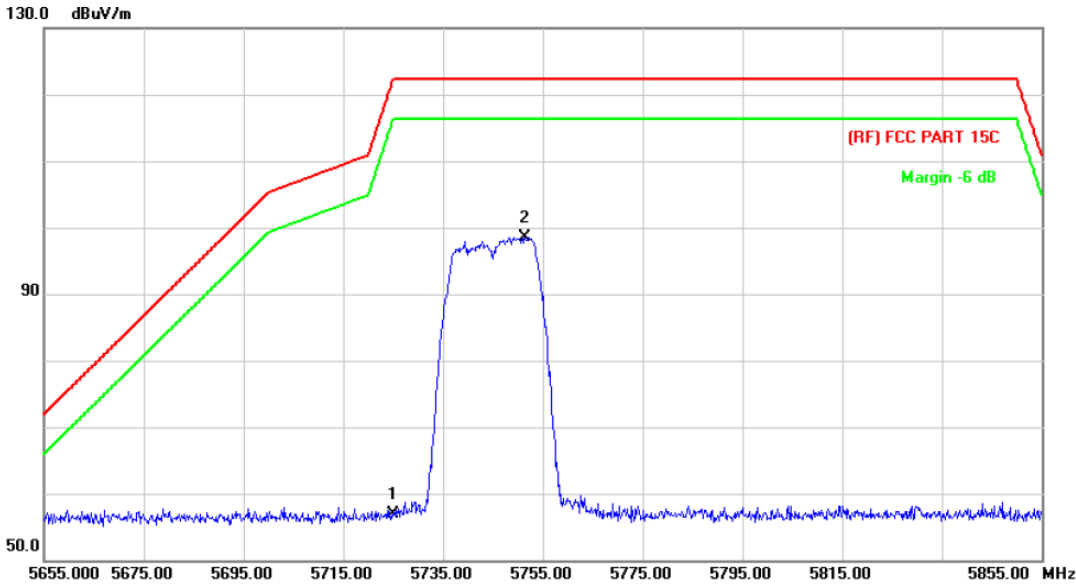

No.	Mk.	Freq. MHz	Reading Level dBuV	Correct Factor dB/m	Measure- ment dBuV/m	Limit dBuV/m	Over dB	Detector
1		5725.000	47.18	9.78	56.96	122.30	-65.34	peak
2	*	5751.400	88.68	9.85	98.53	122.30	-23.77	peak

Emission Level= Read Level+ Correct Factor

Temperature:	25 °C	Relative Humidity:	55%
Test Voltage:	AC 120V/60Hz		
Ant. Pol.	Vertical		
Test Mode:	TX 802.11ac(HT20) Mode 5745 MHz (U-NII-3) Main+AUX Antenna		
Remark:			

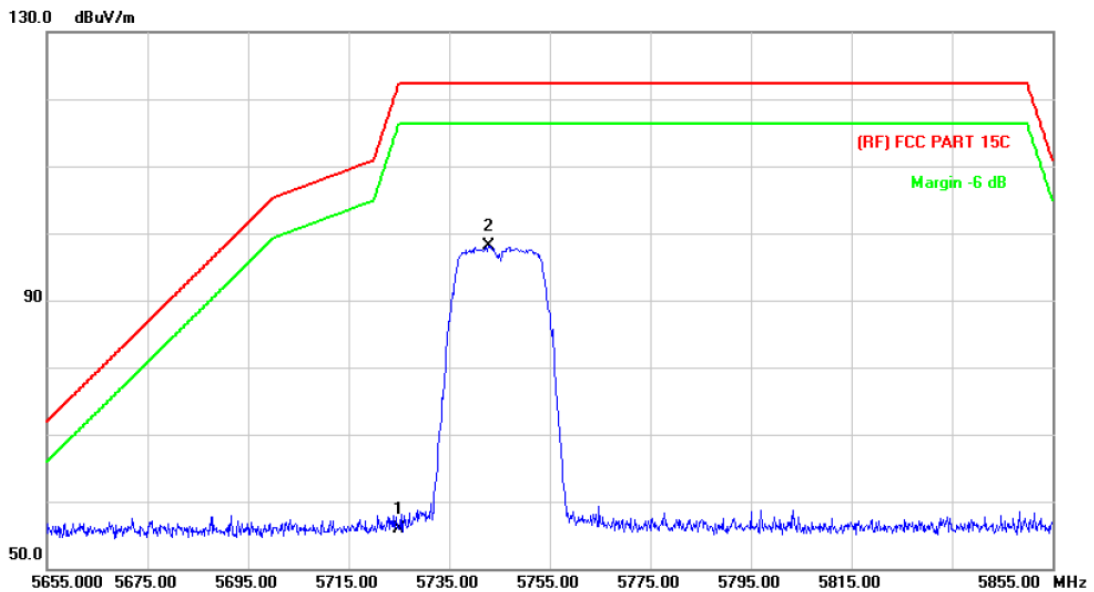

No.	Mk.	Freq.	Reading Level	Correct Factor	Measurement	Limit	Over	Detector
		MHz	dBuV	dB/m	dBuV/m	dBuV/m	dB	
1		5725.000	46.15	9.78	55.93	122.30	-66.37	peak
2	*	5742.800	88.32	9.83	98.15	122.30	-24.15	peak

Emission Level= Read Level+ Correct Factor

Temperature:	25 °C	Relative Humidity:	55%
Test Voltage:	AC 120V/60Hz		
Ant. Pol.	Horizontal		
Test Mode:	TX 802.11ac(HT20) Mode 5825 MHz (U-NII-3) Main+AUX Antenna		
Remark:			

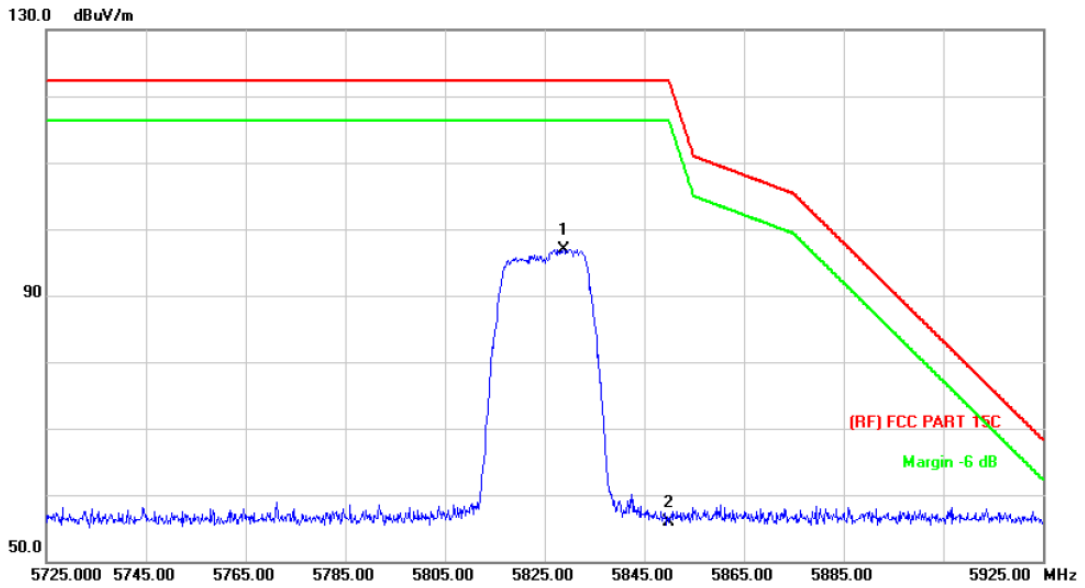

No.	Mk.	Freq. MHz	Reading Level dBuV	Correct Factor dB/m	Measure- ment dBuV/m	Limit dBuV/m	Over dB	Detector
1	*	5828.800	86.92	10.07	96.99	122.30	-25.31	peak
2		5850.000	45.68	10.13	55.81	122.30	-66.49	peak

Emission Level= Read Level+ Correct Factor

Temperature:	25 °C	Relative Humidity:	55%
Test Voltage:	AC 120V/60Hz		
Ant. Pol.	Vertical		
Test Mode:	TX 802.11ac(HT20) Mode 5825 MHz (U-NII-3) Main+AUX Antenna		
Remark:			

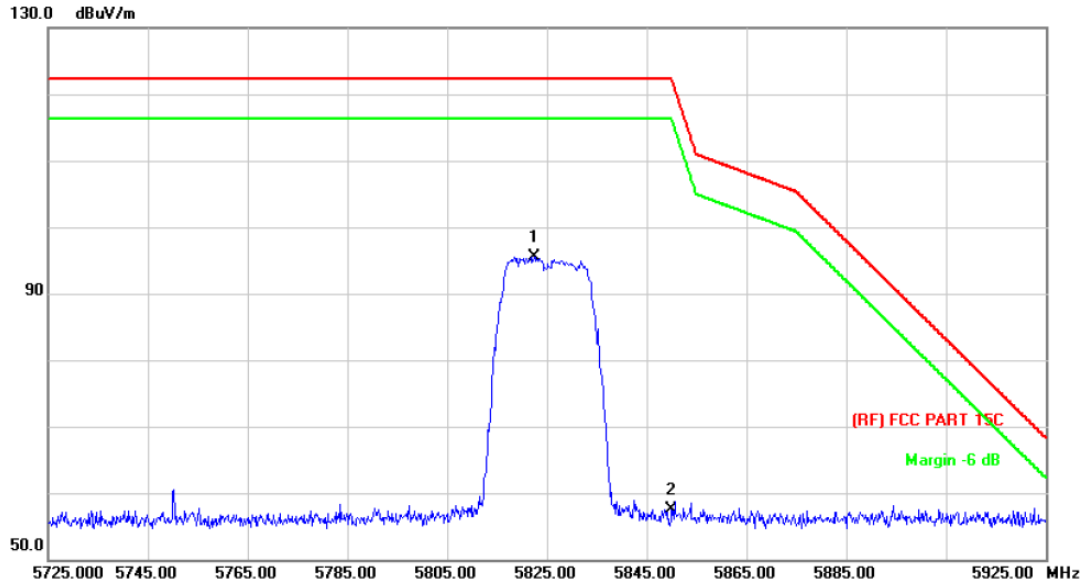

No.	Mk.	Freq. MHz	Reading Level dBuV	Correct Factor dB/m	Measure- ment dBuV/m	Limit dBuV/m	Over dB	Detector
1	*	5822.400	85.45	10.05	95.50	122.30	-26.80	peak
2		5850.000	47.43	10.13	57.56	122.30	-64.74	peak

Emission Level= Read Level+ Correct Factor

Temperature:	25 °C	Relative Humidity:	55%
Test Voltage:	AC 120V/60Hz		
Ant. Pol.	Horizontal		
Test Mode:	TX 802.11n(HT40) Mode 5755 MHz (U-NII-3) Main+AUX Antenna		
Remark:			

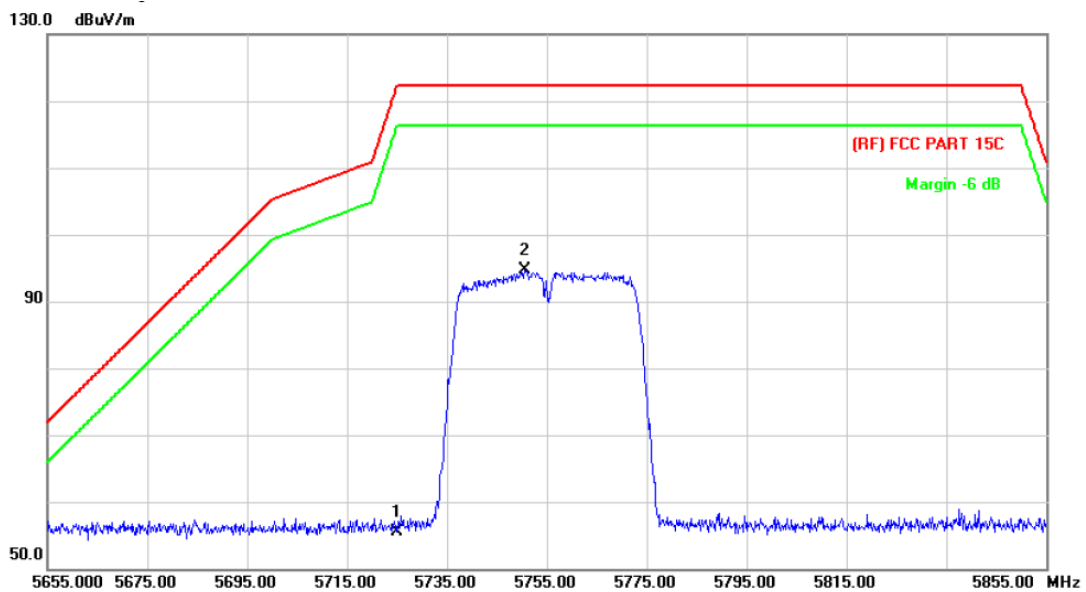

No.	Mk.	Freq. MHz	Reading Level dBuV	Correct Factor dB/m	Measure- ment dBuV/m	Limit dBuV/m	Over dB	Detector
1		5725.000	45.68	9.78	55.46	122.30	-66.84	peak
2	*	5750.600	84.78	9.85	94.63	122.30	-27.67	peak

Emission Level= Read Level+ Correct Factor

Temperature:	25 °C	Relative Humidity:	55%
Test Voltage:	AC 120V/60Hz		
Ant. Pol.	Vertical		
Test Mode:	TX 802.11n(HT40) Mode 5755 MHz (U-NII-3) Main+AUX Antenna		
Remark:			

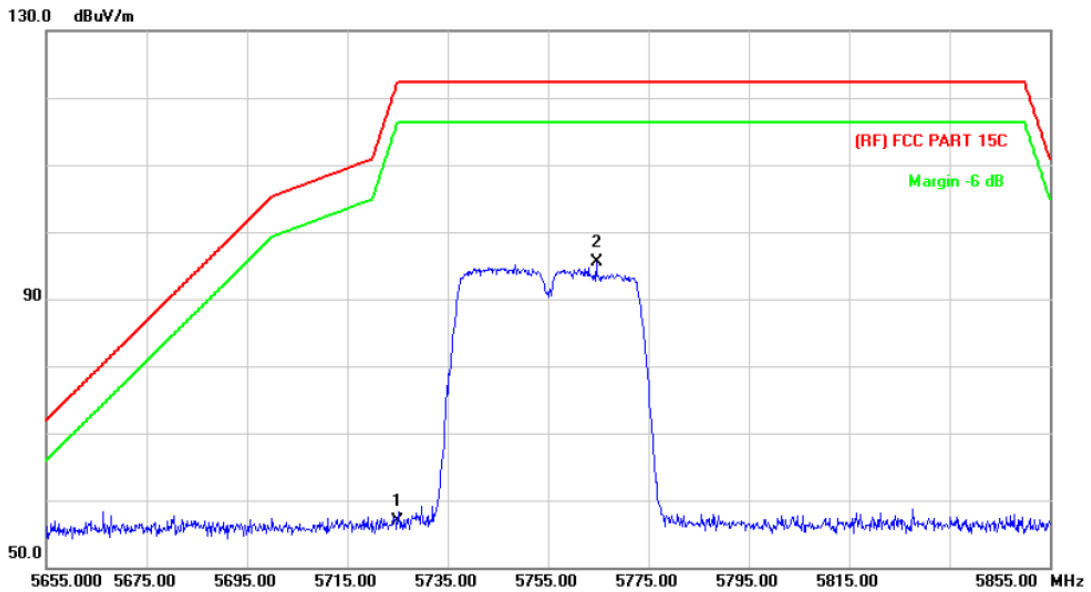

No.	Mk.	Freq. MHz	Reading Level dBuV	Correct Factor dB/m	Measure- ment dBuV/m	Limit dBuV/m	Over dB	Detector
1		5725.000	47.08	9.78	56.86	122.30	-65.44	peak
2	*	5764.600	85.54	9.89	95.43	122.30	-26.87	peak

Emission Level= Read Level+ Correct Factor

Temperature:	25 °C	Relative Humidity:	55%
Test Voltage:	AC 120V/60Hz		
Ant. Pol.	Horizontal		
Test Mode:	TX 802.11n(HT40) Mode 5795 MHz (U-NII-3) Main+AUX Antenna		
Remark:			

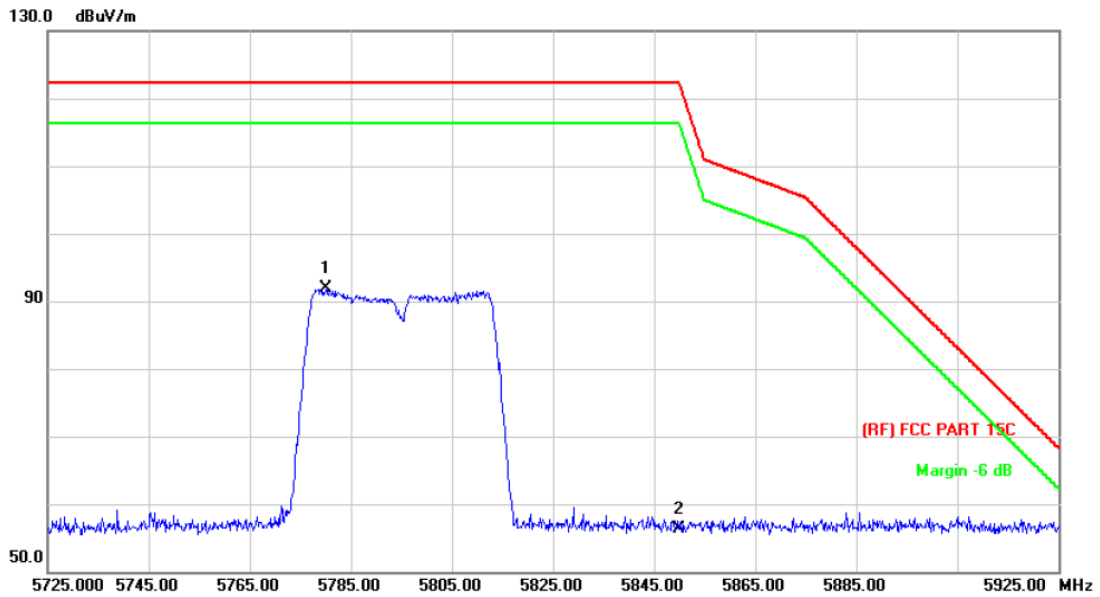

No.	Mk.	Freq. MHz	Reading Level dBuV	Correct Factor dB/m	Measure- ment dBuV/m	Limit dBuV/m	Over dB	Detector
1	*	5780.200	81.89	9.93	91.82	122.30	-30.48	peak
2		5850.000	46.27	10.13	56.40	122.30	-65.90	peak

Emission Level= Read Level+ Correct Factor

Temperature:	25 °C	Relative Humidity:	55%
Test Voltage:	AC 120V/60Hz		
Ant. Pol.	Vertical		
Test Mode:	TX 802.11n(HT40) Mode 5795 MHz (U-NII-3) Main+AUX Antenna		
Remark:			

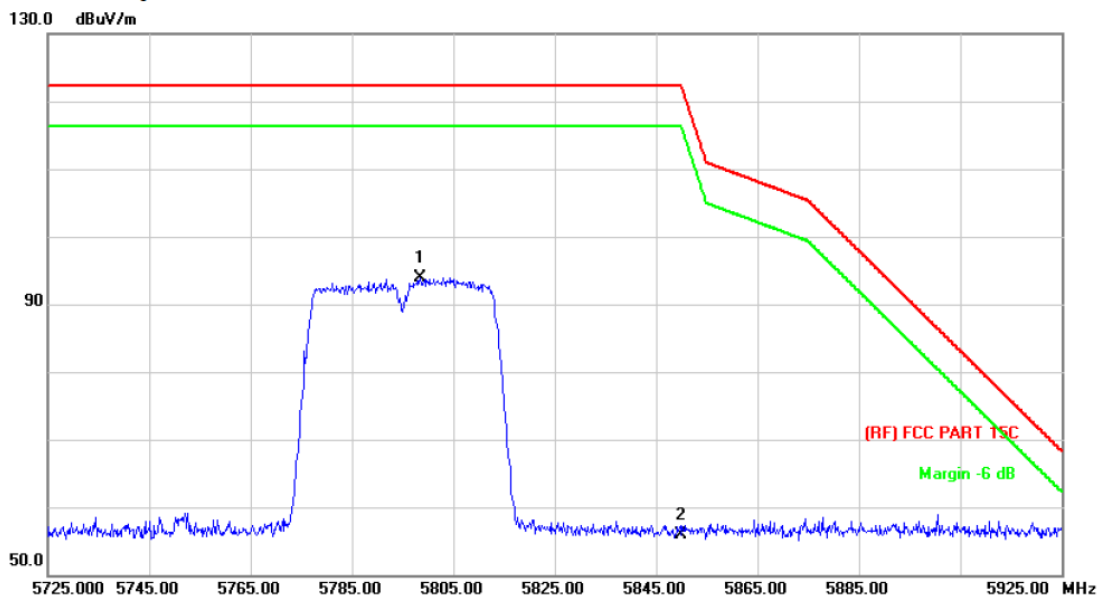

No.	Mk.	Freq. MHz	Reading Level dBuV	Correct Factor dB/m	Measure- ment dBuV/m	Limit dBuV/m	Over dB	Detector
1	*	5798.400	83.95	9.98	93.93	122.30	-28.37	peak
2		5850.000	45.87	10.13	56.00	122.30	-66.30	peak

Emission Level= Read Level+ Correct Factor

Temperature:	25 °C	Relative Humidity:	55%
Test Voltage:	AC 120V/60Hz		
Ant. Pol.	Horizontal		
Test Mode:	TX 802.11ac(VHT40) Mode 5755 MHz (U-NII-3) Main+AUX Antenna		
Remark:			

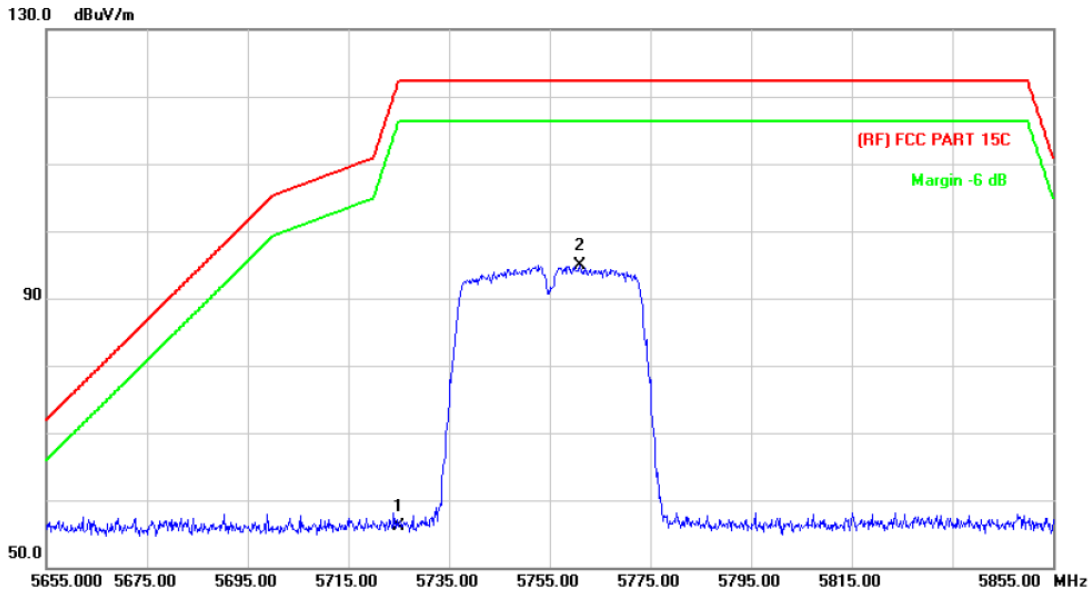

No.	Mk.	Freq.	Reading Level	Correct Factor	Measurement	Limit	Over	Detector
		MHz	dBuV	dB/m	dBuV/m	dBuV/m	dB	
1		5725.000	46.28	9.78	56.06	122.30	-66.24	peak
2	*	5761.000	85.11	9.87	94.98	122.30	-27.32	peak

Emission Level= Read Level+ Correct Factor

Temperature:	25 °C	Relative Humidity:	55%
Test Voltage:	AC 120V/60Hz		
Ant. Pol.	Vertical		
Test Mode:	TX 802.11ac(VHT40) Mode 5755 MHz (U-NII-3) Main+AUX Antenna		
Remark:			

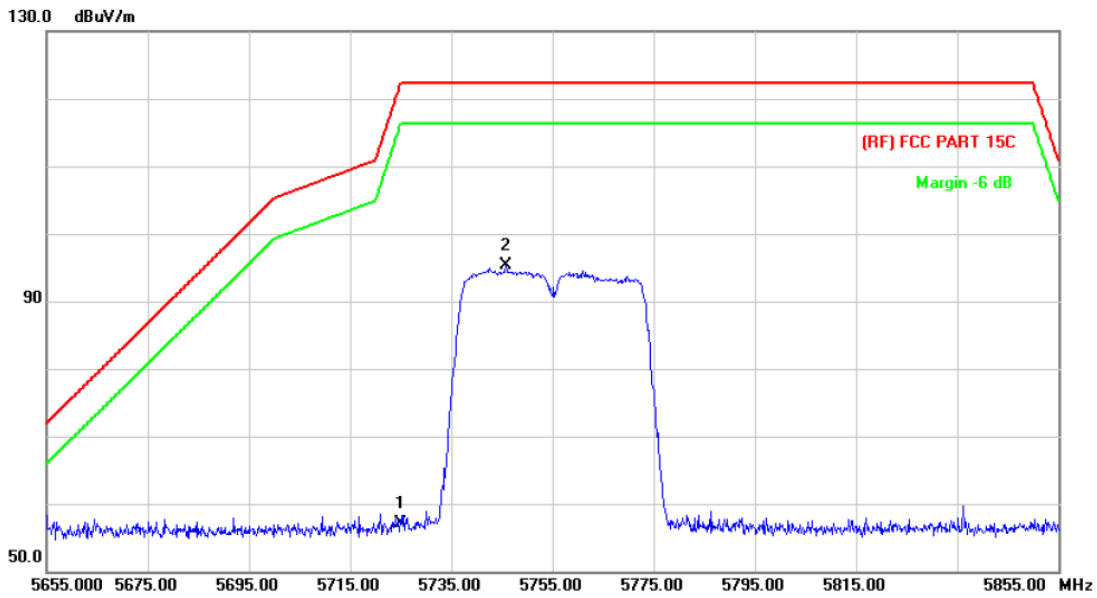

No.	Mk.	Freq. MHz	Reading Level dBuV	Correct Factor dB/m	Measure- ment dBuV/m	Limit dBuV/m	Over dB	Detector
1		5725.000	47.23	9.78	57.01	122.30	-65.29	peak
2	*	5745.800	85.43	9.83	95.26	122.30	-27.04	peak

Emission Level= Read Level+ Correct Factor

Temperature:	25 °C	Relative Humidity:	55%
Test Voltage:	AC 120V/60Hz		
Ant. Pol.	Horizontal		
Test Mode:	TX 802.11ac(VHT40) Mode 5795 MHz (U-NII-3) Main+AUX Antenna		
Remark:			

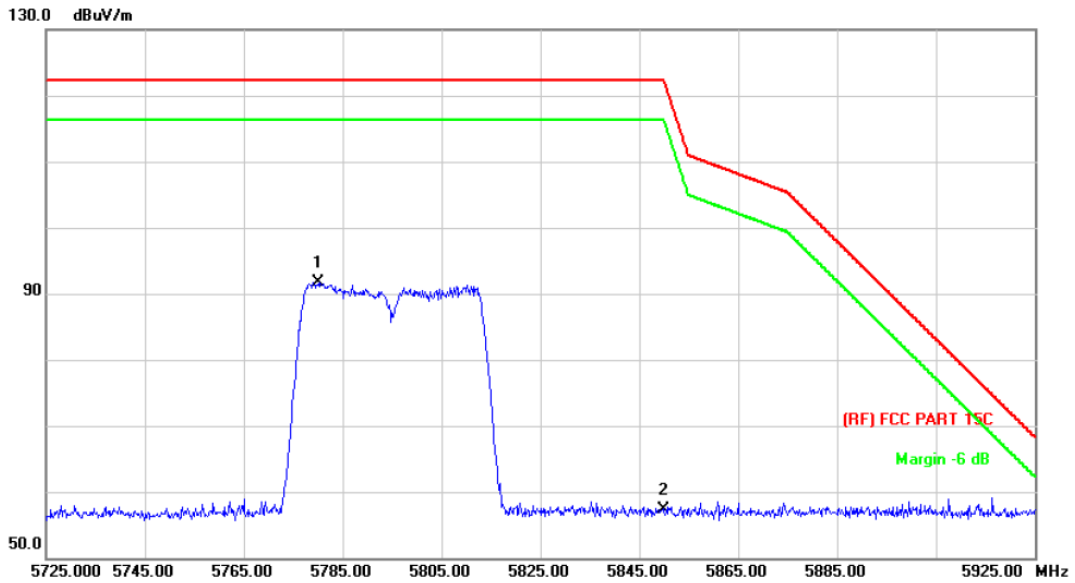

No.	Mk.	Freq. MHz	Reading Level dBuV	Correct Factor dB/m	Measure- ment dBuV/m	Limit dBuV/m	Over dB	Detector
1	*	5780.200	81.79	9.93	91.72	122.30	-30.58	peak
2		5850.000	47.20	10.13	57.33	122.30	-64.97	peak

Emission Level= Read Level+ Correct Factor

Temperature:	25 °C	Relative Humidity:	55%
Test Voltage:	AC 120V/60Hz		
Ant. Pol.	Vertical		
Test Mode:	TX 802.11ac(VHT40) Mode 5795 MHz (U-NII-3) Main+AUX Antenna		
Remark:			

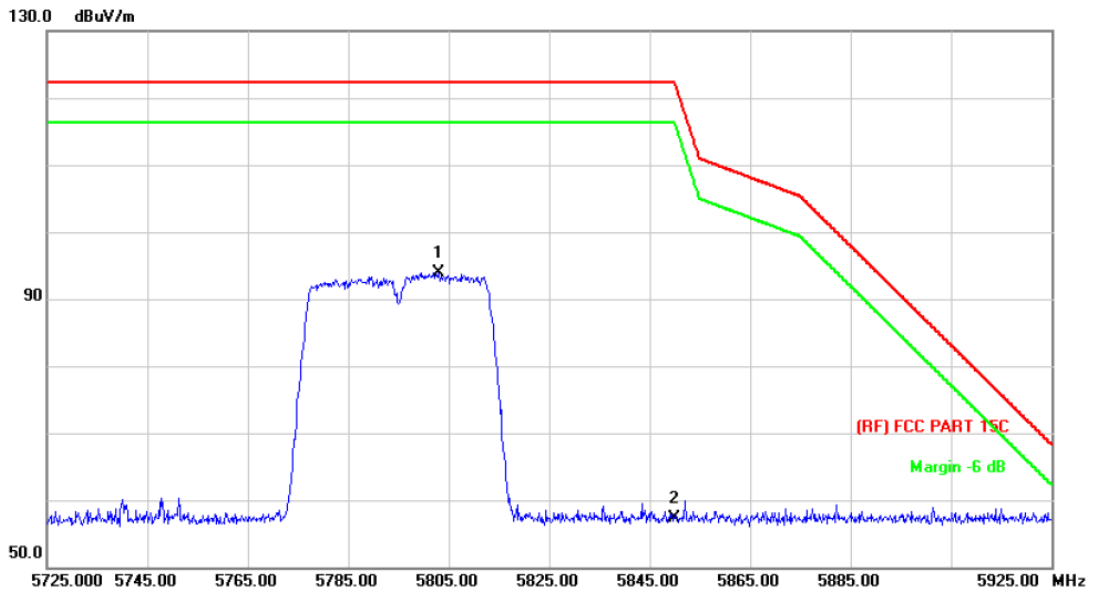

No.	Mk.	Freq.	Reading Level	Correct Factor	Measurement	Limit	Over	Detector
		MHz	dBuV	dB/m	dBuV/m	dBuV/m	dB	
1	*	5803.000	83.85	10.00	93.85	122.30	-28.45	peak
2		5850.000	47.11	10.13	57.24	122.30	-65.06	peak

Emission Level= Read Level+ Correct Factor

Temperature:	25 °C	Relative Humidity:	55%
Test Voltage:	AC 120V/60Hz		
Ant. Pol.	Horizontal		
Test Mode:	TX 802.11ac(VHT80) Mode 5775 MHz (U-NII-3) Main+AUX Antenna		
Remark:			

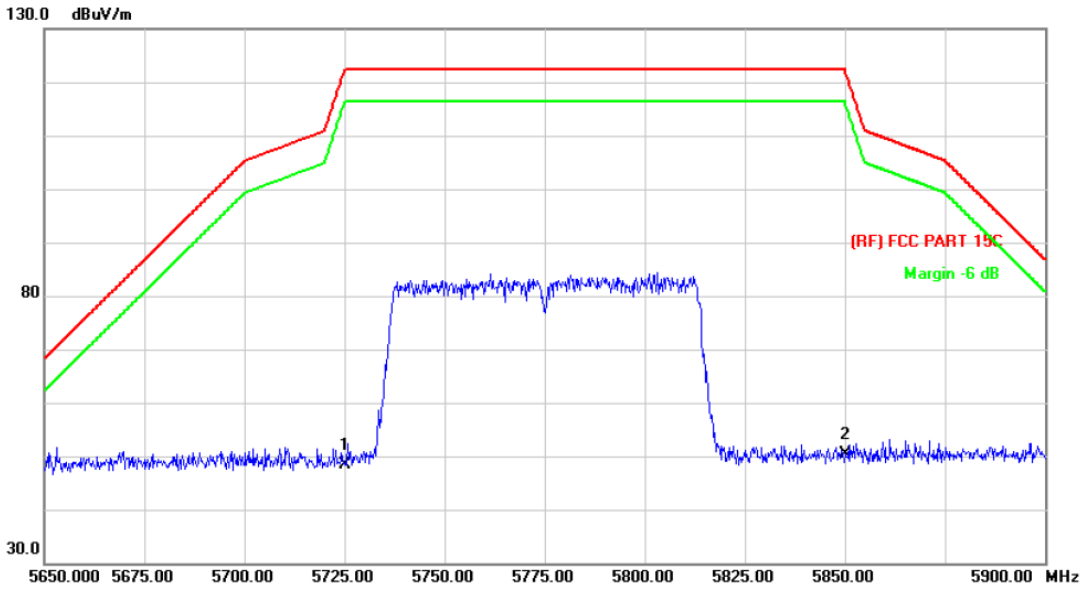

No.	Mk.	Freq. MHz	Reading Level dBuV	Correct Factor dB/m	Measure- ment dBuV/m	Limit dBuV/m	Over dB	Detector
1		5725.000	32.46	15.87	48.33	122.30	-73.97	peak
2	*	5850.000	33.66	16.83	50.49	122.30	-71.81	peak

Emission Level= Read Level+ Correct Factor

Temperature:	25 °C	Relative Humidity:	55%
Test Voltage:	AC 120V/60Hz		
Ant. Pol.	Vertical		
Test Mode:	TX 802.11ac(VHT80) Mode 5775 MHz (U-NII-3) Main+AUX Antenna		
Remark:			

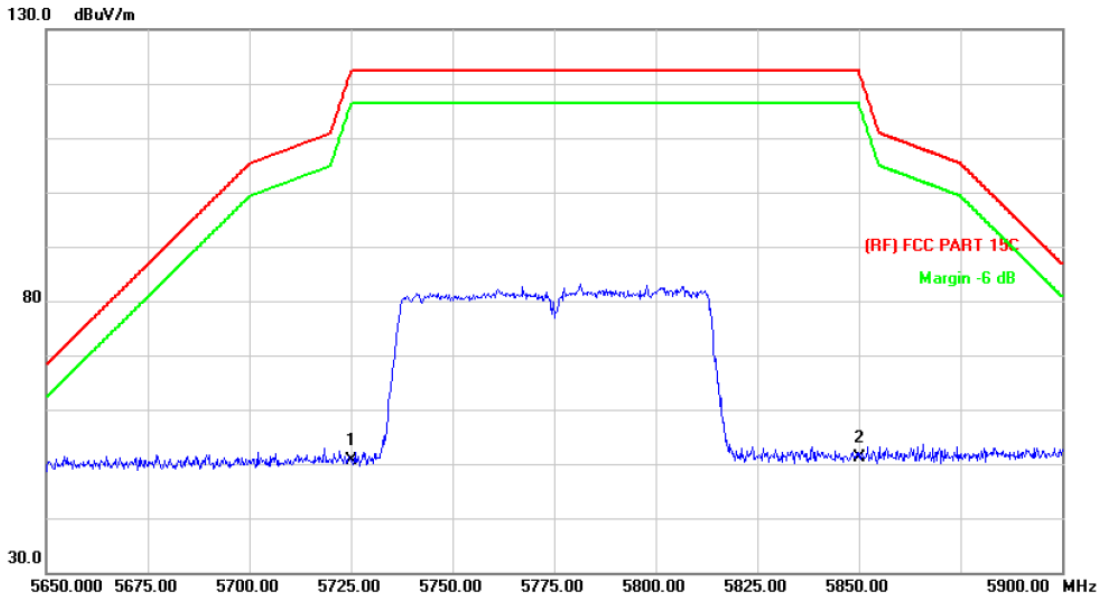

No.	Mk.	Freq. MHz	Reading Level dBuV	Correct Factor dB/m	Measure- ment dBuV/m	Limit dBuV/m	Over dB	Detector
1		5725.000	34.74	15.87	50.61	122.30	-71.69	peak
2	*	5850.000	34.22	16.83	51.05	122.30	-71.25	peak

Emission Level= Read Level+ Correct Factor