

FCC Radio Test Report

FCC ID: 2AM8GCHAMELEON8

Original Grant

Report No. : TB-FCC164421
Applicant : Guangzhou Lie Dun Electronics Technology CO.,Ltd
Equipment Under Test (EUT)
EUT Name : RUGGEDIZED TABLET
Model No. : 8-DUAL
Series Model No. : 8-MICRO, 8-SINGLE, 8-SINGLE+, 8-SLAP
Brand Name : CHAMELEON
Receipt Date : 2019-02-27
Test Date : 2019-03-04 to 2019-06-25
Issue Date : 2019-06-25
Standards : FCC Part 15, Subpart C 15.247
Test Method : ANSI C63.10: 2013
Conclusions : **PASS**

In the configuration tested, the EUT complied with the standards specified above,
The EUT technically complies with the FCC and IC requirements

Test/Witness Engineer : Jason Xu
Test/Witness Engineer : IVAN SU
Approved & Authorized : Ray Lai



This report details the results of the testing carried out on one sample. The results contained in this test report do not relate to other samples of the same product. The manufacturer should ensure that all products in series production are in conformity with the product sample detailed in the report.

Contents

CONTENTS.....2

1. GENERAL INFORMATION ABOUT EUT5

1.1 Client Information.....5

1.2 General Description of EUT (Equipment Under Test)5

1.3 Block Diagram Showing the Configuration of System Tested.....7

1.4 Description of Support Units7

1.5 Description of Test Mode.....8

1.6 Description of Test Software Setting9

1.7 Measurement Uncertainty9

1.8 Test Facility.....10

2. TEST SUMMARY11

3. TEST EQUIPMENT.....12

4. CONDUCTED EMISSION TEST13

4.1 Test Standard and Limit.....13

4.2 Test Setup.....13

4.3 Test Procedure.....13

4.4 EUT Operating Mode14

4.5 Test Data.....14

5. RADIATED EMISSION TEST15

5.1 Test Standard and Limit.....15

5.2 Test Setup.....16

5.3 Test Procedure.....17

5.4 EUT Operating Condition18

5.5 Test Data.....18

6. RESTRICTED BANDS REQUIREMENT19

6.1 Test Standard and Limit.....19

6.2 Test Setup.....19

6.3 Test Procedure.....19

6.4 EUT Operating Condition20

6.5 Test Data.....20

7. BANDWIDTH TEST21

7.1 Test Standard and Limit.....21

7.2 Test Setup.....21

7.3 Test Procedure.....21

7.4 EUT Operating Condition21

7.5 Test Data.....21

8. PEAK OUTPUT POWER TEST.....22

8.1 Test Standard and Limit.....22

- 8.2 Test Setup..... 22
- 8.3 Test Procedure..... 22
- 8.4 EUT Operating Condition 22
- 8.5 Test Data..... 22
- 9. POWER SPECTRAL DENSITY TEST 23**
 - 9.1 Test Standard and Limit..... 23
 - 9.2 Test Setup..... 23
 - 9.3 Test Procedure..... 23
 - 9.4 EUT Operating Condition 23
 - 9.5 Test Data..... 23
- 10. ANTENNA REQUIREMENT..... 24**
 - 10.1 Standard Requirement..... 24
 - 10.2 Antenna Connected Construction..... 24
- ATTACHMENT A-- CONDUCTED EMISSION TEST DATA 25**
- ATTACHMENT C-- RESTRICTED BANDS REQUIREMENT AND BAND-EDGE TEST DATA 53**
- ATTACHMENT D-- BANDWIDTH TEST DATA..... 77**
- ATTACHMENT E-- PEAK OUTPUT POWER TEST DATA..... 93**
- ATTACHMENT F-- POWER SPECTRAL DENSITY TEST DATA..... 97**

Revision History

| Report No. | Version | Description | Issued Date |
|--------------|---------|-------------------------|-------------|
| TB-FCC164421 | Rev.01 | Initial issue of report | 2019-06-25 |
| | | | |
| | | | |
| | | | |
| | | | |
| | | | |
| | | | |
| | | | |
| | | | |
| | | | |
| | | | |
| | | | |
| | | | |
| | | | |
| | | | |

1. General Information about EUT

1.1 Client Information

| | | |
|---------------------|---|---|
| Applicant | : | Guangzhou Lie Dun Electronics Technology CO.,Ltd |
| Address | : | No.4 plant of No.43 South International Trade Avenue, Hualong Town, Panyu District, Guangzhou, Guangdong, China |
| Manufacturer | : | Guangzhou Lie Dun Electronics Technology CO.,Ltd |
| Address | : | No.4 plant of No.43 South International Trade Avenue, Hualong Town, Panyu District, Guangzhou, Guangdong, China |

1.2 General Description of EUT (Equipment Under Test)

| | | | | | | | | | | | | | | |
|-------------------------------|---|--|--|--|--------------------|--|------------------|--|---------------|-------------------|------------------|---|--------------------------|--|
| EUT Name | : | RUGGEDIZED TABLET | | | | | | | | | | | | |
| Models No. | : | 8-DUAL, 8-MICRO, 8-SINGLE, 8-SINGLE+, 8-SLAP | | | | | | | | | | | | |
| Model Different | : | All these models are identical in the same PCB, layout and electrical circuit, the only difference is model name for commercial. | | | | | | | | | | | | |
| Product Description | : | <table border="1"> <tr> <td>Operation Frequency:</td> <td>802.11b/g/n(HT20): 2412MHz~2462MHz 802.11n(HT40): 2422MHz~2452MHz</td> </tr> <tr> <td>Number of Channel:</td> <td>802.11b/g/n(HT20):11 channels <i>see note(3)</i> 802.11n(HT40): 7 channels <i>see note(3)</i></td> </tr> <tr> <td>RF Output Power:</td> <td>802.11b: 8.18 dBm 802.11g: 7.96 dBm 802.11n (HT20): 7.43 dBm 802.11n (HT40): 7.42 dBm</td> </tr> <tr> <td>Antenna Gain:</td> <td>2 dBi FPC Antenna</td> </tr> <tr> <td>Modulation Type:</td> <td>802.11b: DSSS(CCK, DQPSK, DBPSK) 802.11g/n:OFDM(BPSK,QPSK,16QAM,64QAM)</td> </tr> <tr> <td>Bit Rate of Transmitter:</td> <td>802.11b:11/5.5/2/1 Mbps 802.11g:54/48/36/24/18/12/9/6 Mbps 802.11n:up to 150Mbps</td> </tr> </table> | Operation Frequency: | 802.11b/g/n(HT20): 2412MHz~2462MHz 802.11n(HT40): 2422MHz~2452MHz | Number of Channel: | 802.11b/g/n(HT20):11 channels <i>see note(3)</i> 802.11n(HT40): 7 channels <i>see note(3)</i> | RF Output Power: | 802.11b: 8.18 dBm 802.11g: 7.96 dBm 802.11n (HT20): 7.43 dBm 802.11n (HT40): 7.42 dBm | Antenna Gain: | 2 dBi FPC Antenna | Modulation Type: | 802.11b: DSSS(CCK, DQPSK, DBPSK) 802.11g/n:OFDM(BPSK,QPSK,16QAM,64QAM) | Bit Rate of Transmitter: | 802.11b:11/5.5/2/1 Mbps 802.11g:54/48/36/24/18/12/9/6 Mbps 802.11n:up to 150Mbps |
| | | Operation Frequency: | 802.11b/g/n(HT20): 2412MHz~2462MHz 802.11n(HT40): 2422MHz~2452MHz | | | | | | | | | | | |
| | | Number of Channel: | 802.11b/g/n(HT20):11 channels <i>see note(3)</i> 802.11n(HT40): 7 channels <i>see note(3)</i> | | | | | | | | | | | |
| | | RF Output Power: | 802.11b: 8.18 dBm 802.11g: 7.96 dBm 802.11n (HT20): 7.43 dBm 802.11n (HT40): 7.42 dBm | | | | | | | | | | | |
| | | Antenna Gain: | 2 dBi FPC Antenna | | | | | | | | | | | |
| | | Modulation Type: | 802.11b: DSSS(CCK, DQPSK, DBPSK) 802.11g/n:OFDM(BPSK,QPSK,16QAM,64QAM) | | | | | | | | | | | |
| | | Bit Rate of Transmitter: | 802.11b:11/5.5/2/1 Mbps 802.11g:54/48/36/24/18/12/9/6 Mbps 802.11n:up to 150Mbps | | | | | | | | | | | |
| Power Rating | : | Adapter(B036-125): Input: AC 100-240V, 50/60Hz, 1.2A max Output: DC 12V, 3A DC 7.6V by 7600mAh rechargeable Li-ion battery. | | | | | | | | | | | | |
| Software Version | : | Windows Pro | | | | | | | | | | | | |
| Hardware Version | : | V12 | | | | | | | | | | | | |
| Connecting I/O Port(S) | : | Please refer to the User's Manual | | | | | | | | | | | | |

Note:

- (1) This Test Report is FCC Part 15.247 for 802.11b/g/n, the test procedure follows the FCC KDB 558074 D01 v05r02 and KDB 662911 D01 Multiple Transmitter Output v02r01.
- (2) For a more detailed features description, please refer to the manufacturer's specifications or the User's Manual.
- (3) Channel List:

| Channel | Frequency (MHz) | Channel | Frequency (MHz) | Channel | Frequency (MHz) |
|---------|-----------------|---------|-----------------|---------|-----------------|
| 01 | 2412 | 05 | 2432 | 09 | 2452 |
| 02 | 2417 | 06 | 2437 | 10 | 2457 |
| 03 | 2422 | 07 | 2442 | 11 | 2462 |
| 04 | 2427 | 08 | 2447 | | |

Note: CH 01~CH 11 for 802.11b/g/n(HT20)

(4) Antenna information

| Mode | TX Antenna (s) | | Remark | |
|---------------|----------------|------------|----------------------------------|-------------------|
| 802.11b | 1 | | The worst case is Main ANT. TX | |
| 802.11g | 1 | | The worst case is Main ANT. 1 TX | |
| 802.11n(HT20) | 2 | | Main ANT.+AUX ANT. | |
| 802.11n(HT40) | 2 | | Main ANT.+AUX ANT. | |
| Antenna | Brand | Model Name | Type | Antenna Gain(dBi) |
| Main ANT. | N/A | N/A | FPC | 2 |
| Main ANT. | N/A | N/A | FPC | 2 |

Note:For MIMO mode: Directional gain=Gain(Ant1)+Gain(Ant1)=5.01 dBi in 2.4G 802.11 n(HT20/HT40) has MIMO mode.

1.3 Block Diagram Showing the Configuration of System Tested

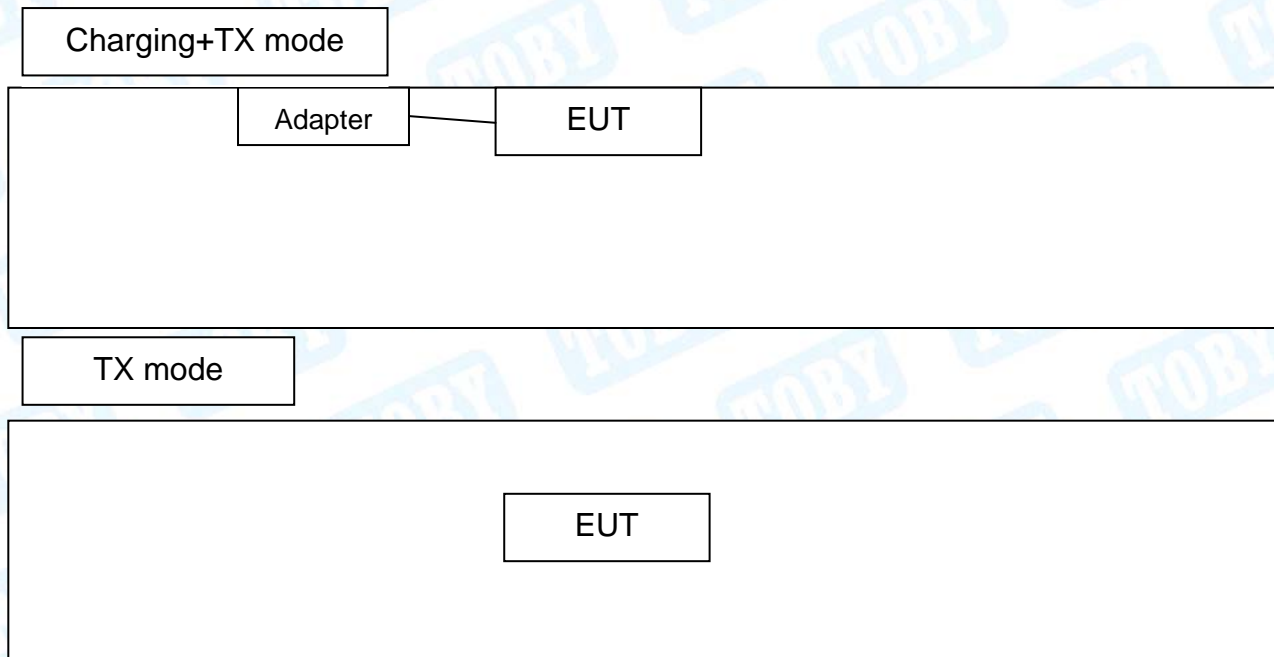

1.4 Description of Support Units

The EUT has been tested as an independent unit.

1.5 Description of Test Mode

To investigate the maximum EMI emission characteristics generates from EUT, the test system was pre-scanning tested base on the consideration of following EUT operation mode or test configuration mode which possible have effect on EMI emission level. Each of these EUT operation mode(s) or test configuration mode(s) mentioned follow was evaluated respectively.

| For Conducted Test | |
|--------------------|-------------------------|
| Final Test Mode | Description |
| Mode 1 | Charging with TX B Mode |

| For Radiated Test | |
|-------------------|---------------------------------------|
| Final Test Mode | Description |
| Mode 2 | TX Mode B Mode Channel 01/06/11 |
| Mode 3 | TX Mode G Mode Channel 01/06/11 |
| Mode 4 | TX Mode N(HT20) Mode Channel 01/06/11 |
| Mode 5 | TX Mode N(HT40) Mode Channel 03/06/09 |

Note:

- (1) For all test, we have verified the construction and function in typical operation. And all the test modes were carried out with the EUT in transmitting operation in maximum power with all kinds of data rate.
According to ANSI C63.10 standards, the measurements are performed at the highest, Middle, lowest available channels, and the worst case data rate as follows:
 - 802.11b Mode: CCK (1 Mbps)
 - 802.11g Mode: OFDM (6 Mbps)
 - 802.11n (HT20) Mode: MCS 0 (6.5 Mbps)
 - 802.11n (HT40) Mode: MCS 0 (30 Mbps)
- (2) During the testing procedure, the continuously transmitting with the maximum power mode was programmed by the customer.
- (3) The EUT is considered a portable unit; in normal use it was positioned on X-plane. The worst case was found positioned on X-plane. Therefore only the test data of this X-plane was used for radiated emission measurement test.

1.6 Description of Test Software Setting

During testing channel & Power controlling software provided by the customer was used to control the operating channel as well as the output power level. The RF output power selection is for the setting of RF output power expected by the customer and is going to be fixed on the firmware of the final end product power parameters of WLAN.

| Test Software:DRTU | | | | |
|--------------------------------------|-------------|---------|------------|-------|
| Test Mode: Continuously transmitting | | | | |
| Mode | Data Rate | Channel | Parameters | |
| | | | ANT 1 | ANT 2 |
| 802.11b | CCK/ 1Mbps | 01 | DEF | DEF |
| | CCK/ 1Mbps | 06 | DEF | DEF |
| | CCK/ 1Mbps | 11 | DEF | DEF |
| 802.11g | OFDM/ 6Mbps | 01 | DEF | DEF |
| | OFDM/ 6Mbps | 06 | DEF | DEF |
| | OFDM/ 6Mbps | 11 | DEF | DEF |
| 802.11n(20) | MCS 0 | 01 | DEF | DEF |
| | MCS 0 | 06 | DEF | DEF |
| | MCS 0 | 11 | DEF | DEF |
| 802.11n(40) | MCS 0 | 03 | DEF | DEF |
| | MCS 0 | 06 | DEF | DEF |
| | MCS 0 | 09 | DEF | DEF |

Note: TX signal at 802.11b/g mode only could transmit at Ant.1 or Ant. 2. All the test mode have pretest with two Antenna, but the worst case is ANT 1.The report only show the worst case.

1.7 Measurement Uncertainty

The reported uncertainty of measurement $y \pm U$, where expended uncertainty U is based on a standard uncertainty multiplied by a coverage factor of $k=2$, providing a level of confidence of approximately 95 %.

| Test Item | Parameters | Expanded Uncertainty (U_{Lab}) |
|--------------------|--------------------------------------|------------------------------------|
| Conducted Emission | Level Accuracy: 9kHz~150kHz | ± 3.42 dB |
| | 150kHz to 30MHz | ± 3.42 dB |
| Radiated Emission | Level Accuracy: 9kHz to 30 MHz | ± 4.60 dB |
| Radiated Emission | Level Accuracy: 30MHz to 1000 MHz | ± 4.40 dB |
| Radiated Emission | Level Accuracy: Above 1000MHz | ± 4.20 dB |

1.8 Test Facility

The testing was performed by the Shenzhen Toby Technology Co., Ltd., in their facilities located at:1A/F., Bldg.6, Yusheng Industrial Zone, The National Road No.107 Xixiang Section 467, Xixiang, Bao'an, Shenzhen, Guangdong, China.

At the time of testing, the following bodies accredited the Laboratory:

CNAS (L5813)

The Laboratory has been accredited by CNAS to ISO/IEC 17025: 2005 General Requirements for the Competence of Testing and Calibration Laboratories for the competence in the field of testing. And the Registration No.: CNAS L5813.

A2LA Certificate No.: 4750.01

The laboratory has been accredited by American Association for Laboratory Accreditation(A2LA) to ISO/IEC 17025: 2005 General Requirements for the Competence of Testing and Calibration Laboratories for the technical competence in the field of Electrical Testing. And the A2LA Certificate No.: 4750.01.FCC Accredited Test Site Number: 854351.

IC Registration No.: (11950A-1)

The Laboratory has been registered by Certification and Engineering Bureau of Industry Canada for radio equipment testing. The site registration: Site# 11950A-1.

2. Test Summary

| FCC Part 15 Subpart C(15.247)/ RSS 247 Issue 2 | | | | |
|--|--------------------|--|----------|--------|
| Standard Section | | Test Item | Judgment | Remark |
| FCC | IC | | | |
| 15.203 | / | Antenna Requirement | PASS | N/A |
| 15.207 | RSS-GEN 7.2.4 | Conducted Emission | PASS | N/A |
| 15.205 | RSS-GEN 7.2.2 | Restricted Bands | PASS | N/A |
| 15.247(a)(2) | RSS 247 5.2 (1) | 6dB Bandwidth | PASS | N/A |
| 15.247(b) | RSS 247 5.4 (4) | Peak Output Power | PASS | N/A |
| 15.247(e) | RSS 247 5.2 (2) | Power Spectral Density | PASS | N/A |
| 15.247(d) | RSS 247 5.5 | Band Edge | PASS | N/A |
| 15.247(d)& 15.209 | RSS 247 5.5 | Transmitter Radiated Spurious Emission | PASS | N/A |

Note: "/" for no requirement for this test item.
N/A is an abbreviation for Not Applicable.

3. Test Equipment

| Conducted Emission Test | | | | | |
|----------------------------|----------------------------------|-------------------|---------------|---------------|---------------|
| Equipment | Manufacturer | Model No. | Serial No. | Last Cal. | Cal. Due Date |
| EMI Test Receiver | Rohde & Schwarz | ESCI | 100321 | Jul.18, 2018 | Jul. 17, 2019 |
| RF Switching Unit | Compliance Direction Systems Inc | RSU-A4 | 34403 | Jul.18, 2018 | Jul. 17, 2019 |
| AMN | SCHWARZBECK | NNBL 8226-2 | 8226-2/164 | Jul.18, 2018 | Jul. 17, 2019 |
| LISN | Rohde & Schwarz | ENV216 | 101131 | Jul.18, 2018 | Jul. 17, 2019 |
| Radiation Emission Test | | | | | |
| Equipment | Manufacturer | Model No. | Serial No. | Last Cal. | Cal. Due Date |
| Spectrum Analyzer | Agilent | E4407B | MY45106456 | Jul.18, 2018 | Jul. 17, 2019 |
| EMI Test Receiver | Rohde & Schwarz | ESPI | 100010/007 | Jul.18, 2018 | Jul. 17, 2019 |
| Bilog Antenna | ETS-LINDGREN | 3142E | 00117537 | Jan. 27, 2019 | Jan. 26, 2020 |
| Bilog Antenna | ETS-LINDGREN | 3142E | 00117542 | Jan. 27, 2019 | Jan. 26, 2020 |
| Horn Antenna | ETS-LINDGREN | 3117 | 00143207 | Mar.03, 2019 | Mar. 02, 2020 |
| Horn Antenna | ETS-LINDGREN | 3117 | 00143209 | Mar.03, 2019 | Mar. 02, 2020 |
| Loop Antenna | SCHWARZBECK | FMZB 1519 B | 1519B-059 | Jul. 14, 2018 | Jul.13, 2019 |
| Pre-amplifier | Sonoma | 310N | 185903 | Mar.04, 2019 | Mar. 03, 2020 |
| Pre-amplifier | HP | 8449B | 3008A00849 | Mar.03, 2019 | Mar. 02, 2020 |
| Cable | HUBER+SUHNER | 100 | SUCOFLEX | Mar.03, 2019 | Mar. 02, 2020 |
| Positioning Controller | ETS-LINDGREN | 2090 | N/A | N/A | N/A |
| Antenna Conducted Emission | | | | | |
| Equipment | Manufacturer | Model No. | Serial No. | Last Cal. | Cal. Due Date |
| Spectrum Analyzer | Agilent | E4407B | MY45106456 | Jul.18, 2018 | Jul. 17, 2019 |
| Spectrum Analyzer | Rohde & Schwarz | ESCI | 100010/007 | Jul.18, 2018 | Jul. 17, 2019 |
| MXA Signal Analyzer | Agilent | N9020A | MY49100060 | Sep. 15, 2018 | Sep. 14, 2019 |
| Vector Signal Generator | Agilent | N5182A | MY50141294 | Sep. 15, 2018 | Sep. 14, 2019 |
| Analog Signal Generator | Agilent | N5181A | MY50141953 | Sep. 15, 2018 | Sep. 14, 2019 |
| RF Power Sensor | DARE!! Instruments | RadiPowerRPR3006W | 17I00015SNO26 | Sep. 15, 2018 | Sep. 14, 2019 |
| | DARE!! Instruments | RadiPowerRPR3006W | 17I00015SNO29 | Sep. 15, 2018 | Sep. 14, 2019 |
| | DARE!! Instruments | RadiPowerRPR3006W | 17I00015SNO31 | Sep. 15, 2018 | Sep. 14, 2019 |
| | DARE!! Instruments | RadiPowerRPR3006W | 17I00015SNO33 | Sep. 15, 2018 | Sep. 14, 2019 |

4. Conducted Emission Test

4.1 Test Standard and Limit

4.1.1 Test Standard
FCC Part 15.207

4.1.2 Test Limit

Conducted Emission Test Limit

| Frequency | Maximum RF Line Voltage (dB μ V) | |
|---------------|--------------------------------------|---------------|
| | Quasi-peak Level | Average Level |
| 150kHz~500kHz | 66 ~ 56 * | 56 ~ 46 * |
| 500kHz~5MHz | 56 | 46 |
| 5MHz~30MHz | 60 | 50 |

Notes:

- (1) *Decreasing linearly with logarithm of the frequency.
- (2) The lower limit shall apply at the transition frequencies.
- (3) The limit decrease in line with the logarithm of the frequency in the range of 0.15 to 0.50MHz.

4.2 Test Setup

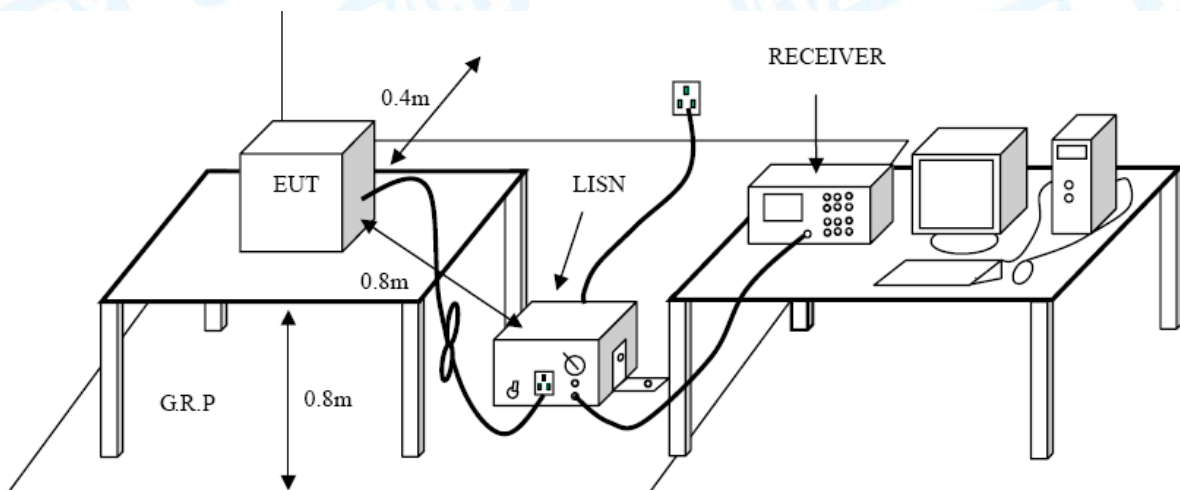

4.3 Test Procedure

The EUT was placed 0.8 meters from the horizontal ground plane with EUT being connected to the power mains through a line impedance stabilization network (LISN). All other support equipments powered from additional LISN(s). The LISN provide 50 Ohm/ 50uH of coupling impedance for the measuring instrument.

Interconnecting cables that hang closer than 40 cm to the ground plane shall be folded back and forth in the center forming a bundle 30 to 40 cm long.

I/O cables that are not connected to a peripheral shall be bundled in the center. The end of the cable may be terminated, if required, using the correct terminating impedance. The overall length shall not exceed 1 m.

LISN at least 80 cm from nearest part of EUT chassis.

The bandwidth of EMI test receiver is set at 9kHz, and the test frequency band is from 0.15MHz to 30MHz.

4.4 EUT Operating Mode

Please refer to the description of test mode.

4.5 Test Data

Please refer to the Attachment A.

5. Radiated Emission Test

5.1 Test Standard and Limit

5.1.1 Test Standard
FCC Part 15.209

5.1.2 Test Limit

Radiated Emission Limits (9 kHz~1000 MHz)

| Frequency (MHz) | Field Strength (microvolt/meter) | Measurement Distance (meters) |
|-----------------|----------------------------------|-------------------------------|
| 0.009~0.490 | 2400/F(KHz) | 300 |
| 0.490~1.705 | 24000/F(KHz) | 30 |
| 1.705~30.0 | 30 | 30 |
| 30~88 | 100 | 3 |
| 88~216 | 150 | 3 |
| 216~960 | 200 | 3 |
| Above 960 | 500 | 3 |

Radiated Emission Limit (Above 1000MHz)

| Frequency (MHz) | Distance of 3m (dBuV/m) | |
|-----------------|-------------------------|---------|
| | Peak | Average |
| Above 1000 | 74 | 54 |

Note:

- (1) The tighter limit applies at the band edges.
- (2) Emission Level(dBuV/m)=20log Emission Level(uV/m)

5.2 Test Setup

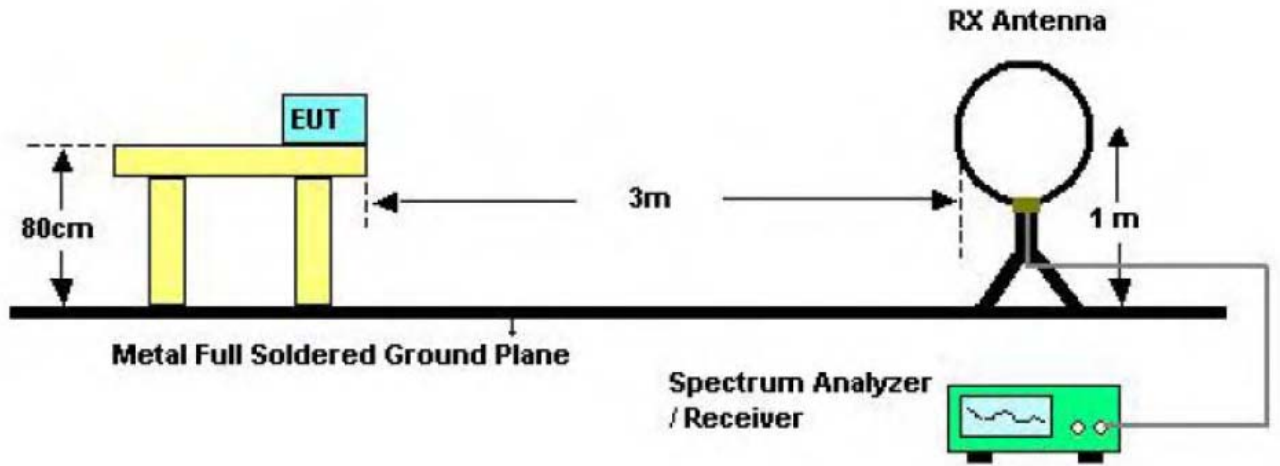

Below 30MHz Test Setup

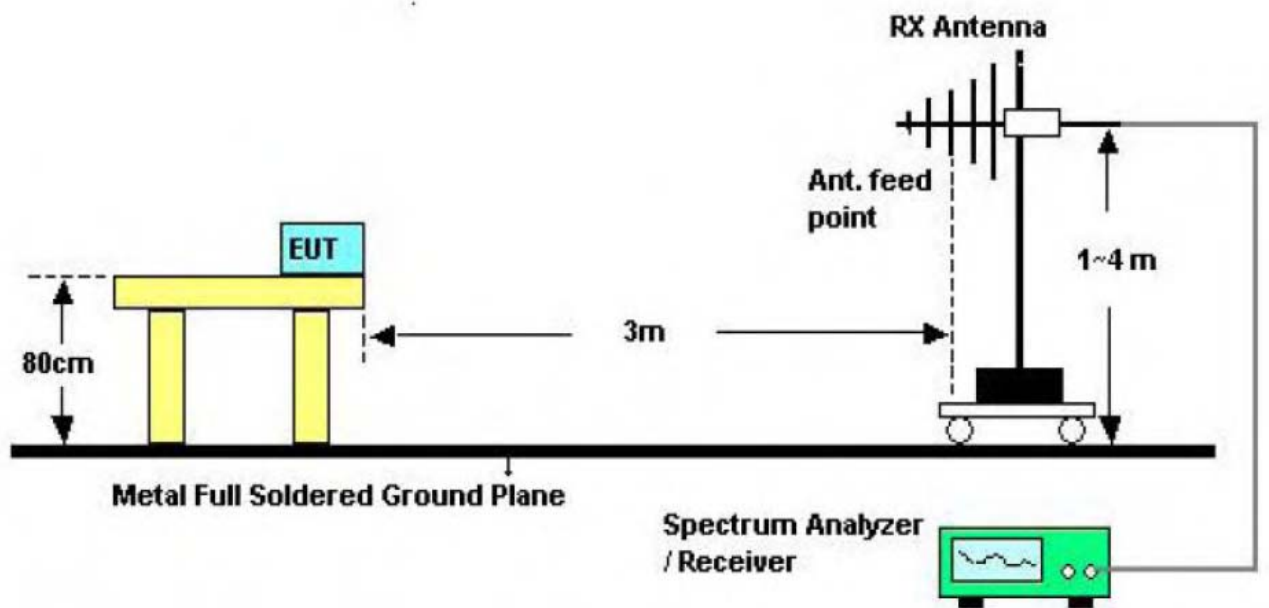

Below 1000MHz Test Setup

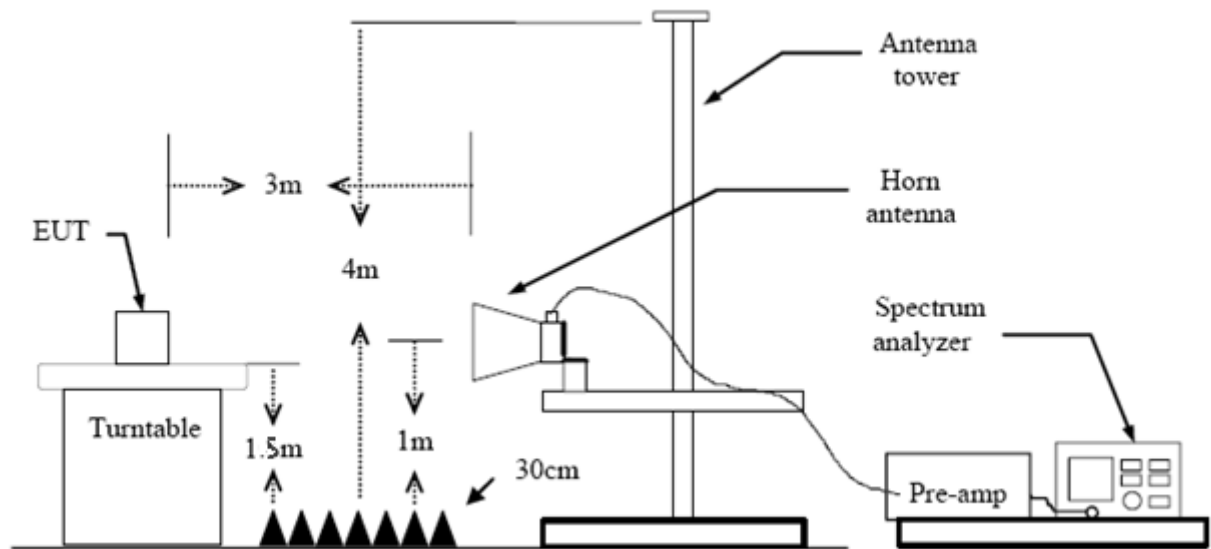

Above 1GHz Test Setup

5.3 Test Procedure

- (1) Measurements at frequency above 1GHz. The EUT was placed on a rotating 1.5m high above the ground. RF absorbers covered the ground plane with a minimum area of 3.0m by 3.0m between the EUT and measurement receiver antenna. The RF absorber shall not exceed 30cm in high above the conducting floor. The table was rotated 360 degrees to determine the position of the highest radiation.
- (2) Measurements at frequency Below 1GHz. The EUT was placed on a rotating 0.8m high above the ground. RF absorbers covered the ground plane with a minimum area of 3.0m by 3.0m between the EUT and measurement receiver antenna. The RF absorber shall not exceed 30cm in high above the conducting floor. The table was rotated 360 degrees to determine the position of the highest radiation.
- (3) The Test antenna shall vary between 1m and 4m, Both Horizontal and Vertical antenna are set to make measurement.
- (4) The initial step in collecting conducted emission data is a spectrum analyzer peak detector mode pre-scanning the measurement frequency range. Significant peaks are then marked and then Quasi Peak detector mode re-measured.
- (5) If the Peak Mode measured value compliance with and lower than Quasi Peak Mode Limit Bellow 1 GHz, the EUT shall be deemed to meet QP Limits and then no additional QP Mode measurement performed. But the Peak Value and average value both need to comply with applicable limit above 1 GHz.
- (6) Testing frequency range below 1GHz the measuring instrument use VBW=120 kHz with Quasi-peak detection.
- (7) Testing frequency range above 1GHz the measuring instrument use RBW=1 MHz and VBW=3 MHz with Peak Detector for Peak Values, and use RBW=1 MHz and VBW=10 Hz with Peak Detector for Average Values.

(8) For the actual test configuration, please see the test setup photo.

5.4 EUT Operating Condition

The Equipment Under Test was set to Continual Transmitting in maximum power.

5.5 Test Data

Remark: During testing above 1GHz the measuring instrument use RBW=1 MHz and VBW=3 MHz with Peak Detector for Peak Values, and use RBW=1 MHz and VBW=10 Hz with Peak Detector for Average Values.

Please refer to the Attachment B.

6. Restricted Bands Requirement

6.1 Test Standard and Limit

- 6.1.1 Test Standard
 - FCC Part 15.247(d)
 - FCC Part 15.209
 - FCC Part 15.205

6.1.2 Test Limit

| Restricted Frequency Band (MHz) | Distance of 3m (dBuV/m) | |
|---------------------------------|-------------------------|---------|
| | Peak | Average |
| 2310 ~2390 | 74 | 54 |
| 2483.5 ~2500 | 74 | 54 |

6.2 Test Setup

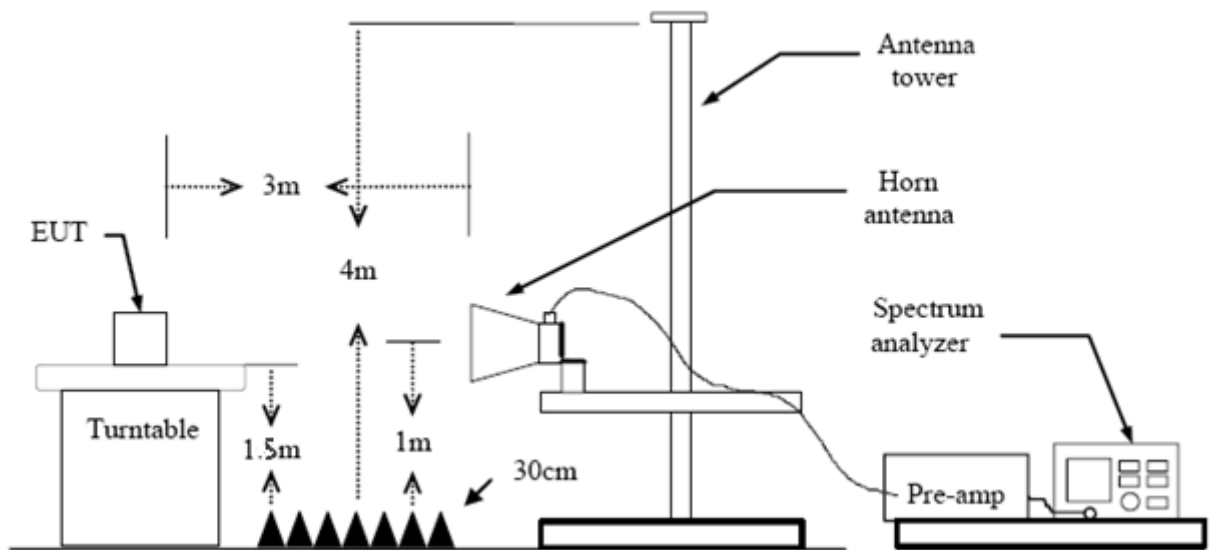

6.3 Test Procedure

- (1) The measuring distance of 3m shall be used for measurements at frequency Below 1GHz and above 1 GHz. The EUT was placed on a rotating 0.8m high above ground, the table was rotated 360 degrees to determine the position of the highest radiation.
- (2) Measurements at frequency above 1GHz. The EUT was placed on a rotating 1.5m high above the ground. RF absorbers covered the ground plane with a minimum area of 3.0m by 3.0m between the EUT and measurement receiver antenna. The RF absorber shall not exceed 30cm in high above the conducting floor. The table was rotated 360 degrees to determine the position of the highest radiation.

- (3) The Test antenna shall vary between 1m and 4m, Both Horizontal and Vertical antenna are set to make measurement.
- (4) The initial step in collecting conducted emission data is a spectrum analyzer peak detector mode pre-scanning the measurement frequency range. Significant peaks are then marked and then Quasi Peak detector mode re-measured.
- (5) If the Peak Mode measured value compliance with and lower than Quasi Peak Mode Limit Bellow 1 GHz, the EUT shall be deemed to meet QP Limits and then no additional QP Mode measurement performed. But the Peak Value and average value both need to comply with applicable limit above 1 GHz.
- (6) Testing frequency range below 1GHz the measuring instrument use VBW=120 kHz with Quasi-peak detection.
- (7) Testing frequency range above 1GHz the measuring instrument use RBW=1 MHz and VBW=3 MHz with Peak Detector for Peak Values, and use RBW=1 MHz and VBW=10 Hz with Peak Detector for Average Values.
- (8) For the actual test configuration, please see the test setup photo.

6.4 EUT Operating Condition

The Equipment Under Test was set to Continual Transmitting in maximum power.

6.5 Test Data

Please refer to the Attachment C.

7. Bandwidth Test

7.1 Test Standard and Limit

- 7.1.1 Test Standard
FCC Part 15.247 (a)(2)
- 7.1.2 Test Limit

| FCC Part 15 Subpart C(15.247) | | |
|-------------------------------|-----------------------------------|----------------------|
| Test Item | Limit | Frequency Range(MHz) |
| Bandwidth | ≥ 500 KHz (6dB bandwidth) | 2400~2483.5 |

7.2 Test Setup

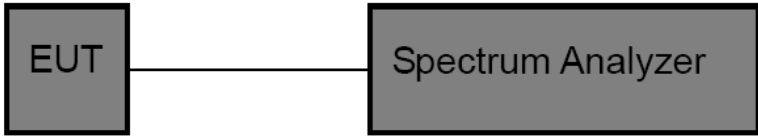

7.3 Test Procedure

- (1) The EUT was directly connected to the spectrum analyzer and antenna output port as show in the block diagram above.
- (2) The bandwidth is measured at an amplitude level reduced 6dB from the reference level. The reference level is the level of the highest amplitude signal observed from the transmitter at the fundamental frequency. Once the reference level is established, the equipment is conditioned with typical modulating signal to produce the worst –case (i.e the widest) bandwidth.
- (3)Measure the channel separation the spectrum analyzer was set to Resolution Bandwidth:100 kHz, and Video Bandwidth:300 kHz, Detector: Peak, Sweep Time set auto.

7.4 EUT Operating Condition

The EUT was set to continuously transmitting in each mode and low, Digital photo framesdle and high channel for the test.

7.5 Test Data

Please refer to the Attachment D.

8. Peak Output Power Test

8.1 Test Standard and Limit

- 8.1.1 Test Standard
FCC Part 15.247 (b)
- 8.1.2 Test Limit

| FCC Part 15 Subpart C(15.247) | | |
|-------------------------------|------------------|----------------------|
| Test Item | Limit | Frequency Range(MHz) |
| Peak Output Power | 1 Watt or 30 dBm | 2400~2483.5 |

8.2 Test Setup

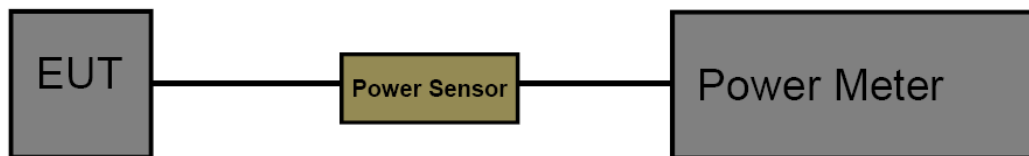

8.3 Test Procedure

The measurement is according to section 9.1.2 of KDB 558074 D01 v05r02.

The EUT was connected to RF power meter via a broadband power sensor as show the block above. The power sensor video bandwidth is greater than or equal to the DTS bandwidth of the equipment.

8.4 EUT Operating Condition

The EUT was set to continuously transmitting in the max power during the test.

8.5 Test Data

Please refer to the Attachment E.

9. Power Spectral Density Test

9.1 Test Standard and Limit

- 9.1.1 Test Standard
FCC Part 15.247 (e)
- 9.1.2 Test Limit

| FCC Part 15 Subpart C(15.247) | | |
|-------------------------------|--------------------|----------------------|
| Test Item | Limit | Frequency Range(MHz) |
| Power Spectral Density | 8dBm(in any 3 kHz) | 2400~2483.5 |

9.2 Test Setup

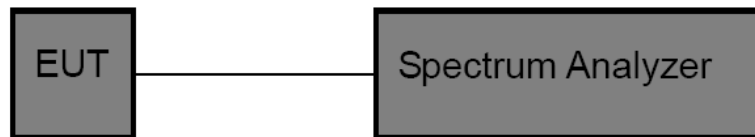

9.3 Test Procedure

The EUT was directly connected to the Spectrum Analyzer and antenna output port as show in the block diagram above. The measurement according to section 10.2 of KDB 558074 D01 D01 v05r02.

- (1) The EUT was directly connected to the spectrum analyzer and antenna output port as show in the block diagram above.
- (2) Set analyser center frequency to DTS channel center frequency.
- (3) Set the span to 1.5 times the DTS bandwidth.
- (4) Set the RBW to: 3 kHz
- (5) Set the VBW to: 10 kHz
- (6) Detector: peak
- (7) Sweep time: auto
- (8) Allow trace to fully stabilize. Then use the peak marker function to determine the maximum amplitude level.

9.4 EUT Operating Condition

The EUT was set to continuously transmitting in each mode and low, Digital photo framesdle and high channel for the test.

9.5 Test Data

Please refer to the Attachment F.

10. Antenna Requirement

10.1 Standard Requirement

10.1.1 Standard

FCC Part 15.203

10.1.2 Requirement

An intentional radiator shall be designed to ensure that no antenna other than that furnished by the responsible party shall be used with the device. The use of a permanently attached antenna or of an antenna that uses a unique coupling to the intentional radiator shall be considered sufficient to comply with the provisions of this Section. The manufacturer may design the unit so that a broken antenna can be replaced by the user, but the use of a standard antenna jack or electrical connector is prohibited.

10.2 Antenna Connected Construction

The gains of the antenna used for transmitting is 2 dBi, and the antenna de-signed with permanent attachment and no consideration of replacement. Please see the EUT photo for details.

Result

The EUT antenna is a FPC Antenna. It complies with the standard requirement.

| Antenna Type |
|--|
| <input type="checkbox"/> Permanent attached antenna |
| <input checked="" type="checkbox"/> Unique connector antenna |
| <input type="checkbox"/> Professional installation antenna |

Attachment A-- Conducted Emission Test Data

Remark: All channels have been tested and Shows only the worst channels.

| | | | |
|----------------------|-----------------------------|---------------------------|-----|
| Temperature: | 25 °C | Relative Humidity: | 55% |
| Test Voltage: | AC 120V/60Hz | | |
| Terminal: | Line | | |
| Test Mode: | Mode 1 | | |
| Remark: | Only worse case is reported | | |

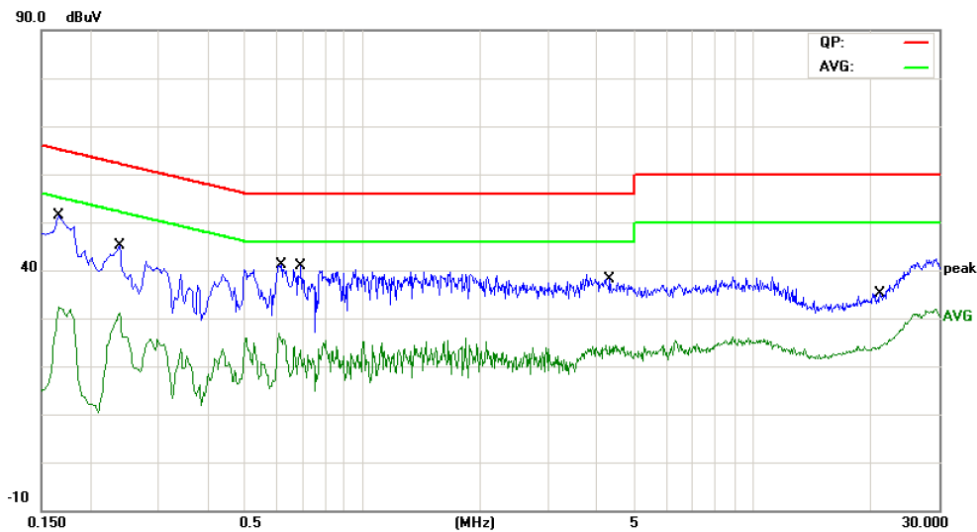

| No. | Mk. | Freq. MHz | Reading Level dBuV | Correct Factor dB | Measure- ment dBuV | Limit dBuV | Over dB | Detector |
|-----|-----|--------------|--------------------------|-------------------------|--------------------------|---------------|------------|----------|
| 1 | * | 0.1660 | 38.27 | 9.58 | 47.85 | 65.15 | -17.30 | QP |
| 2 | | 0.1660 | 17.84 | 9.58 | 27.42 | 55.15 | -27.73 | AVG |
| 3 | | 0.2380 | 29.53 | 9.58 | 39.11 | 62.16 | -23.05 | QP |
| 4 | | 0.2380 | 17.26 | 9.58 | 26.84 | 52.16 | -25.32 | AVG |
| 5 | | 0.6180 | 28.94 | 9.61 | 38.55 | 56.00 | -17.45 | QP |
| 6 | | 0.6180 | 15.67 | 9.61 | 25.28 | 46.00 | -20.72 | AVG |
| 7 | | 0.6940 | 27.30 | 9.61 | 36.91 | 56.00 | -19.09 | QP |
| 8 | | 0.6940 | 11.15 | 9.61 | 20.76 | 46.00 | -25.24 | AVG |
| 9 | | 4.3020 | 22.40 | 9.70 | 32.10 | 56.00 | -23.90 | QP |
| 10 | | 4.3020 | 13.33 | 9.70 | 23.03 | 46.00 | -22.97 | AVG |
| 11 | | 21.1820 | 18.49 | 10.56 | 29.05 | 60.00 | -30.95 | QP |
| 12 | | 21.1820 | 12.89 | 10.56 | 23.45 | 50.00 | -26.55 | AVG |

Emission Level= Read Level+ Correct Factor

| | | | |
|----------------------|-----------------------------|---------------------------|-----|
| Temperature: | 25 °C | Relative Humidity: | 55% |
| Test Voltage: | AC 120V/60Hz | | |
| Terminal: | Neutral | | |
| Test Mode: | Mode 1 | | |
| Remark: | Only worse case is reported | | |

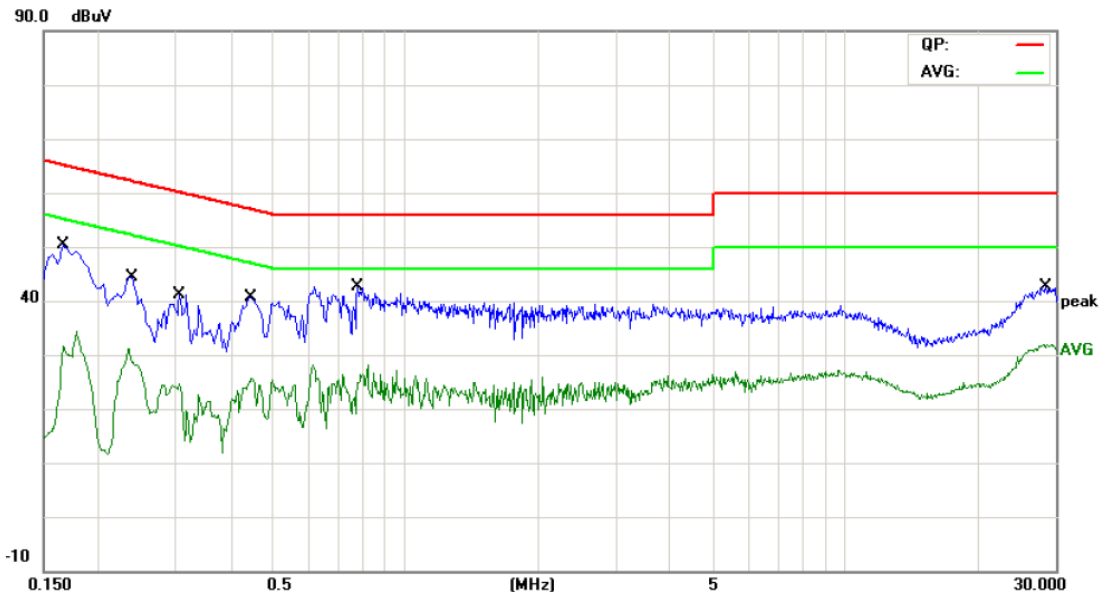

| No. | Mk. | Freq. MHz | Reading Level dBuV | Correct Factor dB | Measure- ment dBuV | Limit dBuV | Over dB | Detector |
|-----|-----|--------------|--------------------------|-------------------------|--------------------------|---------------|------------|----------|
| 1 | | 0.1660 | 36.83 | 9.58 | 46.41 | 65.15 | -18.74 | QP |
| 2 | | 0.1660 | 16.21 | 9.58 | 25.79 | 55.15 | -29.36 | AVG |
| 3 | | 0.2380 | 29.70 | 9.58 | 39.28 | 62.16 | -22.88 | QP |
| 4 | | 0.2380 | 18.77 | 9.58 | 28.35 | 52.16 | -23.81 | AVG |
| 5 | | 0.3060 | 27.07 | 9.59 | 36.66 | 60.08 | -23.42 | QP |
| 6 | | 0.3060 | 13.17 | 9.59 | 22.76 | 50.08 | -27.32 | AVG |
| 7 | | 0.4460 | 26.48 | 9.60 | 36.08 | 56.95 | -20.87 | QP |
| 8 | | 0.4460 | 12.87 | 9.60 | 22.47 | 46.95 | -24.48 | AVG |
| 9 | * | 0.7780 | 29.40 | 9.61 | 39.01 | 56.00 | -16.99 | QP |
| 10 | | 0.7780 | 14.57 | 9.61 | 24.18 | 46.00 | -21.82 | AVG |
| 11 | | 28.5020 | 25.69 | 10.78 | 36.47 | 60.00 | -23.53 | QP |
| 12 | | 28.5020 | 20.24 | 10.78 | 31.02 | 50.00 | -18.98 | AVG |

Emission Level= Read Level+ Correct Factor

Attachment B-- Radiated Emission Test Data

9KHz~30MHz

From 9KHz to 30MHz: Conclusion: PASS

Note: The amplitude of spurious emissions which are attenuated by more than 20dB below the permissible value has no need to be reported.

30MHz~1GHz

| | | | |
|----------------------|------------------------------|---------------------------|-----|
| Temperature: | 25 °C | Relative Humidity: | 55% |
| Test Voltage: | AC 120V/60HZ | | |
| Ant. Pol. | Horizontal | | |
| Test Mode: | TX B Mode 2412MHz | | |
| Remark: | Only worse case is reported. | | |

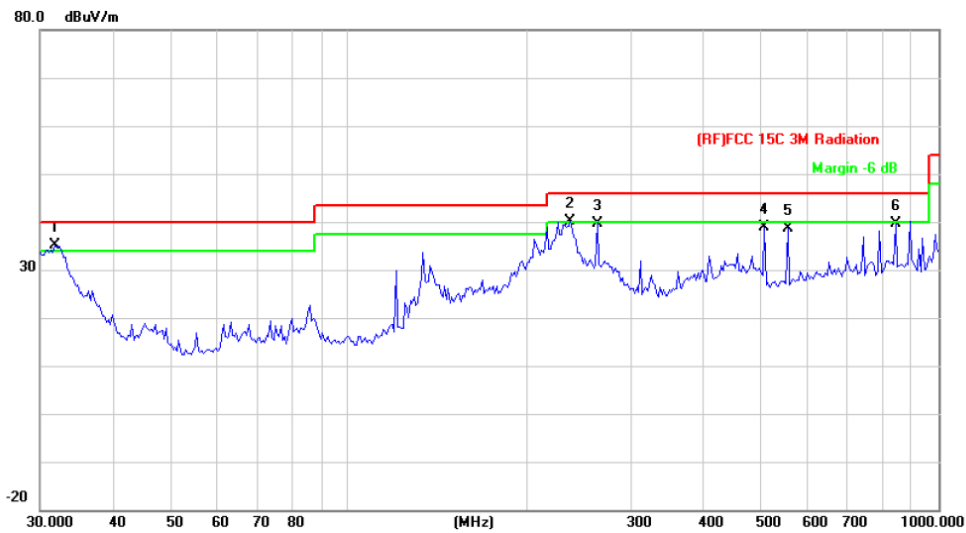

| No. | Mk. | Freq. MHz | Reading Level dBuV | Correct Factor dB/m | Measure- ment dBuV/m | Limit dBuV/m | Over dB | Detector |
|-----|-----|--------------|--------------------------|---------------------------|----------------------------|-----------------|------------|----------|
| 1 | * | 31.7313 | 17.59 | 17.49 | 35.08 | 40.00 | -4.92 | peak |
| 2 | ! | 237.4756 | 26.24 | 13.83 | 40.07 | 46.00 | -5.93 | peak |
| 3 | | 263.8190 | 24.95 | 14.80 | 39.75 | 46.00 | -6.25 | peak |
| 4 | | 506.4791 | 17.58 | 21.22 | 38.80 | 46.00 | -7.20 | peak |
| 5 | | 554.8251 | 16.08 | 22.59 | 38.67 | 46.00 | -7.33 | peak |
| 6 | | 845.0878 | 14.16 | 25.45 | 39.61 | 46.00 | -6.39 | peak |

*:Maximum data x:Over limit !:over margin

Emission Level= Read Level+ Correct Factor

| | | | |
|----------------------|------------------------------|---------------------------|-----|
| Temperature: | 25 °C | Relative Humidity: | 55% |
| Test Voltage: | AC 120V/60HZ | | |
| Ant. Pol. | Vertical | | |
| Test Mode: | TX B Mode 2412MHz | | |
| Remark: | Only worse case is reported. | | |

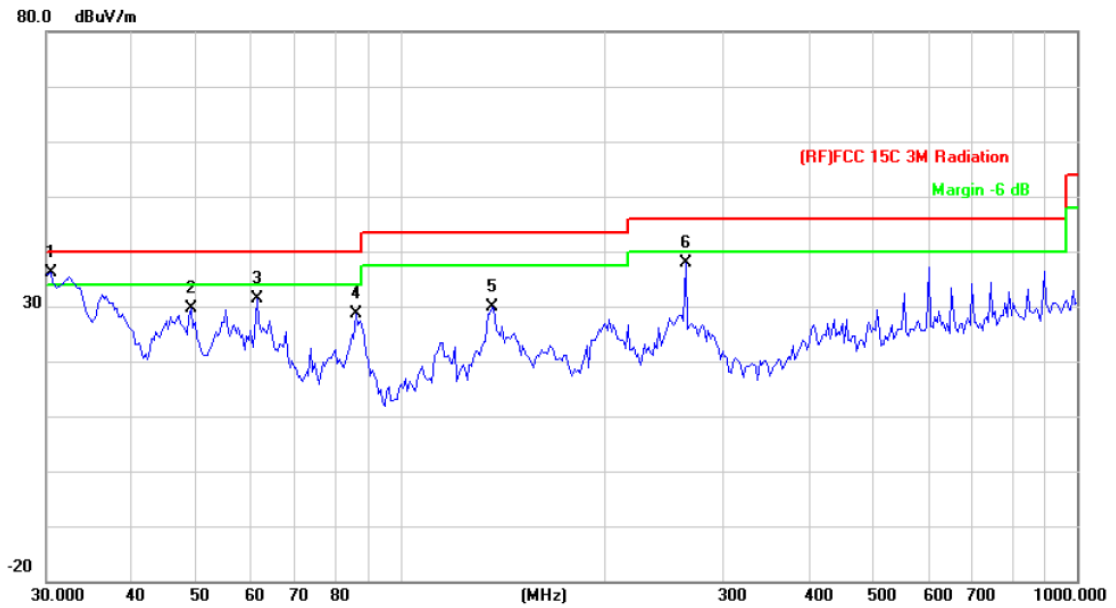

| No. | Mk. | Freq. MHz | Reading Level dBuV | Correct Factor dB/m | Measure- ment dBuV/m | Limit dBuV/m | Over dB | Detector |
|-----|-----|--------------|--------------------------|---------------------------|----------------------------|-----------------|------------|----------|
| 1 | * | 30.4237 | 17.71 | 18.48 | 36.19 | 40.00 | -3.81 | peak |
| 2 | | 49.0144 | 20.78 | 8.88 | 29.66 | 40.00 | -10.34 | peak |
| 3 | | 61.3462 | 23.80 | 7.54 | 31.34 | 40.00 | -8.66 | peak |
| 4 | | 85.8983 | 19.02 | 9.56 | 28.58 | 40.00 | -11.42 | peak |
| 5 | | 136.4598 | 20.56 | 9.28 | 29.84 | 43.50 | -13.66 | peak |
| 6 | | 263.8190 | 23.03 | 14.80 | 37.83 | 46.00 | -8.17 | peak |

*:Maximum data x:Over limit !:over margin

Emission Level= Read Level+ Correct Factor

Above 1GHz

| | | | |
|----------------------|---|---------------------------|-----|
| Temperature: | 25 °C | Relative Humidity: | 55% |
| Test Voltage: | AC 120V/60 Hz | | |
| Ant. Pol. | Horizontal | | |
| Test Mode: | TX B Mode 2412MHz Main ANT. | | |
| Remark: | No report for the emission which more than 10 dB below the prescribed limit. Only show the worse case Main ANT. | | |

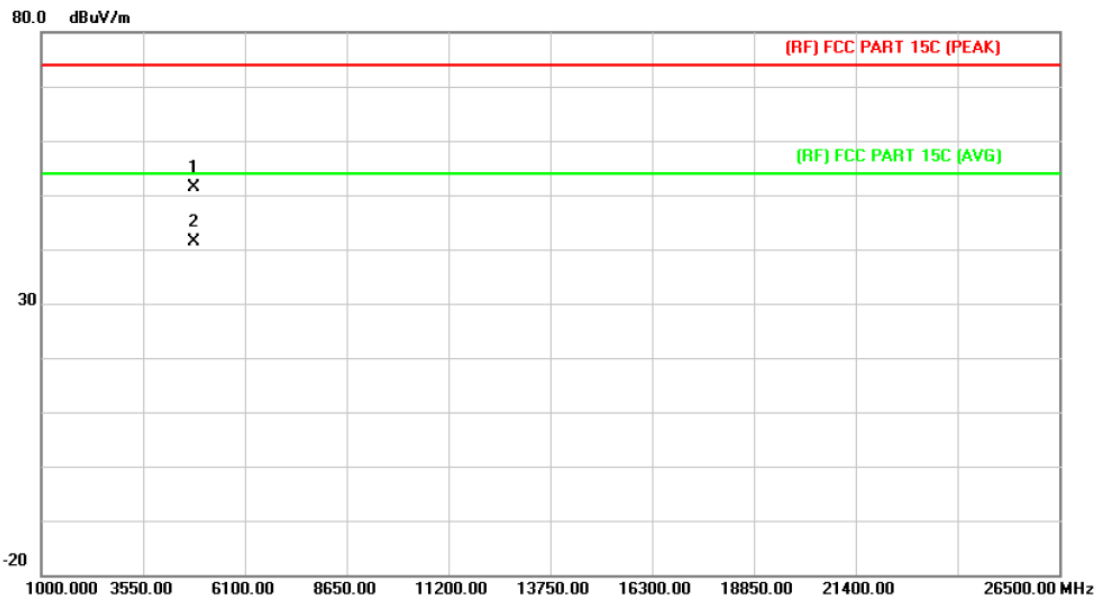

| No. | Mk. | Freq. MHz | Reading Level dBuV | Correct Factor dB/m | Measure- ment dBuV/m | Limit dBuV/m | Over dB | Detector |
|-----|-----|--------------|--------------------------|---------------------------|----------------------------|-----------------|------------|----------|
| 1 | | 4823.904 | 43.15 | 8.19 | 51.34 | 74.00 | -22.66 | peak |
| 2 | * | 4823.904 | 33.19 | 8.19 | 41.38 | 54.00 | -12.62 | AVG |

Emission Level= Read Level+ Correct Factor

| | | | |
|----------------------|---|---------------------------|-----|
| Temperature: | 25 °C | Relative Humidity: | 55% |
| Test Voltage: | AC 120V/60 Hz | | |
| Ant. Pol. | Vertical | | |
| Test Mode: | TX B Mode 2412MHz Main ANT. | | |
| Remark: | No report for the emission which more than 10 dB below the prescribed limit. Only show the worse case Main ANT. | | |

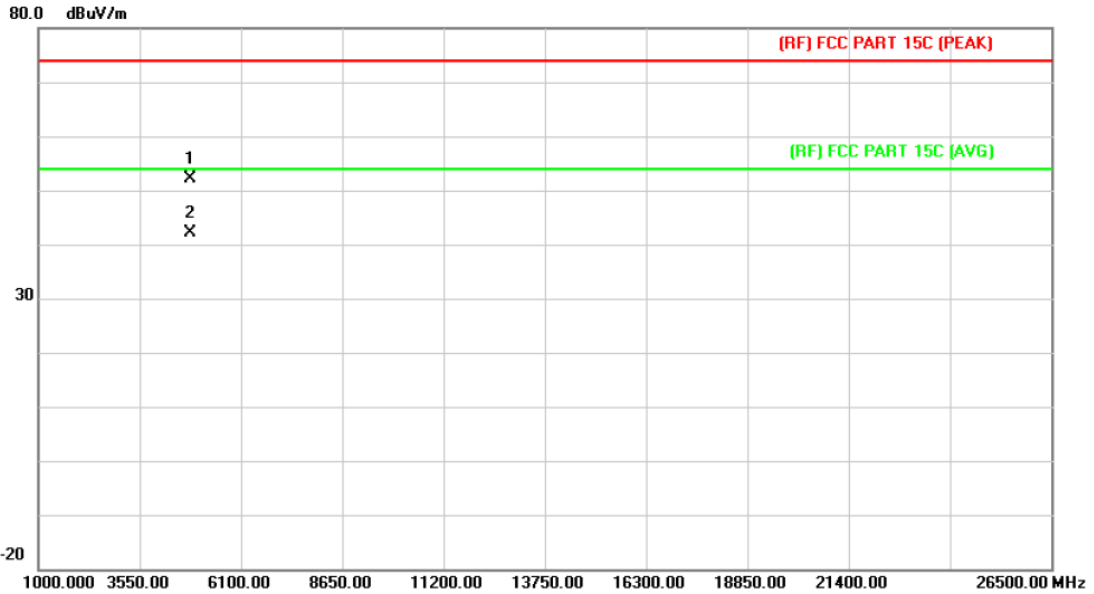

| No. | Mk. | Freq. MHz | Reading Level dBuV | Correct Factor dB/m | Measure- ment dBuV/m | Limit dBuV/m | Over dB | Detector |
|-----|-----|--------------|--------------------------|---------------------------|----------------------------|-----------------|------------|----------|
| 1 | | 4823.904 | 43.94 | 8.19 | 52.13 | 74.00 | -21.87 | peak |
| 2 | * | 4823.904 | 33.99 | 8.19 | 42.18 | 54.00 | -11.82 | AVG |

Emission Level= Read Level+ Correct Factor

| | | | |
|---------------|---|--------------------|-----|
| Temperature: | 25 °C | Relative Humidity: | 55% |
| Temperature: | 25 °C | Relative Humidity: | 55% |
| Test Voltage: | AC 120V/60 Hz | | |
| Ant. Pol. | Horizontal | | |
| Test Mode: | TX B Mode 2437MHz Main ANT. | | |
| Remark: | No report for the emission which more than 10 dB below the prescribed limit. Only show the worse case Main ANT. | | |

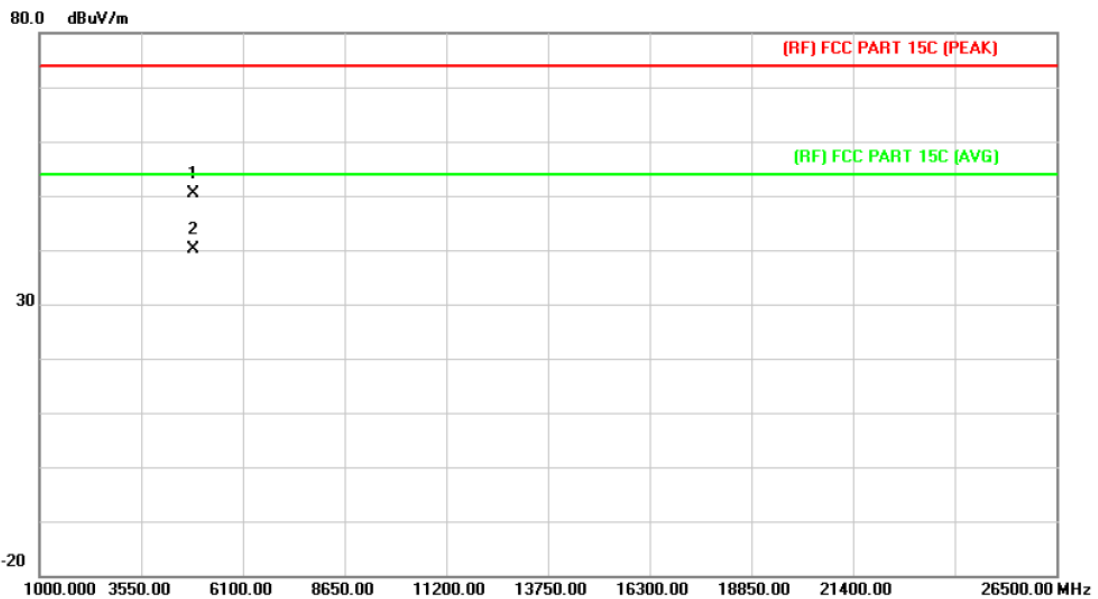

| No. | Mk. | Freq. MHz | Reading Level dBuV | Correct Factor dB/m | Measure- ment dBuV/m | Limit dBuV/m | Over dB | Detector |
|-----|-----|--------------|--------------------------|---------------------------|----------------------------|-----------------|------------|----------|
| 1 | | 4873.921 | 42.24 | 8.21 | 50.45 | 74.00 | -23.55 | peak |
| 2 | * | 4873.921 | 32.04 | 8.21 | 40.25 | 54.00 | -13.75 | AVG |

Emission Level= Read Level+ Correct Factor

| | | | |
|----------------------|---|---------------------------|-----|
| Temperature: | 25 °C | Relative Humidity: | 55% |
| Test Voltage: | AC 120V/60 Hz | | |
| Ant. Pol. | Vertical | | |
| Test Mode: | TX B Mode 2437MHz Main ANT. | | |
| Remark: | No report for the emission which more than 10 dB below the prescribed limit. Only show the worse case Main ANT. | | |

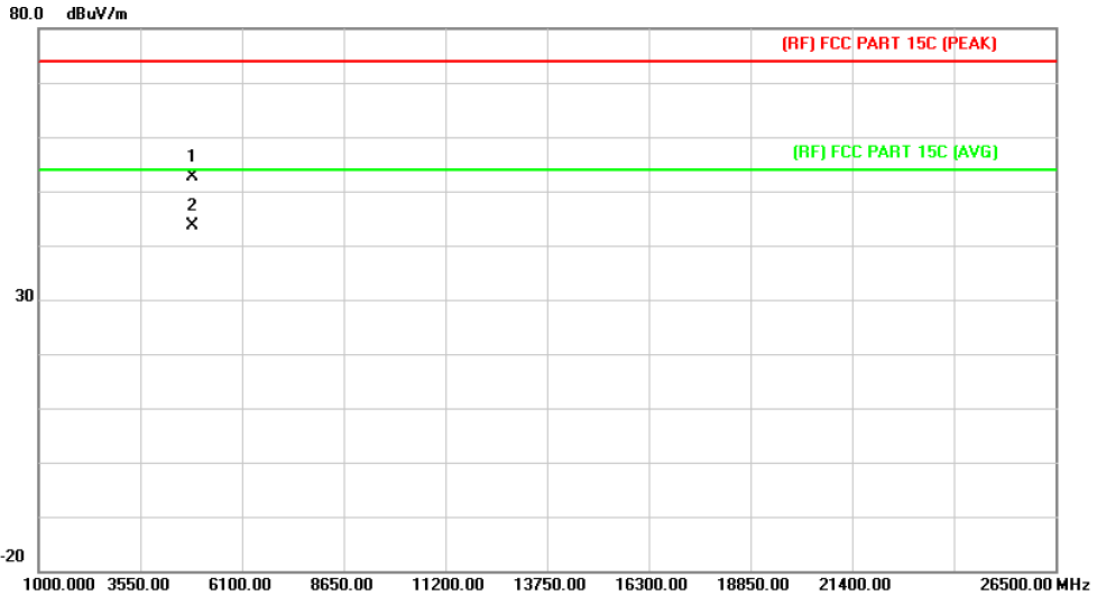

| No. | Mk. | Freq. MHz | Reading Level dBuV | Correct Factor dB/m | Measure- ment dBuV/m | Limit dBuV/m | Over dB | Detector |
|-----|-----|--------------|--------------------------|---------------------------|----------------------------|-----------------|------------|----------|
| 1 | | 4873.921 | 44.35 | 8.21 | 52.56 | 74.00 | -21.44 | peak |
| 2 | * | 4873.921 | 35.31 | 8.21 | 43.52 | 54.00 | -10.48 | AVG |

Emission Level= Read Level+ Correct Factor

| | | | |
|----------------------|---|---------------------------|-----|
| Temperature: | 25 °C | Relative Humidity: | 55% |
| Test Voltage: | AC 120V/60 Hz | | |
| Ant. Pol. | Horizontal | | |
| Test Mode: | TX B Mode 2462MHz Main ANT. | | |
| Remark: | No report for the emission which more than 10 dB below the prescribed limit. Only show the worse case Main ANT. | | |

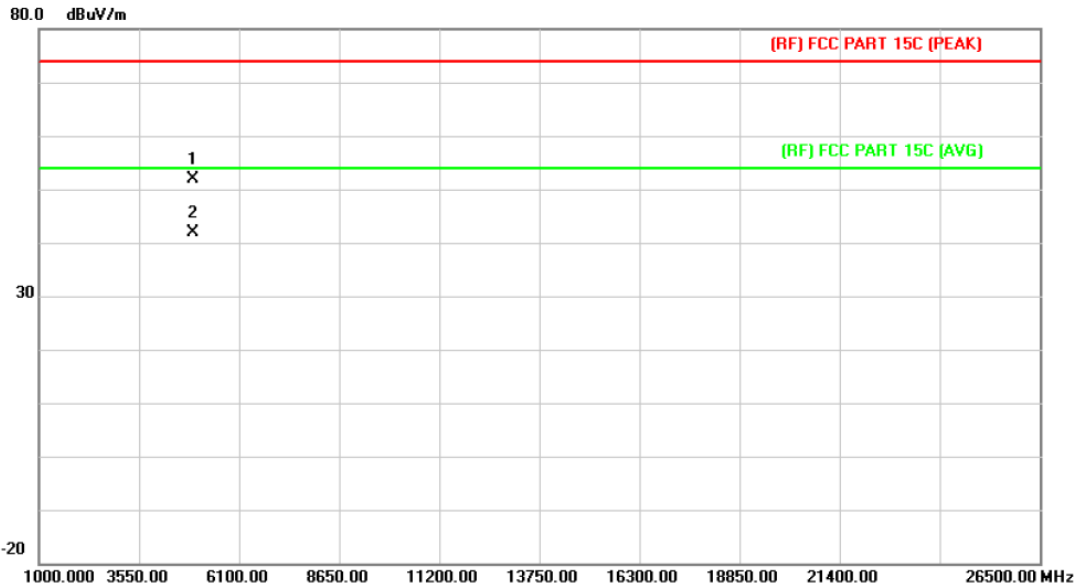

| No. | Mk. | Freq. | Reading Level | Correct Factor | Measurement | Limit | Over | Detector |
|-----|-----|----------|---------------|----------------|-------------|--------|--------|----------|
| | | MHz | dBuV | dB/m | dBuV/m | dBuV/m | dB | |
| 1 | | 4923.913 | 43.65 | 8.22 | 51.87 | 74.00 | -22.13 | peak |
| 2 | * | 4923.913 | 33.63 | 8.22 | 41.85 | 54.00 | -12.15 | AVG |

Emission Level= Read Level+ Correct Factor

| | | | |
|----------------------|---|---------------------------|-----|
| Temperature: | 25 °C | Relative Humidity: | 55% |
| Test Voltage: | AC 120V/60 Hz | | |
| Ant. Pol. | Vertical | | |
| Test Mode: | TX B Mode 2462MHz Main ANT. | | |
| Remark: | No report for the emission which more than 10 dB below the prescribed limit. Only show the worse case Main ANT. | | |

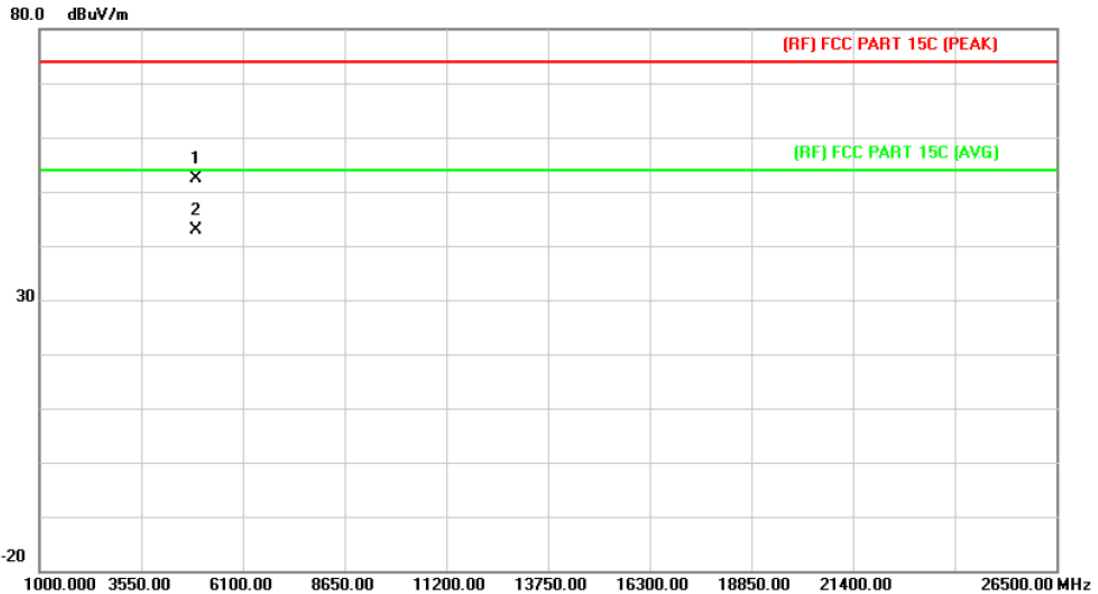

| No. | Mk. | Freq. MHz | Reading Level dBuV | Correct Factor dB/m | Measure- ment dBuV/m | Limit dBuV/m | Over dB | Detector |
|-----|-----|--------------|--------------------------|---------------------------|----------------------------|-----------------|------------|----------|
| 1 | | 4923.913 | 44.07 | 8.22 | 52.29 | 74.00 | -21.71 | peak |
| 2 | * | 4923.913 | 34.76 | 8.22 | 42.98 | 54.00 | -11.02 | AVG |

Emission Level= Read Level+ Correct Factor

| | | | |
|----------------------|---|---------------------------|-----|
| Temperature: | 25 °C | Relative Humidity: | 55% |
| Test Voltage: | AC 120V/60 Hz | | |
| Ant. Pol. | Horizontal | | |
| Test Mode: | TX G Mode 2412MHz Main ANT. | | |
| Remark: | No report for the emission which more than 10 dB below the prescribed limit. Only show the worse case Main ANT. | | |

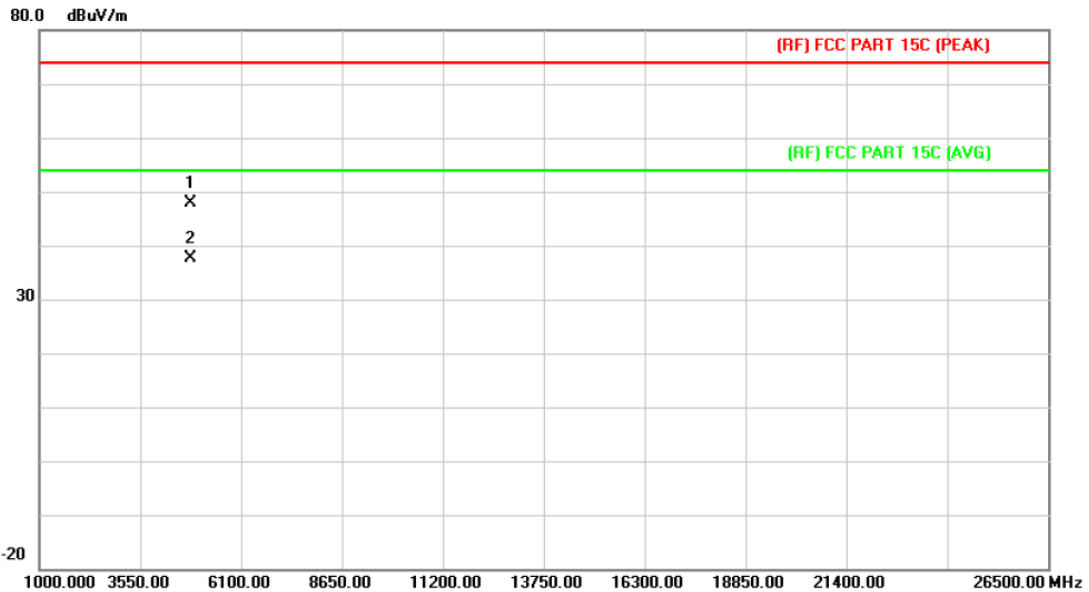

| No. | Mk. | Freq. MHz | Reading Level dBuV | Correct Factor dB/m | Measure- ment dBuV/m | Limit dBuV/m | Over dB | Detector |
|-----|-----|--------------|--------------------------|---------------------------|----------------------------|-----------------|------------|----------|
| 1 | | 4823.927 | 39.76 | 8.19 | 47.95 | 74.00 | -26.05 | peak |
| 2 | * | 4823.927 | 29.46 | 8.19 | 37.65 | 54.00 | -16.35 | AVG |

Emission Level= Read Level+ Correct Factor

| | | | |
|----------------------|---|---------------------------|-----|
| Temperature: | 25 °C | Relative Humidity: | 55% |
| Test Voltage: | AC 120V/60 Hz | | |
| Ant. Pol. | Vertical | | |
| Test Mode: | TX G Mode 2412MHz Main ANT. | | |
| Remark: | No report for the emission which more than 10 dB below the prescribed limit. Only show the worse case Main ANT. | | |

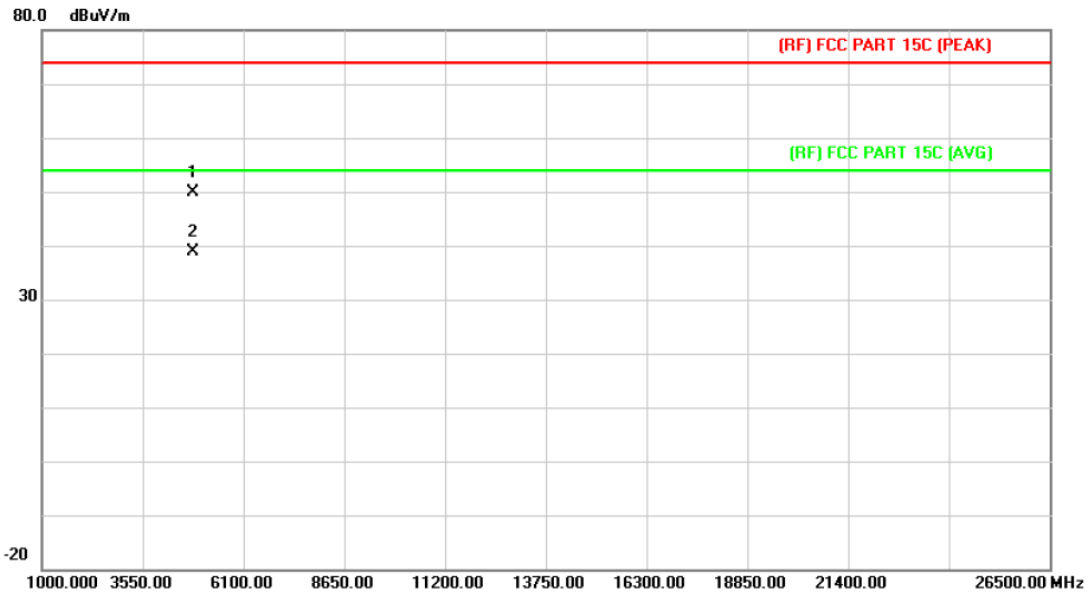

| No. | Mk. | Freq. | Reading Level | Correct Factor | Measurement | Limit | Over | Detector |
|-----|-----|----------|---------------|----------------|-------------|--------|--------|----------|
| | | MHz | dBuV | dB/m | dBuV/m | dBuV/m | dB | |
| 1 | | 4823.973 | 41.70 | 8.19 | 49.89 | 74.00 | -24.11 | peak |
| 2 | * | 4823.973 | 30.75 | 8.19 | 38.94 | 54.00 | -15.06 | AVG |

Emission Level= Read Level+ Correct Factor

| | | | |
|----------------------|---|---------------------------|-----|
| Temperature: | 25 °C | Relative Humidity: | 55% |
| Test Voltage: | AC 120V/60 Hz | | |
| Ant. Pol. | Horizontal | | |
| Test Mode: | TX G Mode 2437MHz Main ANT. | | |
| Remark: | No report for the emission which more than 10 dB below the prescribed limit. Only show the worse case Main ANT. | | |

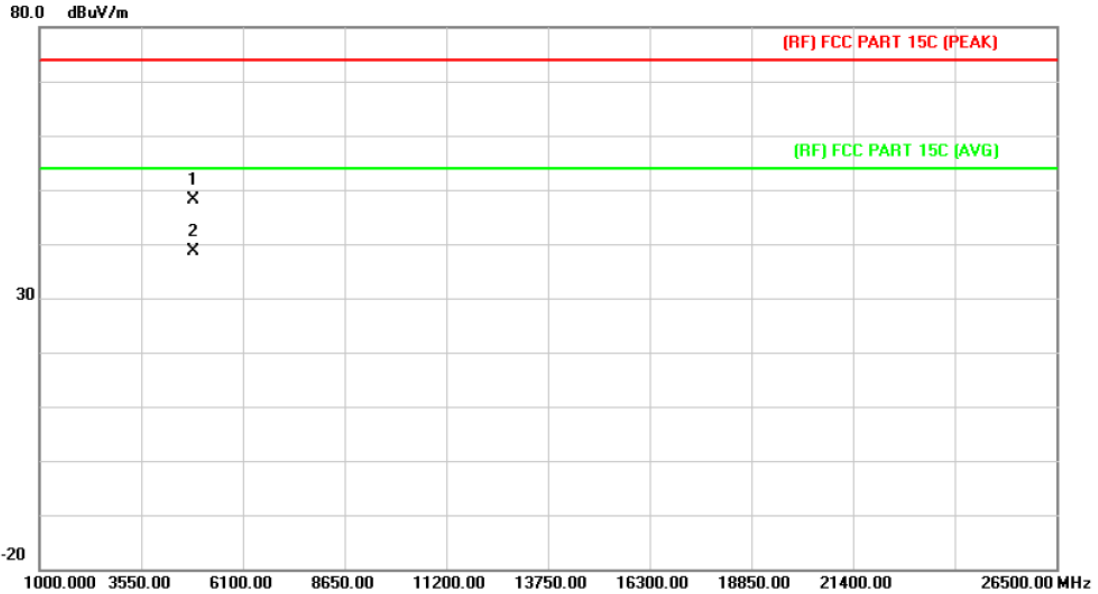

| No. | Mk. | Freq. MHz | Reading Level dBuV | Correct Factor dB/m | Measure- ment dBuV/m | Limit dBuV/m | Over dB | Detector |
|-----|-----|--------------|--------------------------|---------------------------|----------------------------|-----------------|------------|----------|
| 1 | | 4873.958 | 40.01 | 8.21 | 48.22 | 74.00 | -25.78 | peak |
| 2 | * | 4873.958 | 30.44 | 8.21 | 38.65 | 54.00 | -15.35 | AVG |

Emission Level= Read Level+ Correct Factor

| | | | |
|----------------------|---|---------------------------|-----|
| Temperature: | 25 °C | Relative Humidity: | 55% |
| Test Voltage: | AC 120V/60 Hz | | |
| Ant. Pol. | Vertical | | |
| Test Mode: | TX G Mode 2437MHz Main ANT. | | |
| Remark: | No report for the emission which more than 10 dB below the prescribed limit. Only show the worse case Main ANT. | | |

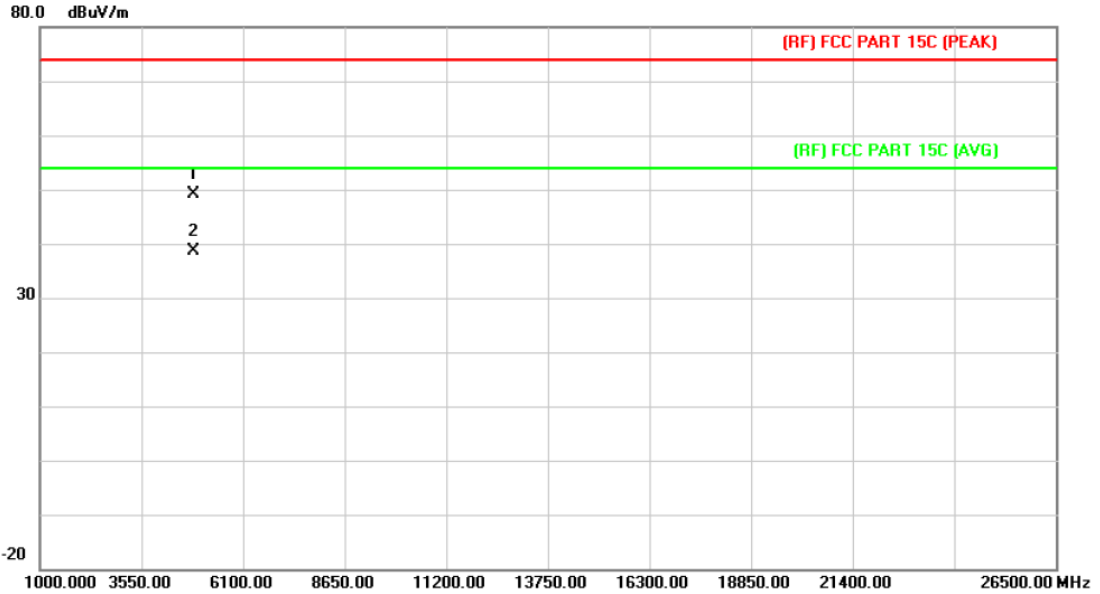

| No. | Mk. | Freq. MHz | Reading Level dBuV | Correct Factor dB/m | Measure- ment dBuV/m | Limit dBuV/m | Over dB | Detector |
|-----|-----|--------------|--------------------------|---------------------------|----------------------------|-----------------|------------|----------|
| 1 | | 4873.972 | 40.99 | 8.21 | 49.20 | 74.00 | -24.80 | peak |
| 2 | * | 4873.972 | 30.36 | 8.21 | 38.57 | 54.00 | -15.43 | AVG |

Emission Level= Read Level+ Correct Factor

| | | | |
|----------------------|---|---------------------------|-----|
| Temperature: | 25 °C | Relative Humidity: | 55% |
| Test Voltage: | AC 120V/60 Hz | | |
| Ant. Pol. | Horizontal | | |
| Test Mode: | TX G Mode 2462MHz Main ANT. | | |
| Remark: | No report for the emission which more than 10 dB below the prescribed limit. Only show the worse case Main ANT. | | |

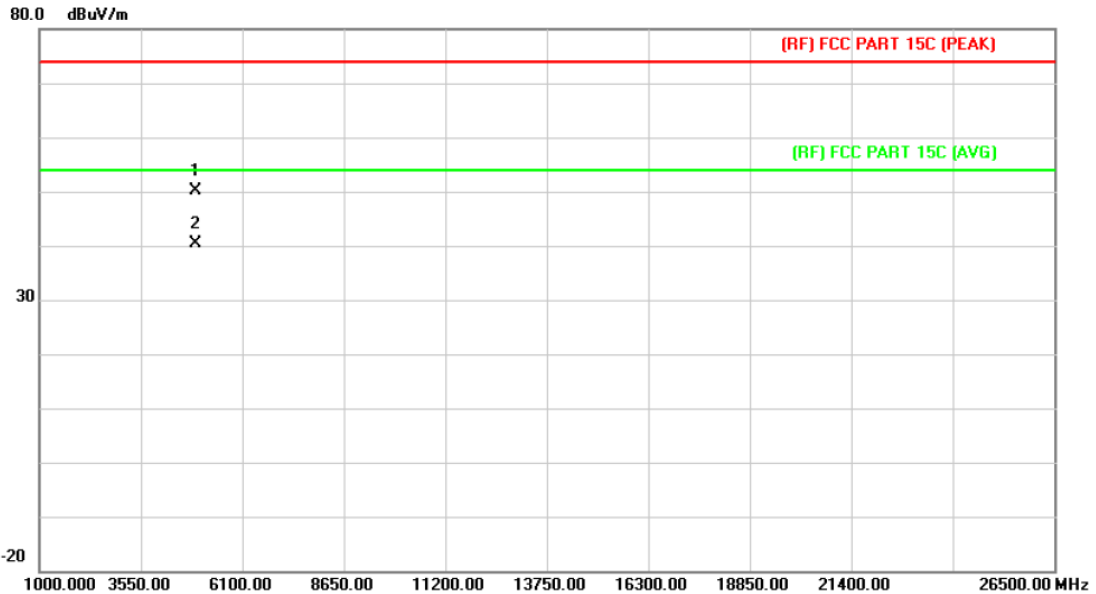

| No. | Mk. | Freq. MHz | Reading Level dBuV | Correct Factor dB/m | Measure- ment dBuV/m | Limit dBuV/m | Over dB | Detector |
|-----|-----|--------------|--------------------------|---------------------------|----------------------------|-----------------|------------|----------|
| 1 | | 4923.968 | 41.88 | 8.22 | 50.10 | 74.00 | -23.90 | peak |
| 2 | * | 4923.968 | 32.04 | 8.22 | 40.26 | 54.00 | -13.74 | AVG |

Emission Level= Read Level+ Correct Factor

| | | | |
|----------------------|---|---------------------------|-----|
| Temperature: | 25 °C | Relative Humidity: | 55% |
| Test Voltage: | AC 120V/60 Hz | | |
| Ant. Pol. | Vertical | | |
| Test Mode: | TX G Mode 2462MHz Main ANT. | | |
| Remark: | No report for the emission which more than 10 dB below the prescribed limit. Only show the worse case Main ANT. | | |

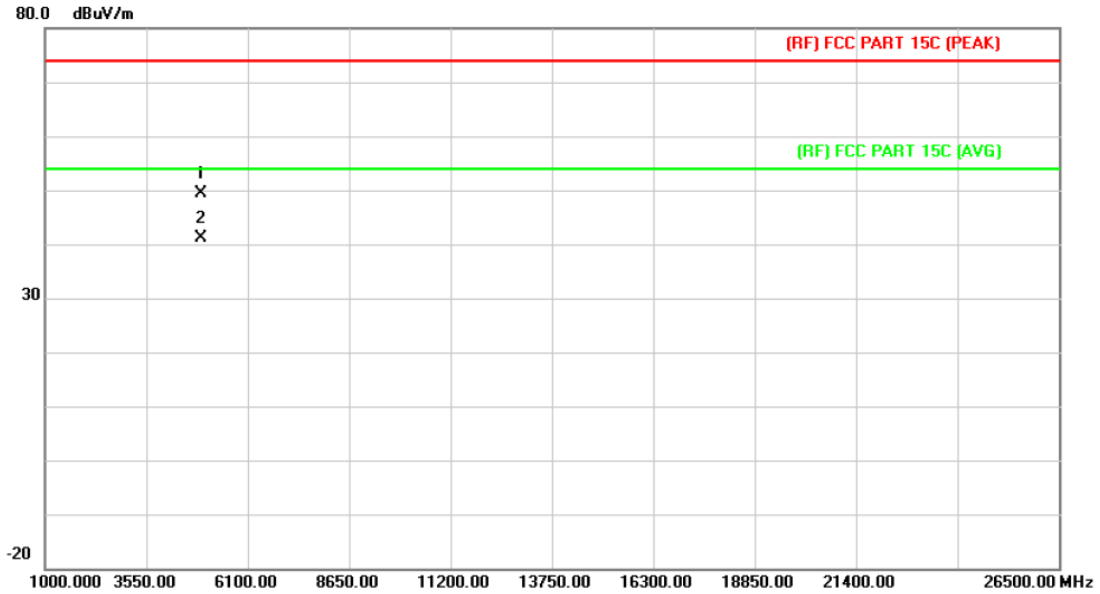

| No. | Mk. | Freq. MHz | Reading Level dBuV | Correct Factor dB/m | Measure- ment dBuV/m | Limit dBuV/m | Over dB | Detector |
|-----|-----|--------------|--------------------------|---------------------------|----------------------------|-----------------|------------|----------|
| 1 | | 4923.968 | 41.23 | 8.22 | 49.45 | 74.00 | -24.55 | peak |
| 2 | * | 4923.968 | 32.81 | 8.22 | 41.03 | 54.00 | -12.97 | AVG |

Emission Level= Read Level+ Correct Factor

| | | | |
|----------------------|--|---------------------------|-----|
| Temperature: | 25 °C | Relative Humidity: | 55% |
| Test Voltage: | AC 120V/60 Hz | | |
| Ant. Pol. | Horizontal | | |
| Test Mode: | TX n(HT20) Mode 2412MHz Main ANT.+AUX ANT. | | |
| Remark: | No report for the emission which more than 10 dB below the prescribed limit. | | |

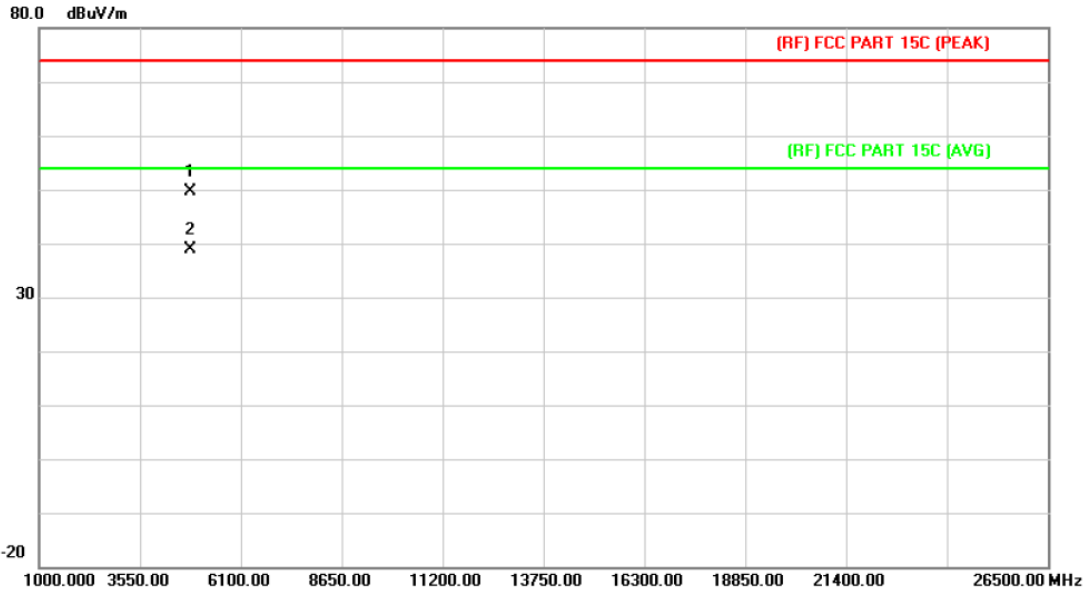

| No. | Mk. | Freq. MHz | Reading Level dBuV | Correct Factor dB/m | Measure- ment dBuV/m | Limit dBuV/m | Over dB | Detector |
|-----|-----|--------------|--------------------------|---------------------------|----------------------------|-----------------|------------|----------|
| 1 | | 4823.978 | 41.41 | 8.19 | 49.60 | 74.00 | -24.40 | peak |
| 2 | * | 4823.978 | 30.79 | 8.19 | 38.98 | 54.00 | -15.02 | AVG |

Emission Level= Read Level+ Correct Factor

| | | | |
|----------------------|--|---------------------------|-----|
| Temperature: | 25 °C | Relative Humidity: | 55% |
| Test Voltage: | AC 120V/60 Hz | | |
| Ant. Pol. | Vertical | | |
| Test Mode: | TX n(HT20) Mode 2412MHz Main ANT.+AUX ANT. | | |
| Remark: | No report for the emission which more than 10 dB below the prescribed limit. | | |

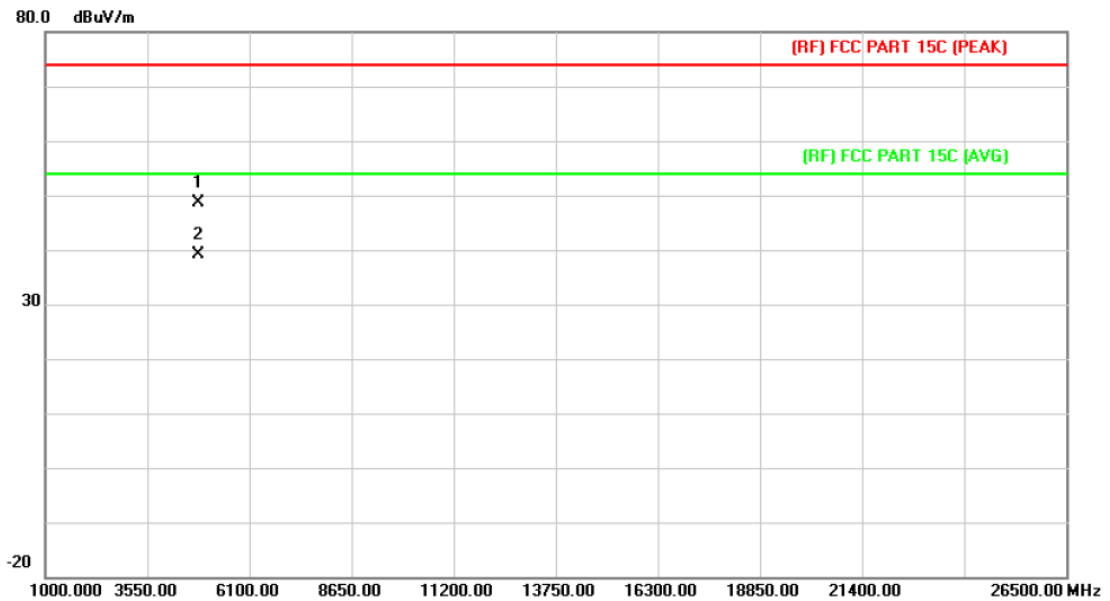

| No. | Mk. | Freq. MHz | Reading Level dBuV | Correct Factor dB/m | Measure- ment dBuV/m | Limit dBuV/m | Over dB | Detector |
|-----|-----|--------------|--------------------------|---------------------------|----------------------------|-----------------|------------|----------|
| 1 | | 4823.984 | 40.37 | 8.19 | 48.56 | 74.00 | -25.44 | peak |
| 2 | * | 4823.984 | 30.85 | 8.19 | 39.04 | 54.00 | -14.96 | AVG |

Emission Level= Read Level+ Correct Factor

| | | | |
|----------------------|--|---------------------------|-----|
| Temperature: | 25 °C | Relative Humidity: | 55% |
| Test Voltage: | AC 120V/60 Hz | | |
| Ant. Pol. | Horizontal | | |
| Test Mode: | TX n(HT20) Mode 2437MHz Main ANT.+AUX ANT. | | |
| Remark: | No report for the emission which more than 10 dB below the prescribed limit. | | |

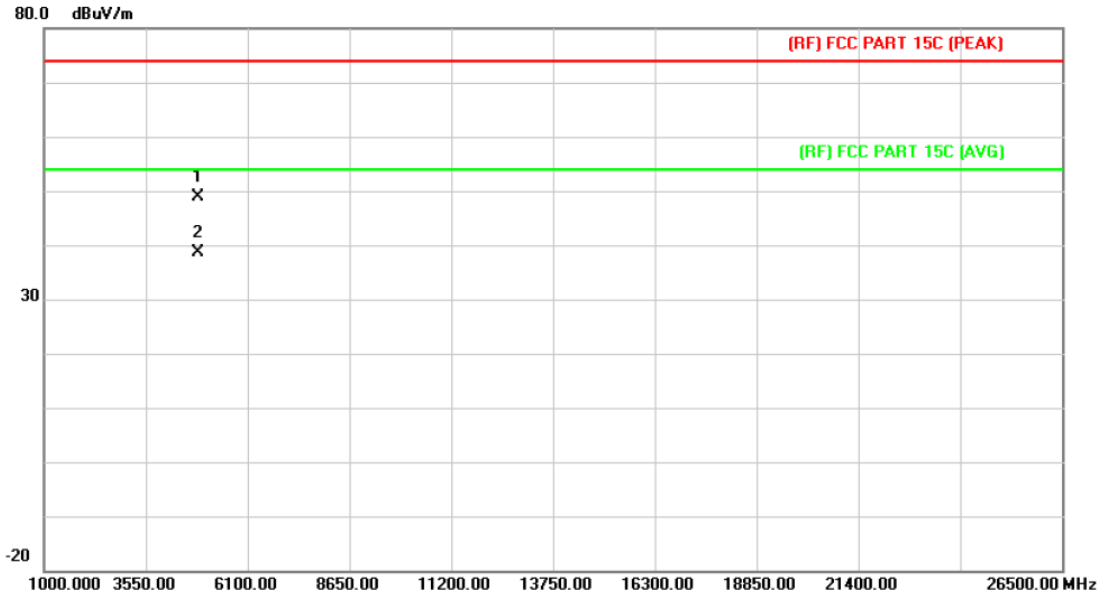

| No. | Mk. | Freq. MHz | Reading Level dBuV | Correct Factor dB/m | Measure- ment dBuV/m | Limit dBuV/m | Over dB | Detector |
|-----|-----|--------------|--------------------------|---------------------------|----------------------------|-----------------|------------|----------|
| 1 | | 4873.966 | 40.69 | 8.21 | 48.90 | 74.00 | -25.10 | peak |
| 2 | * | 4873.966 | 30.46 | 8.21 | 38.67 | 54.00 | -15.33 | AVG |

Emission Level= Read Level+ Correct Factor

| | | | |
|----------------------|--|---------------------------|-----|
| Temperature: | 25 °C | Relative Humidity: | 55% |
| Test Voltage: | AC 120V/60 Hz | | |
| Ant. Pol. | Vertical | | |
| Test Mode: | TX n(HT20) Mode 2437MHz Main ANT.+AUX ANT. | | |
| Remark: | No report for the emission which more than 10 dB below the prescribed limit. | | |

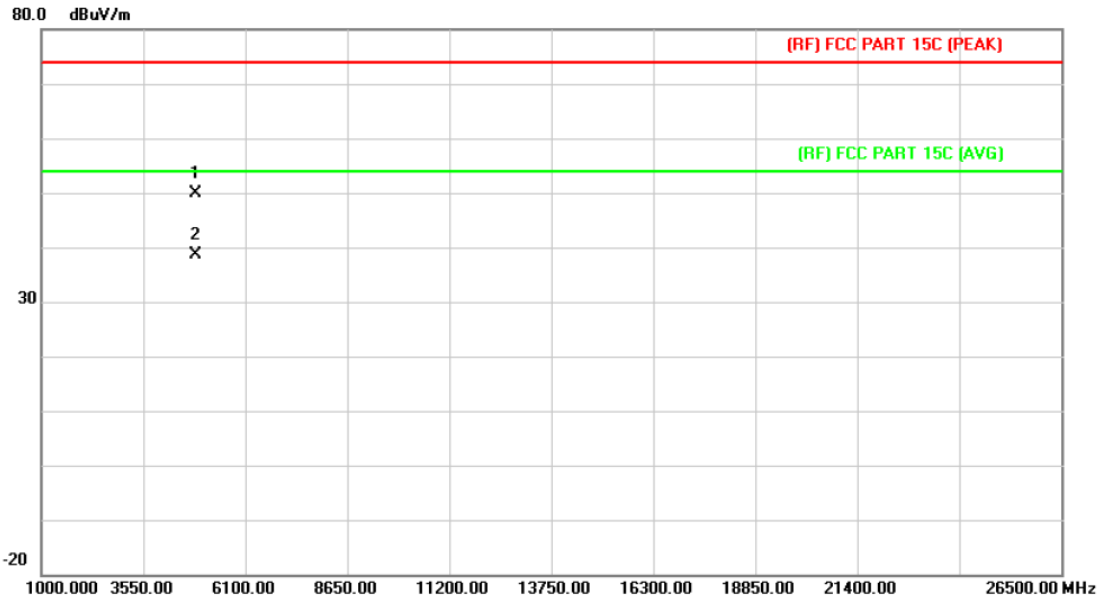

| No. | Mk. | Freq. MHz | Reading Level dBuV | Correct Factor dB/m | Measure- ment dBuV/m | Limit dBuV/m | Over dB | Detector |
|-----|-----|--------------|--------------------------|---------------------------|----------------------------|-----------------|------------|----------|
| 1 | | 4873.976 | 41.65 | 8.21 | 49.86 | 74.00 | -24.14 | peak |
| 2 | * | 4873.976 | 30.37 | 8.21 | 38.58 | 54.00 | -15.42 | AVG |

Emission Level= Read Level+ Correct Factor

| | | | |
|----------------------|--|---------------------------|-----|
| Temperature: | 25 °C | Relative Humidity: | 55% |
| Test Voltage: | AC 120V/60 Hz | | |
| Ant. Pol. | Horizontal | | |
| Test Mode: | TX n(HT20) Mode 2462MHz Main ANT.+AUX ANT. | | |
| Remark: | No report for the emission which more than 10 dB below the prescribed limit. | | |

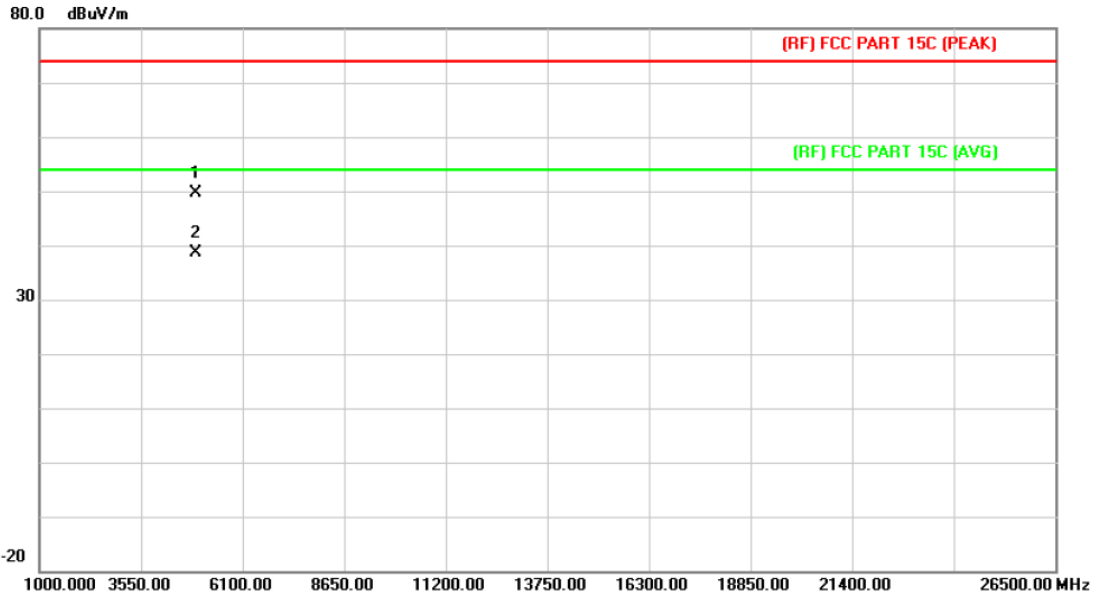

| No. | Mk. | Freq. MHz | Reading Level dBuV | Correct Factor dB/m | Measure- ment dBuV/m | Limit dBuV/m | Over dB | Detector |
|-----|-----|--------------|--------------------------|---------------------------|----------------------------|-----------------|------------|----------|
| 1 | | 4923.976 | 41.43 | 8.22 | 49.65 | 74.00 | -24.35 | peak |
| 2 | * | 4923.976 | 30.43 | 8.22 | 38.65 | 54.00 | -15.35 | AVG |

Emission Level= Read Level+ Correct Factor

| | | | |
|----------------------|--|---------------------------|-----|
| Temperature: | 25 °C | Relative Humidity: | 55% |
| Test Voltage: | AC 120V/60 Hz | | |
| Ant. Pol. | Vertical | | |
| Test Mode: | TX n(HT20) Mode 2462MHz Main ANT.+AUX ANT. | | |
| Remark: | No report for the emission which more than 10 dB below the prescribed limit. | | |

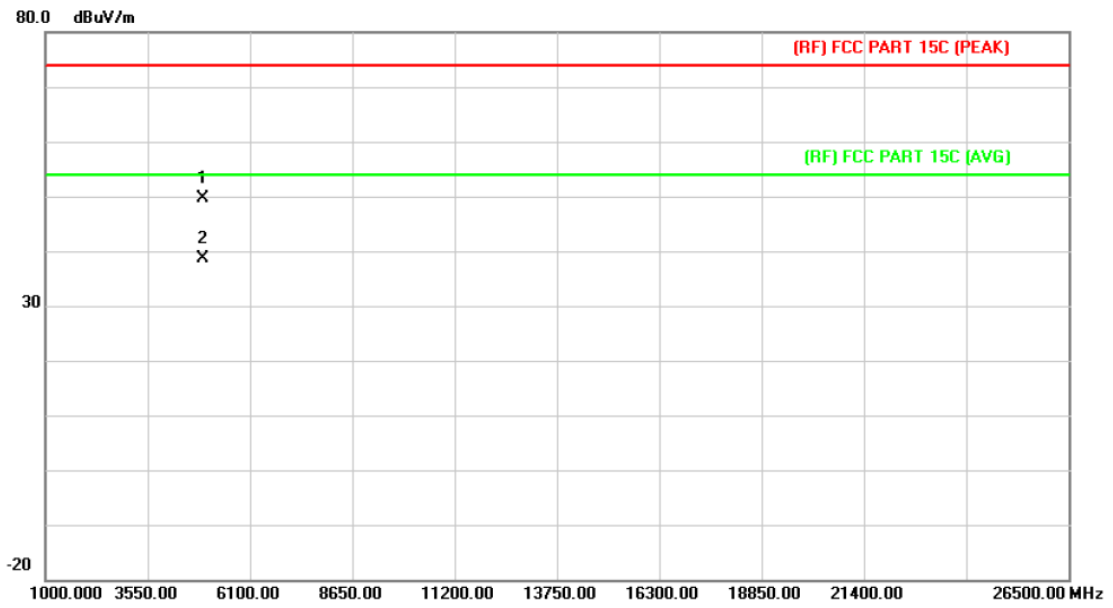

| No. | Mk. | Freq. MHz | Reading Level dBuV | Correct Factor dB/m | Measure- ment dBuV/m | Limit dBuV/m | Over dB | Detector |
|-----|-----|--------------|--------------------------|---------------------------|----------------------------|-----------------|------------|----------|
| 1 | | 4923.976 | 41.46 | 8.22 | 49.68 | 74.00 | -24.32 | peak |
| 2 | * | 4923.976 | 30.43 | 8.22 | 38.65 | 54.00 | -15.35 | AVG |

Emission Level= Read Level+ Correct Factor

| | | | |
|----------------------|--|---------------------------|-----|
| Temperature: | 25 °C | Relative Humidity: | 55% |
| Test Voltage: | AC 120V/60 Hz | | |
| Ant. Pol. | Horizontal | | |
| Test Mode: | TX n(HT40) Mode 2422MHz Main ANT.+AUX ANT. | | |
| Remark: | No report for the emission which more than 10 dB below the prescribed limit. | | |

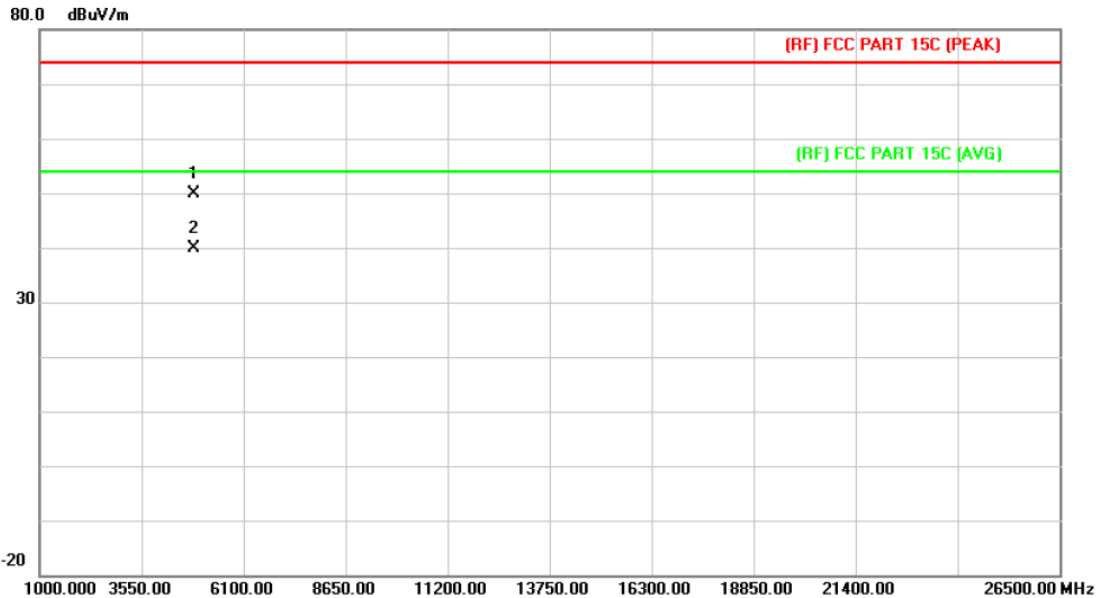

| No. | Mk. | Freq. MHz | Reading Level dBuV | Correct Factor dB/m | Measure- ment dBuV/m | Limit dBuV/m | Over dB | Detector |
|-----|-----|--------------|--------------------------|---------------------------|----------------------------|-----------------|------------|----------|
| 1 | | 4843.968 | 41.68 | 8.20 | 49.88 | 74.00 | -24.12 | peak |
| 2 | * | 4843.968 | 31.75 | 8.20 | 39.95 | 54.00 | -14.05 | AVG |

Emission Level= Read Level+ Correct Factor

| | | | |
|----------------------|--|---------------------------|-----|
| Temperature: | 25 °C | Relative Humidity: | 55% |
| Test Voltage: | AC 120V/60 Hz | | |
| Ant. Pol. | Vertical | | |
| Test Mode: | TX n(HT40) Mode 2422MHz Main ANT.+AUX ANT. | | |
| Remark: | No report for the emission which more than 10 dB below the prescribed limit. | | |

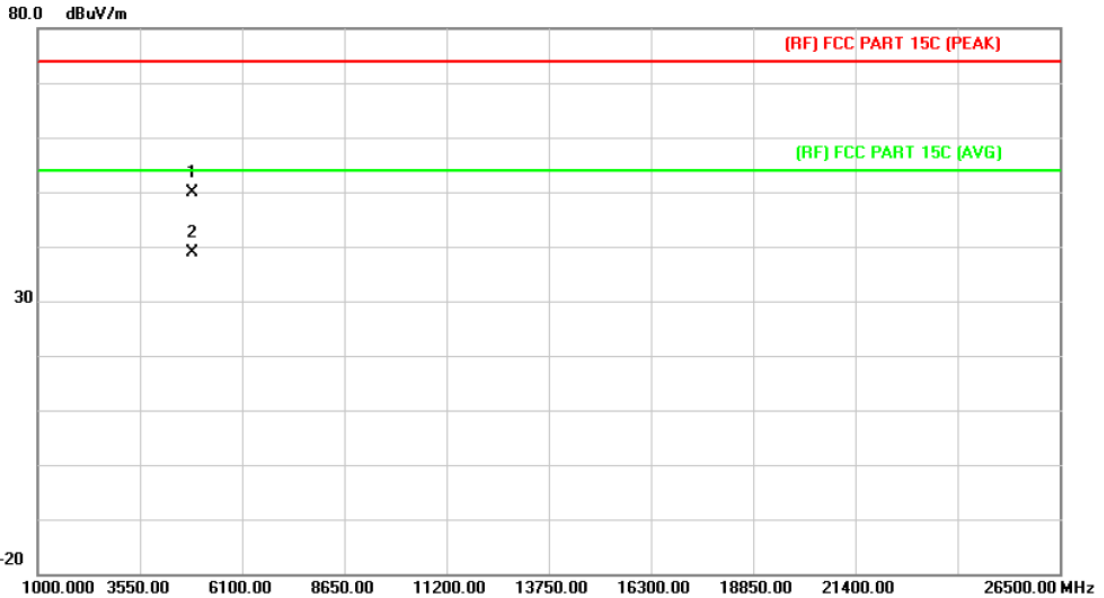

| No. | Mk. | Freq. MHz | Reading Level dBuV | Correct Factor dB/m | Measure- ment dBuV/m | Limit dBuV/m | Over dB | Detector |
|-----|-----|--------------|--------------------------|---------------------------|----------------------------|-----------------|------------|----------|
| 1 | | 4843.967 | 41.67 | 8.20 | 49.87 | 74.00 | -24.13 | peak |
| 2 | * | 4843.967 | 30.69 | 8.20 | 38.89 | 54.00 | -15.11 | AVG |

Emission Level= Read Level+ Correct Factor

| | | | |
|----------------------|--|---------------------------|-----|
| Temperature: | 25 °C | Relative Humidity: | 55% |
| Test Voltage: | AC 120V/60 Hz | | |
| Ant. Pol. | Horizontal | | |
| Test Mode: | TX n(HT40) Mode 2437MHz Main ANT.+AUX ANT. | | |
| Remark: | No report for the emission which more than 10 dB below the prescribed limit. | | |

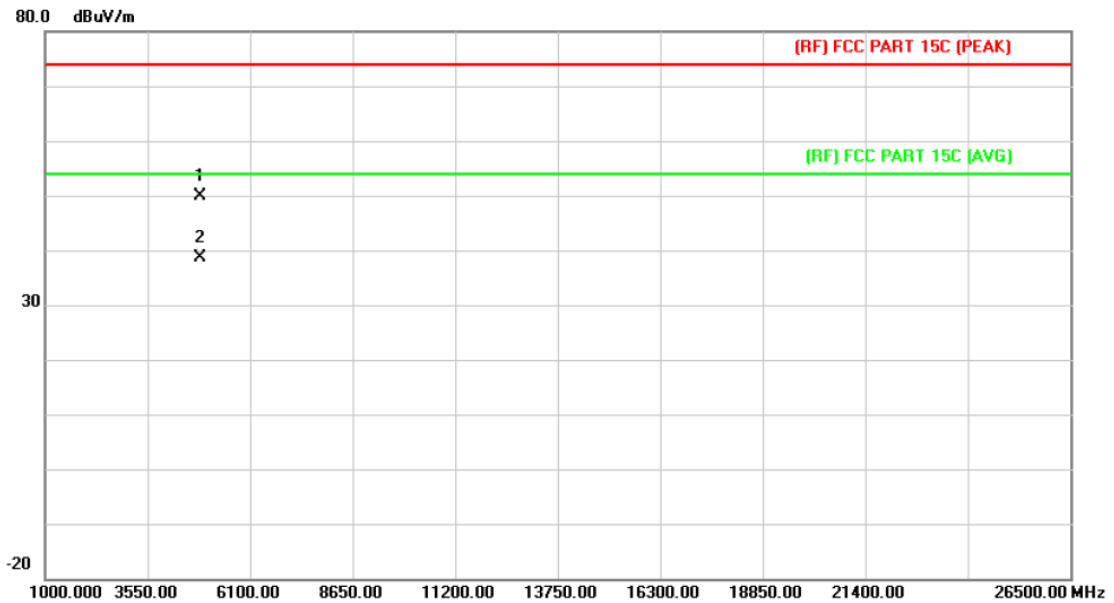

| No. | Mk. | Freq. MHz | Reading Level dBuV | Correct Factor dB/m | Measure- ment dBuV/m | Limit dBuV/m | Over dB | Detector |
|-----|-----|--------------|--------------------------|---------------------------|----------------------------|-----------------|------------|----------|
| 1 | | 4873.968 | 41.57 | 8.21 | 49.78 | 74.00 | -24.22 | peak |
| 2 | * | 4873.968 | 30.44 | 8.21 | 38.65 | 54.00 | -15.35 | AVG |

Emission Level= Read Level+ Correct Factor

| | | | |
|----------------------|--|---------------------------|-----|
| Temperature: | 25 °C | Relative Humidity: | 55% |
| Test Voltage: | AC 120V/60 Hz | | |
| Ant. Pol. | Vertical | | |
| Test Mode: | TX n(HT40) Mode 2437MHz Main ANT.+AUX ANT. | | |
| Remark: | No report for the emission which more than 10 dB below the prescribed limit. | | |

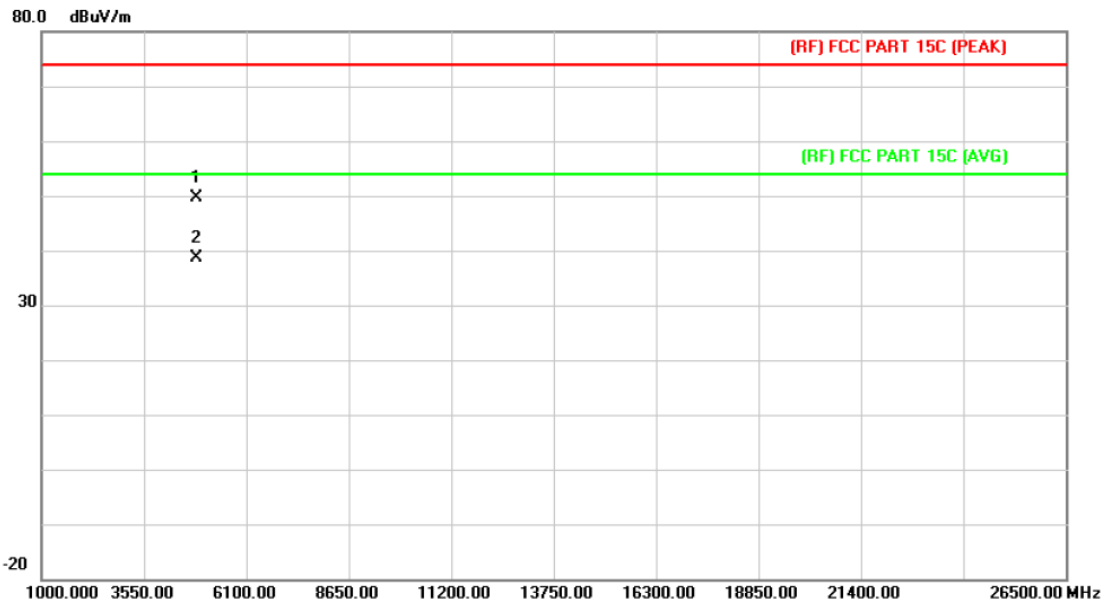

| No. | Mk. | Freq. MHz | Reading Level dBuV | Correct Factor dB/m | Measure- ment dBuV/m | Limit dBuV/m | Over dB | Detector |
|-----|-----|--------------|--------------------------|---------------------------|----------------------------|-----------------|------------|----------|
| 1 | | 4873.968 | 41.47 | 8.21 | 49.68 | 74.00 | -24.32 | peak |
| 2 | * | 4873.968 | 30.48 | 8.21 | 38.69 | 54.00 | -15.31 | AVG |

Emission Level= Read Level+ Correct Factor

| | | | |
|----------------------|--|---------------------------|-----|
| Temperature: | 25 °C | Relative Humidity: | 55% |
| Test Voltage: | AC 120V/60 Hz | | |
| Ant. Pol. | Horizontal | | |
| Test Mode: | TX n(HT40) Mode 2462MHz Main ANT.+AUX ANT. | | |
| Remark: | No report for the emission which more than 10 dB below the prescribed limit. | | |

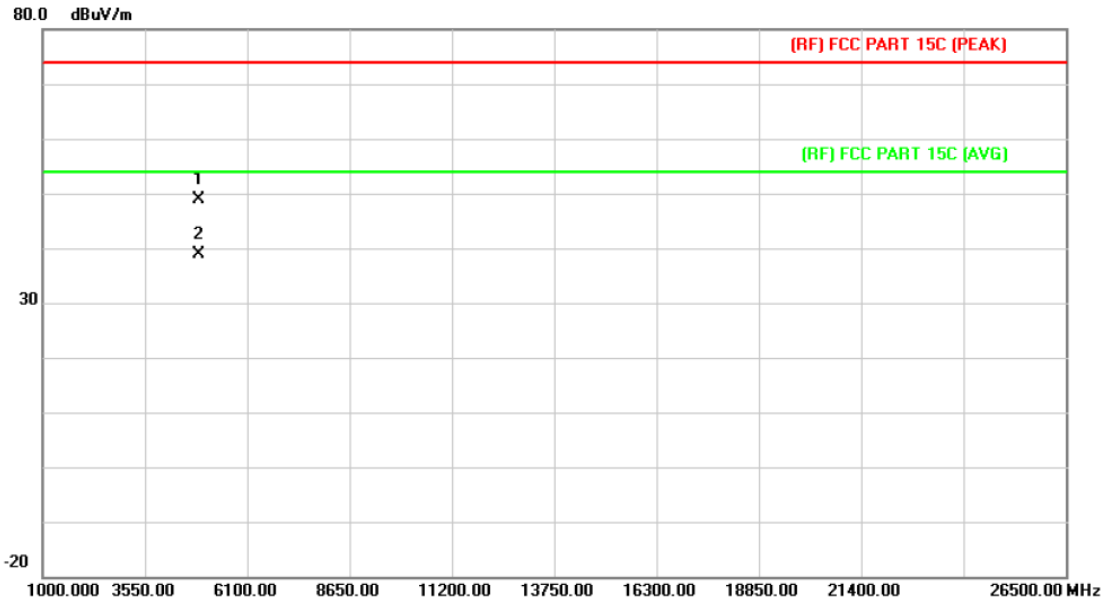

| No. | Mk. | Freq. MHz | Reading Level dBuV | Correct Factor dB/m | Measure- ment dBuV/m | Limit dBuV/m | Over dB | Detector |
|-----|-----|--------------|--------------------------|---------------------------|----------------------------|-----------------|------------|----------|
| 1 | | 4903.968 | 40.74 | 8.21 | 48.95 | 74.00 | -25.05 | peak |
| 2 | * | 4903.968 | 30.74 | 8.21 | 38.95 | 54.00 | -15.05 | AVG |

Emission Level= Read Level+ Correct Factor

| | | | |
|----------------------|--|---------------------------|-----|
| Temperature: | 25 °C | Relative Humidity: | 55% |
| Test Voltage: | AC 120V/60 Hz | | |
| Ant. Pol. | Vertical | | |
| Test Mode: | TX n(HT40) Mode 2462MHz Main ANT.+AUX ANT. | | |
| Remark: | No report for the emission which more than 10 dB below the prescribed limit. | | |

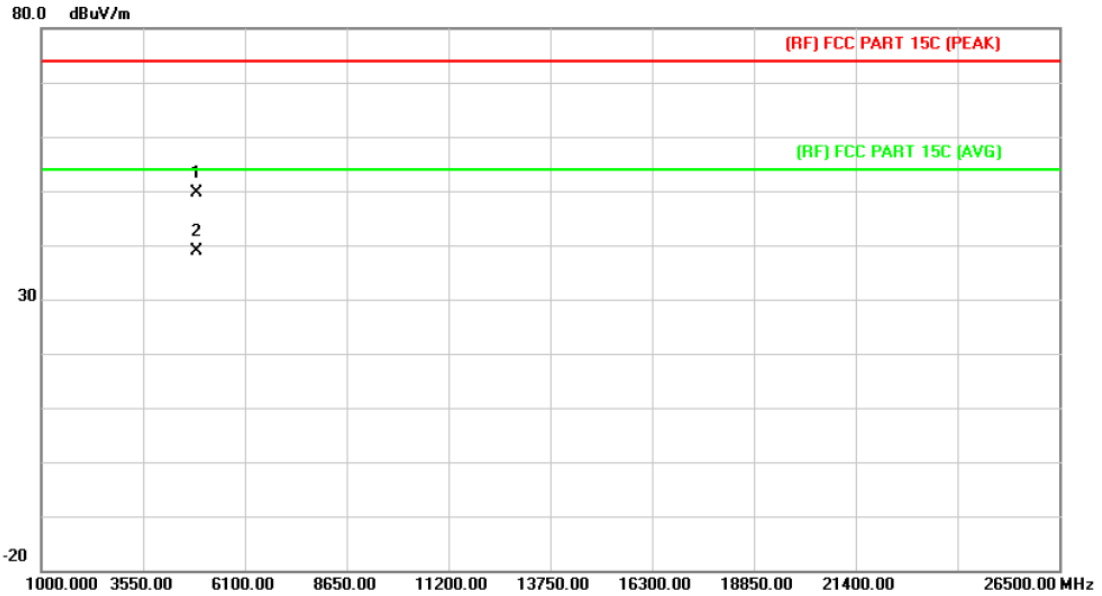

| No. | Mk. | Freq. MHz | Reading Level dBuV | Correct Factor dB/m | Measure- ment dBuV/m | Limit dBuV/m | Over dB | Detector |
|-----|-----|--------------|--------------------------|---------------------------|----------------------------|-----------------|------------|----------|
| 1 | | 4903.968 | 41.51 | 8.21 | 49.72 | 74.00 | -24.28 | peak |
| 2 | * | 4903.968 | 30.64 | 8.21 | 38.85 | 54.00 | -15.15 | AVG |

Emission Level= Read Level+ Correct Factor

Attachment C-- Restricted Bands Requirement and Band-edge Test Data

(1) Radiation Test

| | | | |
|---------------|------------------------------------|--------------------|-----|
| Temperature: | 25 °C | Relative Humidity: | 55% |
| Test Voltage: | AC 120V/60HZ | | |
| Ant. Pol. | Horizontal | | |
| Test Mode: | TX B Mode 2412MHz Main ANT. | | |
| Remark: | Only show the worse case Main ANT. | | |

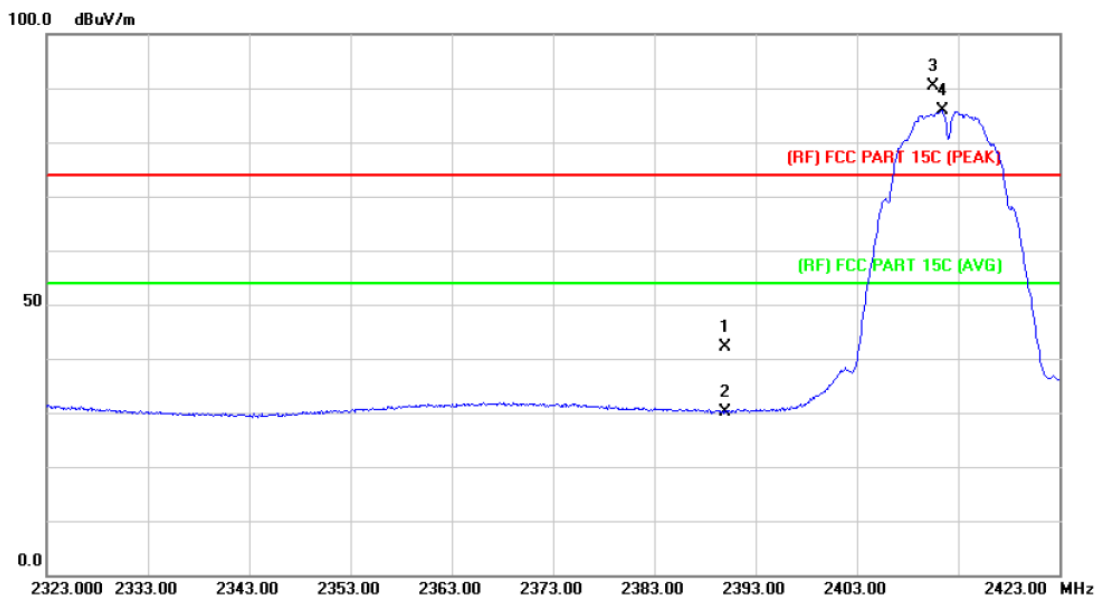

| No. | Mk. | Freq. MHz | Reading Level dBuV | Correct Factor dB/m | Measure- ment dBuV/m | Limit dBuV/m | Over dB | Detector |
|-----|-----|--------------|--------------------------|---------------------------|----------------------------|-----------------------|------------|----------|
| 1 | | 2390.000 | 41.36 | 0.77 | 42.13 | 74.00 | -31.87 | peak |
| 2 | | 2390.000 | 29.41 | 0.77 | 30.18 | 54.00 | -23.82 | AVG |
| 3 | X | 2410.600 | 89.44 | 0.86 | 90.30 | Fundamental Frequency | | peak |
| 4 | * | 2411.400 | 84.93 | 0.86 | 85.79 | Fundamental Frequency | | AVG |

Emission Level= Read Level+ Correct Factor

| | | | |
|----------------------|------------------------------------|---------------------------|-----|
| Temperature: | 25 °C | Relative Humidity: | 55% |
| Test Voltage: | AC 120V/60HZ | | |
| Ant. Pol. | Vertical | | |
| Test Mode: | TX B Mode 2412MHz Main ANT. | | |
| Remark: | Only show the worse case Main ANT. | | |

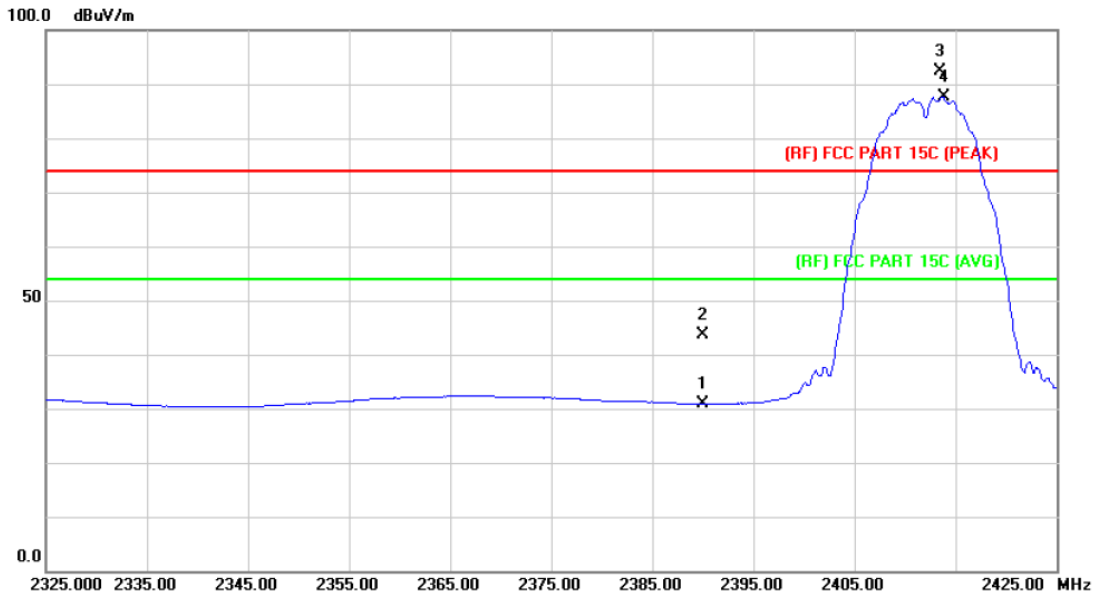

| No. | Mk. | Freq. MHz | Reading Level dBuV | Correct Factor dB/m | Measure- ment dBuV/m | Limit dBuV/m | Over dB | Detector |
|-----|-----|--------------|--------------------------|---------------------------|----------------------------|-----------------------|------------|----------|
| 1 | | 2390.000 | 30.00 | 0.77 | 30.77 | 54.00 | -23.23 | AVG |
| 2 | | 2390.000 | 42.78 | 0.77 | 43.55 | 54.00 | -10.45 | AVG |
| 3 | X | 2413.400 | 91.44 | 0.86 | 92.30 | Fundamental Frequency | | peak |
| 4 | * | 2413.800 | 86.78 | 0.86 | 87.64 | Fundamental Frequency | | AVG |

Emission Level= Read Level+ Correct Factor

| | | | |
|----------------------|------------------------------------|---------------------------|-----|
| Temperature: | 25 °C | Relative Humidity: | 55% |
| Test Voltage: | AC 120V/60HZ | | |
| Ant. Pol. | Horizontal | | |
| Test Mode: | TX B Mode 2462MHz Main ANT. | | |
| Remark: | Only show the worse case Main ANT. | | |

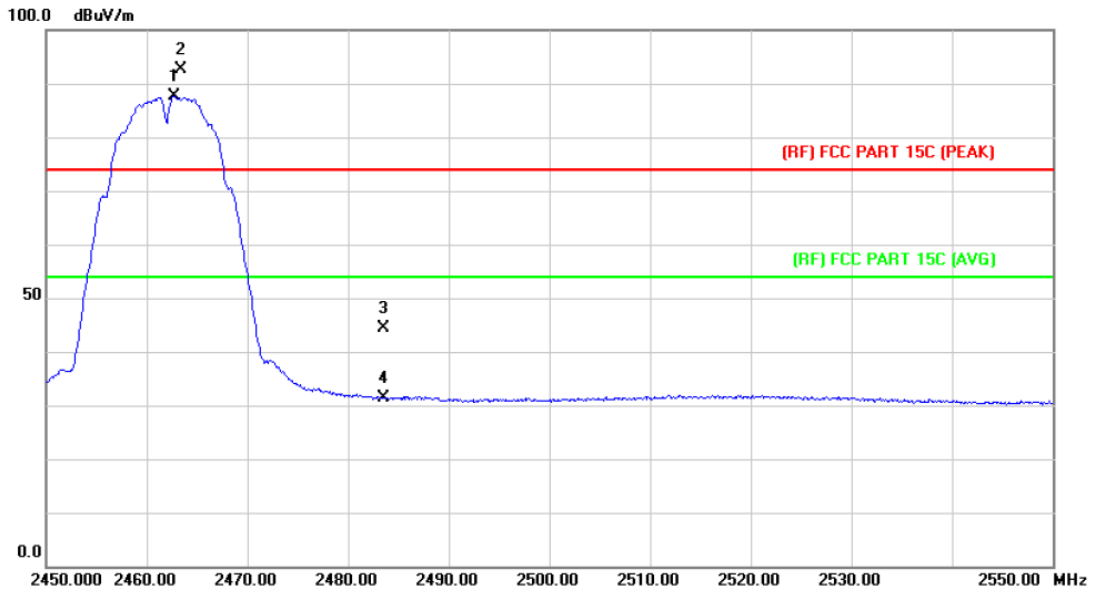

| No. | Mk. | Freq. MHz | Reading Level dBuV | Correct Factor dB/m | Measure- ment dBuV/m | Limit dBuV/m | Over dB | Detector |
|-----|-----|--------------|--------------------------|---------------------------|----------------------------|-----------------------|------------|----------|
| 1 | * | 2462.700 | 86.62 | 1.08 | 87.70 | Fundamental Frequency | | AVG |
| 2 | X | 2463.400 | 91.48 | 1.08 | 92.56 | Fundamental Frequency | | peak |
| 3 | | 2483.500 | 43.10 | 1.17 | 44.27 | 74.00 | -29.73 | peak |
| 4 | | 2483.500 | 30.26 | 1.17 | 31.43 | 54.00 | -22.57 | AVG |

Emission Level= Read Level+ Correct Factor

| | | | |
|----------------------|------------------------------------|---------------------------|-----|
| Temperature: | 25 °C | Relative Humidity: | 55% |
| Test Voltage: | AC 120V/60HZ | | |
| Ant. Pol. | Vertical | | |
| Test Mode: | TX B Mode 2462MHz Main ANT. | | |
| Remark: | Only show the worse case Main ANT. | | |

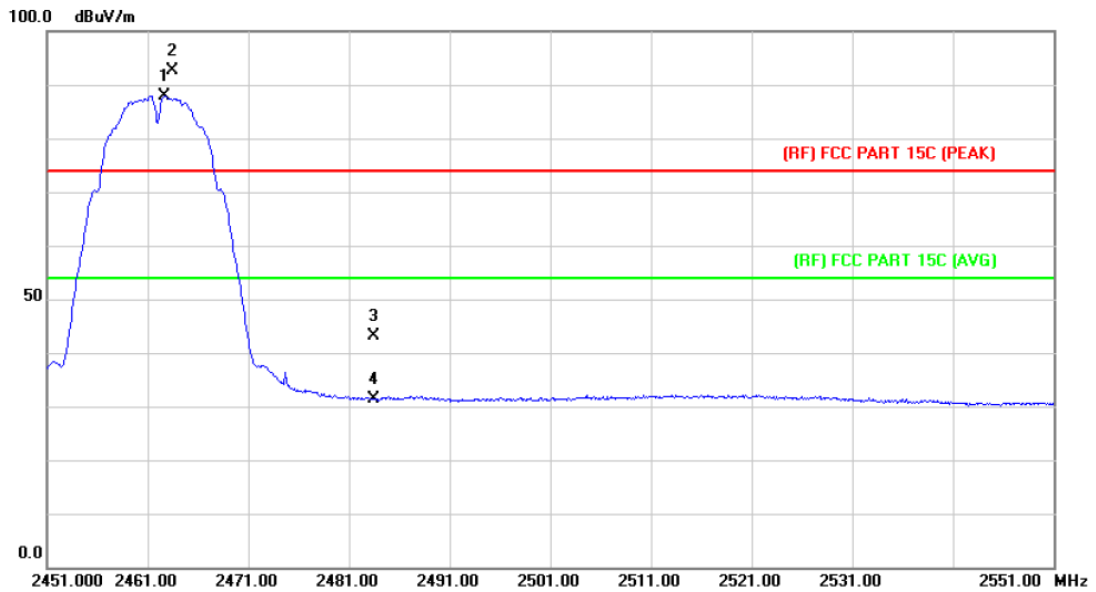

| No. | Mk. | Freq. MHz | Reading Level dBuV | Correct Factor dB/m | Measure- ment dBuV/m | Limit dBuV/m | Over dB | Detector |
|-----|-----|--------------|--------------------------|---------------------------|----------------------------|-----------------------|------------|----------|
| 1 | * | 2462.700 | 86.84 | 1.08 | 87.92 | Fundamental Frequency | | AVG |
| 2 | X | 2463.400 | 91.55 | 1.08 | 92.63 | Fundamental Frequency | | peak |
| 3 | | 2483.500 | 41.91 | 1.17 | 43.08 | 74.00 | -30.92 | peak |
| 4 | | 2483.500 | 30.23 | 1.17 | 31.40 | 54.00 | -22.60 | AVG |

Emission Level= Read Level+ Correct Factor

| | | | |
|----------------------|------------------------------------|---------------------------|-----|
| Temperature: | 25 °C | Relative Humidity: | 55% |
| Test Voltage: | AC 120V/60HZ | | |
| Ant. Pol. | Horizontal | | |
| Test Mode: | TX G Mode 2412MHz Main ANT. | | |
| Remark: | Only show the worse case Main ANT. | | |

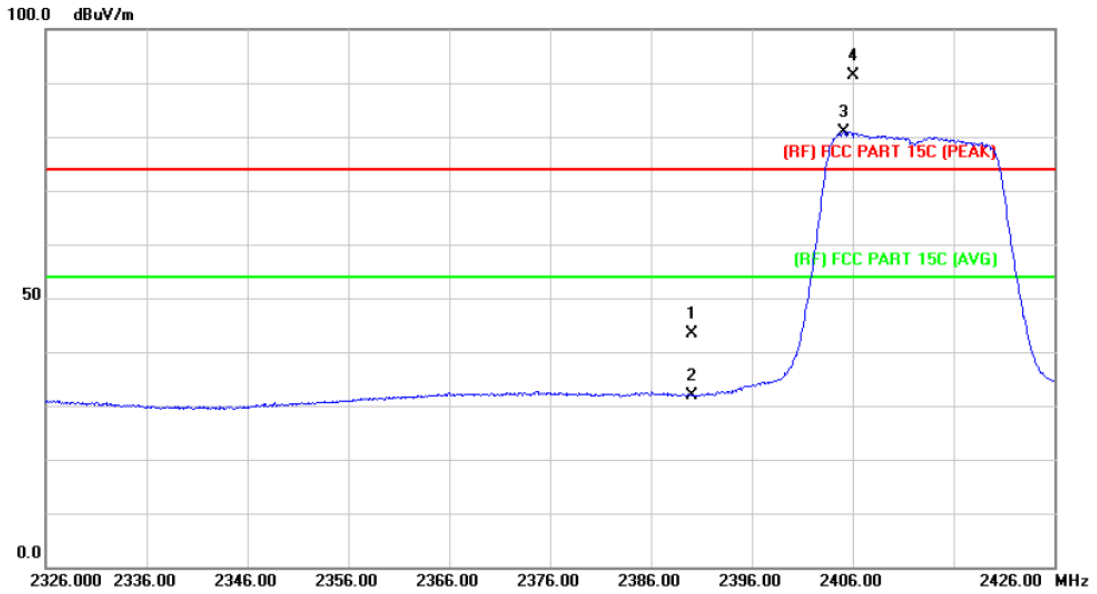

| No. | Mk. | Freq. MHz | Reading Level dBuV | Correct Factor dB/m | Measure- ment dBuV/m | Limit dBuV/m | Over dB | Detector |
|-----|-----|--------------|--------------------------|---------------------------|----------------------------|-----------------------|------------|----------|
| 1 | | 2390.000 | 42.55 | 0.77 | 43.32 | 74.00 | -30.68 | peak |
| 2 | | 2390.000 | 31.12 | 0.77 | 31.89 | 54.00 | -22.11 | AVG |
| 3 | * | 2405.200 | 79.99 | 0.84 | 80.83 | Fundamental Frequency | | AVG |
| 4 | X | 2406.100 | 90.42 | 0.84 | 91.26 | Fundamental Frequency | | peak |

Emission Level= Read Level+ Correct Factor

| | | | |
|----------------------|------------------------------------|---------------------------|-----|
| Temperature: | 25 °C | Relative Humidity: | 55% |
| Test Voltage: | AC 120V/60HZ | | |
| Ant. Pol. | Vertical | | |
| Test Mode: | TX G Mode 2412MHz Main ANT. | | |
| Remark: | Only show the worse case Main ANT. | | |

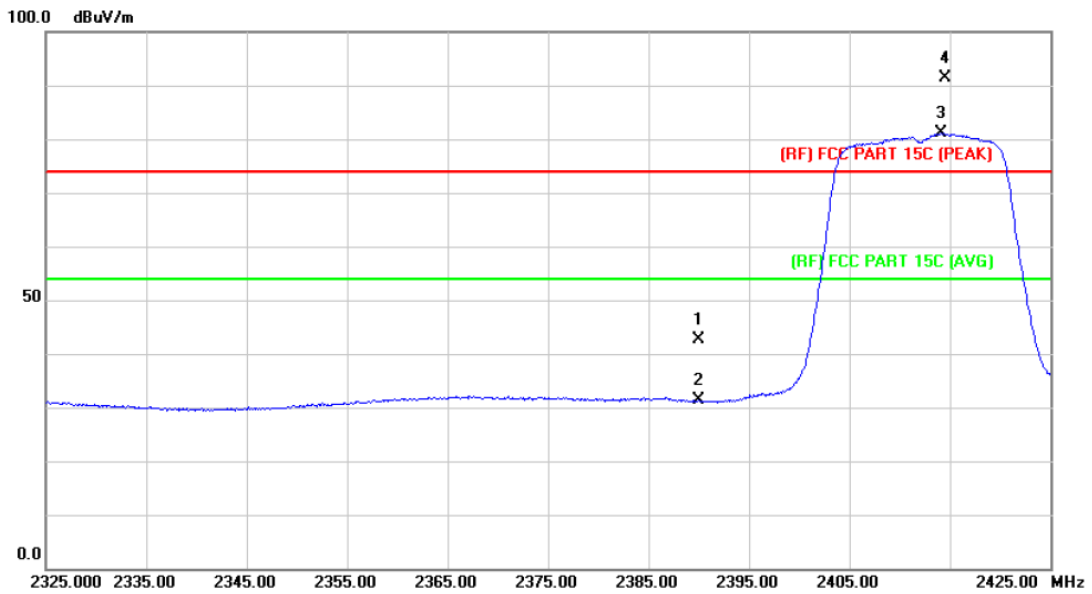

| No. | Mk. | Freq. MHz | Reading Level dBuV | Correct Factor dB/m | Measure- ment dBuV/m | Limit dBuV/m | Over dB | Detector |
|-----|-----|--------------|--------------------------|---------------------------|----------------------------|-----------------------|------------|----------|
| 1 | | 2390.000 | 41.83 | 0.77 | 42.60 | 74.00 | -31.40 | peak |
| 2 | | 2390.000 | 30.55 | 0.77 | 31.32 | 54.00 | -22.68 | AVG |
| 3 | * | 2414.100 | 80.22 | 0.87 | 81.09 | Fundamental Frequency | | AVG |
| 4 | X | 2414.500 | 90.45 | 0.88 | 91.33 | Fundamental Frequency | | peak |

Emission Level= Read Level+ Correct Factor

| | | | |
|----------------------|------------------------------------|---------------------------|-----|
| Temperature: | 25 °C | Relative Humidity: | 55% |
| Test Voltage: | AC 120V/60HZ | | |
| Ant. Pol. | Horizontal | | |
| Test Mode: | TX G Mode 2462MHz Main ANT. | | |
| Remark: | Only show the worse case Main ANT. | | |

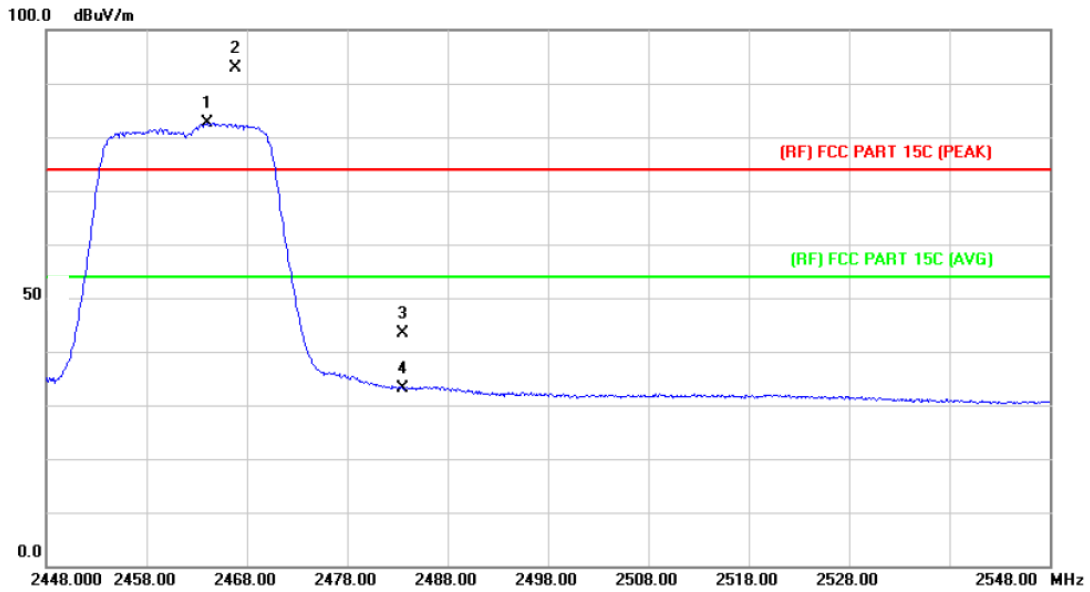

| No. | Mk. | Freq. MHz | Reading Level dBuV | Correct Factor dB/m | Measure- ment dBuV/m | Limit dBuV/m | Over dB | Detector |
|-----|-----|--------------|--------------------------|---------------------------|----------------------------|-----------------------|------------|----------|
| 1 | * | 2464.000 | 81.47 | 1.08 | 82.55 | Fundamental Frequency | | AVG |
| 2 | X | 2466.800 | 91.89 | 1.10 | 92.99 | Fundamental Frequency | | peak |
| 3 | | 2483.500 | 42.30 | 1.17 | 43.47 | 74.00 | -30.53 | peak |
| 4 | | 2483.500 | 31.85 | 1.17 | 33.02 | 54.00 | -20.98 | AVG |

Emission Level= Read Level+ Correct Factor

| | | | |
|----------------------|------------------------------------|---------------------------|-----|
| Temperature: | 25 °C | Relative Humidity: | 55% |
| Test Voltage: | AC 120V/60HZ | | |
| Ant. Pol. | Vertical | | |
| Test Mode: | TX G Mode 2462MHz Main ANT. | | |
| Remark: | Only show the worse case Main ANT. | | |

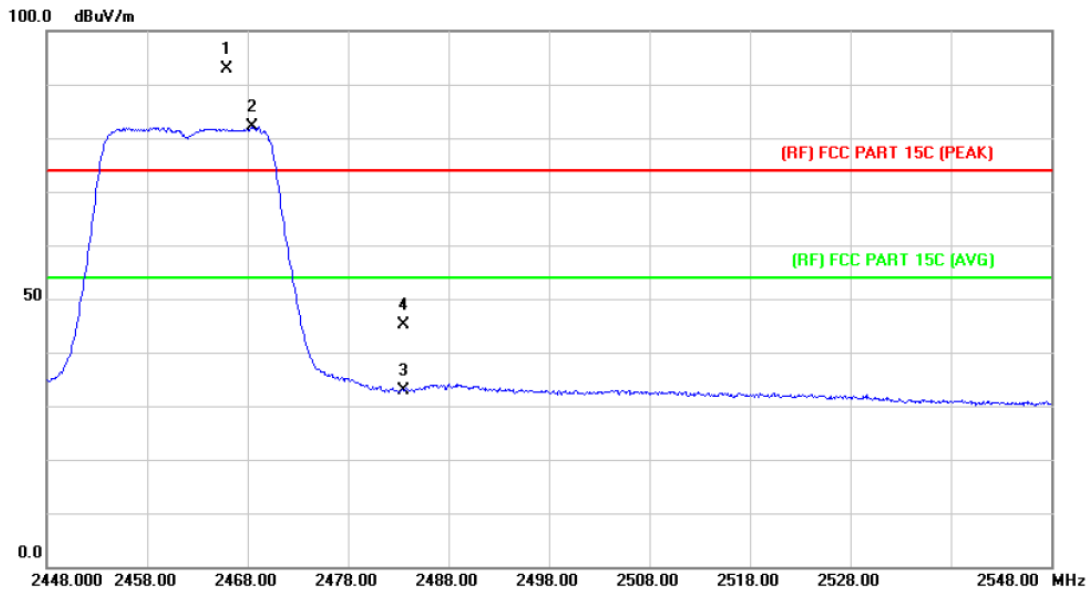

| No. | Mk. | Freq. MHz | Reading Level dBuV | Correct Factor dB/m | Measure- ment dBuV/m | Limit dBuV/m | Over dB | Detector |
|-----|-----|--------------|--------------------------|---------------------------|----------------------------|-----------------------|------------|----------|
| 1 | X | 2465.900 | 91.87 | 1.09 | 92.96 | Fundamental Frequency | | peak |
| 2 | * | 2468.500 | 80.91 | 1.11 | 82.02 | Fundamental Frequency | | AVG |
| 3 | | 2483.500 | 31.74 | 1.17 | 32.91 | 54.00 | -21.09 | AVG |
| 4 | | 2483.500 | 43.95 | 1.17 | 45.12 | 74.00 | -28.88 | peak |

Emission Level= Read Level+ Correct Factor

| | | | |
|----------------------|--|---------------------------|-----|
| Temperature: | 25 °C | Relative Humidity: | 55% |
| Test Voltage: | AC 120V/60HZ | | |
| Ant. Pol. | Horizontal | | |
| Test Mode: | TX N(HT20) Mode 2412MHz Main ANT.+Aux ANT. | | |
| Remark: | N/A | | |

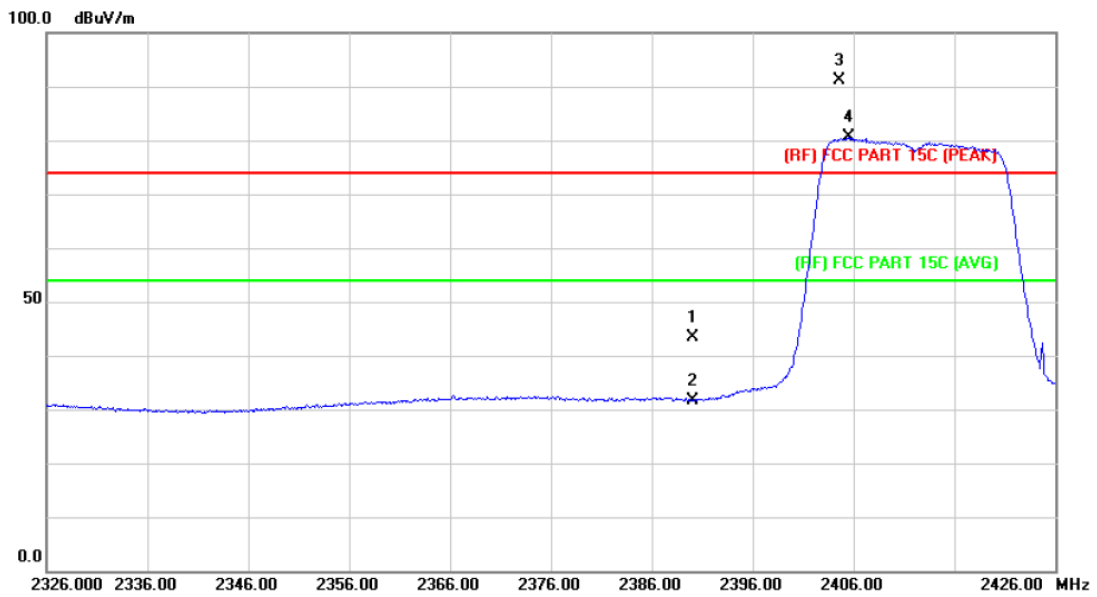

| No. | Mk. | Freq. MHz | Reading Level dBuV | Correct Factor dB/m | Measure- ment dBuV/m | Limit dBuV/m | Over dB | Detector |
|-----|-----|--------------|--------------------------|---------------------------|----------------------------|-----------------------|------------|----------|
| 1 | | 2390.000 | 42.54 | 0.77 | 43.31 | 74.00 | -30.69 | peak |
| 2 | | 2390.000 | 30.83 | 0.77 | 31.60 | 54.00 | -22.40 | AVG |
| 3 | X | 2404.600 | 90.18 | 0.83 | 91.01 | Fundamental Frequency | | peak |
| 4 | * | 2405.500 | 79.73 | 0.84 | 80.57 | Fundamental Frequency | | AVG |

Emission Level= Read Level+ Correct Factor

| | | | |
|----------------------|--|---------------------------|-----|
| Temperature: | 25 °C | Relative Humidity: | 55% |
| Test Voltage: | AC 120V/60HZ | | |
| Ant. Pol. | Vertical | | |
| Test Mode: | TX N(HT20) Mode 2412MHz Main ANT.+Aux ANT. | | |
| Remark: | N/A | | |

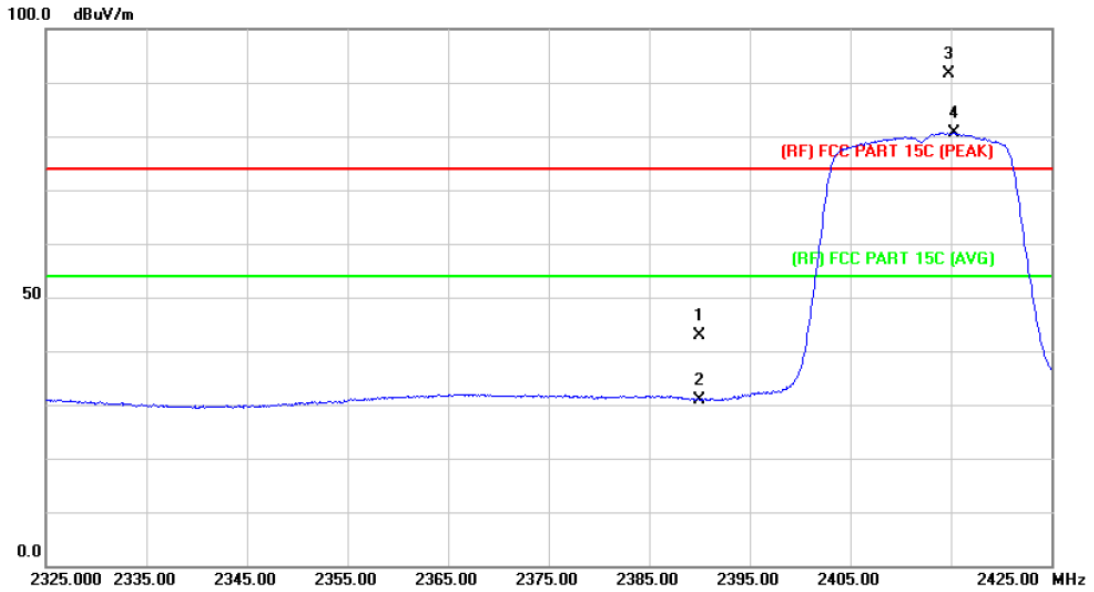

| No. | Mk. | Freq. MHz | Reading Level dBuV | Correct Factor dB/m | Measure- ment dBuV/m | Limit dBuV/m | Over dB | Detector |
|-----|-----|--------------|--------------------------|---------------------------|----------------------------|-----------------------|------------|----------|
| 1 | | 2390.000 | 42.02 | 0.77 | 42.79 | 74.00 | -31.21 | peak |
| 2 | | 2390.000 | 30.15 | 0.77 | 30.92 | 54.00 | -23.08 | AVG |
| 3 | X | 2414.800 | 90.79 | 0.88 | 91.67 | Fundamental Frequency | | peak |
| 4 | * | 2415.300 | 79.71 | 0.88 | 80.59 | Fundamental Frequency | | AVG |

Emission Level= Read Level+ Correct Factor

| | | | |
|----------------------|-----------------------------------|---------------------------|-----|
| Temperature: | 25 °C | Relative Humidity: | 55% |
| Test Voltage: | AC 120V/60HZ | | |
| Ant. Pol. | Horizontal | | |
| Test Mode: | TX N(HT20) Mode 2462MHz +Aux ANT. | | |
| Remark: | N/A | | |

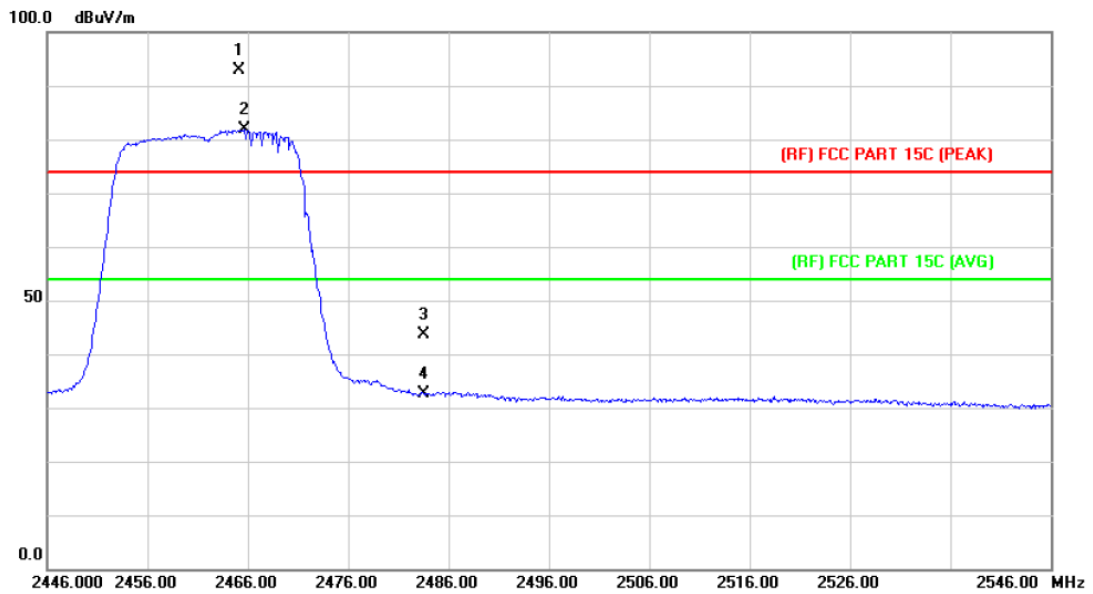

| No. | Mk. | Freq. MHz | Reading Level dBuV | Correct Factor dB/m | Measure- ment dBuV/m | Limit dBuV/m | Over dB | Detector |
|-----|-----|--------------|--------------------------|---------------------------|----------------------------|-----------------------|------------|----------|
| 1 | X | 2465.200 | 91.82 | 1.09 | 92.91 | Fundamental Frequency | | peak |
| 2 | * | 2465.700 | 80.72 | 1.09 | 81.81 | Fundamental Frequency | | AVG |
| 3 | | 2483.500 | 42.40 | 1.17 | 43.57 | 74.00 | -30.43 | peak |
| 4 | | 2483.500 | 31.43 | 1.17 | 32.60 | 54.00 | -21.40 | AVG |

Emission Level= Read Level+ Correct Factor

| | | | |
|----------------------|--|---------------------------|-----|
| Temperature: | 25 °C | Relative Humidity: | 55% |
| Test Voltage: | AC 120V/60HZ | | |
| Ant. Pol. | Vertical | | |
| Test Mode: | TX N(HT20) Mode 2462MHz Main ANT.+Aux ANT. | | |
| Remark: | N/A | | |

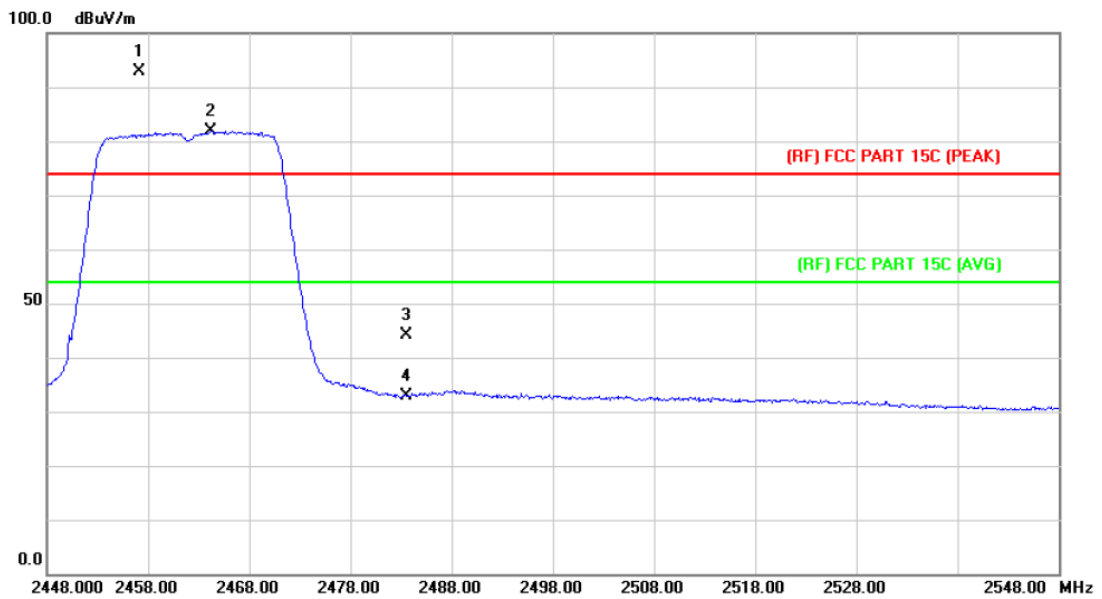

| No. | Mk. | Freq. MHz | Reading Level dBuV | Correct Factor dB/m | Measure- ment dBuV/m | Limit dBuV/m | Over dB | Detector |
|-----|-----|--------------|--------------------------|---------------------------|----------------------------|-----------------------|------------|----------|
| 1 | X | 2457.100 | 91.94 | 1.05 | 92.99 | Fundamental Frequency | | peak |
| 2 | * | 2464.200 | 80.80 | 1.08 | 81.88 | Fundamental Frequency | | AVG |
| 3 | | 2483.500 | 42.99 | 1.17 | 44.16 | 74.00 | -29.84 | peak |
| 4 | | 2483.500 | 31.59 | 1.17 | 32.76 | 54.00 | -21.24 | AVG |

Emission Level= Read Level+ Correct Factor

| | | | |
|----------------------|--|---------------------------|-----|
| Temperature: | 25 °C | Relative Humidity: | 55% |
| Test Voltage: | AC 120V/60HZ | | |
| Ant. Pol. | Horizontal | | |
| Test Mode: | TX N(HT40) Mode 2422MHz Main ANT.+Aux ANT. | | |
| Remark: | N/A | | |

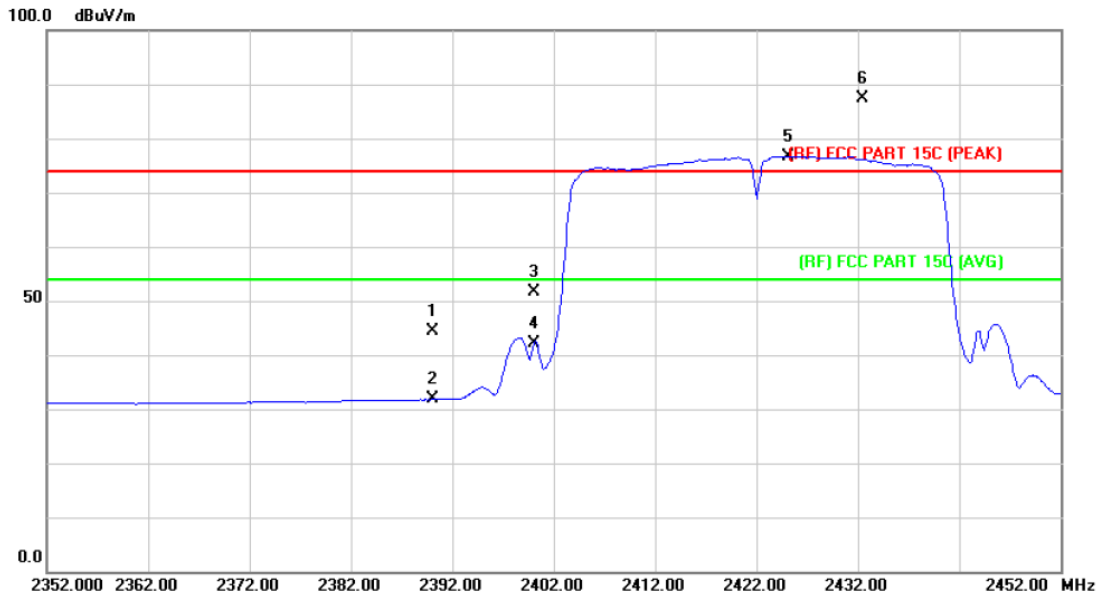

| No. | Mk. | Freq. MHz | Reading Level dBuV | Correct Factor dB/m | Measure- ment dBuV/m | Limit dBuV/m | Over dB | Detector |
|-----|-----|--------------|--------------------------|---------------------------|----------------------------|-----------------------|------------|----------|
| 1 | | 2390.000 | 43.54 | 0.77 | 44.31 | 74.00 | -29.69 | peak |
| 2 | | 2390.000 | 31.02 | 0.77 | 31.79 | 54.00 | -22.21 | AVG |
| 3 | | 2400.000 | 50.79 | 0.81 | 51.60 | 74.00 | -22.40 | peak |
| 4 | | 2400.000 | 41.22 | 0.81 | 42.03 | 54.00 | -11.97 | AVG |
| 5 | * | 2425.100 | 75.80 | 0.93 | 76.73 | Fundamental Frequency | | AVG |
| 6 | X | 2432.400 | 86.32 | 0.95 | 87.27 | Fundamental Frequency | | peak |

Emission Level= Read Level+ Correct Factor

| | | | |
|----------------------|--|---------------------------|-----|
| Temperature: | 25 °C | Relative Humidity: | 55% |
| Test Voltage: | AC 120V/60HZ | | |
| Ant. Pol. | Vertical | | |
| Test Mode: | TX N(HT40) Mode 2422MHz Main ANT.+Aux ANT. | | |
| Remark: | N/A | | |

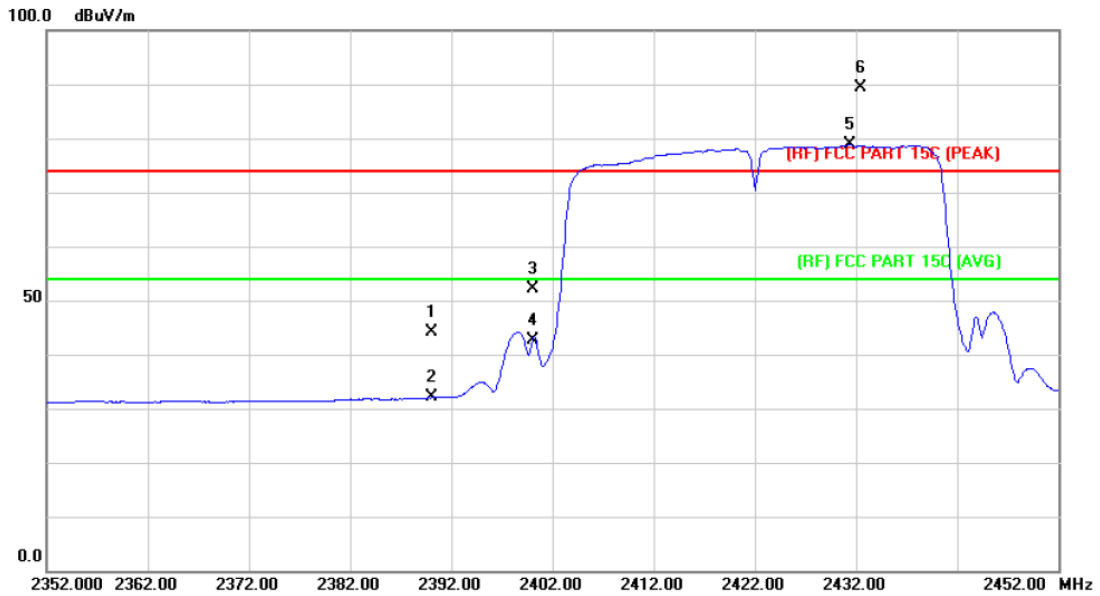

| No. | Mk. | Freq. MHz | Reading Level dBuV | Correct Factor dB/m | Measure- ment dBuV/m | Limit dBuV/m | Over dB | Detector |
|-----|-----|--------------|--------------------------|---------------------------|----------------------------|-----------------------|------------|----------|
| 1 | | 2390.000 | 43.38 | 0.77 | 44.15 | 74.00 | -29.85 | peak |
| 2 | | 2390.000 | 31.24 | 0.77 | 32.01 | 54.00 | -21.99 | AVG |
| 3 | | 2400.000 | 51.33 | 0.81 | 52.14 | 74.00 | -21.86 | peak |
| 4 | | 2400.000 | 41.86 | 0.81 | 42.67 | 54.00 | -11.33 | AVG |
| 5 | * | 2431.400 | 77.86 | 0.95 | 78.81 | Fundamental Frequency | | AVG |
| 6 | X | 2432.500 | 88.40 | 0.95 | 89.35 | Fundamental Frequency | | peak |

Emission Level= Read Level+ Correct Factor

| | | | |
|----------------------|--|---------------------------|-----|
| Temperature: | 25 °C | Relative Humidity: | 55% |
| Test Voltage: | AC 120V/60HZ | | |
| Ant. Pol. | Horizontal | | |
| Test Mode: | TX N(HT40) Mode 2452MHz Main ANT.+Aux ANT. | | |
| Remark: | N/A | | |

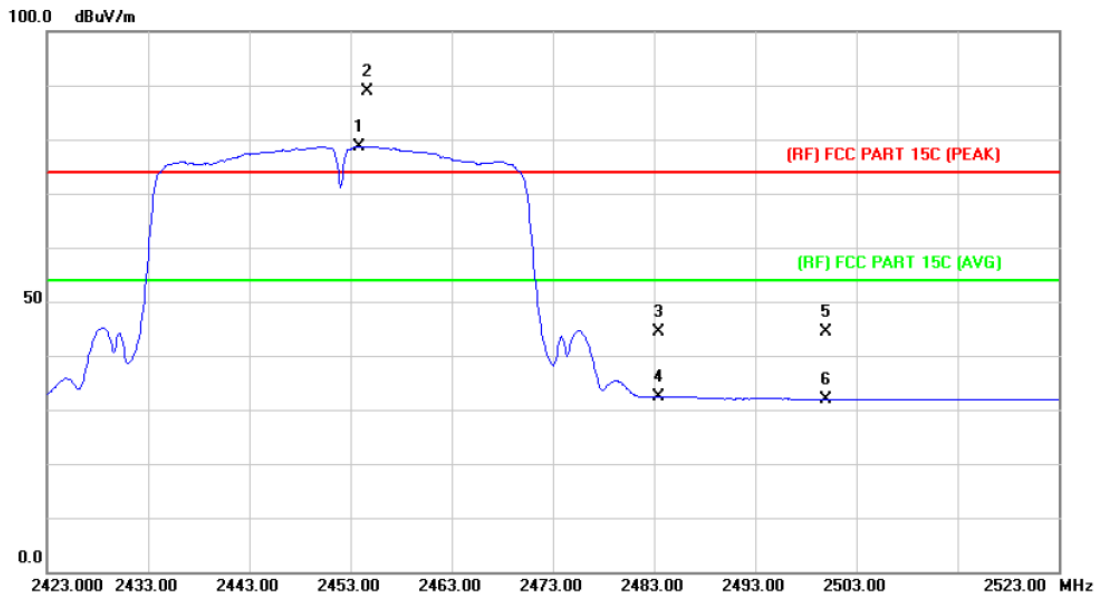

| No. | Mk. | Freq. MHz | Reading Level dBuV | Correct Factor dB/m | Measure- ment dBuV/m | Limit dBuV/m | Over dB | Detector |
|-----|-----|--------------|--------------------------|---------------------------|----------------------------|-----------------------|------------|----------|
| 1 | * | 2453.800 | 77.70 | 1.04 | 78.74 | Fundamental Frequency | | AVG |
| 2 | X | 2454.700 | 87.82 | 1.05 | 88.87 | Fundamental Frequency | | peak |
| 3 | | 2483.500 | 43.13 | 1.17 | 44.30 | 74.00 | -29.70 | peak |
| 4 | | 2483.500 | 31.25 | 1.17 | 32.42 | 54.00 | -21.58 | AVG |
| 5 | | 2500.000 | 43.15 | 1.23 | 44.38 | 74.00 | -29.62 | peak |
| 6 | | 2500.000 | 30.68 | 1.23 | 31.91 | 54.00 | -22.09 | AVG |

Emission Level= Read Level+ Correct Factor

| | | | |
|----------------------|--|---------------------------|-----|
| Temperature: | 25 °C | Relative Humidity: | 55% |
| Test Voltage: | AC 120V/60HZ | | |
| Ant. Pol. | Vertical | | |
| Test Mode: | TX N(HT40) Mode 2452MHz Main ANT.+Aux ANT. | | |
| Remark: | N/A | | |

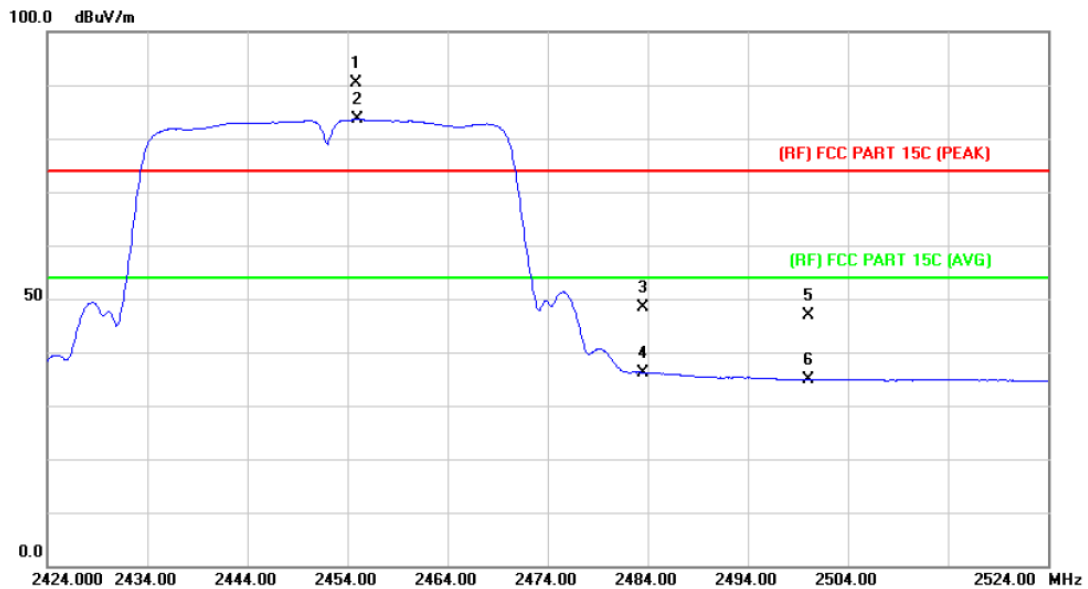

| No. | Mk. | Freq. MHz | Reading Level dBuV | Correct Factor dB/m | Measurement dBuV/m | Limit dBuV/m | Over dB | Detector |
|-----|-----|--------------|--------------------------|---------------------------|-----------------------|-----------------------|------------|----------|
| 1 | X | 2454.900 | 89.33 | 1.05 | 90.38 | Fundamental Frequency | | peak |
| 2 | * | 2455.000 | 82.52 | 1.05 | 83.57 | Fundamental Frequency | | AVG |
| 3 | | 2483.500 | 47.23 | 1.17 | 48.40 | 74.00 | -25.60 | peak |
| 4 | | 2483.500 | 34.97 | 1.17 | 36.14 | 54.00 | -17.86 | AVG |
| 5 | | 2500.000 | 45.67 | 1.23 | 46.90 | 74.00 | -27.10 | peak |
| 6 | | 2500.000 | 33.67 | 1.23 | 34.90 | 54.00 | -19.10 | AVG |

Emission Level= Read Level+ Correct Factor

(2) Conducted Test

| | | | |
|----------------------|--|---------------------------|-----|
| Temperature: | 25 °C | Relative Humidity: | 55% |
| Test Voltage: | AC 120V/60HZ | | |
| Test Mode: | TX B Mode 2412MHz / TX B Mode 2462MHz Main ANT. | | |
| Remark: | The EUT is programed in continuously transmitting mode | | |

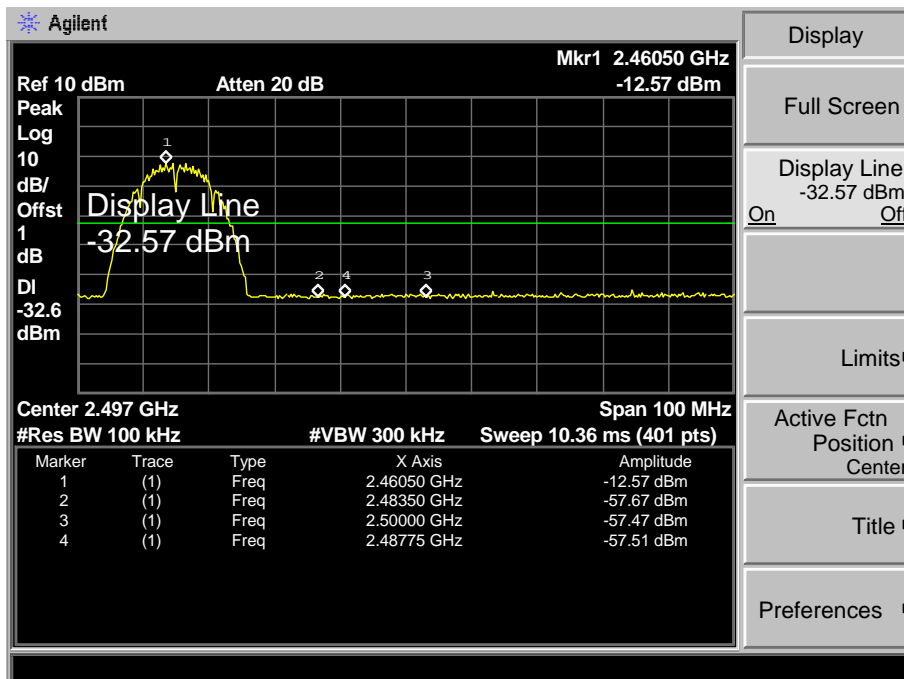
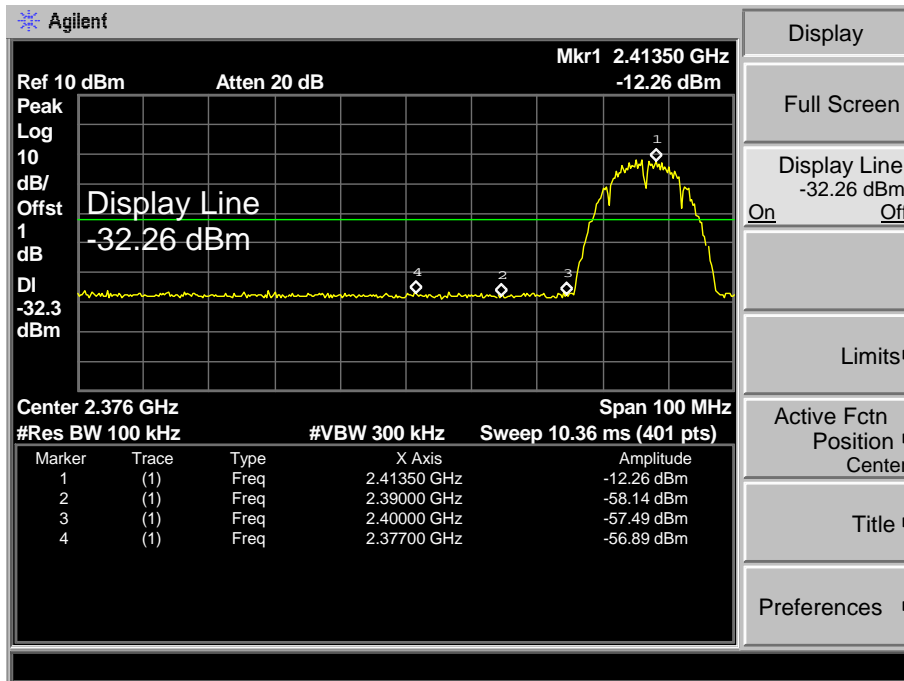

| | | | |
|----------------------|--|---------------------------|-----|
| Temperature: | 25 °C | Relative Humidity: | 55% |
| Test Voltage: | AC 120V/60HZ | | |
| Test Mode: | TX B Mode 2412MHz / TX B Mode 2462MHz Aux ANT. | | |
| Remark: | The EUT is programed in continuously transmitting mode | | |

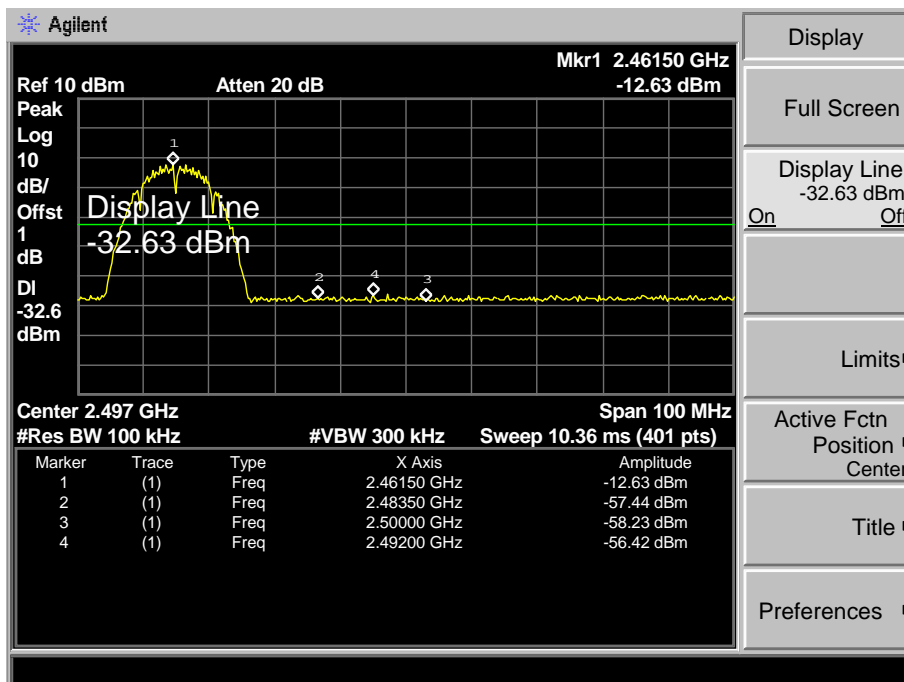
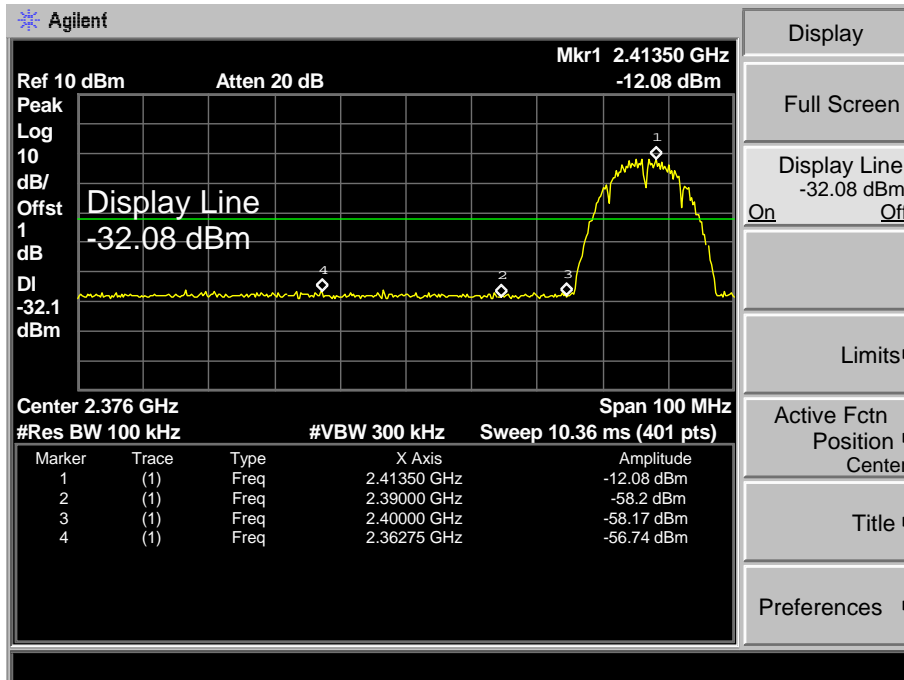

| | | | |
|----------------------|--|---------------------------|-----|
| Temperature: | 25 °C | Relative Humidity: | 55% |
| Test Voltage: | AC 120V/60HZ | | |
| Test Mode: | TX G Mode 2412MHz / TX G Mode 2462MHz Main ANT. | | |
| Remark: | The EUT is programed in continuously transmitting mode | | |

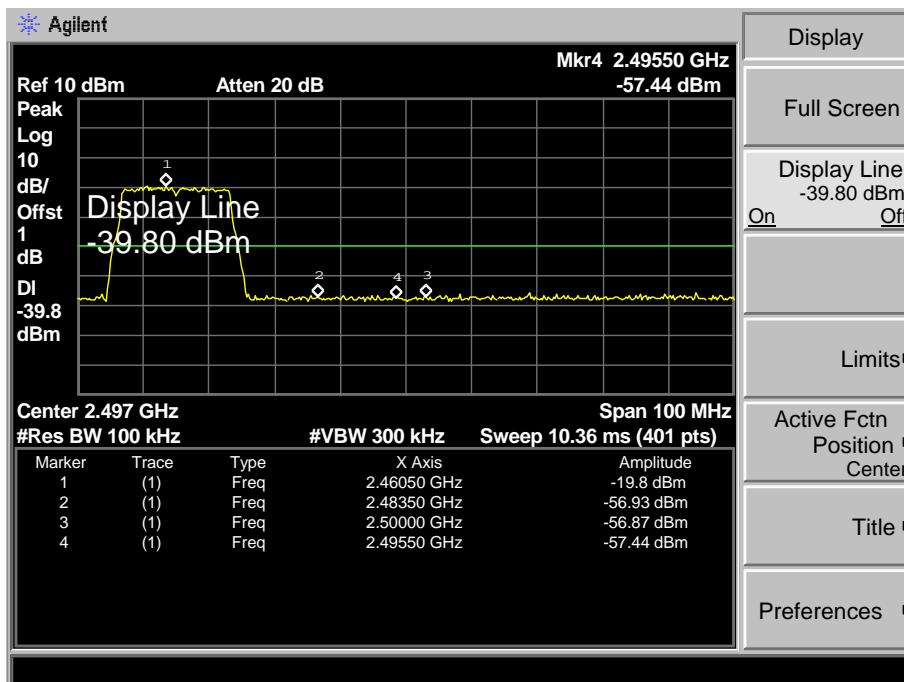
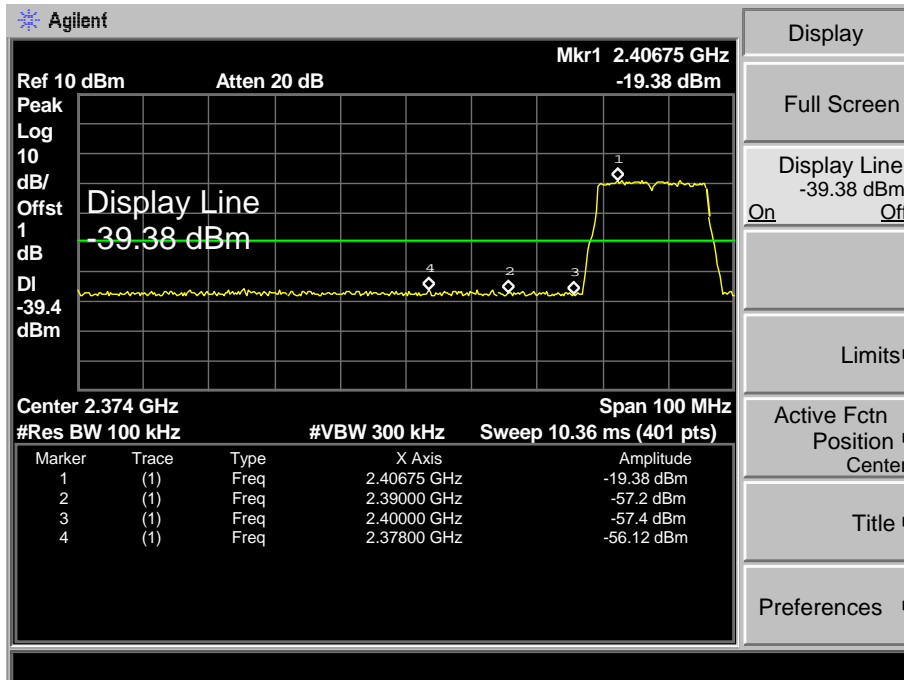

| | | | |
|----------------------|--|---------------------------|-----|
| Temperature: | 25 °C | Relative Humidity: | 55% |
| Test Voltage: | AC 120V/60HZ | | |
| Test Mode: | TX G Mode 2412MHz / TX G Mode 2462MHz Aux ANT. | | |
| Remark: | The EUT is programed in continuously transmitting mode | | |

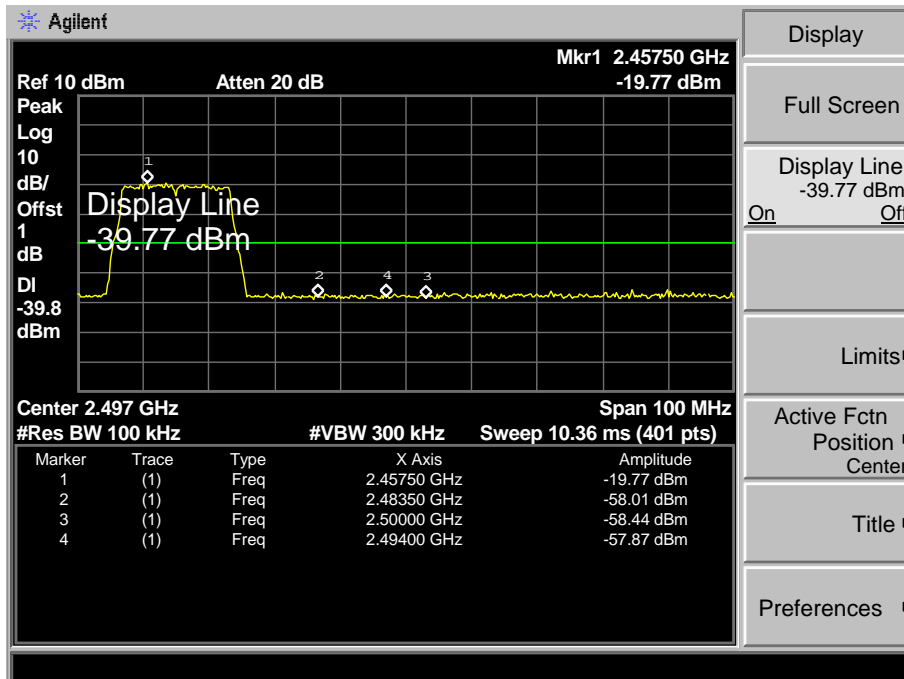
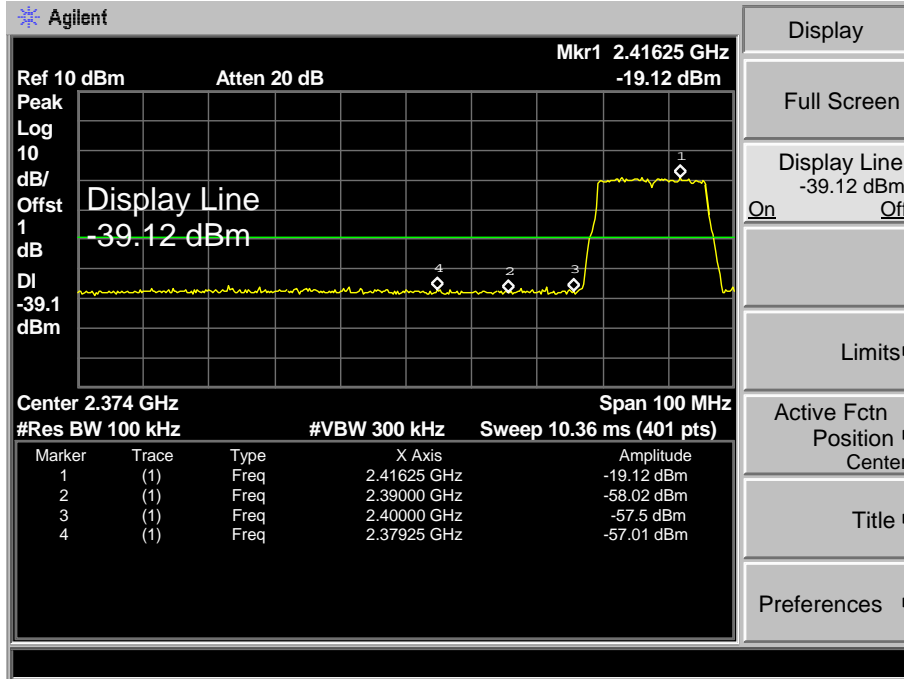

| | | | |
|----------------------|---|---------------------------|-----|
| Temperature: | 25 °C | Relative Humidity: | 55% |
| Test Voltage: | AC 120V/60HZ | | |
| Test Mode: | TX N(HT20) Mode 2412MHz / TX N(HT20) Mode 2462MHz Main ANT. | | |
| Remark: | The EUT is programed in continuously transmitting mode | | |

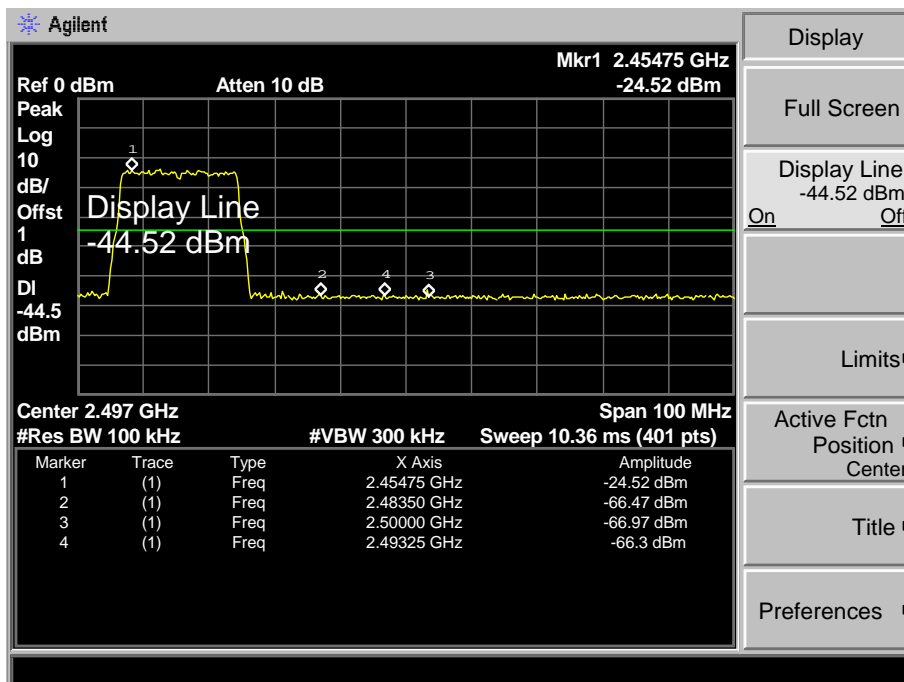
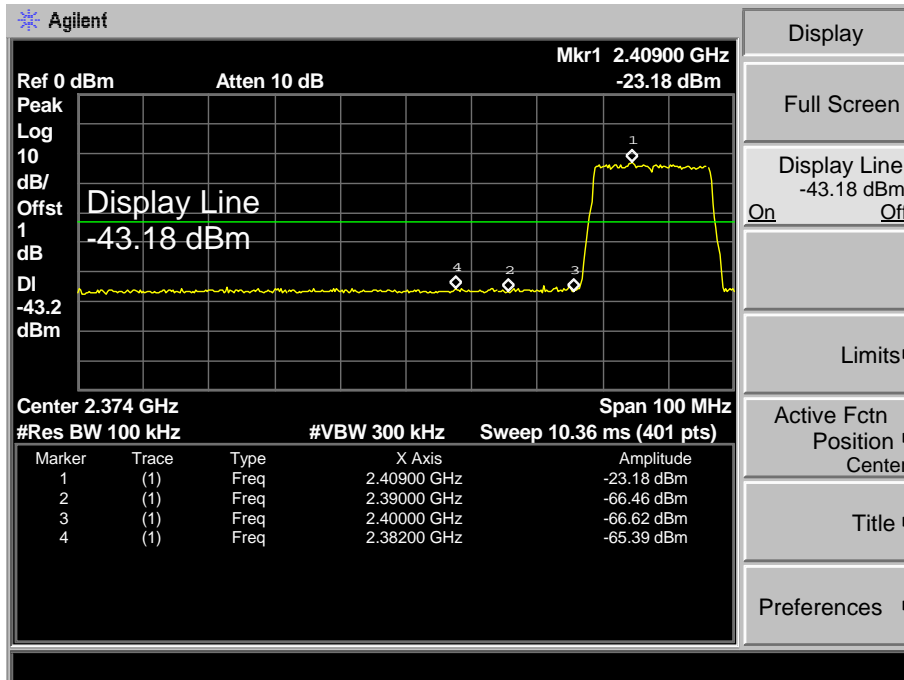

| | | | |
|----------------------|--|---------------------------|-----|
| Temperature: | 25 °C | Relative Humidity: | 55% |
| Test Voltage: | AC 120V/60HZ | | |
| Test Mode: | TX N(HT20) Mode 2412MHz / TX N(HT20) Mode 2462MHz Aux ANT. | | |
| Remark: | The EUT is programed in continuously transmitting mode | | |

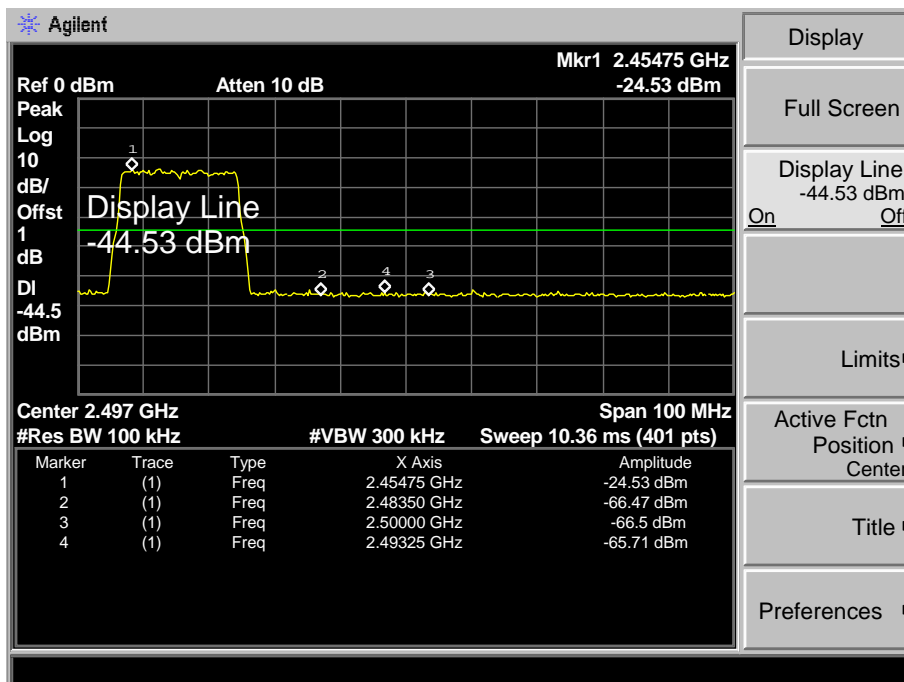
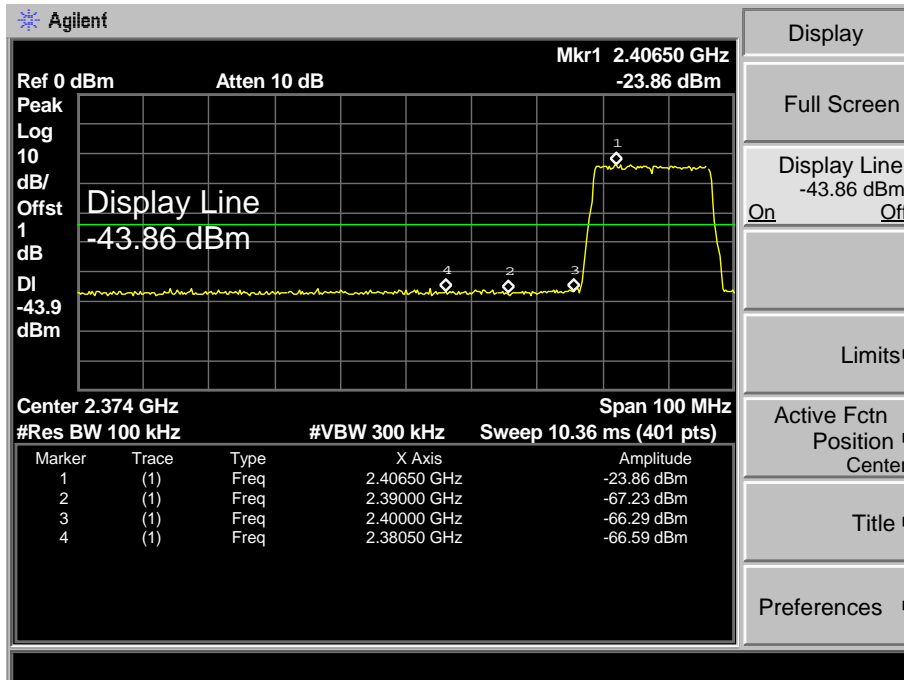

| | | | |
|----------------------|---|---------------------------|-----|
| Temperature: | 25 °C | Relative Humidity: | 55% |
| Test Voltage: | AC 120V/60HZ | | |
| Test Mode: | TX N(HT40) Mode 2422MHz / TX N(HT40) Mode 2452MHz Main ANT. | | |
| Remark: | The EUT is programed in continuously transmitting mode | | |

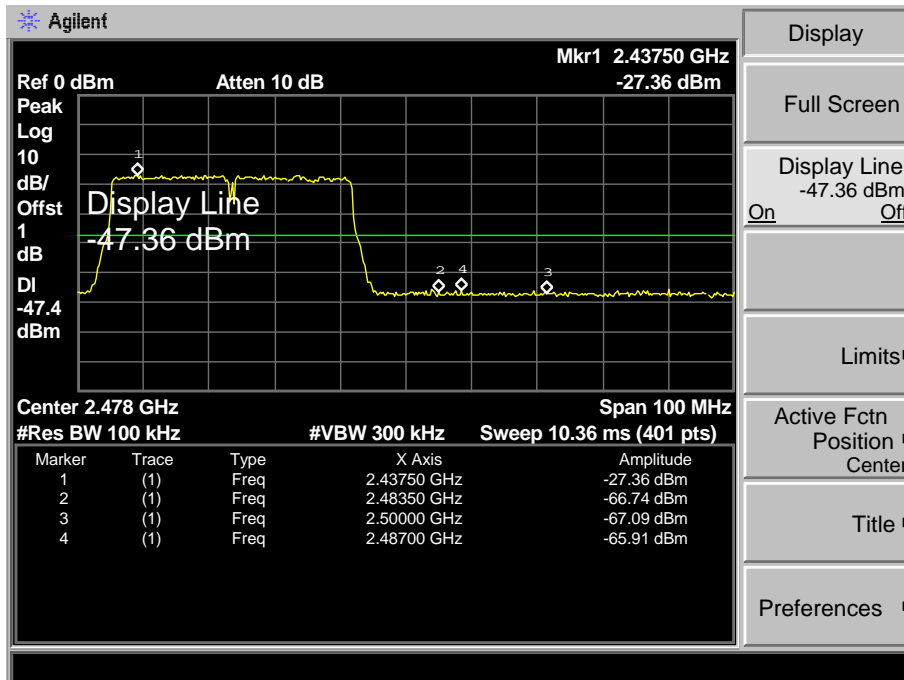
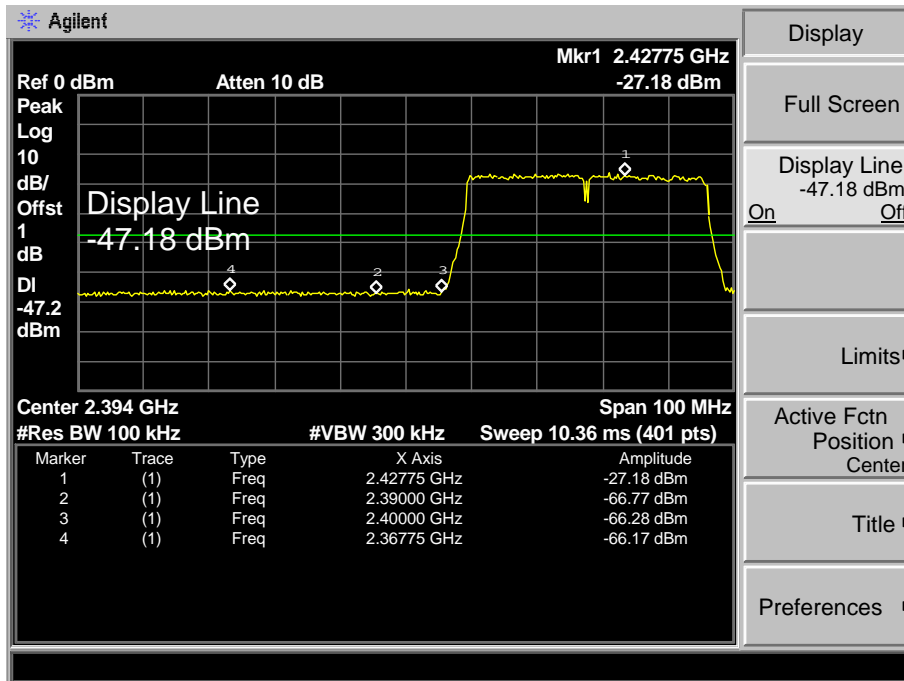

| | | | |
|----------------------|--|---------------------------|-----|
| Temperature: | 25 °C | Relative Humidity: | 55% |
| Test Voltage: | AC 120V/60HZ | | |
| Test Mode: | TX N(HT40) Mode 2422MHz / TX N(HT40) Mode 2452MHz Aux ANT. | | |
| Remark: | The EUT is programed in continuously transmitting mode | | |

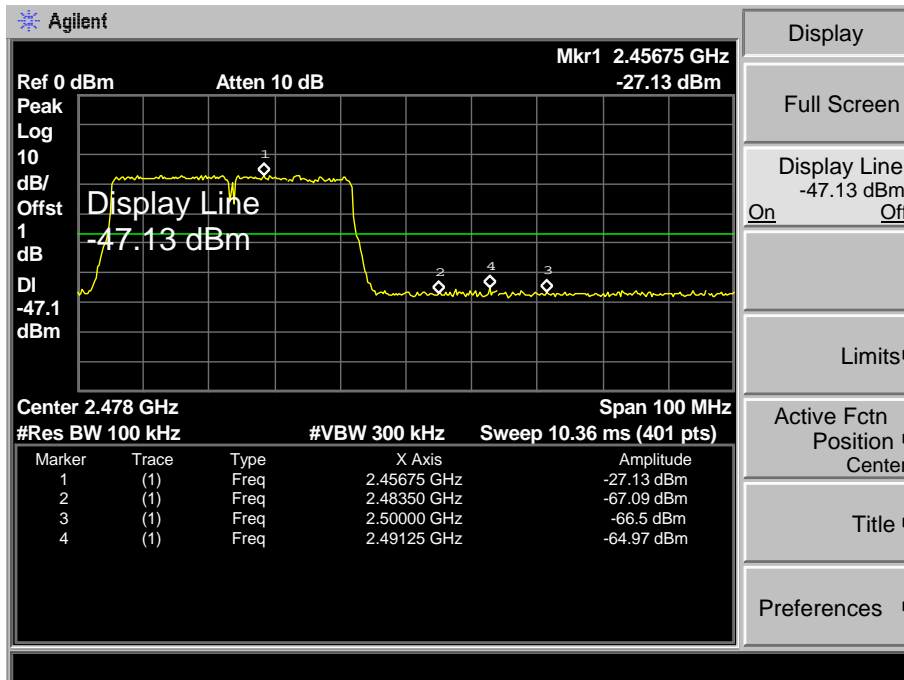
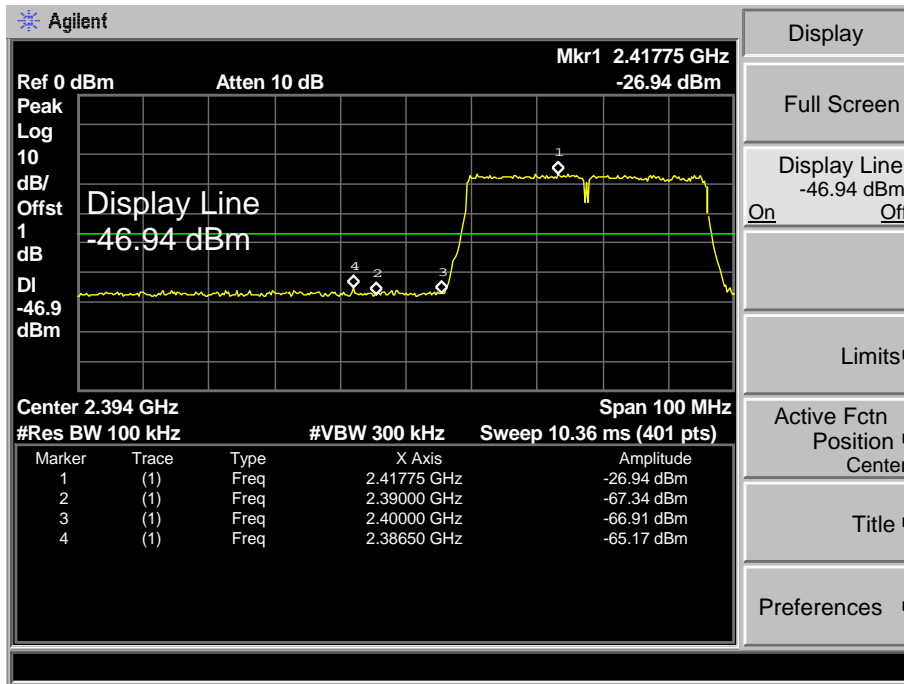

Attachment D-- Bandwidth Test Data

| Temperature: | 25 °C | Relative Humidity: | 55% |
|-------------------------|---------------------------|---------------------|-------------|
| Test Voltage: | AC 120V/60HZ | | |
| Test Mode: | TX 802.11B Mode Main ANT. | | |
| Channel frequency (MHz) | 6dB Bandwidth (MHz) | 99% Bandwidth (MHz) | Limit (MHz) |
| 2412 | 10.059 | 14.2108 | >=0.5 |
| 2437 | 9.064 | 14.1733 | |
| 2462 | 9.617 | 14.2664 | |
| 802.11B Mode | | | |
| 2412 MHz | | | |
| | | | |

802.11B Mode

2437 MHz

| | | | |
|--|--|------------------------------------|--|
| * Agilent | | Freq/Channel | |
| Ch Freq 2.437 GHz Trig Free | | Center Freq 2.43700000 GHz | |
| Occupied Bandwidth | | Start Freq 2.41700000 GHz | |
| Center 2.43700000 GHz | | Stop Freq 2.45700000 GHz | |
| Ref 10 dBm Atten 20 dB | | CF Step 4.00000000 MHz Auto Man | |
| | | Freq Offset 0.00000000 Hz | |
| Center 2.437 GHz Span 40 MHz | | Signal Track On Off | |
| #Res BW 100 kHz #VBW 300 kHz Sweep 4.144 ms (401 pts) | | Scale Type Log Lin | |
| Occupied Bandwidth Occ BW % Pwr 99.00 % 14.1733 MHz x dB -6.00 dB | | | |
| Transmit Freq Error -14.492 kHz | | | |
| x dB Bandwidth 9.064 MHz | | | |

802.11B Mode

2462 MHz

| | | | |
|--|--|------------------------------------|--|
| * Agilent | | Freq/Channel | |
| Ch Freq 2.462 GHz Trig Free | | Center Freq 2.46200000 GHz | |
| Occupied Bandwidth | | Start Freq 2.44200000 GHz | |
| Center 2.46200000 GHz | | Stop Freq 2.48200000 GHz | |
| Ref 10 dBm Atten 20 dB | | CF Step 4.00000000 MHz Auto Man | |
| | | Freq Offset 0.00000000 Hz | |
| Center 2.462 GHz Span 40 MHz | | Signal Track On Off | |
| #Res BW 100 kHz #VBW 300 kHz Sweep 4.144 ms (401 pts) | | Scale Type Log Lin | |
| Occupied Bandwidth Occ BW % Pwr 99.00 % 14.2664 MHz x dB -6.00 dB | | | |
| Transmit Freq Error -11.151 kHz | | | |
| x dB Bandwidth 9.617 MHz | | | |

| Temperature: | 25 °C | Relative Humidity: | 55% |
|-------------------------|--------------------------|---------------------|-------------|
| Test Voltage: | AC 120V/60HZ | | |
| Test Mode: | TX 802.11B Mode Aux ANT. | | |
| Channel frequency (MHz) | 6dB Bandwidth (MHz) | 99% Bandwidth (MHz) | Limit (MHz) |
| 2412 | 10.078 | 14.2389 | ≥0.5 |
| 2437 | 10.053 | 14.1797 | |
| 2462 | 10.084 | 14.2204 | |

802.11B Mode

2412 MHz

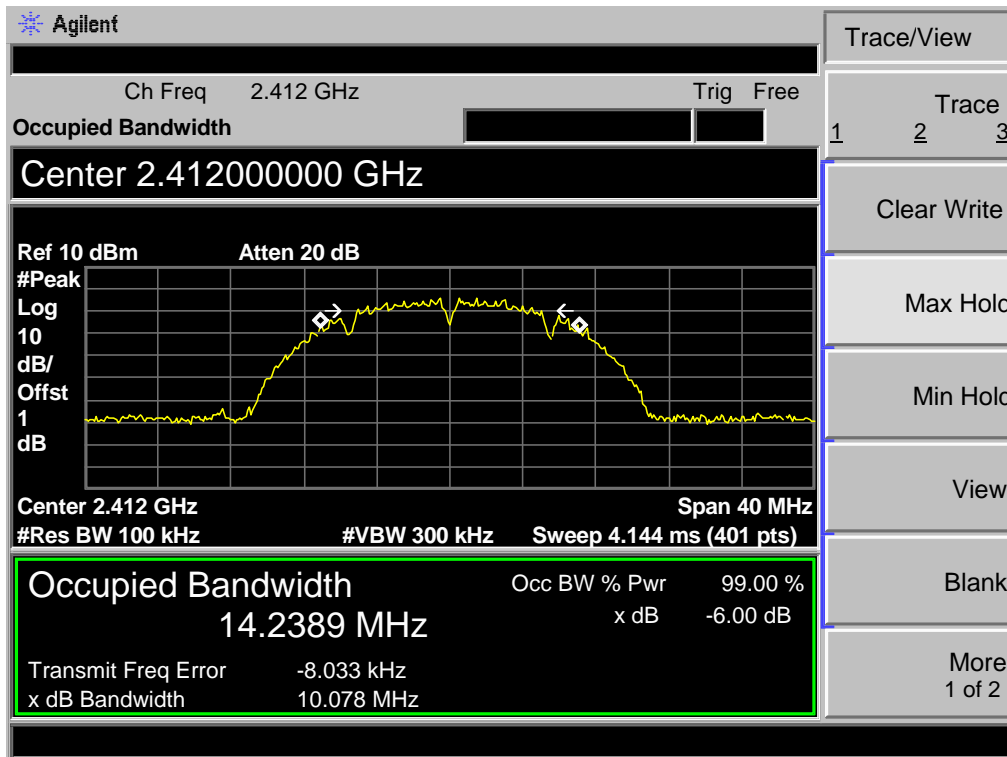

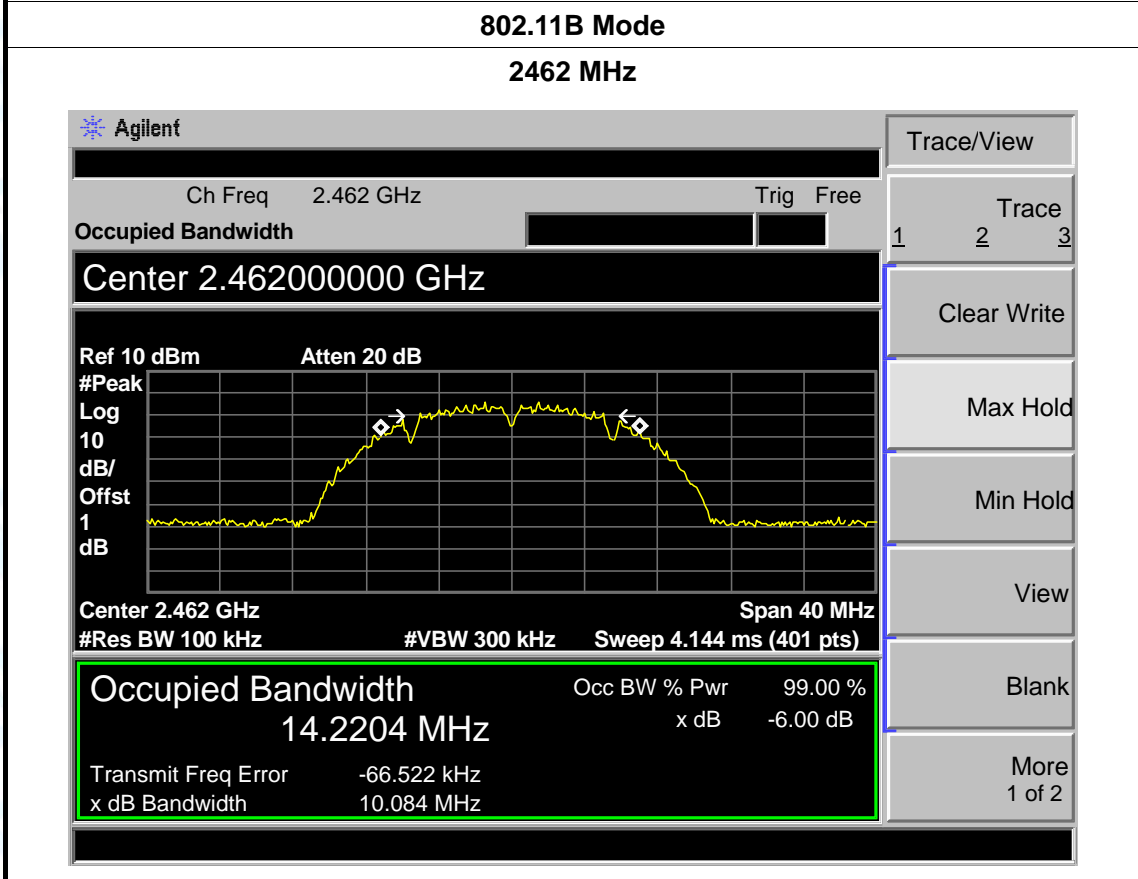
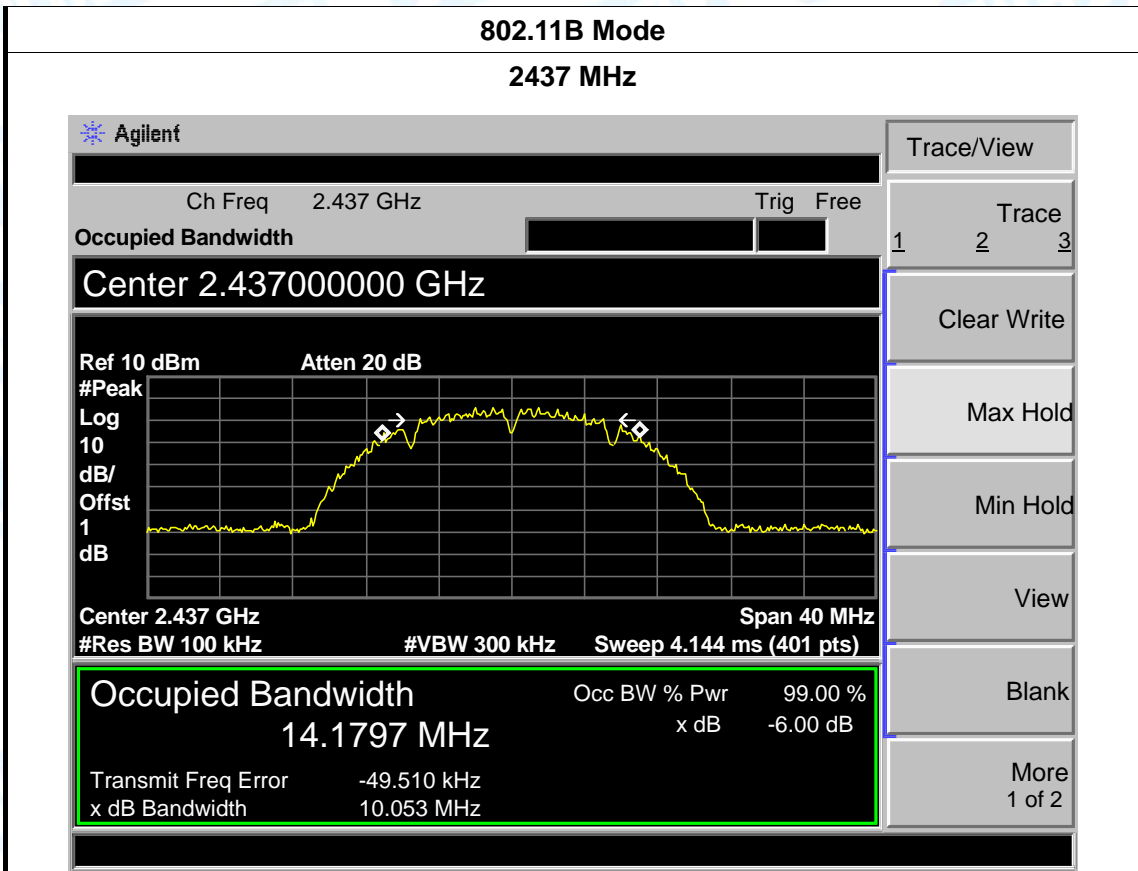

| Temperature: | 25 °C | Relative Humidity: | 55% |
|-------------------------|---------------------------|---------------------------|-------------|
| Test Voltage: | AC 120V/60HZ | | |
| Test Mode: | TX 802.11G Mode Main ANT. | | |
| Channel frequency (MHz) | 6dB Bandwidth (MHz) | 99% Bandwidth (MHz) | Limit (MHz) |
| 2412 | 16.407 | 16.5105 | ≥0.5 |
| 2437 | 16.575 | 16.5068 | |
| 2462 | 16.588 | 16.4824 | |

802.11G Mode

2412 MHz

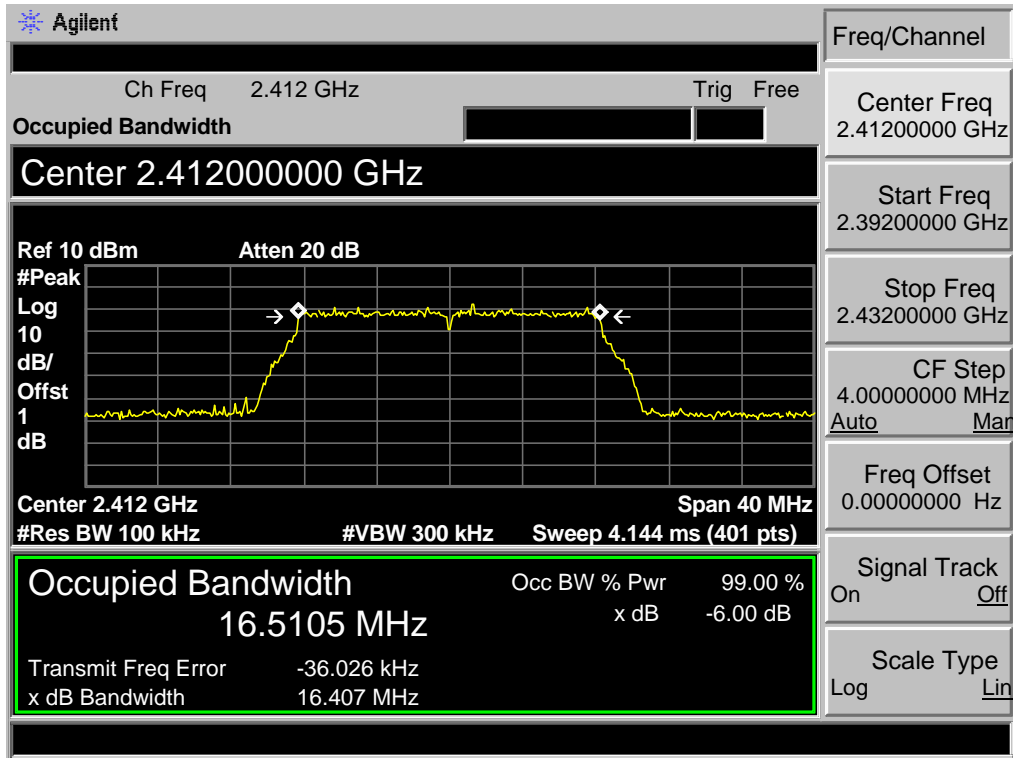

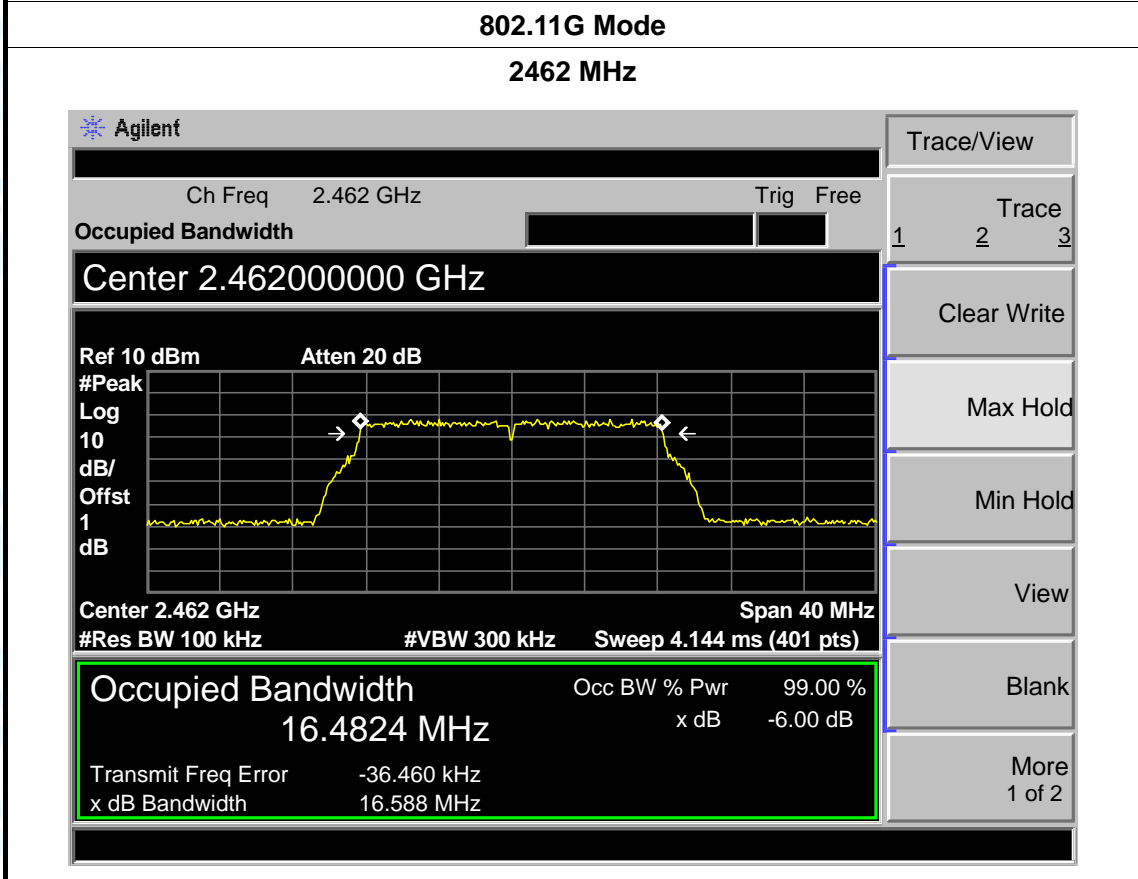
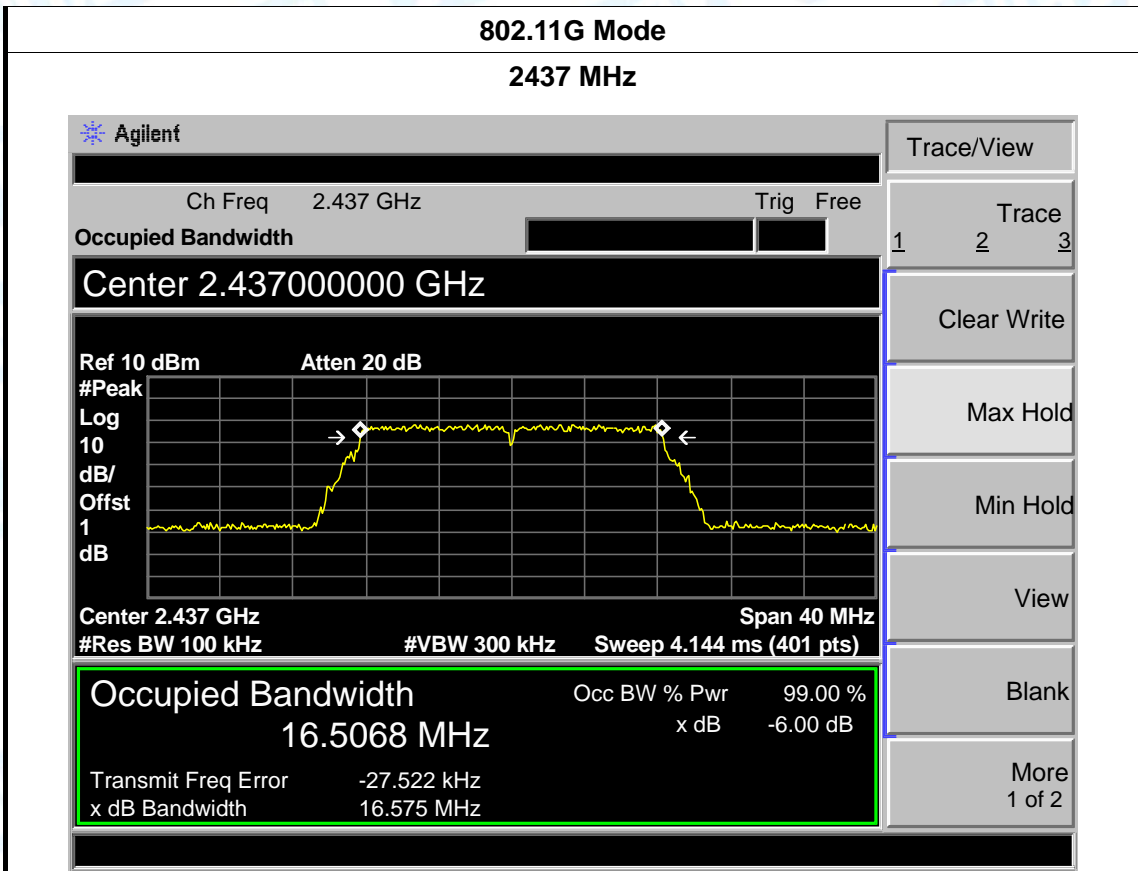

| | | | |
|--------------------------------|----------------------------|----------------------------|--------------------|
| Temperature: | 25 °C | Relative Humidity: | 55% |
| Test Voltage: | AC 120V/60HZ | | |
| Test Mode: | TX 802.11G Mode Aux ANT. | | |
| Channel frequency (MHz) | 6dB Bandwidth (MHz) | 99% Bandwidth (MHz) | Limit (MHz) |
| 2412 | 16.482 | 16.5372 | >=0.5 |
| 2437 | 16.572 | 16.4760 | |
| 2462 | 16.606 | 16.4997 | |

802.11G Mode

2412 MHz

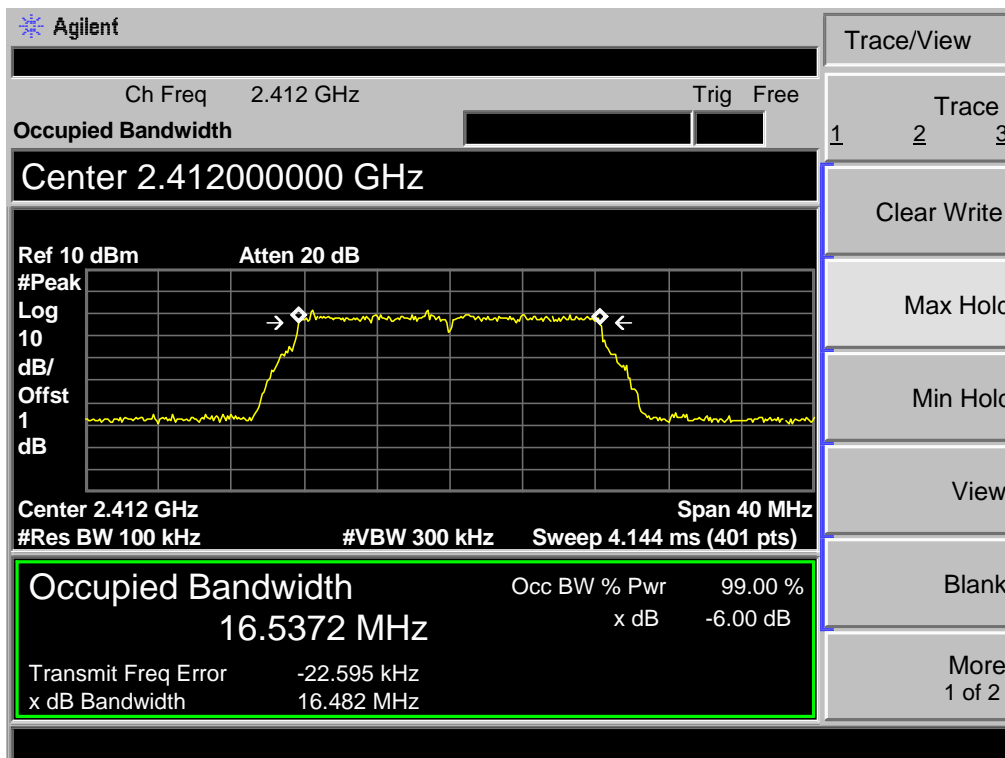

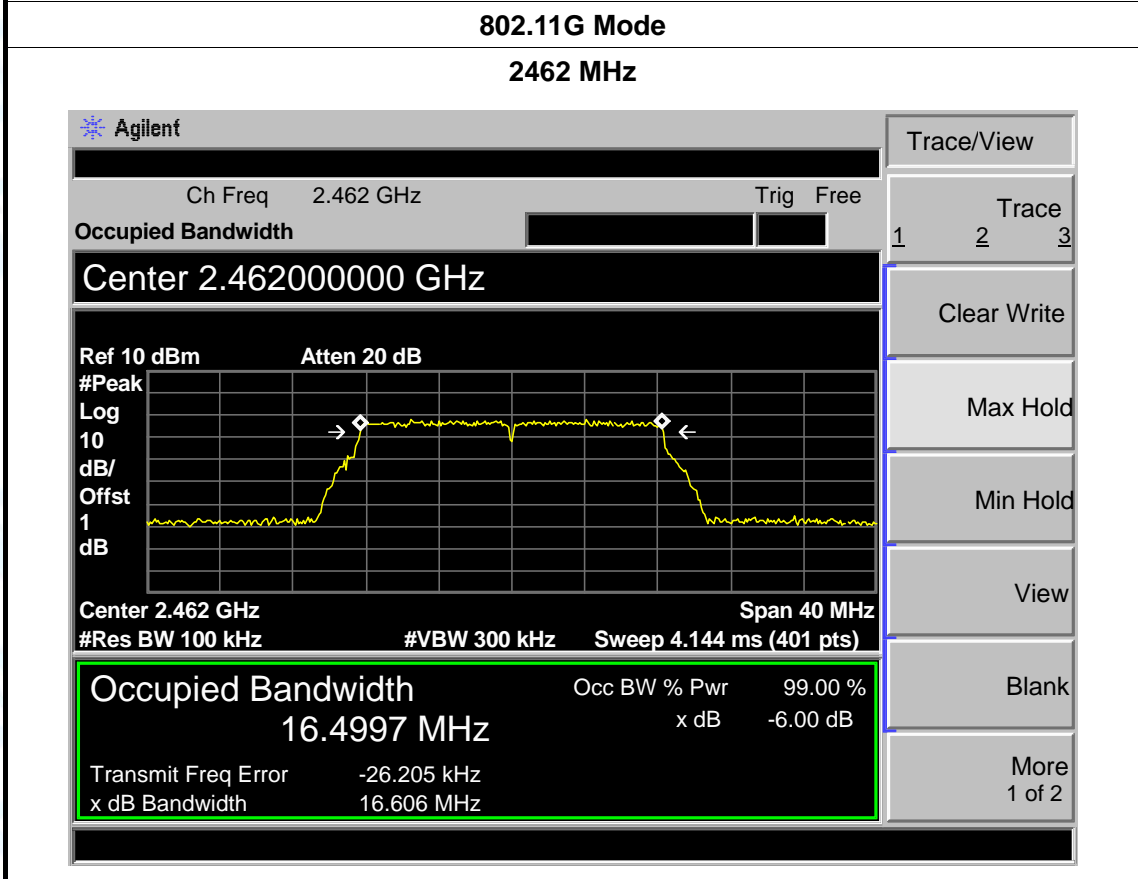
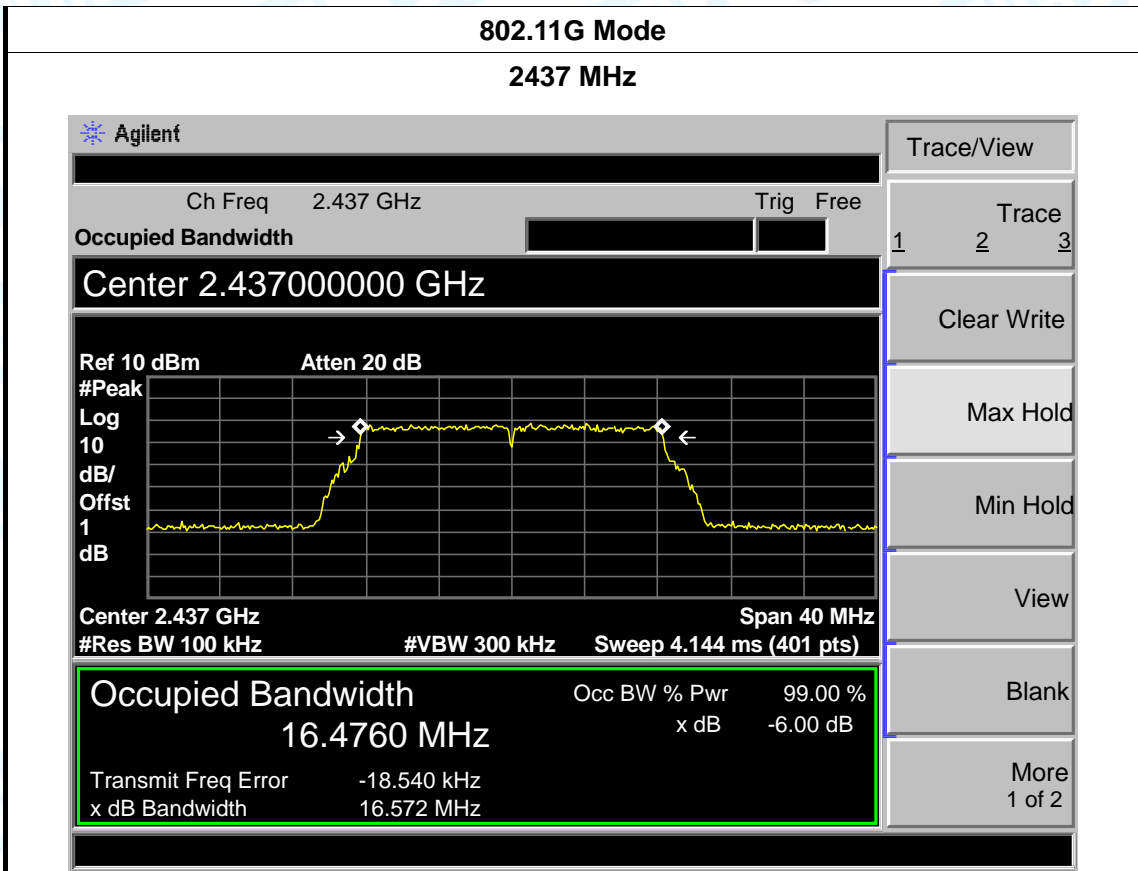

| Temperature: | 25 °C | Relative Humidity: | 55% |
|---------------------------|---------------------------------|---------------------------|-------------|
| Test Voltage: | AC 120V/60HZ | | |
| Test Mode: | TX 802.11N(HT20) Mode Main ANT. | | |
| Channel frequency (MHz) | 6dB Bandwidth (MHz) | 99% Bandwidth (MHz) | Limit (MHz) |
| 2412 | 17.846 | 17.6438 | >=0.5 |
| 2437 | 17.843 | 17.6446 | |
| 2462 | 17.805 | 17.6747 | |
| 802.11N(HT20) Mode | | | |

2412 MHz

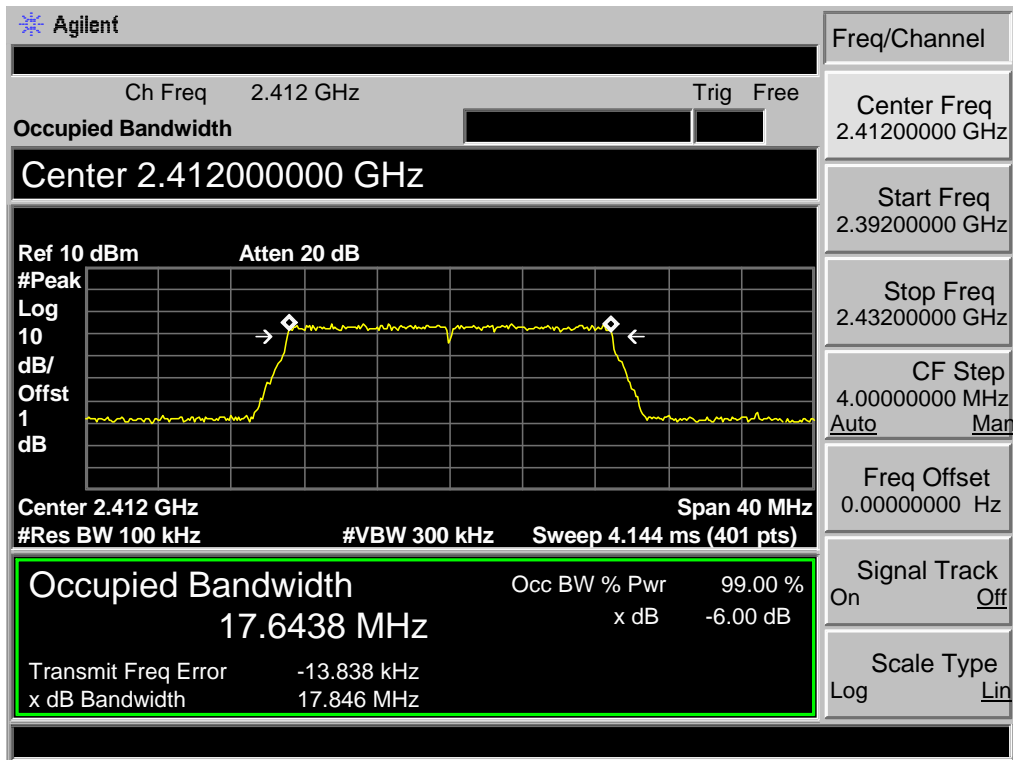

802.11N(HT20) Mode

2437 MHz

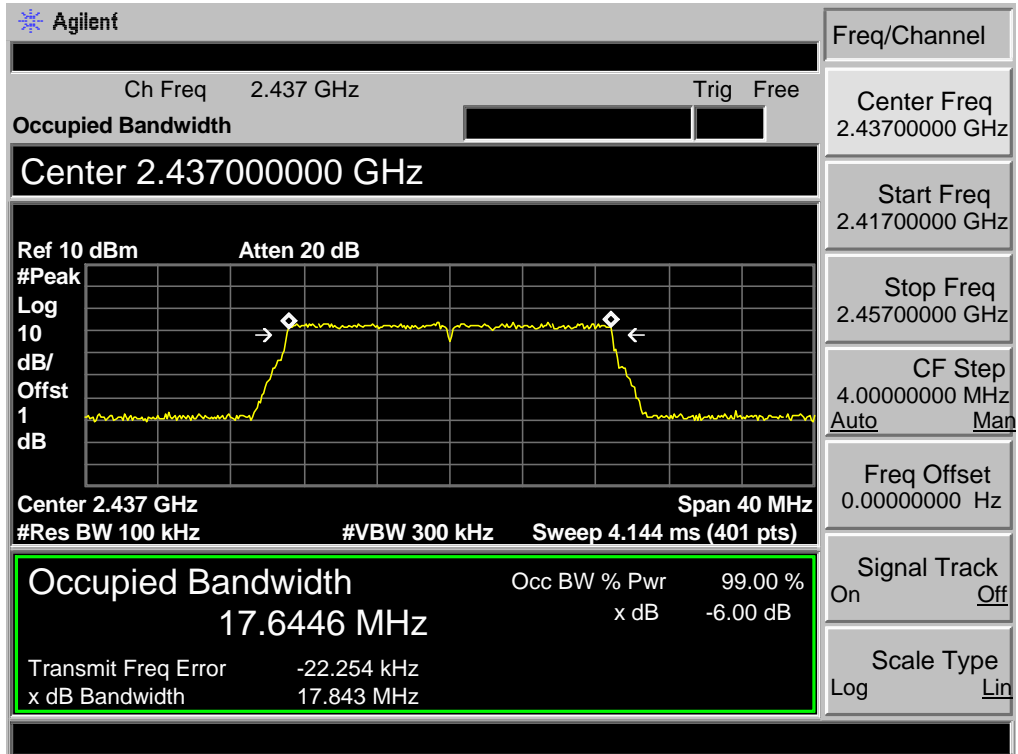

802.11N(HT20) Mode

2462 MHz

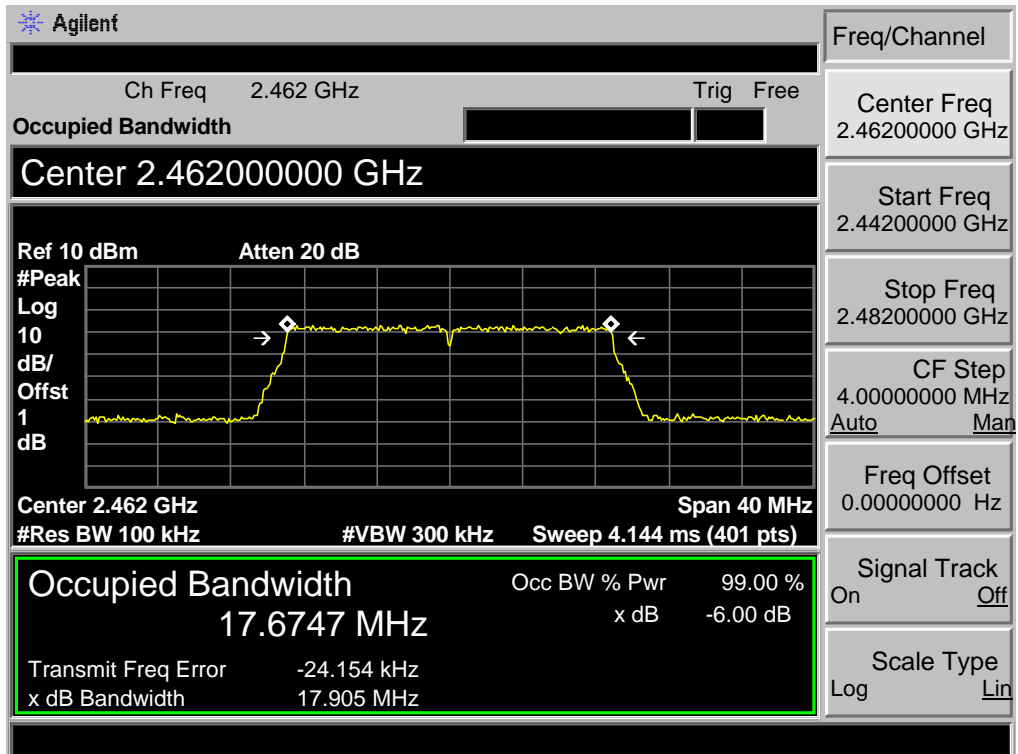

| Temperature: | 25 °C | Relative Humidity: | 55% |
|---------------------------|--------------------------------|---------------------------|-------------|
| Test Voltage: | AC 120V/60HZ | | |
| Test Mode: | TX 802.11N(HT20) Mode Aux ANT. | | |
| Channel frequency (MHz) | 6dB Bandwidth (MHz) | 99% Bandwidth (MHz) | Limit (MHz) |
| 2412 | 17.856 | 17.6612 | ≥0.5 |
| 2437 | 17.833 | 17.6356 | |
| 2462 | 17.838 | 17.6650 | |
| 802.11N(HT20) Mode | | | |

2412 MHz

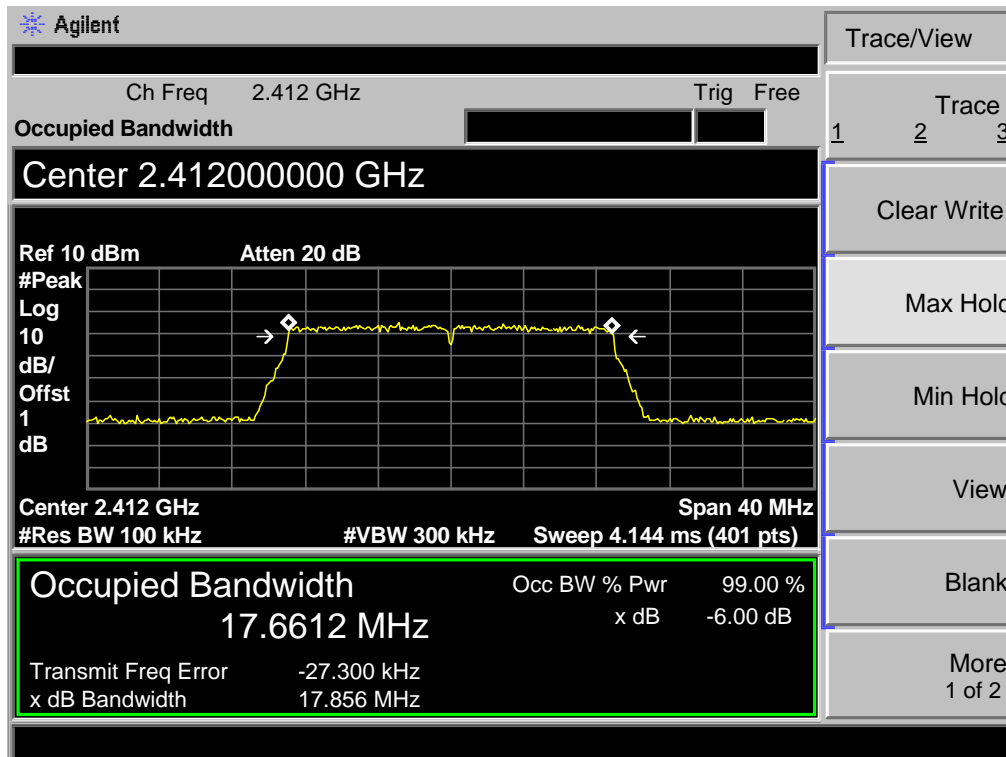

802.11N(HT20) Mode

2437 MHz

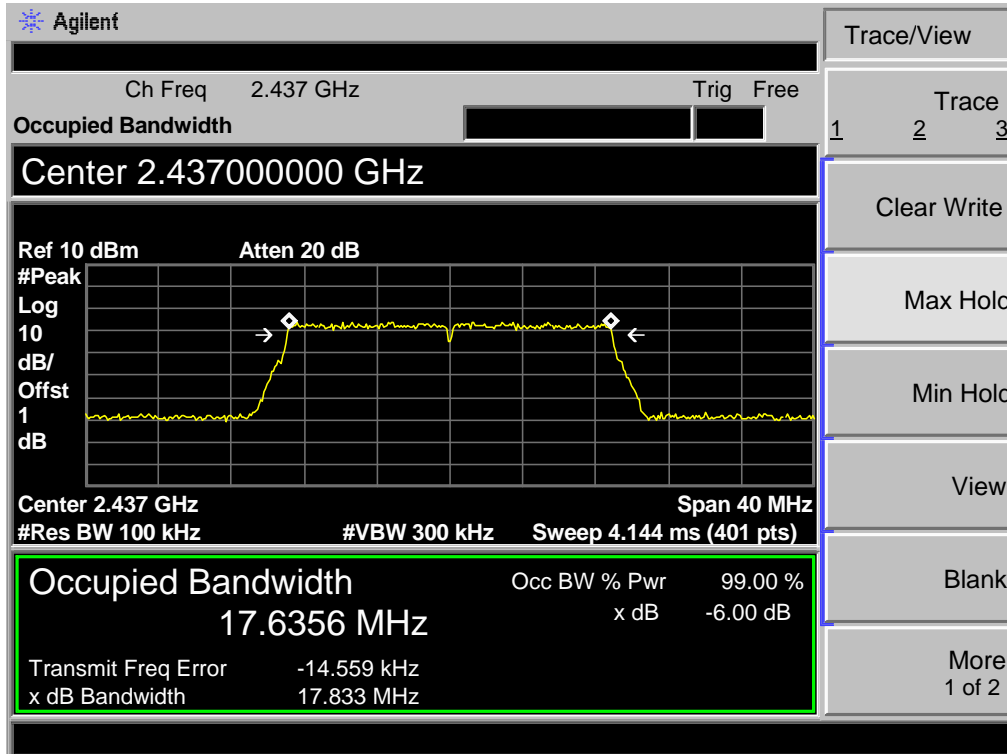

802.11N(HT20) Mode

2462 MHz

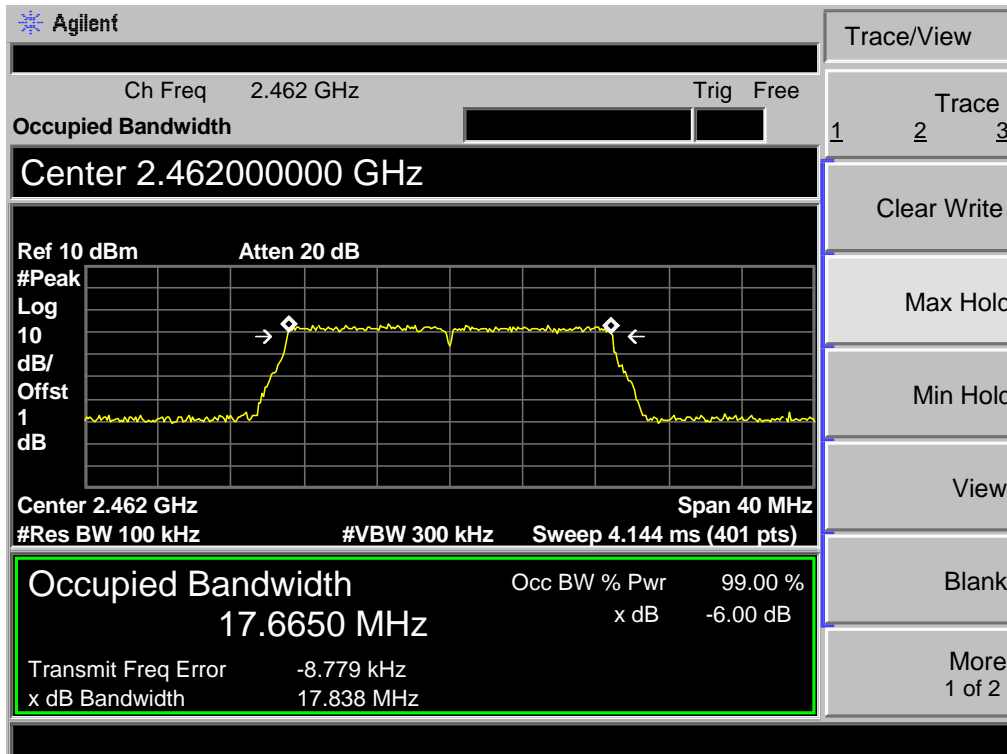

| Temperature: | 25 °C | Relative Humidity: | 55% |
|---------------------------|---------------------------------|---------------------------|-------------|
| Test Voltage: | AC 120V/60HZ | | |
| Test Mode: | TX 802.11N(HT40) Mode Main ANT. | | |
| Channel frequency (MHz) | 6dB Bandwidth (MHz) | 99% Bandwidth (MHz) | Limit (MHz) |
| 2422 | 36.636 | 36.1317 | >=0.5 |
| 2437 | 36.594 | 36.0684 | |
| 2452 | 36.567 | 36.0237 | |
| 802.11N(HT40) Mode | | | |

2422 MHz

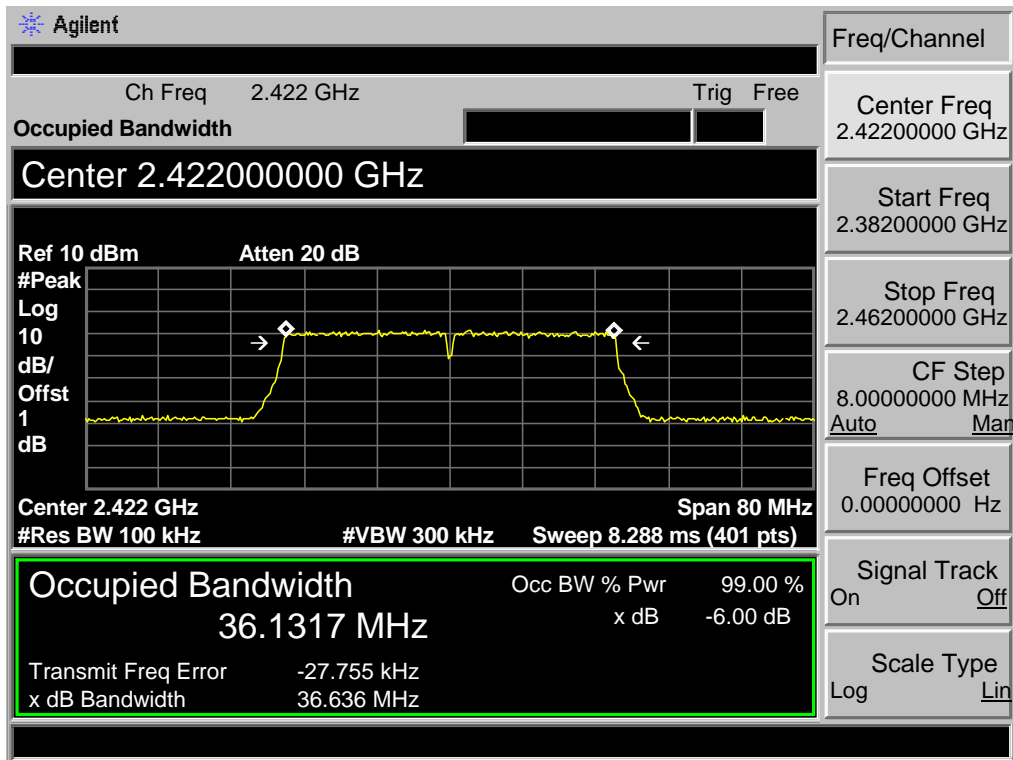

802.11N(HT40) Mode

2437 MHz

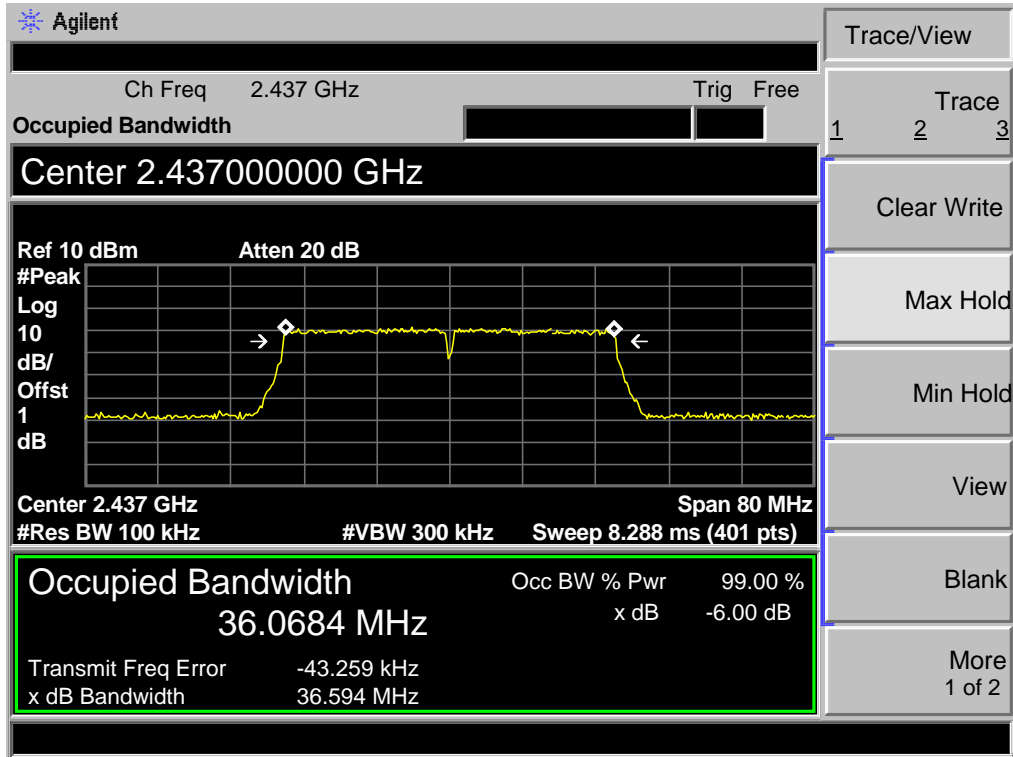

802.11N(HT40) Mode

2452 MHz

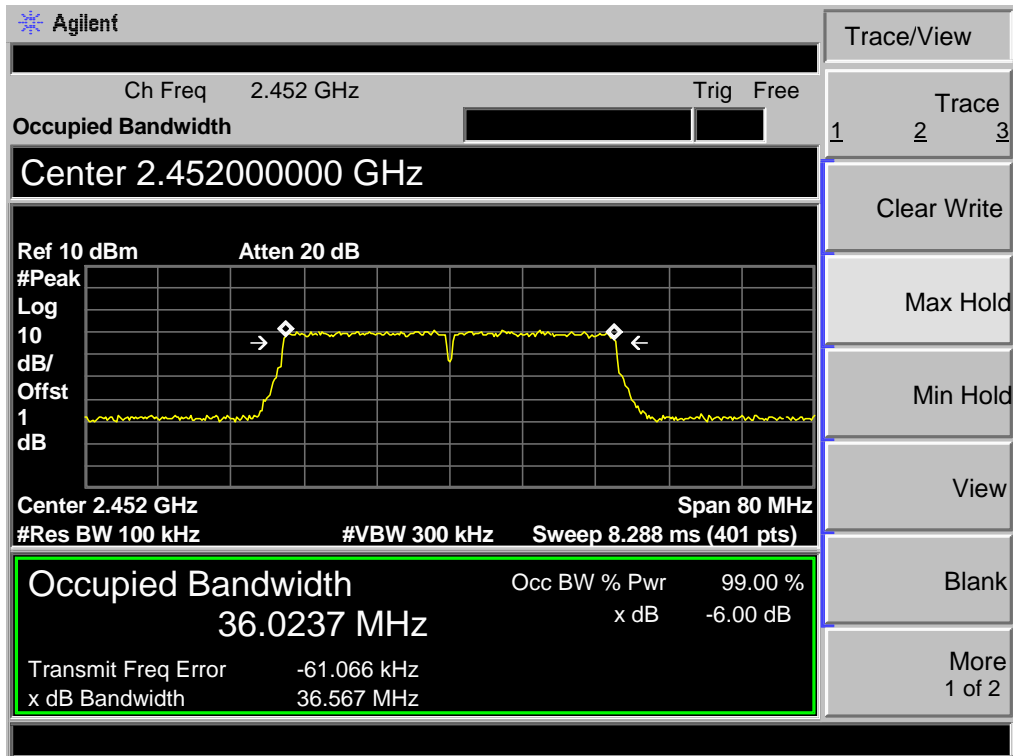

| Temperature: | 25 °C | Relative Humidity: | 55% |
|-------------------------|--------------------------------|---------------------|-------------|
| Test Voltage: | AC 120V/60HZ | | |
| Test Mode: | TX 802.11N(HT40) Mode Aux ANT. | | |
| Channel frequency (MHz) | 6dB Bandwidth (MHz) | 99% Bandwidth (MHz) | Limit (MHz) |
| 2422 | 36.600 | 36.0988 | ≥0.5 |
| 2437 | 36.658 | 36.1264 | |
| 2452 | 36.614 | 36.1204 | |

802.11N(HT40) Mode

2422 MHz

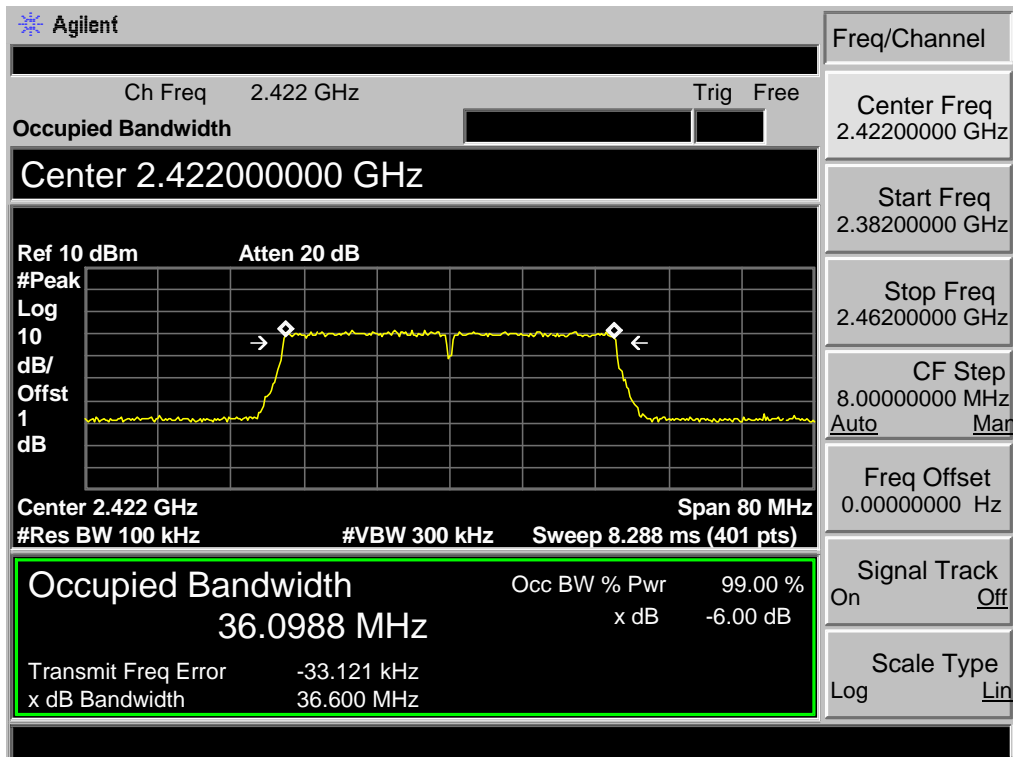

802.11N(HT40) Mode

2437 MHz

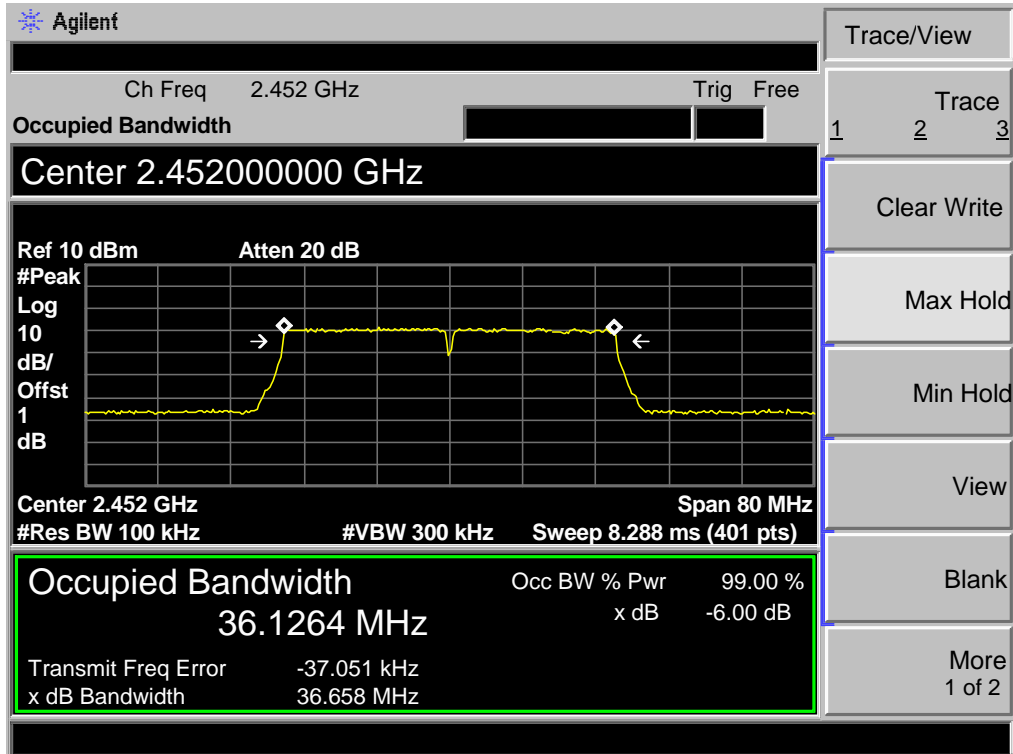

802.11N(HT40) Mode

2452 MHz

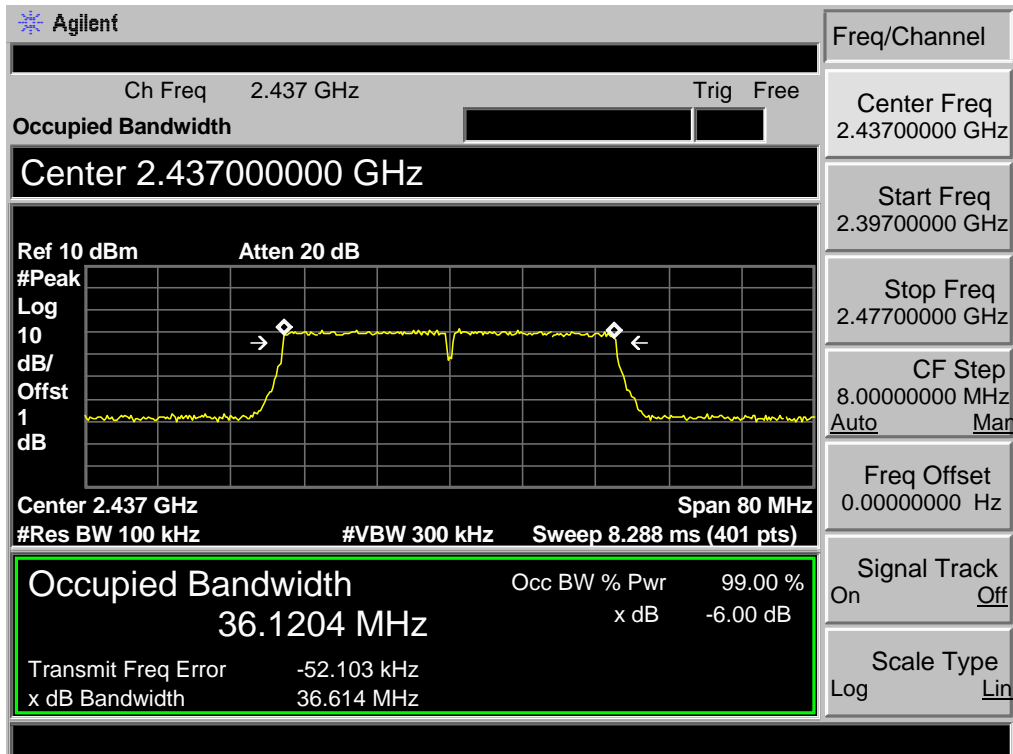

Attachment E-- Peak Output Power Test Data

| Conducted Power | | | | | |
|--|-----------|-----------------------|----------|-------|------------------|
| 802.11b Power | | | | | |
| Channel | Frequency | Conducted Power (dBm) | | | Max. Limit (dBm) |
| | | Main Ant. | Aux Ant. | Total | |
| 1 | 2412 MHz | 8.13 | 8.07 | --- | 30 |
| 6 | 2437 MHz | 8.18 | 8.06 | --- | |
| 11 | 2462 MHz | 8.15 | 8.04 | --- | |
| 802.11g Power | | | | | |
| Channel | Frequency | Conducted Power (dBm) | | | Max. Limit (dBm) |
| | | Main Ant. | Aux Ant. | Total | |
| 1 | 2412 MHz | 7.89 | 7.68 | --- | 30 |
| 6 | 2437 MHz | 7.96 | 7.74 | --- | |
| 11 | 2462 MHz | 7.78 | 7.68 | --- | |
| 802.11n(HT20) Power | | | | | |
| Channel | Frequency | Conducted Power (dBm) | | | Max. Limit (dBm) |
| | | Main Ant. | Aux Ant. | Total | |
| 1 | 2412 MHz | 4.58 | 4.23 | 7.42 | 30 |
| 6 | 2437 MHz | 4.63 | 4.19 | 7.43 | |
| 11 | 2462 MHz | 4.57 | 4.22 | 7.41 | |
| 802.11n(HT40) Power | | | | | |
| Channel | Frequency | Conducted Power (dBm) | | | Max. Limit (dBm) |
| | | Main Ant. | Aux Ant. | Total | |
| 3 | 2422 MHz | 4.68 | 4.15 | 7.42 | 30 |
| 6 | 2437 MHz | 4.55 | 4.24 | 7.41 | |
| 9 | 2452 MHz | 4.68 | 4.12 | 7.42 | |
| Note: When Main ANT. and Aux ANT. transmitting simultaneously, the total Antenna Gain=Main Gain +Aux Gani =5.01 dBi< 6 dBi. So $P_{out} = P_{limit} = 30\text{dBm}$ | | | | | |

| Duty Cycle | | |
|-------------------|-------------------------|-------------|
| Mode | Channel frequency (MHz) | Test Result |
| 802.11b | 2412 | >98% |
| | 2437 | |
| | 2462 | |
| 802.11g | 2412 | |
| | 2437 | |
| | 2462 | |
| 802.11n (HT20) | 2412 | |
| | 2437 | |
| | 2462 | |
| 802.11n (HT40) | 2422 | |
| | 2437 | |
| | 2452 | |

Please see below plots

802.11 B Mode 2437 MHz

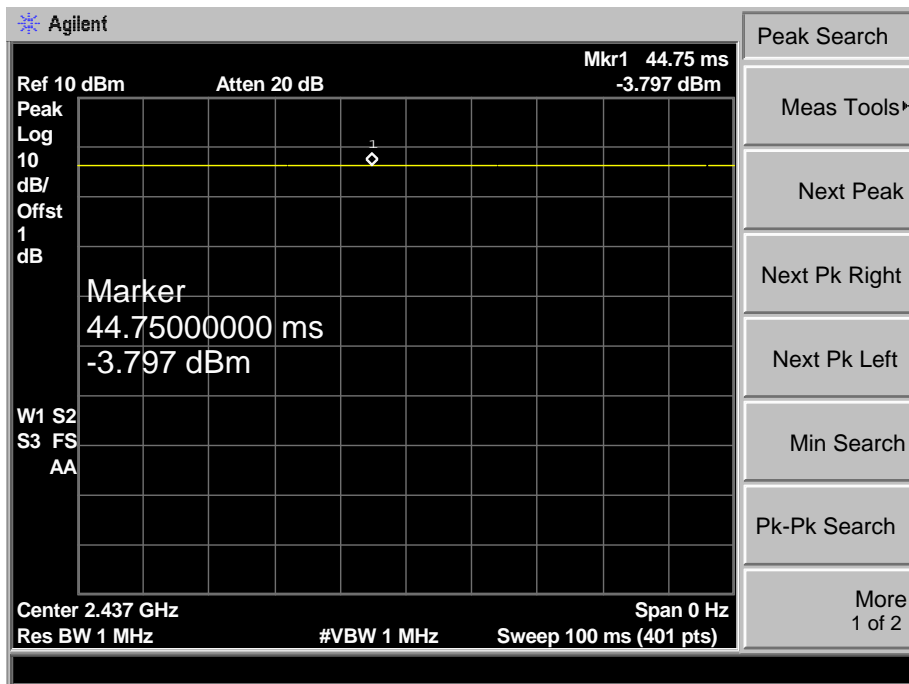

802.11 G Mode 2437 MHz

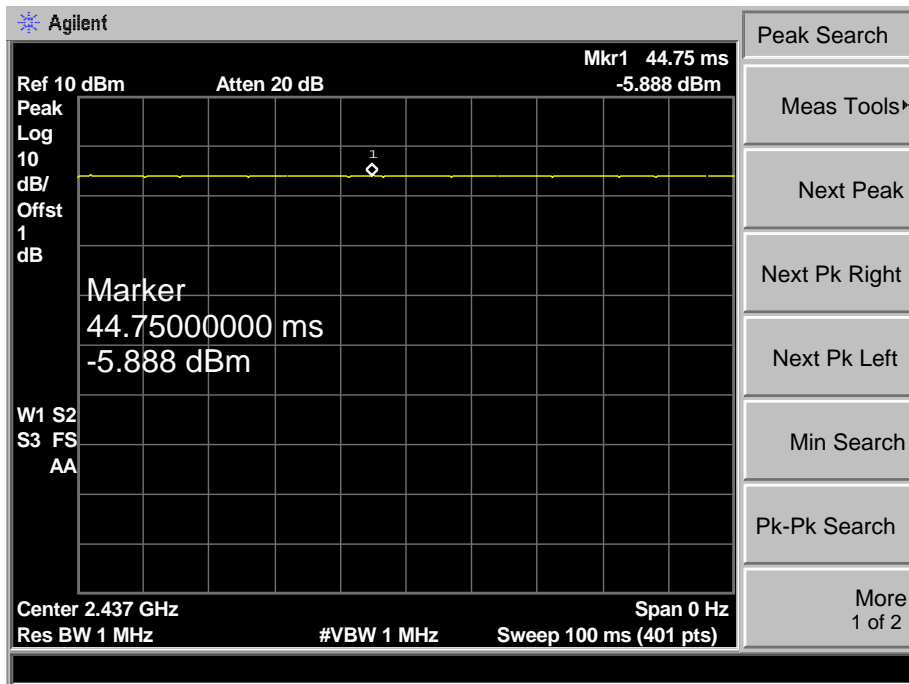

802.11 N(HT20) Mode 2437 MHz

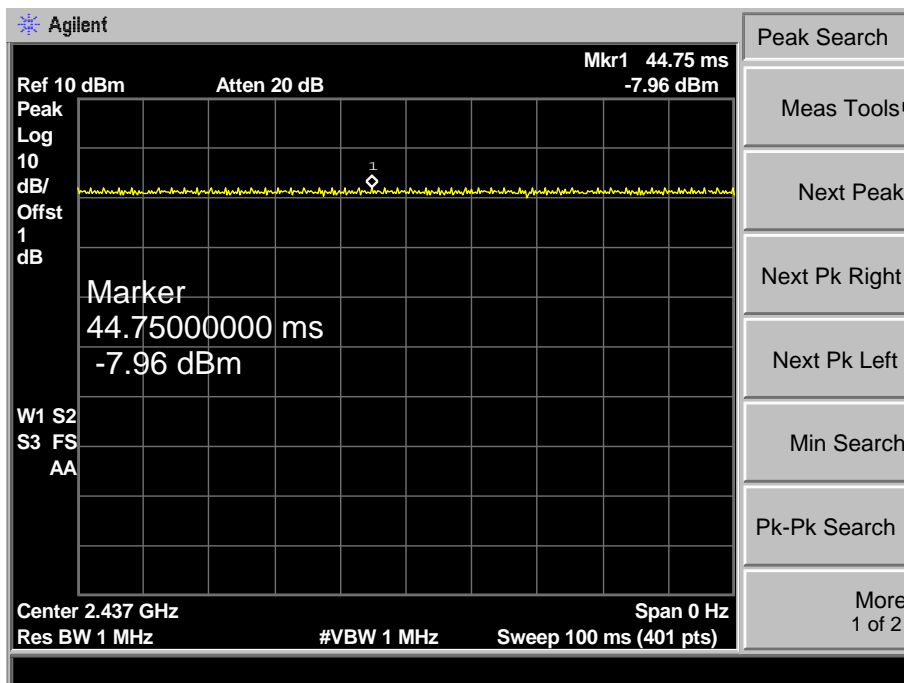

802.11 N(HT40) Mode 2437 MHz

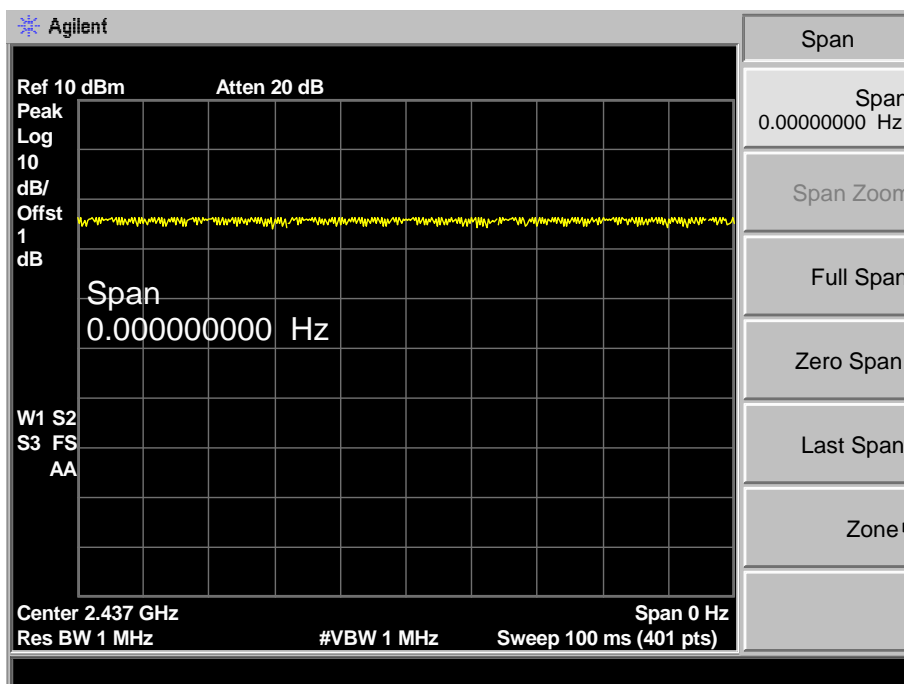

Attachment F-- Power Spectral Density Test Data

| 802.11b Mode | | | | | |
|---|-----------|----------------------------|----------|--------|-----------------------|
| Channel | Frequency | Conducted Power (dBm/3KHz) | | | Max. Limit (dBm/3KHz) |
| | | Main Ant. | Aux Ant. | Total | |
| 1 | 2412 MHz | -24.41 | -24.36 | --- | 8 |
| 6 | 2437 MHz | -24.69 | -24.72 | --- | |
| 11 | 2462 MHz | -25.05 | -25.12 | --- | |
| 802.11g Mode | | | | | |
| Channel | Frequency | Conducted Power (dBm/3KHz) | | | Max. Limit (dBm/3KHz) |
| | | Main Ant. | Aux Ant. | Total | |
| 1 | 2412 MHz | -25.57 | -25.77 | --- | 8 |
| 6 | 2437 MHz | -25.73 | -25.79 | --- | |
| 11 | 2462 MHz | -25.93 | -26.00 | --- | |
| 802.11n(HT20) Mode | | | | | |
| Channel | Frequency | Conducted Power (dBm/3KHz) | | | Max. Limit (dBm/3KHz) |
| | | Main Ant. | Aux Ant. | Total | |
| 1 | 2412 MHz | -29.31 | -29.77 | -26.52 | 8 |
| 6 | 2437 MHz | -29.27 | -29.66 | -26.45 | |
| 11 | 2462 MHz | -29.41 | -30.00 | -26.68 | |
| 802.11n(HT40) Mode | | | | | |
| Channel | Frequency | Conducted Power (dBm/3KHz) | | | Max. Limit (dBm/3KHz) |
| | | Main Ant. | Aux Ant. | Total | |
| 3 | 2422 MHz | -31.39 | -30.80 | -28.07 | 8 |
| 6 | 2437 MHz | -31.74 | -31.77 | -28.74 | |
| 9 | 2452 MHz | -31.09 | -30.60 | -27.83 | |
| Note: When Main ANT. and Aux ANT. transmitting simultaneously, the total Antenna Gain=Main Gain + Aux Gani =5.01 dBi<6 dBi. So $P_{out} = P_{limit} = 8$ | | | | | |
| Test plots please refer to below pages: | | | | | |

802.11 b 2412 MHz (Main ANT.)

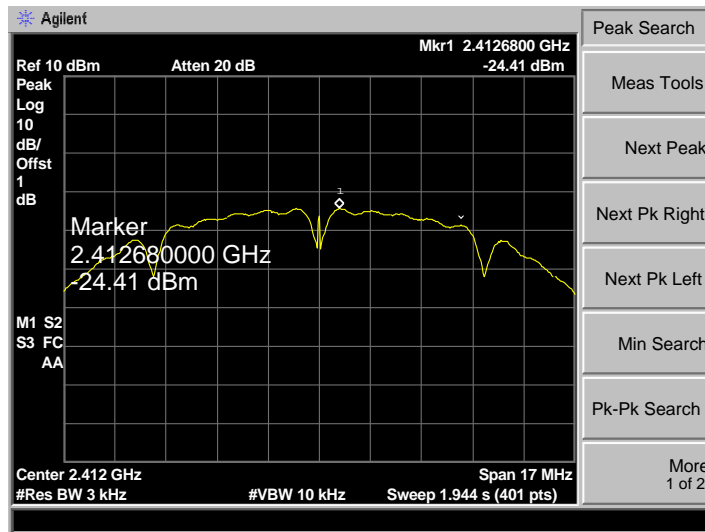

802.11 b 2437 MHz (Main ANT.)

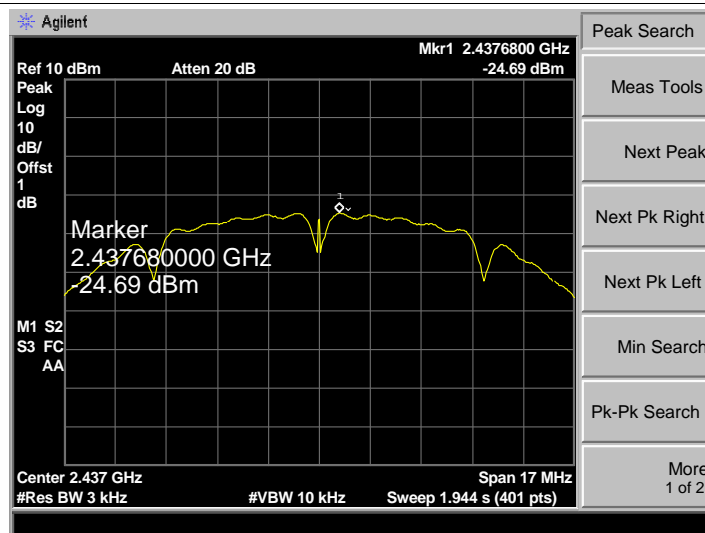

802.11 b 2462MHz (Main ANT.)

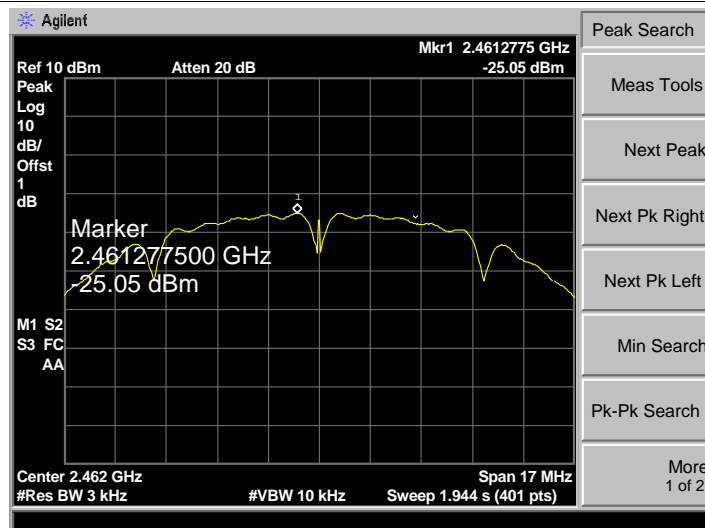

802.11 b 2412 MHz (Aux ANT.)

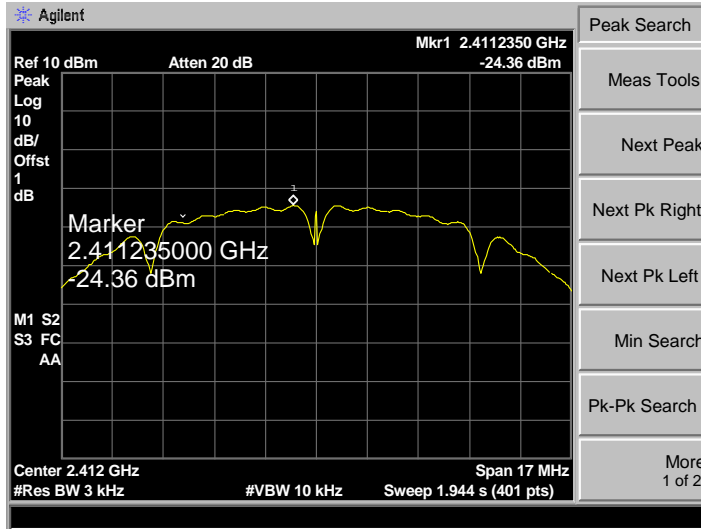

802.11 b 2437 MHz (Aux ANT.)

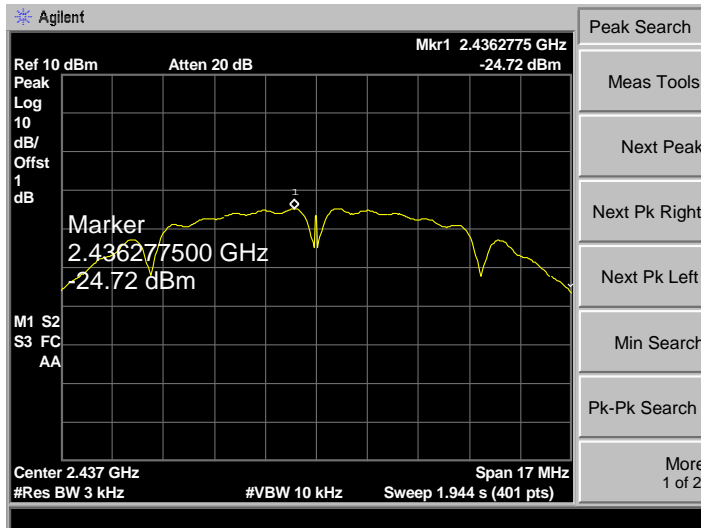

802.11 b 2462MHz (Aux ANT.)

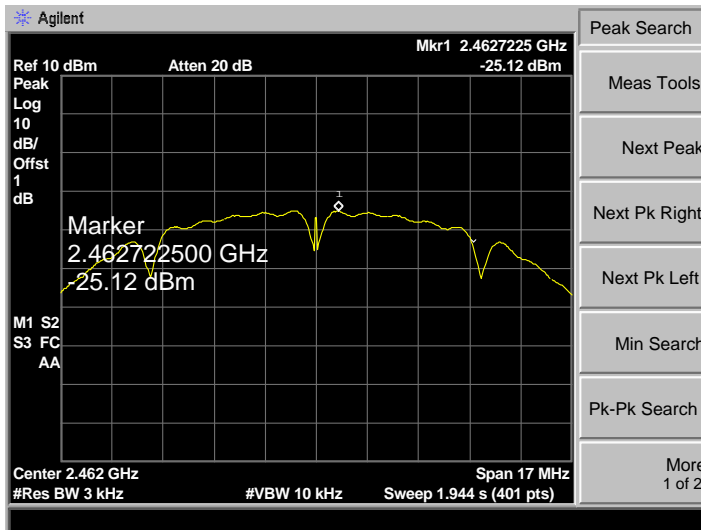

802.11 g 2412 MHz (Main ANT.)

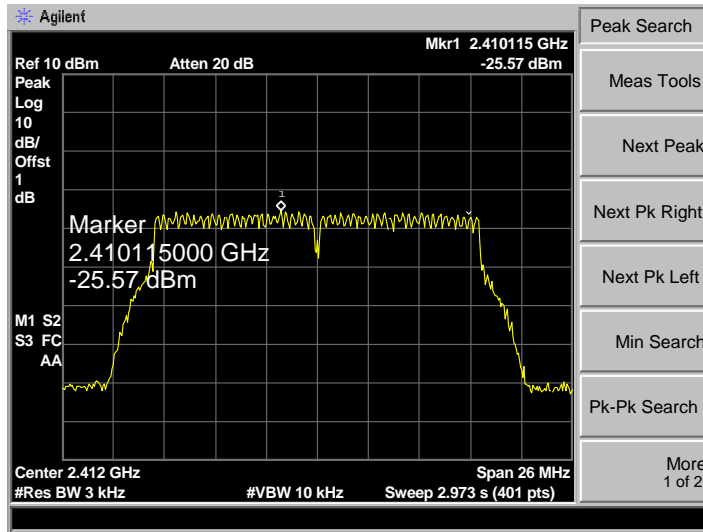

802.11 g 2437 MHz (Main ANT.)

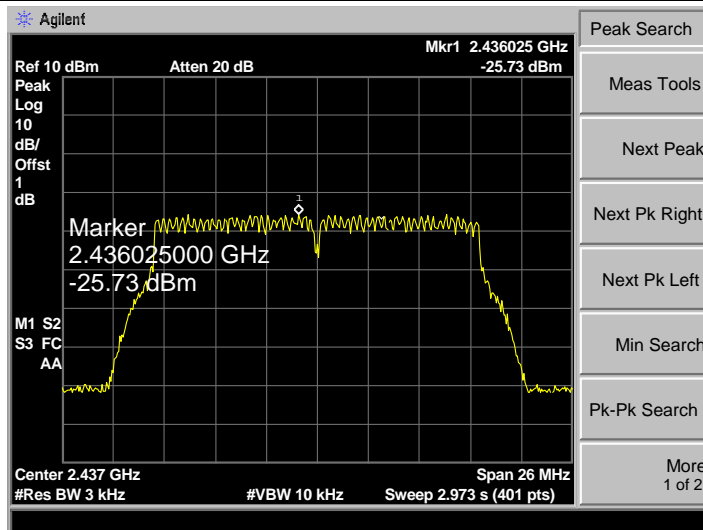

802.11 g 2462MHz (Main ANT.)

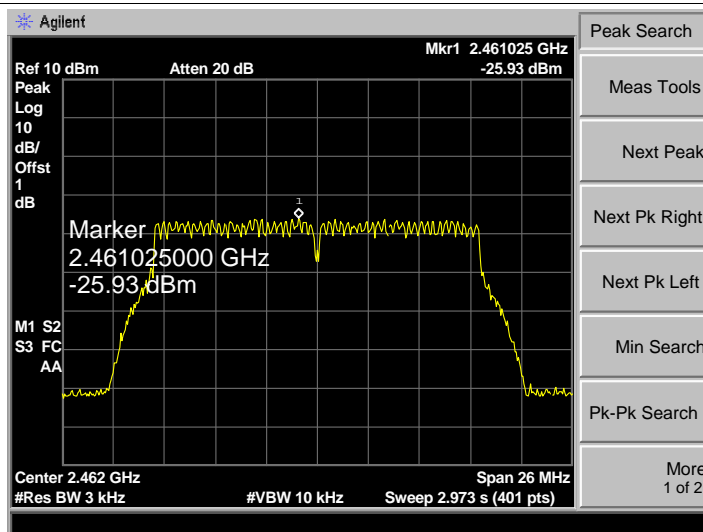

802.11 g 2412 MHz (Aux ANT.)

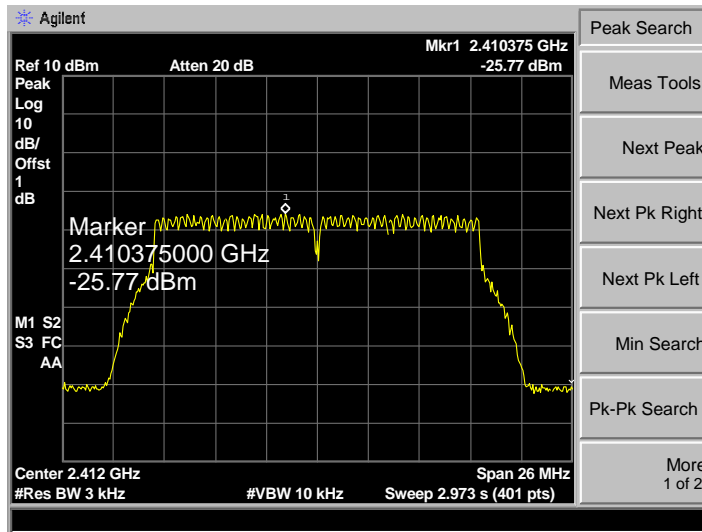

802.11 g 2437 MHz (Aux ANT.)

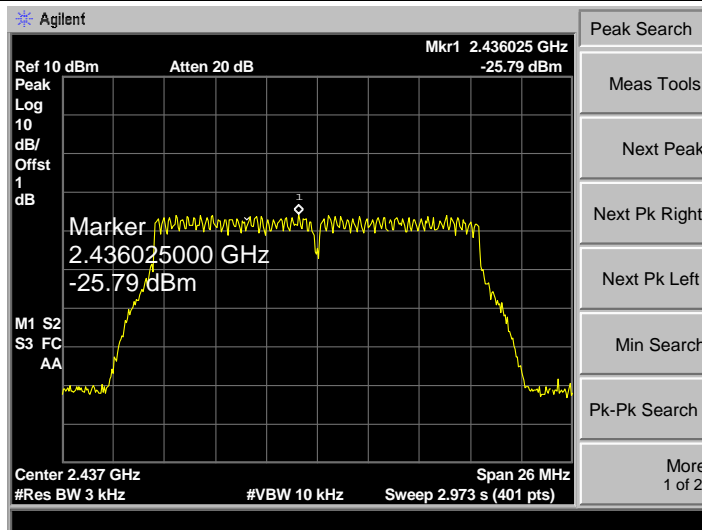

802.11 g 2462 MHz (Aux ANT.)

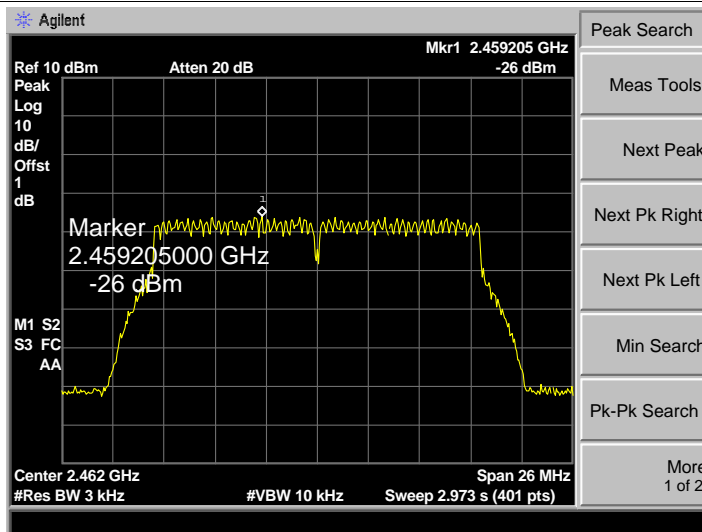

802.11 n(HT20) 2412 MHz (Main ANT.)

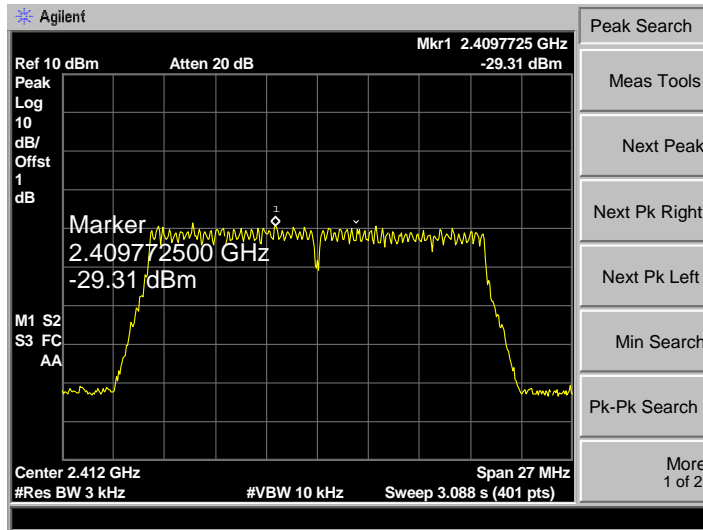

802.11 n(HT20) 2437 MHz (Main ANT.)

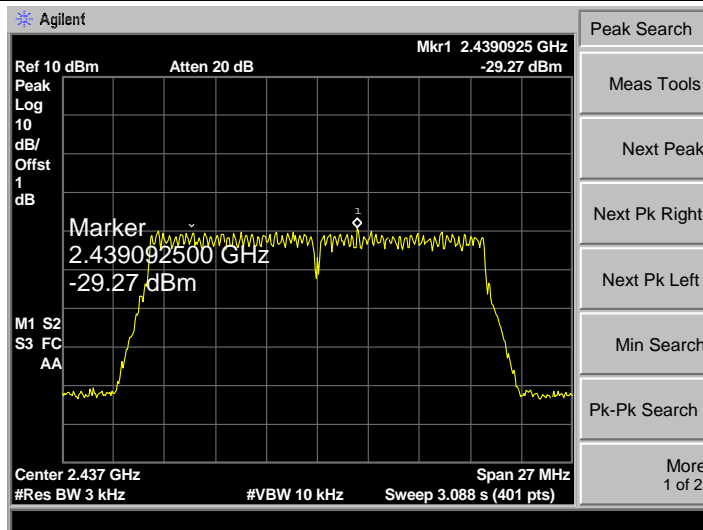

802.11 n(HT20) 2462MHz (Main ANT.)

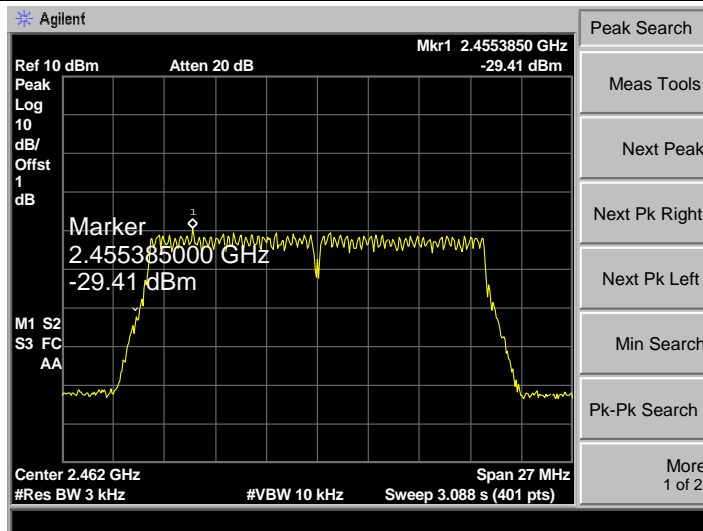

802.11 n(HT20) 2412 MHz (Aux ANT.)

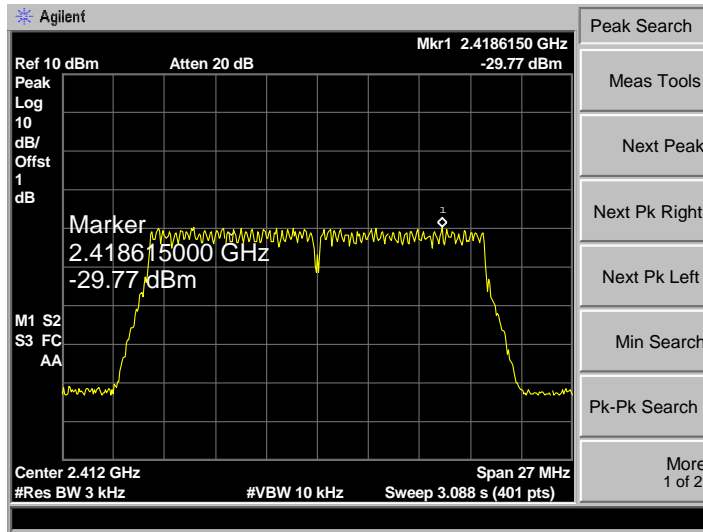

802.11 n(HT20) 2437 MHz (Aux ANT.)

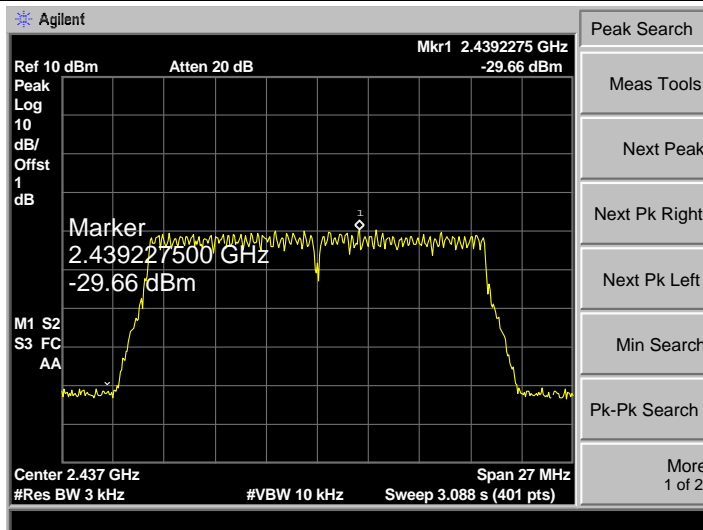

802.11 n(HT20) 2462MHz (Aux ANT.)

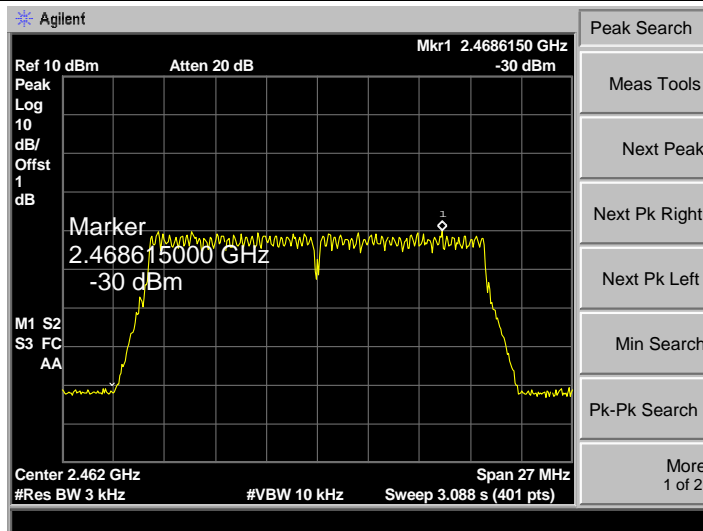

802.11 n(HT40) 2422 MHz (Main ANT.)

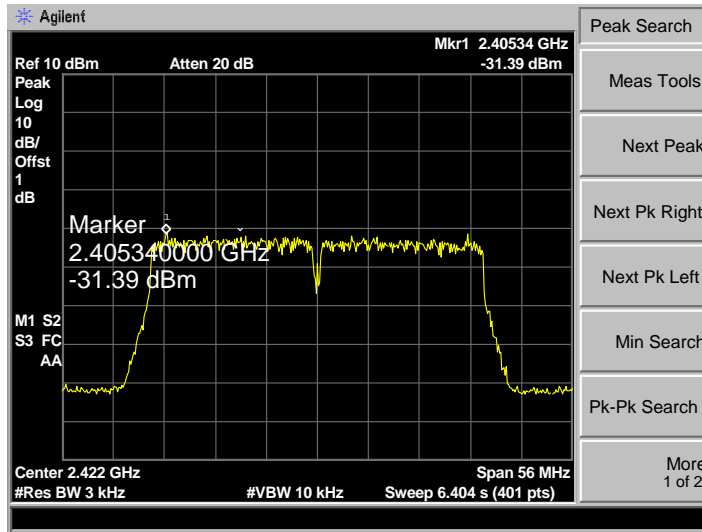

802.11 n(HT40) 2437 MHz (Main ANT.)

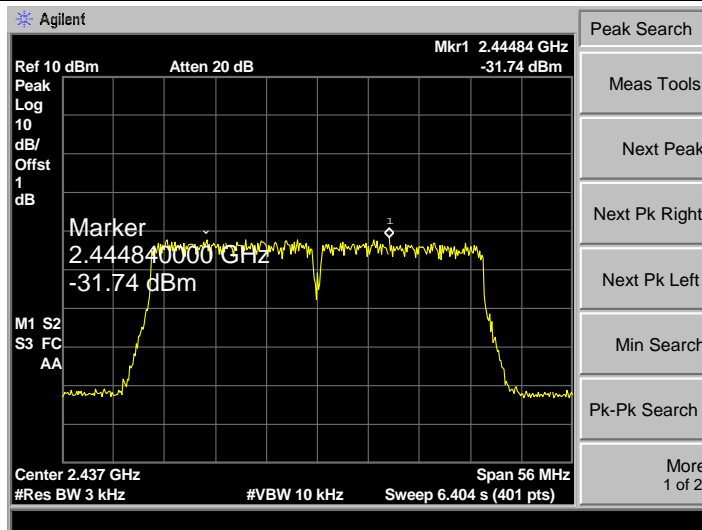

802.11 n(HT40) 2452MHz (Main ANT.)

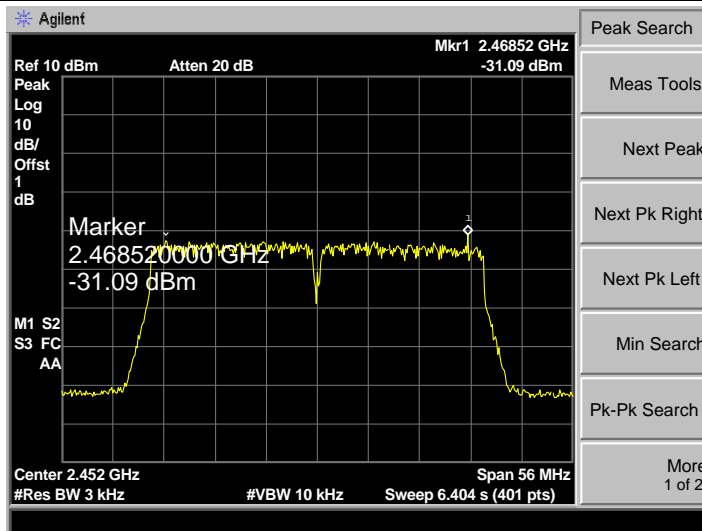

802.11 n(HT40) 2422 MHz (Aux ANT.)

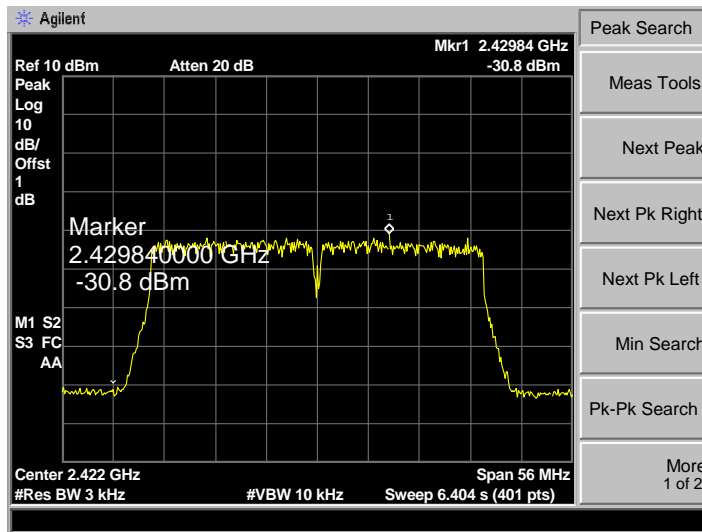

802.11 n(HT40) 2437 MHz (Aux ANT.)

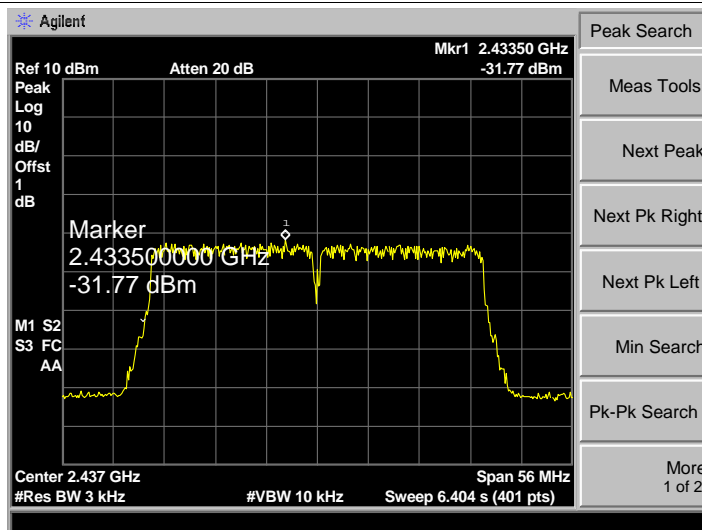

802.11 n(HT40) 2452MHz (Aux ANT.)

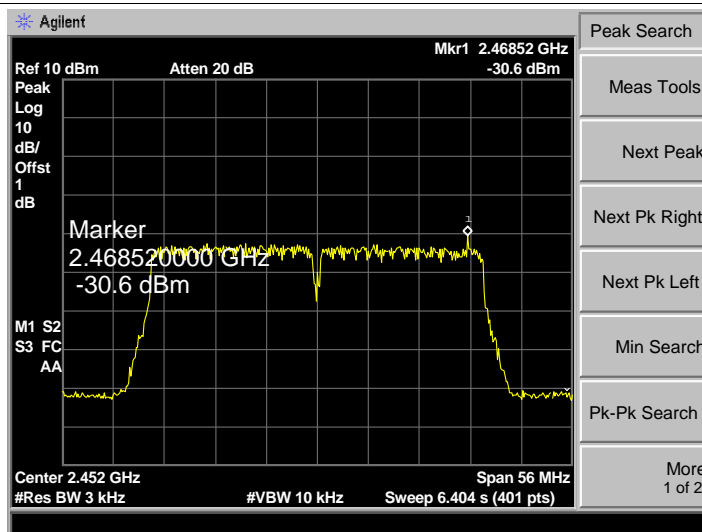

-----END OF REPORT-----