



SAR TEST REPORT

No. I18Z60848-SEM05

For

Shenzhen Tinno Mobile Technology Corp.
smart phone

Model Name: W-C210AE

With

Hardware Version: V0.3

Software Version: C210AE-V02

FCC ID: 2AM86WC210

Issued Date: 2018-8-7



Note:

The test results in this test report relate only to the devices specified in this report. This report shall not be reproduced except in full without the written approval of CTTL.

The report must not be used by the client to claim product certification, approval, or endorsement by NVLAP, NIST, or any agency of the U.S. Government.

Test Laboratory:

CTTL, Telecommunication Technology Labs, CAICT

No. 51, Huayuan North Road, Haidian District, Beijing, P. R. China 100191.

Tel:+86(0)10-62304633-2512, Fax:+86(0)10-62304633-2504

Email: ctl_terminals@caict.ac.cn, website: www.caict.ac.cn



REPORT HISTORY

Report Number	Revision	Issue Date	Description
I18Z60848-SEM05	Rev.0	2018-7-12	Initial creation of test report
I18Z60848-SEM05	Rev.1	2018-8-7	Add the conducted power of LTE 64QAM



TABLE OF CONTENT

1	TEST LABORATORY	5
1.1	TESTING LOCATION	5
1.2	TESTING ENVIRONMENT	5
1.3	PROJECT DATA	5
1.4	SIGNATURE	5
2	STATEMENT OF COMPLIANCE	6
3	CLIENT INFORMATION	8
3.1	APPLICANT INFORMATION	8
3.2	MANUFACTURER INFORMATION	8
4	EQUIPMENT UNDER TEST (EUT) AND ANCILLARY EQUIPMENT (AE)	9
4.1	ABOUT EUT	9
4.2	INTERNAL IDENTIFICATION OF EUT USED DURING THE TEST	9
4.3	INTERNAL IDENTIFICATION OF AE USED DURING THE TEST	9
5	TEST METHODOLOGY	10
5.1	APPLICABLE LIMIT REGULATIONS	10
5.2	APPLICABLE MEASUREMENT STANDARDS	10
6	SPECIFIC ABSORPTION RATE (SAR)	11
6.1	INTRODUCTION	11
6.2	SAR DEFINITION	11
7	TISSUE SIMULATING LIQUIDS	12
7.1	TARGETS FOR TISSUE SIMULATING LIQUID	12
7.2	DIELECTRIC PERFORMANCE	12
8	SYSTEM VERIFICATION	18
8.1	SYSTEM SETUP	18
8.2	SYSTEM VERIFICATION	19
9	MEASUREMENT PROCEDURES	20
9.1	TESTS TO BE PERFORMED	20
9.2	GENERAL MEASUREMENT PROCEDURE	22
9.1	CDMA MEASUREMENT PROCEDURES FOR SAR	23
9.2	WCDMA MEASUREMENT PROCEDURES FOR SAR	24
9.3	SAR MEASUREMENT FOR LTE	25
9.4	BLUETOOTH & WI-FI MEASUREMENT PROCEDURES FOR SAR	27
9.5	POWER DRIFT	28
10	AREA SCAN BASED 1-G SAR	28
10.1	REQUIREMENT OF KDB	28
10.2	FAST SAR ALGORITHMS	28

11	CONDUCTED OUTPUT POWER.....	29
11.1	CDMA MEASUREMENT RESULT	29
11.2	LTE MEASUREMENT RESULT	31
11.3	WI-FI AND BT MEASUREMENT RESULT	42
12	SIMULTANEOUS TX SAR CONSIDERATIONS	45
12.1	INTRODUCTION.....	45
12.2	TRANSMIT ANTENNA SEPARATION DISTANCES	45
12.3	SAR MEASUREMENT POSITIONS	45
12.4	STANDALONE SAR TEST EXCLUSION CONSIDERATIONS.....	46
13	EVALUATION OF SIMULTANEOUS.....	47
14	SAR TEST RESULT	48
14.1	SAR RESULTS	48
14.2	FULL SAR	62
14.3	WLAN EVALUATION	63
15	SAR MEASUREMENT VARIABILITY.....	66
16	MEASUREMENT UNCERTAINTY	67
16.1	MEASUREMENT UNCERTAINTY FOR NORMAL SAR TESTS (300MHZ~3GHZ)	67
16.2	MEASUREMENT UNCERTAINTY FOR NORMAL SAR TESTS (3~6GHZ).....	68
16.3	MEASUREMENT UNCERTAINTY FOR FAST SAR TESTS (300MHZ~3GHZ).....	69
16.4	MEASUREMENT UNCERTAINTY FOR FAST SAR TESTS (3~6GHZ).....	70
17	MAIN TEST INSTRUMENTS.....	72
ANNEX A	GRAPH RESULTS.....	73
ANNEX B	SYSTEM VERIFICATION RESULTS.....	99
ANNEX C	SAR MEASUREMENT SETUP	110
ANNEX D	POSITION OF THE WIRELESS DEVICE IN RELATION TO THE PHANTOM	116
ANNEX E	EQUIVALENT MEDIA RECIPES	119
ANNEX F	SYSTEM VALIDATION	120
ANNEX G	PROBE CALIBRATION CERTIFICATE	121
ANNEX H	DIPOLE CALIBRATION CERTIFICATE.....	132
ANNEX I	ACCREDITATION CERTIFICATE.....	172

1 Test Laboratory

1.1 Testing Location

Company Name:	CTTL(Shouxiang)
Address:	No. 51 Shouxiang Science Building, Xueyuan Road, Haidian District, Beijing, P. R. China100191

1.2 Testing Environment

Temperature:	18°C~25 °C,
Relative humidity:	30%~ 70%
Ground system resistance:	< 0.5 Ω
Ambient noise & Reflection:	< 0.012 W/kg

1.3 Project Data

Project Leader:	Qi Dianyuan
Test Engineer:	Lin Xiaojun
Testing Start Date:	June 20, 2018
Testing End Date:	June 24, 2018

1.4 Signature



Lin Xiaojun

(Prepared this test report)

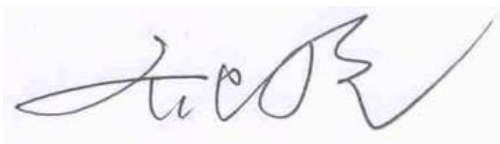

Qi Dianyuan

(Reviewed this test report)



Lu Bingsong

Deputy Director of the laboratory
(Approved this test report)

2 Statement of Compliance

The maximum results of SAR found during testing for Shenzhen Tinnno Mobile Technology Corp. smart phone W-C210AE is as follows:

Table 2.1: Highest Reported SAR (1g)

Exposure Configuration	Technology Band	Highest Reported SAR 1g (W/Kg)	Equipment Class
Head (Separation Distance 0mm)	CDMA BC0	0.13	PCE
	CDMA BC1	0.46	
	CDMA BC10	0.18	
	LTE Band 13	0.27	
	LTE Band 25	0.32	
	LTE Band 26	0.35	
	LTE Band 41	0.26	
	WLAN 2.4 GHz	0.95	DTS
Hotspot (Separation Distance 10mm)	CDMA BC0	0.63	PCE
	CDMA BC1	1.08	
	CDMA BC10	0.64	
	LTE Band 13	0.50	
	LTE Band 25	0.59	
	LTE Band 26	0.52	
	LTE Band 41	0.40	
	WLAN 2.4 GHz	0.20	DTS
Body Worn (Separation Distance 15mm)	CDMA BC1	0.92	PCE
	LTE Band 25	1.17	
	LTE Band 41	0.28	

The SAR values found for the Mobile Phone are below the maximum recommended levels of 1.6 W/Kg as averaged over any 1g tissue according to the ANSI C95.1-1992.

For body worn operation, this device has been tested and meets FCC RF exposure guidelines when used with any accessory that contains no metal and which provides a minimum separation distance of 10 mm between this device and the body of the user. Use of other accessories may not ensure compliance with FCC RF exposure guidelines.

The EUT battery must be fully charged and checked periodically during the test to ascertain uniform power output.

The measurement together with the test system set-up is described in annex C of this test report. A detailed description of the equipment under test can be found in chapter 4 of this test report.

The highest reported SAR value is obtained at the case of (**Table 2.1**), and the values are: **1.17 W/kg (1g)**.

Table 2.2: The sum of reported SAR values for main antenna and WiFi

	Position	Main antenna	WiFi	Sum
Highest reported SAR value for Head	Left hand, Touch cheek (CDMA BC1)	0.46	0.95	1.41
Highest reported SAR value for Body	Rear (LTE Band 25)	1.17	0.2	1.37

Table 2.3: The sum of reported SAR values for main antenna and BT

	Position	Main antenna	BT	Sum
Maximum reported SAR value for Head	Left hand, Touch cheek (CDMA BC1)	0.46	0.21	0.67
Maximum reported SAR value for Body 10mm	Rear (CDMA BC1)	1.08	0.10	1.18
Maximum reported SAR value for Body 15mm	Rear (LTE Band 25)	1.17	0.07	1.24

[1] - Estimated SAR for Bluetooth (see the table 13.3)

According to the above tables, the highest sum of reported SAR values is **1.41 W/kg (1g)**. The detail for simultaneous transmission consideration is described in chapter 13.



3 Client Information

3.1 Applicant Information

Company Name:	Wiko SAS
Address /Post:	1, rue Capitaine Dessemond 13007 - Marseille - France.
Contact Person:	Laurent Dahan
E-mail:	ldahan@wikomobile.com
Telephone:	33488089515
Fax:	33488089520

3.2 Manufacturer Information

Company Name:	Shenzhen Tinno Mobile Technology Corp.
Address /Post:	4/F, H-3 Building, OCT Eastern industrial Park, No.1 XiangShan East Road.,Nan Shan District, Shenzhen, P.R. China
Contact Person:	Jingwen.Guo
E-mail:	jingwen.guo@tinno.com
Telephone:	0755-86095550
Fax:	0755-86095551

4 Equipment Under Test (EUT) and Ancillary Equipment (AE)

4.1 About EUT

Description:	smart phone
Model name:	W-C210AE
Operating mode(s):	CDMA BC0/1/10,LTE Band 13/25/26/41,BT,WLAN
Tested Tx Frequency:	824.7 - 848.31 MHz (CDMA BC0)
	1851.25 - 1908.75 MHz (CDMA BC1)
	817.9 - 823.1 MHz (CDMA BC10)
	779.5 –784.5 MHz (LTE Band 13)
	1850.7 –1914.3 MHz (LTE Band 25)
	814.7–848.3 MHz (LTE Band 26)
	2498.5 – 2687.5 MHz (LTE Band41)
2412 – 2462 MHz (Wi-Fi 2.4G)	
Test device Production information:	Production unit
Device type:	Portable device
Antenna type:	Integrated antenna
Hotspot mode:	Support
Product dimension	Long 150mm ;Wide 72.6mm ; Overall Diagonal 166.65mm

4.2 Internal Identification of EUT used during the test

1	357960090021761	V0.3	C210AE-V02
2	357960090021803	V0.3	C210AE-V02

*EUT ID: is used to identify the test sample in the lab internally.

Note: It is performed to test SAR with the EUT1 and conducted power with the EUT2.

4.3 Internal Identification of AE used during the test

AE ID	Description	Model	SN	Manufactor
AE1	Battery	C210AEBATT0		Ningbo Veken Battery Co., Ltd

*AE ID: is used to identify the test sample in the lab internally.



5 TEST METHODOLOGY

5.1 Applicable Limit Regulations

ANSI C95.1–1992: IEEE Standard for Safety Levels with Respect to Human Exposure to Radio Frequency Electromagnetic Fields, 3 kHz to 300 GHz.

It specifies the maximum exposure limit of **1.6 W/kg** as averaged over any 1 gram of tissue for portable devices being used within 20 cm of the user in the uncontrolled environment.

5.2 Applicable Measurement Standards

IEEE 1528–2013: Recommended Practice for Determining the Peak Spatial-Average Specific Absorption Rate (SAR) in the Human Head from Wireless Communications Devices: Measurement Techniques.

KDB447498 D01 General RF Exposure Guidance v06: Mobile and Portable Devices RF Exposure Procedures and Equipment Authorization Policies.

KDB648474 D04 Handset SAR v01r03: SAR Evaluation Considerations for Wireless Handsets.

KDB941225 D01 SAR test for 3G devices v03r01: SAR Measurement Procedures for 3G Devices

KDB941225 D05 SAR for LTE Devices v02r05: SAR Evaluation Considerations for LTE Devices

KDB248227 D01 802.11 Wi-Fi SAR v02r02: SAR GUIDANCE FOR IEEE 802.11 (Wi-Fi) TRANSMITTERS

KDB865664 D01 SAR measurement 100 MHz to 6 GHz v01r04: SAR Measurement Requirements for 100 MHz to 6 GHz.

KDB865664 D02 RF Exposure Reporting v01r02: RF Exposure Compliance Reporting and Documentation Considerations

6 Specific Absorption Rate (SAR)

6.1 Introduction

SAR is related to the rate at which energy is absorbed per unit mass in an object exposed to a radio field. The SAR distribution in a biological body is complicated and is usually carried out by experimental techniques or numerical modeling. The standard recommends limits for two tiers of groups, occupational/controlled and general population/uncontrolled, based on a person's awareness and ability to exercise control over his or her exposure. In general, occupational/controlled exposure limits are higher than the limits for general population/uncontrolled.

6.2 SAR Definition

The SAR definition is the time derivative (rate) of the incremental energy (dW) absorbed by (dissipated in) an incremental mass (dm) contained in a volume element (dv) of a given density (ρ). The equation description is as below:

$$SAR = \frac{d}{dt} \left(\frac{dW}{dm} \right) = \frac{d}{dt} \left(\frac{dW}{\rho dv} \right)$$

SAR is expressed in units of Watts per kilogram (W/kg)

SAR measurement can be either related to the temperature elevation in tissue by

$$SAR = c \left(\frac{\delta T}{\delta t} \right)$$

Where: C is the specific heat capacity, δT is the temperature rise and δt is the exposure duration, or related to the electrical field in the tissue by

$$SAR = \frac{\sigma |E|^2}{\rho}$$

Where: σ is the conductivity of the tissue, ρ is the mass density of tissue and E is the RMS electrical field strength.

However for evaluating SAR of low power transmitter, electrical field measurement is typically applied.

7 Tissue Simulating Liquids

7.1 Targets for tissue simulating liquid

Table 7.1: Targets for tissue simulating liquid

Frequency(MHz)	Liquid Type	Conductivity(σ)	$\pm 5\%$ Range	Permittivity(ϵ)	$\pm 5\%$ Range
750	Head	0.89	0.85~0.93	41.94	39.8~44.0
750	Body	0.96	0.91~1.01	55.5	52.7~58.3
835	Head	0.90	0.86~0.95	41.5	39.4~43.6
835	Body	0.97	0.92~1.02	55.2	52.4~58.0
1900	Head	1.40	1.33~1.47	40.0	38.0~42.0
1900	Body	1.52	1.44~1.60	53.3	50.6~56.0
2450	Head	1.80	1.71~1.89	39.2	37.2~41.2
2450	Body	1.95	1.85~2.05	52.7	50.1~55.3
2600	Head	1.96	1.86~2.06	39.01	37.06~40.96
2600	Body	2.16	2.05~2.27	52.5	49.9~55.1

7.2 Dielectric Performance

Table 7.2: Dielectric Performance of Tissue Simulating Liquid

Measurement Date yyyy/mm/dd	Frequency	Type	Permittivity ϵ	Drift (%)	Conductivity σ (S/m)	Drift (%)
2018/6/20	750 MHz	Head	42.12	0.43	0.902	1.35
		Body	54.81	-1.24	0.962	0.21
2018/6/21	835 MHz	Head	41.3	-0.48	0.899	-0.11
		Body	54.4	-1.45	0.952	-1.86
2018/6/22	1900 MHz	Head	39.95	-0.12	1.418	1.29
		Body	54.08	1.46	1.502	-1.18
2018/6/23	2450 MHz	Head	38.75	-1.15	1.791	-0.50
		Body	52.09	-1.16	1.936	-0.72
2018/6/24	2600 MHz	Head	39.24	0.59	1.94	-1.02
		Body	53.51	1.92	2.131	-1.34

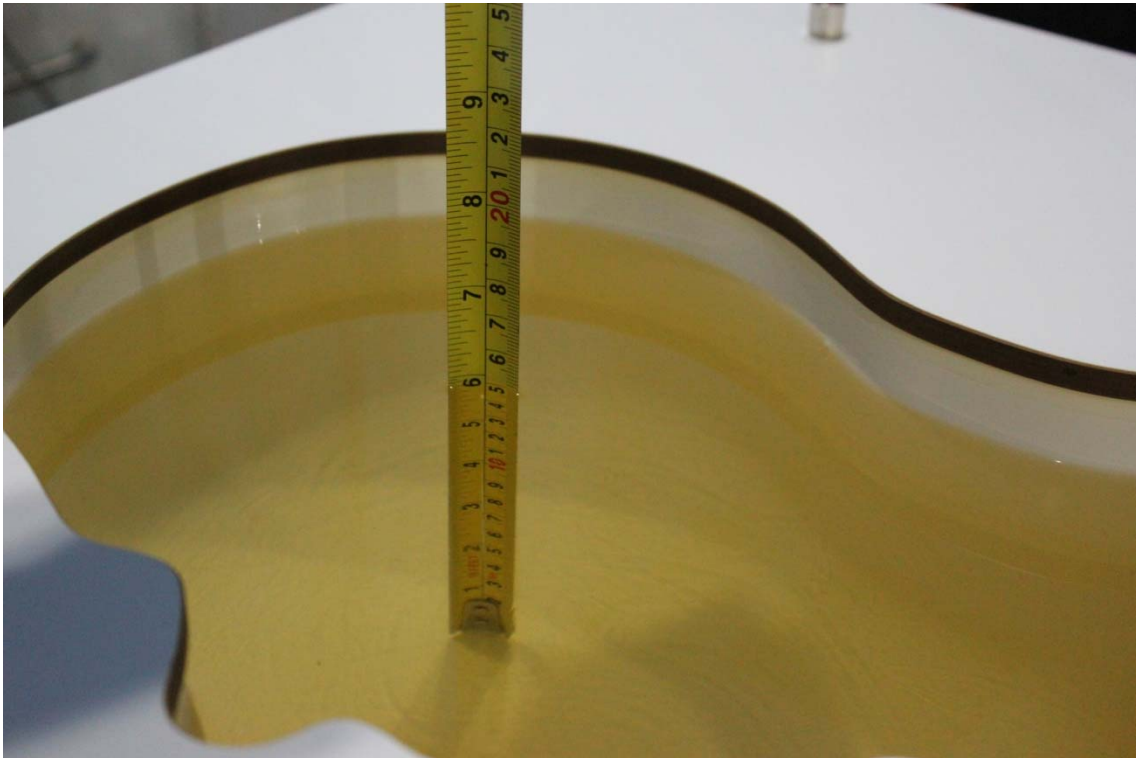

Picture 7-1 Liquid depth in the Head Phantom (750 MHz)



Picture 7-2 Liquid depth in the Flat Phantom (750 MHz)

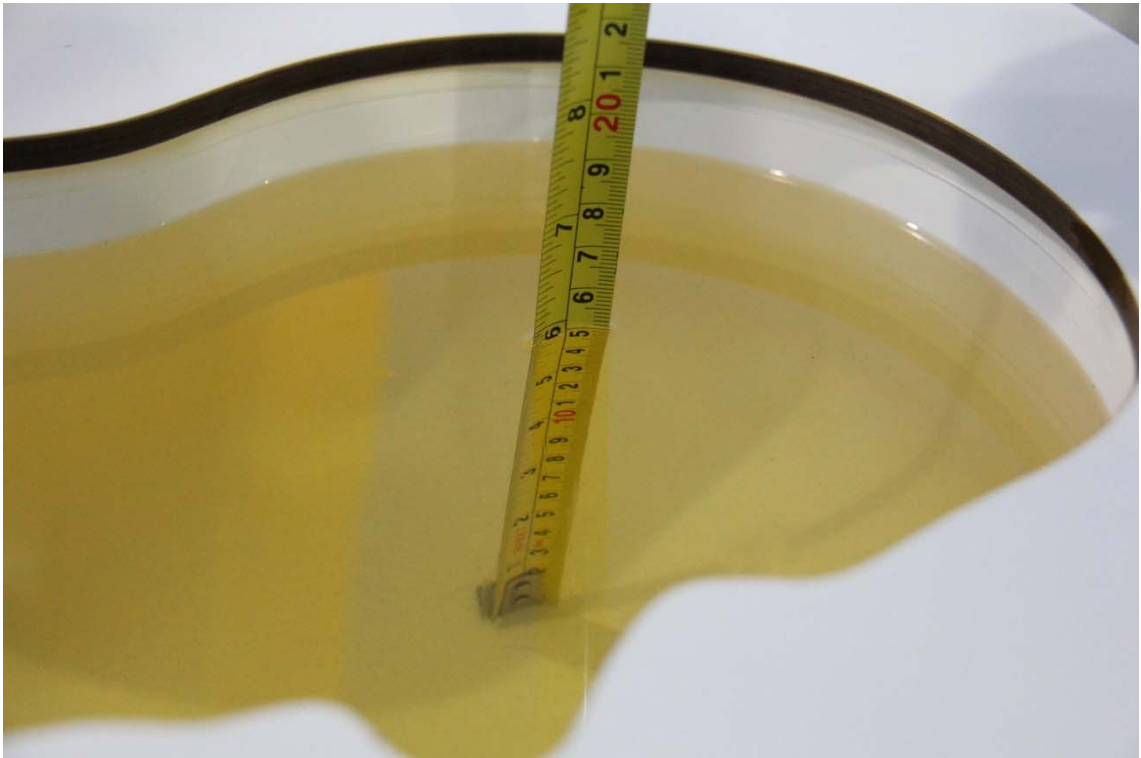

Picture 7-3 Liquid depth in the Head Phantom (835MHz)



Picture 7-4 Liquid depth in the Flat Phantom (835MHz)

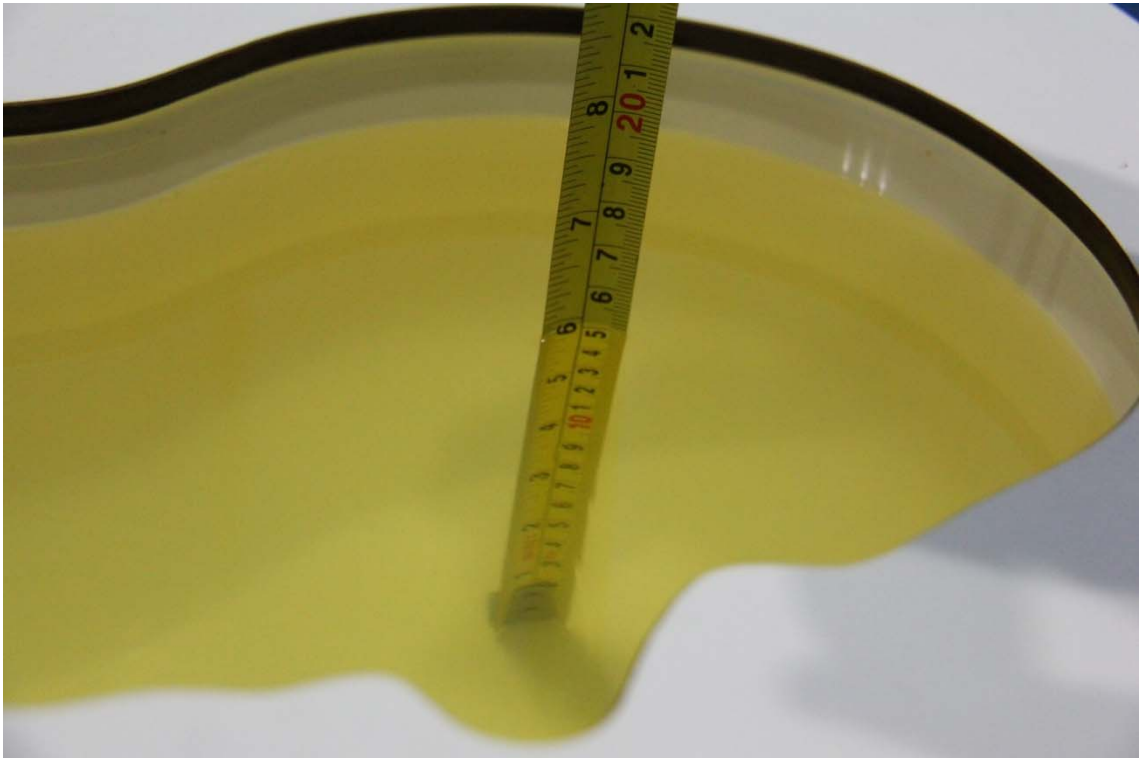

Picture 7-5 Liquid depth in the Head Phantom (1900 MHz)



Picture 7-6 Liquid depth in the Flat Phantom (1900MHz)



Picture 7-7 Liquid depth in the Head Phantom (2450MHz)

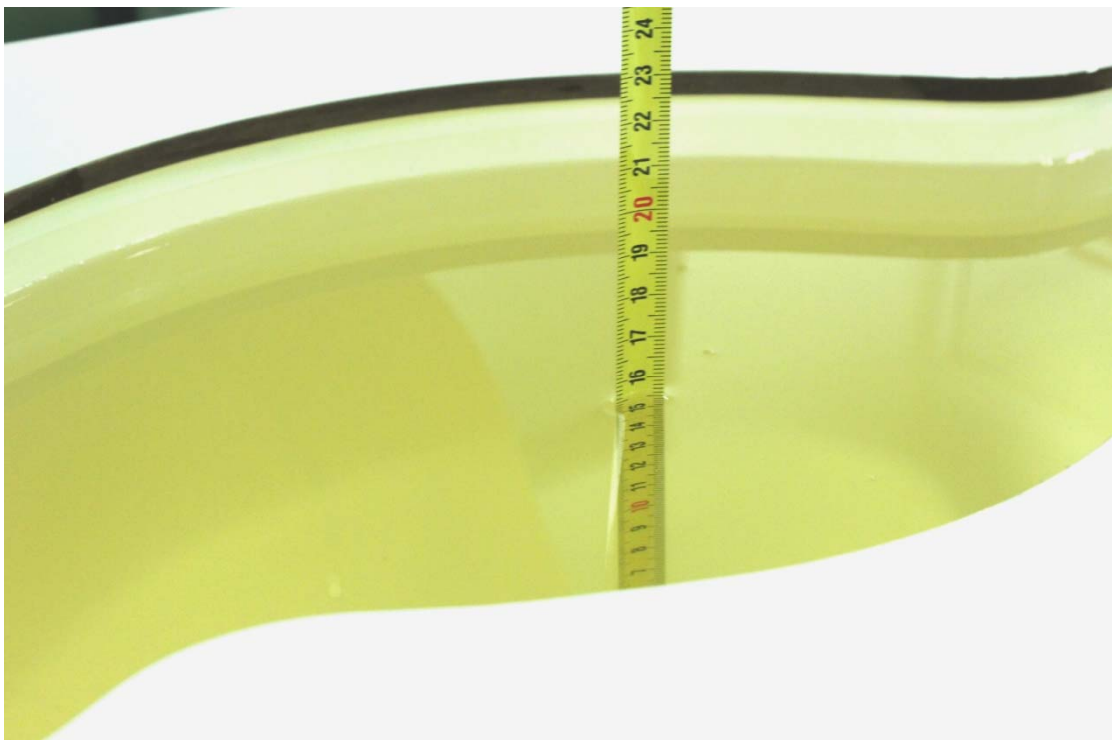

Picture 7-8 Liquid depth in the Flat Phantom (2450MHz)



Picture 7-9 Liquid depth in the Head Phantom (2600 MHz Head)

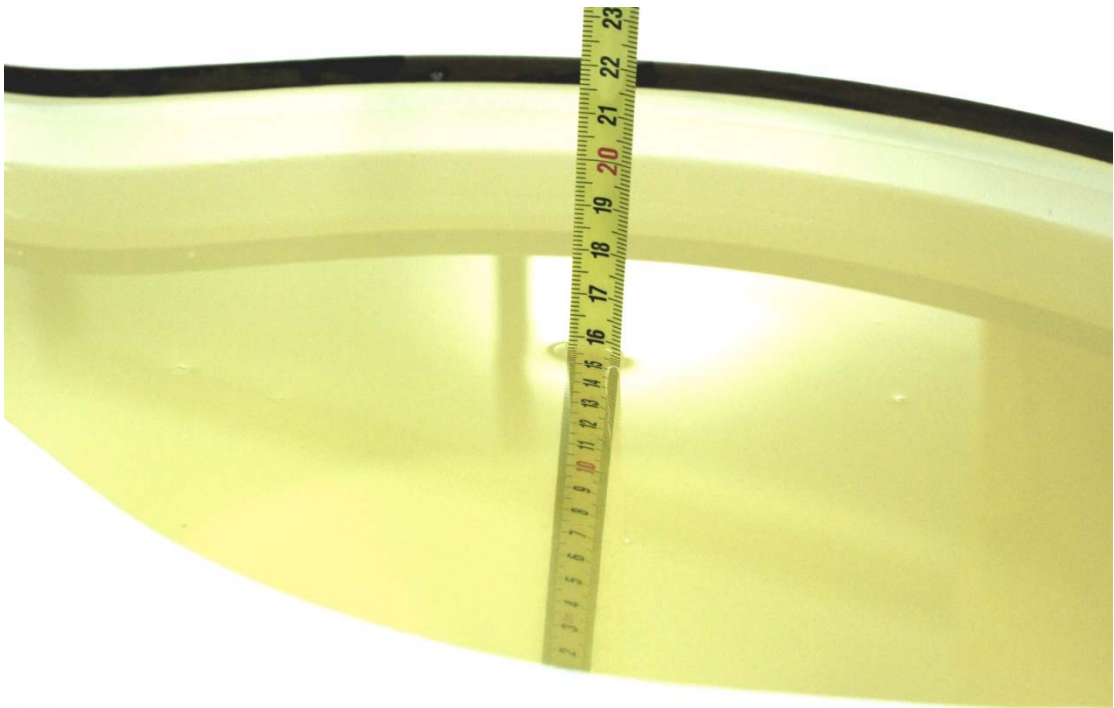

Picture 7-10 Liquid depth in the Flat Phantom (2600MHz)

8 System verification

8.1 System Setup

In the simplified setup for system evaluation, the DUT is replaced by a calibrated dipole and the power source is replaced by a continuous wave that comes from a signal generator. The calibrated dipole must be placed beneath the flat phantom section of the SAM twin phantom with the correct distance holder. The distance holder should touch the phantom surface with a light pressure at the reference marking and be oriented parallel to the long side of the phantom. The equipment setup is shown below:

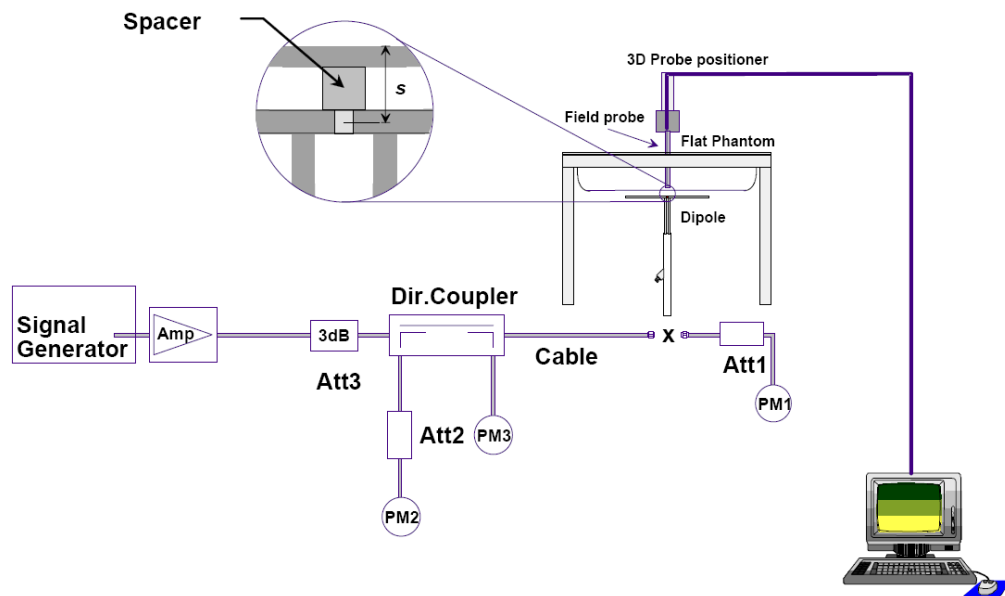

Picture 8.1 System Setup for System Evaluation



Picture 8.2 Photo of Dipole Setup

8.2 System Verification

SAR system verification is required to confirm measurement accuracy, according to the tissue dielectric media, probe calibration points and other system operating parameters required for measuring the SAR of a test device. The system verification must be performed for each frequency band and within the valid range of each probe calibration point required for testing the device.

The system verification results are required that the area scan estimated 1-g SAR is within 3% of the zoom scan 1-g SAR. The details are presented in annex B.

Table 8.1: System Verification of Head

Measurement Date (yyyy-mm-dd)	Frequency	Target value (W/kg)		Measured value (W/kg)		Deviation	
		10 g Average	1 g Average	10 g Average	1 g Average	10 g Average	1 g Average
2018/6/20	750 MHz	5.42	8.32	5.36	8.32	-1.11%	0.00%
2018/6/21	835 MHz	6.06	9.37	5.96	9.44	-1.65%	0.75%
2018/6/22	1900 MHz	21.0	40.0	20.64	40.32	-1.71%	0.80%
2018/6/23	2450 MHz	24.7	52.2	24.48	52	-0.89%	-0.38%
2018/6/24	2600 MHz	25.8	57.9	25.56	57.64	-0.93%	-0.45%

Table 8.2: System Verification of Body

Measurement Date (yyyy-mm-dd)	Frequency	Target value (W/kg)		Measured value (W/kg)		Deviation	
		10 g Average	1 g Average	10 g Average	1 g Average	10 g Average	1 g Average
2018/6/20	750 MHz	5.68	8.66	5.68	8.68	0.00%	0.23%
2018/6/21	835 MHz	6.12	9.41	6.2	9.32	1.31%	-0.96%
2018/6/22	1900 MHz	21.5	40.5	21.32	40.12	-0.84%	-0.94%
2018/6/23	2450 MHz	23.8	50.4	24.12	50.56	1.34%	0.32%
2018/6/24	2600 MHz	24.8	55.5	24.96	56.2	0.65%	1.26%

9 Measurement Procedures

9.1 Tests to be performed

In order to determine the highest value of the peak spatial-average SAR of a handset, all device positions, configurations and operational modes shall be tested for each frequency band according to steps 1 to 3 below. A flowchart of the test process is shown in picture 9.1.

Step 1: The tests described in 9.2 shall be performed at the channel that is closest to the center of the transmit frequency band (f_c) for:

- a) all device positions (cheek and tilt, for both left and right sides of the SAM phantom, as described in annex D),
- b) all configurations for each device position in a), e.g., antenna extended and retracted, and
- c) all operational modes, e.g., analogue and digital, for each device position in a) and configuration in b) in each frequency band.

If more than three frequencies need to be tested according to 11.1 (i.e., $N_c > 3$), then all frequencies, configurations and modes shall be tested for all of the above test conditions.

Step 2: For the condition providing highest peak spatial-average SAR determined in Step 1, perform all tests described in 9.2 at all other test frequencies, i.e., lowest and highest frequencies. In addition, for all other conditions (device position, configuration and operational mode) where the peak spatial-average SAR value determined in Step 1 is within 3 dB of the applicable SAR limit, it is recommended that all other test frequencies shall be tested as well.

Step 3: Examine all data to determine the highest value of the peak spatial-average SAR found in Steps 1 to 2.

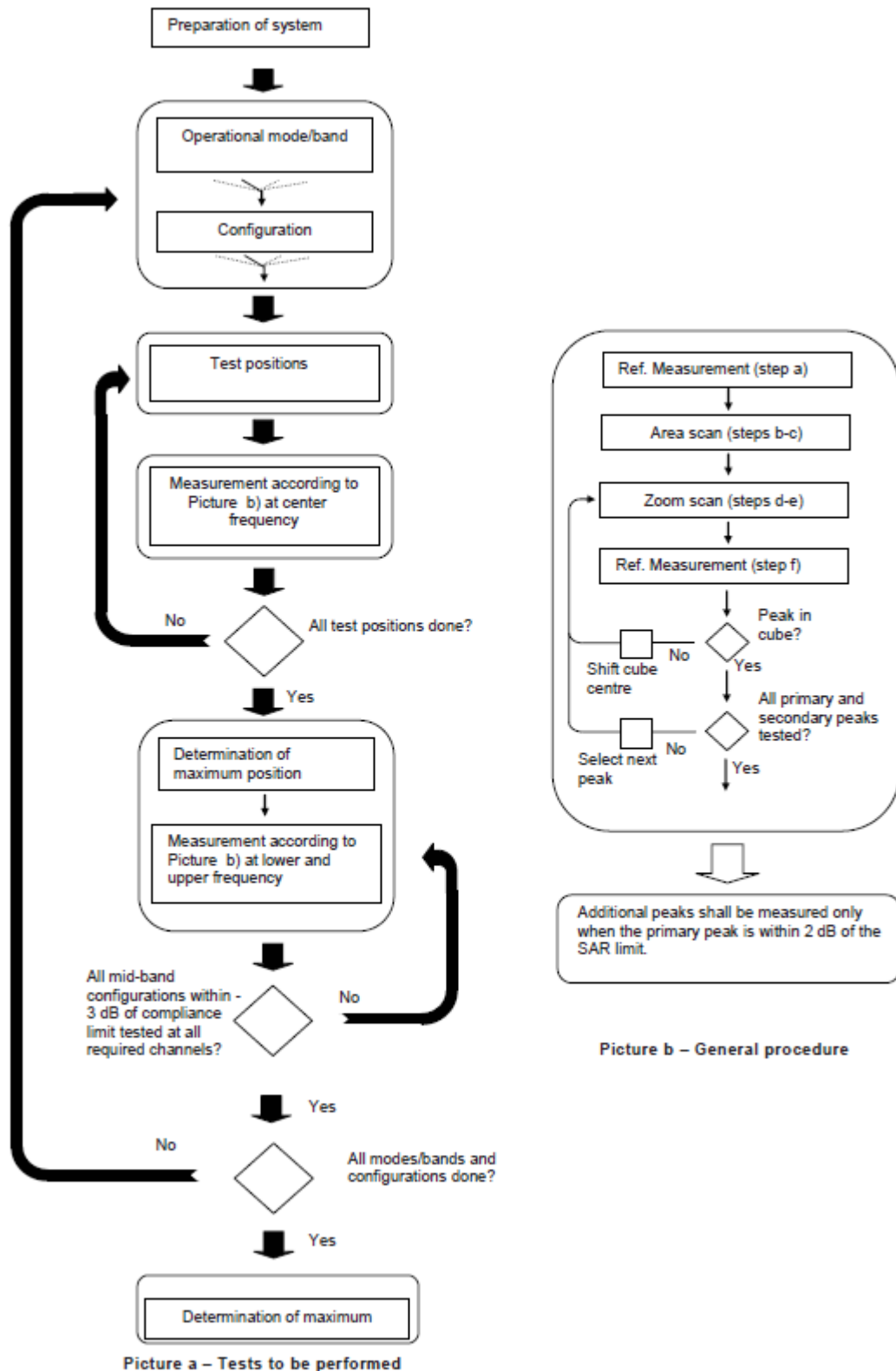

Picture 9.1 Block diagram of the tests to be performed

9.2 General Measurement Procedure

The area and zoom scan resolutions specified in the table below must be applied to the SAR measurements and fully documented in SAR reports to qualify for TCB approval. Probe boundary effect error compensation is required for measurements with the probe tip closer than half a probe tip diameter to the phantom surface. Both the probe tip diameter and sensor offset distance must satisfy measurement protocols; to ensure probe boundary effect errors are minimized and the higher fields closest to the phantom surface can be correctly measured and extrapolated to the phantom surface for computing 1-g SAR. Tolerances of the post-processing algorithms must be verified by the test laboratory for the scan resolutions used in the SAR measurements, according to the reference distribution functions specified in IEEE Std 1528-2013. The results should be documented as part of the system validation records and may be requested to support test results when all the measurement parameters in the following table are not satisfied.

		≤ 3 GHz	> 3 GHz
Maximum distance from closest measurement point (geometric center of probe sensors) to phantom surface		5 ± 1 mm	$\frac{1}{2} \delta \cdot \ln(2) \pm 0.5$ mm
Maximum probe angle from probe axis to phantom surface normal at the measurement location		$30^\circ \pm 1^\circ$	$20^\circ \pm 1^\circ$
Maximum area scan spatial resolution: Δx_{Area} , Δy_{Area}		≤ 2 GHz: ≤ 15 mm 2 – 3 GHz: ≤ 12 mm	3 – 4 GHz: ≤ 12 mm 4 – 6 GHz: ≤ 10 mm
		When the x or y dimension of the test device, in the measurement plane orientation, is smaller than the above, the measurement resolution must be \leq the corresponding x or y dimension of the test device with at least one measurement point on the test device.	
Maximum zoom scan spatial resolution: Δx_{Zoom} , Δy_{Zoom}		≤ 2 GHz: ≤ 8 mm 2 – 3 GHz: ≤ 5 mm*	3 – 4 GHz: ≤ 5 mm* 4 – 6 GHz: ≤ 4 mm*
Maximum zoom scan spatial resolution, normal to phantom surface	uniform grid: $\Delta z_{Zoom}(n)$	≤ 5 mm	3 – 4 GHz: ≤ 4 mm 4 – 5 GHz: ≤ 3 mm 5 – 6 GHz: ≤ 2 mm
	graded grid $\Delta z_{Zoom}(1)$: between 1 st two points closest to phantom surface	≤ 4 mm	3 – 4 GHz: ≤ 3 mm 4 – 5 GHz: ≤ 2.5 mm 5 – 6 GHz: ≤ 2 mm
	$\Delta z_{Zoom}(n>1)$: between subsequent points	$\leq 1.5 \cdot \Delta z_{Zoom}(n-1)$	
Minimum zoom scan volume	x, y, z	≥ 30 mm	3 – 4 GHz: ≥ 28 mm 4 – 5 GHz: ≥ 25 mm 5 – 6 GHz: ≥ 22 mm
Note: δ is the penetration depth of a plane-wave at normal incidence to the tissue medium; see draft standard IEEE P1528-2011 for details. * When zoom scan is required and the <i>reported</i> SAR from the area scan based 1-g SAR estimation procedures of KDB 447498 is ≤ 1.4 W/kg, ≤ 8 mm, ≤ 7 mm and ≤ 5 mm zoom scan resolution may be applied, respectively, for 2 GHz to 3 GHz, 3 GHz to 4 GHz and 4 GHz to 6 GHz.			

9.1 CDMA Measurement Procedures for SAR

3G SAR Test Reduction Procedure

In the following procedures, the mode tested for SAR is referred to as the primary mode. The equivalent modes considered for SAR test reduction are denoted as secondary modes. Both primary and secondary modes must be in the same frequency band. When the maximum output power and tune-up tolerance specified for production units in a secondary mode is $\leq \frac{1}{4}$ dB higher than the primary mode or when the highest reported SAR of the primary mode is scaled by the ratio of specified maximum output power and tune-up tolerance of secondary to primary mode and the adjusted SAR is ≤ 1.2 W/kg, SAR measurement is not required for the secondary mode.³ This is referred to as the 3G SAR test reduction procedure in the following SAR test guidance, where the primary mode is identified in the applicable wireless mode test procedures and the secondary mode is wireless mode being considered for SAR test reduction by that procedure. When the 3G SAR test reduction procedure is not satisfied, it is identified as “otherwise” in the applicable procedures; SAR measurement is required for the secondary mode.

1x Ev-Do Data Devices

The following procedures apply to Access Terminals (AT) operating under CDMA 2000 High Rate packet Data, 1x Ev-Do Rev. 0, Rev. A and Rev. B. SAR is required for devices with Ev-Do capabilities in body-worn accessory and other body exposure conditions, such as handsets, laptops, tablets and data modems operating in various consumer electronic devices. When VOIP is supported by Ev-Do devices for next to the ear use, head exposure SAR is required. The default test configuration is to measure SAR with an established radio link between the AT and a communication test set, according to 3GPP2 Test Application Protocols (TAP); FTAP/RTAP for Rev. 0, FETAP/RETAP for Rev. A and FMCTAP/RMCTAP for Rev. B. The code channel power levels, RF channel output power (with All Bits Up) and other operating parameters should be actively monitored and controlled by the communication test set during SAR measurement. The use of FTM should be avoided. Maximum output power is verified by applying the procedures defined in 3GPP2 C.S0033 and TIA-866. SAR must be measured according to these maximum output conditions and requirements in KDB Publication 447498 D01.

Output Power Verification

Maximum output power is verified on the high, middle and low channels according to procedures in section 3.1.2.3.4 of 3GPP2 C.S0033-0/TIA-866 for Rev. 0, section 4.3.4 of 3GPP2 C.S0033-A for Rev. A and section 4.3.4 of 3GPP2 C.S0033-C for Rev. B. Maximum output power is measured for Rev. 0 and Rev. A in Subtype 0/1 and Subtype 2 Physical Layer configurations, respectively. For Rev. B, maximum output power is measured according to power back-off requirements using Subtype 3 Physical Layer with “test 2” and “test 3” configurations. Power is measured using “test 2” with two carriers in the maximum frequency separation condition and “test 3” for N-adjacent carriers; where N is the maximum number of carriers supported by the device. Both “test 2” and “test 3” configurations are measured with the channels centered within the transmit frequency band. The device operating configurations under TAP/ETAP/MCTAP must be clearly documented in the test report; including power control, code channel and RF channel output power conditions. The measurement results are required in the SAR report with any measurement difficulties and equipment limitations clearly identified.

SAR Measurement

SAR is measured using the F/R TAP configurations required for Rev. 0, Rev. A and Rev. B. The AT is tested with a Reverse Data Channel rate of 153.6 kbps in Subtype 0/1 Physical Layer configurations. A Reverse Data Channel payload size of 4096 bits and Termination Target of 16 slots are used for Subtype 2 and 3. FTAP, FETAP and FMCTAP are all configured with a Forward Traffic Channel data rate corresponding to the 2-slot version of 307.2 kbps with ACK Channel transmitting in all slots. AT power control is in “All Bits Up” conditions for the TAP/ETAP/MCTAP.

Body-worn accessory and other body SAR are measured using Subtype 0/1 Physical Layer configurations for Rev. 0. The 3G SAR test reduction procedure is applied to Rev. A, Subtype 2 Physical layer configuration, with Rev. 0 as the primary mode; otherwise, SAR is measured for Rev. A using the highest *reported* SAR configuration for body-worn accessory exposure in Rev. 0. SAR is required for Rev. B, Subtype 3; it is measured by applying both the “test 2” and “test 3” configurations used for power measurement. Head SAR is required for Ev-Do devices that support next to the ear use according to the required handset test configurations; for example, with VOIP in Subtype 2 or Subtype 3 Physical Layer configurations.

1x RTT Support

For Ev-Do data devices that also support 1x RTT voice and/or data operations, the 3G SAR test reduction procedure is applied to 1x RTT RC3 and RC1 with Ev-Do Rev. 0, Rev. A and Rev. B as the respective primary modes.¹⁶ Otherwise, the ‘Body-Worn Accessory SAR’ procedures in the ‘3GPP2 CDMA 2000 1x Handsets’ section are applied.

9.2 WCDMA Measurement Procedures for SAR

The following procedures are applicable to WCDMA handsets operating under 3GPP Release99, Release 5 and Release 6. The default test configuration is to measure SAR with an established radio link between the DUT and a communication test set using a 12.2kbps RMC (reference measurement channel) configured in Test Loop Mode 1. SAR is selectively confirmed for other physical channel configurations (DPCCH & DPDCH_n), HSDPA and HSPA (HSUPA/HSDPA) modes according to output power, exposure conditions and device operating capabilities. Both uplink and downlink should be configured with the same RMC or AMR, when required. SAR for Release 5 HSDPA and Release 6 HSPA are measured using the applicable FRC (fixed reference channel) and E-DCH reference channel configurations. Maximum output power is verified according to applicable versions of 3GPP TS 34.121 and SAR must be measured according to these maximum output conditions. When Maximum Power Reduction (MPR) is not implemented according to Cubic Metric (CM) requirements for Release 6 HSPA, the following procedures do not apply.

For Release 5 HSDPA Data Devices:

Sub-test	β_c	β_d	β_d (SF)	β_c/β_d	β_{hs}	CM/dB
1	2/15	15/15	64	2/15	4/15	0.0
2	12/15	15/15	64	12/15	24/25	1.0
3	15/15	8/15	64	15/8	30/15	1.5
4	15/15	4/15	64	15/4	30/15	1.5

For Release 6 HSPA Data Devices

Sub-test	β_c	β_d	β_d (SF)	β_c / β_d	β_{hs}	β_{ec}	β_{ed}	β_{ed} (SF)	β_{ed} (codes)	CM (dB)	MPR (dB)	AG Index	E- TFCI
1	11/15	15/15	64	11/15	22/15	209/225	1039/225	4	1	1.5	1.5	20	75
2	6/15	15/15	64	6/15	12/15	12/15	12/15	4	1	1.5	1.5	12	67
3	15/15	9/15	64	15/9	30/15	30/15	$\beta_{ed1}:47/15$ $\beta_{ed2}:47/15$	4	2	1.5	1.5	15	92
4	2/15	15/15	64	2/15	4/15	4/15	56/75	4	1	1.5	1.5	17	71
5	15/15	15/15	64	15/15	24/15	30/15	134/15	4	1	1.5	1.5	21	81

Rel.8 DC-HSDPA (Cat 24)

SAR test exclusion for Rel.8 DC-HSDPA must satisfy the SAR test exclusion requirements of Rel.5 HSDPA. SAR test exclusion for DC-HSDPA devices is determined by power measurements according to the H-Set 12, Fixed Reference Channel (FRC) configuration in Table C.8.1.12 of 3GPP TS 34.121-1. A primary and a secondary serving HS-DSCH Cell are required to perform the power measurement and for the results to qualify for SAR test exclusion.

9.3 SAR Measurement for LTE

SAR tests for LTE are performed with a base station simulator, Rohde & Schwarz CMW500. Closed loop power control was used so the UE transmits with maximum output power during SAR testing. All powers were measured with the CMW 500.

It is performed for conducted power and SAR based on the KDB941225 D05.

SAR is evaluated separately according to the following procedures for the different test positions in each exposure condition – head, body, body-worn accessories and other use conditions. The procedures in the following subsections are applied separately to test each LTE frequency band.

1) QPSK with 1 RB allocation

Start with the largest channel bandwidth and measure SAR for QPSK with 1 RB allocation, using the RB offset and required test channel combination with the highest maximum output power among RB offsets at the upper edge, middle and lower edge of each required test channel. When the reported SAR is ≤ 0.8 W/kg, testing of the remaining RB offset configurations and required test channels is not required for 1 RB allocation; otherwise, SAR is required for the remaining required test channels and only for the RB offset configuration with the highest output power for that channel. When the reported SAR of a required test channel is > 1.45 W/kg, SAR is required for all three RB offset configurations for that required test channel.

2) QPSK with 50% RB allocation

The procedures required for 1 RB allocation in 1) are applied to measure the SAR for QPSK with 50% RB allocation.

3) QPSK with 100% RB allocation

For QPSK with 100% RB allocation, SAR is not required when the highest maximum output power for 100 % RB allocation is less than the highest maximum output power in 50% and 1 RB

allocations and the highest reported SAR for 1 RB and 50% RB allocation in 1) and 2) are ≤ 0.8 W/kg. Otherwise, SAR is measured for the highest output power channel; and if the reported SAR is > 1.45 W/kg, the remaining required test channels must also be tested.

TDD test:

TDD testing is performed using guidance from FCC KDB 941225 D05 v02r05 and the SAR test guidance provided in April 2013 TCB works hop notes. TDD is tested at the highest duty factor using UL-DL configuration 0 with special subframe configuration 6 and applying the FDD LTE procedures in KDB 941225 D05 v02r05. SAR testing is performed using the extended cyclic prefix listed in 3GPP TS 36.211.

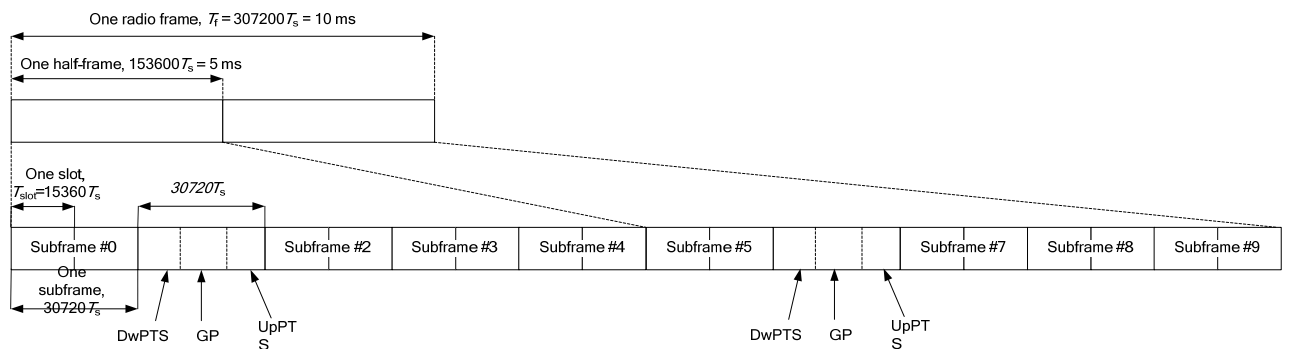

Figure 9.2: Frame structure type 2 (for 5 ms switch-point periodicity)

Table 9.1: Configuration of special subframe (lengths of DwPTS/GP/UpPTS)

Special subframe configuration	Normal cyclic prefix in downlink			Extended cyclic prefix in downlink		
	DwPTS	UpPTS		DwPTS	UpPTS	
		Normal cyclic prefix in uplink	Extended cyclic prefix in uplink		Normal cyclic prefix in uplink	Extended cyclic prefix in uplink
0	$6592 \cdot T_s$	$2192 \cdot T_s$	$2560 \cdot T_s$	$7680 \cdot T_s$	$2192 \cdot T_s$	$2560 \cdot T_s$
1	$19760 \cdot T_s$			$20480 \cdot T_s$		
2	$21952 \cdot T_s$			$23040 \cdot T_s$		
3	$24144 \cdot T_s$			$25600 \cdot T_s$		
4	$26336 \cdot T_s$			$7680 \cdot T_s$	$4384 \cdot T_s$	$5120 \cdot T_s$
5	$6592 \cdot T_s$	$20480 \cdot T_s$				
6	$19760 \cdot T_s$	$23040 \cdot T_s$				
7	$21952 \cdot T_s$	$12800 \cdot T_s$				
8	$24144 \cdot T_s$	-	-	-		
9	$13168 \cdot T_s$	-	-	-	-	

Table 9.2: Uplink-downlink configurations

Uplink-downlink configuration	Downlink-to-Uplink Switch-point periodicity	Subframe number									
		0	1	2	3	4	5	6	7	8	9
0	5 ms	D	S	U	U	U	D	S	U	U	U
1	5 ms	D	S	U	U	D	D	S	U	U	D
2	5 ms	D	S	U	D	D	D	S	U	D	D
3	10 ms	D	S	U	U	U	D	D	D	D	D
4	10 ms	D	S	U	U	D	D	D	D	D	D
5	10 ms	D	S	U	D	D	D	D	D	D	D
6	5 ms	D	S	U	U	U	D	S	U	U	D

Duty factor is calculated by:

$$\begin{aligned}
 \text{Duty factor} &= \text{uplink frame} * 6 + \text{UpPTS} * 2 / \text{one frame length} \\
 &= (30720 \cdot T_s * 6 + 5120 \cdot T_s * 2) / 307200 \cdot T_s \\
 &= 0.633
 \end{aligned}$$

According to the KDB 447498 D01, SAR should be evaluated at more than 3 frequencies for devices supporting transmit bands wider than 100MHz. Oct.2014 FCC-TCB conference notes (Dec. 2014 rev.) specifies the 5 test channels to use for 3GPP band 41 SAR evaluation.

9.4 Bluetooth & Wi-Fi Measurement Procedures for SAR

Normal network operating configurations are not suitable for measuring the SAR of 802.11 transmitters in general. Unpredictable fluctuations in network traffic and antenna diversity conditions can introduce undesirable variations in SAR results. The SAR for these devices should be measured using chipset based test mode software to ensure that the results are consistent and reliable.

Chipset based test mode software is hardware dependent and generally varies among manufacturers. The device operating parameters established in a test mode for SAR measurements must be identical to those programmed in production units, including output power levels, amplifier gain settings and other RF performance tuning parameters. The test frequencies should correspond to actual channel frequencies defined for domestic use. SAR for devices with switched diversity should be measured with only one antenna transmitting at a time during each SAR measurement, according to a fixed modulation and data rate. The same data pattern should be used for all measurements.

9.5 Power Drift

To control the output power stability during the SAR test, DASY4 system calculates the power drift by measuring the E-field at the same location at the beginning and at the end of the measurement for each test position. These drift values can be found in section 14 labeled as: (Power Drift [dB]). This ensures that the power drift during one measurement is within 5%.

10 Area Scan Based 1-g SAR

10.1 Requirement of KDB

According to the KDB447498 D01 v05, when the implementation is based the specific polynomial fit algorithm as presented at the 29th Bioelectromagnetics Society meeting (2007) and the estimated 1-g SAR is ≤ 1.2 W/kg, a zoom scan measurement is not required provided it is also not needed for any other purpose; for example, if the peak SAR location required for simultaneous transmission SAR test exclusion can be determined accurately by the SAR system or manually to discriminate between distinctive peaks and scattered noisy SAR distributions from area scans.

There must not be any warning or alert messages due to various measurement concerns identified by the SAR system; for example, noise in measurements, peaks too close to scan boundary, peaks are too sharp, spatial resolution and uncertainty issues etc. The SAR system verification must also demonstrate that the area scan estimated 1-g SAR is within 3% of the zoom scan 1-g SAR (See Annex B). When all the SAR results for each exposure condition in a frequency band and wireless mode are based on estimated 1-g SAR, the 1-g SAR for the highest SAR configuration must be determined by a zoom scan.

10.2 Fast SAR Algorithms

The approach is based on the area scan measurement applying a frequency dependent attenuation parameter. This attenuation parameter was empirically determined by analyzing a large number of phones. The MOTOROLA FAST SAR was developed and validated by the MOTOROLA Research Group in Ft. Lauderdale.

In the initial study, an approximation algorithm based on Linear fit was developed. The accuracy of the algorithm has been demonstrated across a broad frequency range (136-2450 MHz) and for both 1- and 10-g averaged SAR using a sample of 264 SAR measurements from 55 wireless handsets. For the sample size studied, the root-mean-squared errors of the algorithm are 1.2% and 5.8% for 1- and 10-g averaged SAR, respectively. The paper describing the algorithm in detail is expected to be published in August 2004 within the Special Issue of Transactions on MTT.

In the second step, the same research group optimized the fitting algorithm to an Polynomial fit whereby the frequency validity was extended to cover the range 30-6000MHz. Details of this study can be found in the BEMS 2007 Proceedings.

Both algorithms are implemented in DASY software.



11 Conducted Output Power

11.1 CDMA Measurement result

CDMA800-BC0 #1					
			Measured Power (dBm)		
Item		Tune-up	CH777 848.3 MHz	CH384 836.5 MHz	CH1013 824.7 MHz
1xRTT	SO55/RC1	25.50	23.75	23.70	23.67
	SO55/RC3	25.50	23.73	23.66	23.63
	SO32/RC3 (FCH only)	25.50	23.74	23.69	23.67
	SO32/RC3 (FCH+SCHn)	24.00	22.73	22.67	22.65
1xEVDO Rel.0	4.00	25.50	23.82	23.87	23.83
1xEVDO Rel.A	5.00	25.50	23.91	23.84	23.79

CDMA1900-BC1 #1					
			Measured Power (dBm)		
Item		Tune-up	CH1175 1908.75 MHz	CH600 1880 MHz	CH25 1851.25 MHz
1xRTT	SO55/RC1	21.00	19.71	19.75	19.83
	SO55/RC3	21.00	19.99	19.97	19.98
	SO32/RC3 (FCH only)	21.00	19.91	19.94	19.96
	SO32/RC3 (FCH+SCHn)	21.00	19.70	19.75	19.84
1xEVDO Rel.0	4.00	21.00	20.12	20.11	20.14
1xEVDO Rel.A	5.00	21.00	20.18	20.12	20.14



CDMA1900-BC1 #2					
			Measured Power (dBm)		
Item		Tune-up	CH1175 1908.75 MHz	CH600 1880 MHz	CH25 1851.25 MHz
1xRTT	SO55/RC1	25.00	23.71	23.87	23.82
	SO55/RC3	25.00	23.68	23.73	23.79
	SO32/RC3 (FCH only)	25.00	23.73	23.78	23.85
	SO32/RC3 (FCH+SCHn)	24.00	22.78	22.79	22.88
1xEVDO Rel.0	4.00	25.00	23.88	23.92	23.87
1xEVDO Rel.A	5.00	25.00	23.92	23.88	23.85

CDMA800-BC10 #1					
			Measured Power (dBm)		
Item		Tune-up	CH684 823.1 MHz	CH580 820.5 MHz	CH476 817.9 MHz
1xRTT	SO55/RC1	25.50	23.65	23.64	23.66
	SO55/RC3	25.50	23.61	23.60	23.62
	SO32/RC3 (FCH only)	25.50	23.64	23.63	23.65
	SO32/RC3 (FCH+SCHn)	24.00	22.63	22.62	22.64
1xEVDO Rel.0	4.00	25.50	23.75	23.78	23.84
1xEVDO Rel.A	5.00	25.50	23.77	23.74	23.72

11.2 LTE Measurement result

Table 11-1 LTE750-FDD13 #1

LTE750-FDD13 #1										
BandWidth	RB No./Start	Channel	Tune-up	Measured Power (dBm) & MPR						
				QPSK		16QAM		64QAM		
				Measured Power	MPR	Measured Power	MPR	Measured Power	MPR	
5MHz	1H	23255	24.5	22.67	0	21.81	1	20.56	2	
		23230	24.5	22.66	0	21.80	1	20.54	2	
		23205	24.5	22.61	0	22.07	1	20.52	2	
	1M	23255	24.5	22.92	0	22.04	1	20.53	2	
		23230	24.5	22.91	0	21.98	1	20.51	2	
		23205	24.5	22.89	0	22.34	1	20.55	2	
	1L	23255	24.5	22.63	0	21.67	1	20.52	2	
		23230	24.5	22.69	0	21.75	1	20.55	2	
		23205	24.5	22.67	0	22.13	1	20.61	2	
	12H	23255	24.5	21.75	1	20.73	2	20.59	3	
		23230	24.5	21.67	1	20.73	2	20.58	3	
		23205	24.5	21.75	1	20.82	2	20.56	3	
	12M	23255	24.5	21.82	1	20.82	2	19.54	3	
		23230	24.5	21.74	1	20.78	2	19.51	3	
		23205	24.5	21.80	1	20.87	2	19.56	3	
	12L	23255	24.5	21.79	1	20.79	2	19.51	3	
		23230	24.5	21.69	1	20.70	2	19.57	3	
		23205	24.5	21.57	1	20.66	2	19.51	3	
	25	23255	24.5	21.76	1	20.71	2	19.52	3	
		23230	24.5	21.67	1	20.67	2	19.58	3	
		23205	24.5	21.67	1	20.71	2	19.58	3	
	10MHz	1H	H	24.5		0		1		2
			M	24.5		0		1		2
			23230	24.5	22.68	0	21.72	1	20.55	2
1M		H	24.5		0		1		2	
		M	24.5		0		1		2	
		23230	24.5	22.77	0	21.63	1	20.67	2	
1L		H	24.5		0		1		2	
		M	24.5		0		1		2	
		23230	24.5	22.66	0	21.60	1	20.52	2	
25H		H	24.5		1		2		3	
		M	24.5		1		2		3	
		23230	24.5	21.74	1	20.70	2	19.51	3	
25M		H	24.5		1		2		3	
		M	24.5		1		2		3	
		23230	24.5	21.72	1	20.71	2	19.59	3	
25L		H	24.5		1		2		3	
		M	24.5		1		2		3	
		23230	24.5	21.64	1	20.65	2	19.56	3	
50		H	24.5		1		2		3	
		M	24.5		1		2		3	
		23230	24.5	21.71	1	20.66	2	19.51	3	



Table 11-2 LTE1900-FDD25 #1

LTE1900-FDD25 #1										
SN	Measured Power (dBm) & MPR									
	BandWidth	RB No./Start	Channel	Tune-up	QPSK		16QAM		64QAM	
					Measured Power	MPR	Measured Power	MPR	Measured Power	MPR
1.4MHz	1H	26683	18.5	17.47	0	17.68	0	17.71	0	
		26365	18.5	17.52	0	17.89	0	17.66	0	
		26047	18.5	17.44	0	17.60	0	17.80	0	
	1M	26683	18.5	17.62	0	17.85	0	17.79	0	
		26365	18.5	17.65	0	17.90	0	17.75	0	
		26047	18.5	17.63	0	17.73	0	17.87	0	
	1L	26683	18.5	17.47	0	17.69	0	17.77	0	
		26365	18.5	17.52	0	17.88	0	17.62	0	
		26047	18.5	17.43	0	17.55	0	17.79	0	
	3H	26683	18.5	17.66	0	17.65	0	17.71	0	
		26365	18.5	17.56	0	17.84	0	17.64	0	
		26047	18.5	17.55	0	17.78	0	17.73	0	
	3M	26683	18.5	17.65	0	17.68	0	17.69	0	
		26365	18.5	17.59	0	17.63	0	17.66	0	
		26047	18.5	17.60	0	17.79	0	17.74	0	
	3L	26683	18.5	17.61	0	17.66	0	17.70	0	
		26365	18.5	17.55	0	17.81	0	17.66	0	
		26047	18.5	17.53	0	17.76	0	17.70	0	
	6	26683	18.5	17.56	0	17.77	0	17.58	0	
		26365	18.5	17.53	0	17.52	0	17.56	0	
		26047	18.5	17.53	0	17.75	0	17.64	0	
										0
	3MHz	1H	26675	18.5	17.53	0	17.61	0	17.79	0
			26365	18.5	17.56	0	17.54	0	17.78	0
			26055	18.5	17.64	0	17.98	0	17.84	0
		1M	26675	18.5	17.68	0	17.81	0	17.74	0
			26365	18.5	17.66	0	17.39	0	17.75	0
26055			18.5	17.74	0	17.93	0	17.87	0	
1L		26675	18.5	17.59	0	17.70	0	17.77	0	
		26365	18.5	17.52	0	17.56	0	17.69	0	
		26055	18.5	17.64	0	17.99	0	17.85	0	
8H		26675	18.5	17.56	0	17.62	0	17.65	0	
		26365	18.5	17.52	0	17.58	0	17.63	0	
		26055	18.5	17.54	0	17.68	0	17.69	0	
8M		26675	18.5	17.62	0	17.67	0	17.71	0	
		26365	18.5	17.54	0	17.70	0	17.65	0	
		26055	18.5	17.55	0	17.73	0	17.73	0	
8L		26675	18.5	17.60	0	17.65	0	17.67	0	
		26365	18.5	17.59	0	17.75	0	17.63	0	
		26055	18.5	17.55	0	17.70	0	17.70	0	
15		26675	18.5	17.55	0	17.58	0	17.60	0	
		26365	18.5	17.56	0	17.57	0	17.60	0	
		26055	18.5	17.56	0	17.64	0	17.65	0	
										0
5MHz		1H	26665	18.5	17.55	0	17.67	0	17.71	0
			26365	18.5	17.56	0	17.69	0	17.67	0
			26065	18.5	17.55	0	17.85	0	17.76	0
		1M	26665	18.5	17.75	0	17.90	0	17.78	0
			26365	18.5	17.76	0	17.96	0	17.78	0
	26065		18.5	17.74	0	17.97	0	17.82	0	
	1L	26665	18.5	17.55	0	17.68	0	17.69	0	
		26365	18.5	17.54	0	17.72	0	17.65	0	
		26065	18.5	17.49	0	17.81	0	17.77	0	
	12H	26665	18.5	17.57	0	17.63	0	17.63	0	
		26365	18.5	17.54	0	17.61	0	17.57	0	
		26065	18.5	17.54	0	17.71	0	17.68	0	
	12M	26665	18.5	17.66	0	17.70	0	17.69	0	
		26365	18.5	17.61	0	17.68	0	17.63	0	
		26065	18.5	17.62	0	17.77	0	17.72	0	
	12L	26665	18.5	17.65	0	17.71	0	17.70	0	
		26365	18.5	17.60	0	17.66	0	17.64	0	
		26065	18.5	17.60	0	17.74	0	17.69	0	
	25	26665	18.5	17.57	0	17.60	0	17.67	0	
		26365	18.5	17.58	0	17.60	0	17.59	0	
		26065	18.5	17.56	0	17.67	0	17.68	0	



									0	
10MHz	1H	26640	18.5	17.49	0	17.61	0	17.81	0	
		26365	18.5	17.54	0	17.53	0	17.69	0	
		26090	18.5	17.63	0	17.98	0	17.83	0	
	1M	26640	18.5	17.71	0	17.69	0	17.84	0	
		26365	18.5	17.65	0	17.67	0	17.89	0	
		26090	18.5	17.82	0	17.85	0	17.92	0	
	1L	26640	18.5	17.49	0	17.58	0	17.77	0	
		26365	18.5	17.49	0	17.53	0	17.76	0	
		26090	18.5	17.58	0	17.95	0	17.80	0	
	25H	26640	18.5	17.48	0	17.62	0	17.55	0	
		26365	18.5	17.51	0	17.58	0	17.56	0	
		26090	18.5	17.58	0	17.68	0	17.69	0	
	25M	26640	18.5	17.56	0	17.72	0	17.66	0	
		26365	18.5	17.58	0	17.68	0	17.63	0	
		26090	18.5	17.65	0	17.70	0	17.70	0	
	25L	26640	18.5	17.69	0	17.72	0	17.72	0	
		26365	18.5	17.63	0	17.65	0	17.60	0	
		26090	18.5	17.56	0	17.67	0	17.67	0	
	50	26640	18.5	17.57	0	17.66	0	17.66	0	
		26365	18.5	17.58	0	17.59	0	17.59	0	
		26090	18.5	17.60	0	17.66	0	17.67	0	
									0	
	15MHz	1H	26615	18.5	17.50	0	17.99	0	17.72	0
			26365	18.5	17.48	0	17.49	0	17.67	0
			26115	18.5	17.53	0	17.88	0	17.70	0
		1M	26615	18.5	17.60	0	17.89	0	17.77	0
			26365	18.5	17.58	0	17.57	0	17.77	0
26115			18.5	17.66	0	17.82	0	17.88	0	
1L		26615	18.5	17.51	0	17.84	0	17.69	0	
		26365	18.5	17.50	0	17.51	0	17.71	0	
		26115	18.5	17.50	0	17.88	0	17.78	0	
36H		26615	18.5	17.55	0	17.51	0	17.57	0	
		26365	18.5	17.54	0	17.55	0	17.58	0	
		26115	18.5	17.63	0	17.70	0	17.70	0	
36M		26615	18.5	17.66	0	17.64	0	17.68	0	
		26365	18.5	17.61	0	17.63	0	17.63	0	
		26115	18.5	17.61	0	17.68	0	17.69	0	
36L		26615	18.5	17.63	0	17.60	0	17.65	0	
		26365	18.5	17.61	0	17.59	0	17.63	0	
		26115	18.5	17.54	0	17.69	0	17.67	0	
75		26615	18.5	17.58	0	17.59	0	17.61	0	
		26365	18.5	17.58	0	17.60	0	17.59	0	
		26115	18.5	17.56	0	17.62	0	17.66	0	
									0	
20MHz		1H	26590	18.5	17.31	0	17.68	0	17.63	0
			26365	18.5	17.32	0	17.79	0	17.52	0
			26140	18.5	17.38	0	17.83	0	17.57	0
		1M	26590	18.5	17.74	0	17.85	0	17.86	0
			26365	18.5	17.69	0	17.91	0	17.87	0
	26140		18.5	17.77	0	17.98	0	17.97	0	
	1L	26590	18.5	17.34	0	17.68	0	17.56	0	
		26365	18.5	17.33	0	17.79	0	17.58	0	
		26140	18.5	17.32	0	17.66	0	17.61	0	
	50H	26590	18.5	17.40	0	17.44	0	17.48	0	
		26365	18.5	17.54	0	17.55	0	17.59	0	
		26140	18.5	17.67	0	17.76	0	17.70	0	
	50M	26590	18.5	17.61	0	17.63	0	17.67	0	
		26365	18.5	17.58	0	17.61	0	17.64	0	
		26140	18.5	17.62	0	17.70	0	17.69	0	
	50L	26590	18.5	17.61	0	17.60	0	17.67	0	
		26365	18.5	17.62	0	17.60	0	17.65	0	
		26140	18.5	17.54	0	17.61	0	17.65	0	
	100	26590	18.5	17.53	0	17.55	0	17.58	0	
		26365	18.5	17.60	0	17.55	0	17.58	0	
		26140	18.5	17.66	0	17.72	0	17.68	0	



Table 11-3 LTE1900-FDD25 #2

LTE1900-FDD25 #2										
SN				Measured Power (dBm) & MPR						
BandWidth	RB No./Start	Channel	Tune-up	QPSK		16QAM		64QAM		
				Measured Power	MPR	Measured Power	MPR	Measured Power	MPR	
1.4MHz	1H	26683	24	22.93	0	22.27	1	20.68	2	
		26365	24	22.88	0	21.98	1	20.81	2	
		26047	24	22.85	0	22.05	1	20.81	2	
	1M	26683	24	23.10	0	22.40	1	20.89	2	
		26365	24	23.09	0	22.11	1	20.97	2	
		26047	24	23.03	0	22.04	1	20.87	2	
	1L	26683	24	22.92	0	22.27	1	20.66	2	
		26365	24	22.91	0	22.01	1	20.61	2	
		26047	24	22.89	0	22.03	1	20.68	2	
	3H	26683	24	22.98	0	22.16	1	20.54	2	
		26365	24	22.95	0	22.19	1	20.88	2	
		26047	24	22.92	0	22.08	1	20.80	2	
	3M	26683	24	22.99	0	22.19	1	20.72	2	
		26365	24	23.02	0	22.20	1	20.63	2	
		26047	24	23.00	0	22.11	1	20.66	2	
	3L	26683	24	22.98	0	22.16	1	20.81	2	
		26365	24	22.97	0	22.15	1	20.91	2	
		26047	24	22.97	0	21.99	1	20.78	2	
	6	26683	24	22.08	1	20.93	2	19.70	3	
		26365	24	22.04	1	21.21	2	19.80	3	
		26047	24	21.97	1	21.09	2	19.71	3	
	3MHz	1H	26675	24	23.06	0	21.92	1	20.57	2
			26365	24	22.99	0	21.94	1	20.98	2
			26055	24	22.95	0	22.40	1	20.96	2
		1M	26675	24	22.95	0	22.14	1	20.72	2
			26365	24	22.94	0	22.05	1	20.94	2
			26055	24	22.99	0	22.55	1	20.80	2
1L		26675	24	23.06	0	22.07	1	20.88	2	
		26365	24	23.02	0	21.96	1	20.62	2	
		26055	24	22.98	0	22.36	1	21.01	2	
8H		26675	24	22.04	1	21.06	2	19.92	3	
		26365	24	21.97	1	21.08	2	19.65	3	
		26055	24	21.98	1	21.10	2	19.86	3	
8M		26675	24	22.08	1	21.17	2	19.91	3	
		26365	24	22.04	1	21.14	2	19.87	3	
		26055	24	22.01	1	21.12	2	19.92	3	
8L		26675	24	22.06	1	21.06	2	19.78	3	
		26365	24	22.04	1	21.12	2	19.77	3	
		26055	24	22.03	1	21.09	2	19.98	3	
15		26675	24	22.01	1	20.96	2	19.70	3	
		26365	24	22.01	1	21.06	2	19.75	3	
		26055	24	22.01	1	21.05	2	19.85	3	
5MHz		1H	26665	24	22.90	0	22.00	1	20.54	2
			26365	24	22.94	0	22.09	1	20.90	2
			26065	24	22.94	0	22.49	1	20.96	2
		1M	26665	24	23.12	0	22.23	1	20.66	2
			26365	24	23.21	0	22.30	1	20.81	2
			26065	24	23.15	0	22.68	1	20.77	2
	1L	26665	24	22.94	0	22.04	1	20.99	2	
		26365	24	22.97	0	22.08	1	20.75	2	
		26065	24	22.88	0	22.42	1	20.81	2	
	12H	26665	24	22.00	1	21.02	2	19.71	3	
		26365	24	21.97	1	21.01	2	19.69	3	
		26065	24	22.01	1	21.13	2	19.68	3	
	12M	26665	24	22.06	1	21.09	2	19.81	3	
		26365	24	22.05	1	21.12	2	19.80	3	
		26065	24	22.08	1	21.22	2	19.85	3	
	12L	26665	24	22.07	1	21.08	2	19.83	3	
		26365	24	22.02	1	21.04	2	19.71	3	
		26065	24	21.99	1	21.14	2	19.82	3	
	25	26665	24	21.98	1	20.94	2	19.90	3	
		26365	24	21.99	1	21.01	2	19.79	3	
		26065	24	22.00	1	21.11	2	19.77	3	



10MHz	1H	26640	24	22.89	0	21.96	1	20.80	2	
		26365	24	22.88	0	21.86	1	20.91	2	
		26090	24	22.96	0	22.38	1	20.69	2	
	1M	26640	24	23.05	0	22.14	1	20.93	2	
		26365	24	23.07	0	22.05	1	20.95	2	
		26090	24	23.12	0	22.49	1	21.03	2	
	1L	26640	24	22.87	0	21.98	1	20.83	2	
		26365	24	22.89	0	21.87	1	20.86	2	
		26090	24	22.91	0	22.31	1	20.78	2	
	25H	26640	24	21.90	1	20.99	2	19.82	3	
		26365	24	21.97	1	20.99	2	19.61	3	
		26090	24	22.05	1	21.12	2	19.67	3	
	25M	26640	24	22.06	1	21.20	2	19.85	3	
		26365	24	22.06	1	21.10	2	19.68	3	
		26090	24	22.09	1	21.16	2	19.77	3	
	25L	26640	24	22.05	1	21.16	2	19.97	3	
		26365	24	22.05	1	21.05	2	19.87	3	
		26090	24	22.04	1	21.13	2	19.80	3	
	50	26640	24	21.98	1	21.03	2	19.77	3	
		26365	24	22.01	1	21.02	2	19.73	3	
		26090	24	22.07	1	21.12	2	19.79	3	
	15MHz	1H	26615	24	22.85	0	22.20	1	20.96	2
			26365	24	22.80	0	21.92	1	20.89	2
			26115	24	22.95	0	22.24	1	20.84	2
		1M	26615	24	23.02	0	22.34	1	20.90	2
			26365	24	22.92	0	21.92	1	20.86	2
			26115	24	22.96	0	22.35	1	20.92	2
1L		26615	24	22.91	0	22.26	1	20.68	2	
		26365	24	22.83	0	21.83	1	20.97	2	
		26115	24	22.84	0	22.27	1	20.77	2	
36H		26615	24	22.04	1	20.90	2	19.53	3	
		26365	24	21.99	1	20.94	2	19.74	3	
		26115	24	22.08	1	21.11	2	19.88	3	
36M		26615	24	22.16	1	21.03	2	19.64	3	
		26365	24	22.07	1	20.99	2	19.78	3	
		26115	24	22.07	1	21.07	2	19.80	3	
36L		26615	24	22.12	1	20.98	2	19.59	3	
		26365	24	22.08	1	21.02	2	19.83	3	
		26115	24	22.11	1	21.09	2	19.84	3	
75		26615	24	22.08	1	20.99	2	19.51	3	
		26365	24	22.04	1	21.01	2	19.73	3	
		26115	24	22.10	1	21.09	2	19.78	3	
20MHz		1H	26590	24	22.65	0	22.20	1	20.35	2
			26365	24	22.66	0	22.23	1	20.52	2
			26140	24	22.63	0	22.06	1	20.28	2
		1M	26590	24	23.18	0	22.55	1	20.26	2
			26365	24	23.17	0	22.56	1	20.57	2
			26140	24	23.16	0	22.50	1	20.89	2
	1L	26590	24	22.67	0	22.24	1	20.45	2	
		26365	24	22.66	0	22.17	1	20.44	2	
		26140	24	22.62	0	22.05	1	20.69	2	
	50H	26590	24	21.79	1	20.80	2	19.33	3	
		26365	24	21.95	1	20.95	2	19.35	3	
		26140	24	22.02	1	21.05	2	19.80	3	
	50M	26590	24	22.01	1	21.01	2	19.60	3	
		26365	24	22.03	1	21.06	2	19.59	3	
		26140	24	22.03	1	21.00	2	19.65	3	
	50L	26590	24	21.97	1	20.99	2	19.44	3	
		26365	24	22.04	1	21.04	2	19.58	3	
		26140	24	22.02	1	21.00	2	19.55	3	
	100	26590	24	21.87	1	20.95	2	19.35	3	
		26365	24	21.97	1	21.00	2	19.47	3	
		26140	24	22.03	1	21.03	2	19.67	3	



Table 11-4 LTE850-FDD26 #1

LTE850-FDD26 #1										
BandWidth	RB No./Start	Channel	Tune-up	Measured Power (dBm) & MPR						
				QPSK		16QAM		64QAM		
				Measured Power	MPR	Measured Power	MPR	Measured Power	MPR	
1.4MHz	1H	27033	24.5	22.99	0	21.71	1	20.71	2	
		26865	24.5	22.83	0	21.80	1	20.66	2	
		26697	24.5	22.84	0	22.09	1	20.77	2	
	1M	27033	24.5	22.89	0	21.84	1	20.76	2	
		26865	24.5	22.88	0	22.05	1	20.84	2	
		26697	24.5	22.95	0	22.24	1	20.73	2	
	1L	27033	24.5	22.86	0	21.71	1	20.87	2	
		26865	24.5	22.73	0	21.87	1	20.70	2	
		26697	24.5	22.73	0	22.09	1	20.94	2	
	3H	27033	24.5	22.83	0	21.88	1	20.84	2	
		26865	24.5	22.90	0	21.83	1	20.73	2	
		26697	24.5	22.84	0	21.99	1	20.63	2	
	3M	27033	24.5	22.86	0	21.98	1	20.55	2	
		26865	24.5	22.89	0	21.88	1	20.82	2	
		26697	24.5	22.90	0	21.99	1	20.75	2	
	3L	27033	24.5	22.92	0	21.93	1	20.61	2	
		26865	24.5	22.89	0	21.84	1	20.91	2	
		26697	24.5	22.83	0	21.99	1	20.78	2	
	6	27033	24.5	22.91	1	21.09	2	19.56	3	
		26865	24.5	21.89	1	21.00	2	19.55	3	
		26697	24.5	21.85	1	20.74	2	19.54	3	
	3MHz	1H	27025	24.5	23.03	0	22.08	1	20.57	2
			26865	24.5	22.90	0	21.79	1	20.79	2
			26705	24.5	22.86	0	21.76	1	20.87	2
		1M	27025	24.5	22.97	0	22.25	1	20.54	2
			26865	24.5	23.01	0	21.92	1	20.67	2
			26705	24.5	22.87	0	21.96	1	20.86	2
1L		27025	24.5	22.91	0	22.13	1	20.73	2	
		26865	24.5	22.87	0	21.84	1	20.85	2	
		26705	24.5	22.85	0	21.81	1	20.69	2	
8H		27025	24.5	21.97	1	20.91	2	19.62	3	
		26865	24.5	21.85	1	20.88	2	19.61	3	
		26705	24.5	21.84	1	20.86	2	19.63	3	
8M		27025	24.5	21.92	1	20.98	2	19.61	3	
		26865	24.5	21.87	1	20.96	2	19.54	3	
		26705	24.5	21.83	1	20.88	2	19.59	3	
8L		27025	24.5	21.84	1	20.95	2	19.65	3	
		26865	24.5	21.87	1	20.85	2	19.50	3	
		26705	24.5	21.86	1	20.87	2	19.64	3	
15		27025	24.5	21.83	1	20.86	2	19.57	3	
		26865	24.5	21.84	1	20.83	2	19.53	3	
		26705	24.5	21.86	1	20.80	2	19.56	3	
5MHz		1H	27015	24.5	22.81	0	21.76	1	20.70	2
			26865	24.5	22.69	0	21.90	1	20.89	2
			26715	24.5	22.70	0	22.19	1	20.77	2
		1M	27015	24.5	22.97	0	22.04	1	20.86	2
			26865	24.5	22.93	0	22.09	1	20.80	2
			26715	24.5	22.92	0	22.41	1	20.93	2
	1L	27015	24.5	22.69	0	21.75	1	20.51	2	
		26865	24.5	22.64	0	21.83	1	20.52	2	
		26715	24.5	22.70	0	22.17	1	20.67	2	
	12H	27015	24.5	21.75	1	20.81	2	19.58	3	
		26865	24.5	21.84	1	20.88	2	19.55	3	
		26715	24.5	21.76	1	20.90	2	19.66	3	
	12M	27015	24.5	21.86	1	20.96	2	19.75	3	
		26865	24.5	21.89	1	20.89	2	19.51	3	
		26715	24.5	21.86	1	20.97	2	19.58	3	
	12L	27015	24.5	21.78	1	20.89	2	19.67	3	
		26865	24.5	21.80	1	20.85	2	19.60	3	
		26715	24.5	21.81	1	20.90	2	19.58	3	
	25	27015	24.5	21.75	1	20.77	2	19.63	3	
		26865	24.5	21.82	1	20.83	2	19.59	3	
		26715	24.5	21.80	1	20.87	2	19.60	3	



10MHz	1H	26990	24.5	22.89	0	21.73	1	20.66	2
		26865	24.5	22.80	0	21.66	1	20.89	2
		26750	24.5	22.86	0	22.15	1	20.80	2
	1M	26990	24.5	22.85	0	21.85	1	20.97	2
		26865	24.5	22.89	0	21.82	1	20.71	2
		26750	24.5	22.92	0	22.19	1	20.74	2
	1L	26990	24.5	22.74	0	21.69	1	20.66	2
		26865	24.5	22.72	0	21.69	1	20.88	2
		26750	24.5	22.77	0	22.10	1	20.82	2
	25H	26990	24.5	21.73	1	20.87	2	19.57	3
		26865	24.5	21.88	1	20.90	2	19.50	3
		26750	24.5	21.84	1	20.87	2	19.65	3
	25M	26990	24.5	21.78	1	20.94	2	19.61	3
		26865	24.5	21.86	1	20.89	2	19.59	3
		26750	24.5	21.87	1	20.90	2	19.50	3
	25L	26990	24.5	21.89	1	20.99	2	19.82	3
		26865	24.5	21.87	1	20.86	2	19.68	3
		26750	24.5	21.84	1	20.84	2	19.62	3
	50	26990	24.5	21.83	1	20.91	2	19.56	3
		26865	24.5	21.86	1	20.84	2	19.62	3
		26750	24.5	21.82	1	20.84	2	19.53	3
15MHz	1H	26965	24.5	22.90	0	21.98	1	20.78	2
		26865	24.5	22.70	0	21.57	1	20.72	2
		26775	24.5	22.78	0	22.07	1	21.11	2
	1M	26965	24.5	22.90	0	22.08	1	21.10	2
		26865	24.5	22.81	0	21.73	1	20.84	2
		26775	24.5	22.85	0	22.14	1	20.95	2
	1L	26965	24.5	22.74	0	22.05	1	21.05	2
		26865	24.5	22.63	0	21.61	1	20.97	2
		26775	24.5	22.71	0	22.02	1	21.16	2
	36H	26965	24.5	21.83	1	20.76	2	19.86	3
		26865	24.5	21.89	1	20.88	2	19.88	3
		26775	24.5	21.95	1	20.88	2	19.78	3
	36M	26965	24.5	21.92	1	20.83	2	19.96	3
		26865	24.5	21.96	1	20.88	2	19.91	3
		26775	24.5	21.96	1	20.90	2	19.87	3
	36L	26965	24.5	21.92	1	20.84	2	19.80	3
		26865	24.5	21.94	1	20.84	2	19.89	3
		26775	24.5	21.97	1	20.91	2	19.91	3
	75	26965	24.5	21.90	1	20.89	2	19.84	3
		26865	24.5	21.96	1	20.90	2	19.80	3
		26775	24.5	21.96	1	20.90	2	19.88	3



Table 11-5 LTE2500-TDD41 #1

LTE2500-TDD41 #1										
BandWidth	RB No./Start	Channel	Tune-up	Measured Power (dBm) & MPR						
				QPSK		16QAM		64QAM		
				Measured Power	MPR	Measured Power	MPR	Measured Power	MPR	
5MHz	1H	41565	23	21.85	0	22.21	0	21.62	0	
		40620	23	21.92	0	22.26	0	21.51	0	
		39675	23	21.95	0	22.20	0	21.49	0	
		41565	23	21.92	0	22.28	0	21.45	0	
	1M	40620	23	21.79	0	22.10	0	21.42	0	
		39675	23	22.14	0	22.52	0	21.75	0	
		41565	23	22.17	0	22.66	0	21.59	0	
		40620	23	22.25	0	22.49	0	21.60	0	
	1L	39675	23	22.18	0	22.53	0	21.52	0	
		41565	23	22.07	0	22.39	0	21.55	0	
		40620	23	21.85	0	22.22	0	21.67	0	
		39675	23	21.95	0	22.25	0	21.53	0	
	12H	41565	23	21.97	0	22.21	0	21.54	0	
		40620	23	21.94	0	22.28	0	21.49	0	
		39675	23	21.76	0	22.26	0	21.44	0	
		41565	23	21.94	0	21.99	0	21.65	0	
	12M	40620	23	22.06	0	22.20	0	21.57	0	
		39675	23	22.03	0	22.10	0	21.53	0	
		41565	23	22.01	0	21.99	0	21.44	0	
		40620	23	21.93	0	22.06	0	21.56	0	
	12L	39675	23	22.01	0	22.04	0	21.71	0	
		41093	23	22.08	0	22.24	0	21.59	0	
		41540	23	22.07	0	22.11	0	21.56	0	
		40620	23	22.02	0	22.05	0	21.47	0	
	25	39700	23	21.90	0	22.05	0	21.61	0	
		41540	23	22.00	0	22.00	0	21.69	0	
		40620	23	22.04	0	22.18	0	21.53	0	
		39700	23	22.06	0	22.11	0	21.56	0	
	25	41540	23	22.00	0	22.03	0	21.47	0	
		40620	23	21.87	0	21.73	0	21.57	0	
		39700	23	21.98	0	22.02	0	21.69	0	
		41540	23	22.07	0	22.12	0	21.58	0	
	25	40620	23	22.09	0	22.08	0	21.55	0	
		39700	23	22.01	0	22.10	0	21.52	0	
		41540	23	21.88	0	21.96	0	21.60	0	
		40620								
	10MHz	1H	39700	23	21.95	0	22.26	0	21.38	0
			41540	23	21.98	0	22.29	0	21.26	0
			40620	23	22.17	0	22.38	0	21.29	0
			39700	23	22.00	0	22.30	0	21.22	0
		1M	41540	23	21.90	0	22.39	0	21.39	0
			40620	23	21.99	0	22.32	0	21.46	0
			39700	23	22.06	0	22.38	0	21.34	0
			40620	23	22.20	0	22.42	0	21.37	0
1L		41540	23	22.04	0	22.35	0	21.32	0	
		40620	23	21.91	0	22.22	0	21.46	0	
		39725	23	21.92	0	22.24	0	21.44	0	
		41540	23	21.97	0	22.31	0	21.30	0	
25H		40620	23	22.15	0	22.35	0	21.33	0	
		39725	23	21.97	0	22.29	0	21.31	0	
		41540	23	21.82	0	22.32	0	21.43	0	
		40620	23	22.00	0	22.03	0	21.46	0	
25M		39725	23	22.18	0	22.21	0	21.42	0	
		41540	23	22.13	0	22.14	0	21.45	0	
		40620	23	22.03	0	22.05	0	21.34	0	
		39725	23	21.91	0	21.99	0	21.48	0	
25L		41540	23	21.99	0	22.06	0	21.53	0	
		40620	23	22.11	0	22.24	0	21.38	0	
		39725	23	22.09	0	22.14	0	21.43	0	
		41540	23	22.04	0	22.08	0	21.38	0	
25L		40620	23	21.98	0	22.02	0	21.51	0	
		39725	23	21.99	0	22.06	0	21.59	0	
		41540	23	22.10	0	22.16	0	21.37	0	
		40620	23	22.10	0	22.15	0	21.41	0	
25L		39725	23	22.06	0	22.11	0	21.42	0	



		39700	23	21.90	0	22.03	0	21.54	0	
	50	41490	23	21.98	0	22.06	0	21.51	0	
		40620	23	22.14	0	22.21	0	21.37	0	
		39750	23	22.14	0	22.17	0	21.38	0	
		41490	23	22.03	0	22.12	0	21.32	0	
		40620	23	21.95	0	22.05	0	21.47	0	
		39750								
15MHz	1H	41490	23	21.82	0	22.13	0	21.23	0	
		40620	23	21.85	0	22.25	0	21.13	0	
		39750	23	22.02	0	22.24	0	21.13	0	
		41490	23	21.93	0	22.37	0	21.08	0	
		40620	23	21.74	0	22.23	0	21.23	0	
	1M	39750	23	21.93	0	22.23	0	21.36	0	
		41490	23	21.95	0	22.37	0	21.23	0	
		40620	23	22.12	0	22.33	0	21.27	0	
		39750	23	21.98	0	22.48	0	21.20	0	
		41490	23	21.83	0	22.28	0	21.37	0	
	1L	40620	23	21.86	0	22.18	0	21.33	0	
		39750	23	21.87	0	22.29	0	21.23	0	
		41490	23	22.02	0	22.27	0	21.20	0	
		40620	23	21.87	0	22.18	0	21.17	0	
		39750	23	21.69	0	22.12	0	21.29	0	
	36H	41515	23	21.94	0	21.95	0	21.33	0	
		41068	23	22.10	0	22.14	0	21.27	0	
		40620	23	22.10	0	22.07	0	21.28	0	
		40173	23	21.97	0	22.04	0	21.18	0	
		39725	23	21.88	0	21.94	0	21.37	0	
	36M	41515	23	21.94	0	21.95	0	21.38	0	
		41068	23	22.10	0	22.12	0	21.27	0	
		40620	23	22.06	0	22.12	0	21.29	0	
		40173	23	21.98	0	22.00	0	21.22	0	
		39725	23	21.89	0	21.96	0	21.37	0	
	36L	41515	23	21.91	0	21.90	0	21.37	0	
		41068	23	22.09	0	22.04	0	21.25	0	
		40620	23	22.06	0	22.06	0	21.29	0	
		40173	23	21.98	0	21.98	0	21.17	0	
		39725	23	21.88	0	21.92	0	21.38	0	
	75	41515	23	21.93	0	21.99	0	21.38	0	
		41068	23	22.09	0	22.10	0	21.30	0	
		40620	23	22.08	0	22.12	0	21.32	0	
		40173	23	21.98	0	22.02	0	21.25	0	
		39725	23	21.91	0	21.91	0	21.38	0	
	20MHz	1H	41490	23	21.65	0	22.01	0	21.11	0
			41055	23	21.79	0	22.06	0	21.18	0
			40620	23	21.74	0	22.20	0	21.19	0
			40185	23	21.77	0	22.01	0	21.15	0
			39750	23	21.69	0	21.92	0	21.05	0
		1M	41490	23	22.19	0	22.51	0	21.44	0
			41055	23	22.26	0	22.47	0	21.33	0
			40620	23	22.21	0	22.66	0	21.35	0
			40185	23	22.19	0	22.49	0	21.28	0
			39750	23	22.17	0	22.35	0	21.45	0
		1L	41490	23	21.70	0	22.00	0	21.23	0
			41055	23	21.80	0	22.01	0	21.11	0
			40620	23	21.67	0	22.13	0	21.11	0
40185			23	21.67	0	22.00	0	21.05	0	
39750			23	21.62	0	21.83	0	21.17	0	
50H		41490	23	21.92	0	21.92	0	21.41	0	
		41055	23	22.05	0	22.11	0	21.32	0	
		40620	23	22.02	0	22.13	0	21.28	0	
		40185	23	21.91	0	21.90	0	21.18	0	
		39750	23	21.84	0	21.95	0	21.36	0	
50M		41490	23	21.93	0	21.97	0	21.48	0	
		41055	23	22.11	0	22.13	0	21.32	0	
		40620	23	22.04	0	22.18	0	21.36	0	
		40185	23	21.93	0	21.98	0	21.28	0	
		39750	23	21.89	0	21.97	0	21.39	0	
50L		41490	23	21.85	0	21.85	0	21.46	0	
		41055	23	21.94	0	22.01	0	21.30	0	
		40620	23	21.95	0	22.01	0	21.33	0	
		40185	23	21.94	0	21.95	0	21.30	0	
		39750	23	21.88	0	22.33	0	21.41	0	
100		41490	23	21.89	0	21.92	0	21.47	0	
		41055	23	22.03	0	22.08	0	21.35	0	
		40620	23	21.99	0	22.05	0	21.31	0	
		40185	23	21.91	0	21.94	0	21.26	0	
		39750	23	21.88	0	21.92	0	21.37	0	



Table 11-6 LTE2500-TDD41 #2

LTE2500-TDD41 #2										
BandWidth	RB No./Start	Channel	Tune-up	Measured Power (dBm) & MPR						
				QPSK		16QAM		64QAM		
				Measured Power	MPR	Measured Power	MPR	Measured Power	MPR	
5MHz	1H	41565	27	26.00	0	25.25	1	23.42	2	
		40620	27	26.12	0	25.41	1	23.29	2	
		39675	27	26.12	0	25.26	1	23.30	2	
		41565	27	26.09	0	25.30	1	23.23	2	
	1M	40620	27	26.01	0	25.33	1	23.40	2	
		39675	27	26.29	0	25.53	1	23.54	2	
		41565	27	26.39	0	25.68	1	23.37	2	
		40620	27	26.40	0	25.54	1	23.43	2	
	1L	39675	27	26.36	0	25.58	1	23.36	2	
		41565	27	26.25	0	25.59	1	23.52	2	
		40620	27	26.08	0	25.25	1	23.45	2	
		39675	27	26.12	0	25.44	1	23.30	2	
	12H	41565	27	26.16	0	25.27	1	23.32	2	
		40620	27	26.10	0	25.28	1	23.28	2	
		39675	27	25.94	0	25.32	1	23.42	2	
		41565	27	25.04	1	24.04	2	22.56	3	
	12M	40620	27	25.15	1	24.22	2	22.48	3	
		39675	27	25.17	1	24.14	2	22.43	3	
		41565	27	25.10	1	24.04	2	22.41	3	
		40620	27	25.03	1	24.11	2	22.58	3	
	12L	39675	27	25.07	1	24.08	2	22.62	3	
		41093	27	25.19	1	24.26	2	22.50	3	
		41540	27	25.15	1	24.16	2	22.49	3	
		40620	27	25.14	1	24.09	2	22.44	3	
	25	39700	27	25.03	1	24.08	2	22.57	3	
		41540	27	25.08	1	24.06	2	22.60	3	
		40620	27	25.16	1	24.23	2	22.44	3	
		39700	27	25.16	1	24.15	2	22.45	3	
	25	41540	27	25.12	1	24.08	2	22.45	3	
		40620	27	24.97	1	24.05	2	22.55	3	
		39700	27	25.03	1	24.12	2	22.61	3	
		41540	27	25.18	1	24.15	2	22.50	3	
	25	40620	27	25.16	1	24.14	2	22.49	3	
		39700	27	25.12	1	24.09	2	22.46	3	
		41540	27	24.98	1	24.00	2	22.60	3	
		40620								
	10MHz	1H	39700	27	25.99	0	25.29	1	23.50	2
			41540	27	26.08	0	25.51	1	23.36	2
			40620	27	26.17	0	25.50	1	23.40	2
			39700	27	26.05	0	25.33	1	23.31	2
1M		41540	27	25.97	0	25.42	1	23.50	2	
		40620	27	26.45	0	25.34	1	23.69	2	
		39700	27	26.23	0	25.59	1	23.47	2	
		40620	27	26.23	0	25.53	1	23.46	2	
1L		41540	27	26.06	0	25.36	1	23.42	2	
		40620	27	25.96	0	25.47	1	23.57	2	
		39725	27	26.20	0	25.28	1	23.55	2	
		41540	27	26.27	0	25.48	1	23.41	2	
25H		40620	27	26.25	0	25.45	1	23.42	2	
		39725	27	26.09	0	25.31	1	23.39	2	
		41540	27	25.98	0	25.37	1	23.51	2	
		40620	27	24.99	1	24.06	2	22.61	3	
25M		39725	27	25.18	1	24.18	2	22.56	3	
		41540	27	25.16	1	24.22	2	22.55	3	
		40620	27	25.19	1	24.16	2	22.46	3	
		39725	27	25.10	1	24.07	2	22.60	3	
25L		41540	27	25.05	1	24.09	2	22.67	3	
		40620	27	25.14	1	24.16	2	22.50	3	
		39725	27	25.11	1	24.17	2	22.54	3	
		41540	27	25.17	1	24.11	2	22.48	3	
25L		40620	27	25.09	1	24.05	2	22.61	3	
		39725	27	25.01	1	24.08	2	22.68	3	
		41540	27	25.12	1	24.16	2	22.51	3	
		40620	27	25.12	1	24.18	2	22.53	3	
25L		39725	27	25.19	1	24.13	2	22.52	3	



		39700	27	25.06	1	24.00	2	22.64	3	
	50	41490	27	25.03	1	24.07	2	22.60	3	
		40620	27	25.15	1	24.20	2	22.50	3	
		39750	27	25.16	1	24.21	2	22.50	3	
		41490	27	25.16	1	24.12	2	22.44	3	
		40620	27	25.11	1	24.05	2	22.58	3	
		39750								
15MHz	1H	41490	27	25.84	0	25.31	1	23.37	2	
		40620	27	25.97	0	25.26	1	23.24	2	
		39750	27	26.06	0	25.23	1	23.26	2	
		41490	27	25.95	0	25.34	1	23.16	2	
		40620	27	25.85	0	25.25	1	23.35	2	
	1M	39750	27	26.03	0	25.39	1	23.50	2	
		41490	27	26.11	0	25.39	1	23.33	2	
		40620	27	26.18	0	25.32	1	23.37	2	
		39750	27	26.09	0	25.47	1	23.31	2	
	1L	41490	27	25.98	0	25.28	1	23.47	2	
		40620	27	25.89	0	25.30	1	23.45	2	
		39750	27	26.04	0	25.30	1	23.32	2	
		41490	27	26.07	0	25.25	1	23.30	2	
	36H	40620	27	25.98	0	25.42	1	23.29	2	
		39750	27	25.84	0	25.16	1	23.40	2	
		41515	27	25.03	1	24.02	2	22.48	3	
		41068	27	25.21	1	24.24	2	22.36	3	
	36M	40620	27	25.20	1	24.12	2	22.40	3	
		40173	27	25.12	1	24.00	2	22.32	3	
		39725	27	25.01	1	24.05	2	22.48	3	
		41515	27	25.11	1	23.95	2	22.52	3	
	36L	41068	27	25.20	1	24.17	2	22.42	3	
		40620	27	25.18	1	24.09	2	22.41	3	
		40173	27	25.11	1	24.01	2	22.37	3	
		39725	27	25.01	1	23.96	2	22.49	3	
	75	41515	27	25.00	1	23.93	2	22.52	3	
		41068	27	25.14	1	24.09	2	22.39	3	
		40620	27	25.16	1	24.06	2	22.40	3	
		40173	27	25.15	1	24.01	2	22.38	3	
	20MHz	1H	39725	27	25.01	1	23.98	2	22.49	3
			41515	27	25.03	1	24.01	2	22.52	3
			41068	27	25.20	1	24.14	2	22.44	3
			40620	27	25.22	1	24.15	2	22.41	3
			40173	27	25.10	1	24.03	2	22.38	3
		1M	39725	27	24.99	1	23.99	2	22.51	3
			41490	27	25.79	0	24.99	1	23.21	2
			41055	27	26.02	0	25.04	1	23.08	2
			40620	27	25.91	0	25.23	1	23.08	2
			40185	27	25.87	0	25.05	1	23.03	2
		1L	39750	27	25.90	0	24.91	1	23.16	2
			41490	27	26.30	0	25.53	1	23.57	2
	41055		27	26.46	0	25.44	1	23.43	2	
	40620		27	26.38	0	25.66	1	23.46	2	
	40185		27	26.32	0	25.48	1	23.36	2	
	50H	39750	27	26.35	0	25.34	1	23.53	2	
		41490	27	25.82	0	24.99	1	23.31	2	
		41055	27	26.03	0	25.00	1	23.20	2	
		40620	27	25.88	0	25.16	1	23.18	2	
40185		27	25.85	0	25.05	1	23.15	2		
50M	39750	27	25.85	0	24.83	1	23.25	2		
	41490	27	25.00	1	23.95	2	22.48	3		
	41055	27	25.14	1	24.10	2	22.44	3		
	40620	27	25.13	1	24.11	2	22.40	3		
	40185	27	24.98	1	23.92	2	22.27	3		
50L	39750	27	24.99	1	23.95	2	22.47	3		
	41490	27	25.04	1	24.03	2	22.56	3		
	41055	27	25.14	1	24.13	2	22.44	3		
	40620	27	25.35	1	24.15	2	22.45	3		
	40185	27	25.05	1	23.98	2	22.39	3		
100	39750	27	25.01	1	24.00	2	22.50	3		
	41490	27	24.94	1	23.91	2	22.54	3		
	41055	27	25.03	1	24.00	2	22.40	3		
	40620	27	25.04	1	24.07	2	22.43	3		
	40185	27	24.99	1	23.94	2	22.41	3		
100	39750	27	24.93	1	23.96	2	22.52	3		
	41490	27	24.96	1	23.92	2	22.55	3		
	41055	27	25.08	1	24.09	2	22.45	3		
	40620	27	25.08	1	24.05	2	22.42	3		
		40185	27	24.99	1	23.93	2	22.37	3	
		39750	27	24.95	1	23.94	2	22.49	3	

11.3 Wi-Fi and BT Measurement result

The output power of BT antenna is as following:

Table 11-7 Bluetooth Power

Bluetooth Power				
Mode	Channel	Frequency	Tune-up	Measured
GFSK	78	2480 MHz	6	5.57
	39	2441 MHz	7	6.72
	0	2402 MHz	6	5.21
EDR2M-4_DQPSK	78	2480 MHz	6	4.84
	39	2441 MHz	7	5.71
	0	2402 MHz	6	4.33
EDR3M-8DPSK	78	2480 MHz	6	5.13
	39	2441 MHz	7	6.01
	0	2402 MHz	6	4.53



The average conducted power for Wi-Fi is as following:

Table 11-8 WLAN2450 #1

WLAN2450 #1						
Band	Mode	Channel	Frequency	Data Rate	Tune-up	Measured
WLAN 2.4G 20M	802.11b	11	2462 MHz	5.5Mbps	21.00	19.94
		6	2437 MHz		21.00	20.25
		1	2412 MHz		21.00	19.55
		11	2462 MHz	2Mbps	/	/
		6	2437 MHz		21.00	19.68
		1	2412 MHz		/	/
		11	2462 MHz	1Mbps	21.00	19.72
		6	2437 MHz		21.00	19.84
		1	2412 MHz		21.00	19.32
		11	2462 MHz	11Mbps	/	/
		6	2437 MHz		21.00	20.12
		1	2412 MHz		/	/
	11	2462 MHz	6Mbps	19.50	18.69	
	6	2437 MHz		19.50	18.84	
	1	2412 MHz		19.50	18.41	
	11	2462 MHz	9Mbps	/	/	
	6	2437 MHz		19.00	18.45	
	1	2412 MHz		/	/	
	11	2462 MHz	12Mbps	/	/	
	6	2437 MHz		19.00	18.39	
	1	2412 MHz		/	/	
	11	2462 MHz	18Mbps	/	/	
	6	2437 MHz		19.00	18.65	
	1	2412 MHz		/	/	
	11	2462 MHz	24Mbps	/	/	
	6	2437 MHz		18.00	17.42	
	1	2412 MHz		/	/	
	11	2462 MHz	36Mbps	/	/	
	6	2437 MHz		18.00	17.35	
	1	2412 MHz		/	/	
	11	2462 MHz	48Mbps	/	/	
	6	2437 MHz		18.00	17.89	
	1	2412 MHz		/	/	
	11	2462 MHz	54Mbps	/	/	
	6	2437 MHz		17.00	16.86	
	1	2412 MHz		/	/	
	11	2462 MHz	MCS0	19.50	18.91	
	6	2437 MHz		19.50	18.69	
	1	2412 MHz		19.50	18.26	
	11	2462 MHz	MCS1	19.50	18.65	
	6	2437 MHz		/	/	
	1	2412 MHz		/	/	
	11	2462 MHz	MCS2	19.50	19.02	
	6	2437 MHz		19.50	18.96	
	1	2412 MHz		19.50	18.37	
	11	2462 MHz	MCS3	17.50	17.07	
	6	2437 MHz		/	/	
	1	2412 MHz		/	/	
11	2462 MHz	MCS4	17.50	17.05		
6	2437 MHz		/	/		
1	2412 MHz		/	/		
11	2462 MHz	MCS5	17.50	16.79		
6	2437 MHz		/	/		
1	2412 MHz		/	/		
11	2462 MHz	MCS6	17.50	16.82		
6	2437 MHz		/	/		
1	2412 MHz		/	/		
11	2462 MHz	MCS7	17.00	16.30		
6	2437 MHz		/	/		
1	2412 MHz		/	/		