

TEST REPORT

Product Name : **Wireless Monitor Headphones system**
Model Number : **HP-TX01**
FCC ID : **2AM73-HPTX01**

Prepared for : AlphaTheta Corporation
Address : 6F, Yokohama i-Mark Place, 4-4-5 Minatomirai, Nishi-ku,
Yokohama, Kanagawa 220-0012 JAPAN

Prepared by : EMTEK (SHENZHEN) CO., LTD.
Address : Building 69, Majialong Industry Zone, Nanshan District,
Shenzhen, Guangdong, China

Tel: (0755) 26954280
Fax: (0755) 26954282

Report Number : ENS2212220100W01001R
Date(s) of Tests : December 29, 2022 to March 19, 2023
Date of issue : March 22, 2023

TABLE OF CONTENTS

1 TEST RESULT CERTIFICATION	3
2 EUT TECHNICAL DESCRIPTION	5
3 SUMMARY OF TEST RESULT	6
4 TEST METHODOLOGY	7
4.1 GENERAL DESCRIPTION OF APPLIED STANDARDS.....	7
4.2 MEASUREMENT EQUIPMENT USED.....	7
4.3 DESCRIPTION OF TEST MODES.....	8
5 FACILITIES AND ACCREDITATIONS	9
5.1 FACILITIES.....	9
5.2 LABORATORY ACCREDITATIONS AND LISTINGS.....	9
6 TEST SYSTEM UNCERTAINTY	10
7 SETUP OF EQUIPMENT UNDER TEST	11
7.1 RADIO FREQUENCY TEST SETUP 1.....	11
7.2 RADIO FREQUENCY TEST SETUP 2.....	11
7.3 CONDUCTED EMISSION TEST SETUP.....	13
7.4 BLOCK DIAGRAM CONFIGURATION OF TEST SYSTEM.....	14
7.5 SUPPORT EQUIPMENT.....	14
8 TEST REQUIREMENTS	15
8.1 DTS 6DB BANDWIDTH.....	15
8.2 MAXIMUM PEAK CONDUCTED OUTPUT POWER.....	18
8.3 MAXIMUM POWER SPECTRAL DENSITY.....	21
8.4 UNWANTED EMISSIONS IN NON-RESTRICTED FREQUENCY BANDS.....	24
8.5 RADIATED SPURIOUS EMISSION.....	36
8.6 CONDUCTED EMISSIONS TEST.....	48
8.7 ANTENNA APPLICATION.....	51

1 TEST RESULT CERTIFICATION

Applicant : AlphaTheta Corporation
 Address : 6F, Yokohama i-Mark Place, 4-4-5 Minatomirai, Nishi-ku, Yokohama, Kanagawa 220-0012 JAPAN
 Manufacturer : AlphaTheta Corporation
 Address : 6F, Yokohama i-Mark Place, 4-4-5 Minatomirai, Nishi-ku, Yokohama, Kanagawa 220-0012 JAPAN
 EUT : Wireless Monitor Headphones system
 Model Name : HP-TX01
 Trademark : AlphaTheta

Measurement Procedure Used:

APPLICASRD 2.4GSTANDARDS	
STANDARD	TEST RESULT
FCC 47 CFR Part 2 , Subpart J FCC 47 CFR Part 15, Subpart C	PASS

The above equipment was tested by EMTEK(SHENZHEN) CO., LTD. The test data, data evaluation, test procedures, and equipment configurations shown in this report were made in accordance with the procedures given in ANSI C63.10 (2013) and the energy emitted by the sample EUT tested as described in this report is in compliance with the requirements of FCC Rules Part 2 and Part 15.247

The test results of this report relate only to the tested sample identified in this report

Date of Test : December 29, 2022 to March 19, 2023

Prepared by : 
Una Yu/Editor

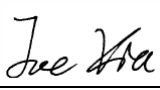
Reviewer : 
Joe Xia/Supervisor

Approved & Authorized Signer : 
Lisa Wang/Manager

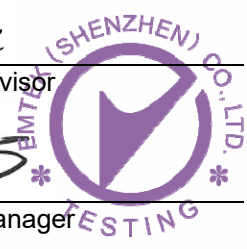

Modified Information

Version	Report No.	Revision Date	Summary
Ver.1.0	ENS2212220100W01001R	/	Original Report



2 EUT TECHNICAL DESCRIPTION

Product	Wireless Monitor Headphones system
Model Number	HP-TX01
Device Type	SRD 2.4G
Modulation	GFSK
Operating Frequency Range	2402-2480MHz
Number of Channels	79Channels
Antenna Type	PCB Antenna
Antenna Gain	ANT1: 2.02dBi ANT2: 1.45dBi
Power Supply	DC 3.7V from battery DC 5V from type C port
Temperature Range	0°C ~ 40°C

Note: for more details, please refer to the User's manual of the EUT.

3 SUMMARY OF TEST RESULT

FCC Part Clause	Test Parameter	Verdict	Remark
15.247(a)(2)	DTS (6dB) Bandwidth	PASS	
15.247(b)(3)	Maximum Peak Conducted Output Power	PASS	
15.247(e)	Maximum Power Spectral Density Level	PASS	
15.247(d)	Unwanted Emission Into Non-Restricted Frequency Bands	PASS	
15.247(d) 15.209	Unwanted Emission Into Restricted Frequency Bands (conducted)	PASS	
15.247(d) 15.209	Radiated Spurious Emission	PASS	
15.207	Conducted Emission Test	PASS	
15.247(b)	Antenna Application	PASS	
	NOTE1: N/A (Not Applicable) NOTE2: According to FCC OET KDB 558074, the report use radiated measurements in the restricted frequency bands. In addition, the radiated test is also performed to ensure the emissions emanating from the device cabinet also comply with the applicable limits.		

RELATED SUBMITTAL(S) / GRANT(S):

This submittal(s) (test report) is intended for FCC ID: 2AM73-HPTX01 filing to comply with Section 15.247 of the FCC Part 15, Subpart C Rules.

4 TEST METHODOLOGY

4.1 GENERAL DESCRIPTION OF APPLIED STANDARDS

According to its specifications, the EUT must comply with the requirements of the following standards:

FCC 47 CFR Part 2, Subpart J

FCC 47 CFR Part 15, Subpart C

FCC KDB 558074 D01 15.247 Meas Guidance v05r02

4.2 MEASUREMENT EQUIPMENT USED

For Conducted Emission Test Equipment

Equipment	Manufacturer	Model No.	Serial No.	Last Cal.	Cal. Interval
EMI Test Receiver	Rohde & Schwarz	ESCI	101045	2022/5/14	1Year
PULSE LIMTER	Rohde & Schwarz	ESH3-Z2	100107	2022/5/14	1Year
AMN	Rohde & Schwarz	ESH3-Z5	100191	2022/5/15	1Year
AMN	Schwarzbeck	NNLK 8129	8129203	2022/5/15	1Year
V-Network	Rohde & Schwarz	ESH3-Z6	100011	2022/5/15	1Year
V-Network	Rohde & Schwarz	ESH3-Z6	100253	2022/5/15	1Year

For Spurious Emissions Test

Equipment	Manufacturer	Model No.	Serial No.	Last Cal.	Cal. Interval
Pre-Amplifier	HP	8447F	2944A07999	2022/5/14	1Year
EMI Test Receiver	Rohde & Schwarz	ESCI	101414	2022/5/14	1Year
Bilog Antenna	Schwarzbeck	VULB9163	712	2021/7/5	2 Year
Horn antenna	Schwarzbeck	BBHA9120D	9120D-1178	2021/8/22	2 Year
Pre-Amplifie	Lunar EM	LNA1G18-48	J1011131010 001	2022/5/14	1Year
Spectrum Analyzer	Rohde & Schwarz	FSV40	100967	2022/5/14	1Year
Horn antenna	Schwarzbeck	BBHA9170	9170-399	2021/6/12	2 Year
Loop Antenna	Schwarzbeck	FMZB1519	1519-012	2021/6/12	2 Year

For other test items:

Equipment	Manufacturer	Model No.	Serial No.	Last Cal.	Cal. Interval
Wideband Radio Communication Tester	R&S	CMW500	171168	2022/5/3	1Year
Frequency Extender	R&S	CMW-Z800A	100430	2022/5/16	1Year
Spectrum Analyzer	R&S	FSV3044	MY60242456	2022/4/11	1Year
Analog Signal Generator	R&S	SMB100A	MY61252625	2022/4/22	1Year
Vector Signal Generator	R&S	SMM100A	MY61252674	2022/5/9	1Year
RF Control Unit	Tonscend	JS0806-2	22C8060567	2022/7/20	N/A
Temperature&Humidity Chamber	ESPEC	EL-02KA	12107166	2022/7/2	1 Year

4.3 DESCRIPTION OF TEST MODES

The EUT has been tested under its typical operating condition.

The EUT configuration for testing is installed on RF field strength measurement to meet the Commissions requirement and operating in a manner which intends to maximize its emission characteristics in a continuous normal application.

The Transmitter was operated in the normal operating mode. The TX frequency was fixed which was for the purpose of the measurements.

Test of channel included the lowest and middle and highest frequency to perform the test, then record on this report.

Those data rates (GFSK;) were used for all test.

Pre-defined engineering program for regulatory testing used to control the EUT for staying in continuous transmitting and receiving mode is programmed.

Frequency and Channel list for SRD 2.4G:

Channel	Frequency (MHz)	Channel	Frequency (MHz)	Channel	Frequency (MHz)
0	2402	39	2441
1	2403	40	2442	76	2478
2	2404	41	2443	77	2479
...	78	2480

Note: $f_c = 2402\text{MHz} + k \times 1\text{MHz}$ $k = 0$ to 78

Test Frequency and channel for SRD 2.4G:

Lowest Frequency		Middle Frequency		Highest Frequency	
Channel	Frequency (MHz)	Channel	Frequency (MHz)	Channel	Frequency (MHz)
0	2402	39	2441	78	2480

5 FACILITIES AND ACCREDITATIONS

5.1 FACILITIES

All measurement facilities used to collect the measurement data are located at

Bldg 69, Majialong Industry Zone District, Nanshan District, Shenzhen, China

The sites are constructed in conformance with the requirements of ANSI C63.7, ANSI C63.10 and CISPR Publication 22.

5.2 LABORATORY ACCREDITATIONS AND LISTINGS

Site Description

EMC Lab.

: **Accredited by CNAS**

The Certificate Registration Number is L2291

The Laboratory has been assessed and proved to be in compliance with

CNAS-CL01 (identical to ISO/IEC 17025:2017)

Accredited by FCC

Designation Number: CN1204

Test Firm Registration Number: 882943

Accredited by A2LA

The Certificate Number is 4321.01

Accredited by Industry Canada

The Conformity Assessment Body Identifier is CN0008

Name of Firm

: EMTEK (SHENZHEN) CO., LTD.

Site Location

: Building 69, Majialong Industry Zone, Nanshan District, Shenzhen, Guangdong, China

6 TEST SYSTEM UNCERTAINTY

The following measurement uncertainty levels have been estimated for tests performed on the apparatus:

Test Parameter	Measurement Uncertainty
RF Output Power	±1.0%
Power Spectral Density	±0.9%
Duty Cycle and Tx-Sequence and Tx-Gap	±1.3%
Medium Utilisation Factor	±1.5%
Occupied Channel Bandwidth	±2.3%
Transmitter Unwanted Emission in the Out-of Band	±1.2%
Transmitter Unwanted Emissions in the Spurious Domain	±2.7%
Receiver Spurious Emissions	±2.7%
Temperature	±3.2%
Humidity	±2.5%

Measurement Uncertainty for a level of Confidence of 95%



7 SETUP OF EQUIPMENT UNDER TEST

7.1 RADIO FREQUENCY TEST SETUP 1

The SRD 2.4G component's antenna ports(s) of the EUT are connected to the measurement instrument per an appropriate attenuator. The EUT is controlled by PC/software to emit the specified signals for the purpose of measurements.

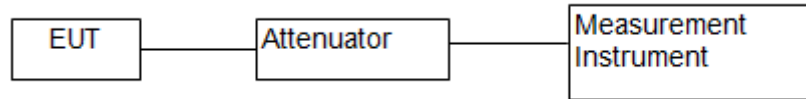

7.2 RADIO FREQUENCY TEST SETUP 2

The test site semi-anechoic chamber has met the requirement of NSA tolerance 4 dB according to the standards: ANSI C63.10. The test distance is 3m. The setup is according to the requirements in Section 13.1.4.1 of ANSI C63.10-2013 and CAN/CSA-CEI/IEC CISPR 22.

Below 30MHz:

The EUT is placed on a turntable 0.8 meters above the ground in the chamber, 3 meter away from the antenna (loop antenna). The Antenna should be positioned with its plane vertical at the specified distance from the EUT and rotated about its vertical axis for maximum response at each azimuth about the EUT. The center of the loop shall be 1 m above the ground. For certain applications, the loop antenna plane may also need to be positioned horizontally at the specified distance from the EUT.

30MHz-1GHz:

The EUT is placed on a turntable 0.8 meters above the ground in the chamber, 3 meter away from the antenna. The maximal emission value is acquired by adjusting the antenna height, polarisation and turntable azimuth. Normally, the height range of antenna is 1 m to 4 m, the azimuth range of turntable is 0° to 360°, and the receive antenna has two polarizations Vertical (V) and Horizontal (H).

Above 1GHz:

The EUT is placed on a turntable 1.5 meters above the ground in the chamber, 3 meter away from the antenna. The maximal emission value is acquired by adjusting the antenna height, polarisation and turntable azimuth. Normally, the height range of antenna is 1 m to 4 m, the azimuth range of turntable is 0° to 360°, and the receive antenna has two polarizations Vertical (V) and Horizontal (H).

(a) Radiated Emission Test Set-Up, Frequency Below 30MHz

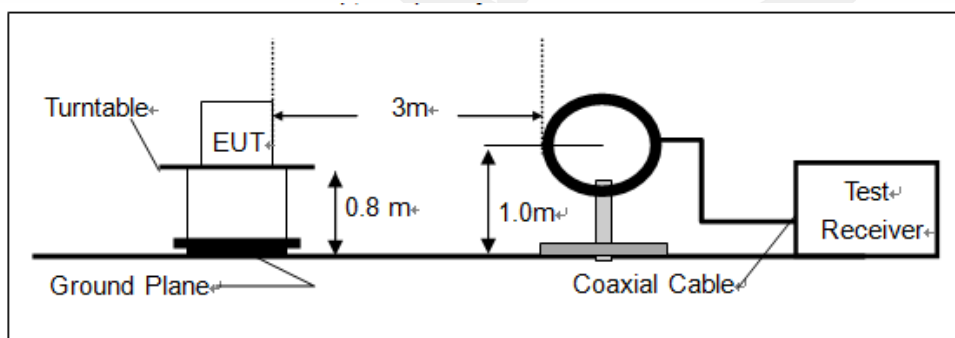

(b) Radiated Emission Test Set-Up, Frequency Below 1000MHz

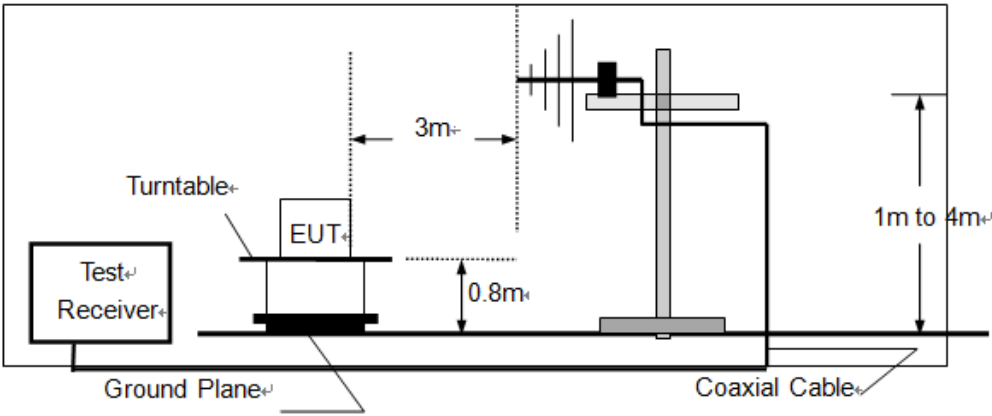

(c) Radiated Emission Test Set-Up, Frequency above 1000MHz

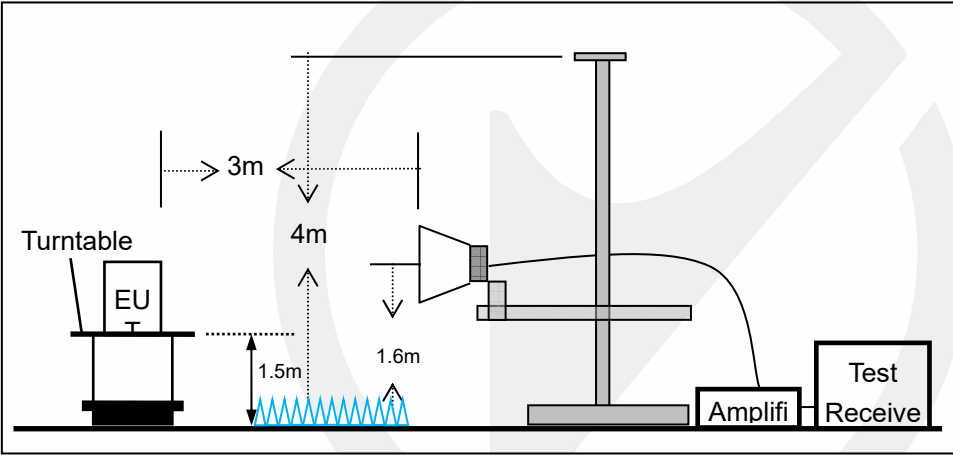

7.3 CONDUCTED EMISSION TEST SETUP

The mains cable of the EUT (maybe per AC/DC Adapter) must be connected to LISN. The LISN shall be placed 0.8 m from the boundary of EUT and bonded to a ground reference plane for LISN mounted on top of the ground reference plane. This distance is between the closest points of the LISN and the EUT. All other units of the EUT and associated equipment shall be at least 0.8m from the LISN.

Ground connections, where required for safety purposes, shall be connected to the reference ground point of the LISN and, where not otherwise provided or specified by the manufacturer, shall be of same length as the mains cable and run parallel to the mains connection at a separation distance of not more than 0.1 m.

According to the requirements in Section 13.1.4.1 of ANSI C63.10-2013 Conducted emissions from the EUT measured in the frequency range between 0.15 MHz and 30 MHz using CISPR Quasi-Peak and average detector mode.

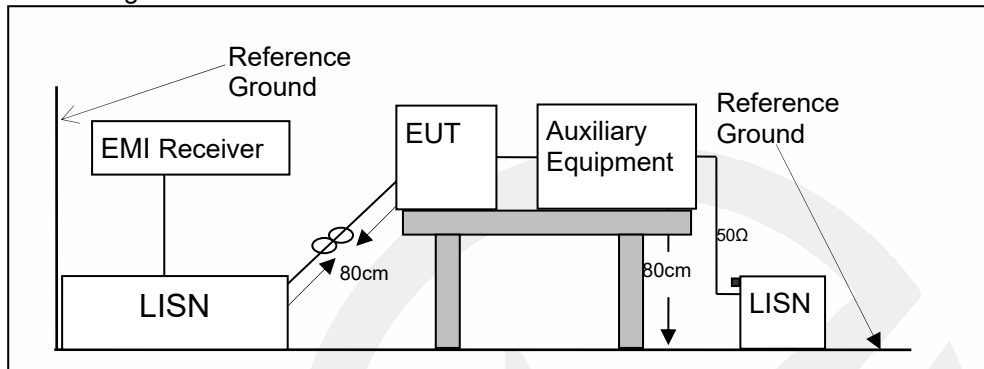

7.4 BLOCK DIAGRAM CONFIGURATION OF TEST SYSTEM

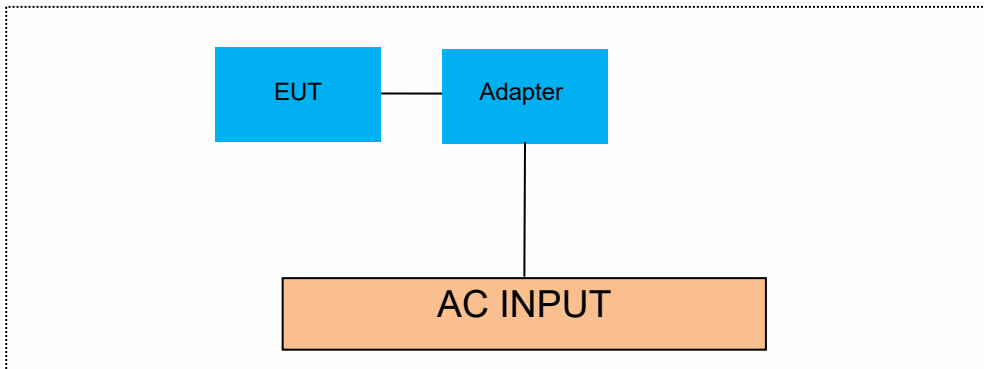

7.5 SUPPORT EQUIPMENT

Adapter : Manufacturer: Aohai
M/N: A8A-050200U-CN1
CE, FCC

Notes:

1. All the equipment/cables were placed in the worst-case configuration to maximize the emission during the test.
2. Grounding was established in accordance with the manufacturer's requirements and conditions for the intended use.

8 TEST REQUIREMENTS

8.1 DTS 6DB BANDWIDTH

8.1.1 Applicable Standard

According to FCC Part 15.247(a)(2) and KDB 558074 D01 15.247 Meas Guidance v05r02

8.1.2 Conformance Limit

The minimum -6 dB bandwidth shall be at least 500 kHz.

8.1.3 Test Configuration

Test according to clause 7.1 radio frequency test setup 1

8.1.4 Test Procedure

The EUT was operating in SRD 2.4Gmode and controlled its channel. Printed out the test result from the spectrum by hard copy function.

The RF output of EUT was connected to the spectrum analyzer by RF cable and attenuator. The path loss was compensated to the results for each measurement.

Set to the maximum power setting and enable the EUT transmit continuously

Set RBW = 100 kHz.

Set the video bandwidth (VBW) =300 kHz.

Set Span=2 times OBW

Set Detector = Peak.

Set Trace mode = max hold.

Set Sweep = auto couple.

Allow the trace to stabilize.

Measure the maximum width of the emission that is constrained by the frequencies associated with the two outermost amplitude points (upper and lower frequencies) that are attenuated by 6 dB relative to the maximum level measured in the fundamental emission.

Measure and record the results in the test report.

Test Results

Temperature:	25° C
Relative Humidity:	45%
ATM Pressure:	1011 mbar

TestMode	Antenna	Frequency[MHz]	DTS BW [MHz]	FL[MHz]	FH[MHz]	Limit[MHz]	Verdict
SRD2.4G	Ant1	2402	0.68	2401.66	2402.34	0.5	PASS
	Ant2	2402	0.68	2401.66	2402.33	0.5	PASS
	Ant1	2441	0.69	2440.65	2441.34	0.5	PASS
	Ant2	2441	0.68	2440.66	2441.34	0.5	PASS
	Ant1	2480	0.69	2479.66	2480.34	0.5	PASS
	Ant2	2480	0.70	2479.65	2480.35	0.5	PASS

SRD2.4G_Ant1_2402

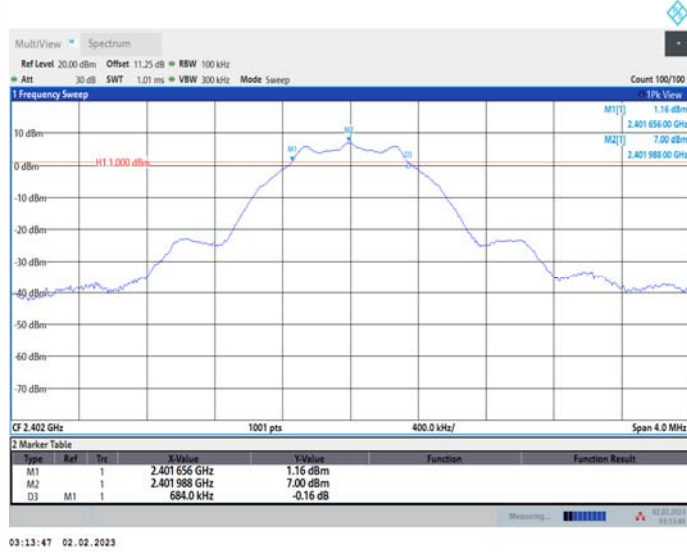

SRD2.4G_Ant2_2402

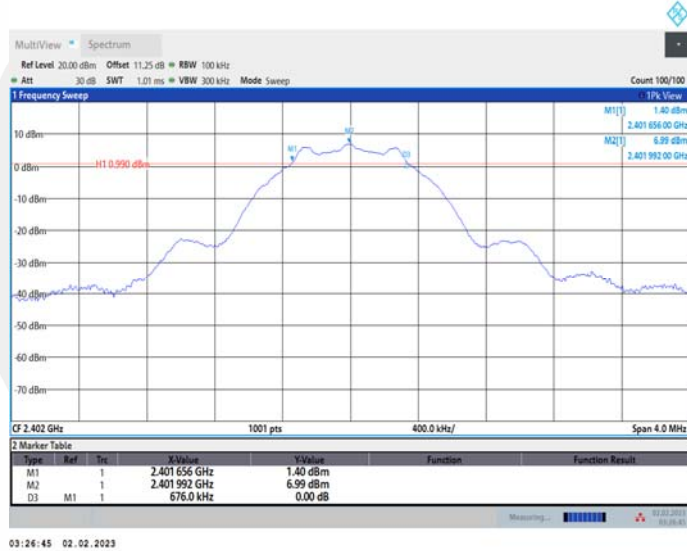

SRD2.4G_Ant1_2441



SRD2.4G_Ant2_2441

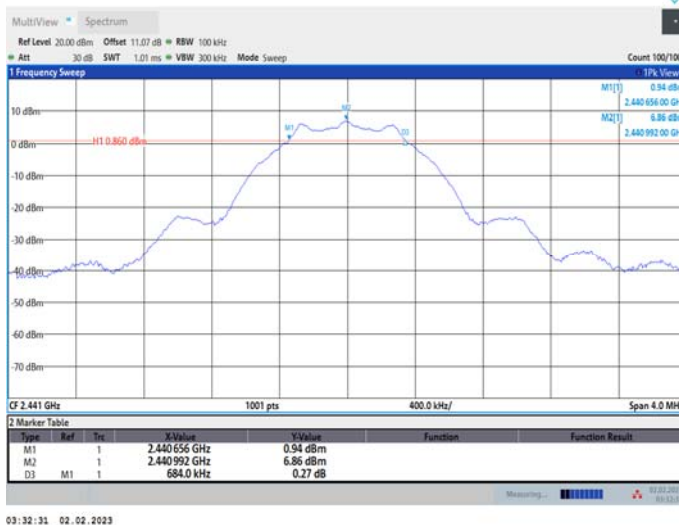

03:32:31 02.02.2023

SRD2.4G_Ant1_2480

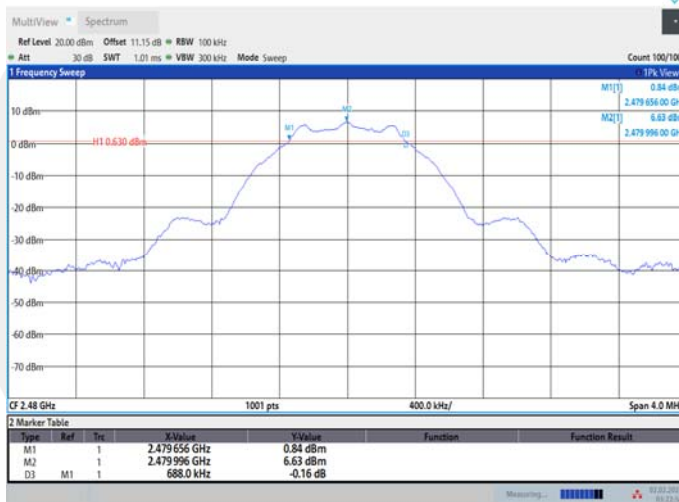

03:22:50 02.02.2023

SRD2.4G_Ant2_2480

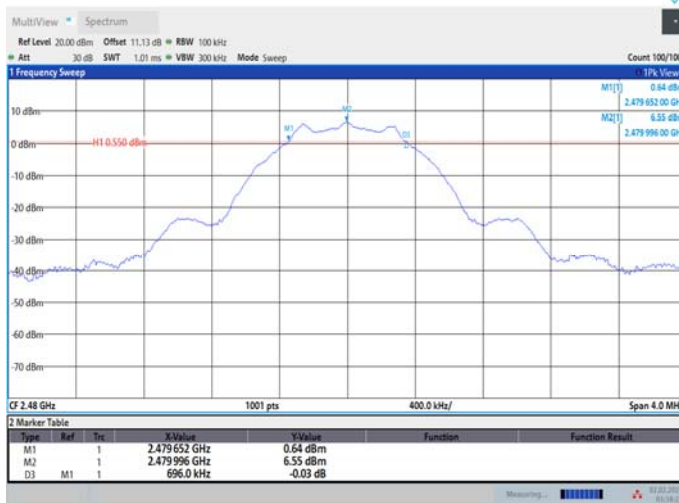

03:38:23 02.02.2023

8.2 MAXIMUM PEAK CONDUCTED OUTPUT POWER

8.2.1 Applicable Standard

According to FCC Part 15.247(b)(3) and KDB 558074 D01 15.247 Meas Guidance v05r02

8.2.2 Conformance Limit

The maximum peak conducted output power of the intentional radiator for systems using digital modulation in the 2400 - 2483.5 MHz bands shall not exceed: 1 Watt (30dBm).

8.2.3 Test Configuration

Test according to clause 7.1 radio frequency test setup 1

8.2.4 Test Procedure

■ According to FCC Part 15.247(b)(3)

As an alternative to a peak power measurement, compliance with the one Watt limit can be based on a measurement of the maximum conducted output power. For smart system, Maximum Conducted Output Power is defined as the total transmit power delivered to all antennas and antenna elements averaged across all symbols in the signaling alphabet when the transmitter is operating at its maximum power control level. Power must be summed across all antennas and antenna elements. If multiple modes of operation are possible (e.g., alternative modulation methods), the maximum conducted output power is the highest total transmit power occurring in any mode.

Set the RBW \geq DTS bandwidth (about 1MHz).

Set VBW = 3*RBW (about 3MHz)

Set the span \geq 3*RBW

Set Sweep time = auto couple.

Set Detector = peak.

Set Trace mode = max hold.

Allow trace to fully stabilize. Use peak marker function to determine the peak amplitude level.

■ According to FCC Part 15.247(b)(4):

Conducted output power limit specified in paragraph (b) of this section is based on the use of antennas with directional gains that do not exceed 6 dBi. If transmitting antennas of directional gain greater than 6 dBi are used, the conducted output power from the intentional radiator shall be reduced below the stated values in paragraphs (b)(3) of this section, as appropriate, by the amount in dB that the directional gain of the antenna exceeds 6 dBi.

Test Results

Temperature:	25° C
Relative Humidity:	45%
ATM Pressure:	1011 mbar

TestMode	Antenna	Frequency[MHz]	Conducted Peak Power[dBm]	Conducted Limit[dBm]	EIRP[dBm]	EIRP Limit[dBm]	Verdict
SRD2.4G	Ant1	2402	7.06	≤ 30	9.08	≤ 36	PASS
	Ant2	2402	7.05	≤ 30	8.50	≤ 36	PASS
	Ant1	2441	7.02	≤ 30	9.04	≤ 36	PASS
	Ant2	2441	6.92	≤ 30	8.37	≤ 36	PASS
	Ant1	2480	6.70	≤ 30	8.72	≤ 36	PASS
	Ant2	2480	6.63	≤ 30	8.08	≤ 36	PASS

SRD2.4G_Ant1_2402

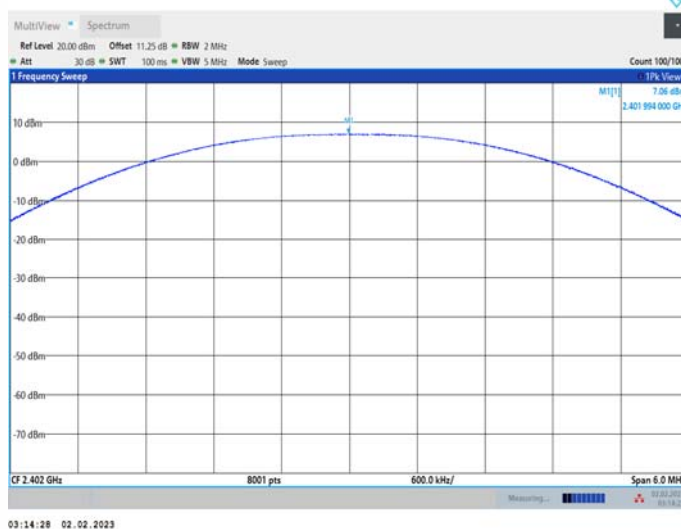

SRD2.4G_Ant2_2402

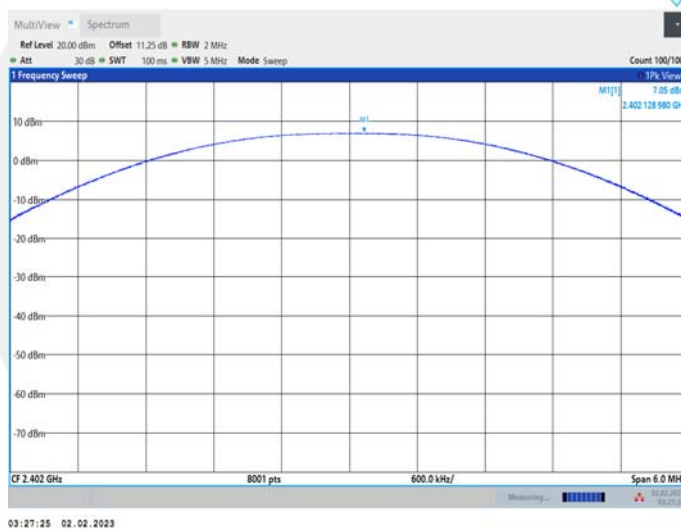

SRD2.4G_Ant1_2441

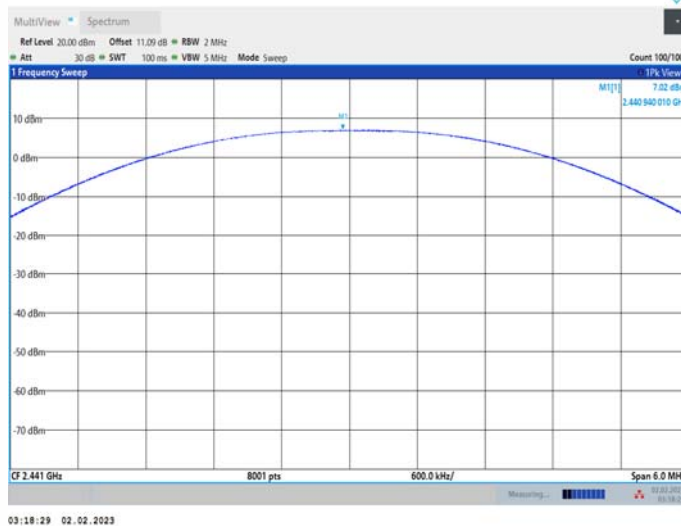

SRD2.4G_Ant2_2441

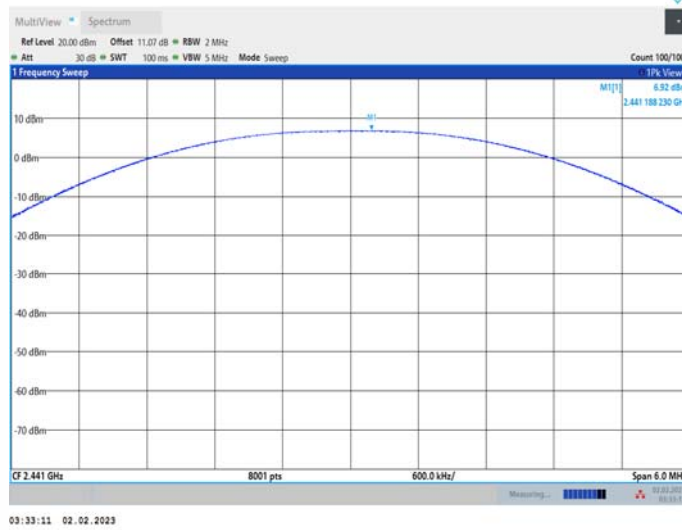

SRD2.4G_Ant1_2480

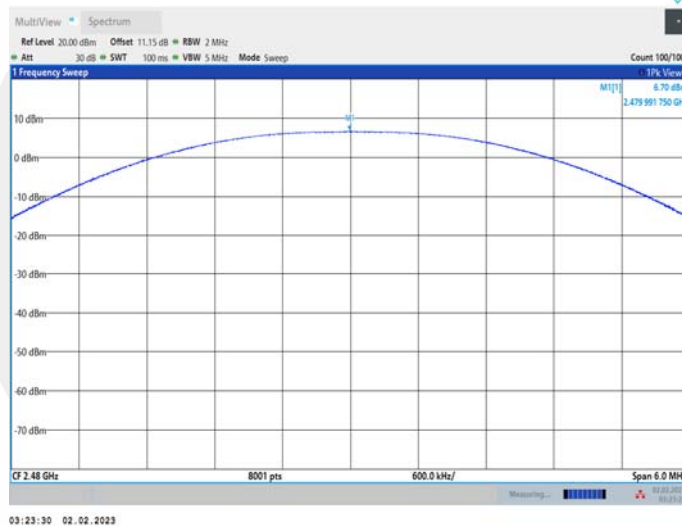

SRD2.4G_Ant2_2480

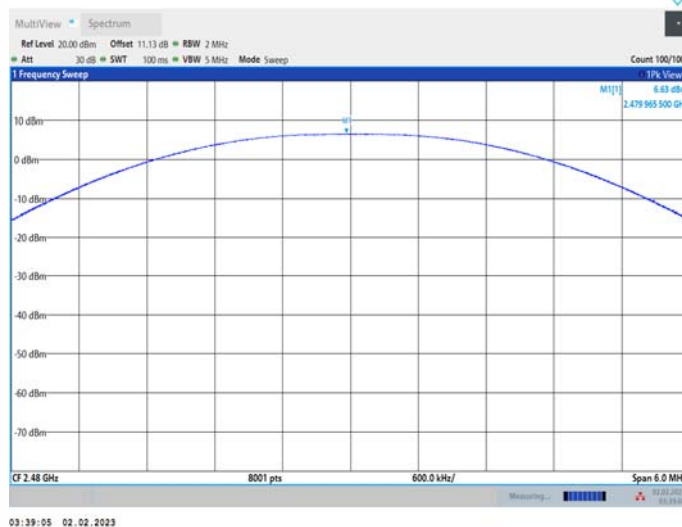

8.3 MAXIMUM POWER SPECTRAL DENSITY

8.3.1 Applicable Standard

According to FCC Part 15.247(e) and KDB 558074 D01 15.247 Meas Guidance v05r02

8.3.2 Conformance Limit

The transmitter power spectral density conducted from the transmitter to the antenna shall not be greater than 8 dBm in any 3 kHz band during any time interval of continuous transmission.

8.3.3 Test Configuration

Test according to clause 7.1 radio frequency test setup 1

8.3.4 Test Procedure

This procedure shall be used if maximum peak conducted output power was used to demonstrate compliance
 The transmitter output (antenna port) was connected to the spectrum analyzer
 Set analyzer center frequency to DTS channel center frequency.
 Set the span to 1.5 times the DTS bandwidth.
 Set the RBW to: 3 kHz
 Set the VBW to: 10 kHz.
 Set Detector = peak.
 Set Sweep time = auto couple.
 Set Trace mode = max hold.
 Allow trace to fully stabilize.
 Use the peak marker function to determine the maximum amplitude level within the RBW.

8.3.5 Test Results

Temperature:	25° C
Relative Humidity:	45%
ATM Pressure:	1011 mbar

TestMode	Antenna	Frequency[MHz]	Result[dBm/3kHz]	Limit[dBm/3kHz]	Verdict
SRD2.4G	Ant1	2402	-5.73	≤8.00	PASS
	Ant2	2402	-5.35	≤8.00	PASS
	Ant1	2441	-5.75	≤8.00	PASS
	Ant2	2441	-4.87	≤8.00	PASS
	Ant1	2480	-5.36	≤8.00	PASS
	Ant2	2480	-5.84	≤8.00	PASS

SRD2.4G_Ant1_2402

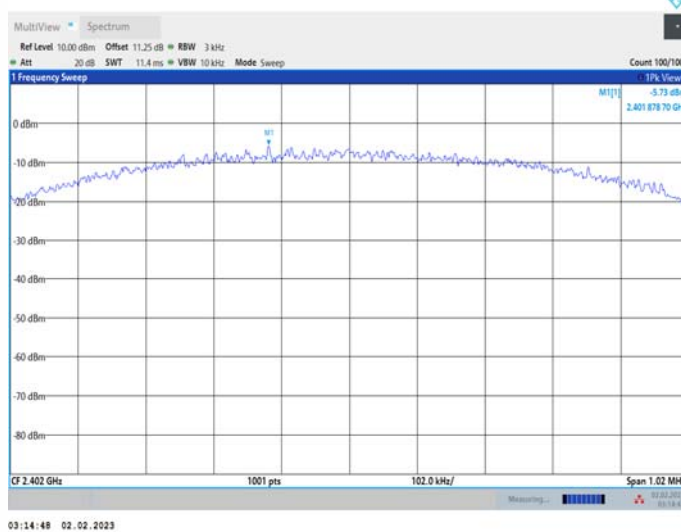

SRD2.4G_Ant2_2402

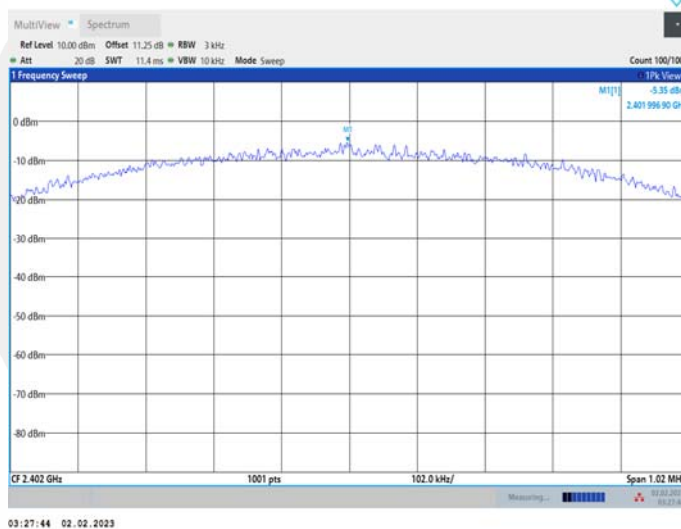

SRD2.4G_Ant1_2441

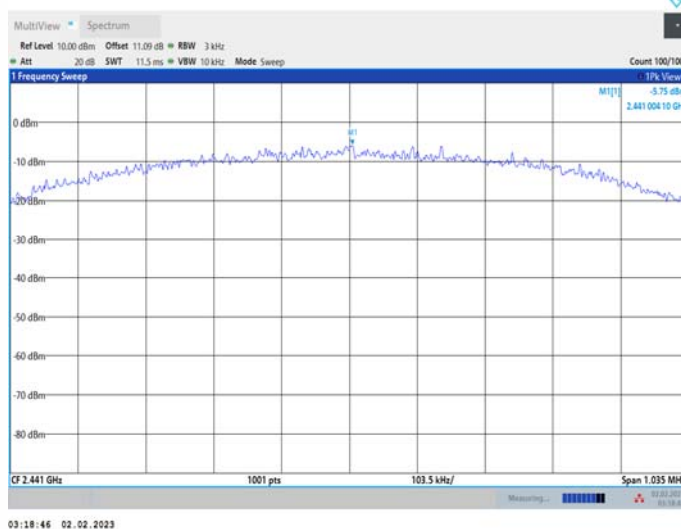

SRD2.4G_Ant2_2441

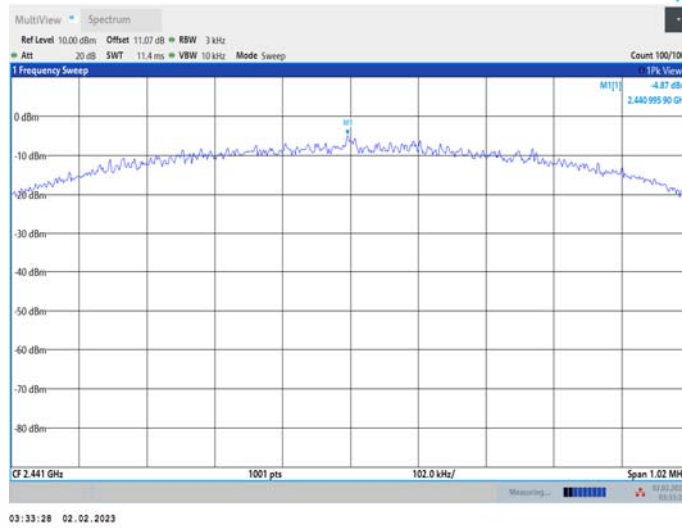

SRD2.4G_Ant1_2480

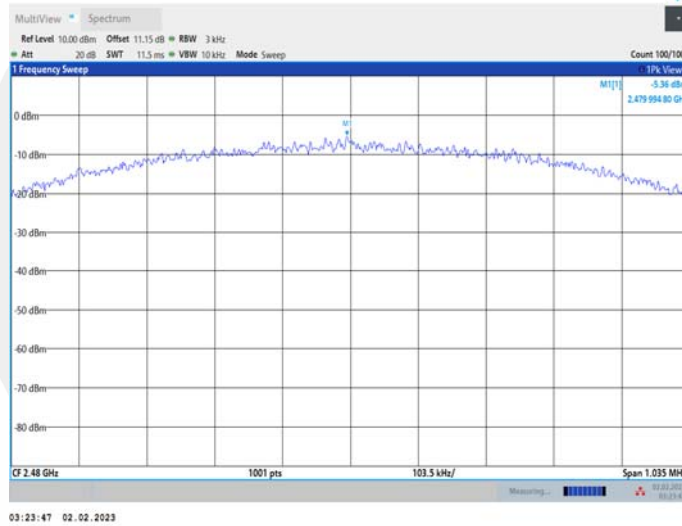

SRD2.4G_Ant2_2480

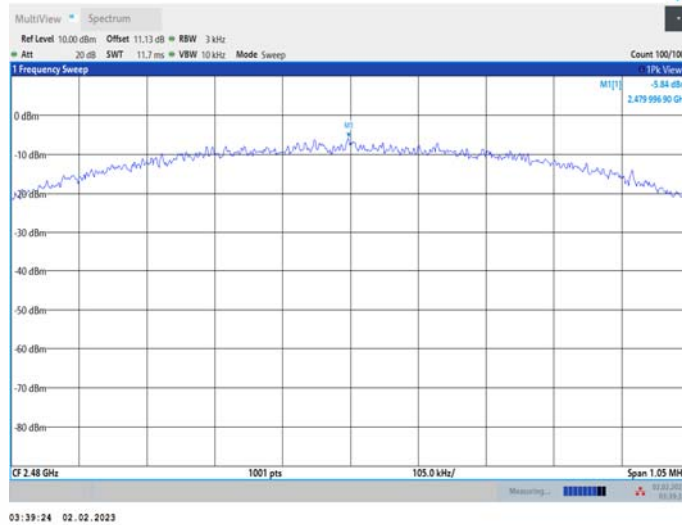

8.4 UNWANTED EMISSIONS IN NON-RESTRICTED FREQUENCY BANDS

8.4.1 Applicable Standard

According to FCC Part 15.247(d) and KDB 558074 D01 15.247 Meas Guidance v05r02

8.4.2 Conformance Limit

According to FCC Part 15.247(d):

In any 100 kHz bandwidth outside the frequency band in which the spread spectrum or digitally modulated intentional radiator is operating, the radio frequency power that is produced by the intentional radiator shall be at least 20 dB below that in the 100 kHz bandwidth within the band that contains the highest level of the desired power, based on either an RF conducted or a radiated measurement, provided the transmitter demonstrates compliance with the peak conducted power limits. If the transmitter complies with the conducted power limits based on the use of RMS averaging over a time interval, as permitted under paragraph (b)(3) of this section, the attenuation required under this paragraph shall be 30 dB instead of 20 dB.

8.4.3 Test Configuration

Test according to clause 7.1 radio frequency test setup 1

8.4.4 Test Procedure

The transmitter output (antenna port) was connected to the spectrum analyzer

■ Reference level measurement

Establish a reference level by using the following procedure:

Set instrument center frequency to DTS channel center frequency.

Set the span to = 1.5 times the DTS bandwidth.

Set the RBW = 100 kHz.

Set the VBW $\geq 3 \times$ RBW.

Set Detector = peak.

Set Sweep time = auto couple.

Set Trace mode = max hold.

Allow trace to fully stabilize.

Use the peak marker function to determine the maximum PSD level.

Note that the channel found to contain the maximum PSD level can be used to establish the reference level.

■ Emission level measurement

Set the center frequency and span to encompass frequency range to be measured.

Set the RBW = 100 kHz.

Set the VBW = 300 kHz.

Set Detector = peak

Sweep time = auto couple.

Trace mode = max hold.

Allow trace to fully stabilize.

Use the peak marker function to determine the maximum amplitude level.

Ensure that the amplitude of all unwanted emissions outside of the authorized frequency band (excluding restricted frequency bands) are attenuated by at least the minimum requirements. Report the three highest emissions relative to the limit.

8.4.5 Test Results

Temperature:	25° C
Relative Humidity:	45%
ATM Pressure:	1011 mbar

Reference level measurement

TestMode	Antenna	Freq(MHz)	Max.Point[MHz]	Result[dBm]
SRD2.4G	Ant1	2402	2401.99	6.98
	Ant2	2402	2401.99	6.97
	Ant1	2441	2440.99	6.94
	Ant2	2441	2440.99	6.84
	Ant1	2480	2480.00	6.63
	Ant2	2480	2480.00	6.56



SRD2.4G_Ant1_2402

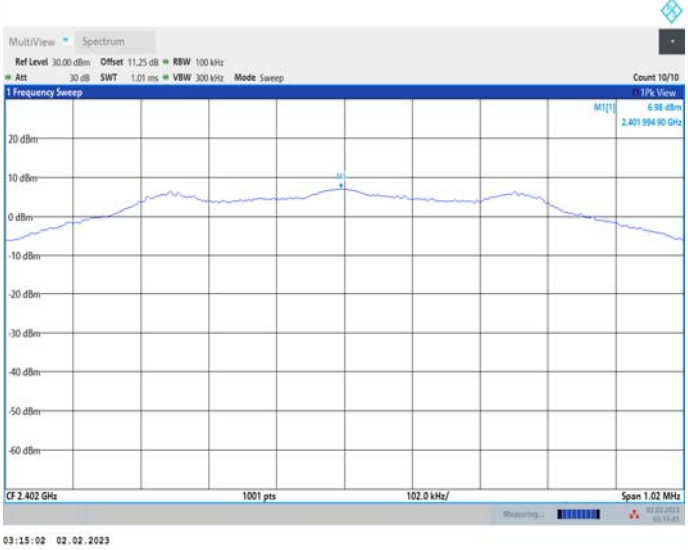

SRD2.4G_Ant2_2402

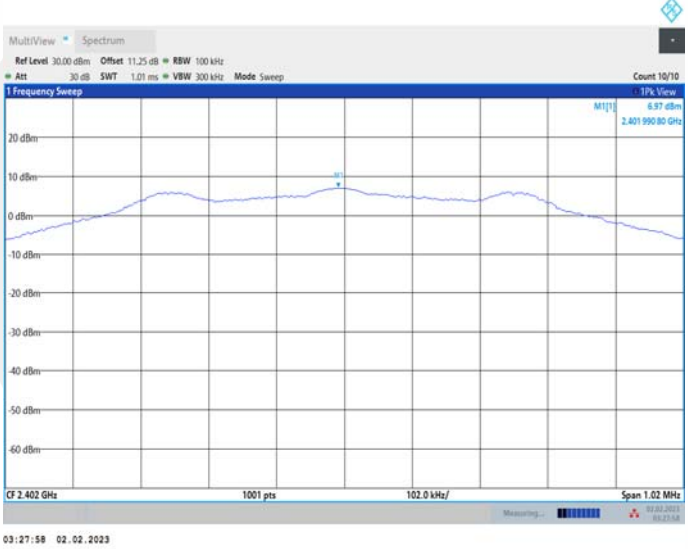

SRD2.4G_Ant1_2441

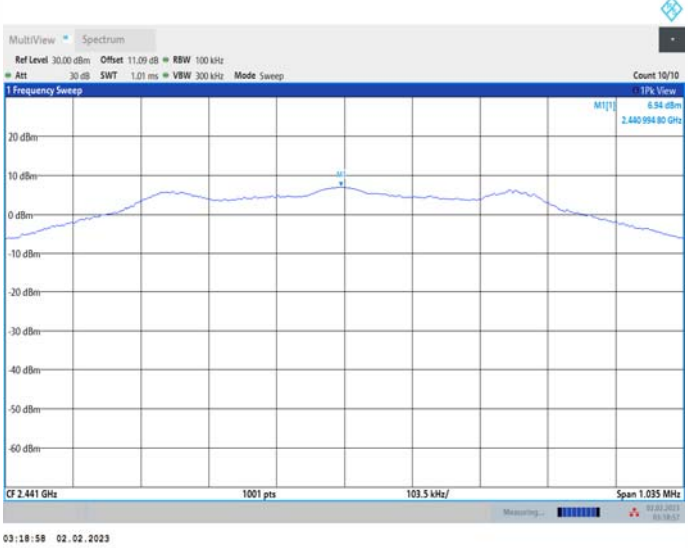

SRD2.4G_Ant2_2441

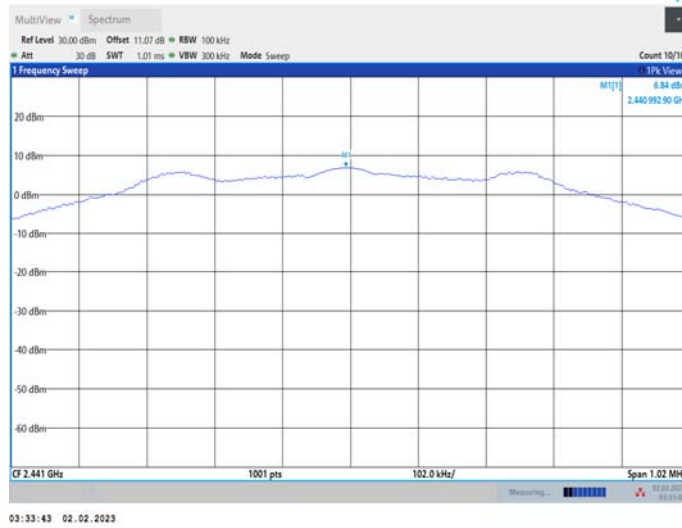

SRD2.4G_Ant1_2480

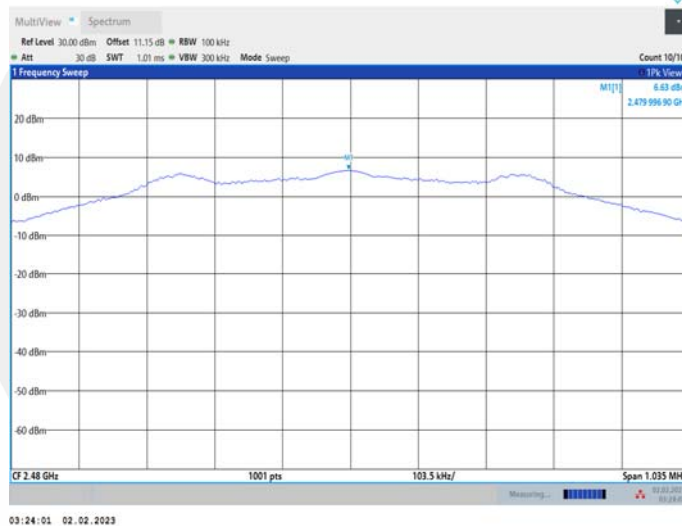

SRD2.4G_Ant2_2480

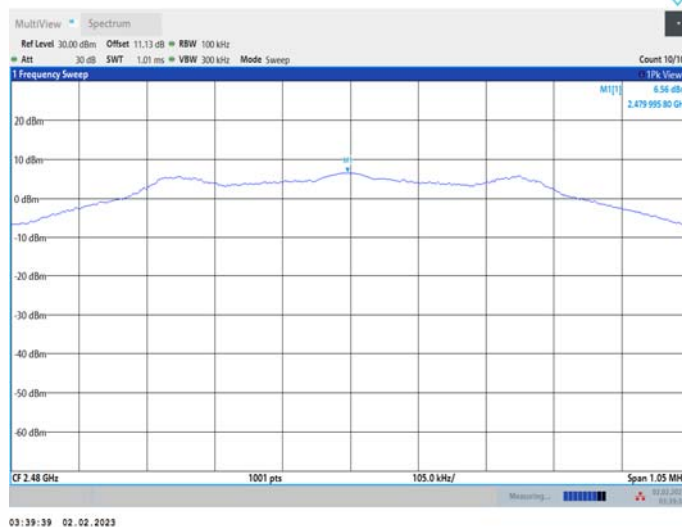

Band edge measurements

TestMode	Antenna	ChName	Frequency[MHz]	RefLevel[dBm]	Result[dBm]	Limit[dBm]	Verdict
SRD2.4G	Ant1	Low	2402	6.98	-40.64	≤-13.02	PASS
	Ant2	Low	2402	6.97	-40.36	≤-13.03	PASS
	Ant1	High	2480	6.63	-45.03	≤-13.37	PASS
	Ant2	High	2480	6.56	-45.19	≤-13.44	PASS



SRD2.4G Ant1_Low_2402

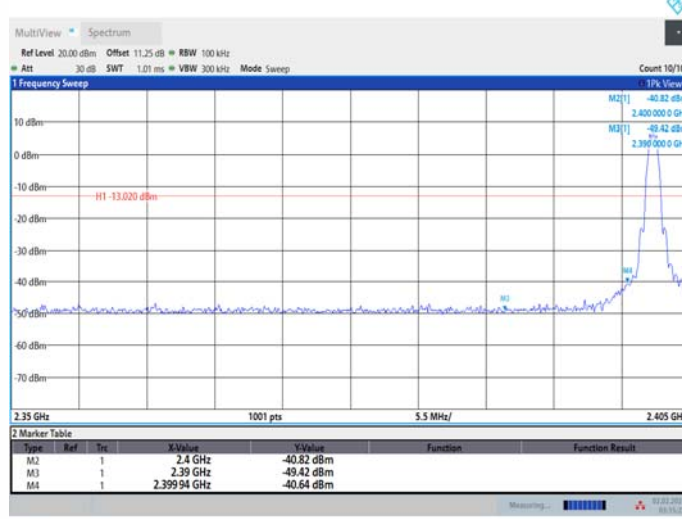

SRD2.4G Ant2_Low_2402

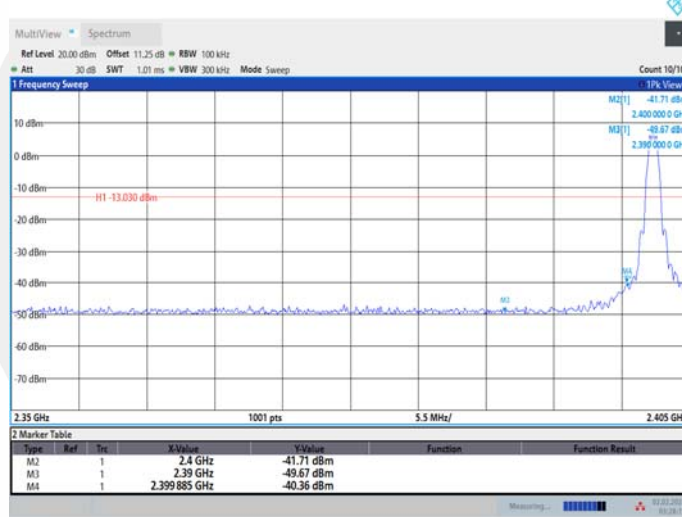

SRD2.4G Ant1_High_2480

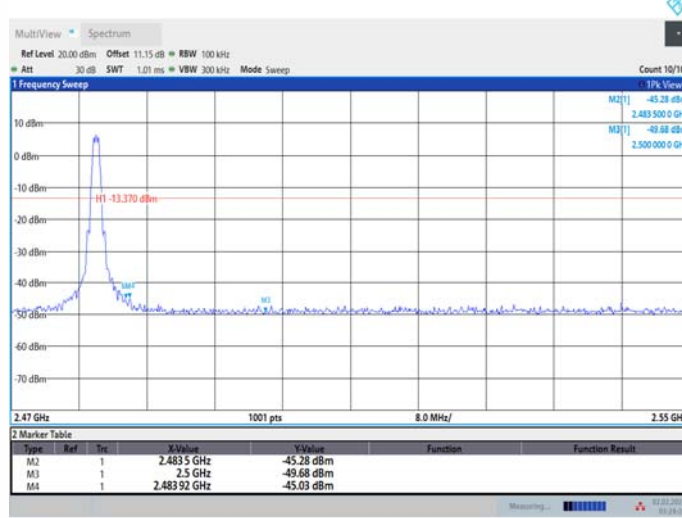

SRD2.4G_Ant2_High_2480

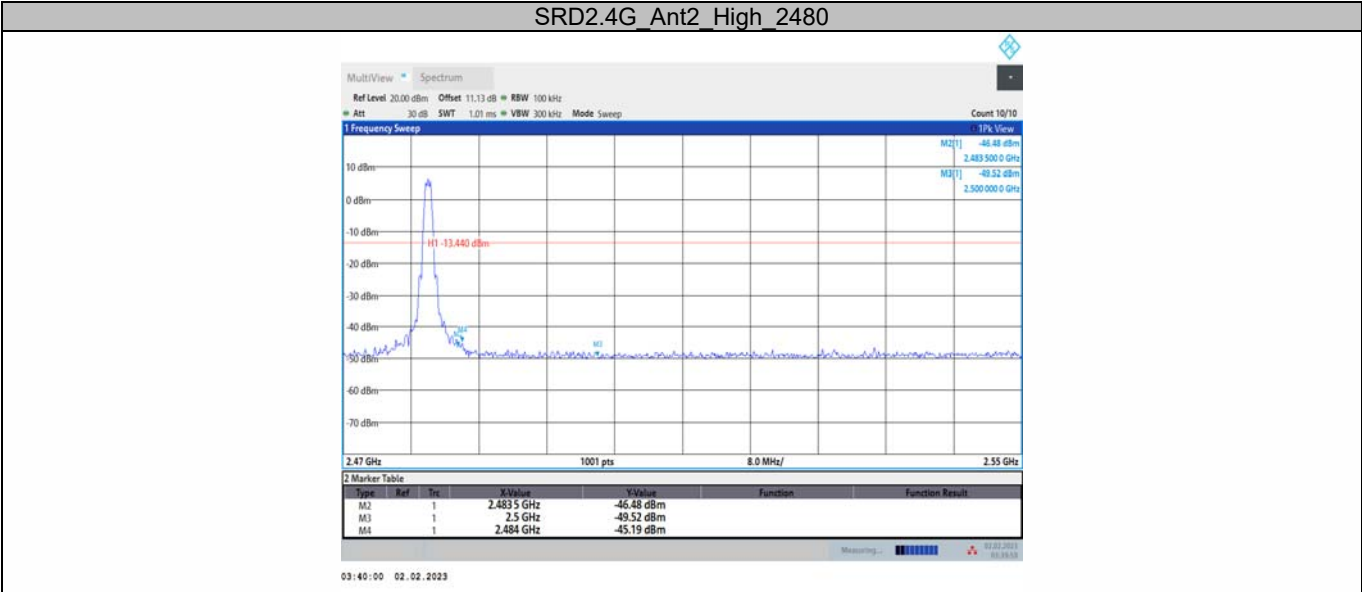

Emission level measurement

TestMode	Antenna	Frequency[MHz]	FreqRange [MHz]	RefLevel [dBm]	Result[dBm]	Limit[dBm]	Verdict
SRD2.4G	Ant1	2402	30~1000	6.98	-53.29	≤-13.02	PASS
			1000~26500	6.98	-44.54	≤-13.02	PASS
	Ant2	2402	30~1000	6.97	-51.71	≤-13.03	PASS
			1000~26500	6.97	-45.53	≤-13.03	PASS
	Ant1	2441	30~1000	6.94	-53.5	≤-13.06	PASS
			1000~26500	6.94	-45.02	≤-13.06	PASS
	Ant2	2441	30~1000	6.84	-53.69	≤-13.16	PASS
			1000~26500	6.84	-44.19	≤-13.16	PASS
	Ant1	2480	30~1000	6.63	-54.19	≤-13.37	PASS
			1000~26500	6.63	-46.16	≤-13.37	PASS
	Ant2	2480	30~1000	6.56	-54.42	≤-13.44	PASS
			1000~26500	6.56	-45.6	≤-13.44	PASS



SRD2.4G_Ant1_2402_30~1000

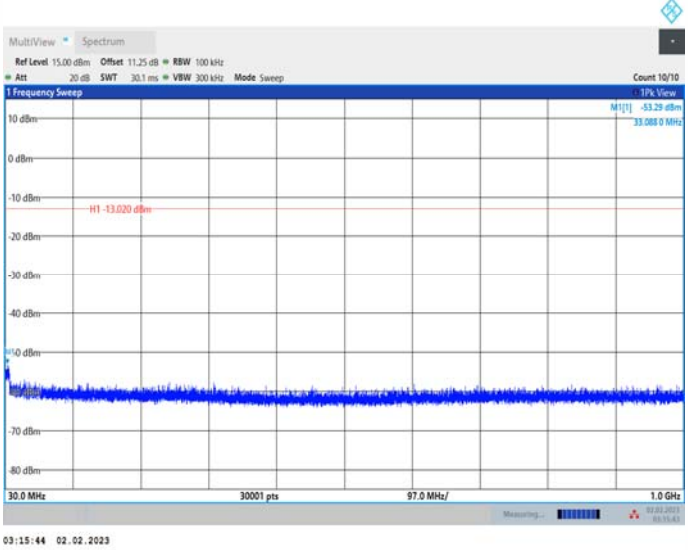

SRD2.4G_Ant1_2402_1000~26500

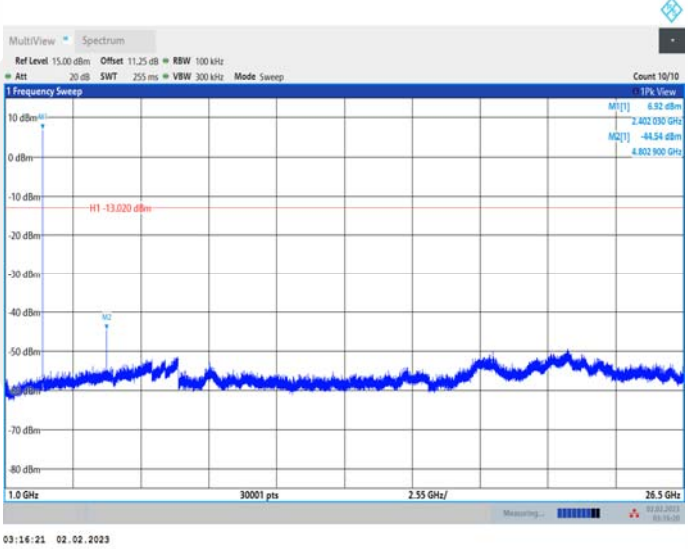

SRD2.4G_Ant2_2402_30~1000

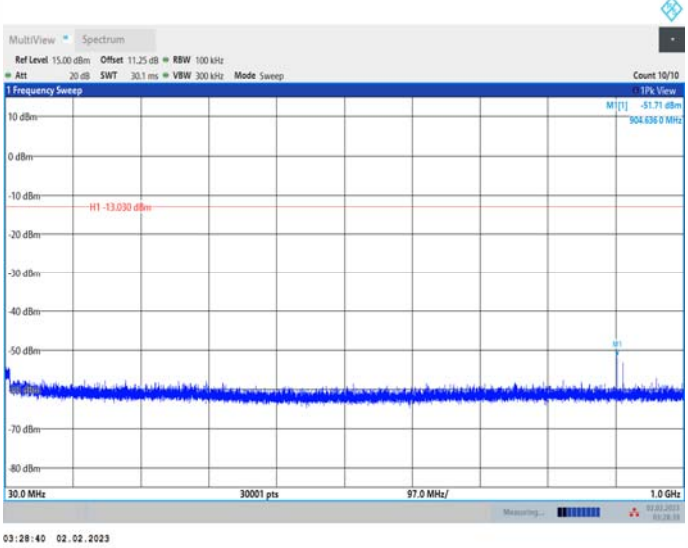

SRD2.4G_Ant2_2402_1000~26500

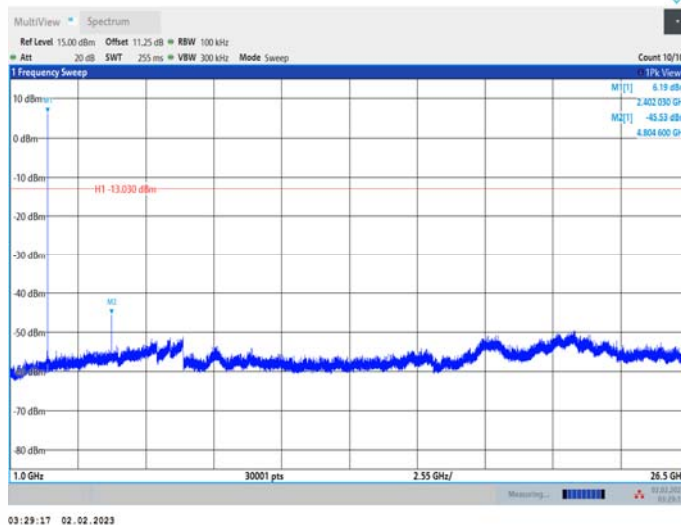

SRD2.4G_Ant1_2441_30~1000

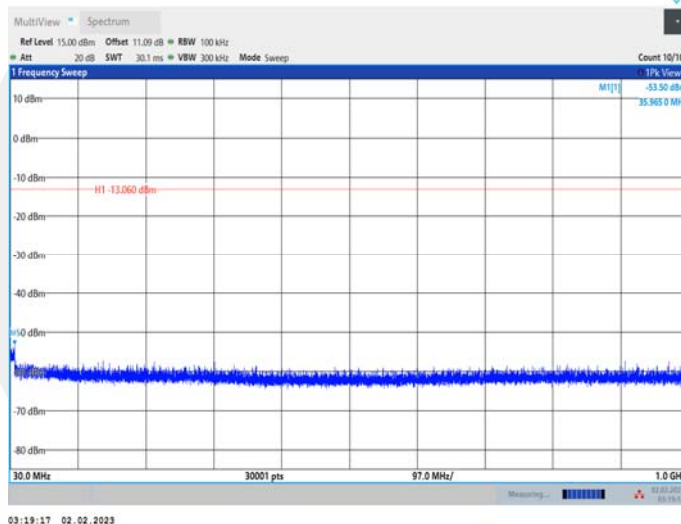

SRD2.4G_Ant1_2441_1000~26500

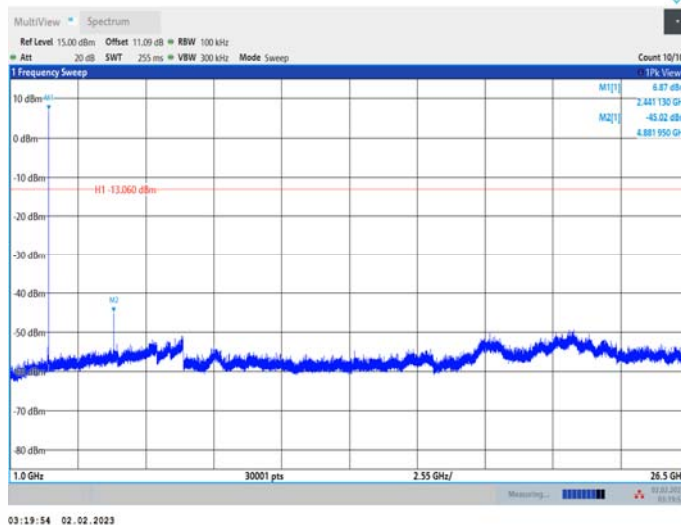

SRD2.4G_Ant2_2441_30~1000

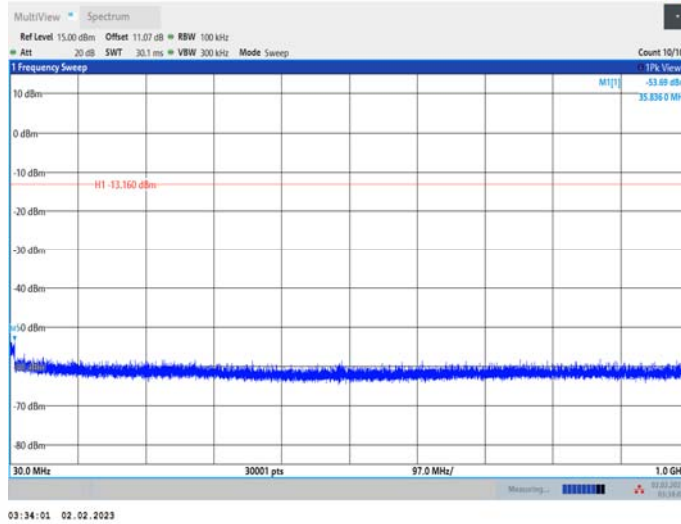

SRD2.4G_Ant2_2441_1000~26500

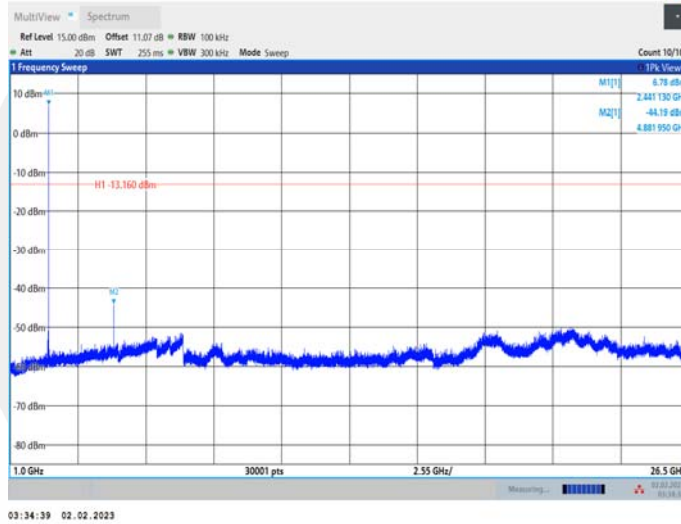

SRD2.4G_Ant1_2480_30~1000

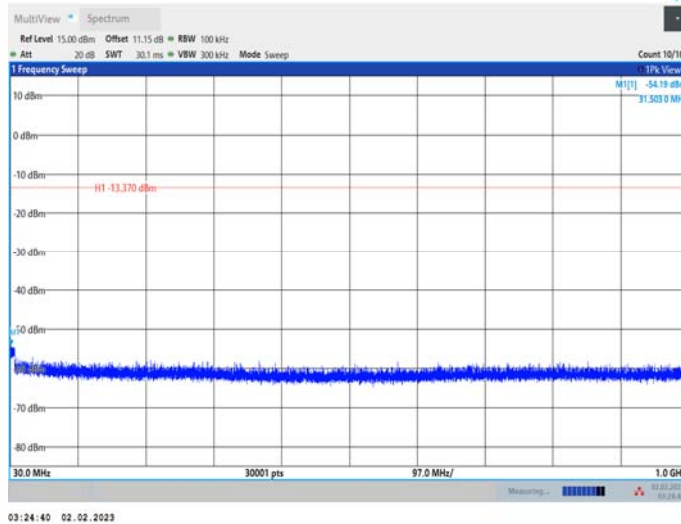

SRD2.4G_Ant1_2480_1000~26500

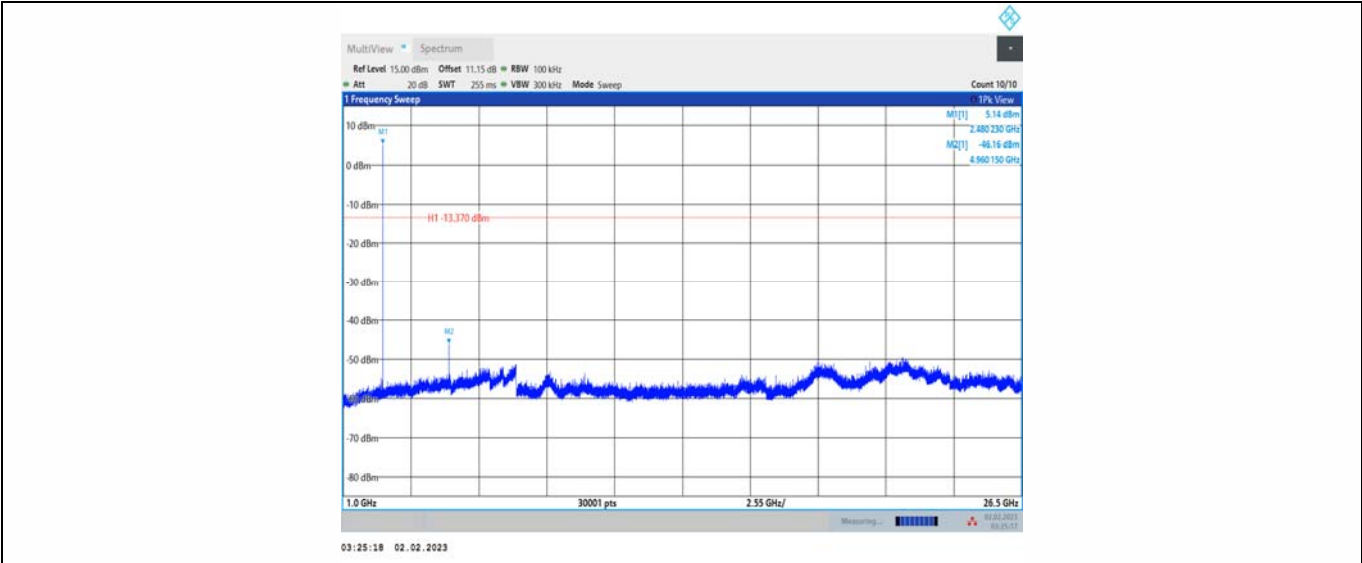

SRD2.4G Ant2 2480 30~1000

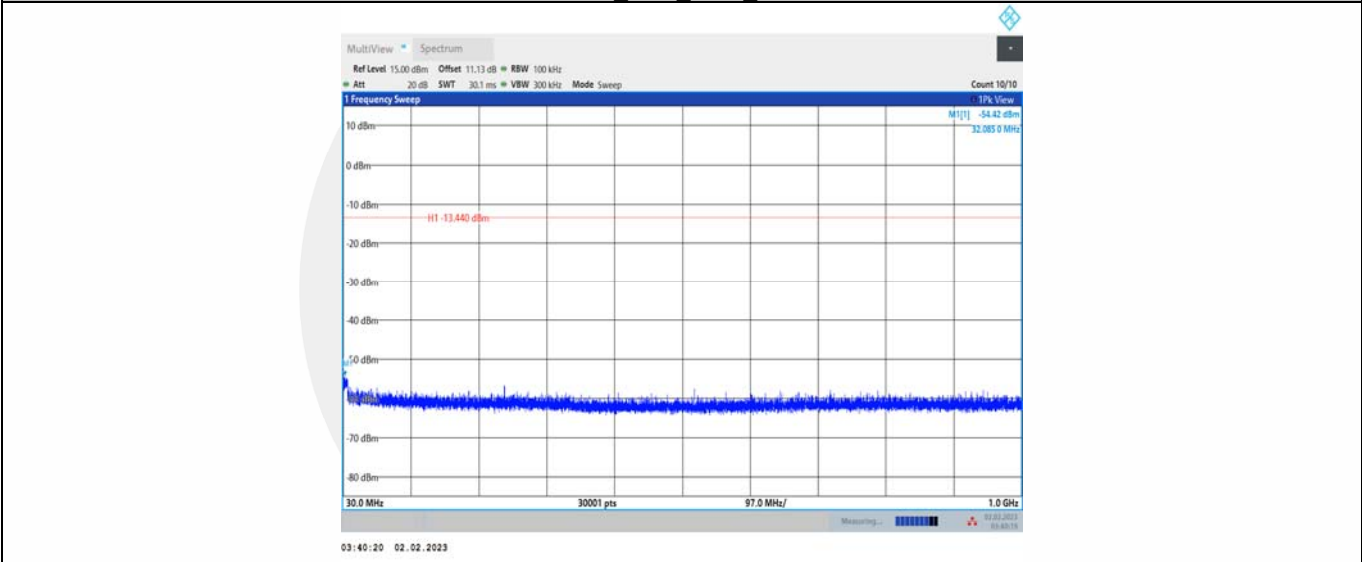

SRD2.4G Ant2 2480 1000~26500

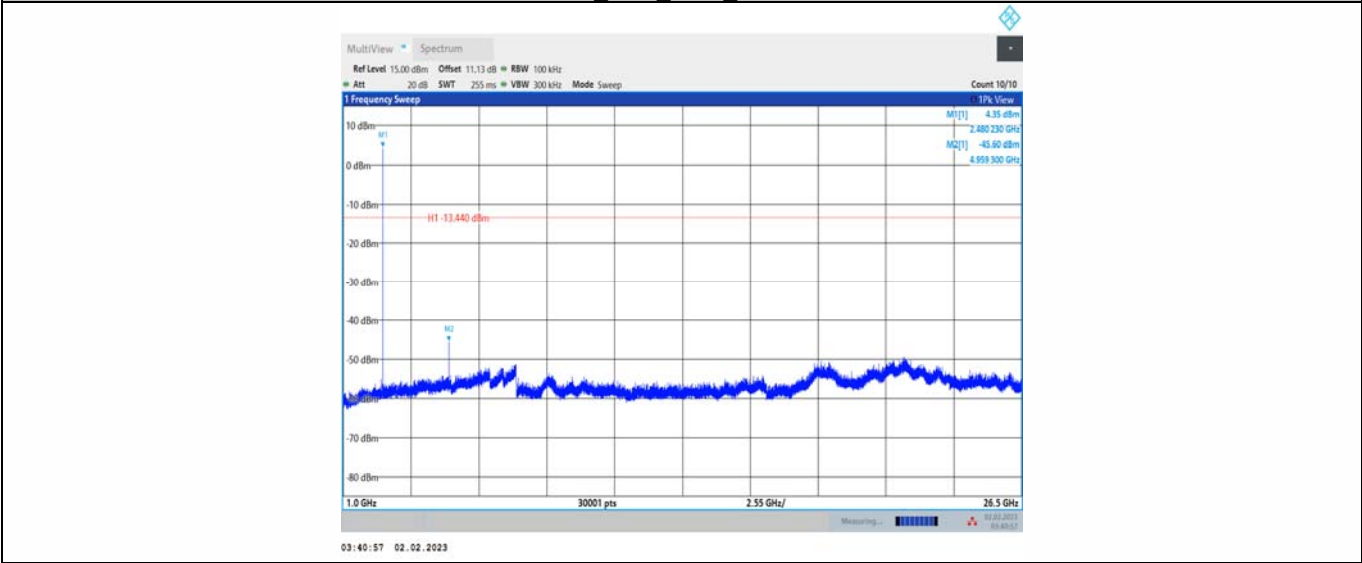

8.5 RADIATED SPURIOUS EMISSION

8.5.1 Applicable Standard

According to FCC Part 15.247(d) and 15.209 and KDB 558074 D01 15.247 Meas Guidance v05r02

8.5.2 Conformance Limit

According to FCC Part 15.247(d): radiated emissions which fall in the restricted bands, as defined in §15.205(a), must also comply with the radiated emission limits specified in §15.209(a) (see §15.205(c)).

According to FCC Part 15.205, Restricted bands

MHz	MHz	MHz	GHz
0.090-0.110	16.42-16.423	399.9-410	4.5-5.15
10.495-0.505	16.69475-16.69525	608-614	5.35-5.46
2.1735-2.1905	16.80425-16.80475	960-1240	7.25-7.75
4.125-4.128	25.5-25.67	1300-1427	8.025-8.5
4.17725-4.17775	37.5-38.25	1435-1626.5	9.0-9.2
4.20725-4.20775	73-74.6	1645.5-1646.5	9.3-9.5
6.215-6.218	74.8-75.2	1660-1710	10.6-12.7
6.26775-6.26825	123-138	2200-2300	14.47-14.5
8.291-8.294	149.9-150.05	2310-2390	15.35-16.2
8.362-8.366	156.52475-156.52525	2483.5-2500	17.7-21.4
8.37625-8.38675	156.7-156.9	2690-2900	22.01-23.12
8.41425-8.41475	162.0125-167.17	3260-3267	23.6-24.0
12.29-12.293	167.72-173.2	3332-3339	31.2-31.8
12.51975-12.52025	240-285	3345.8-3358	36.43-36.5
12.57675-12.57725	322-335.4	3600-4400	(2)
13.36-13.41			

According to FCC Part 15.205, the level of any transmitter spurious emission in Restricted bands shall not exceed the level of the emission specified in the following table

Restricted Frequency(MHz)	Field Strength (μV/m)	Field Strength (dBμV/m)	Measurement Distance
0.009-0.490	2400/F(KHz)	20 log (uV/m)	300
0.490-1.705	24000/F(KHz)	20 log (uV/m)	30
1.705-30	30	29.5	30
30-88	100	40	3
88-216	150	43.5	3
216-960	200	46	3
Above 960	500	54	3

8.5.3 Test Configuration

Test according to clause 7.2 radio frequency test setup 2

8.5.4 Test Procedure

This test is required for any spurious emission that falls in a Restricted Band, as defined in Section 15.205. It must be performed with the highest gain of each type of antenna proposed for use with the EUT. Use the following spectrum analyzer settings:

The EUT was placed on a turn table which is 0.8m above ground plane.

Maximum procedure was performed on the highest emissions to ensure EUT compliance.

Span = wide enough to fully capture the emission being measured

RBW = 1 MHz for $f \geq 1$ GHz(1GHz to 25GHz), 100 kHz for $f < 1$ GHz(30MHz to 1GHz)

VBW \geq RBW

Sweep = auto

Detector function = peak

Trace = max hold

Follow the guidelines in ANSI C63.10-2013 with respect to maximizing the emission by rotating the EUT, measuring the emission while the EUT is situated in three orthogonal planes (if appropriate), adjusting the measurement antenna height and polarization, etc. A pre-amp and a high pass filter are required for this test, in order to provide the measuring system with sufficient sensitivity. Allow the trace to stabilize. The peak reading of the emission, after being corrected by the antenna factor, cable loss, pre-amp gain, etc., is the peak field strength, which must comply with the limit specified in Section 15.35(b). Submit this data.

Now set the VBW to 10 Hz, while maintaining all of the other instrument settings. This peak level, once corrected, must comply with the limit specified in Section 15.209. If the dwell time per channel of the hopping signal is less than 100 ms, then the reading obtained with the 10 Hz VBW may be further adjusted by a “duty cycle correction factor”, derived from $20\log(\text{dwell time}/100 \text{ ms})$, in an effort to demonstrate compliance with the 15.209 limit. Submit this data.

Repeat above procedures until all frequency measured was complete.

8.5.5 Test Results

Temperature:	25° C
Relative Humidity:	60%
ATM Pressure:	1011 mbar

■ Spurious Emission below 30MHz (9KHz to 30MHz)

Freq. (MHz)	Ant.Pol. H/V	Emission Level(dBuV/m)		Limit 3m(dBuV/m)		Over(dB)	
		PK	AV	PK	AV	PK	AV
--	--	--	--	--	--	--	--

Note: the amplitude of spurious emission that is attenuated by more than 20dB below the permissible limit has no need to be reported.

Distance extrapolation factor = $40\log(\text{Specific distance}/ \text{test distance})$ (dB);

Limit line = Specific limits(dBuV) + distance extrapolation factor

■ Spurious Emission Above 1GHz (1GHz to 25GHz)

All the antenna(Antenna 1&2) and modes(GFSK) have been tested and the worst(Antenna 1, GFSK) result recorded was report as below:

Test mode: Ant 1 Frequency: Channel 0: 2402MHz

Freq. (MHz)	Ant.Pol.	Emission Level(dBuV/m)		Limit 3m(dBuV/m)		Over(dB)		
		H/V	PK	AV	PK	AV	PK	AV
11495.6	V		61.10	47.13	74	54	12.90	6.87
14647.5	V		66.02	48.76	74	54	7.98	5.24
17610	V		68.51	50.37	74	54	5.49	3.63
11253.7	H		60.56	45.64	74	54	13.44	8.36
14726.2	H		64.89	47.47	74	54	9.11	6.53
17583.7	H		68.92	49.61	74	54	5.08	4.39

Test mode: Ant 1 Frequency: Channel 39: 2441MHz

Freq. (MHz)	Ant.Pol.	Emission Level(dBuV/m)		Limit 3m(dBuV/m)		Over(dB)		
		H/V	PK	AV	PK	AV	PK	AV
11345.6	V		60.19	45.71	74	54	13.81	8.29
14645.6	V		65.43	48.87	74	54	8.57	5.13
17645.6	V		69.13	48.89	74	54	4.87	5.11
11505	H		60.76	48.09	74	54	13.24	5.91
14649.3	H		65.22	50.17	74	54	8.78	3.83
17602.5	H		69.13	50.61	74	54	4.87	3.39

Test mode: Ant 1 Frequency: Channel 78: 2480MHz

Freq. (MHz)	Ant.Pol.	Emission Level(dBuV/m)		Limit 3m(dBuV/m)		Over(dB)		
		H/V	PK	AV	PK	AV	PK	AV
11293.1	V		60.67	46.58	74	54	13.33	7.42
14953.1	V		63.05	47.44	74	54	10.95	6.56
17595	V		68.37	50.23	74	54	5.63	3.77
11385	H		60.77	48.99	74	54	13.23	5.01
14645.6	H		65.67	50.88	74	54	8.33	3.12
17606.2	H		68.34	50.59	74	54	5.66	3.41

- Note:**
- (1) All Readings are Peak Value (VBW=3MHz) and Average Value (VBW=10Hz).
 - (2) Emission Level= Reading Level+Correct Factor.
 - (3) Correct Factor= Ant_F + Cab_L - Preamp
 - (4) The reading of emissions are attenuated more than 20dB below the permissible limits or the field strength is too small to be measured.

■ Spurious Emission in Restricted Band 2310-2390MHz and 2483.5-2500MHz

Test mode: SRD 2.4G Frequency: Channel 0: 2402MHz

Frequency (MHz)	Polarity	PK(dBuV/m) (VBW=3MHz)	Limit 3m (dBuV/m)	Margin (dB)	AV(dBuV/m) (VBW=10Hz)	Limit 3m (dBuV/m)	Margin (dB)
2389.98	H	53.52	74	20.48	46.20	54	7.80
2386.52	V	48.01	74	25.99	41.55	54	12.45

Test mode: SRD 2.4G Frequency: Channel 78: 2480MHz

Frequency (MHz)	Polarity	PK(dBuV/m) (VBW=3MHz)	Limit 3m (dBuV/m)	Margin (dB)	AV(dBuV/m) (VBW=10Hz)	Limit 3m (dBuV/m)	Margin (dB)
2483.54	H	67.68	74	6.32	48.23	54	5.77
2483.74	V	48.90	74	25.10	39.55	54	14.45

- Note:**
- (1) All Readings are Peak Value (VBW=3MHz) and Average Value (VBW=10Hz).
 - (2) Emission Level= Reading Level+Correct Factor.
 - (3) Correct Factor= Ant_F + Cab_L - Preamp
 - (4) The reading of emissions are attenuated more than 20dB below the permissible limits or the field strength is too small to be measured.

Test Model Spurious Emission in Restricted Band 2310-2390MHz
SRD 2.4G
Channel 0: 2402MHz H

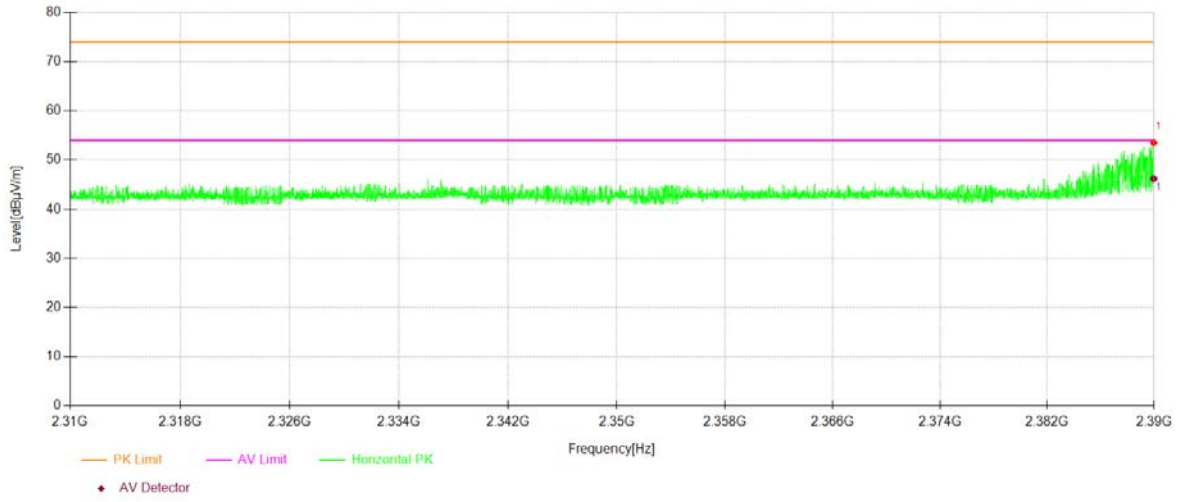

Test Model Spurious Emission in Restricted Band 2310-2390MHz
SRD 2.4G
Channel 0: 2402MHz V

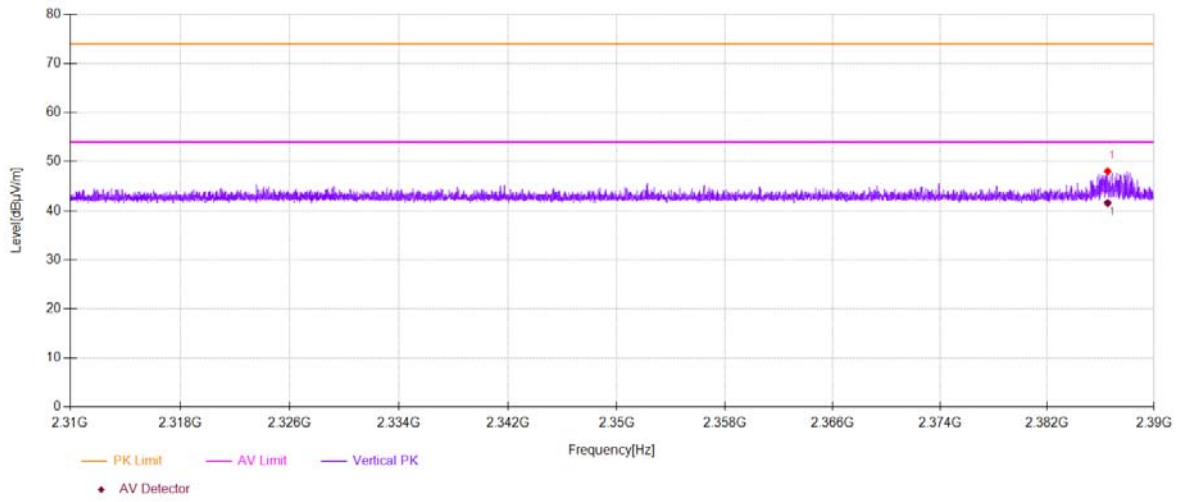

Test Model Spurious Emission in Restricted Band 2483.5-2500MHz
SRD 2.4G
 Channel 78: 2480MHz H

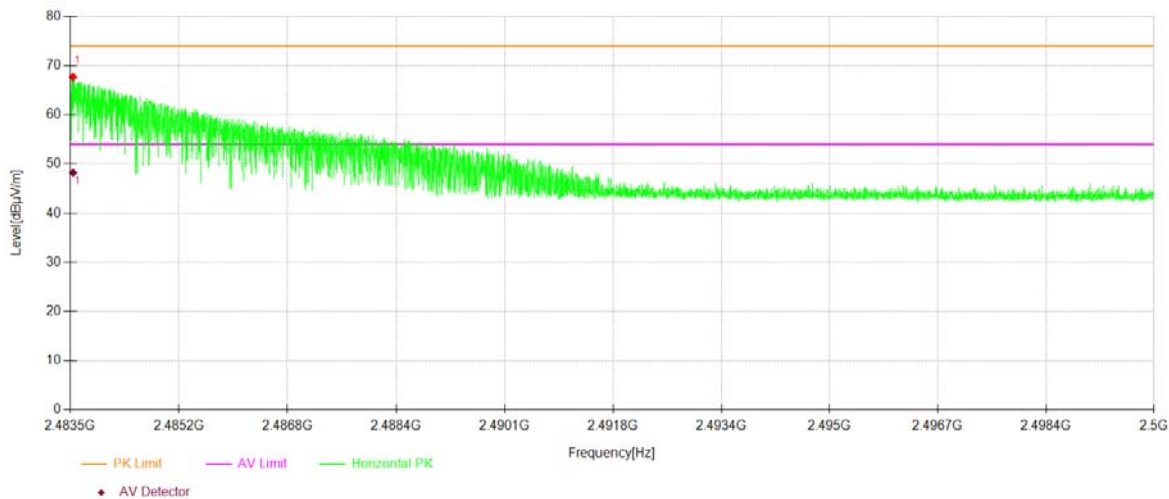

Test Model Spurious Emission in Restricted Band 2483.5-2500MHz
SRD 2.4G
 Channel 78: 2480MHz V

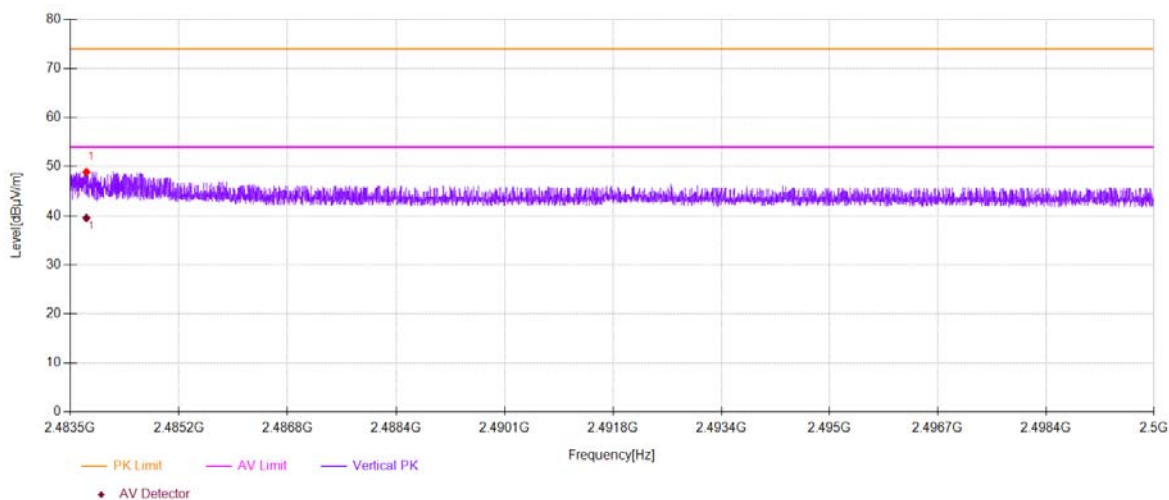

■ Spurious Emission below 1GHz (30MHz to 1GHz)

All the antenna(Antenna 1&2) and modes(GFSK) have been tested and the worst(Antenna 1, GFSK) result recorded was report as below:

2402

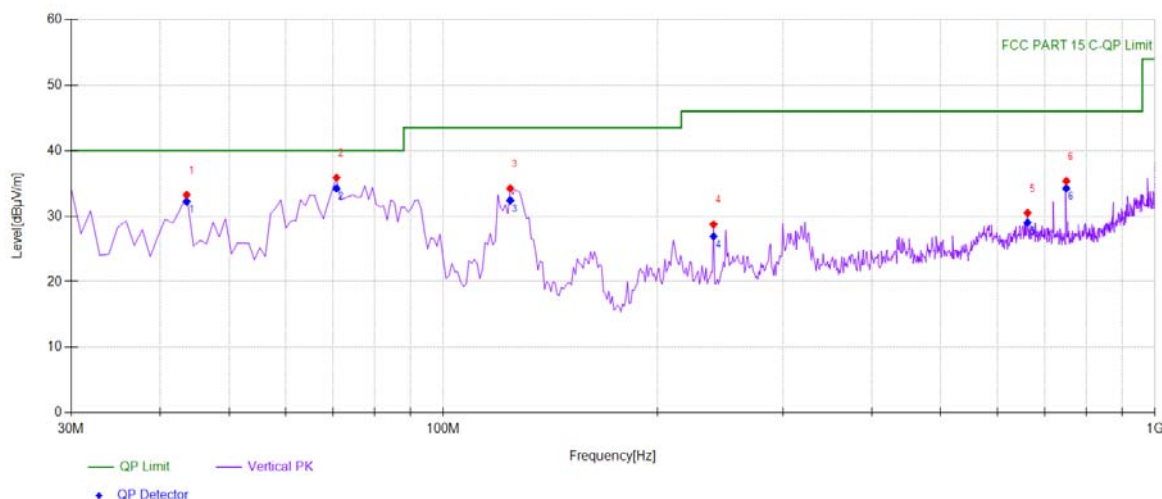

Suspected Data List										
NO.	Freq. [MHz]	Reading [dBμV]	Factor [dB/m]	Level [dBμV/m]	Detector	Limit [dBμV/m]	Margin [dB]	Polarity	Angle[°]	Height [cm]
1	43.5936	50.90	-17.66	33.24	PK	40.00	6.76	V	329	100
2	70.7808	55.96	-20.08	35.88	PK	40.00	4.12	V	51	100
3	124.184	52.60	-18.37	34.23	PK	43.50	9.27	V	275	100
4	239.729	43.95	-15.21	28.74	PK	46.00	17.26	V	275	100
5	662.102	36.61	-6.13	30.48	PK	46.00	15.52	V	97	100
6	750.460	40.67	-5.33	35.34	PK	46.00	10.66	V	320	100

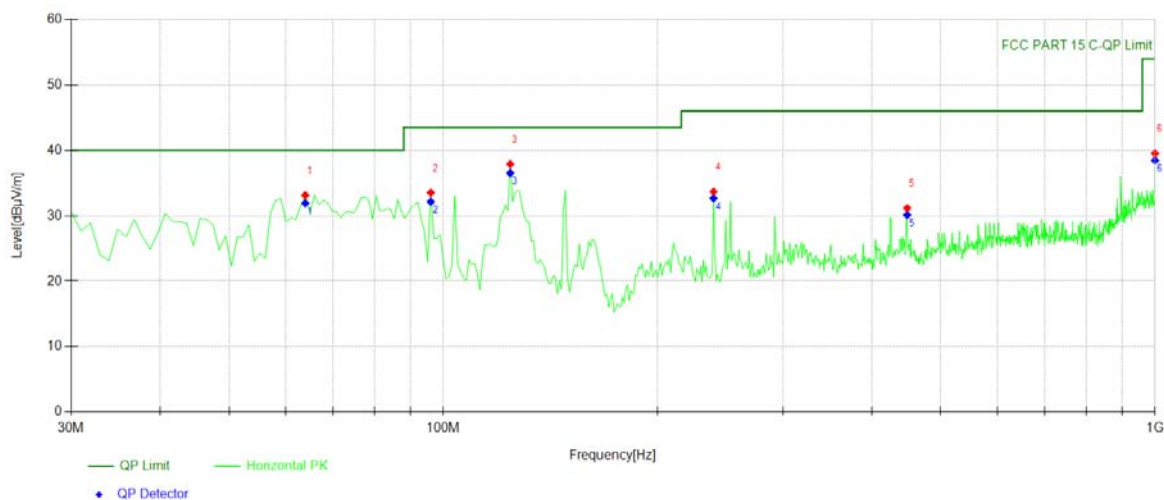

Suspected Data List

NO.	Freq. [MHz]	Reading [dBµV]	Factor [dB/m]	Level [dBµV/m]	Detector	Limit [dBµV/m]	Margin [dB]	Polarity	Angle[°]	Height[cm]
1	63.984	52.22	-19.11	33.11	PK	40.00	6.89	H	49	100
2	96.026	51.25	-17.73	33.52	PK	43.50	9.98	H	196	100
3	124.184	56.26	-18.37	37.89	PK	43.50	5.61	H	306	100
4	239.729	48.89	-15.21	33.68	PK	46.00	12.32	H	191	100
5	448.488	42.28	-11.14	31.14	PK	46.00	14.86	H	191	100
6	1000	41.21	-1.72	39.49	PK	54.00	14.51	H	76	100

2441

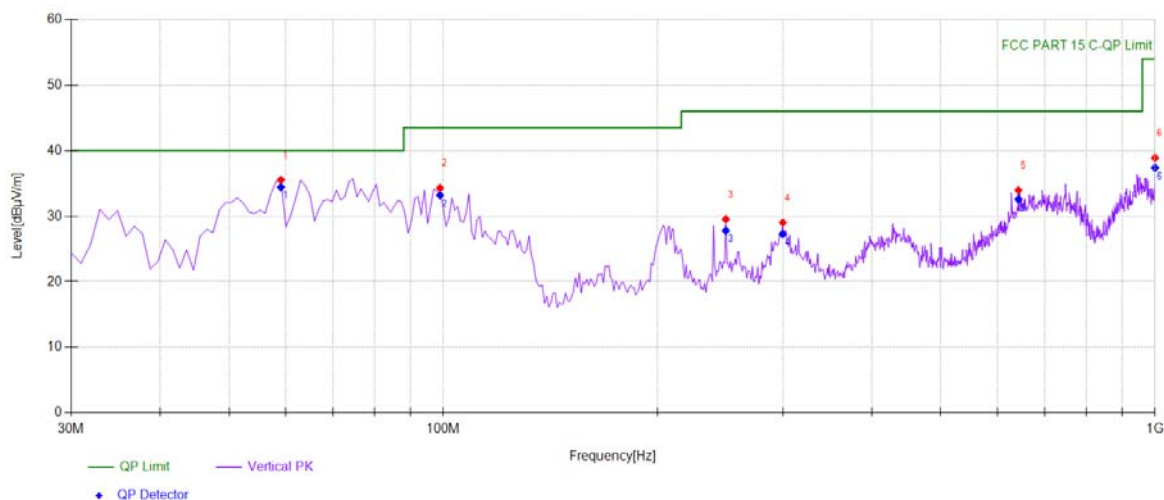

Suspected Data List

NO.	Freq. [MHz]	Reading [dBµV]	Factor [dB/m]	Level [dBµV/m]	Detector	Limit [dBµV/m]	Margin [dB]	Polarity	Angle[°]	Height [cm]
1	59.1291	53.95	-18.43	35.52	PK	40.00	4.48	V	16	100
2	98.9389	51.34	-17.05	34.29	PK	43.50	9.21	V	202	100
3	249.439	44.71	-15.17	29.54	PK	46.00	16.46	V	198	100
4	299.929	43.17	-14.14	29.03	PK	46.00	16.97	V	184	100
5	642.682	40.19	-6.24	33.95	PK	46.00	12.05	V	30	100
6	1000	40.62	-1.72	38.90	PK	54.00	15.10	V	80	100

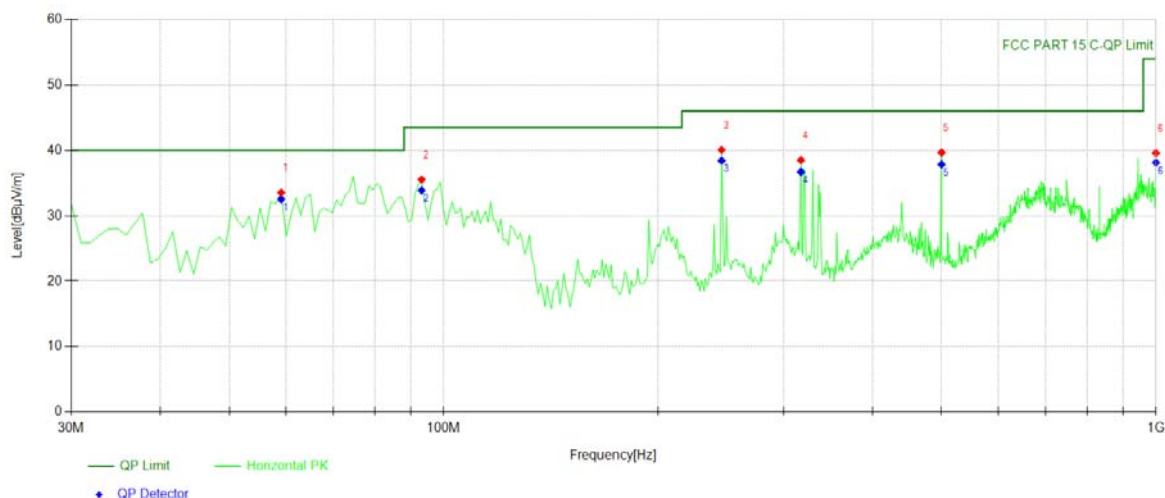

Suspected Data List

NO.	Freq. [MHz]	Reading [dBµV]	Factor [dB/m]	Level [dBµV/m]	Detector	Limit [dBµV/m]	Margin [dB]	Polarity	Angle[°]	Height [cm]
1	59.1291	51.96	-18.43	33.53	PK	40.00	6.47	H	30	100
2	93.1131	53.94	-18.43	35.51	PK	43.50	7.99	H	258	100
3	245.555	55.24	-15.18	40.06	PK	46.00	5.94	H	244	100
4	317.407	52.65	-14.14	38.51	PK	46.00	7.49	H	244	100
5	499.95	49.41	-9.76	39.65	PK	46.00	6.35	H	263	100
6	1000	41.29	-1.72	39.57	PK	54.00	14.43	H	71	100

2480

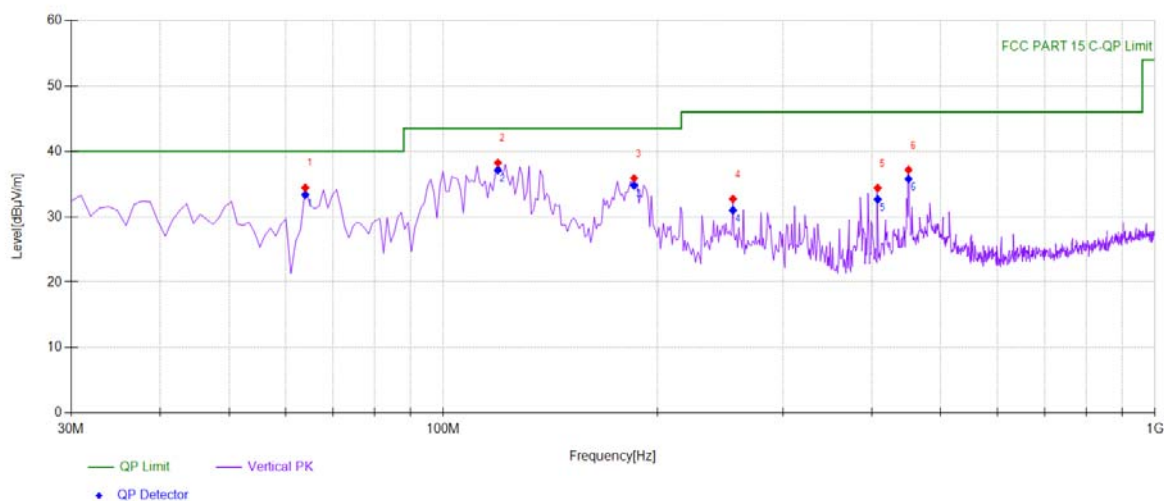

Suspected Data List

NO.	Freq. [MHz]	Reading [dBµV]	Factor [dB/m]	Level [dBµV/m]	Detector	Limit [dBµV/m]	Margin [dB]	Polarity	Angle[°]	Height[cm]
1	63.984	53.54	-19.11	34.43	PK	40.00	5.57	V	66	100
2	119.329	56.11	-17.88	38.23	PK	43.50	5.27	V	107	100
3	185.355	53.93	-18.05	35.88	PK	43.50	7.62	V	252	100
4	255.265	47.89	-15.17	32.72	PK	46.00	13.28	V	170	100
5	407.707	46.17	-11.78	34.39	PK	46.00	11.61	V	284	100
6	450.430	48.29	-11.13	37.16	PK	46.00	8.84	V	266	100

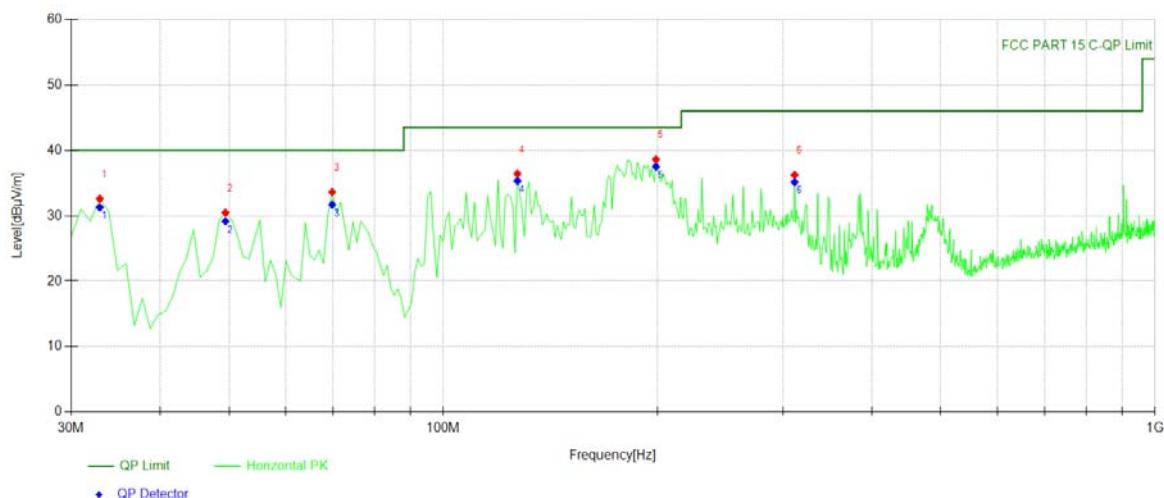

Suspected Data List

NO.	Freq. [MHz]	Reading [dBµV]	Factor [dB/m]	Level [dBµV/m]	Detector	Limit [dBµV/m]	Margin [dB]	Polarity	Angle[°]	Height [cm]
1	32.9129	50.91	-18.35	32.56	PK	40.00	7.44	H	86	100
2	49.4194	47.70	-17.25	30.45	PK	40.00	9.55	H	340	100
3	69.8098	53.56	-19.94	33.62	PK	40.00	6.38	H	313	100
4	127.097	55.11	-18.69	36.42	PK	43.50	7.08	H	90	100
5	198.948	55.81	-17.20	38.61	PK	43.50	4.89	H	263	100
6	311.581	50.38	-14.15	36.23	PK	46.00	9.77	H	276	100

8.6 CONDUCTED EMISSIONS TEST

8.6.1 Applicable Standard

According to FCC Part 15.207(a)

8.6.2 Conformance Limit

Frequency(MHz)	Conducted Emission Limit	
	Quasi-peak	Average
0.15-0.5	66-56	56-46
0.5-5.0	56	46
5.0-30.0	60	50

Note: 1. The lower limit shall apply at the transition frequencies
2. The limit decreases in line with the logarithm of the frequency in the range of 0.15 to 0.50MHz.

8.6.3 Test Configuration

Test according to clause 7.3 conducted emission test setup

8.6.4 Test Procedure

The EUT was placed on a table which is 0.8m above ground plane.
Maximum procedure was performed on the highest emissions to ensure EUT compliance.
Repeat above procedures until all frequency measured were complete.

8.6.5 Test Results

Pass

The 120V &240V voltage have been tested, and the worst result recorded was report as below:

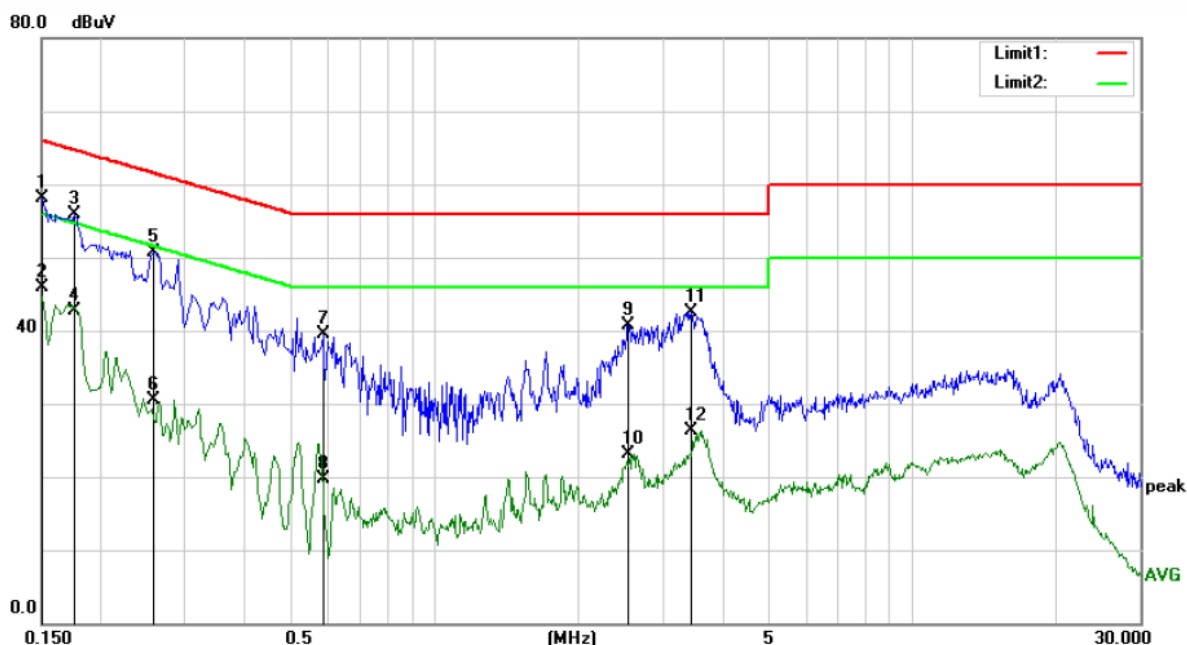

Site Conduction #1

Phase: **N**

Temperature: 22.4

Limit: (CE)FCC PART 15 class B_QP

Power: AC 120V/60Hz

Humidity: 55 %

Mode: SRD 2.4G mode

Note:

No.	Mk.	Freq. MHz	Reading Level dBuV	Correct Factor dB	Measure- ment dBuV	Limit dBuV	Over dB	Detector	Comment
1	*	0.1500	48.58	9.53	58.11	66.00	-7.89	QP	
2		0.1500	36.33	9.53	45.86	56.00	-10.14	AVG	
3		0.1758	46.33	9.53	55.86	64.68	-8.82	QP	
4		0.1758	33.14	9.53	42.67	54.68	-12.01	AVG	
5		0.2575	41.24	9.53	50.77	61.51	-10.74	QP	
6		0.2575	20.94	9.53	30.47	51.51	-21.04	AVG	
7		0.5850	29.92	9.53	39.45	56.00	-16.55	QP	
8		0.5850	10.27	9.53	19.80	46.00	-26.20	AVG	
9		2.5450	31.15	9.55	40.70	56.00	-15.30	QP	
10		2.5450	13.54	9.55	23.09	46.00	-22.91	AVG	
11		3.4450	32.85	9.56	42.41	56.00	-13.59	QP	
12		3.4450	16.76	9.56	26.32	46.00	-19.68	AVG	

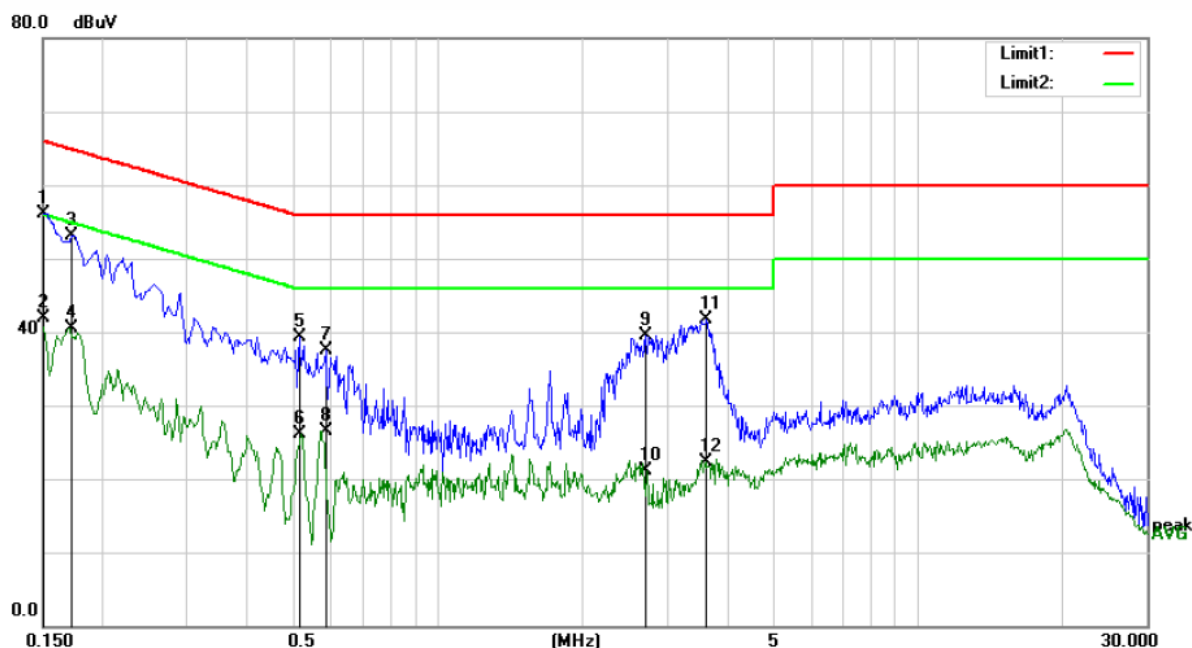

Site Conduction #1

Phase: **L1**

Temperature: 22.4

Limit: (CE)FCC PART 15 class B_QP

Power: AC 120V/60Hz

Humidity: 55 %

Mode: SRD 2.4G mode

Note:

No.	Mk.	Freq.	Reading Level	Correct Factor	Measurement	Limit	Over	Detector	Comment
		MHz	dBuV	dB	dBuV	dBuV	dB		
1	*	0.1500	46.58	9.53	56.11	66.00	-9.89	QP	
2		0.1500	32.33	9.53	41.86	56.00	-14.14	AVG	
3		0.1720	43.67	9.53	53.20	64.86	-11.66	QP	
4		0.1720	30.92	9.53	40.45	54.86	-14.41	AVG	
5		0.5150	29.75	9.53	39.28	56.00	-16.72	QP	
6		0.5150	16.59	9.53	26.12	46.00	-19.88	AVG	
7		0.5850	27.92	9.53	37.45	56.00	-18.55	QP	
8		0.5850	16.95	9.53	26.48	46.00	-19.52	AVG	
9		2.7150	29.93	9.56	39.49	56.00	-16.51	QP	
10		2.7150	11.48	9.56	21.04	46.00	-24.96	AVG	
11		3.6300	32.09	9.56	41.65	56.00	-14.35	QP	
12		3.6300	12.84	9.56	22.40	46.00	-23.60	AVG	

8.7 ANTENNA APPLICATION

8.7.1 Antenna Requirement

Standard	Requirement
FCC CRF Part 15.203	An intentional radiator shall be designed to ensure that no antenna other than that furnished by the responsible party shall be used with the device. The use of a permanently attached antenna or of an antenna that uses a unique coupling to the intentional radiator shall be considered sufficient to comply with the provisions of this section. The manufacturer may design the unit so that a broken antenna can be replaced by the user, but the use of a standard antenna jack or electrical connector is prohibited. This requirement does not apply to carrier current devices or to devices operated under the provisions of §15.211, §15.213, §15.217, §15.219, or §15.221. Further, this requirement does not apply to intentional radiators that must be professionally installed, such as perimeter protection systems and some field disturbance sensors, or to other intentional radiators which, in accordance with §15.31(d), must be measured at the installation site. However, the installer shall be responsible for ensuring that the proper antenna is employed so that the limits in this part are not exceeded.

For intentional device, according to FCC 47 CFR Section 15.203, an intentional radiator shall be designed to ensure that no antenna other than that furnished by the responsible party shall be used with the device. And according to FCC 47 CFR Section 15.247 (b), if transmitting antennas of directional gain greater than 6dBi are used, the power shall be reduced by the amount in dB that the directional gain of the antenna exceeds 6dBi.

8.7.2 Result

PASS.

- Antenna use a permanently attached antenna which is not replaceable.
- Not using a standard antenna jack or electrical connector for antenna replacement
- The antenna has to be professionally installed (please provide method of installation)

Note: which in accordance to section 15.203, please refer to the internal photos.

Detail of factor for radiated emission

Frequency(MHz)	Ant F(dB)	Cab L(dB)	Preamp(dB)	Correct Factor(dB)
0.009	20.6	0.03	\	20.63
0.15	20.7	0.1	\	20.8
1	20.9	0.15	\	21.05
10	20.1	0.28	\	20.38
30	18.8	0.45	\	19.25
30	11.7	0.62	27.9	-15.58
100	12.5	1.02	27.8	-14.28
300	12.9	1.91	27.5	-12.69
600	19.2	2.92	27	-4.88
800	21.1	3.54	26.6	-1.96
1000	22.3	4.17	26.2	0.27
1000	25.6	1.76	41.4	-14.04
3000	28.9	3.27	43.2	-11.03
5000	31.1	4.2	44.6	-9.3
8000	36.2	5.95	44.7	-2.55
10000	38.4	6.3	43.9	0.8
12000	38.5	7.14	42.3	3.34
15000	40.2	8.15	41.4	6.95
18000	45.4	9.02	41.3	13.12
18000	37.9	1.81	47.9	-8.19
21000	37.9	1.95	48.7	-8.85
25000	39.3	2.01	42.8	-1.49
28000	39.6	2.16	46.0	-4.24
31000	41.2	2.24	44.5	-1.06
34000	41.5	2.29	46.6	-2.81
37000	43.8	2.30	46.4	-0.3
40000	43.2	2.50	42.2	3.5

--- End of Report ---