

Instruction Manual

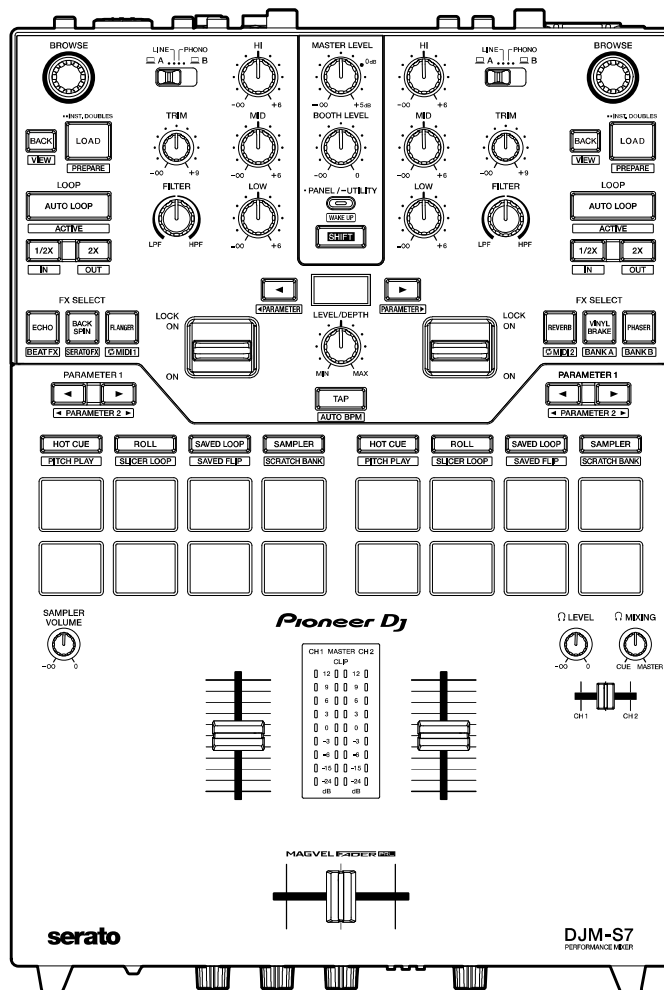

DJ Mixer

DJM-S7

pioneerdj.com/support/

rekordbox.com

<https://serato.com/>

For FAQs and other support information for this product, visit the websites above.

Pioneer Dj

serato

Contents

Before you start	5
How to read this manual	5
What's in the box.....	6
User guides	6
DJ software	7
Serato DJ Pro.....	7
rekordbox	8
Part names	9
Top panel	9
Front panel.....	10
Rear panel.....	11
PC/Mac setup	13
Dedicated software	13
Setting Utility	15
Connections	22
Connecting to the input terminals.....	22
Connecting to the output terminals	23
Connecting to the CDJ/controller terminals.....	24
DVS	25
Connections	25
Settings in Serato DJ Pro.....	27
Playback	30
Browse section	30
Adding a track to the library	31
Loading a track to the unit.....	31
Playing a track.....	32

Audio output	33
Channel section/master section	33
Outputting sound	35
Adjusting the sound	36
Setting the faders	36
Monitoring sound	39
Headphones section	39
Monitoring with headphones	39
Booth section	40
Using a booth monitor	40
Microphone	41
MIC section	41
Using a microphone	42
AUX	43
AUX section	43
Using AUX	43
Bluetooth	44
Bluetooth section	44
Connecting with a Bluetooth device	45
Using a Bluetooth device	45
Filter	46
Filter section	46
Using a filter or an effect	46
Effect types and settings	47
Beat FX/software FX	49
FX section	49
Using Beat FX/software FX	50
Beat FX types and settings	51
FX SELECT button mode switching	57

Using Loop MIDI	58
Using FX Bank	60
Using FX Trigger mode	63
Loop	64
Loop section	64
Using a loop	65
Using the Performance Pads	66
Performance Pad section	66
Serato DJ Pro	68
rekordbox	82
User mode	89
Using User modes	89
Fader Start	91
Using Fader Start	91
Settings	93
Changing the settings	93
Utility settings	94
Specifications	97
Block diagram	100
Additional information	102
Troubleshooting	102
Trademarks and registered trademarks	102
Software license notice	103
Cautions on copyrights	104

Before you start

How to read this manual

- Thank you for choosing this Pioneer DJ product.

Be sure to read this manual, the “Quick Start Guide” and the “Precautions for Use” which are also included with this product. These documents include important information that you should understand before using the unit. In particular, be sure to read the IMPORTANT SAFETY INSTRUCTIONS.

- In this manual the names of buttons, knobs and terminals that appear on the product, and the names of buttons, menus etc. in the software on your PC/Mac or mobile device, are indicated within square brackets ([]). (e.g. [File], [CUE] button)
- Please note that the software screens and their specifications, as well as the external appearance and specifications of the hardware, ~~were still under development at the time this manual was created and may differ from the final specifications.~~
- Please note that depending on the operating system version, web browser settings, etc. operation may differ from the ways described in this manual.
- Please note that the language on the screens of the software described in this manual may differ from the language on your screen.

申し送り

What's in the box

- Power cord
- USB cable^{*1}
- Warranty (for some regions)^{*2}
- Quick Start Guide
- Precautions for Use
- Serato DJ Pro Expansion Pack voucher^{*3}

*1 One USB cable is included with the unit. To connect two devices to the unit, use an additional cable that conforms to USB 2.0 standards.

*2 Only products in Europe.

Products in North America and Japan include warranty information in the "Precautions for Use".

*3 The voucher code needed to activate the expansion pack can't be reissued. Keep it in a safe place to be sure you don't lose it.

User guides

❖ Serato DJ Pro software manual

Refer to the following Serato DJ site.

<https://serato.com/dj/pro/downloads>

❖ rekordbox Introduction, Instruction Manual

Refer to the "rekordbox Introduction" to find out how to set up rekordbox, and see the "Instruction Manual" to find out how to use rekordbox.

Visit the URL below to find these user guides.

rekordbox.com/manual

DJ software

You can DJ with this unit by connecting it to a PC/Mac running Serato DJ Pro or rekordbox.

Serato DJ Pro

Serato DJ Pro is DJ software from Serato and compatible with DVS (page 25).

The Serato DJ Pro software is not included with the unit. Download the software from the URL below.

<https://serato.com/>

- For the latest system requirements, compatibility, and supported operating systems, visit the URL below.

<https://serato.com/dj/pro/downloads>

- Operation is not guaranteed on all PC/Mac models, even if the system requirements are met.
- Your PC/Mac may not provide sufficient processing capabilities for the CPU and hard disk, depending on its power-saving settings and some other conditions. For laptops in particular, use the High Performance setting, e.g. keep the AC power connected when using Serato DJ Pro.

rekordbox

rekordbox is a professional DJ application for music management and performing.

The rekordbox software is not included with the unit. Download the software from the URL below.

rekordbox.com/system

- The unit is automatically recognized when you launch rekordbox, and the following functions will be available.
 - Performance mode (the DJ functions in rekordbox)
 - DVS (digital vinyl system), which controls decks using the signals from compatible multi players, or from turntables when using the dedicated control vinyl.
- For the latest system requirements, compatibility, and supported operating systems, visit the URL below.

rekordbox.com/system

- Operation is not guaranteed on all PC/Mac models, even if the system requirements are met.
- Your PC/Mac may not provide sufficient processing capabilities for the CPU and hard disk, depending on its power-saving settings and some other conditions. For laptops in particular, use the High Performance setting, e.g. keep the AC power connected when using rekordbox.

Part names

Top panel

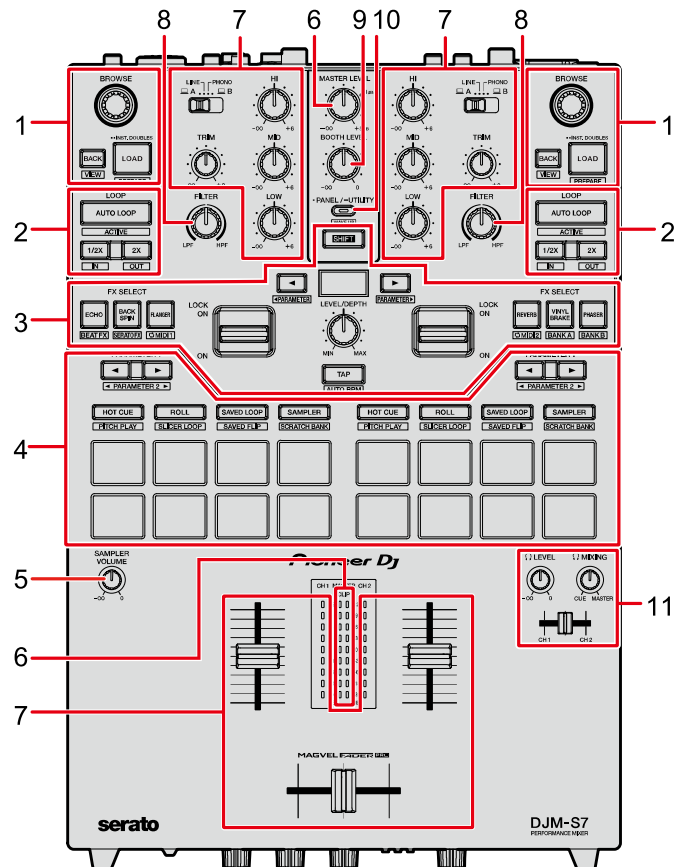

1. **Browse section** (page 30)
2. **Loop section** (page 64)
3. **FX section** (page 49)
4. **Performance Pad section** (page 66)
5. **Sampler Volume knob** (pages 71, 85)
6. **Master section** (page 33)
7. **Channel section** (page 33)
8. **Filter section** (page 46)
9. **Booth section** (page 40)

10. **PANEL/UTILITY button** (page 93)

11. **Headphones section** (page 39)

Front panel

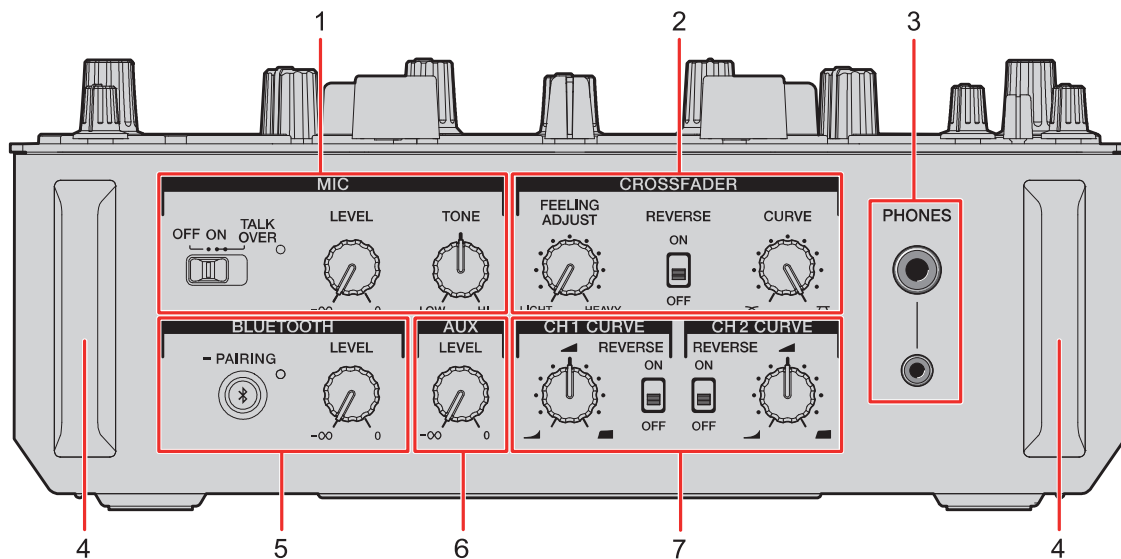

1. **MIC section** (page 41)

2. **Crossfader section** (page 37)

3. **PHONES terminals** (page 39)

4. **Front guard**

Protects the terminals and knobs on the front panel.

- Do not stand the unit on the guards as if they're feet, or it may tip over.

5. **Bluetooth section** (page 44)

6. **AUX section** (page 43)

7. **Channel curve section** (page 36)

Rear panel

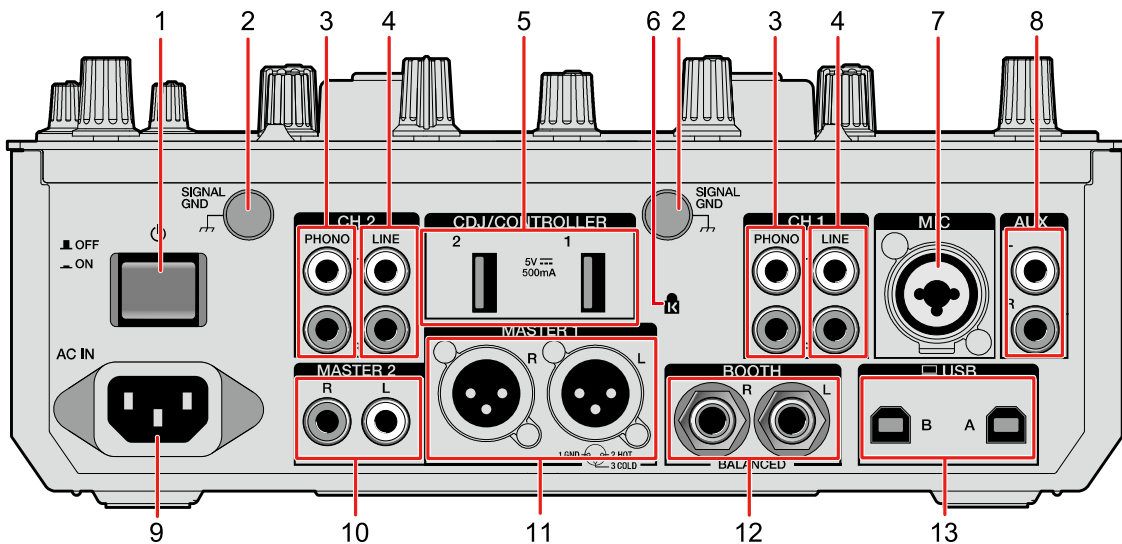

1. **⏻ button**

Turns the unit on and off.

2. **Signal GND terminal** (page 22)

Connect a turntable's ground wire.

Reduces unwanted noises that occur when a turntable is connected to the unit.

3. **PHONO terminals (RCA)** (page 22)

Connect phono-level (MM cartridge) output devices.

- Do not input line-level signals to the terminals.

4. **LINE terminals (RCA)** (page 22)

Connect multi players or line-level output devices.

5. **CDJ/CONTROLLER terminals** (page 24)

Connect compatible multi players or controllers.

- Do not connect storage devices (e.g. USB drives/hard disks, etc.) to the [CDJ/CONTROLLER] terminals.

Note that, if you turn the input selector switches, devices are forcibly disconnected from any PC/Mac connected to the unit and data on the devices may break.

6. **Kensington security slot**

Connect a cable lock.

Part names

7. **MIC terminal (XLR or 1/4"/6.35 mm, TRS)** (page 22)
8. **AUX terminals** (page 22)
Connect a line-level input device.
9. **AC IN** (page 22)
Connect to a power outlet with the supplied power cord.
10. **MASTER 2 terminals (RCA)** (page 23)
Connect to analog input terminals on a power amplifier, etc.
11. **MASTER 1 terminals (balanced XLR)** (page 23)
Connect to analog input terminals on a power amplifier, etc.
 - Use the terminals for balanced output only.
 - Do not connect a power cord from another product to the terminals.
 - Do not connect to a terminal that can supply phantom power.
12. **BOOTH terminals (1/4"/6.35 mm, TRS)** (page 23)
Connect a booth monitor.
 - Use the terminals for balanced output only.
13. **USB ports** (page 22)
Connect a PC/Mac.

PC/Mac setup

Dedicated software

To input or output your PC/Mac's audio to/from the unit, install the dedicated audio driver software and/or Setting Utility on your computer.

If you install the audio driver software to your PC (Windows), Setting Utility will also be installed with the driver software.

If you use a Mac, install Setting Utility only.

- For the latest system requirements, compatibility, and supported operating systems, visit the URL below.

pioneerdj.com/support/

- Operation is not guaranteed on all PC/Mac models, even if the system requirements are met.
- Operation is not guaranteed when multiple units are connected to a PC/Mac.
- If a PC (Windows) without the audio driver software installed is connected to the unit, errors may occur on the PC.
- Malfunctions may occur due to incompatibility with other software installed on a PC/Mac.

Installation

❖ Notes on installation

- Turn the unit off and disconnect the USB cable connected to the unit and the PC/Mac before installation.
- Close all applications running on the PC (Windows) before installation.
- You will need admin rights to install the audio driver software to your PC (Windows).
- Read the License Agreement terms carefully before installation.
- If you quit the installation halfway through, perform the installation procedure from the beginning again.

Downloading the dedicated software

Download the dedicated audio driver software/Setting Utility to your PC/Mac from the URL below.

pioneerdj.com/support/

Installing the dedicated software

1 Double-click the downloaded installation file.

2 Read the License Agreement terms carefully.

If you agree to the terms, mark the [Agree] check box and click [OK].

- If you do not agree to the License Agreement terms, click [Disagree] (for Mac)/ [Cancel] (for Windows) to cancel the installation.

3 Follow the on-screen instructions to complete the installation.

Setting Utility

You can check and set connections between the unit and a PC/Mac using the Setting Utility installed on the PC/Mac.

Launching Setting Utility

1 Click [Pioneer] > [DJM-S7 Setting Utility] from the applications list on a PC/Mac.

Setting Utility launches.

- You can also launch it from [PC UTILITY] in the Utility menu (page 95).

Checking the status of the input selector switches on the unit

1 Click the [MIXER INPUT] tab.

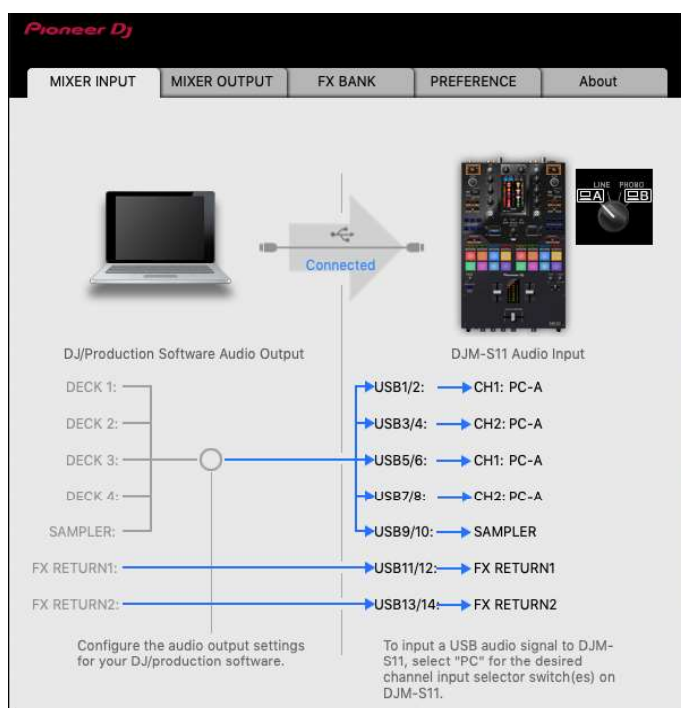

Setting the audio data output from the unit to a PC/Mac

- 1 Click the [MIXER OUTPUT] tab.
- 2 Click the pull-down list under [DJM-S7 Audio Output] and select the audio data output from the unit to the PC/Mac.

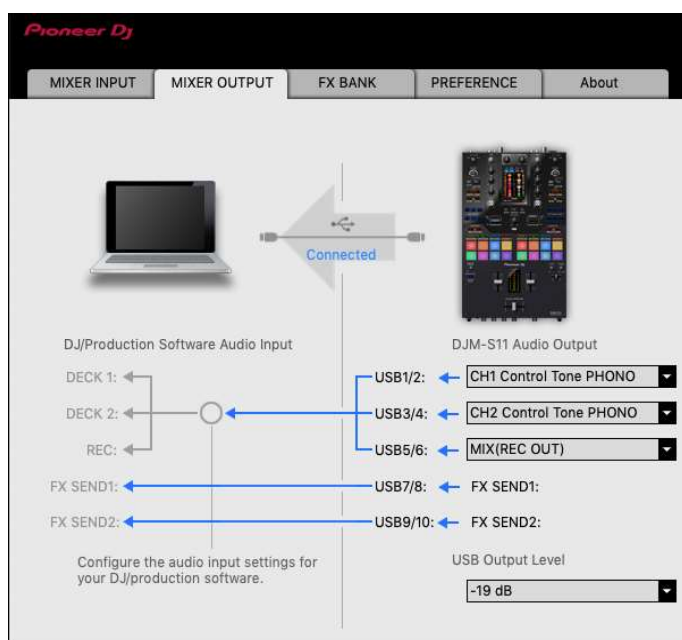

➡ [Read more: Audio Output pull-down list \(page 21\)](#)

- 3 Click the pull-down list under [USB Output Level] and select a level of volume to output from the unit.

- Set the volume in [USB Output Level] when you can't produce as much volume as you expect using the volume adjustment in your DJ application. Note that the sound may be distorted if you set the volume too high.

Adjusting the buffer size (for Windows ASIO)

- Close any running applications (DJ applications, etc.) which use the unit as the default audio device before adjusting the buffer size.

1 Click the [ASIO] tab.

2 Adjust the buffer size with the slider.

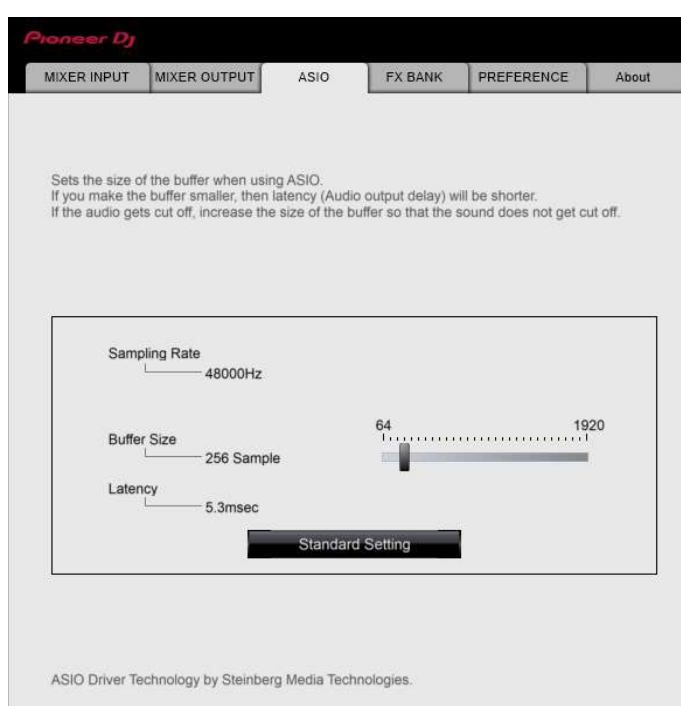

- Breaks in sound are less likely to occur if you set a large buffer size, but this increases lag time due to the latency of audio data transmission.

Changing the assignment of the FX

You can change the FX assigned to the **[FX SELECT]** button and the **[FILTER]** knob on the unit.

You can register the settings to **[BANK A]** or **[BANK B]**, and call up the settings when you need to.

➡ Read more: [Setting an FX Bank \(page 61\)](#)

Changing the settings

1 Click the **[PREFERENCE]** tab.

2 Change the settings.

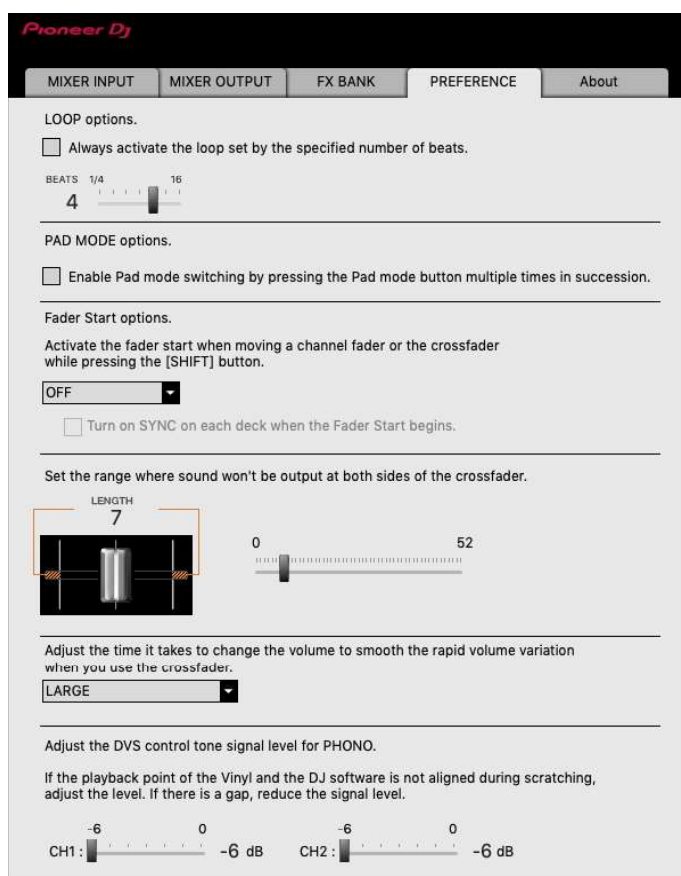

Setting items	Description
<u>LOOP options.</u> ¹	<p>Mark the check box to activate the loop length set by the slider.</p> <p>Clear the check box to set the [AUTO LOOP] button on the unit to work as the Auto Beat Loop button.</p>
<u>PAD MODE options.</u>	<p>Mark the check box to enable Pad mode switching by pressing a Pad mode button twice, three, or four times in succession.</p> <ul style="list-style-type: none"> When two computers (PC/Mac) are connected to the unit and the input selector switches for CH 1 and CH 2 are set to the different computers, this setting will be valid when it's enabled on each PC/Mac.
<u>Fader Start options.</u>	<p>To enable the Fader Start function, select [ON] from the pull-down list and mark the check box.</p> <p> Read more: Using Fader Start (page 91)</p>
<u>Set the range where sound won't be output at both sides of the crossfader.</u>	<p>Use the slider to set the range where sound will not be output at the both ends of the crossfader.</p> <ul style="list-style-type: none"> When two computers (PC/Mac) are connected to the unit and the input selector switches for CH 1 and CH 2 are set to [LINE] or [PHONO], this setting is invalid (the default setting is applied).
<u>Adjust the time it takes to change the volume to smooth the rapid volume variation when you use the crossfader.</u>	<p>Adjusts the time it takes to change the volume to smooth the rapid variation in the volume when you use the crossfader.</p> <ul style="list-style-type: none"> When two computers (PC/Mac) are connected to the unit, [NONE] is automatically applied in the following cases. <ul style="list-style-type: none"> The input selector switches for CH 1 and CH 2 are set to different computers (PC/Mac). The input selector switches for CH 1 and CH 2 are set to [LINE] or [PHONO].

Setting items	Description
<u>Adjust the DVS control tone signal level for PHONO.</u>	<u>Reduces the signal level if the playback points of the control vinyl and DJ software deviate while scratching.</u>

Checking the firmware and software versions

1 Click the [About] tab.

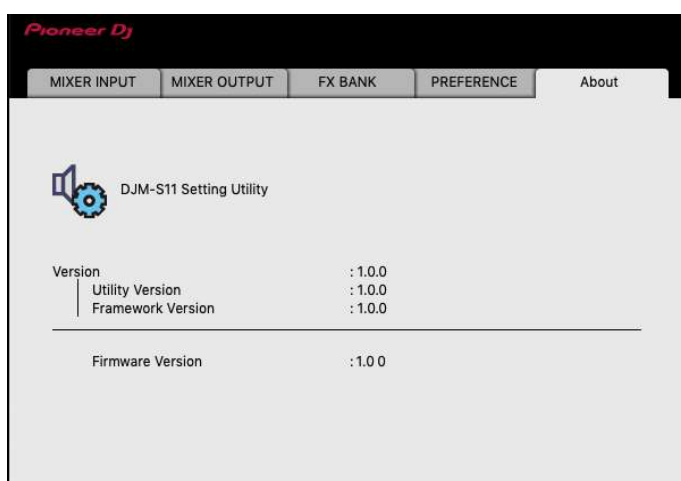

Audio Output pull-down list

- CH4 (USB 7/8), CH 5 (USB 9/10) is fixed to **[FX SEND]**.

#: indicates channel number

CH 1 (USB 1/2), CH 2 (USB 3/4)	CH 3 (USB 5/6)
<u>CH# Control Tone PHONO</u> ¹	<u>MIX(REC OUT)</u> ^{2,4}
<u>CH# Control Tone LINE</u> ¹	<u>CROSSFADER A</u> ^{2,3}
<u>Post CH# Fader</u> ²	<u>CROSSFADER B</u> ^{2,3}
<u>CROSSFADER A</u> ^{2,3}	<u>MIC</u>
<u>CROSSFADER B</u> ^{2,3}	<u>AUX</u>
<u>MIC</u>	<u>Post CH1 Fader</u> ²
<u>AUX</u>	<u>Post CH2 Fader</u> ²

¹ Available for software applications that support the function. Outputs sound at the volume input to the unit regardless of the **[USB Output Level]** setting.

² For uses other than recording, be sure to set the DJ application so that no sound loop occurs. Sound may be input or output at an unintended volume level when a sound loop occurs.

³ The sound applied with the **[ECHO]**, **[DUCKING ECHO]**, **[ECHO OUT]**, **[SPIRAL]**, or **[DELAY]** effect is output from **[CROSSFADER A]** or **[CROSSFADER B]**.

⁴ The sound applied with the **[REVERB]** effect is output from **[MIX(REC OUT)]**.

Connections

Turn the unit off and disconnect the power cord before connecting other units.

Connect the power cord after all the connections are complete.

- Use the supplied power cord.
- Read the instruction manuals for the devices you are going to connect with the unit.

Connecting to the input terminals

- When you use DVS (digital vinyl system) with the unit and Serato DJ Pro or rekordbox, make sure your PC/Mac is correctly connected to the input terminals on the unit and the input selector switch is correctly set.

Read the instruction manual for the software.

➡ Read more: DVS (page 25)

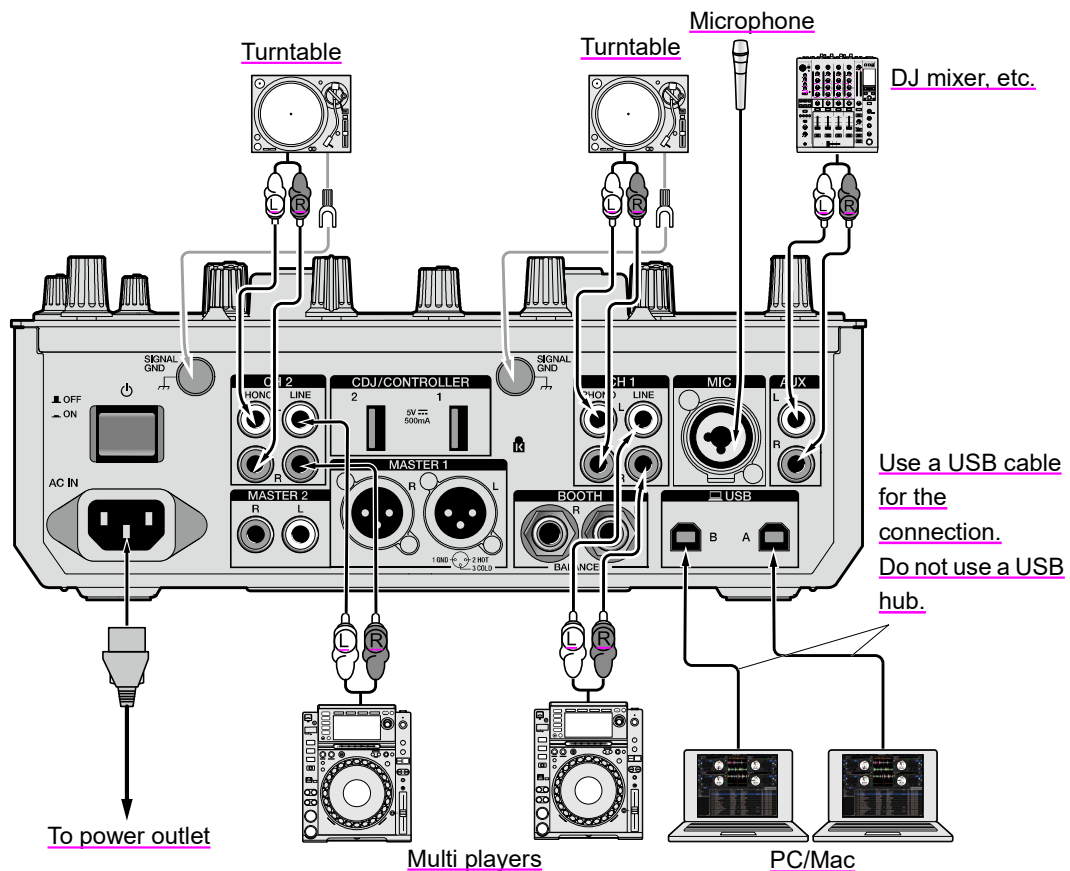

Connecting to the output terminals

Rear panel of the unit

Front panel of the unit

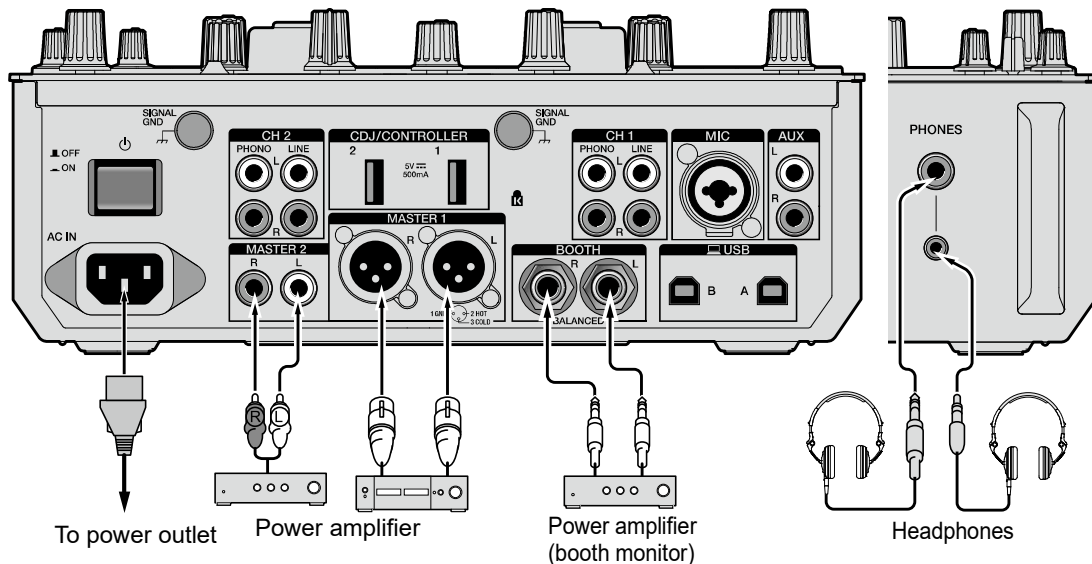

- Use the **[MASTER 1]** terminals for balanced output. Connecting the terminals to unbalanced inputs (RCA, etc.) with an XLR-RCA conversion cable (conversion adapter), etc. results in unwanted noises and/or poor sound quality.
- Use the **[MASTER 2]** terminals for unbalanced input (RCA, etc.).
- Use the **[BOOTH]** terminals for balanced output. Connecting the terminals to unbalanced inputs results in unwanted noises and/or poor sound quality.
- Do not connect a power cord from another product or a terminal that can supply phantom power to the **[MASTER 1]** terminals.

Connecting to the CDJ/controller terminals

You can control DJ software from a multi player if you connect the multi player to the **[CDJ/CONTROLLER]** terminals on the unit.

Be sure to read the instruction manual for the software.

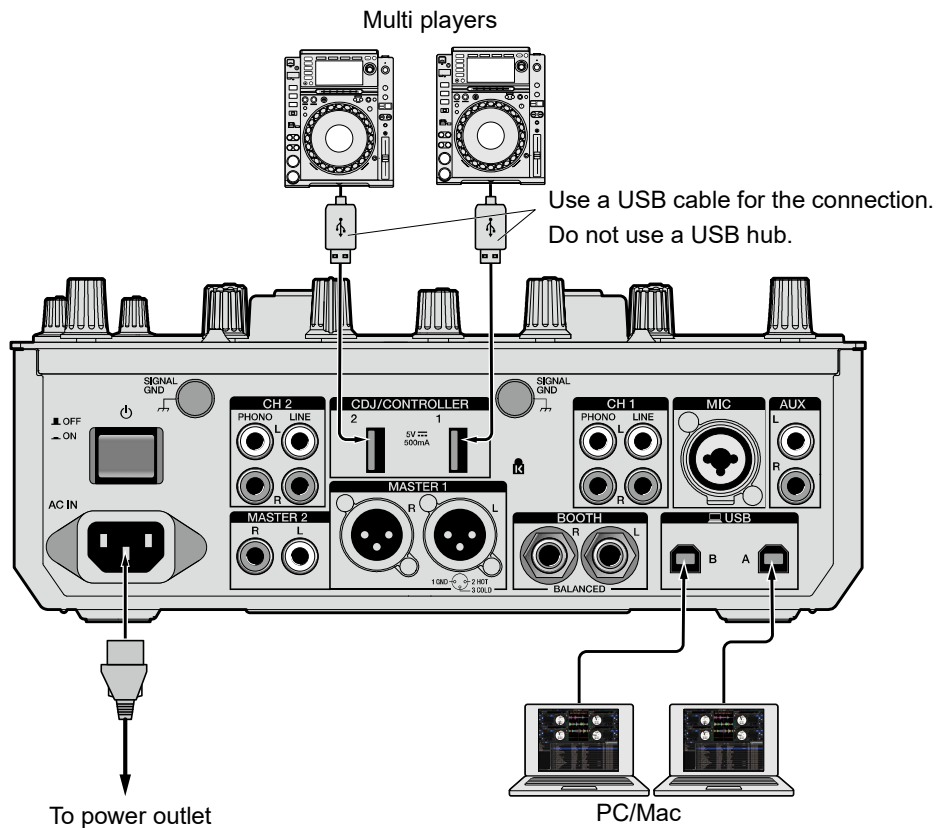

- Do not connect storage devices (e.g. USB drives/hard disks, etc.) to the **[CDJ/CONTROLLER]** terminals.

Note that, if you turn the input selector switches, devices are forcibly disconnected from any PC/Mac connected to the unit and data on the devices may break.

DVS

If you use the unit with DJ software (Serato DJ Pro or rekordbox) and a control disc (special vinyl or CDs with specific control signals), you can control digital music files using a turntable or multi player.

- Control discs aren't included with this unit. You'll need to buy them separately.
- You can download the control signals from the Serato DJ Pro or rekordbox website. Save them to a USB storage device to use them with this unit.
- When you use DVS with rekordbox, refer to the rekordbox dvs Setup Guide, available at the URL below.

rekordbox.com/manual

Connections

Using turntables

This section describes an example of how to connect [DECK 1] and [DECK 2] of DJ software with turntables.

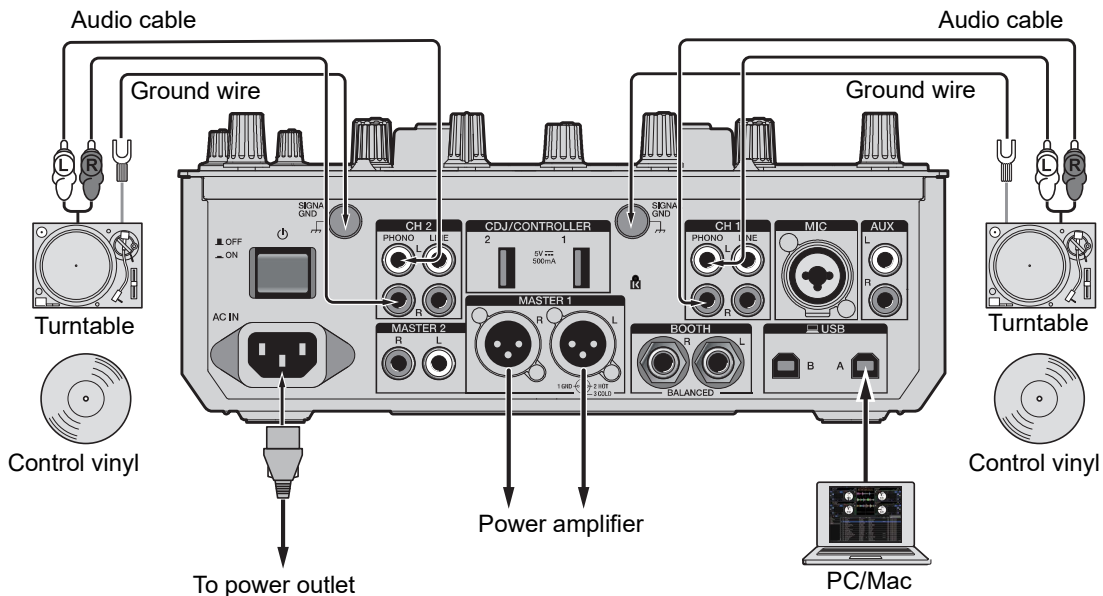



- 1 Connect a turntable you want to control [DECK 1] to the [PHONO] terminals for [CH 1], and a turntable you want to control [DECK 2] to the [PHONO] terminals for [CH 2].
- 2 Connect the turntable ground wires to the [SIGNAL GND] terminals on the unit.
- 3 Place control vinyl on the turntables.
- 4 Set the input selector switches of [CH 1] and [CH 2] on the unit to [A/B] (use [A] for the example above).

Using multi players

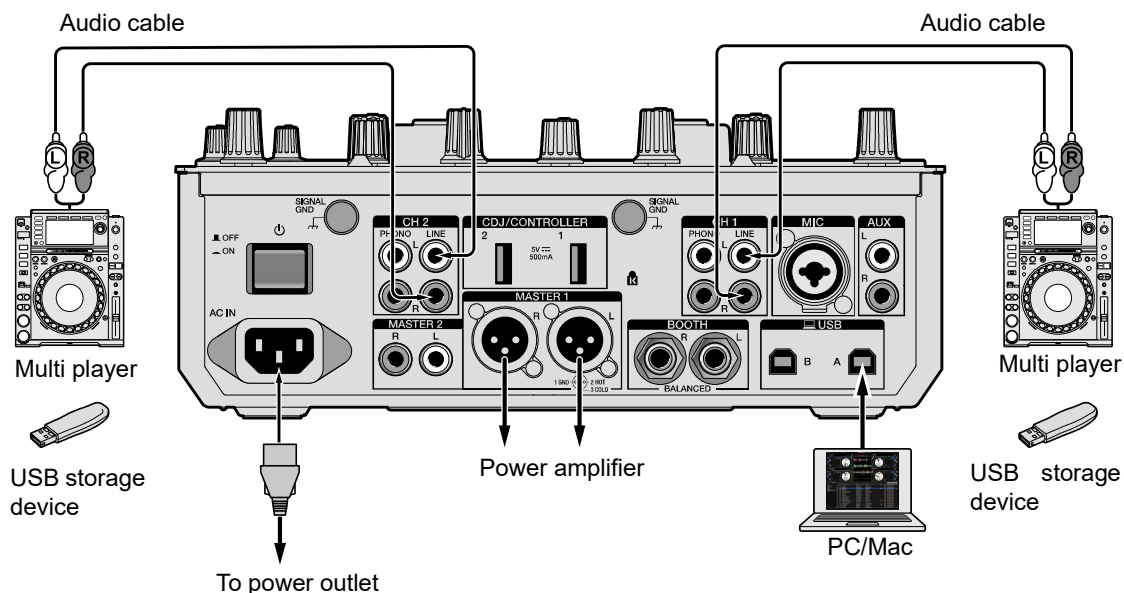
This section describes an example of how to connect [DECK 1] and [DECK 2] of DJ software with multi players.



- 1 Connect a multi player you want to control [DECK 1] to the [LINE] terminals for [CH 1], and a multi player you want to control [DECK 2] to the [LINE] terminals for [CH 2].

- 2 Take USB storage devices which have the control signals saved and connect them to the multi players. Then start playback.
- 3 Set the input selector switches of [CH 1] and [CH 2] on the unit to [ A/B] (use [ A] for the example above).

Settings in Serato DJ Pro

SETUP screen

The SETUP screen of Serato DJ Pro is displayed as shown below when the unit is connected (the illustration shows when the unit is connected to a PC/Mac for the first time after the driver software/Setting Utility is installed).

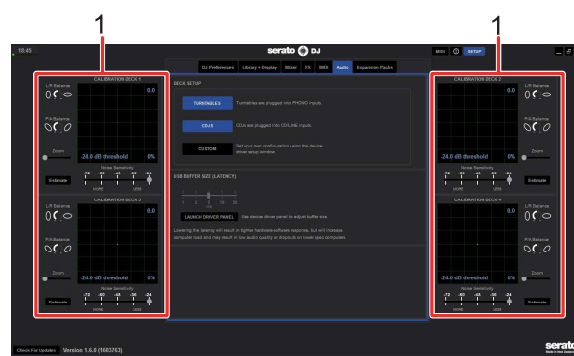

1. **CALIBRATION DECK:** Serato DJ Pro calculates analog signals from a control disc and processes the signals for digital audio files. It calculates signal levels and device statuses for each operating environment and sets up optimal settings for reading the control signals.
If the CALIBRATION DECKS are not displayed, click the [Expansion Packs] tab, select [Vinyl/CDJ Control] from the list, and mark the check box of [Enable Vinyl/CDJ control].

Setting up Serato DJ Pro

- 1 Click [SETUP] on the Serato DJ Pro screen.
- 2 Select [TURNTABLES] or [CDJS] on the [Audio] tab of the SETUP screen.



Checking control signals

- 1 Start playback of track 1 on the connected turntable or multi player.

Green rings appear on [CALIBRATION DECK].

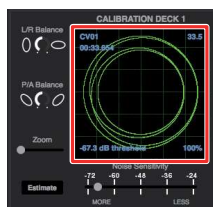

- Check if the innermost ring is almost a perfect circle. For details, refer to the Serato DJ Pro software manual (page 6).

Selecting a playback mode

Serato DJ Pro supports three playback modes ([\[ABS\]](#), [\[REL\]](#), and [\[INT\]](#)).

- [For details on the playback modes, refer to the Serato DJ Pro software manual \(page 6\).](#)

1 Select [ABS], [REL], or [INT] from the pull-down list on the deck pane.

When [\[ABS\]](#) is selected:



Playback

Browse section

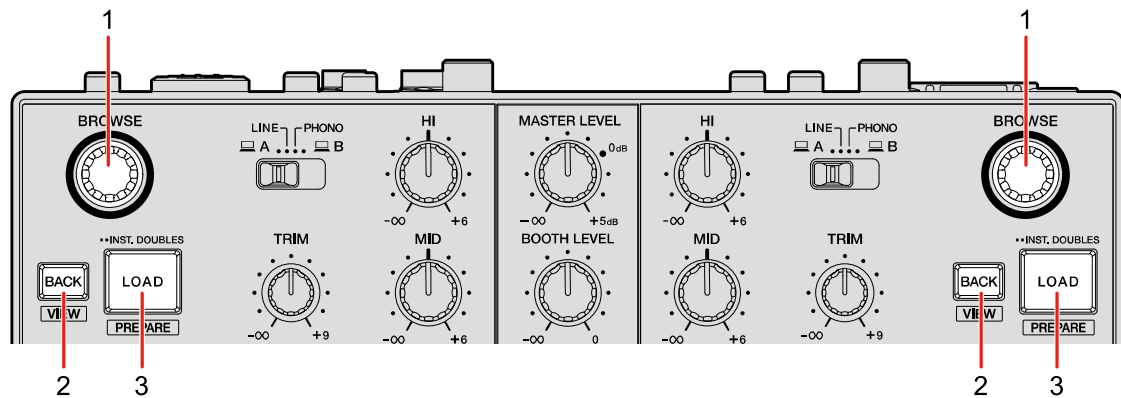

1. **BROWSE knob**

Turn to move the cursor up or down.

Press to move the cursor between the crates pane and library pane on the Serato DJ Pro screen. The cursor moves to the next level down on the **[Files]** pane, and to the next category on the **[Browse]** pane.

2. **BACK button**

Moves the cursor between the crates pane and library pane on the Serato DJ Pro screen. Displays or hides a subcrate when a subcrate is available for the item selected on the crates pane. The cursor moves to the next level up on the **[Files]** pane, and to the previous category on the **[Browse]** pane.

Press while also pressing the **[SHIFT]** button to switch the layout of the Serato DJ Pro screen.

3. **LOAD button**

Loads a selected track to the unit.

Press twice to load a track that's loaded to another deck on which you're pressing the **[LOAD]** button. Playback starts from the same position if you press twice while playing a track and pressing the button on the other deck (Instant Doubles).

Press while pressing the **[SHIFT]** button to load a track to the **[Prepare]** pane.

Adding a track to the library

Add a track to the library on the Serato DJ Pro screen.

1 Click [Files] on the Serato DJ Pro screen.

Files and folders stored on the PC/Mac or devices connected to the PC/Mac are displayed in the [Files] pane.

2 Click a folder that contains a file you want to add to the library on the [Files] pane.

The folder is selected.

3 Drag and drop the folder to the crates pane.

A crate is created and the tracks are added to the library.

Loading a track to the unit

1 Press the [BROWSE] knob to move the cursor to the crates pane on the Serato DJ Pro screen.

2 Turn the [BROWSE] knob to select a crate, etc.

3 Press the [BROWSE] knob.

The cursor moves to the library pane.

- You can also use the [BACK] button to move the cursor between the crates pane and library pane.

4 Turn the [BROWSE] knob to select a track.

5 Press the [LOAD] button for the deck you want to use.

The selected track is loaded to the relevant deck.

Playing a track

- 1 Use the connected multi player, turntable, or DJ controller to start playback of a track.

Audio output

Follow the procedures below to output and adjust sound.

- [Outputting sound \(page 35\)](#)
- [Adjusting the sound \(page 36\)](#)
- [Setting the faders \(page 36\)](#)

➡ To output sound to the **[BOOTH]** terminals, see [Using a booth monitor \(page 40\)](#).

Channel section/master section

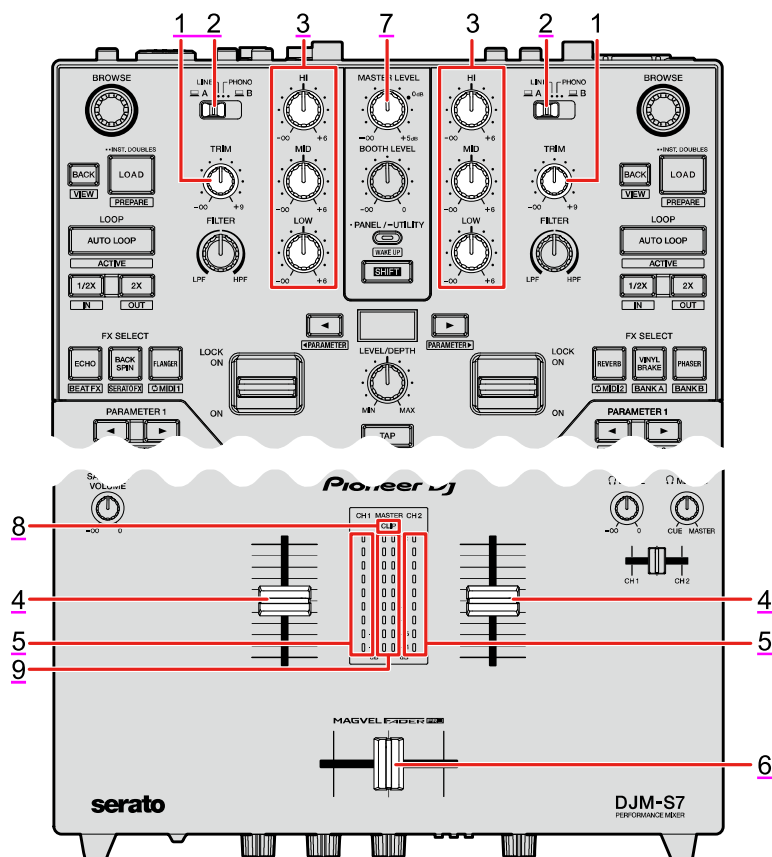

❖ [Channel section](#)

1. [TRIM knob](#)

[Adjusts the volume for the channel input sound.](#)

Audio output

2. Input selector switch

Selects an input sound source.

- [ A,B]: Selects a PC/Mac connected to one of the [USB] ports.
- [LINE]: Selects a multi player, etc. connected to the [LINE] terminals.
- [PHONO]: Selects a turntable connected to the [PHONO] terminals.

3. HI, MID, LOW knobs

Adjusts the volume of each frequency band.

Each knob adjusts in the following range.

- [HI]: -∞ dB to +6 dB (ISO)
- [MID]: -∞ dB to +6 dB (ISO)
- [LOW]: -∞ dB to +6 dB (ISO)

4. Channel fader

Adjusts the volume for the channel output sound according to the channel fader curve set with the [CH 1 CURVE] or [CH 2 CURVE] knob (page 36). Moving it up increases the volume, and down decreases the volume.

Slide up from the bottom position while pressing the [SHIFT] button to trigger Channel Fader Start (page 91).

5. Channel level indicator

Displays the volume level before the sound passes through the channel fader.

6. Crossfader

Adjusts the volume balance between the channel output sounds according to the crossfader curve specified with the [CROSSFADER CURVE] knob (page 37). Moving it to the CH 1 side outputs the sound of CH 1, and to the CH 2 side outputs the sound of CH 2.

Slide from either end to the other side while pressing the [SHIFT] button to trigger Crossfader Start (page 92).

❖ Master section

7. MASTER LEVEL knob

Adjusts the volume for the master sound.

8. CLIP indicator

Blinks when excessive volume is output from the [MASTER 1] or [MASTER 2] terminals.

9. **Master level indicator**

Displays the volume level of the master sound output to the [MASTER 1] and [MASTER 2] terminals.

Outputting sound

Adjusting the channel input volume

1 Slide the input selector switch to select an input sound source.

2 Turn the [TRIM] knob to adjust the volume for the input sound.

The channel level indicator lights up when sound is input to the channel.

Adjusting the channel output volume

1 Move the channel fader to adjust the volume for the output sound.

2 Move the crossfader to adjust the volume balance of the two channels.

Adjusting the master sound volume

1 Turn the [MASTER LEVEL] knob to adjust the volume for the master sound.

The master level indicator lights up when the master sound is output.

Adjusting the sound

- 1 Turn the [HI], [MID], and [LOW] knobs to adjust the volume of each band.

Setting the faders

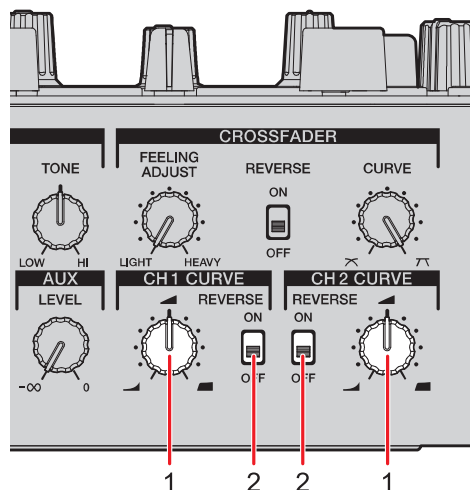

Set the channel fader and crossfader.

Channel curve section



1. CH 1/2 CURVE knob

Sets the channel fader curve.

-  : Steeply raises the volume when the channel fader is moved close to the top position.
-  : Gradually raises the volume as the channel fader is moved up.
-  : Steeply raises the volume as the channel fader is moved from the bottom position.

2. REVERSE switch

Turns the channel fader reverse function on and off.

Setting the channel fader

1 Turn the [CH 1/2 CURVE] knob to set the channel fader curve.

- Set the [REVERSE] switch to [ON] to reverse the operating direction of the channel fader.

Crossfader section

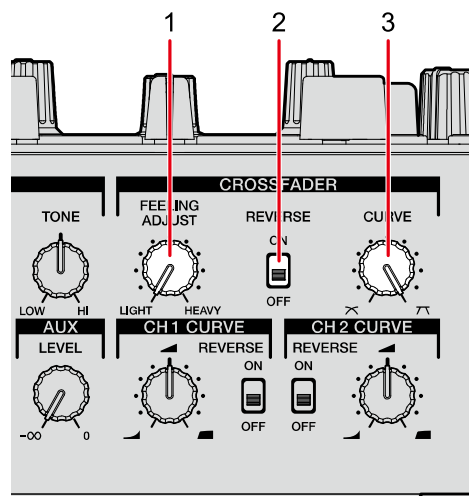

1. FEELING ADJUST knob



Adjusts the “weight” of the crossfader.

2. REVERSE switch

Turns the crossfader reverse function on and off.

3. CURVE knob

Sets the crossfader curve.

-  : Gradually raises the volume of the sound assigned to the other side as the crossfader is moved from one side (CH 1 or CH 2 side) to the other, and decreases the volume of the sound on the side it is moving away from.
-  : Steeply raises the volume of the sound assigned to the other side as the crossfader is moved from one side (CH 1 or CH 2 side) to the other.

Setting the crossfader

- 1 Turn the [CURVE] knob to set the crossfader curve.
 - 2 Turn the [FEELING ADJUST] knob to adjust the “weight” of the crossfader.
- Set the [REVERSE] switch to [ON] to reverse the operating direction of the crossfader.

Monitoring sound

Headphones section

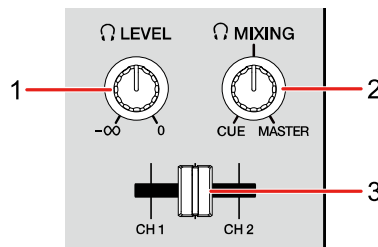

1.  **LEVEL knob**

Adjusts the volume for the sound output from the [PHONES] terminals.

2.  **MIXING knob**

Adjusts the volume balance between the master sound and the channel selected with the headphones cue fader.

- Set the knob to [CUE] to monitor only the channel sound, and to [MASTER] to monitor only the master sound.

3. **Headphones cue fader**

Adjusts the volume balance between the CH 1 sound and CH 2 sound output to the headphones.

Monitoring with headphones

1 Connect headphones to one of the [PHONES] terminals.

 Read more: [Connecting to the output terminals \(page 23\)](#)

2 Turn the [ MIXING] knob to adjust the volume balance between the channel sound and the master sound.

Monitoring sound

- 3 Move the headphones cue fader to adjust the volume balance between the CH 1 sound and the CH 2 sound.
- 4 Turn the [🎧 LEVEL] knob to adjust the volume.

Booth section

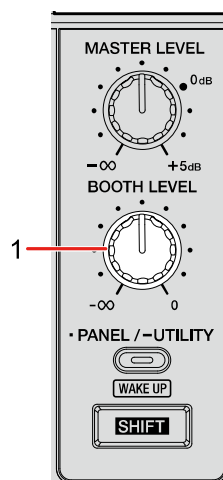

1. **BOOTH LEVEL knob**
Adjusts the volume for the sound output to a booth monitor.

Using a booth monitor

- 1 Connect a booth monitor to the [BOOTH] terminals.

🔗 Read more: [Connecting to the output terminals \(page 23\)](#)
- 2 Turn the [BOOTH LEVEL] knob to adjust the volume for the output sound.

Microphone

MIC section

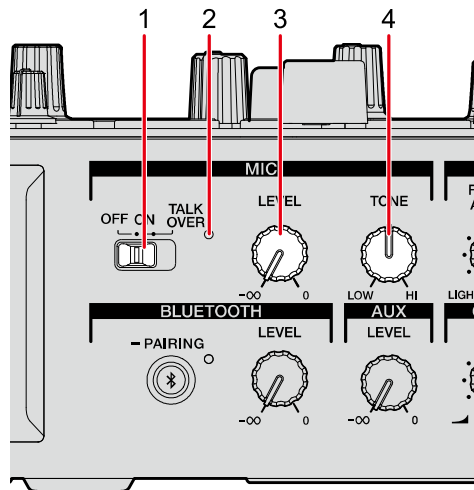

1. MIC switch

Turns the microphone on or off, or turns microphone talkover on.

2. MIC indicator

Indicates the microphone sound output as follows.

- Off: The microphone is off.
- Lights up: The microphone is on.
- Blinks: The microphone is on and the microphone talkover is applied.

3. LEVEL knob

Adjusts the volume of sound input from the **[MIC]** terminal.

4. TONE knob

Adjusts the volume of sound input from the **[MIC]** terminal.

You can adjust in the following range.

- Turn counterclockwise: High range (+0 dB to -12 dB)
- Turn clockwise: Low range (+0 dB to -12 dB)

Using a microphone

1 Connect a microphone to the [MIC] terminal.

➡ Read more: [Connecting to the input terminals \(page 22\)](#)

2 Set the MIC switch to [ON].

3 Turn the [LEVEL] knob to adjust the microphone volume level.

- Note that turning the knob too far clockwise outputs the sound at a high volume.

4 Turn the [TONE] knob to adjust the volume of each band.

5 Speak into the microphone.

AUX

AUX section

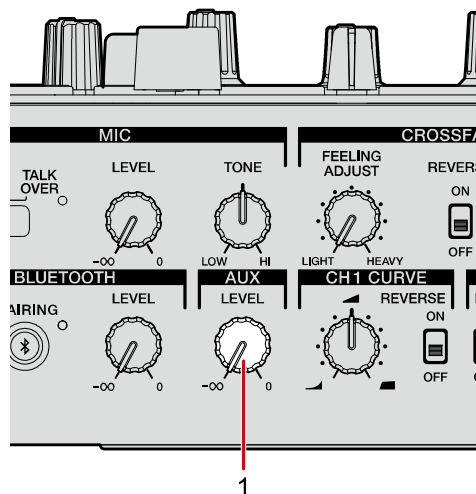

1. LEVEL knob

Adjusts the volume for the input sound from an external device.

Using AUX

1 Connect an external device to the [AUX] terminal.

➡ Read more: [Connecting to the input terminals \(page 22\)](#)

2 Turn the [LEVEL] knob to adjust the volume of the input sound.

Bluetooth

申し送り

Bluetooth section

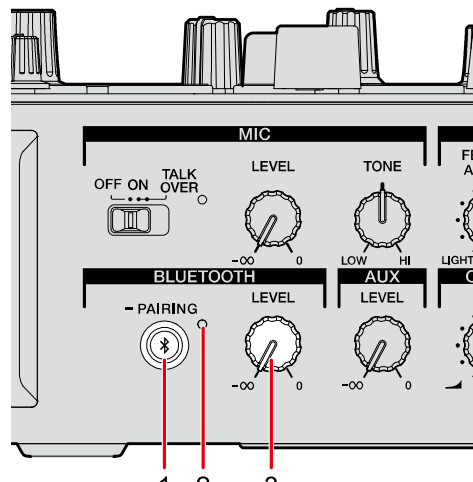

1. Bluetooth button

Pairs the unit with a Bluetooth device.

2. Bluetooth indicator

Indicates the connection status as follows.

- Blinks: The unit is waiting for pairing operation and connection.
- Lights up: The unit is connected with a Bluetooth device.

3. LEVEL knob

Adjusts the volume input via Bluetooth.

Connecting with a Bluetooth device

1 Turns the unit on.

 Read more: Rear panel (page 11)

2 Press and hold the Bluetooth button for approximately 2 seconds.

The unit enters pairing state.

- The Bluetooth indicator blinks while in pairing state (for approximately 120 seconds).

3 Perform pairing operation on a Bluetooth device.

The Bluetooth indicator on the unit stops blinking and lights up when the connection is established.

- For the pairing operation on the Bluetooth device, read the instruction manual for the device.
- Perform pairing operation on a Bluetooth device while the unit is in pairing state.
- If you use a Bluetooth device that has connected with the unit, you can connect the unit with the device by pressing the Bluetooth button briefly.
- The Bluetooth indicator turns off if the unit cannot pair with a Bluetooth device within 120 seconds.
- You can connect the unit with only one Bluetooth device at a time. If you connect the unit with other device than the connected one, the connection information will be overwritten with the one of the newly connected device.

Using a Bluetooth device

1 Connect the unit with a Bluetooth device.

2 Turn the [LEVEL] knob to adjust the volume for the input sound.

3 Output sound from the connected Bluetooth device.

Filter

You can apply a filter or an effect to the sound on any channel.

Filter section



1. FILTER knob

Adjusts a filter or an effect.

Using a filter or an effect

You can change an effect assigned to the [FILTER] knob. Choose an effect from the [FILTER] pull-down list on the [FX BANK] tab in Setting Utility (page 61).

Effect types and settings

You can adjust the following settings with the knob or from the [FX BANK] tab in Setting Utility.

<u>Effect/operation</u>	<u>Description</u>
<u>FILTER</u>	<u>Outputs filtered sound.</u>
• <u>FILTER:</u>	<u>Turn counterclockwise to lower the cut-off frequency of the low-pass filter.</u> <u>Turn clockwise to raise the cut-off frequency of the high-pass filter.</u>
• <u>Sub parameter:</u>	<u>Resonance</u>
<u>DUB ECHO</u>	<u>Adds reverberating echo by outputting the sounds slightly delayed from the original sound several times and attenuating them.</u>
• <u>FILTER:</u>	<u>Turn counterclockwise to add reverberating echo to the middle frequency range.</u> <u>Turn clockwise to add reverberating echo to the high frequency range.</u>
• <u>Sub parameter:</u>	<u>Feedback</u>
<u>NOISE</u>	<u>Outputs filtered white noise mixed with the sound of the channel.</u>
• <u>FILTER:</u>	<u>Turn counterclockwise to lower the cut-off frequency for the filter which passes white noise through.</u> <u>Turn clockwise to raise the cut-off frequency for the filter which passes white noise through.</u>
• <u>Sub parameter:</u>	<u>Volume of the noise.</u>

Effect/operation	Description
<u>PITCH</u>	<u>Changes the pitch.</u>
• <u>FILTER:</u>	<u>Turn counterclockwise to lower the pitch.</u> <u>Turn clockwise to raise the pitch.</u>
• <u>Sub parameter:</u>	<u>Pitch change range: ± 1 semitone to ± 2 octaves</u>
<u>WIDE FILTER</u>	<u>Outputs filtered sound.</u>
• <u>FILTER:</u>	<u>Turn counterclockwise to lower the cut-off frequency for the low-pass filter.</u> <u>Turn clockwise to raise the cut-off frequency for the high-pass filter.</u> <u>Turn all the way counterclockwise or clockwise to completely cut the sound.</u>
• <u>Sub parameter:</u>	<u>Resonance</u>

Beat FX/software FX

The unit includes 6 buttons for the effects. You can assign the internal effects (Beat FX) or DJ software effects (software FX, loop MIDI) to the buttons.

FX section

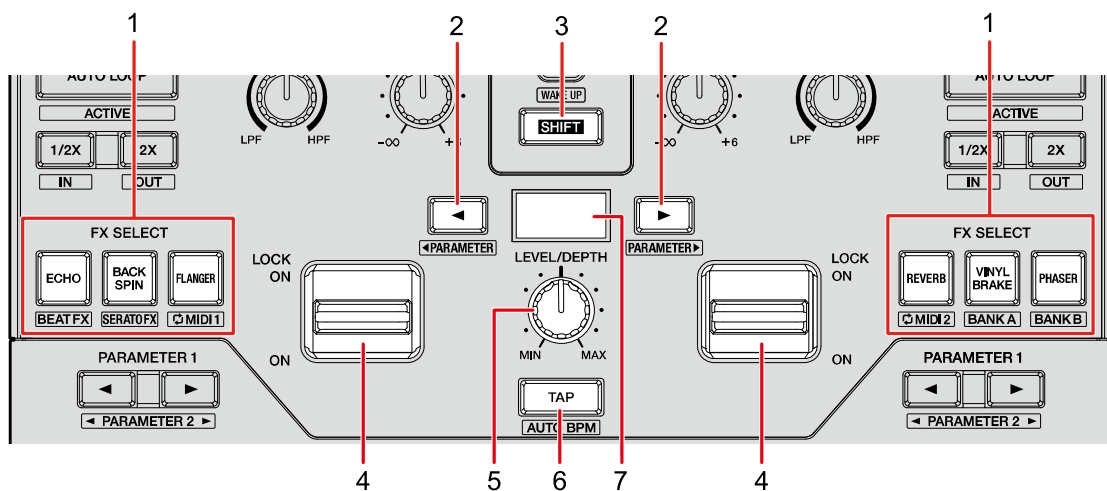

1. **FX SELECT buttons**

Selects the internal effects (Beat FX) or DJ software effects.

2. **BEAT ◀/▶ button**

Sets the number of beats for Beat FX.

3. **SHIFT button**

4. **Effect lever**

Applies an effect.

— **[ON]**: Applies an effect while you hold the effect lever in the **[ON]** position. Release the lever to return it to the center position and turn the effect off.

— **[LOCK ON]**: Continues applying an effect when you let go of the effect lever and leave it in the **[LOCK ON]** position. Return the effect lever to the center position to turn the effect off.

5. **LEVEL/DEPTH knob** (page 51)

Adjusts an effect.

6. TAP button

Sets BPM.

7. FX display

Using Beat FX/software FX

➔ Read more: Beat FX types and settings (page 51)

1 Press a [FX SELECT] button to which the effect you want to use is assigned.

- If you press multiple [FX SELECT] buttons with software FX assigned, you can use multiple software FX at the same time.
- You can use up to 6 effects at the same time by selecting an internal effect (one of the Beat FX) and multiple software FX (up to 5 effects).
- You can change effects assigned to the [FX SELECT] buttons (page 61).

2 Set BPM with the [TAP] button.

- Press the [TAP] button to manually set BPM.
- Press the [BEAT ◀] or [BEAT ▶] button while pressing the [TAP] button to adjust BPM in increments of 1.
- Press the [BEAT ◀] or [BEAT ▶] button while pressing the [TAP] and [SHIFT] buttons to adjust BPM in increments of 0.1.
- Press the [TAP] button while pressing the [SHIFT] button to automatically set BPM.

3 Press the [BEAT ◀] or [BEAT ▶] button to set a beat fraction to synchronize the effect with.

4 Turn the [LEVEL/DEPTH] knob to adjust the effect.

- Turn the knob all the way counterclockwise to output the original sound.

5 Set the effect lever to [ON] or [LOCK ON].

The selected effect is applied to the sound of the channel on which you're using the effect lever.

Beat FX types and settings

You can adjust the following settings with the buttons and knob or from the [FX BANK] tab in Setting Utility.

Beat FX/operation	Description
ECHO ⓘ <ul style="list-style-type: none"> • BEAT ◀▶: Delay time with respect to 1 beat of the BPM (beat fraction): 1/32 to 16 beats • LEVEL/DEPTH: Balance between the original sound and the effected sound, and feedback • Sub parameter: Cut-off frequency for HPF: 1 to 9 	<u>Outputs a delay sound several times while attenuating it according to the beat.</u>
DUCKING ECHO ⓘ <ul style="list-style-type: none"> • BEAT ◀▶: Delay time with respect to 1 beat of the BPM (beat fraction): 1/32 to 16 beats • LEVEL/DEPTH: Balance between the original sound and the effected sound, and feedback • Sub parameter: Cut-off frequency for HPF: 1 to 9 	<u>Outputs a delay sound several times while attenuating it when sound is muted by the crossfader or channel fader.</u>
ECHO OUT ⓘ <ul style="list-style-type: none"> • BEAT ◀▶: Delay time with respect to 1 beat of the BPM (beat fraction): 1/32 to 16 beats • LEVEL/DEPTH: Balance between the original sound and the effected sound, and feedback • Sub parameter: Cut-off frequency for HPF: 1 to 9 	<u>Mutes the input sound and outputs a delay sound several times while attenuating it.</u>

Beat FX/software FX

Beat FX/operation	Description
<u>SPIRAL</u> ¹	<u>Adds reverberation to the input sound.</u>
• <u>BEAT</u> ◀▶:	<u>Delay time with respect to 1 beat of the BPM (beat fraction): 1/16 to 16 beats</u>
• <u>LEVEL/DEPTH</u> :	<u>Balance between the original sound and the effected sound, and feedback</u>
• <u>Sub parameter</u> :	<u>Speed: 1 to 9</u>
<u>HELIX</u>	<u>Records the input sound and outputs the recorded sound repeatedly according to the specified beat fraction.</u>
• <u>BEAT</u> ◀▶:	<u>Effect time with respect to 1 beat of the BPM (beat fraction): 1/16 to 16 beats</u>
• <u>LEVEL/DEPTH</u> :	<u>Ratio of sound overlay</u> <u>• You can change the attenuation rate by turning the [LEVEL/DEPTH] knob all the way counterclockwise and then clockwise. Turn the knob all the way clockwise to fix the output sound.</u>
• <u>Sub parameter</u> :	<u>Speed: 1 to 9</u>
<u>DELAY</u> ¹	<u>Outputs a delay sound once according to the beat.</u>
• <u>BEAT</u> ◀▶:	<u>Delay time with respect to 1 beat of the BPM (beat fraction): 1/32 to 4 beats</u>
• <u>LEVEL/DEPTH</u> :	<u>Balance between the original sound and the effected sound</u>
• <u>Sub parameter</u> :	<u>Swing: 1 to 9</u>
<u>REVERB</u> ¹	<u>Adds reverberation to the input sound.</u>
• <u>BEAT</u> ◀▶:	<u>Reverberation level: 1 to 100%</u>
• <u>LEVEL/DEPTH</u> :	<u>Balance between the original sound and the effected sound</u>
• <u>Sub parameter</u> :	<u>Cut-off frequency for HPF: 1 to 9</u>

Beat FX/software FX

Beat FX/operation	Description
<u>BACK SPIN</u>	<u>Cyclically adds effect of fast reversing the input sound being played.</u>
• <u>BEAT</u> ◀▶:	<u>Cycle of the effect with respect to 1 beat of the BPM (beat fraction): 1/16 to 64 beats</u>
• <u>LEVEL/DEPTH</u> :	<u>Balance between the original sound and the effected sound, and playback speed</u>
• <u>Sub parameter</u> :	<u>Spin speed: 1 to 9</u>
<u>ONE-SHOT SPIN</u>	<u>Adds an effect of fast reversing the input sound being played.</u>
• <u>BEAT</u> ◀▶:	<u>Reverse playback time with respect to 1 beat of the BPM (beat fraction): 1/16 to 64 beats</u>
• <u>LEVEL/DEPTH</u> :	<u>Balance between the original sound and the effected sound, and playback speed</u>
• <u>Sub parameter</u> :	<u>Brake speed: 1 to 9</u>
<u>VINYL BRAKE</u>	<u>Cyclically slows down the playback speed of the input sound gradually according to the beat and then stops playback.</u>
• <u>BEAT</u> ◀▶:	<u>Cycle of the effect with respect to 1 beat of the BPM (beat fraction): 1/16 to 64 beats</u>
• <u>LEVEL/DEPTH</u> :	<u>Balance between the original sound and the effected sound, and playback speed</u>
• <u>Sub parameter</u> :	<u>Brake speed: 1 to 9</u>

Beat FX/software FX

Beat FX/operation	Description
<u>ONE-SHOT BRAKE</u>	<u>Slows down the playback speed for the input sound gradually and then stops playback.</u>
• <u>BEAT</u> ◀▶:	<u>Effect time with respect to 1 beat of the BPM (beat fraction): 1/16 to 64 beats</u>
• <u>LEVEL/DEPTH:</u>	<u>Balance between the original sound and the effected sound, and the playback speed</u>
• <u>Sub parameter:</u>	<u>Spin speed: 1 to 9</u>
<u>FLANGER</u>	<u>Adds a cyclic flanger effect according to the beat.</u>
• <u>BEAT</u> ◀▶:	<u>Moving cycle of the effect with respect to 1 beat of the BPM (beat fraction): 1/16 to 64 beats</u>
• <u>LEVEL/DEPTH:</u>	<u>Effect level</u>
• <u>Sub parameter:</u>	<u>Depth of flanger effect: 1 to 9</u>
<u>PHASER</u>	<u>Adds a cyclic phaser effect according to the beat.</u>
• <u>BEAT</u> ◀▶:	<u>Moving cycle of the effect with respect to 1 beat of the BPM (beat fraction): 1/16 to 64 beats</u>
• <u>LEVEL/DEPTH:</u>	<u>Effect level</u>
• <u>Sub parameter:</u>	<u>Depth of phaser effect: 1 to 9</u>
<u>HP FILTER</u>	<u>Cyclically changes the cut-off frequency for the high-pass filter according to the beat.</u>
• <u>BEAT</u> ◀▶:	<u>Moving cycle of the effect with respect to 1 beat of the BPM (beat fraction): 1/16 to 64 beats</u>
• <u>LEVEL/DEPTH:</u>	<u>Effect level</u>
• <u>Sub parameter:</u>	<u>Cycle to finely fluctuate the effect: 1 to 9</u>

Beat FX/software FX

Beat FX/operation	Description
<u>LP FILTER</u>	<u>Cyclically changes the cut-off frequency for the low-pass filter according to the beat.</u>
• <u>BEAT ◀▶:</u>	<u>Moving cycle of the effect with respect to 1 beat of the BPM (beat fraction): 1/16 to 64 beats</u>
• <u>LEVEL/DEPTH:</u>	<u>Effect level</u>
• <u>Sub parameter:</u>	<u>Cycle to finely fluctuate the effect: 1 to 9</u>
<u>TRANS</u>	<u>Cyclically cuts the sound according to the beat.</u>
• <u>BEAT ◀▶:</u>	<u>Cycle of the cut with respect to 1 beat of the BPM (beat fraction): 1/16 to 16 beats</u>
• <u>LEVEL/DEPTH:</u>	<u>Balance between the original sound and the effected sound, and duty</u>
• <u>Sub parameter:</u>	<u>Duty: 1 to 9</u>
<u>KILL</u>	<u>Attenuates the input sound gradually and then mutes the sound.</u>
• <u>BEAT ◀▶:</u>	<u>Attenuation time with respect to 1 beat of the BPM (beat fraction): 1/32 to 64 beats</u>
• <u>LEVEL/DEPTH:</u>	<u>Balance between the original sound and the effected sound, and attenuation time</u>
	• <u>Turn the [LEVEL/DEPTH] knob all the way clockwise to attenuate the input sound gradually and then mutes the sound according to the attenuation time specified with the [BEAT ◀] or [BEAT ▶] button.</u>
• <u>Sub parameter:</u>	<u>Attenuation curve: 1 to 9</u>

Beat FX/software FX

Beat FX/operation	Description
ROLL	<u>Records the input sound when the effect is turned on, and outputs the recorded sound repeatedly according to the specified beat fraction.</u>
• BEAT ◀▶:	<u>Effect time with respect to 1 beat of the BPM (beat fraction): 1/16 to 16 beats</u>
• LEVEL/DEPTH:	<u>Balance between the original sound and the effected sound, and mute amount</u>
• Sub parameter:	<u>Mute amount: 1 to 9</u>
<hr/>	
FADER PITCH ²	<u>Changes the pitch of the input sound according to the operation of the channel fader.</u>
• BEAT ◀▶:	<u>Maximum pitch change (octave): -2, -1, +1, +2</u>
• LEVEL/DEPTH:	<u>Balance between the original sound and the effected sound</u>
• Sub parameter:	<u>Scale: 1 to 7 (LINEAR, CHROMATIC, MAJOR, MINOR, MAJOR P, MINOR P, 4STEP)</u>
<hr/>	
FADER SYNTH (SINE/SAW/SQUARE) ²	<u>Outputs the synth sound as the audio source of the base oscillation frequency.</u>
• BEAT ◀▶:	<u>Base oscillation frequency level: -3 to +3</u>
• LEVEL/DEPTH:	<u>Effect volume</u>
• Sub parameter:	<u>Scale: 1 to 9 (CHROMATIC, MAJOR, MINOR, MINOR H, JAPANESE, CHINESE, HAWAIIAN, RYUKYU, 2OCT ANALOG)</u>

¹ You cannot monitor the effected sound.

² You cannot adjust the volume with the channel fader when the effect is turned on.

FX SELECT button mode switching

If you press the **[FX SELECT]** button while pressing the **[SHIFT]** button, the mode switches as follows. Colors of the **[FX SELECT]** button and the LED of the effect lever change according to the mode.

FX SELECT button	Mode	LED color	Description
ECHO button	Beat FX mode	Blue	Uses the internal effects (Beat FX).
BACK SPIN button	Software FX mode	Light blue	Uses DJ software effects.
FLANGER button	Loop MIDI 1 mode	Green	Uses Loop MIDI 1.
REVERB button	Loop MIDI 2 mode	Yellow	Uses Loop MIDI 2.
VINYL BRAKE button	Bank A mode	Red	Calls up Bank A.
PHASER button	Bank B mode	Pink	Calls up Bank B.

- The **[FX SELECT]** button lights up in the mode color while pressing the **[SHIFT]** button.

Using Loop MIDI

You can use the effect lever to control loop operation of DJ software effects (loop playback start/stop of the sampler slot 1, etc.).

- For the DJ software effect assignments for loop operation, read the instruction manual for the software (page 6).

1 Press the [FX SELECT] button while pressing the [SHIFT] button to switch to Loop MIDI 1 or Loop MIDI 2 mode.

2 Press the [FX SELECT] button to which the effect you want to loop is assigned.

- You can select multiple effects if you press multiple [FX SELECT] buttons at the same time.

3 Set the effect lever to [ON] or [LOCK ON].

Loop operation of the selected DJ software effect starts.

- If you use the effect lever while pressing the [SHIFT] button, you can use different operations.

Function assigned to Loop MIDI differs depending on the DJ software. The default settings are as follows.

Serato DJ Pro

Mode	FX SELECT button	Effect lever set to [ON]	[SHIFT] pressed and effect lever set to [ON]
Loop MIDI 1	ECHO button	Plays sampler slot 1.	Stops sampler slot 1.
	BACK SPIN button	Plays sampler slot 2.	Stops sampler slot 2.
	FLANGER button	Plays sampler slot 3.	Stops sampler slot 3.
	REVERB button	Plays Hot Cue 1.	-
	VINYL BRAKE button	Plays Hot Cue 2.	-
	PHASER button	Plays Hot Cue 3.	-

Beat FX/software FX

Mode	FX SELECT button	Effect lever set to [ON]	[SHIFT] pressed and effect lever set to [ON]
Loop MIDI 2	ECHO button	Raises the key.	Resets the key.
	BACK SPIN button	Lowers the key.	Resets the key.
	FLANGER button	Uses Censor.	-
	REVERB button	Plays Hot Cue 1.	-
	VINYL BRAKE button	Plays sampler slot 1.	Stops sampler slot 1.
	PHASER button	Mutes.	-

rekordbox

Mode	FX SELECT button	Effect lever set to [ON]	[SHIFT] pressed and effect lever set to [ON]
Loop MIDI 1	ECHO button	Plays sampler slot 1.	Stops sampler slot 1.
	BACK SPIN button	Plays sampler slot 2.	Stops sampler slot 2.
	FLANGER button	Plays sampler slot 3.	Stops sampler slot 3.
	REVERB button	Plays Hot Cue A.	-
	VINYL BRAKE button	Plays Hot Cue B.	-
	PHASER button	Plays Hot Cue C.	-
Loop MIDI 2	ECHO button	Raises the key.	Resets the key.
	BACK SPIN button	Lowers the key.	Resets the key.
	FLANGER button	Uses Slip Reverse.	-
	REVERB button	Plays Hot Cue A.	-
	VINYL BRAKE button	Plays sampler slot 1.	Stops sampler slot 1.
	PHASER button	Mutes.	-

Using FX Bank

You can save effect settings assigned to the [FILTER] knob and the [FX SELECT] buttons to FX Banks, and load the FX Banks when you want to use them.

❖ Restrictions on operation

The following restrictions are applied when two computers (PC/Mac) are connected to the unit.

- You can't load an FX Bank.
- You can't change effects by turning the [BROWSE] knob while pressing the [FX SELECT] button.
- The Beat FX assigned to the buttons reset to the default settings (i.e. to the effects displayed on the [FX SELECT] buttons).

The restrictions are not applied in the following cases.

- Input selector switches of [CH 1] and [CH 2] are set to [A].
- Input selector switches of [CH 1] and [CH 2] are set to [B].

Setting an FX Bank

You can set up to two FX Banks using the Setting Utility.

➔ [Read more: Launching Setting Utility \(page 15\)](#)

1 Click the [FX BANK] tab.

2 Click [BANK A] or [BANK B] to select an FX Bank to save settings to.

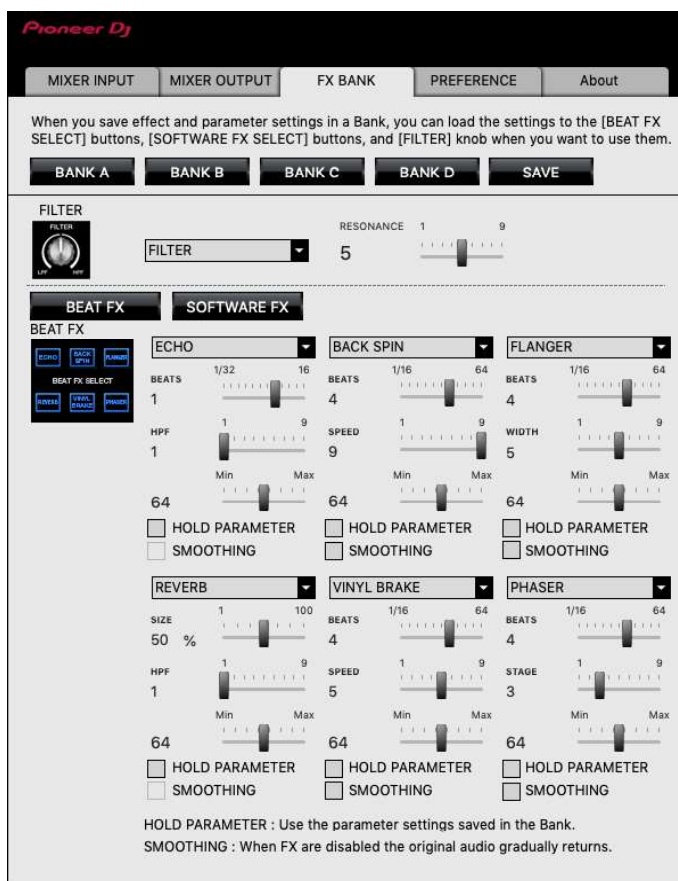

3 Select a filter or an effect to assign to the [FILTER] knob from the [FILTER] pull-down list.

➔ [Read more: Effect types and settings \(page 47\)](#)

4 Select an effect to assign to each button from the pull-down list.

➡ [Read more: Beat FX types and settings \(page 51\)](#)

5 Mark the check box of [SMOOTHING] as necessary.

— [\[SMOOTHING\]: Gradually returns to the original sound after the effect turns off.](#)

6 Click [SAVE].

[The setting is saved to the FX Bank.](#)

Changing an assigned effect

[You can change the effects assigned to the \[FX SELECT\] buttons using the following methods.](#)

- [Set from the pull-down lists in Setting Utility \(page 61\).](#)
- [Turn the \[BROWSE\] knob while pressing the \[FX SELECT\] button on the unit.](#)

Loading an FX Bank

[You can load an FX Bank using the buttons on the unit.](#)

1 Press the [VINYL BRAKE] or [PHASER] button while pressing the [SHIFT] button.

- [\[VINYL BRAKE\]: Loads bank A.](#)
- [\[PHASER\]: Loads bank B.](#)
- [If banks are set in DJ software, the settings are also loaded.](#)

Using FX Trigger mode

You can use FX Trigger mode to apply Beat FX using the Performance Pads even when a PC/Mac is not connected to the unit.

Parameter values are pre-assigned to the Performance Pads, so you can apply an effect only by pressing a Performance Pad.

- You can only use FX Trigger mode when one of the Beat FX is selected.

1 Set the input selector switch to [LINE] or [PHONO].

2 Press a Performance Pad.

The specified Beat FX is applied according to the number of beats assigned to the Performance Pad.

Example: When [ECHO] is selected

Performance Pad No.			
1	2	3	4
1/32 beats	1/16 beats	1/8 beats	1/4 beats
5	6	7	8
1/3 beats	1/2 beats	3/4 beat	1 beats

- Release the Performance Pad to turn off the effect.

Loop

You can choose a section of a track to play repeatedly.

Loop section

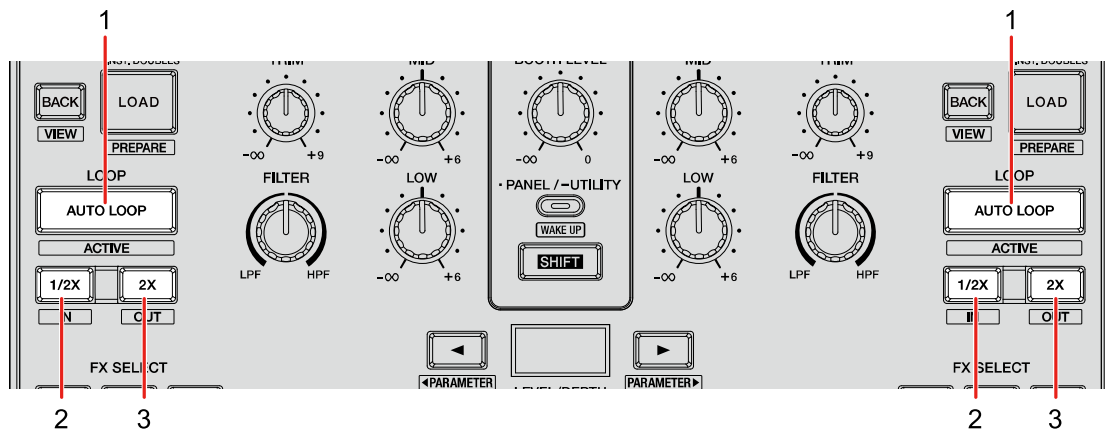

1. AUTO LOOP button

Plays a loop of the specified number of beats or Auto Beat Loop.

Press while pressing the [SHIFT] button to turn a loop on and off.

- You can choose whether the [AUTO LOOP] button starts a loop of the specified number of beats or Auto Beat Loop in [LOOP options.] ([PREFERENCE] tab) in Setting Utility (page 18).

2. 1/2X button

Halves the length of the loop.

3. 2X button

Doubles the length of the loop.

Using a loop

Setting a loop automatically

1 Press the [AUTO LOOP] button during playback.

Loop playback starts from the position where the button is pressed.

Setting a loop manually

1 Press the [SHIFT] and [1/2X] buttons at the point where you want to start the loop (loop-in point) during playback.

2 Press the [SHIFT] and [2X] buttons at the point where you want the loop to end (loop-out point).

Loop playback of the specified section starts.

Halving the length of a loop

1 Press the [1/2X] button during loop playback.

The loop length is halved each time you press the button.

Doubling the length of a loop

1 Press the [2X] button during loop playback.

The loop length is doubled each time you press the button.

Using the Performance Pads

You can trigger various functions with the Performance Pads when using the unit with DJ software.

Performance Pad section

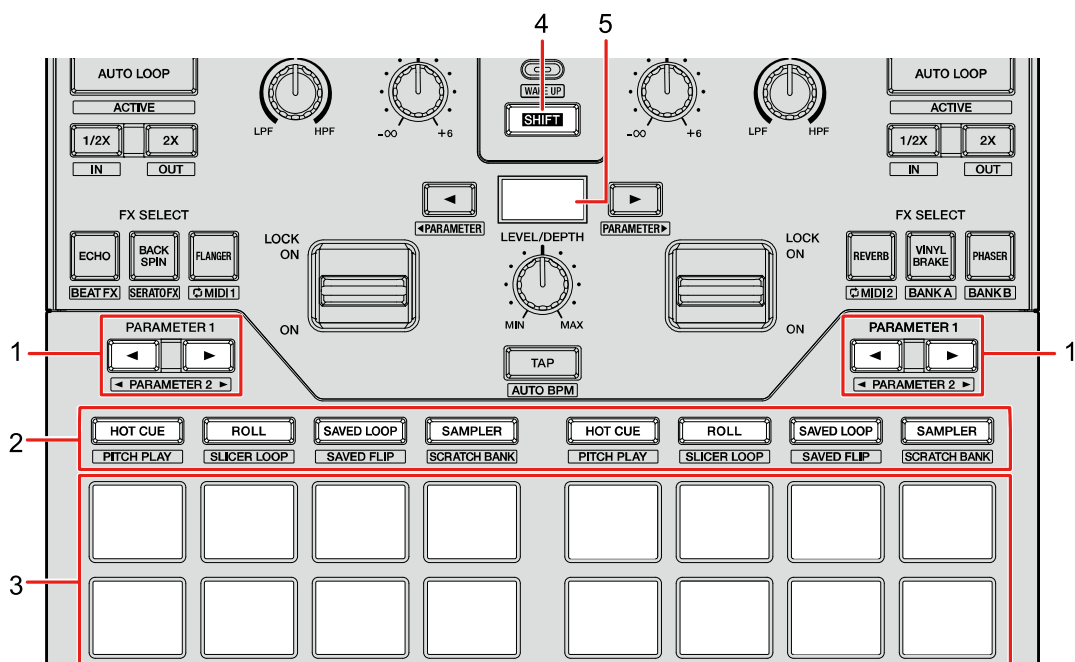

1. **PARAMETER** ◀▶ button

Switches settings.

2. **Pad mode buttons**

When using the unit with Serato DJ Pro:

<u>Operation</u>	<u>HOT CUE button</u>	<u>ROLL button</u>	<u>SAVED LOOP button</u>	<u>SAMPLER button</u>
Press	Hot Cue	Roll	Saved Loop	Sampler

Using the Performance Pads

Operation	HOT CUE button	ROLL button	SAVED LOOP button	SAMPLER button
Press while pressing the [SHIFT] button	Pitch Play	Slicer Loop	Saved Flip	Scratch Bank
Press twice	Gate Cue	Cue Loop	Auto Loop	Transport
Press twice while pressing the [SHIFT] button	User mode 1	User mode 2	User mode 3	User mode 4

When using the unit with rekordbox:

Operation	HOT CUE button	ROLL button	SAVED LOOP button	SAMPLER button
Press	Hot Cue	Pad FX1	Beat Jump	Sampler
Press while pressing the [SHIFT] button	Keyboard	Pad FX2	Beat Loop	Key Shift

3. [Performance Pads](#)

4. [SHIFT button](#)

Using the Performance Pads

Serato DJ Pro

Press the Pad mode button ([HOT CUE], [ROLL], [SAVED LOOP], or [SAMPLER]) to switch functions.

Combo Pad mode

If you press a Pad mode button while pressing another Pad mode button, you can use two Pad modes at the same time (the supported modes are Hot Cue, Roll, Saved Loop and Sampler modes).

The Pad mode of the button you press first is assigned to the top four Performance Pads and the Pad mode of the button you press next is assigned to the bottom four Performance Pads.

Hot Cue mode

You can call up a Hot Cue quickly and start playback by pressing a Performance Pad.

- You can set up to 8 Hot Cues per track.

1 Press the [HOT CUE] button.

The unit switches to Hot Cue mode.

2 Press a Performance Pad at the point where you want to set a Hot Cue during playback or pause.

A Hot Cue is set.

- Hot Cues are assigned to the Performance Pads as follows.

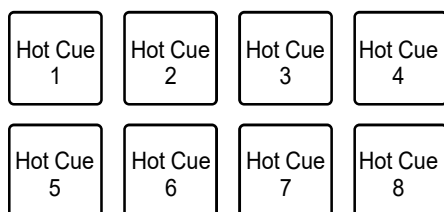

3 Press a Performance Pad to which a Hot Cue is set.

Playback starts from the Hot Cue point.

Using the Performance Pads

- Press a Performance Pad while pressing the [SHIFT] button to delete a Hot Cue set to the pad.

Roll mode

Loop Roll playback continues according to the number of beats assigned to a Performance Pad while you press the pad.

1 Press the [ROLL] button.

The unit switches to Roll mode.

2 Press the [PARAMETER ◀] or [PARAMETER ▶] button.

The numbers of beats assigned to the Performance Pads change as follows each time the button is pressed.

- 1/32 to 4 beats
- 1/16 to 8 beats
- 1/8 to 16 beats
- 1/4 to 32 beats

Example: When set to 1/8 to 16 beats, the numbers of beats are assigned to the Performance Pads as follows.

1/8	1/4	1/2	1
2	4	8	16

The numbers of beats are displayed on the Serato DJ Pro screen.



3 Press the Performance Pad assigned with the number of beats you want to play in a loop.

Using the Performance Pads

Loop Roll playback continues according to the number of beats assigned to the Performance Pad while you press the pad.

- Press the [1/2X] or [2X] button during Loop Roll playback to change the number of beats in the Loop Roll being played.
 - Normal playback continues with its original rhythm in the background during Loop Roll playback, but you can't hear this.
-
- Release the Performance Pad to end the Loop Roll playback. Normal playback starts from the exact point the track would have reached by now.

Saved Loop mode

You can save a loop to a loop slot in Serato DJ Pro and call up a saved loop.

1 Press the [SAVED LOOP] button.

The unit switches to Saved Loop mode.

2 Press a Performance Pad during loop playback.

Loops are assigned to the loop slots in Serato DJ Pro as follows.

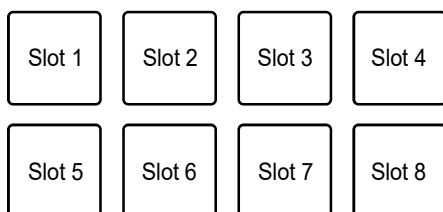

3 Press a Performance Pad to which a loop is assigned while pressing the [SHIFT] button.

Loop playback starts from the beginning of the loop.

- Press the [PARAMETER ◀] or [PARAMETER ▶] button during loop playback to change the length of the loop being played. The setting of the called-up loop is overwritten with the changed setting.
- Press the [1/2X] or [2X] button while pressing the [SHIFT] button during loop playback to move a loop without changing the loop length. The setting of the called-up loop is overwritten with the changed setting.

Using the Performance Pads

- Press the Performance Pad again to cancel loop playback.

Sampler mode

You can start playback of a track loaded in a Sampler slot using a Performance Pad.

1 Display the [SAMPLER] pane on the Serato DJ Pro screen.

2 Press the [SAMPLER] button on the unit.

The unit switches to Sampler mode.

3 Press the [PARAMETER ◀] or [PARAMETER ▶] button to switch Sampler Banks.

There are four banks (A, B, C, D) to switch between.

- Each bank has eight slots.

4 Drag and drop a track to each slot on the [SAMPLER] pane to load it on the Serato DJ Pro screen.

The Sampler settings and the loaded tracks are saved.

5 Press the Performance Pad matching the slot (track) you want to play.

Slot playback starts.

- Slots are assigned to the Performance Pads as follows.

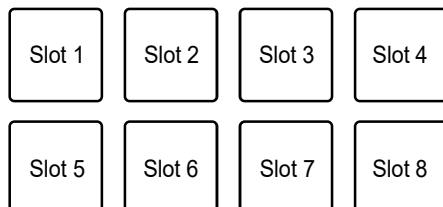

6 Turn the [SAMPLER VOLUME] knob to adjust the volume of the Sampler sound.

Using the Performance Pads

- Playback methods differ according to the Sampler mode set in Serato DJ Pro. For details, refer to the Serato DJ Pro software manual (page 6).
- Press the Performance Pad while pressing the [SHIFT] button to stop slot playback.

Pitch Play mode

Pitch Play is a function of Pitch 'n Time DJ.

1 Press the [HOT CUE] button while pressing the [SHIFT] button.

The unit switches to Pitch Play mode.

2 Press a Performance Pad while pressing the [SHIFT] button.

A Hot Cue assigned to the Performance Pad is selected.

3 Press a Performance Pad.

Playback starts from the selected Hot Cue point according to the pitch assigned to the Performance Pad.

- Press the [PARAMETER ◀] or [PARAMETER ▶] button during Pitch playback to change the pitch range. Each press switches between Up range, Middle range, and Down range.

— Up range:



Using the Performance Pads

— Middle range:

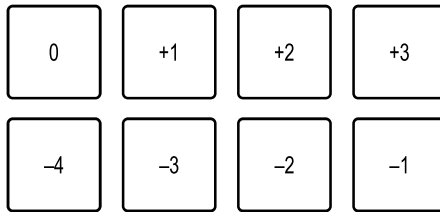

— Down range:

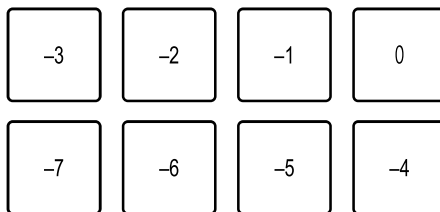

- Press the [PARAMETER ◀] or [PARAMETER ▶] button while pressing the [SHIFT] button to shift the pitch range by a semitone.

Slicer Loop mode

A specified range is applied to the track divided into eight sections. The divided sections are assigned to different Performance Pads.

Loop playback of the section assigned to a Performance Pad continues while you press the Performance Pad.



- You can't use Slicer Loop with a track that doesn't have beatgrid set. For details on how to set beatgrid, refer to the Serato DJ Pro software manual (page 6).

1 Press the [ROLL] button while pressing the [SHIFT] button.

The unit switches to Slicer Loop mode.

Using the Performance Pads

2 Press the [PARAMETER ◀] or [PARAMETER ▶] button while pressing the [SHIFT] button to specify the range (domain) to divide into eight sections.

- Each press of the button sets the domain as follows from the position where the button is pressed.
 - 2 beats
 - 4 beats
 - 8 beats
 - 16 beats
 - 32 beats
 - 64 beats
- Eight sections of a divided domain are assigned to the Performance Pads as follows.

Sections 1 to 8:

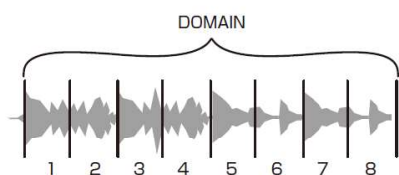

Performance Pads assignment:

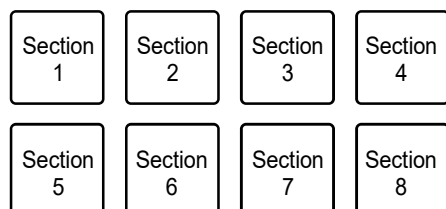

3 Press the [PARAMETER ◀] or [PARAMETER ▶] button to set a Quantization.

Each press of the button sets a Quantization as follows.

- 1/8 (plays a loop of 1/8 length from the beginning of a section)
- 1/4 (plays a loop of 1/4 length from the beginning of a section)
- 1/2 (plays a loop of 1/2 length from the beginning of a section)
- 1 (plays the entire section)

Using the Performance Pads

4 Press a Performance Pad assigned with the section you want to play in a loop.

Loop playback continues while you press the Performance Pad.

- Normal playback continues with its original rhythm in the background during Slicer Loop playback, but you can't hear this.
- Release a Performance Pad to end Slicer Loop playback. Normal playback starts from the exact point the track would have reached by now.
- Playback returns to and continues from the beginning of section 1 if playback reaches the end of a domain.

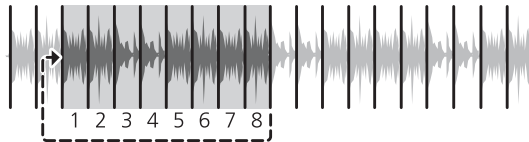

Saved Flip mode

Serato Flip is a function to record or call up a sequence of such as operation of a Hot Cue.
You can save and play a Flip using the Performance Pads on the unit.

❖ Registering a Flip to a slot

1 Create a Flip using Serato DJ Pro.

- For details on how to create a Flip, refer to the Serato DJ Pro software manual (page 6).

2 Press the [SAVED LOOP] button while pressing the [SHIFT] button.

The unit switches to Saved Flip mode.

3 Press the Performance Pad for the slot you want to save the Flip to.

The Flip is saved to the slot.

Using the Performance Pads

- Slots are assigned to the Performance Pads as follows.

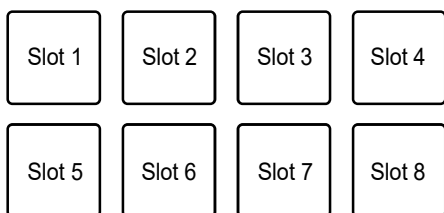

- You can't save a Flip to a slot if all slots have saved Flips already. Delete a Flip on the slot screen in Serato DJ Pro to free up a slot for a new Flip.

❖ Calling up and playing a Flip

1 Press the [SAVED LOOP] button while pressing the [SHIFT] button.

The unit switches to Saved Flip mode.

2 Press the Performance Pad assigned with the slot (Flip) you want to play.

The Flip is called up and playback starts from the beginning of the Flip.

- Slots are assigned to the Performance Pads as follows.

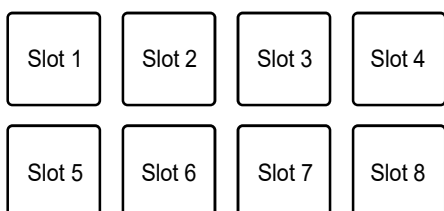

- If you call up a Flip by pressing a Performance Pad while pressing the [SHIFT] button, playback does not start from the beginning. Instead, Flip playback starts when the playback of the track reaches the beginning of the Flip.
- Press a Performance Pad during Flip playback to move to the beginning of the Flip that's playing.
- Press the Performance Pad while pressing the [SHIFT] button to cancel Flip playback and return to normal playback.

Using the Performance Pads

Scratch Bank mode

You can load the sound of a Scratch Bank.

1 Open the [SCRATCH BANK] pane on the Serato DJ Pro screen.

2 Press the [SAMPLER] button while pressing the [SHIFT] button.

The unit switches to Scratch Bank mode.

3 Press the Performance Pad assigned with the Scratch Bank you want to load.

The sound of the Scratch Bank is loaded to the unit.

- Slots are assigned to the Performance Pads as follows.

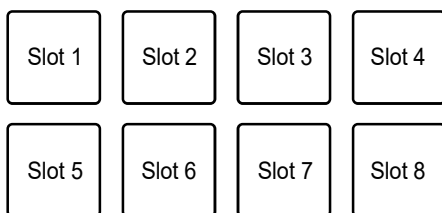

Gate Cue mode

You can play a Hot Cue by using Gate Cue.

1 Press the [HOT CUE] button twice in succession.

The unit switches to Gate Cue mode.

2 Press a Performance Pad assigned with a Hot Cue you want to play.

Playback of the Hot Cue sound continues while you press the Performance Pad.

Using the Performance Pads

- Hot Cues are assigned to the Performance Pads as follows.

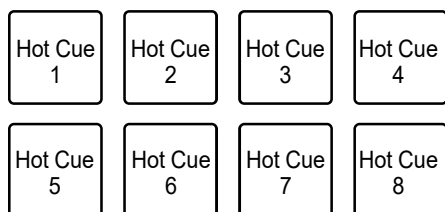

- Release the Performance Pad to mute the sound. Press the Performance Pad again to start playback of the Hot Cue from the beginning.

Cue Loop mode

1 Press the [ROLL] button twice in succession.

The unit switches to Cue Loop mode.

2 During playback, press a Performance Pad at the point where you want to set a loop point.

A loop point is set to a Hot Cue slot, and loop playback starts.

- Loop-in points are assigned to the Performance Pads as follows.

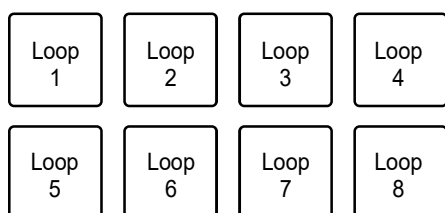

- The number of beats set for Auto Loop is applied to the loop length.
- A Hot Cue is used as a loop-in point for Cue Loop. Press a Performance Pad which is set with a Hot Cue to start loop playback from the Hot Cue point.
- Press the [PARAMETER ◀] or [1/2X] button during loop playback to halve the loop length by half with each press.
- Press the [PARAMETER ▶] or [2X] button during loop playback to double the loop length with each press.

Using the Performance Pads

- Press the Performance Pad again while pressing the [SHIFT] button to return to the loop-in point and start playback from there.
- Press the Performance Pad again to cancel loop playback.

Auto Loop mode

If you press a Performance Pad, a loop is set with the number of beats assigned to the Performance Pad and loop playback continues even if you release the Performance Pad.

1 Press the [SAVED LOOP] button twice in succession.

The unit switches to Auto Loop mode.

2 Press a Performance Pad during playback.

Loop playback starts according to the number of beats assigned to the Performance Pad.

- The number of beats is displayed on the Serato DJ Pro screen in the same way as the number of beats for Roll (page 69).
 - Press the [PARAMETER ◀] or [PARAMETER ▶] button during loop playback to change the length of a loop being played (page 65).
 - Press the [PARAMETER ◀] or [PARAMETER ▶] button while pressing the [SHIFT] button during loop playback to move a loop without changing the loop length.
- Press the Performance Pad again to cancel loop playback.

Using the Performance Pads

Transport mode

You can control a track using the Performance Pads without using a turntable or multi player. In Transport mode, functions are assigned to the Performance Pads as follows.

Performance Pad no.			
1	2	3	4
Pitch bend (-)	Pitch bend (+)	Pitch nudge (-)	Pitch nudge (+)
5	6	7	8
Key lock	Sync	Temp cue	Play/stop

1 Press the [SAMPLER] button twice in succession.

The unit switches to Transport mode.

2 Press a Performance Pad.

- 1 /2: Adjusts the pitch temporarily.
- 3 /4: Adjusts the pitch permanently by nudging the track.
Press Performance Pad 3 or 4 while pressing the [SHIFT] button to reset the key.
- 5: Turns the key lock function on and off.
When key lock is turned on, the pitch doesn't change – even if the tempo of a track is changed. In this scenario, sound quality is lowered due to the digital processing applied.
Press Performance Pad 5 while pressing the [SHIFT] button to switch the Serato DVS playback mode between the internal mode and relative mode.
- 6: Turns on the sync function.
Automatically synchronizes the tempo (pitch) of tracks on multiple decks when the Serato DVS playback mode is set to relative mode.
Automatically synchronizes the tempo and beatgrids of tracks on multiple decks when the Serato DVS playback mode is set to internal mode.
You can't use the sync function when the Serato DVS playback mode is set to absolute mode.

Using the Performance Pads

Press Performance Pad 6 while pressing the [SHIFT] button to turn off the sync function.

— 7: Sets, calls up, or plays a temporary cue point.

Press during pause to set a temporary cue point.

Press during playback to return to a temporary cue point and pause (Back Cue).

Press after the playback point returns to a temporary cue point to continue playback while pressing the button (Cue Sampler). Press Performance Pad 8 during Cue Sampler playback to continue playback even if you release the Performance Pad.

Press while pressing the [SHIFT] button to load a previous track in the track list (Previous Track). If the current playback position is not the beginning of the track, the playback point returns to the beginning of the track.

— 8: Plays or stops a track.

Press while pressing the [SHIFT] button to return to a temporary cue point and continue playback (Stutter).

Using the Performance Pads

rekordbox

Press the Pad mode buttons ([HOT CUE], [ROLL], [SAVED LOOP], or [SAMPLER]) to switch between modes and use different functions.

Hot Cue mode

You can call up a Hot Cue quickly and start playback by pressing a Performance Pad.

- You can set up to 16 Hot Cues per track.
- The procedure is the same as for Serato DJ Pro. See Hot Cue mode (page 68).
- Hot Cues are assigned to the Performance Pads as follows.

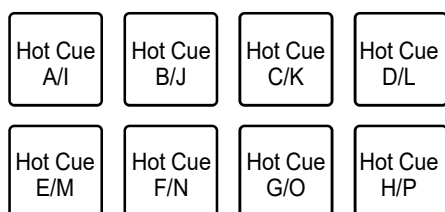

- Press the [PARAMETER ◀] or [PARAMETER ▶] button to switch Hot Cues between A to H and I to P. At the same time, the Hot Cue display area switches on the deck screen in rekordbox.

Pad FX mode

You can apply effects using the Performance Pads.

1 Press the [ROLL] button.

The unit switches to Pad FX mode 1.

- Press the [ROLL] button while pressing the [SHIFT] button to switch to Pad FX mode 2.

2 Press the Performance Pad assigned with the effect you want to use.

The effect is applied according to the number of beats set to the Performance Pad while you press it.

Using the Performance Pads

- Effects are assigned to the Performance Pads as follows.

Effect A/I	Effect B/J	Effect C/K	Effect D/L
Effect E/M	Effect F/N	Effect G/O	Effect H/P

- Release the Performance Pad to cancel the effect.
- Press the [PARAMETER ◀] or [PARAMETER ▶] button to switch effects between A to H and I to P. At the same time, the effects display area switches on the deck screen in rekordbox.

Beat Jump mode

You can move the playback point quickly without breaking the rhythm of the track that's playing.

1 Press the [SAVED LOOP] button.

The unit switches to Beat Jump mode.

2 Press a Performance Pad.

The playback point moves according to the number of beats or bars assigned to the Performance Pad.

- The number of beats or bars to jump is assigned to the Performance Pads as follows in the default settings.

1 beat (to the left)	1 beat (to the right)	2 beats (to the left)	2 beats (to the right)
4 beats (to the left)	4 beats (to the right)	8 beats (to the left)	8 beats (to the right)

- Press the [PARAMETER ◀] or [PARAMETER ▶] button to switch the number of beats or bars to assign to the Performance Pads.

Using the Performance Pads

Sampler mode

You can play a track loaded to a Sampler slot using the Performance Pads.

❖ Preparation

1 Click the Sampler pane icon on the upper part of the rekordbox screen.

The Sampler pane is displayed on the rekordbox screen.

2 Press the [SAMPLER] button on the unit.

The unit switches to Sampler mode.

3 Press the [PARAMETER ◀] or [PARAMETER ▶] button while pressing the [SHIFT] button to switch Sampler Banks.

Sampler has four banks and each bank has 16 slots.

- The selected Sampler Bank is applied to all the decks.

4 Press the [BROWSE] knob to move the cursor to the track list.

5 Turn the [BROWSE] knob to select a track.

6 Press a Performance Pad while pressing the [SHIFT] button.

The selected track is loaded to the Sampler slot.

- You may not be able to load a track to a Sampler slot which already has a track loaded, depending on the [Preferences] settings in rekordbox.

Using the Performance Pads

❖ Playing a Sampler track

1 Press the [SAMPLER] button.

The unit switches to Sampler mode.

2 Press the [PARAMETER ◀] or [PARAMETER ▶] button while pressing the [SHIFT] button to switch Sampler Banks.

3 Adjust the Sampler gain on the rekordbox screen.

4 Press a Performance Pad.

Playback of the slot assigned to the Performance Pad starts.

- Slots are assigned to the Performance Pads as follows.

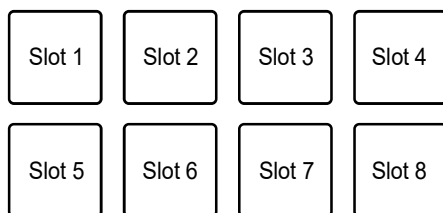

- Press a Performance Pad during Sampler playback to return to the beginning and continue playback.

5 Turn the [SAMPLER VOLUME] knob to adjust the volume for the Sampler sound.

- Press the Performance Pad again while pressing the [SHIFT] button to stop playback.

Using the Performance Pads

Keyboard mode

You can change the scale of a Hot Cue using the Performance Pads like a keyboard.

1 Press the [HOT CUE] button while pressing the [SHIFT] button.

The unit switches to Keyboard mode.

2 Press the [PARAMETER ◀] or [PARAMETER ▶] button to switch the keys to assign to the Performance Pads.

3 Press the Performance Pad assigned with the Hot Cue you want to use.

- If a Hot Cue is not assigned to the Performance Pad, the current playback position is set as a Hot Cue to be used in Keyboard mode.
- Press the [HOT CUE] button while pressing the [SHIFT] button to change a Hot Cue.

4 Press a Performance Pad.

Playback of the Hot Cue starts according to the key assigned to the Performance Pad.

Using the Performance Pads

Beat Loop mode

If you press a Performance Pad, a loop is set with the number of beats or bars assigned to the Performance Pad, and the loop playback continues even if you release the Performance Pad.

1 Press the [SAVED LOOP] button while pressing the [SHIFT] button.

The unit switches to Beat Loop mode.

2 Press a Performance Pad.

Loop playback starts according to the number of beats or bars assigned to the Performance Pad.

- The number of beats or bars for Beat Loop is assigned to the Performance Pads as follows.

1/64 beats	1/32 beats	1/16 beats	1/8 beats
1/4 beats	1/2 beats	1 beat	2 beats

- Press the [PARAMETER ◀] or [PARAMETER ▶] button to switch the number of beats or bars to assign to the Performance Pads. At the same time, the Beat Loop display area is switched on the deck screen in rekordbox.
- Press the Performance Pad again to cancel loop playback.

Using the Performance Pads

Key Shift mode

You can shift the key of a track that's playing according to the keys assigned to the Performance Pads.

1 Press the [SAMPLER] button while pressing the [SHIFT] button.

The unit switches to Key Shift mode.

2 Press the [PARAMETER ◀] or [PARAMETER ▶] button to switch the keys to assign to the Performance Pads.

3 Press a Performance Pad.

The key of the track that's playing is shifted to the key assigned to the Performance Pad.

Pad editor

You can customize the functions to assign to the Performance Pads on the unit using rekordbox.

For details on the pad editor, refer to the instruction manual for rekordbox at the URL below.

rekordbox.com/manual

User mode

You can assign DJ software functions to the Performance Pads on the unit using the MIDI assigning mode in most types of DJ software.

- Find out about the MIDI assigning mode of your DJ software in the relevant user manual.

Using User modes

The unit supports four User modes. You can assign functions to eight pads for each User mode.

This section describes an example of how to use User modes with Serato DJ Pro.

1 Press the [HOT CUE], [ROLL], [SAVED LOOP], or [SAMPLER] button twice in succession while pressing the [SHIFT] button.

- [HOT CUE]: Switches to User mode 1.
- [ROLL]: Switches to User mode 2.
- [SAVED LOOP]: Switches to User mode 3.
- [SAMPLER]: Switches to User mode 4.

2 Click [MIDI] on the Serato DJ Pro screen.

Serato DJ Pro switches to MIDI assigning mode.

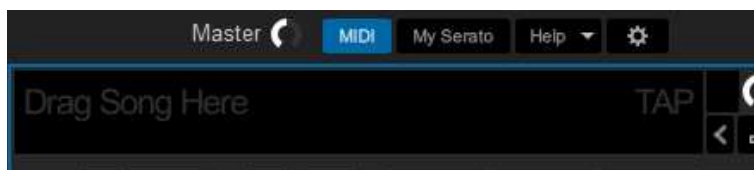

3 Click a function to assign to a Performance Pad on the unit.

Example: When assigning [▶] (PLAY/PAUSE)

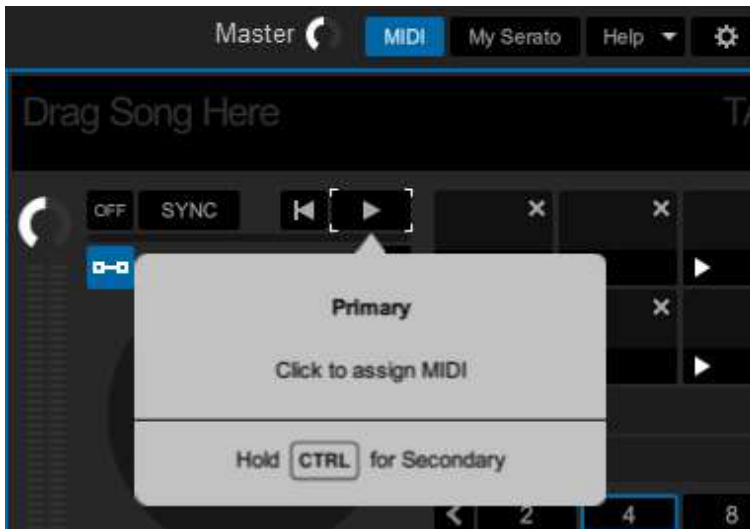

4 Press a Performance Pad to assign the selected function to.

If the assignment works, the confirmation message appears.

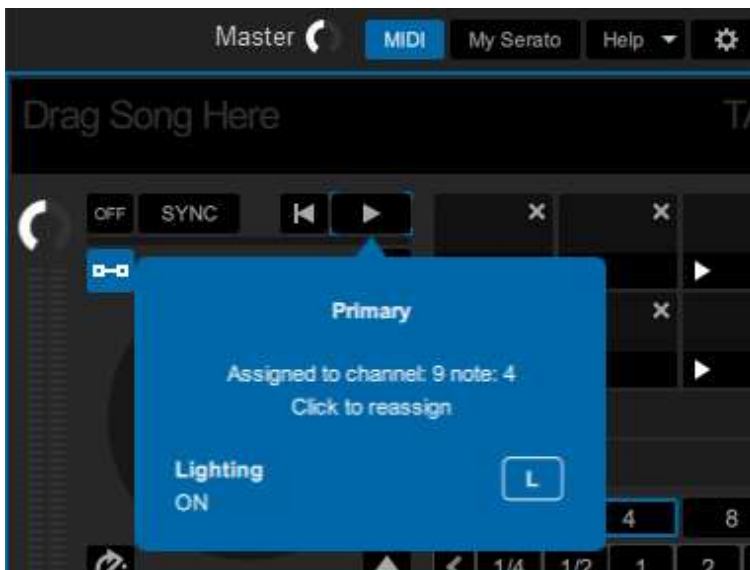

- Click [MIDI] to exit MIDI assigning mode.
- Switch to the relevant User mode after you've finished making settings to use the Serato DJ Pro functions assigned to the Performance Pads.

Fader Start

You can start playback by moving the fader knobs.

Using Fader Start

To use the Fader Start function, mark the check box of [Fader Start options.] on the [PREFERENCE] tab in Setting Utility.

🔗 Read more: Changing the settings (page 18)

Using Channel Fader Start

1 Set a cue.

- To find out how to set a cue point, refer to the user manual for your DJ software.
- You can set a cue by moving the channel fader to the bottom position while pressing the [SHIFT] button when a track is paused.

2 Move the channel fader up from the bottom position while pressing the [SHIFT] button.

Playback of the track starts from the cue point.

- Move the channel fader back to the bottom position while pressing the [SHIFT] button during playback to quickly return to the cue point and pause playback (Back Cue).
- If a cue is not set, playback starts from the beginning of the track.
- You can set whether the sync function will turn on when Channel Fader Start is triggered (only for use with Serato DJ Pro) on the [PREFERENCE] tab in Setting Utility (page 18).
- Move the channel fader to the bottom position while pressing the [SHIFT] button during cue standby to start playback from the cue point.

Using Crossfader Start

1 Set a cue.

- For details on how to set a cue point, refer to the user manual for your DJ software.
- You can set a cue by moving the crossfader all the way to the left or right side while pressing the [SHIFT] button during pause.

2 Set the crossfader all the way to the left side or right side.

- Set the crossfader to the opposite side of the channel which starts playback via Crossfader Start.

3 Move the crossfader away from the left or right side while pressing the [SHIFT] button.

Playback of the track starts from the cue point.

- Move the crossfader all the way back to the left or right side while pressing the [SHIFT] button during playback to quickly return to the cue point and pause playback (Back Cue).
- If a cue is not set, playback starts from the beginning of the track.
- Move the crossfader all the way from one side to the other while pressing the [SHIFT] button during cue standby to start playback from the set cue point.

Settings

Changing the settings

You can change the settings of the unit from the Utility menu.

If a PC/Mac is connected to the unit when you change the settings, the changed settings are saved to the PC/Mac. The saved settings are applied to the unit the next time the PC/Mac is connected.

- 1 Press and hold the [PANEL/UTILITY] button for more than 1 second.**

The [Utility] setting screen appears.

- 2 Press the [BEAT ◀] or [BEAT ▶] button to select a setting item.**

- 3 Press the [SHIFT] button.**

The setting screen appears.

- 4 Press the [BEAT ◀] or [BEAT ▶] button to select a setting.**

- 5 Press the [SHIFT] button to confirm the setting.**

The display returns to the previous screen.

- To return to the previous screen without changing the setting, press the [PANEL/UTILITY] button.

- 6 Press the [PANEL/UTILITY] button.**

The [Utility] setting screen closes.

Utility settings

*: Factory setting

Setting items	Description
<u>AUTO STANDBY</u>	<p>Sets the auto standby function (page 96).</p> <ul style="list-style-type: none"> Setting values: OFF, ON*
<u>MIC TALKOVER</u>	<p>Sets the talkover mode for the microphone.</p> <ul style="list-style-type: none"> Setting values: OFF*, ADVANCED, NORMAL
<u>TALKOVER LEVEL</u>	<p>Sets the talkover level for the microphone.</p> <ul style="list-style-type: none"> Setting values: -6dB, -12dB, -18dB*, -24dB
<u>MIC LOW CUT</u>	<p>Sets the low-frequency cut function for the microphone sound.</p> <ul style="list-style-type: none"> Setting values: OFF, ON*
<u>MIC TO BOOTH</u>	<p>Sets whether or not to mix the microphone sound into the booth output sound.</p> <ul style="list-style-type: none"> Setting values: OFF, ON*
<u>MIC LIMITER</u>	<p>Sets whether or not to reduce distortion to the sound output from the [MIC] terminals.</p> <ul style="list-style-type: none"> Setting values: OFF*, ON
<u>MASTER ATT.</u>	<p>Sets the attenuation level for the sound output from the [MASTER 1] and [MASTER 2] terminals.</p> <ul style="list-style-type: none"> Setting values: -12dB, -6dB, 0dB*
<u>MASTER LIMITER</u>	<p>Reduces distortion to the sound output from the [MASTER 1] and [MASTER 2] terminals.</p> <ul style="list-style-type: none"> Setting values: OFF, ON*

Setting items	Description
<u>BOOTH ATT.</u>	<p>Sets the attenuation level for the sound output from the <u>[BOOTH]</u> terminals.</p> <ul style="list-style-type: none"> Setting values: <u>-12dB, -6dB, 0dB*</u>
<u>MASTER OUT</u>	<p>Sets the output method (mono/stereo) for the sound output from the <u>[MASTER 1]</u> and <u>[MASTER 2]</u> terminals.</p> <ul style="list-style-type: none"> Setting values: <u>MONO, STEREO*</u>
<u>BOOTH OUT</u>	<p>Sets the output method (mono/stereo) for the sound output from the <u>[BOOTH]</u> terminals.</p> <ul style="list-style-type: none"> Setting values: <u>MONO, STEREO*</u>
<u>LED BRIGHTNESS</u>	<p>Sets the brightness of the buttons, Performance Pads, and organic EL display.</p> <ul style="list-style-type: none"> Setting values: <u>1*, 2, 3</u>
<u>AUX INPUT LEVEL</u>	<p>Sets the input level for AUX.</p> <ul style="list-style-type: none"> Setting values: <u>0dB*, 12dB</u>
<u>BLUETOOTH INPUT</u>	<p>Sets the input route for the Bluetooth device audio.</p> <ul style="list-style-type: none"> Setting values: <u>MASTER*, CH 1, CH 2</u>
<u>BT LINK TONE</u>	<p>Sets the volume for the tone output to the headphones when a Bluetooth device is connected or the connection is terminated.</p> <ul style="list-style-type: none"> Setting values: <u>OFF, SMALL, MID*, LARGE</u>
<u>PC UTILITY</u>	<p>Sets whether or not to launch Setting Utility (page 15) when a PC/Mac is connected to the unit.</p> <ul style="list-style-type: none"> Setting values: <u>OFF, ON*</u>
<u>FACTORY RESET</u>	<p>Restores the factory settings.</p> <ul style="list-style-type: none"> Setting values: <u>OK, CANCEL</u>

Auto standby

When [AUTO STANDBY] is set to [ON], the unit enters Standby mode after 10 hours without being used (when no audio signal is input to the channels on the unit).

Press the [PANEL/UTILITY] button to exit standby mode.

- The factory setting is [ON].
- Set [AUTO STANDBY] to [OFF] if you don't need to use the auto standby function.

Specifications

Main unit weight	4.5 kg (9.9 lbs)
Max. dimensions	267 mm (W) × 452.2 mm (D) × 107.9 mm (H) (10.5 in. (W) × 17.8 in. (D) × 4.2 in. (H))
Tolerable operating temperature	+5 °C to +35 °C (+41 °F to +95 °F)
Tolerable operating humidity	5% to 85% (no condensation)

Audio Section

Sampling rate	48 kHz
MASTER D/A converter	24 bits
CH input A/D converter	24 bits
Other A/D, D/A converters.....	24 bits
Frequency characteristic	
USB, LINE, MIC, AUX	20 Hz to 20 kHz
S/N ratio (rated output, A-WEIGHTED)	
USB	115 dB
LINE	105 dB
PHONO	90 dB
MIC	80 dB
AUX	90 dB
Total harmonic distortion (20 Hz to 20 kHzBW)	
USB	0.003%
LINE	0.005%
Standard input level/input impedance	
LINE	-12 dBu/47 kΩ
PHONO	-52 dBu/47 kΩ
MIC.....	-57 dBu/3.3 kΩ
AUX	-12 dBu/47 kΩ
Maximum input level	
PHONO	-17.8 dBu
LINE	+15 dBu
MIC.....	+2.3 dBu
AUX.....	+17 dBu (0 dB) / +5 dBu (12 dB)
Standard output level/load impedance/output impedance	
MASTER 1	+6 dBu/10 kΩ/390 Ω or less
MASTER 2	+2 dBu/10 kΩ/390 Ω or less

Specifications

BOOTH	+6 dBu/10 k Ω /390 Ω or less
PHONES	+8 dBu/32 Ω /10 Ω or less
Rated output level/load impedance	
MASTER 1	+25 dBu/10 k Ω
MASTER 2	+21 dBu/10 k Ω
BOOTH	+25 dBu/10 k Ω
Crosstalk	
LINE	82 dB
Channel equalizer characteristic	
ISO	
HI.....	-. ∞ dB to +6 dB (20 kHz)
MID	-. ∞ dB to +6 dB (1 kHz)
LOW	-. ∞ dB to +6 dB (20 Hz)
Microphone equalizer characteristic	
HI.....	-12 dB to +0 dB (10 kHz)
LOW	-12 dB to +0 dB (100 Hz)

Input/output terminals

LINE input terminal	
RCA pin jacks.....	2 sets
PHONO input terminal	
RCA pin jacks.....	2 sets
MIC input terminal (XLR/TRS)	
XLR connector & 1/4" TRS jack	1 set
AUX input terminal	
RCA pin jacks.....	1 set
MASTER output terminal	
XLR connector	1 set
RCA pin jacks.....	1 set
BOOTH output terminal (TRS)	
1/4" TRS jacks.....	1 set
PHONES output terminal	
1/4" stereo phone jack.....	1 set
3.5 mm stereo mini jack	1 set
CDJ/CONTROLLER terminal	
申し送り USB type A	2 sets
Power supply	5 V/500 mA or less

Specifications

USB terminal

USB type B 2 sets

The specifications and design of this product are subject to change without notice.

Block diagram

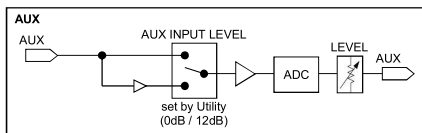
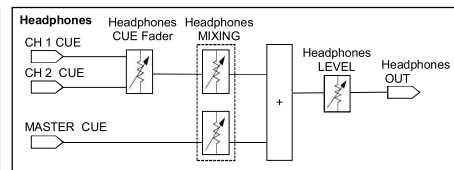
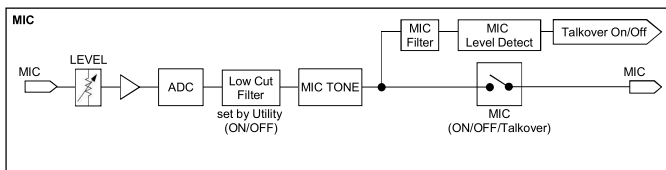
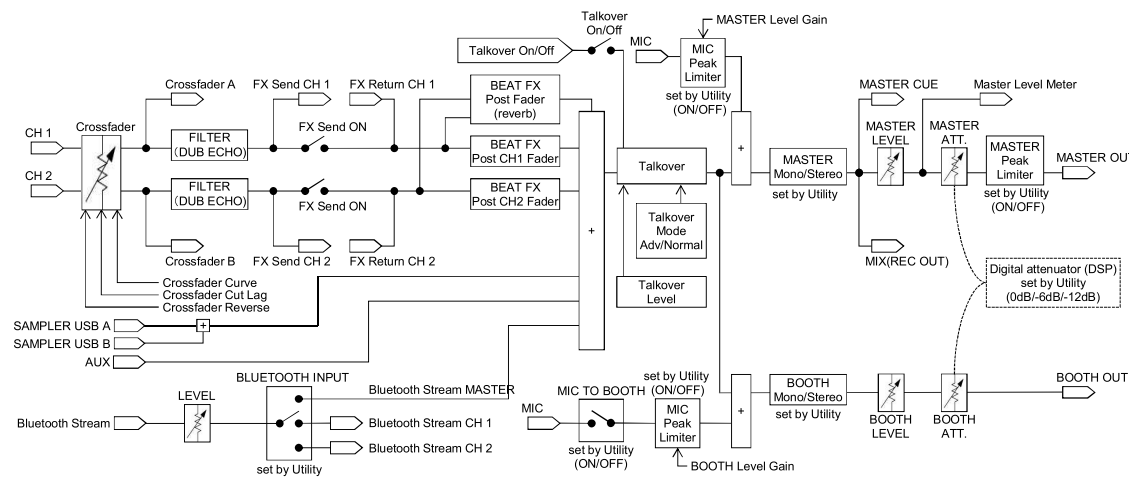
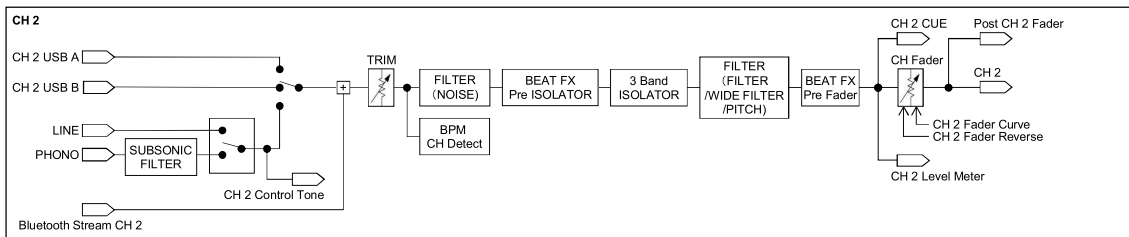
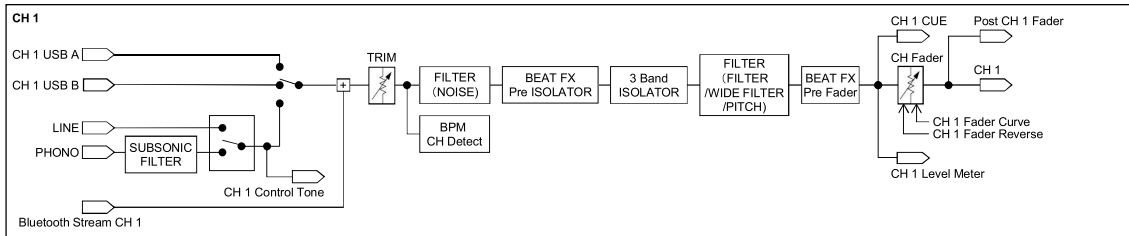

Specifications

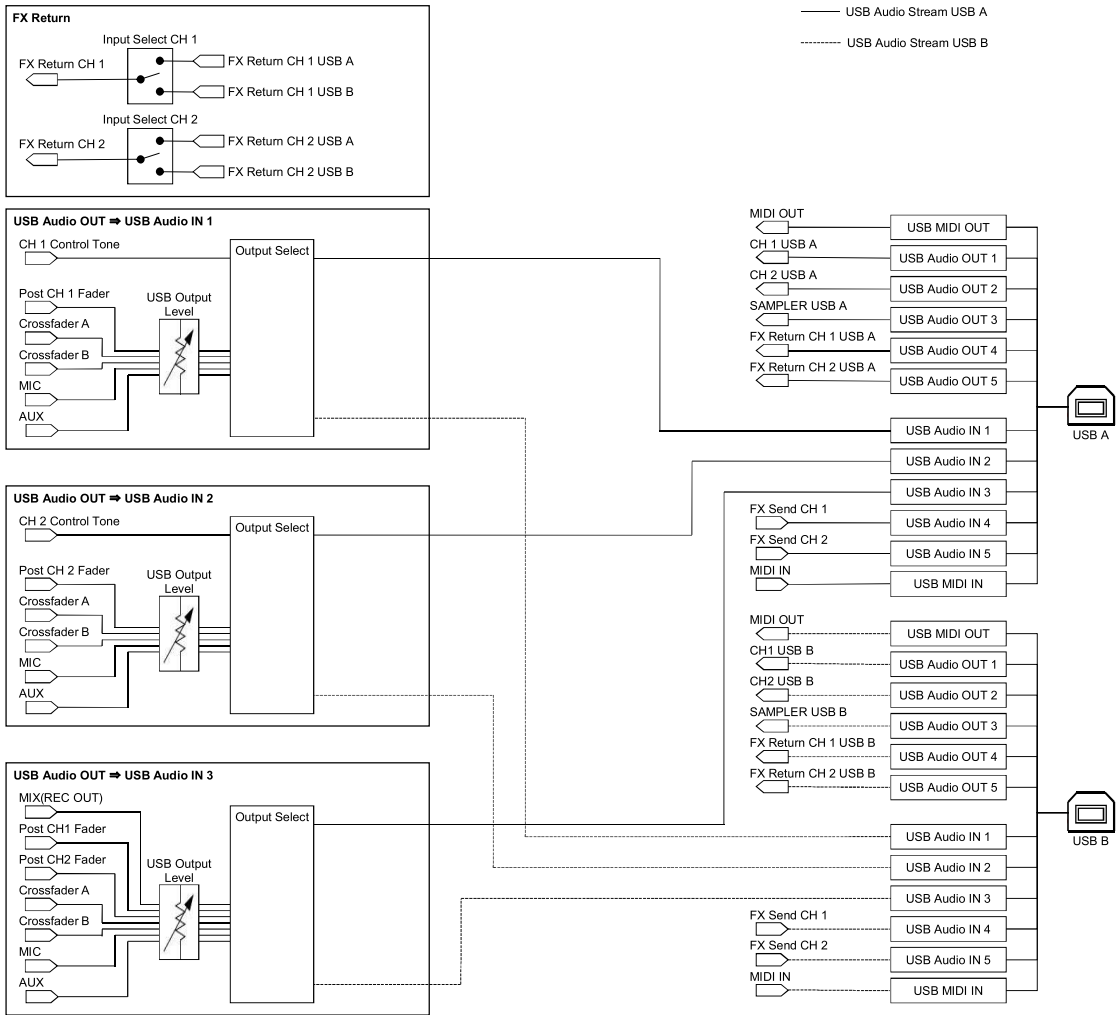

Additional information

Troubleshooting

If you think something is wrong with the unit, check the information below and refer to the [\[FAQ\]](#) for the DJM-S7 at the URL below.

pioneerdj.com/support/

- [Inspect devices connected with the unit.](#)
- [The unit may restore proper operation after you turn it off and on.](#)

[If the problems continue, read the “Precautions for Use” and consult Authorized Service Company or your dealer.](#)

Trademarks and registered trademarks

- [rekordbox™ is a trademark or registered trademark of AlphaTheta Corporation.](#)
- [Mac and macOS are trademarks of Apple Inc., registered in the U.S. and other countries.](#)
- [Windows is a registered trademark of Microsoft Corporation in the United States and other countries.](#)
- [ASIO is a trademark of Steinberg Media Technologies GmbH.](#)
- [Serato DJ Pro is a registered trademark of Serato Limited.](#)

[Other product, technology and company names, etc. mentioned herein are trademarks or registered trademarks of their respective owners.](#)

Software license notice

The licenses for the open source software used on this player are shown below. For accuracy purposes, here we have included the original texts (in English).

Copyright © 2010 Texas Instruments Incorporated - <http://www.ti.com/>

Redistribution and use in source and binary forms, with or without modification, are permitted provided that the following conditions are met:

Redistributions of source code must retain the above copyright notice, this list of conditions and the following disclaimer.

Redistributions in binary form must reproduce the above copyright notice, this list of conditions and the following disclaimer in the documentation and/or other materials provided with the distribution.

Neither the name of Texas Instruments Incorporated nor the names of its contributors may be used to endorse or promote products derived from this software without specific prior written permission.

THIS SOFTWARE IS PROVIDED BY THE COPYRIGHT HOLDERS AND CONTRIBUTORS «AS IS» AND ANY EXPRESS OR IMPLIED WARRANTIES, INCLUDING, BUT NOT LIMITED TO, THE IMPLIED WARRANTIES OF MERCHANTABILITY AND FITNESS FOR A PARTICULAR PURPOSE ARE DISCLAIMED. IN NO EVENT SHALL THE COPYRIGHT OWNER OR CONTRIBUTORS BE LIABLE FOR ANY DIRECT, INDIRECT, INCIDENTAL, SPECIAL, EXEMPLARY, OR CONSEQUENTIAL DAMAGES (INCLUDING, BUT NOT LIMITED TO, PROCUREMENT OF SUBSTITUTE GOODS OR SERVICES; LOSS OF USE, DATA, OR PROFITS; OR BUSINESS INTERRUPTION) HOWEVER CAUSED AND ON ANY THEORY OF LIABILITY, WHETHER IN CONTRACT, STRICT LIABILITY, OR TORT (INCLUDING NEGLIGENCE OR OTHERWISE) ARISING IN ANY WAY OUT OF THE USE OF THIS SOFTWARE, EVEN IF ADVISED OF THE POSSIBILITY OF SUCH DAMAGE.

Cautions on copyrights

Recordings you have made are for your personal enjoyment and according to copyright laws may not be used without the consent of the copyright holder.

- Music recorded from CDs, etc., is protected by the copyright laws of individual countries and by international treaties. It is the full responsibility of the person who has recorded the music to ensure that it is used legally.
- When handling music downloaded from the Internet, etc., it is the full responsibility of the person who has downloaded the music to ensure that it is used in accordance with the contract concluded with the download site.

The specifications and design of this product are subject to change without notice.

© 2020 AlphaTheta Corporation. All rights reserved.

<DRI1682-A>

Pioneer DJ DJM-S7

**DJ MIXER
TABLE DE MIXAGE
DJ-MISCHPULT
MIXER PER DJ
DJ MENGPAANEL
MESA DE MEZCLAS
MESA DE MISTURA PARA DJ
DJ микшерный пульт**

**Precautions for Use
Précautions à l'utilisation
Hinweise für den Gebrauch
Precauzioni
Voorzorgsmaatregelen
Precauciones al usar
ΠΡΕΚΑΥΣΙΕΣ
Правила предосторожности при эксплуатации**

**pioneer.com/support/
redbox.com/**

For FAQs and other support information for this product, visit the above site.
Concernant les questions les plus fréquemment posées et les autres informations de support à propos de ce produit, veuillez vous rendre sur le site ci-dessus.
Besuchen Sie für FAQs und andere Support-Informationen die oben aufgeführte Website.
Per FAQ e altre informazioni di supporto per questo prodotto, visitate il sito sopra indicato.
Für FAQs e andere supportinformationen voor dit product, bezoek de bovengenoemde website.
Para consultar las preguntas frecuentes y otra información de soporte de este producto, visite el sitio de arriba.
Relativamente às FAQ e outras informações de apoio relacionadas com este produto, visite o site em cima.
Ответы на часто задаваемые вопросы и другую информацию о поддержке данного устройства см. на приведенном выше веб-сайте.

Bluetooth **Low Latency**

Qualcomm aptX™

EARC

AlphaTheta Corporation
6F, Yokohama 1-Mark Place, 4-4-5 Minatomirai, Nishi-ku, Yokohama, Kanagawa 220-0012 JAPAN
AlphaTheta株式会社
〒220-0012 神奈川県横浜市みなとみらい4丁目4番5号 横浜アイマーグループ16階
Корпорация АльфаТета
6F, Yokohama 1-Mark Place, 4-4-5 Minatomirai, Nishi-ku, Yokohama, Kanagawa 220-0012 JAPON
AlphaTheta EMEA Limited
11th Floor, Watlington Road, West End Road, South Ruislip, Middlesex, HA4 6QE, U.K. TEL: +44-203-7617-220
AlphaTheta Music Americas, Inc.
2500 W. 190th Street, Suite 109, Torrance, CA 90504, U.S.A. TEL: +1 (424) 488-0480

© 2020 AlphaTheta Corporation. All rights reserved.
© 2020 AlphaTheta Corporation. Tous droits réservés.

Сделано в Китае Printed in China / Imprimé en Chine **DRHM1615-A-**

English

CAUTION
TO PREVENT THE RISK OF ELECTRIC SHOCK, DO NOT REMOVE COVER (OR BACK). NO USER-SERVICEABLE PARTS INSIDE. REFER SERVICING TO QUALIFIED SERVICE PERSONNEL. **D3-4-2-1_B1_En**

WARNING
This equipment is not waterproof. To prevent a fire or shock hazard, do not place any container filled with liquid near this equipment such as a vase or flower pot or expose it to sprays, misting, rain or moisture. **D3-4-2-2_Aa_1_En**

WARNING
This product equipped with a three-wire grounding (earthed) plug - a plug that has a third grounding pin. This plug only fits a grounded three-prong outlet. If you are unable to insert the plug into an outlet, contact a licensed electrician to replace the outlet with a properly grounded one. Do not defeat the safety purpose of the grounding plug. **D3-4-2-1-7a_1_En**

WARNING
To prevent a fire hazard, do not place any naked flame sources (such as a lit cigarette) on the equipment. **D3-4-2-1-7a_1_En**

Operating Environment
Operating temperature and humidity:
+5 °C to +45 °C (+41 °F to +113 °F), less than 85 %RH (cooling vents not blocked)
Do not install this unit in a poorly ventilated area, or in locations exposed to high humidity or direct sunlight (or strong artificial light). **D3-4-2-1-7c_1_En**

VENTILATION CAUTION
When installing this unit, make sure to leave space around the unit for ventilation to improve heat radiation (at least 5 cm at rear, and 5 cm at each side). **D3-4-2-1-7d_1_En**

WARNING
Store small parts out of the reach of children and infants. If accidentally swallowed, contact a doctor immediately. **D4-1-4_A1_En**

For Europe
If you want to dispose this product, do not mix it with general household waste. There is a separate collection system for used electronic products in accordance with legislation that requires proper treatment, recovery and recycling. **D4-1-4_A1_En**

Private households in the member states of the EU, in Switzerland and Norway may return their used electronic products free of charge to designated collection facilities or to a retailer (if you purchase a similar new one).
For entries not mentioned above, please contact your local authorities for the correct method of disposal.
By doing so you will ensure that your disposed product undergoes the necessary treatment, recovery and recycling and thus prevent potential negative effects on the environment and human health. **K06A_1_En**

For Finland customers
Apurajat sisältävät sähköiskotilman vastustustuon pöytäasennuksen.
For Norway customers
Apurajat skilpov skilpovt utslipp av skilpovt med jord, som givert forbruldes til skilpovt og jord. **D3-4-2-1-4b_1_En**

For Sweden customers
Apurajat skilpovt utslipp av skilpovt med jord, som givert forbruldes til skilpovt og jord. **D3-4-2-1-4b_1_En**

For Denmark customers
Apurajat skilpovt utslipp av skilpovt med jord, som givert forbruldes til skilpovt og jord. **D3-4-2-1-4b_1_En**

For U.S.A.
This transmitter must not be co-located or operated in conjunction with any other antenna or transmitter. **D3-4-2-1-7a_1_En**

This equipment complies with FCC radiation exposure limits set forth for an uncontrolled environment and meets the FCC radio frequency (RF) Exposure Guidelines. This equipment has very low levels of RF energy that it deemed to comply without maximum permissive exposure (MPE). But it is desirable that it should be installed and operated keeping the radiator at least 20 cm or more away from person's body (excluding extremities: hands, wrists, feet and ankles).
NOTE: This equipment has been tested and found to comply with the limits for a Class B digital device, pursuant to Part 15 of the FCC Rules. These limits are designed to provide reasonable protection against harmful interference in a residential installation. This equipment generates, uses, and can radiate radio frequency energy and, if not installed and used in accordance with the instructions, may cause harmful interference to radio communications. However, there is no guarantee that interference will not occur in a particular installation. If this equipment does cause harmful interference to radio or television reception, which can be determined by turning the equipment off and on, the user is encouraged to try to correct the interference by one or more of the following measures:
— Recipient or relocate the receiving antenna.
— Increase the separation between the equipment and receiver.
— Connect the equipment into an outlet on a circuit different from that to which the receiver is connected.
— Consult the dealer or an experienced radio/TV technician for help. **D3-10-1-2_A1_En**

For Canada
This device contains licence-exempt transmitter(s)/receiver(s) that comply with Innovation, Science and Economic Development Canada's licence-exempt RSS(s). Operation is subject to the following two conditions: (1) This device must not cause interference; and (2) This device must accept any interference, including interference that may cause undesired operation of the device. **D3-10-1-2_A1_En**

Specifications
General - Main Unit
Power requirements: AC 110 V ~ 240 V, 50/60 Hz
Power consumption (standby): 0.3 W
Power consumption (standby): 0.3 W
Main unit weight: 4.5 kg (9.9 lbs)
Max. dimensions: (W x H x D) 287 x 397 x 107 mm / 10.51" x 15.65" x 4.25"
Tolerable operating temperature: +5 ~ +45 °C (+41 °F ~ +113 °F)
Tolerable operating humidity: 5 ~ 85% (no condensation)

Audio Section
Sampling rate: 48 kHz
D/A converter: 24 bit
Power characteristics:
USB, LINE, MIC, AUX (Weighted)
20 Hz ~ 20 kHz
SN ratio (input/output, A-WEIGHTED)
20 Hz ~ 20 kHz
USB: 110 dB
LINE: 103 dB
PHONO: 88 dB
MIC: 80 dB
AUX: 103 dB
Maximiser Eingangspegel: 110 dB
MIC: +23 dBu
LINE: +15 dBu (0 dB) +3 dBu (12 dB)
AUX: +23 dBu (0 dB) +3 dBu (12 dB)

Standard-Ausgangspegel / Ausgangsimpedanz
Line-Eingangsbuschens: 2 Sätze
Cinch-Buschens: 2 Sätze
PHONO-Eingangsbuschens: 1 Satz
MIC-Eingangsbuschens (XLR/TRS): 1 Satz
XLR-Anschlüsse: 1 Satz
Cinch-Buschens: 1 Satz
BOOTH-Ausgangsbuschens (TRS): 1 Satz
PHONO-Anschlüsse: 1 Satz
Cinch-Klinkenstecker: 1 Satz
Stereo-Mikrofonklinkenstecker: 1 Satz
Typ A: 1 Satz
Strömungsverbrauch: 5 W/600 mA
Typ B: 2 Sätze
Bluetooth®-Angaben
Maximale Übertragungsdistanz: Etwa 10 m ohne Hindernisse
Übertragungsdistanz mit Hindernissen: Etwa 10 m
Modulationsverfahren: FH-SS (Frequency hopping spread spectrum)
Kompatible Codescs: SBC, AAC, Qualcomm aptX™, Qualcomm aptX™ Low Latency
abhängig von der USB-Cable Art.
Anderen Angaben der technischen Daten und des Designs dieses Geräts ohne vorherige Ankündigung bleiben vorbehalten.

ATTENZIONE
PER EVITARE IL RISCHIO DI SCOSSE ELETTRICHE, NON RIMOVIAMO IL COPRICOLO (O IL RETRO). NON CI SONO PARTI INTERNE LA CUI MANUTENZIONE POSSA ESSERE EFFETTUATA DALL'UTENTE. IN CASO DI NECESSITÀ, RIVOLGERSI ESCLUSIVAMENTE AL PERSONALE DI SERVIZIO QUALIFICATO. **D3-4-2-1_B1_En**

ATTENZIONE
Questo apparecchio non è impermeabile. Per prevenire pericoli di incendio o shock elettrico, non collocare questo apparecchio vicino a contenitori pieni di liquidi (quali vasi da fiori, o simili), e non esporre l'apparecchio a spruzzi, schizzi, pioggia o umidità. **D3-4-2-1-7a_1_En**

ATTENZIONE
Questo apparecchio è dotato di una spina con messa a terra, cioè di una spina con un terzo spinotto (per la messa a terra). Questo tipo di spina si inserisce automaticamente in una presa a tre poli. Se non si riesce ad inserire la spina nella presa di corrente di casa, rivolgersi ad un elettricista qualificato per far sostituire la presa alla parete con una dotata di attacco per la messa a terra. Non annullare la spina di sicurezza della spina con messa a terra. **D3-4-2-1-7a_1_En**

IMPORTANT

CAUTION
RISK OF ELECTRIC SHOCK
DO NOT OPEN

The ignition flash with arrowhead symbol, as reported by the user in the presence of the equipment, is intended to alert the user of the presence of potentially hazardous conditions within the products that may constitute a risk of electric shock to persons.
CAUTION
TO PREVENT THE RISK OF ELECTRIC SHOCK, DO NOT REMOVE COVER (OR BACK). NO USER-SERVICEABLE PARTS INSIDE. REFER SERVICING TO QUALIFIED SERVICE PERSONNEL.
The extension point within an equalized triangle is intended to alert the user of the presence of important operating and maintenance (service) instructions in the literature accompanying the appliance.
POWER-CORD CAUTION
Handle the power cord by the plug, do not pull out the plug by tugging the cord and never touch the power cord when your hands are wet as this could cause a short circuit or electric shock. Do not place the unit, a piece of furniture, etc., on the power cord, or pinch the cord. Never make a knot in the cord or tie it with other cords. The power cords should be routed such that they are not likely to be stepped on. A damaged power cord can cause a fire or give you an electrical shock. Check the power cord once in a while. When you find it damaged, ask your nearest service center or your dealer for a replacement. **D3-4-2-1-7a_1_En**

[Supplied power cord]
The supplied power cord is designed specifically for 120 V. Do not use it with a voltage other than 120 V.
Doing so may cause a fire or electric shock. **D3-7-16_PDU_1_En**

SETUP/SAFE LEVEL
• Set your volume control at a low setting.
• Slowly increase the sound until you can hear it comfortably and clearly, without a distortion.
• Once you have established a comfortable sound level, set the dial and leave it there.

BE SURE TO OBSERVE THE FOLLOWING GUIDELINES:
• Do not turn up the volume so high that you can't hear what's around you.
• Use caution or temporarily discontinue use when listening to hazardous situations.
• Do not use headphones while operating a motorized vehicle, the use of headphones may create a traffic hazard and is illegal in many areas. **800A_1_En**

For U.S.A. and other areas
FEDERAL COMMUNICATIONS COMMISSION DECLARATION OF CONFORMITY
This device complies with part 15 of the FCC Rules. Operation is subject to the following two conditions: (1) This device must not cause interference; and (2) This device must accept any interference received, including interference that may cause undesired operation of the equipment.
Product Name: DJ MIXER
Model Number: DJM-S7
Responsible Party Name: AlphaTheta Music Americas, Inc. OPERATIONS DIVISION
Address: 2500 W. 190th Street, Suite 109, Torrance, CA 90504, U.S.A.
Phone: 1-424-488-0480
URL: pioneer.com **D3-10-1-2_A1_En**

Information to User
Alterations or modifications carried out without appropriate authorization may invalidate the user's right to operate the equipment. **D3-10-1-2_A1_En**

Maximum input level
PHONO: -17.8 dBu
LINE: +15 dBu
MIC: +23 dBu
AUX: +23 dBu (0 dB) +3 dBu (12 dB)
Standard output level / Load impedance / Output impedance
PHONO: +2 dBu (0 dB) +3 dBu (12 dB) or less
MIC: +2 dBu (0 dB) +3 dBu (12 dB) or less
MASTER 2: +2 dBu (0 dB) +3 dBu (12 dB) or less
BOOTH: +2 dBu (0 dB) +3 dBu (12 dB) or less
PHONES: +8 dBu (2) / 10 Ω or less
Rated output level / Load impedance
MASTER 1: +24 dBu (0) k
MASTER 2: +24 dBu (0) k
BOOTH: +24 dBu (0) k

Line
Circuit: equalizer characteristic
HI: -8 dB ~ +6 dB (20 kHz)
MI: -8 dB ~ +6 dB (1 kHz)
LO: -8 dB ~ +6 dB (20 Hz)
Microphone equalizer characteristic
LO: -8 dB ~ +6 dB (10 kHz)
HI: -8 dB ~ +6 dB (100 Hz)

Input / Output terminals
LINE: RCA pin jacks: 2 sets
PHONO: RCA pin jacks: 2 sets
MIC input (TRS): 1 set
XLR connector & 1/4" TRS jack: 1 set
AUX input (TRS): 1 set
RCA pin jacks: 1 set

ATTENZIONE
PER EVITARE IL RISCHIO DI SCOSSE ELETTRICHE, NON RIMOVIAMO IL COPRICOLO (O IL RETRO). NON CI SONO PARTI INTERNE LA CUI MANUTENZIONE POSSA ESSERE EFFETTUATA DALL'UTENTE. IN CASO DI NECESSITÀ, RIVOLGERSI ESCLUSIVAMENTE AL PERSONALE DI SERVIZIO QUALIFICATO. **D3-4-2-1_B1_En**

ATTENZIONE
Questo apparecchio non è impermeabile. Per prevenire pericoli di incendio o shock elettrico, non collocare questo apparecchio vicino a contenitori pieni di liquidi (quali vasi da fiori, o simili), e non esporre l'apparecchio a spruzzi, schizzi, pioggia o umidità. **D3-4-2-1-7a_1_En**

ATTENZIONE
Questo apparecchio è dotato di una spina con messa a terra, cioè di una spina con un terzo spinotto (per la messa a terra). Questo tipo di spina si inserisce automaticamente in una presa a tre poli. Se non si riesce ad inserire la spina nella presa di corrente di casa, rivolgersi ad un elettricista qualificato per far sostituire la presa alla parete con una dotata di attacco per la messa a terra. Non annullare la spina di sicurezza della spina con messa a terra. **D3-4-2-1-7a_1_En**

ATTENZIONE
PER EVITARE IL RISCHIO DI SCOSSE ELETTRICHE, NON RIMOVIAMO IL COPRICOLO (O IL RETRO). NON CI SONO PARTI INTERNE LA CUI MANUTENZIONE POSSA ESSERE EFFETTUATA DALL'UTENTE. IN CASO DI NECESSITÀ, RIVOLGERSI ESCLUSIVAMENTE AL PERSONALE DI SERVIZIO QUALIFICATO. **D3-4-2-1_B1_En**

ATTENZIONE
Questo apparecchio non è impermeabile. Per prevenire pericoli di incendio o shock elettrico, non collocare questo apparecchio vicino a contenitori pieni di liquidi (quali vasi da fiori, o simili), e non esporre l'apparecchio a spruzzi, schizzi, pioggia o umidità. **D3-4-2-1-7a_1_En**

ATTENZIONE
Questo apparecchio è dotato di una spina con messa a terra, cioè di una spina con un terzo spinotto (per la messa a terra). Questo tipo di spina si inserisce automaticamente in una presa a tre poli. Se non si riesce ad inserire la spina nella presa di corrente di casa, rivolgersi ad un elettricista qualificato per far sostituire la presa alla parete con una dotata di attacco per la messa a terra. Non annullare la spina di sicurezza della spina con messa a terra. **D3-4-2-1-7a_1_En**

ATTENZIONE
Questo apparecchio non è impermeabile. Per prevenire pericoli di incendio o shock elettrico, non collocare questo apparecchio vicino a contenitori pieni di liquidi (quali vasi da fiori, o simili), e non esporre l'apparecchio a spruzzi, schizzi, pioggia o umidità. **D3-4-2-1-7a_1_En**

ATTENZIONE
Questo apparecchio è dotato di una spina con messa a terra, cioè di una spina con un terzo spinotto (per la messa a terra). Questo tipo di spina si inserisce automaticamente in una presa a tre poli. Se non si riesce ad inserire la spina nella presa di corrente di casa, rivolgersi ad un elettricista qualificato per far sostituire la presa alla parete con una dotata di attacco per la messa a terra. Non annullare la spina di sicurezza della spina con messa a terra. **D3-4-2-1-7a_1_En**

ATTENZIONE
Questo apparecchio non è impermeabile. Per prevenire pericoli di incendio o shock elettrico, non collocare questo apparecchio vicino a contenitori pieni di liquidi (quali vasi da fiori, o simili), e non esporre l'apparecchio a spruzzi, schizzi, pioggia o umidità. **D3-4-2-1-7a_1_En**

ATTENZIONE
Questo apparecchio è dotato di una spina con messa a terra, cioè di una spina con un terzo spinotto (per la messa a terra). Questo tipo di spina si inserisce automaticamente in una presa a tre poli. Se non si riesce ad inserire la spina nella presa di corrente di casa, rivolgersi ad un elettricista qualificato per far sostituire la presa alla parete con una dotata di attacco per la messa a terra. Non annullare la spina di sicurezza della spina con messa a terra. **D3-4-2-1-7a_1_En**

ATTENZIONE
Questo apparecchio non è impermeabile. Per prevenire pericoli di incendio o shock elettrico, non collocare questo apparecchio vicino a contenitori pieni di liquidi (quali vasi da fiori, o simili), e non esporre l'apparecchio a spruzzi, schizzi, pioggia o umidità. **D3-4-2-1-7a_1_En**

ATTENZIONE
Questo apparecchio è dotato di una spina con messa a terra, cioè di una spina con un terzo spinotto (per la messa a terra). Questo tipo di spina si inserisce automaticamente in una presa a tre poli. Se non si riesce ad inserire la spina nella presa di corrente di casa, rivolgersi ad un elettricista qualificato per far sostituire la presa alla parete con una dotata di attacco per la messa a terra. Non annullare la spina di sicurezza della spina con messa a terra. **D3-4-2-1-7a_1_En**

ATTENZIONE
Questo apparecchio non è impermeabile. Per prevenire pericoli di incendio o shock elettrico, non collocare questo apparecchio vicino a contenitori pieni di liquidi (quali vasi da fiori, o simili), e non esporre l'apparecchio a spruzzi, schizzi, pioggia o umidità. **D3-4-2-1-7a_1_En**

ATTENZIONE
Questo apparecchio è dotato di una spina con messa a terra, cioè di una spina con un terzo spinotto (per la messa a terra). Questo tipo di spina si inserisce automaticamente in una presa a tre poli. Se non si riesce ad inserire la spina nella presa di corrente di casa, rivolgersi ad un elettricista qualificato per far sostituire la presa alla parete con una dotata di attacco per la messa a terra. Non annullare la spina di sicurezza della spina con messa a terra. **D3-4-2-1-7a_1_En**

ATTENZIONE
Questo apparecchio non è impermeabile. Per prevenire pericoli di incendio o shock elettrico, non collocare questo apparecchio vicino a contenitori pieni di liquidi (quali vasi da fiori, o simili), e non esporre l'apparecchio a spruzzi, schizzi, pioggia o umidità. **D3-4-2-1-7a_1_En**

ATTENZIONE
Questo apparecchio è dotato di una spina con messa a terra, cioè di una spina con un terzo spinotto (per la messa a terra). Questo tipo di spina si inserisce automaticamente in una presa a tre poli. Se non si riesce ad inserire la spina nella presa di corrente di casa, rivolgersi ad un elettricista qualificato per far sostituire la presa alla parete con una dotata di attacco per la messa a terra. Non annullare la spina di sicurezza della spina con messa a terra. **D3-4-2-1-7a_1_En**

ATTENZIONE
Questo apparecchio non è impermeabile. Per prevenire pericoli di incendio o shock elettrico, non collocare questo apparecchio vicino a contenitori pieni di liquidi (quali vasi da fiori, o simili), e non esporre l'apparecchio a spruzzi, schizzi, pioggia o umidità. **D3-4-2-1-7a_1_En**

ATTENZIONE
Questo apparecchio è dotato di una spina con messa a terra, cioè di una spina con un terzo spinotto (per la messa a terra). Questo tipo di spina si inserisce automaticamente in una presa a tre poli. Se non si riesce ad inserire la spina nella presa di corrente di casa, rivolgersi ad un elettricista qualificato per far sostituire la presa alla parete con una dotata di attacco per la messa a terra. Non annullare la spina di sicurezza della spina con messa a terra. **D3-4-2-1-7a_1_En**

ATTENZIONE
Questo apparecchio non è impermeabile. Per prevenire pericoli di incendio o shock elettrico, non collocare questo apparecchio vicino a contenitori pieni di liquidi (quali vasi da fiori, o simili), e non esporre l'apparecchio a spruzzi, schizzi, pioggia o umidità. **D3-4-2-1-7a_1_En**

ATTENZIONE
Questo apparecchio è dotato di una spina con messa a terra, cioè di una spina con un terzo spinotto (per la messa a terra). Questo tipo di spina si inserisce automaticamente in una presa a tre poli. Se non si riesce ad inserire la spina nella presa di corrente di casa, rivolgersi ad un elettricista qualificato per far sostituire la presa alla parete con una dotata di attacco per la messa a terra. Non annullare la spina di sicurezza della spina con messa a terra. **D3-4-2-1-7a_1_En**

ATTENZIONE
Questo apparecchio non è impermeabile. Per prevenire pericoli di incendio o shock elettrico, non collocare questo apparecchio vicino a contenitori pieni di liquidi (quali vasi da fiori, o simili), e non esporre l'apparecchio a spruzzi, schizzi, pioggia o umidità. **D3-4-2-1-7a_1_En**

ATTENZIONE
Questo apparecchio è dotato di una spina con messa a terra, cioè di una spina con un terzo spinotto (per la messa a terra). Questo tipo di spina si inserisce automaticamente in una presa a tre poli. Se non si riesce ad inserire la spina nella presa di corrente di casa, rivolgersi ad un elettricista qualificato per far sostituire la presa alla parete con una dotata di attacco per la messa a terra. Non annullare la spina di sicurezza della spina con messa a terra. **D3-4-2-1-7a_1_En**

ATTENZIONE
Questo apparecchio non è impermeabile. Per prevenire pericoli di incendio o shock elettrico, non collocare questo apparecchio vicino a contenitori pieni di liquidi (quali vasi da fiori, o simili), e non esporre l'apparecchio a spruzzi, schizzi, pioggia o umidità. **D3-4-2-1-7a_1_En**

ATTENZIONE
Questo apparecchio è dotato di una spina con messa a terra, cioè di una spina con un terzo spinotto (per la messa a terra). Questo tipo di spina si inserisce automaticamente in una presa a tre poli. Se non si riesce ad inserire la spina nella presa di corrente di casa, rivolgersi ad un elettricista qualificato per far sostituire la presa alla parete con una dotata di attacco per la messa a terra. Non annullare la spina di sicurezza della spina con messa a terra. **D3-4-2-1-7a_1_En**

ATTENZIONE
Questo apparecchio non è impermeabile. Per prevenire pericoli di incendio o shock elettrico, non collocare questo apparecchio vicino a contenitori pieni di liquidi (quali vasi da fiori, o simili), e non esporre l'apparecchio a spruzzi, schizzi, pioggia o umidità. **D3-4-2-1-7a_1_En**

ATTENZIONE
Questo apparecchio è dotato di una spina con messa a terra, cioè di una spina con un terzo spinotto (per la messa a terra). Questo tipo di spina si inserisce automaticamente in una presa a tre poli. Se non si riesce ad inserire la spina nella presa di corrente di casa, rivolgersi ad un elettricista qualificato per far sostituire la presa alla parete con una dotata di attacco per la messa a terra. Non annullare la spina di sicurezza della spina con messa a terra. **D3-4-2-1-7a_1_En**

ATTENZIONE
Questo apparecchio non è impermeabile. Per prevenire pericoli di incendio o shock elettrico, non collocare questo apparecchio vicino a contenitori pieni di liquidi (quali vasi da fiori, o simili), e non esporre l'apparecchio a spruzzi, schizzi, pioggia o umidità. **D3-4-2-1-7a_1_En**

ATTENZIONE
Questo apparecchio è dotato di una spina con messa a terra, cioè di una spina con un terzo spinotto (per la messa a terra). Questo tipo di spina si inserisce automaticamente in una presa a tre poli. Se non si riesce ad inserire la spina nella presa di corrente di casa, rivolgersi ad un elettricista qualificato per far sostituire la presa alla parete con una dotata di attacco per la messa a terra. Non annullare la spina di sicurezza della spina con messa a terra. **D3-4-2-1-7a_1_En**

ATTENZIONE
Questo apparecchio non è impermeabile. Per prevenire pericoli di incendio o shock elettrico, non collocare questo apparecchio vicino a contenitori pieni di liquidi (quali vasi da fiori, o simili), e non esporre l'apparecchio a spruzzi, schizzi, pioggia o umidità. **D3-4-2-1-7a_1_En**

ATTENZIONE
Questo apparecchio è dotato di una spina con messa a terra, cioè di una spina con un terzo spinotto (per la messa a terra). Questo tipo di spina si inserisce automaticamente in una presa a tre poli. Se non si riesce ad inserire la spina nella presa di corrente di casa, rivolgersi ad un elettricista qualificato per far sostituire la presa alla parete con una dotata di attacco per la messa a terra. Non annullare la spina di sicurezza della spina con messa a terra. **D3-4-2-1-7a_1_En**

ATTENZIONE
Questo apparecchio non è impermeabile. Per prevenire pericoli di incendio o shock elettrico, non collocare questo apparecchio vicino a contenitori pieni di liquidi (quali vasi da fiori, o simili), e non esporre l'apparecchio a spruzzi, schizzi, pioggia o umidità. **D3-4-2-1-7a_1_En**

ATTENZIONE
Questo apparecchio è dotato di una spina con messa a terra, cioè di una spina con un terzo spinotto (per la messa a terra). Questo tipo di spina si inserisce automaticamente in una presa a tre poli. Se non si riesce ad inserire la spina nella presa di corrente di casa, rivolgersi ad un elettricista qualificato per far sostituire la presa alla parete con una dotata di attacco per la messa a terra. Non annullare la spina di sicurezza della spina con messa a terra. **D3-4-2-1-7a_1_En**

ATTENZIONE
Questo apparecchio non è impermeabile. Per prevenire pericoli di incendio o shock elettrico, non collocare questo apparecchio vicino a contenitori pieni di liquidi (quali vasi da fiori, o simili), e non esporre l'apparecchio a spruzzi, schizzi, pioggia o umidità. **D3-4-2-1-7a_1_En**

ATTENZIONE
Questo apparecchio è dotato di una spina con messa a terra, cioè di una spina con un terzo spinotto (per la messa a terra). Questo tipo di spina si inserisce automaticamente in una presa a tre poli. Se non si riesce ad inserire la spina nella presa di corrente di casa, rivolgersi ad un elettricista qualificato per far sostituire la presa alla parete con una dotata di attacco per la messa a terra. Non annullare la spina di sicurezza della spina con messa a terra. **D3-4-2-1-7a_1_En**

ATTENZIONE
Questo apparecchio non è impermeabile. Per prevenire pericoli di incendio o shock elettrico, non collocare questo apparecchio vicino a contenitori pieni di liquidi (quali vasi da fiori, o simili), e non esporre l'apparecchio a spruzzi, schizzi, pioggia o umidità. **D3-4-2-1-7a_1_En**

ATTENZIONE
Questo apparecchio è dotato di una spina con messa a terra, cioè di una spina con un terzo spinotto (per la messa a terra). Questo tipo di spina si inserisce automaticamente in una presa a tre poli. Se non si riesce ad inserire la spina nella presa di corrente di casa, rivolgersi ad un elettricista qualificato per far sostituire la presa alla parete con una dotata di attacco per la messa a terra. Non annullare la spina di sicurezza della spina con messa a terra. **D3-4-2-1-7a_1_En**

ATTENZIONE
Questo apparecchio non è impermeabile. Per prevenire pericoli di incendio o shock elettrico, non collocare questo apparecchio vicino a contenitori pieni di liquidi (quali vasi da fiori, o simili), e non esporre l'apparecchio a spruzzi, schizzi, pioggia o umidità. **D3-4-2-1-7a_1_En**

ATTENZIONE
Questo apparecchio è dotato di una spina con messa a terra, cioè di una spina con un terzo spinotto (per la messa a terra). Questo tipo di spina si inserisce automaticamente in una presa a tre poli. Se non si riesce ad inserire la spina nella presa di corrente di casa, rivolgersi ad un elettricista qualificato per far sostituire la presa alla parete con una dotata di attacco per la messa a terra. Non annullare la spina di sicurezza della spina con messa a terra. **D3-4-2-1-7a_1_En**

ATTENZIONE
Questo apparecchio non è impermeabile. Per prevenire pericoli di incendio o shock elettrico, non collocare questo apparecchio vicino a contenitori pieni di liquidi (quali vasi da fiori, o simili), e non esporre l'apparecchio a spruzzi, schizzi, pioggia o umidità. **D3-4-2-1-7a_1_En**

ATTENZIONE
Questo apparecchio è dotato di una spina con messa a terra, cioè di una spina con un terzo spinotto (per la messa a terra). Questo tipo di spina si inserisce automaticamente in una presa a tre poli. Se non si riesce ad inserire la spina nella presa di corrente di casa, rivolgersi ad un elettricista qualificato per far sostituire la presa alla parete con una dotata di attacco per la messa a terra. Non annullare la spina di sicurezza della spina con messa a terra. **D3-4-2-1-7a_1_En**

ATTENZIONE
Questo apparecchio non è impermeabile. Per prevenire pericoli di incendio o shock elettrico, non collocare questo apparecchio vicino a contenitori pieni di liquidi (quali vasi da fiori, o simili), e non esporre l'apparecchio a spruzzi, schizzi, pioggia o umidità. **D3-4-2-1-7a_1_En**

ATTENZIONE
Questo apparecchio è dotato di una spina con messa a terra, cioè di una spina con un terzo spinotto (per la messa a terra). Questo tipo di spina si inserisce automaticamente in una presa a tre poli. Se non si riesce ad inserire la spina nella presa di corrente di casa, rivolgersi ad un elettricista qualificato per far sostituire la presa alla parete con una dotata di attacco per la messa a terra. Non annullare la spina di sicurezza della spina con messa a terra. **D3-4-2-1-7a_1_En**

ATTENZIONE
Questo apparecchio non è impermeabile. Per prevenire pericoli di incendio o shock elettrico, non collocare questo apparecchio vicino a contenitori pieni di liquidi (quali vasi da fiori, o simili), e non esporre l'apparecchio a spruzzi, schizzi, pioggia o umidità. **D3-4-2-1-7a_1_En**

ATTENZIONE
Questo apparecchio è dotato di una spina con messa a terra, cioè di una spina con un terzo spinotto (per la messa a terra). Questo tipo di spina si inserisce automaticamente in una presa a tre poli. Se non si riesce ad inserire la spina nella presa di corrente di casa, rivolgersi ad un elettricista qualificato per far sostituire la presa alla parete con una dotata di attacco per la messa a terra. Non annullare la spina di sicurezza della spina con messa a terra. **D3-4-2-1-7a_1_En**

ATTENZIONE
Questo apparecchio non è impermeabile. Per prevenire pericoli di incendio o shock elettrico, non collocare questo apparecchio vicino a contenitori pieni di liquidi (quali vasi da fiori, o simili), e non esporre l'apparecchio a spruzzi, schizzi, pioggia o umidità. **D3-4-2-1-7a_1_En**

ATTENZIONE
Questo apparecchio è dotato di una spina con messa a terra, cioè di una spina con un terzo spinotto (per la messa a terra). Questo tipo di spina si inserisce automaticamente in una presa a tre poli. Se non si riesce ad inserire la spina nella presa di corrente di casa, rivolgersi ad un elettricista qualificato per far sostituire la presa alla parete con una dotata di attacco per la messa a terra. Non annullare la spina di sicurezza della spina con messa a terra. **D3-4-2-1-7a_1_En**

ATTENZIONE
Questo apparecchio non è impermeabile. Per prevenire pericoli di incendio o shock elettrico, non collocare questo apparecchio vicino a contenitori pieni di liquidi (quali vasi da fiori, o simili), e non esporre l'apparecchio a spruzzi, schizzi, pioggia o umidità. **D3-4-2-1-7a_1_En**

ATTENZIONE
Questo apparecchio è dotato di una spina con messa a terra, cioè di una spina con un terzo spinotto (per la messa a terra). Questo tipo di spina si inserisce automaticamente in una presa a tre poli. Se non si riesce ad inserire la spina nella presa di corrente di casa, rivolgersi ad un elettricista qualificato per far sostituire la presa alla parete con una dotata di attacco per la messa a terra. Non annullare la spina di sicurezza della spina con messa a terra. **D3-4-2-1-7a_1_En**

ATTENZIONE
Questo apparecchio non è impermeabile. Per prevenire pericoli di incendio o shock elettrico, non collocare questo apparecchio vicino a contenitori pieni di liquidi (quali vasi da fiori, o simili), e non esporre l'apparecchio a spruzzi, schizzi, pioggia o umidità. **D3**

