



中认信通
CHINA CERTIFICATION ICT CO., LTD (DONGGUAN)



TEST REPORT

Applicant: Fujian Newland Payment Technology Co.,Ltd.

Address: No. B602, Building #1, Haixia Jingmao Plaza, Fuzhou Bonded Area
350015, Fuzhou, Fujian, China

FCC ID: 2AM6U-NA750

Product Name: POS Terminal

**Standard(s): 47 CFR Part 15, Subpart C(15.225)
ANSI C63.10-2013**

The above equipment has been tested and found compliant with the requirement of the relative standards by China Certification ICT Co., Ltd (Dongguan)

Report Number: CR230631809-00D

Date Of Issue: 2023/7/20

Reviewed By: Julie Tan

Julie Tan

Title: RF Engineer

Approved By: Sun Zhong

Sun Zhong

Title: Manager

Test Laboratory: China Certification ICT Co., Ltd (Dongguan)

No. 113, Pingkang Road, Dalang Town, Dongguan,
Guangdong, China
Tel: +86-769-82016888

Test Facility

The Test site used by China Certification ICT Co., Ltd (Dongguan) to collect test data is located on the No. 113, Pingkang Road, Dalang Town, Dongguan, Guangdong, China.

The lab has been recognized as the FCC accredited lab under the KDB 974614 D01 and is listed in the FCC Public Access Link (PAL) database, FCC Registration No. : 442868, the FCC Designation No. : CN1314.

The lab has been recognized by Innovation, Science and Economic Development Canada to test to Canadian radio equipment requirements, the CAB identifier: CN0123.

Declarations

China Certification ICT Co., Ltd (Dongguan) is not responsible for the authenticity of any test data provided by the applicant. Data included from the applicant that may affect test results are marked with a triangle symbol “▲”. Customer model name, addresses, names, trademarks etc. are not considered data.

Unless otherwise stated the results shown in this test report refer only to the sample(s) tested.

This report cannot be reproduced except in full, without prior written approval of the Company.

This report is valid only with a valid digital signature. The digital signature may be available only under the Adobe software above version 7.0.

This report may contain data that are not covered by the accreditation scope and shall be marked with an asterisk “★”.

CONTENTS

TEST FACILITY	2
DECLARATIONS.....	2
DOCUMENT REVISION HISTORY	5
1. GENERAL INFORMATION	6
1.1 PRODUCT DESCRIPTION FOR EQUIPMENT UNDER TEST (EUT)	6
1.2 DESCRIPTION OF TEST CONFIGURATION.....	7
1.2.2 Support Equipment List and Details	7
1.2.3 Support Cable List and Details	7
1.2.4 Block Diagram of Test Setup.....	7
1.3 MEASUREMENT UNCERTAINTY	9
2. SUMMARY OF TEST RESULTS	10
3. REQUIREMENTS AND TEST PROCEDURES	11
3.1 AC LINE CONDUCTED EMISSIONS.....	11
3.1.1 Applicable Standard.....	11
3.1.2 EUT Setup.....	12
3.1.3 EMI Test Receiver Setup	12
3.1.4 Test Procedure	13
3.1.5 Corrected Amplitude & Margin Calculation.....	13
3.2 RADIATED EMISSIONS	14
3.2.1 Applicable Standard.....	14
3.2.2 EUT Setup.....	14
3.2.3 EMI Test Receiver & Spectrum Analyzer Setup	14
3.2.4 Corrected Amplitude & Margin Calculation.....	15
3.3 20 DB EMISSION BANDWIDTH:.....	16
3.3.1 Applicable Standard.....	16
3.3.2 EUT Setup.....	16
3.3.3 Test Procedure	16
3.4 FREQUENCY STABILITY.....	17
3.4.1 Applicable Standard.....	17
3.4.2 EUT Setup.....	17
3.4.3 Test Procedure	17
3.5 ANTENNA REQUIREMENT.....	18
3.5.1 Applicable Standard.....	18
3.5.2 Judgment.....	18
4. TEST DATA AND RESULTS	19
4.1 AC LINE CONDUCTED EMISSIONS.....	19
4.2 RADIATION SPURIOUS EMISSIONS	22
4.3 20 DB EMISSION BANDWIDTH	34
4.4 FREQUENCY STABILITY.....	36

5. RF EXPOSURE EVALUATION37
APPLICABLE STANDARD.....37

DOCUMENT REVISION HISTORY

Revision Number	Report Number	Description of Revision	Date of Revision
1.0	CR230631809-00D	Original Report	2023/7/20

1. GENERAL INFORMATION

1.1 Product Description for Equipment under Test (EUT)

EUT Name:	POS Terminal
EUT Model:	N750
Operation Frequency:	13.56 MHz
Modulation Type:	ASK
Rated Input Voltage:	DC 5V from adapter or DC 3.8V from battery
Serial Number:	26JR-4 (Sample 1#: For Conducted Emissions Test) 26JR-6 (Sample 2#:For Radiated Test)
EUT Received Date:	2023/6/6
EUT Received Status:	Good
<p>Note: Conducted emissions test only performed with Sample 1# + Battery 1# mode since it is the worst case per test for BLE report. Spurious Emissions test only performed with Sample 2# + Battery 1# mode since it is the worst case per test for BLE report.</p>	

EUT Configuration Detail

Configuration	Description	SN
Sample 1#	with a scanning head	NDA400000075
Sample 2#	without a scanning head	NDA400000074

Antenna Information Detail ▲ :

Antenna Type	input impedance (Ohm)	Frequency Range	Antenna Gain
Loop	50	13.56MHz	Unknown

Accessory Information:

Accessory Description	Manufacturer	Model	Parameter
Adapter	SHENZHEN HONOR ELECTRONIC CO.,LTD.	ADS-12B-06 05010E	Input: 100-240Vac,50/60Hz;Max 0.3A Output: 5Vdc,2A,10W
Battery 1#	Guangdong Fenghua New Energy Co.,Ltd	NL3836A	Rated Voltage:3.8V Rated Capacity:3600mAh/13.68Wh
Battery 2#	Guangdong Fenghua New Energy Co.,Ltd	NL3853A	Rated Voltage:3.8V Rated Capacity:5200mAh/19.76Wh

1.2 Description of Test Configuration

1.2.1 EUT Operation Condition:

EUT Operation Mode:	The system was configured for testing in Engineering Mode, which was provided by the manufacturer.
Equipment Modifications:	No
EUT Exercise Software:	No
Engineering Mode was provided by manufacturer ▲. The maximum power was configured default setting.	

1.2.2 Support Equipment List and Details

Manufacturer	Description	Model	Serial Number
Unknown	NFC Card	Unknown	Unknown

1.2.3 Support Cable List and Details

Cable Description	Shielding Type	Ferrite Core	Length (m)	From Port	To
/	/	/	/	/	/

1.2.4 Block Diagram of Test Setup

AC line conducted emissions:

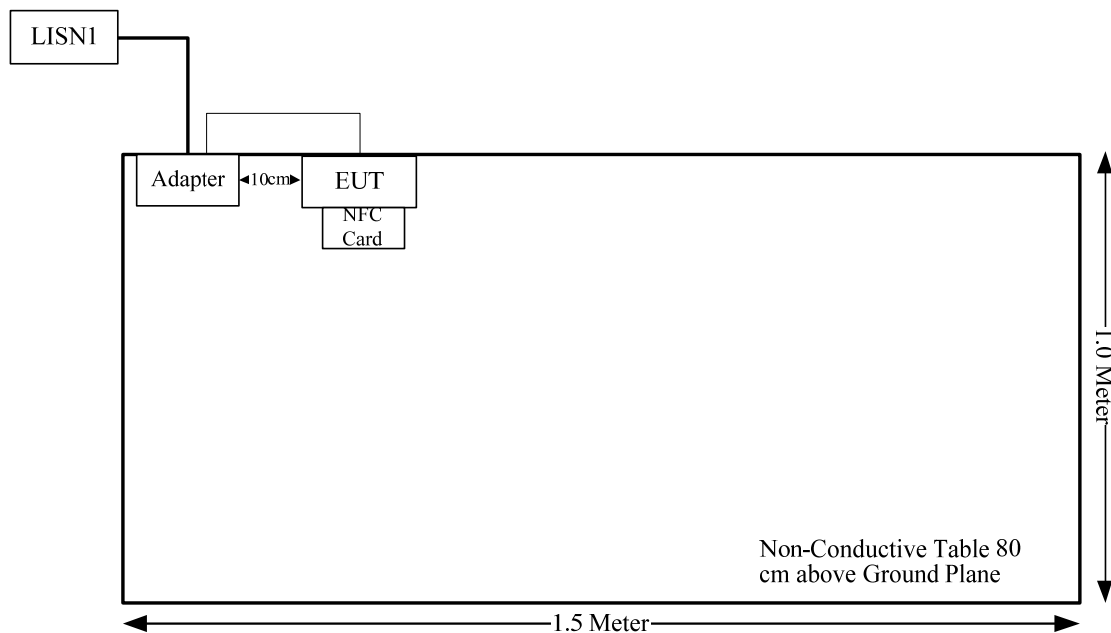

Spurious Emissions:

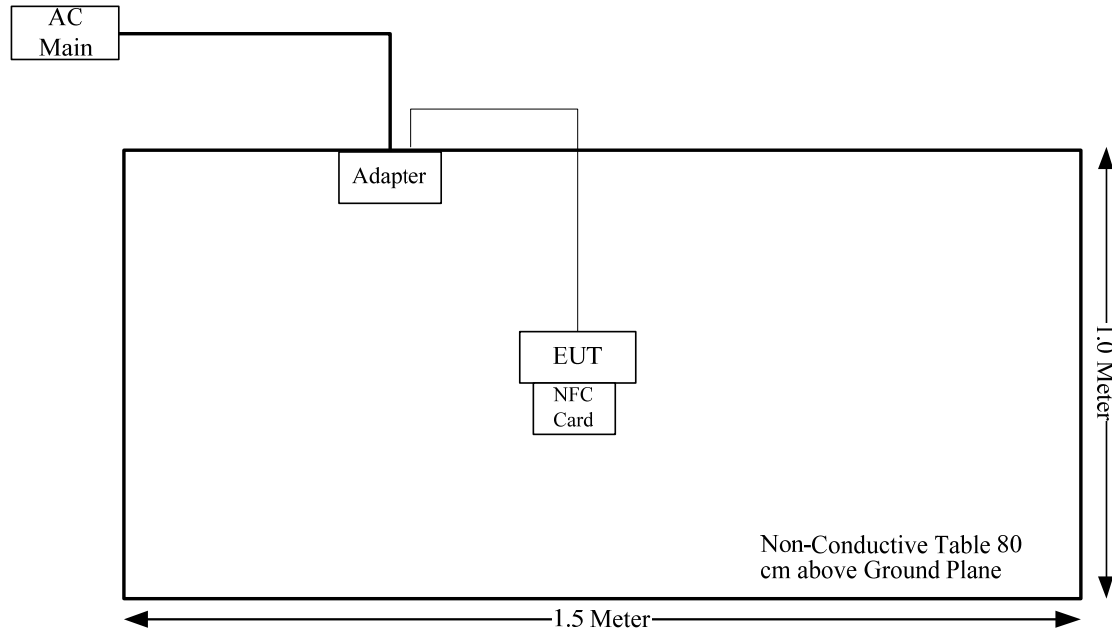

1.3 Measurement Uncertainty

Otherwise required by the applicant or Product Regulations, Decision Rule in this report did not consider the uncertainty. The extended uncertainty given in this report is obtained by combining the standard uncertainty times the coverage factor K with the 95% confidence interval.

Parameter	Measurement Uncertainty
Occupied Channel Bandwidth	±5 %
Unwanted Emissions, radiated	30M~200MHz: 4.15 dB, 200M~1GHz: 5.61 dB, 1G~6GHz: 5.14 dB, 6G~18GHz: 5.93 dB, 18G~26.5G: 5.47 dB, 26.5G~40G: 5.63 dB
Temperature	±1 °C
Humidity	±5%
DC and low frequency voltages	±0.4%
Duty Cycle	1%
AC Power Lines Conducted Emission	2.8 dB (150 kHz to 30 MHz)

2. SUMMARY OF TEST RESULTS

FCC Rules	Description of Test	Result
FCC§15.203	Antenna Requirement	Compliant
FCC§15.207 (a)	Conducted Emissions	Compliant
§15.225 §15.209 §15.205	Radiated Emission Test	Compliant
§15.225(e)	Frequency Stability	Compliant
§15.215(c)	20 dB Bandwidth	Compliant
§1.1310 & §2.1093	RF Exposure	Compliant

3. REQUIREMENTS AND TEST PROCEDURES

3.1 AC Line Conducted Emissions

3.1.1 Applicable Standard

FCC§15.207(a).

(a) Except as shown in paragraphs (b) and (c) of this section, for an intentional radiator that is designed to be connected to the public utility (AC) power line, the radio frequency voltage that is conducted back onto the AC power line on any frequency or frequencies, within the band 150 kHz to 30 MHz, shall not exceed the limits in the following table, as measured using a 50 μ H/50 ohms line impedance stabilization network (LISN). Compliance with the provisions of this paragraph shall be based on the measurement of the radio frequency voltage between each power line and ground at the power terminal. The lower limit applies at the boundary between the frequency ranges.

Frequency of emission (MHz)	Conducted limit (dB μ V)	
	Quasi-peak	Average
0.15-0.5	66 to 56*	56 to 46*
0.5-5	56	46
5-30	60	50

*Decreases with the logarithm of the frequency.

(b) The limit shown in paragraph (a) of this section shall not apply to carrier current systems operating as intentional radiators on frequencies below 30 MHz. In lieu thereof, these carrier current systems shall be subject to the following standards:

(1) For carrier current system containing their fundamental emission within the frequency band 535-1705 kHz and intended to be received using a standard AM broadcast receiver: no limit on conducted emissions.

(2) For all other carrier current systems: 1000 μ V within the frequency band 535-1705 kHz, as measured using a 50 μ H/50 ohms LISN.

(3) Carrier current systems operating below 30 MHz are also subject to the radiated emission limits in §15.205, §15.209, §15.221, §15.223, or §15.227, as appropriate.

(c) Measurements to demonstrate compliance with the conducted limits are not required for devices which only employ battery power for operation and which do not operate from the AC power lines or contain provisions for operation while connected to the AC power lines. Devices that include, or make provisions for, the use of battery chargers which permit operating while charging, AC adapters or battery eliminators or that connect to the AC power lines indirectly, obtaining their power through another device which is connected to the AC power lines, shall be tested to demonstrate compliance with the conducted limits.

3.1.2 EUT Setup

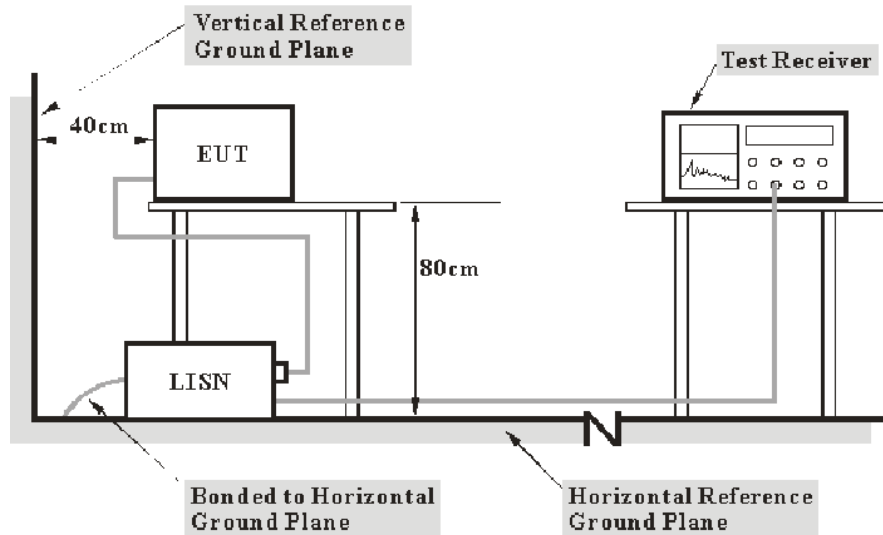

- Note: 1. Support units were connected to second LISN.
 2. Both of LISNs (AMN) 80 cm from EUT and at the least 80 cm from other units and other metal planes support units.

The setup of EUT is according with per ANSI C63.10-2013 measurement procedure. The specification used was with the FCC Part 15.207 limits.

The spacing between the peripherals was 10 cm.

The adapter or EUT was connected to the main LISN with a 120 V/60 Hz AC power source.

3.1.3 EMI Test Receiver Setup

The EMI test receiver was set to investigate the spectrum from 150 kHz to 30 MHz.

During the conducted emission test, the EMI test receiver was set with the following configurations:

Frequency Range	IF B/W
150 kHz – 30 MHz	9 kHz

3.1.4 Test Procedure

During the conducted emission test, the adapter was connected to the outlet of the LISN.

The frequency and amplitude of the six highest ac power-line conducted emissions relative to the limit, measured over all the current-carrying conductors of the EUT power cords, and the operating frequency or frequency to which the EUT is tuned (if appropriate), should be reported, unless such emissions are more than 20 dB below the limit. AC power-line conducted emissions measurements are to be separately carried out only on each of the phase (“hot”) line(s) and (if used) on the neutral line(s), but not on the ground [protective earth] line(s). If less than six emission frequencies are within 20 dB of the limit, then the noise level of the measuring instrument at representative frequencies should be reported. The specific conductor of the power-line cord for each of the reported emissions should be identified. Measure the six highest emissions with respect to the limit on each current-carrying conductor of each power cord associated with the EUT (but not the power cords of associated or peripheral equipment that are part of the test configuration). Then, report the six highest emissions with respect to the limit from among all the measurements identifying the frequency and specific current-carrying conductor identified with the emission. The six highest emissions should be reported for each of the current-carrying conductors, or the six highest emissions may be reported over all the current-carrying conductors.

According FCC publication number 174176, for a device with a permanent antenna operating at or below 30 MHz, the measurements done with a suitable dummy load, in lieu of the permanent antenna under the following conditions: (1) perform the AC line conducted tests with the permanent antenna to determine compliance with the Section 15.207 limits outside the transmitter's fundamental emission band; (2) retest with a dummy load in lieu of the permanent antenna to determine compliance with the Section 15.207 limits within the transmitter's fundamental emission band.

3.1.5 Corrected Amplitude & Margin Calculation

The basic equation is as follows:

Result = Reading + Factor

Factor = attenuation caused by cable loss + voltage division factor of AMN

The “**Margin**” column of the following data tables indicates the degree of compliance within the applicable limit. The equation for margin calculation is as follows:

Margin = Limit – Result

3.2 Radiated Emissions

3.2.1 Applicable Standard

As per FCC Part 15.225

- The field strength of any emissions within the band 13.553–13.567 MHz shall not exceed 15,848 microvolts/meter at 30 meters.
- Within the bands 13.410–13.553 MHz and 13.567–13.710 MHz, the field strength of any emissions shall not exceed 334 microvolts/meter at 30 meters.
- Within the bands 13.110–13.410 MHz and 13.710–14.010 MHz the field strength of any emissions shall not exceed 106 microvolts/meter at 30 meters.
- The field strength of any emissions appearing outside of the 13.110–14.010 MHz band shall not exceed the general radiated emission limits in §15.209.

3.2.2 EUT Setup

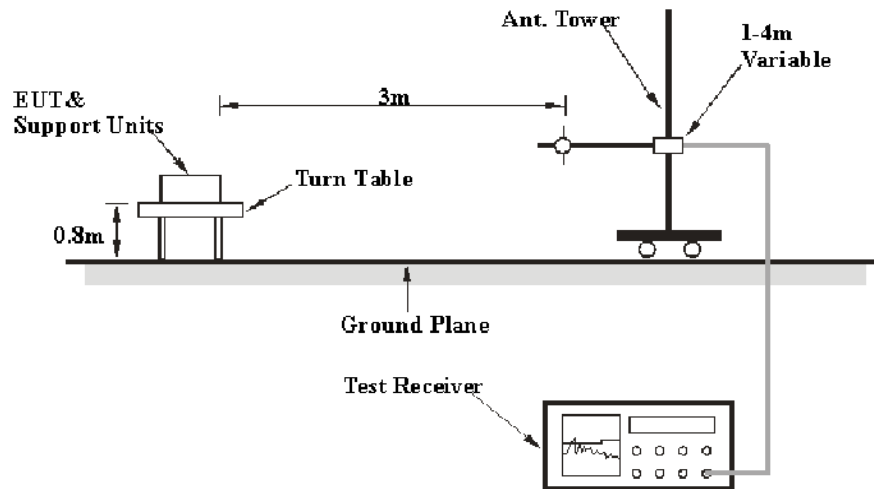

The radiated emission tests were performed in the 3-meter chamber test site, using the setup accordance with the ANSI C63.10-2013.

The spacing between the peripherals was 10 cm.

3.2.3 EMI Test Receiver & Spectrum Analyzer Setup

The system was investigated from 9 kHz to 1 GHz.

During the radiated emission test, the EMI test Receiver was set with the following configurations:

Frequency Range	RBW	Video B/W	Detector
9 kHz – 150 kHz	200 Hz	1 kHz	QP
150 kHz – 30 MHz	9 kHz	30 kHz	QP
30 MHz – 1000 MHz	120 kHz	300 kHz	QP

If the maximized peak measured value complies with the limit, then it is unnecessary to perform an QP measurement

3.2.4 Corrected Amplitude & Margin Calculation

The basic equation is as follows:

Result = Reading + Factor

Factor = Antenna Factor + Cable Loss- Amplifier Gain

The “**Margin**” column of the following data tables indicates the degree of compliance within the applicable limit. The equation for margin calculation is as follows:

Margin = Limit – Result

3.3 20 dB Emission Bandwidth:

3.3.1 Applicable Standard

FCC §15.215

Intentional radiators operating under the alternative provisions to the general emission limits, as contained in §15.217 through § 15.257 and in Subpart E of this part, must be designed to ensure that the 20 dB bandwidth of the emission, or whatever bandwidth may otherwise be specified in the specific rule section under which the equipment operates, is contained within the frequency band designated in the rule section under which the equipment is operated. The requirement to contain the designated bandwidth of the emission within the specified frequency band includes the effects from frequency sweeping, frequency hopping and other modulation techniques that may be employed as well as the frequency stability of the transmitter over expected variations in temperature and supply voltage. If a frequency stability is not specified in the regulations, it is recommended that the fundamental emission be kept within at least the central 80% of the permitted band in order to minimize the possibility of out-of band operation.

3.3.2 EUT Setup

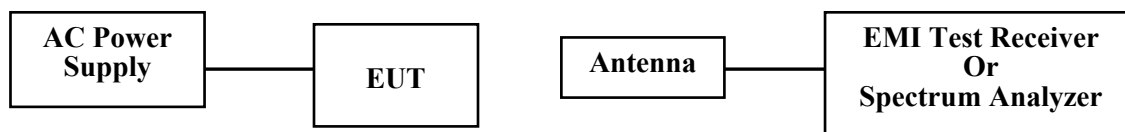

3.3.3 Test Procedure

1. Check the calibration of the measuring instrument using either an internal calibrator or a known signal from an external generator.
2. Position the EUT on the test table without connection to measurement instrument. Turn on the EUT. Then set it to any one convenient frequency within its operating range. Set a reference level on the measuring instrument equal to the highest peak value.
3. Measure the frequency difference of two frequencies that were attenuated 20 dB from the reference level. Record the frequency difference as the emission bandwidth.

3.4 Frequency Stability

3.4.1 Applicable Standard

As per FCC Part 15.225:

The frequency tolerance of the carrier signal shall be maintained within $\pm 0.01\%$ of the operating frequency over a temperature variation of -20 degrees to $+50$ degrees C at normal supply voltage, and for a variation in the primary supply voltage from 85% to 115% of the rated supply voltage at a temperature of 20 degrees C. For battery operated equipment, the equipment tests shall be performed using a new battery.

3.4.2 EUT Setup

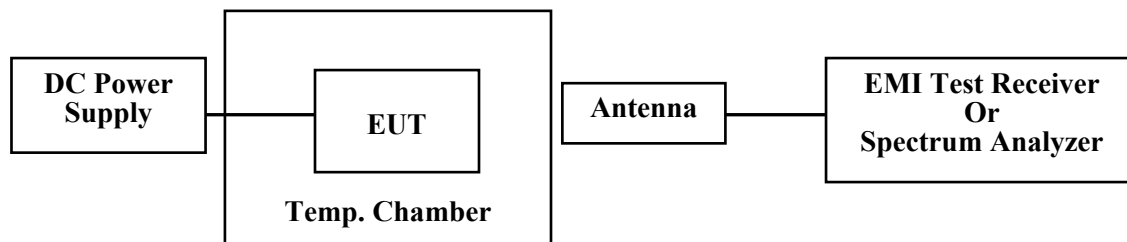

3.4.3 Test Procedure

Frequency Stability vs. Temperature: The equipment under test was connected to an external DC power.

The EUT was placed inside the temperature chamber.

After the temperature stabilized for approximately 20 minutes, the frequency output was recorded from the Spectrum Analyzer.

Frequency Stability vs. Voltage: An external variable DC power supply Source. The voltage was set to the end point of the battery. The output frequency was recorded for each voltage.

3.5 Antenna Requirement

3.5.1 Applicable Standard

FCC §15.203

An intentional radiator shall be designed to ensure that no antenna other than that furnished by the responsible party shall be used with the device. The use of a permanently attached antenna or of an antenna that uses a unique coupling to the intentional radiator shall be considered sufficient to comply with the provisions of this section. The manufacturer may design the unit so that a broken antenna can be replaced by the user, but the user of a standard antenna jack or electrical connector is prohibited. The structure and application of the EUT were analyzed to determine compliance with section §15.203 of the rules. §15.203 state that the subject device must meet the following criteria:

- a. Antenna must be permanently attached to the unit.
- b. Antenna must use a unique type of connector to attach to the EUT.
- c. Unit must be professionally installed, and installer shall be responsible for verifying that the correct antenna is employed with the unit.

3.5.2 Judgment

Please refer to the Antenna Information detail in Section 1.

4. TEST DATA AND RESULTS

4.1 AC Line Conducted Emissions

Serial Number:	26JR-4	Test Date:	2023/06/13
Test Site:	CE	Test Mode:	Transmitting
Tester:	David Huang	Test Result:	Pass

Environmental Conditions:

Temperature: (°C)	23.8	Relative Humidity: (%)	53	ATM Pressure: (kPa)	100.2
----------------------	------	------------------------------	----	------------------------	-------

Test Equipment List and Details:

Manufacturer	Description	Model	Serial Number	Calibration Date	Calibration Due Date
R&S	LISN	ENV216	101134	2023/03/31	2024/03/30
R&S	EMI Test Receiver	ESR3	102726	2022/07/15	2023/07/14
MICRO-COAX	Coaxial Cable	UTIFLEX	C-0200-01	2022/08/07	2023/08/06
Audix	Test Software	E3	190306 (V9)	N/A	N/A

* Statement of Traceability: China Certification ICT Co., Ltd (Dongguan) attests that all calibrations have been performed, traceable to National Primary Standards and International System of Units (SI).

Line:

Test Mode: Transmitting

Port: Line

Note:

Date: 2023-06-13

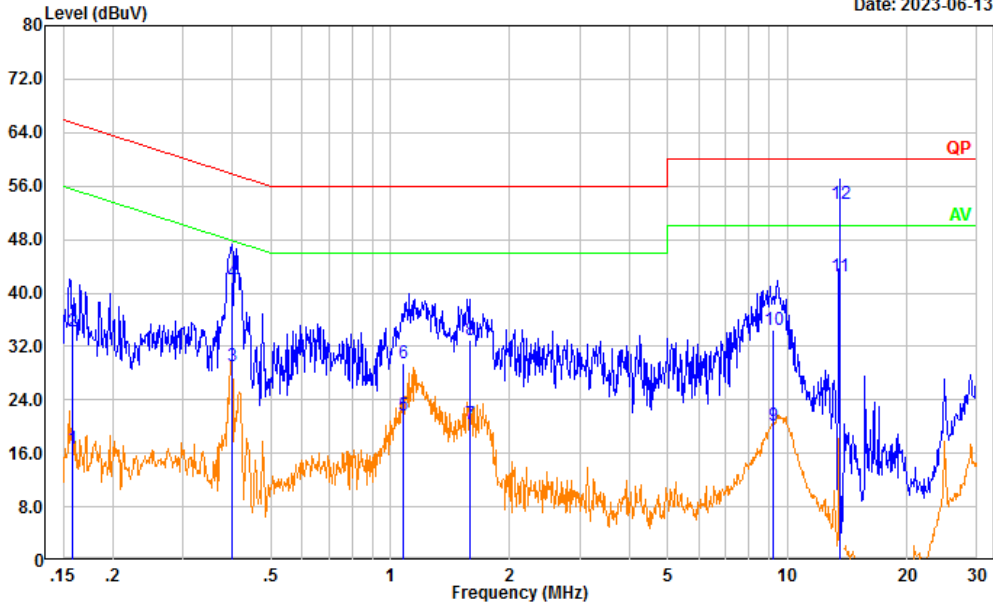

No.	Frequency (MHz)	Reading (dBμV)	Factor (dB)	Result (dBμV)	Limit (dBμV)	Margin (dB)	Detector
1	0.158	7.07	9.61	16.68	55.57	38.89	Average
2	0.158	24.55	9.61	34.16	65.57	31.41	QP
3	0.398	19.49	9.61	29.10	47.89	18.79	Average
4	0.398	32.01	9.61	41.62	57.89	16.27	QP
5	1.077	12.01	9.62	21.63	46.00	24.37	Average
6	1.077	19.95	9.62	29.57	56.00	26.43	QP
7	1.584	10.72	9.63	20.35	46.00	25.65	Average
8	1.584	23.42	9.63	33.05	56.00	22.95	QP
9	9.228	10.46	9.67	20.13	50.00	29.87	Average
10	9.228	24.75	9.67	34.42	60.00	25.58	QP
11	13.559	32.71	9.68	42.39	50.00	7.61	Average
12	13.559	43.63	9.68	53.31	60.00	6.69	QP

Neutral:

Test Mode: Transmitting
 Port: neutral
 Note:

Date: 2023-06-13

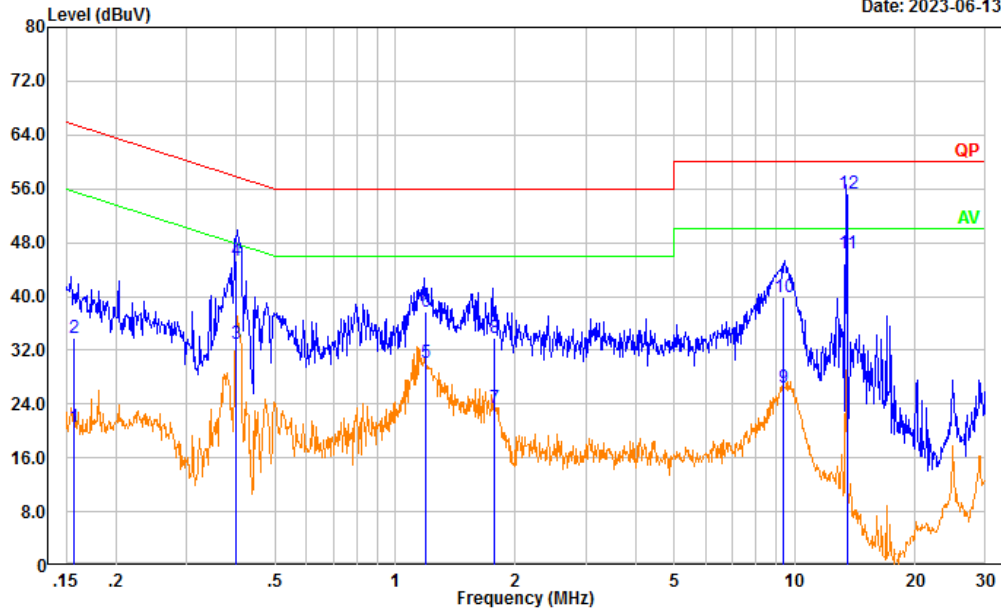

No.	Frequency (MHz)	Reading (dBμV)	Factor (dB)	Result (dBμV)	Limit (dBμV)	Margin (dB)	Detector
1	0.157	11.07	9.61	20.68	55.63	34.95	Average
2	0.157	24.31	9.61	33.92	65.63	31.71	QP
3	0.400	23.41	9.61	33.02	47.85	14.83	Average
4	0.400	35.75	9.61	45.36	57.85	12.49	QP
5	1.190	20.60	9.62	30.22	46.00	15.78	Average
6	1.190	28.01	9.62	37.63	56.00	18.37	QP
7	1.766	13.73	9.63	23.36	46.00	22.64	Average
8	1.766	24.24	9.63	33.87	56.00	22.13	QP
9	9.400	16.75	9.67	26.42	50.00	23.58	Average
10	9.400	30.30	9.67	39.97	60.00	20.03	QP
11	13.559	36.81	9.68	46.49	50.00	3.51	Average
12	13.559	45.68	9.68	55.36	60.00	4.64	QP

4.2 Radiation Spurious Emissions

Serial Number:	26JR-6	Test Date:	2023/6/28
Test Site:	966-2	Test Mode:	Transmitting
Tester:	Carl Xue	Test Result:	Pass

Environmental Conditions:

Temperature: (°C)	27	Relative Humidity: (%)	70	ATM Pressure: (kPa)	100.4
----------------------	----	---------------------------	----	---------------------------	-------

Test Equipment List and Details:

Manufacturer	Description	Model	Serial Number	Calibration Date	Calibration Due Date
EMCO	Passive Loop Antenna	6512	9706-1209	2023/2/15	2026/2/14
Sunol Sciences	Antenna	JB6	A082520-5	2020/10/19	2023/10/18
R&S	EMI Test Receiver	ESR3	102724	2022/7/15	2023/7/14
TIMES MICROWAVE	Coaxial Cable	LMR-600-UltraFlex	C-0470-02	2022/7/17	2023/7/16
TIMES MICROWAVE	Coaxial Cable	LMR-600-UltraFlex	C-0780-01	2022/7/17	2023/7/16
Sonoma	Amplifier	310N	186165	2022/7/17	2023/7/16
Audix	Test Software	E3	201021 (V9)	N/A	N/A

* Statement of Traceability: China Certification ICT Co., Ltd (Dongguan) attests that all calibrations have been performed, traceable to National Primary Standards and International System of Units (SI).

Test Data:

After pre-scan in the X, Y and Z axes of orientation, the worst case is below:

**9kHz~30MHz:
Ground-parallel:**

Test Mode: Transmitting

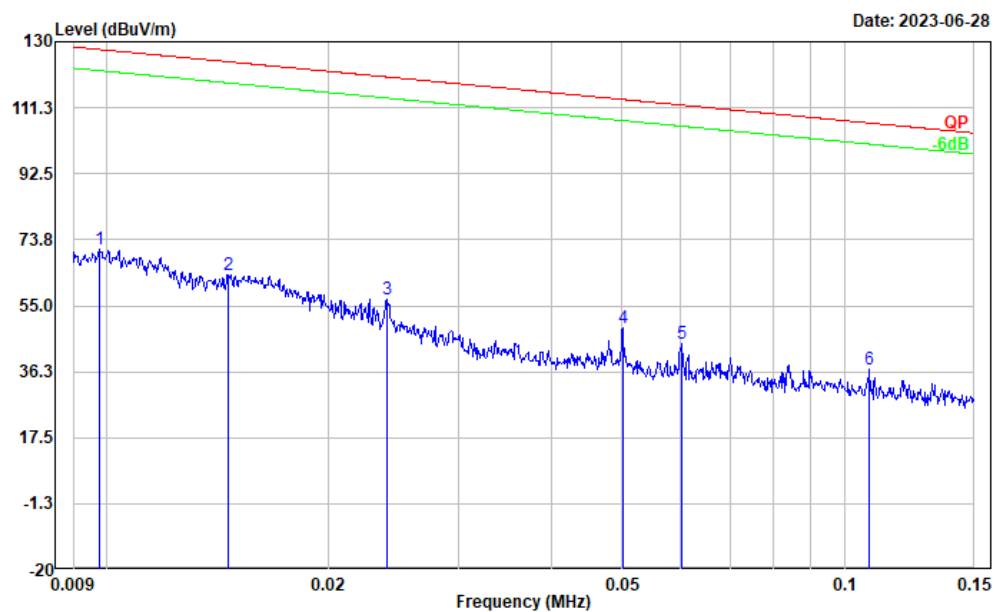

No.	Frequency (MHz)	Reading (dBμV)	Factor (dB/m)	Result (dBμV/m)	Limit (dBμV/m)	Margin (dB)	Detector
1	0.010	12.71	58.28	70.99	127.81	56.82	Peak
2	0.015	9.91	53.99	63.90	124.32	60.42	Peak
3	0.024	9.14	47.82	56.96	120.02	63.06	Peak
4	0.050	6.29	42.26	48.55	113.61	65.06	Peak
5	0.060	4.22	40.01	44.23	112.00	67.77	Peak
6	0.108	1.94	34.78	36.72	106.92	70.20	Peak

Test Mode: Transmitting

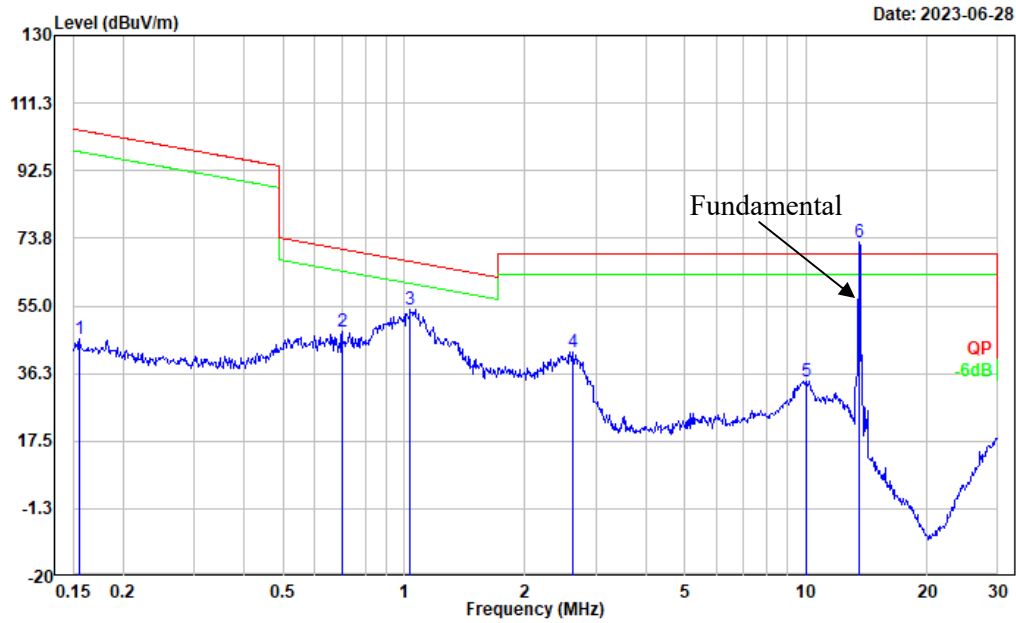

No.	Frequency (MHz)	Reading (dB μ V)	Factor (dB/m)	Result (dB μ V/m)	Limit (dB μ V/m)	Margin (dB)	Detector
1	0.156	13.76	32.10	45.86	103.76	57.90	Peak
2	0.701	28.11	19.63	47.74	70.62	22.88	Peak
3	1.037	37.38	16.65	54.03	67.15	13.12	Peak
4	2.622	32.87	9.42	42.29	69.54	27.25	Peak
5	10.019	29.84	4.39	34.23	69.54	35.31	Peak
6	13.551	79.02	-6.36	72.66	69.54	-3.12	Peak

Test Mode: Transmitting

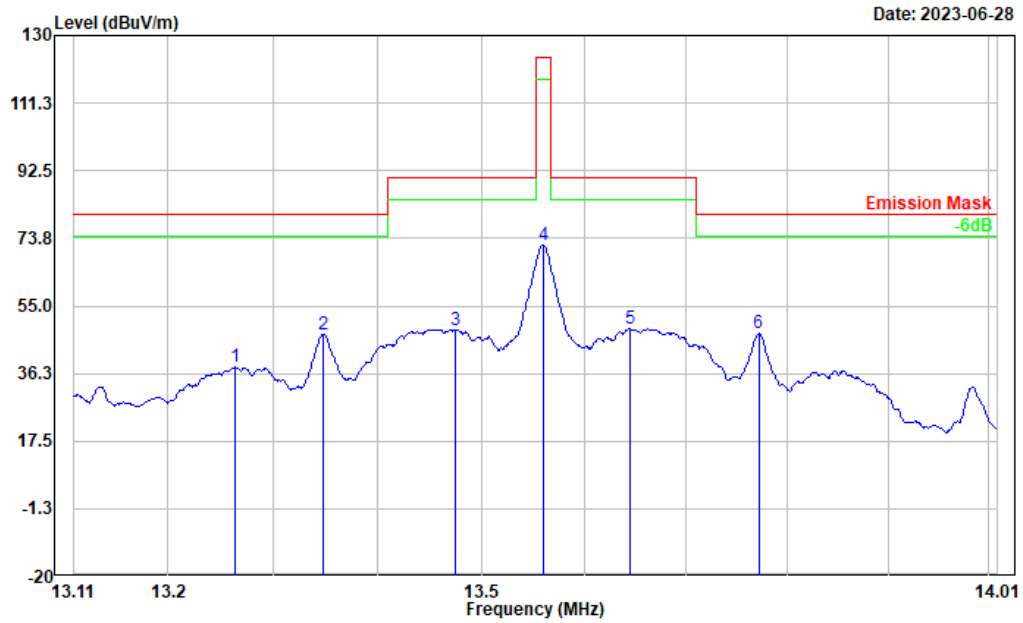

No.	Frequency (MHz)	Reading (dB μ V)	Factor (dB/m)	Result (dB μ V/m)	Limit (dB μ V/m)	Margin (dB)	Detector
1	13.263	43.44	-5.49	37.95	80.51	42.56	Peak
2	13.348	52.93	-5.75	47.18	80.51	33.33	Peak
3	13.475	54.61	-6.14	48.47	90.47	42.00	Peak
4	13.560	78.31	-6.38	71.93	124.00	52.07	Peak
5	13.645	55.27	-6.64	48.63	90.47	41.84	Peak
6	13.772	54.32	-7.03	47.29	80.51	33.22	Peak

Perpendicular:

Test Mode: Transmitting

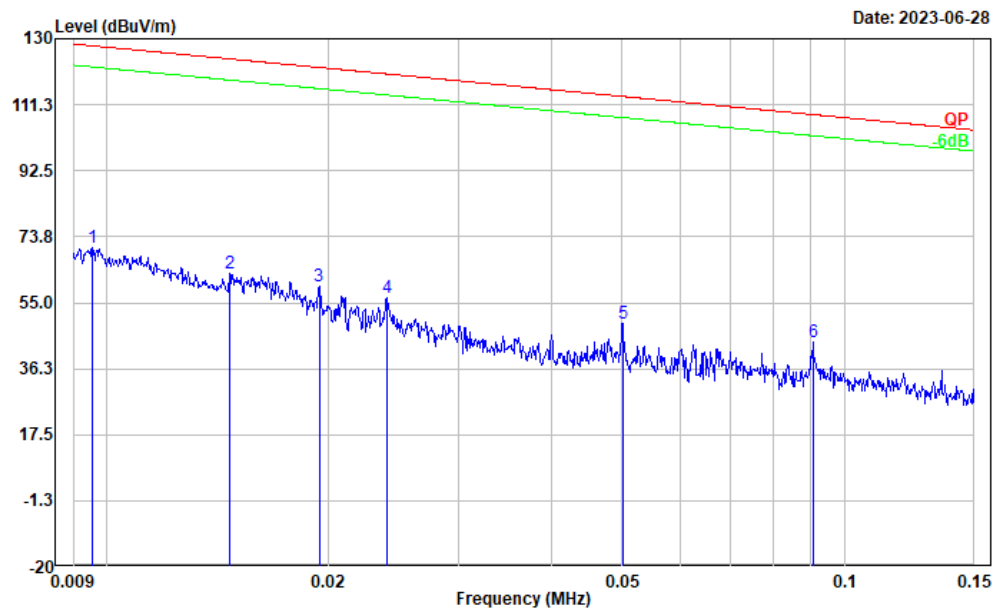

No.	Frequency (MHz)	Reading (dBμV)	Factor (dB/m)	Result (dBμV/m)	Limit (dBμV/m)	Margin (dB)	Detector
1	0.010	12.36	58.49	70.85	127.98	57.13	Peak
2	0.015	9.40	53.92	63.32	124.27	60.95	Peak
3	0.019	9.86	49.80	59.66	121.85	62.19	Peak
4	0.024	8.69	47.82	56.51	120.02	63.51	Peak
5	0.050	6.93	42.26	49.19	113.61	64.42	Peak
6	0.091	8.17	35.72	43.89	108.46	64.57	Peak

Test Mode: Transmitting

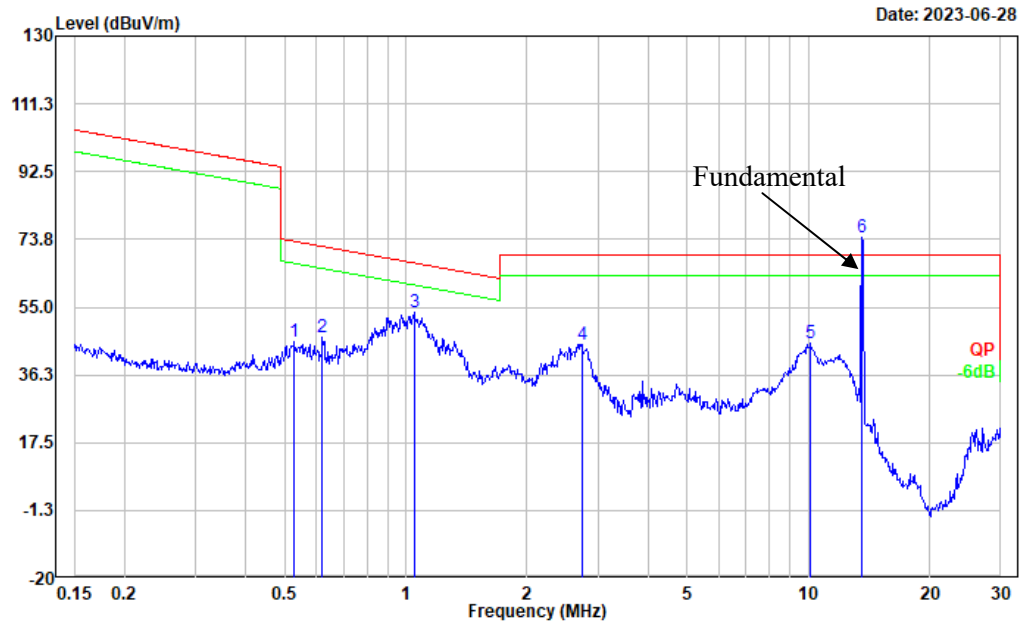

No.	Frequency (MHz)	Reading (dB μ V)	Factor (dB/m)	Result (dB μ V/m)	Limit (dB μ V/m)	Margin (dB)	Detector
1	0.529	23.46	21.85	45.31	73.11	27.80	Peak
2	0.621	26.05	20.66	46.71	71.71	25.00	Peak
3	1.049	36.83	16.58	53.41	67.05	13.64	Peak
4	2.736	35.72	9.09	44.81	69.54	24.73	Peak
5	10.125	40.78	4.07	44.85	69.54	24.69	Peak
6	13.551	80.52	-6.36	74.16	69.54	-4.62	Peak

Test Mode: Transmitting

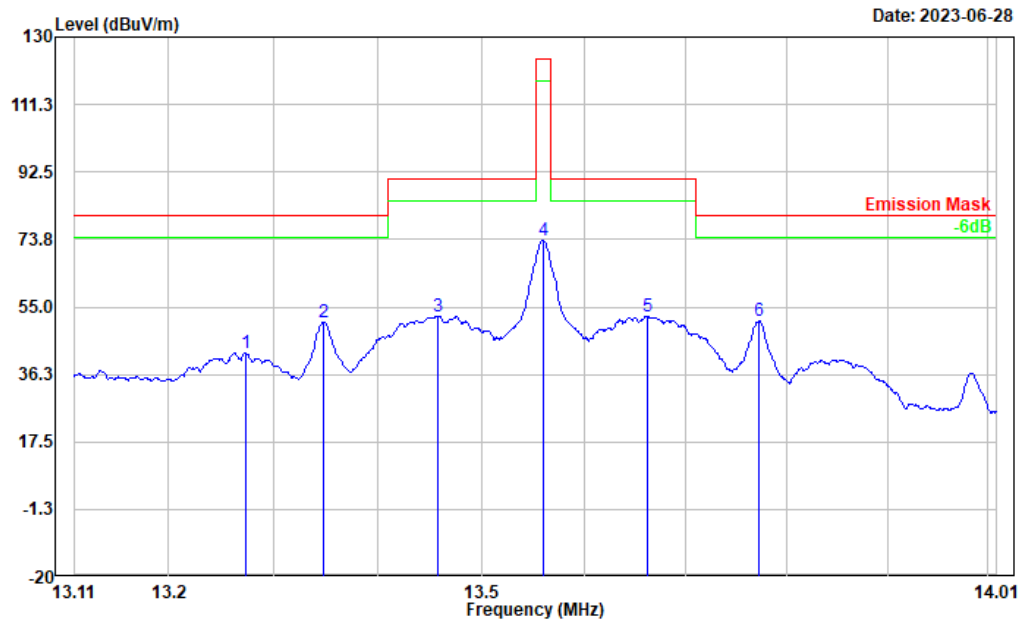

No.	Frequency (MHz)	Reading (dB μ V)	Factor (dB/m)	Result (dB μ V/m)	Limit (dB μ V/m)	Margin (dB)	Detector
1	13.273	47.74	-5.53	42.21	80.51	38.30	Peak
2	13.348	56.63	-5.75	50.88	80.51	29.63	Peak
3	13.458	58.46	-6.09	52.37	90.47	38.10	Peak
4	13.560	79.94	-6.38	73.56	124.00	50.44	Peak
5	13.662	58.97	-6.69	52.28	90.47	38.19	Peak
6	13.772	58.14	-7.03	51.11	80.51	29.40	Peak

Parallel:

Test Mode: Transmitting

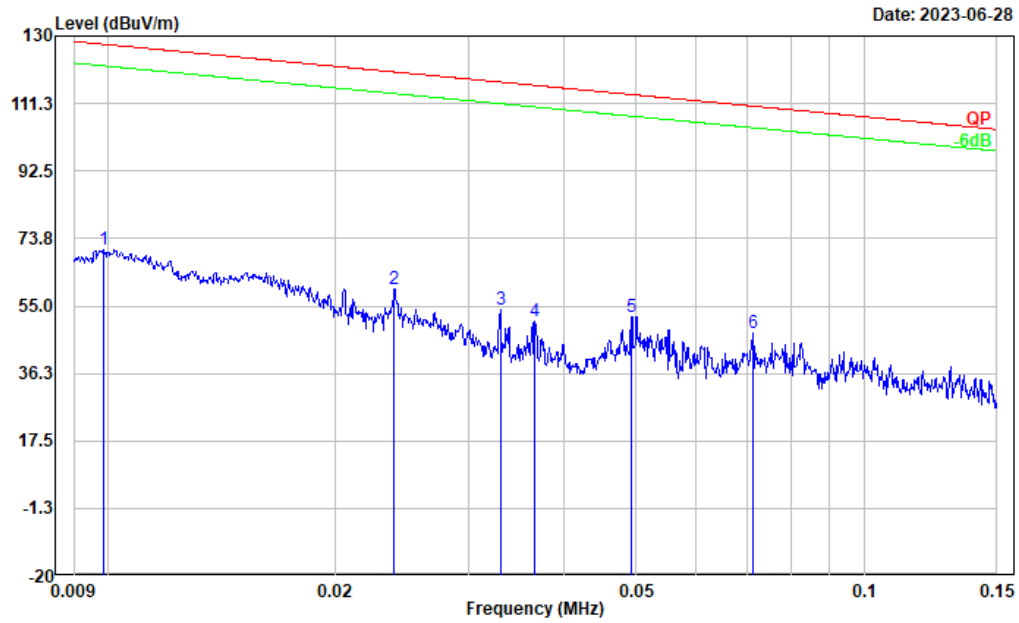

No.	Frequency (MHz)	Reading (dBμV)	Factor (dB/m)	Result (dBμV/m)	Limit (dBμV/m)	Margin (dB)	Detector
1	0.010	12.56	58.16	70.72	127.71	56.99	Peak
2	0.024	11.87	47.85	59.72	120.04	60.32	Peak
3	0.033	9.05	45.01	54.06	117.23	63.17	Peak
4	0.037	6.40	44.26	50.66	116.30	65.64	Peak
5	0.049	9.57	42.38	51.95	113.76	61.81	Peak
6	0.071	9.58	38.10	47.68	110.53	62.85	Peak

Test Mode: Transmitting

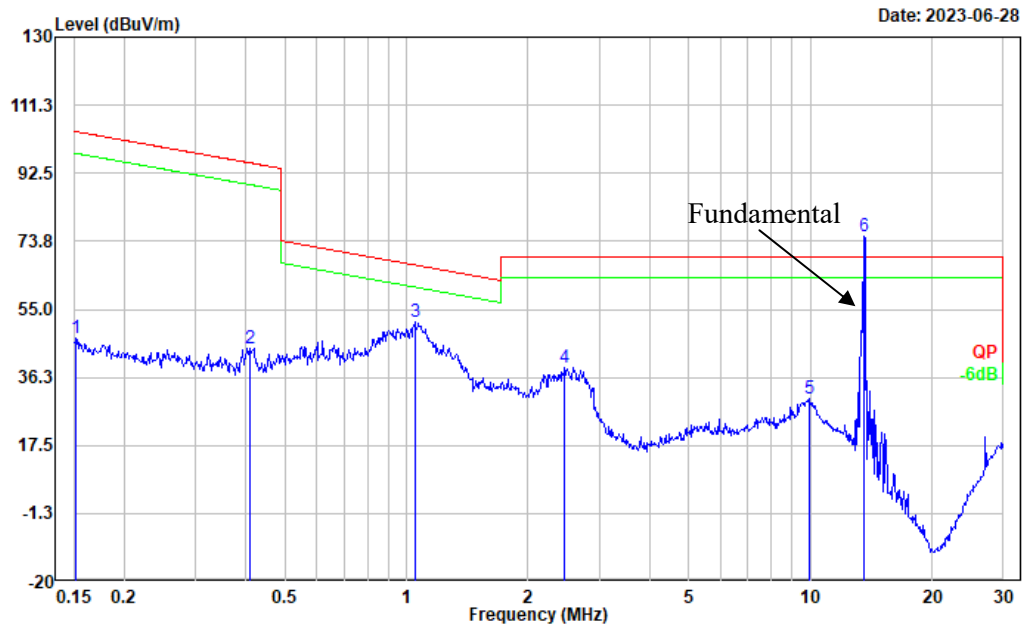

No.	Frequency (MHz)	Reading (dBμV)	Factor (dB/m)	Result (dBμV/m)	Limit (dBμV/m)	Margin (dB)	Detector
1	0.152	14.76	32.28	47.04	103.94	56.90	Peak
2	0.410	20.57	23.82	44.39	95.34	50.95	Peak
3	1.049	35.13	16.58	51.71	67.05	15.34	Peak
4	2.461	28.97	9.88	38.85	69.54	30.69	Peak
5	9.913	26.11	4.46	30.57	69.54	38.97	Peak
6	13.551	81.68	-6.36	75.32	69.54	-5.78	Peak

Test Mode: Transmitting

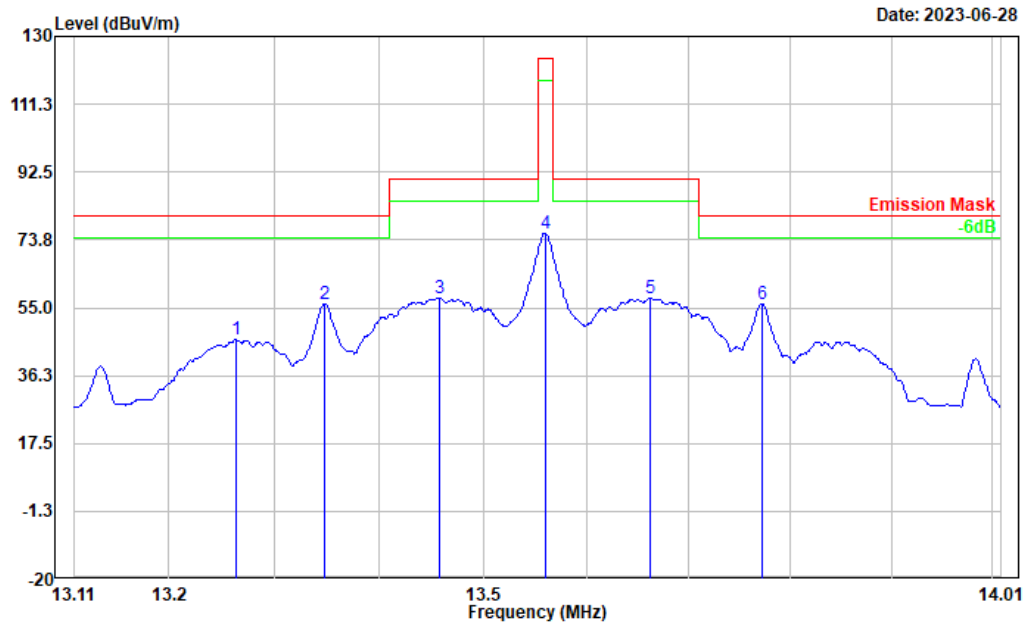

No.	Frequency (MHz)	Reading (dB μ V)	Factor (dB/m)	Result (dB μ V/m)	Limit (dB μ V/m)	Margin (dB)	Detector
1	13.263	51.72	-5.49	46.23	80.51	34.28	Peak
2	13.348	61.84	-5.75	56.09	80.51	24.42	Peak
3	13.458	63.59	-6.09	57.50	90.47	32.97	Peak
4	13.560	82.05	-6.38	75.67	124.00	48.33	Peak
5	13.663	64.19	-6.70	57.49	90.47	32.98	Peak
6	13.772	63.24	-7.03	56.21	80.51	24.30	Peak

**1) 30MHz-1GHz
Horizontal:**

Test Mode: Transmitting
Polarization: horizontal
Note:

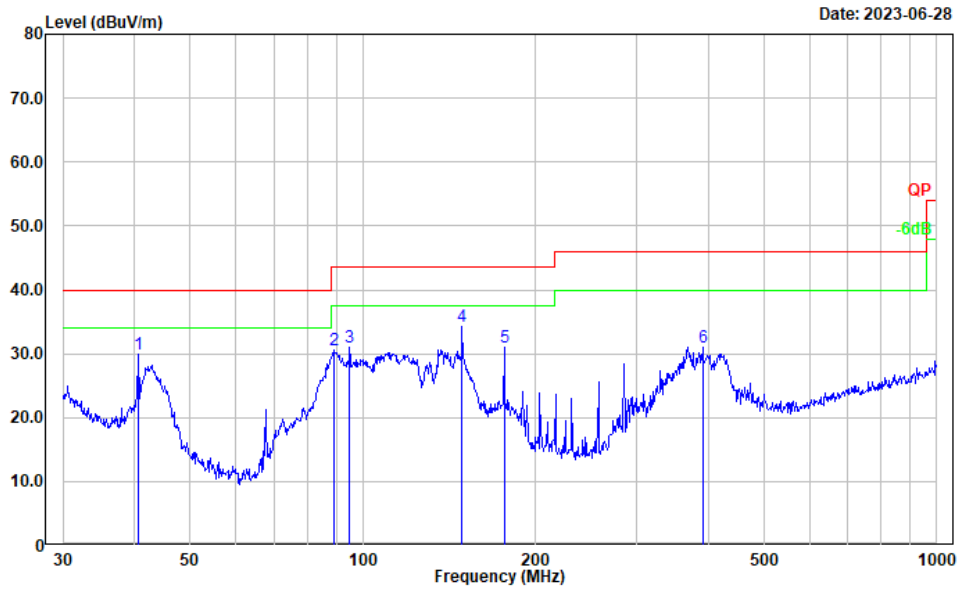

No.	Frequency (MHz)	Reading (dBμV)	Factor (dB/m)	Result (dBμV/m)	Limit (dBμV/m)	Margin (dB)	Detector
1	40.702	41.57	-11.73	29.84	40.00	10.16	Peak
2	88.964	47.63	-17.00	30.63	43.50	12.87	Peak
3	94.760	46.61	-15.69	30.92	43.50	12.58	Peak
4	148.963	46.35	-12.00	34.35	43.50	9.15	Peak
5	176.269	44.38	-13.31	31.07	43.50	12.43	Peak
6	390.723	39.90	-8.88	31.02	46.00	14.98	Peak

Vertical:

Test Mode: Transmitting
 Polarization: vertical
 Note:

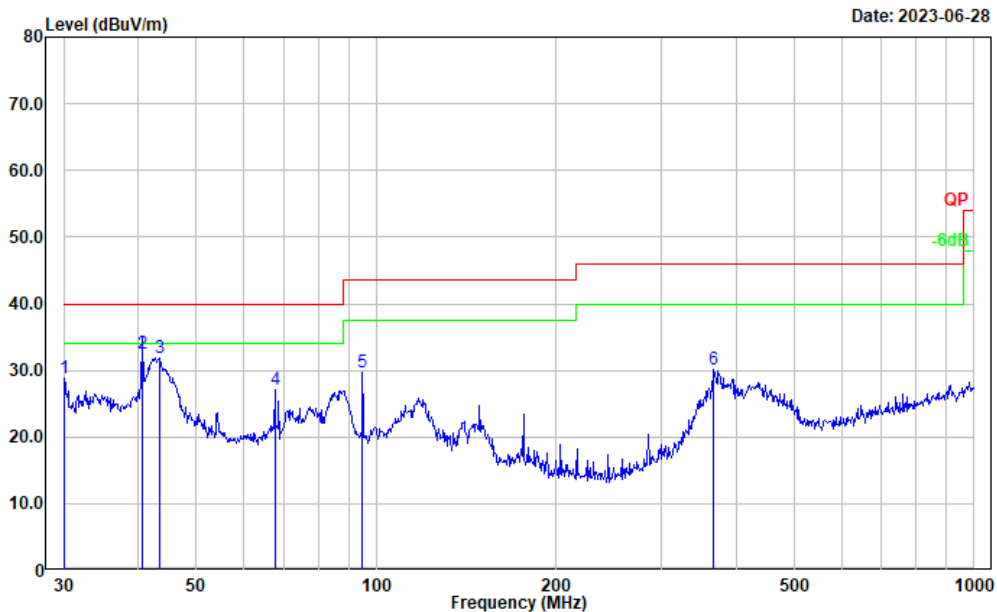

No.	Frequency (MHz)	Reading (dBμV)	Factor (dB/m)	Result (dBμV/m)	Limit (dBμV/m)	Margin (dB)	Detector
1	30.000	32.42	-3.60	28.82	40.00	11.18	Peak
2	40.687	44.34	-11.73	32.61	40.00	7.39	QP
3	43.506	45.15	-13.37	31.78	40.00	8.22	Peak
4	67.675	43.83	-16.71	27.12	40.00	12.88	Peak
5	94.760	45.29	-15.69	29.60	43.50	13.90	Peak
6	366.823	39.71	-9.60	30.11	46.00	15.89	Peak

4.3 20 dB Emission Bandwidth

Serial Number:	26JR-6	Test Date:	2023/6/28
Test Site:	966-2	Test Mode:	Transmitting
Tester:	Carl Xue	Test Result:	Pass

Environmental Conditions:

Temperature: (°C)	27	Relative Humidity: (%)	70	ATM Pressure: (kPa)	100.4
----------------------	----	---------------------------	----	---------------------------	-------

Test Equipment List and Details:

Manufacturer	Description	Model	Serial Number	Calibration Date	Calibration Due Date
EMCO	Passive Loop Antenna	6512	9706-1209	2023/2/15	2026/2/14
R&S	EMI Test Receiver	ESR3	102724	2022/7/15	2023/7/14
TIMES MICROWAVE	Coaxial Cable	LMR-600-UltraFlex	C-0470-02	2022/7/17	2023/7/16
TIMES MICROWAVE	Coaxial Cable	LMR-600-UltraFlex	C-0780-01	2022/7/17	2023/7/16
Audix	Test Software	E3	201021 (V9)	N/A	N/A

** Statement of Traceability: China Certification ICT Co., Ltd (Dongguan) attests that all calibrations have been performed, traceable to National Primary Standards and International System of Units (SI).*

Test Data:

Test Frequency (MHz)	20 dB Emission Bandwidth (Hz)
13.56	1499

20dB Emission Bandwidth

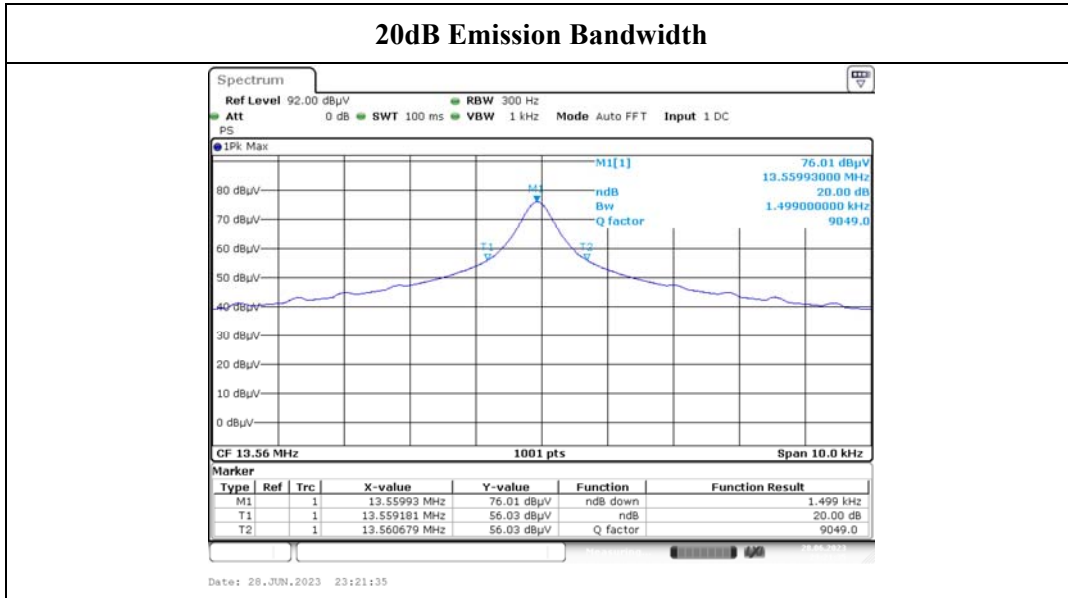

Date: 28.JUN.2023 23:21:35

4.4 Frequency Stability

Serial Number:	26JR-6	Test Date:	2023/6/29
Test Site:	RF	Test Mode:	Transmitting
Tester:	Carl Xue	Test Result:	Pass

Environmental Conditions:

Temperature: (°C)	27	Relative Humidity: (%)	56	ATM Pressure: (kPa)	100.4
----------------------	----	---------------------------	----	---------------------------	-------

Test Equipment List and Details:

Manufacturer	Description	Model	Serial Number	Calibration Date	Calibration Due Date
EMCO	Passive Loop Antenna	6512	9706-1209	2023/2/15	2026/2/14
R&S	EMI Test Receiver	ESR3	102724	2022/7/15	2023/7/14
BACL	TEMP&HUMI Test Chamber	BTH-150-40	30174	2023/3/31	2024/3/30
YINSAIGE	Coaxial Cable	SS402	SJ0300001	Each time	N/A
UNI-T	Multimeter	UT39A+	C210582554	2022/9/29	2023/9/28
ZHAOXIN	DC Power Supply	RXN-6010D	21R6010D0912386	N/A	N/A

** Statement of Traceability: China Certification ICT Co., Ltd (Dongguan) attests that all calibrations have been performed, traceable to National Primary Standards and International System of Units (SI).*

Test Data:

$f_0 = 13.56$ MHz				
Temperature	Voltage	Measured frequency	Frequency Error	Limit
°C	V _{DC}	MHz	Hz	Hz
-20	3.8	13.559871	-129	±1356
-10		13.560126	126	±1356
0		13.559890	-110	±1356
10		13.560046	46	±1356
20		13.559930	-70	±1356
25		13.559976	-24	±1356
30		13.559825	-175	±1356
40		13.559857	-143	±1356
50		13.560132	132	±1356
20		3.2	13.560077	77
20	4.35	13.559905	-95	±1356

5. RF EXPOSURE EVALUATION

Applicable Standard

According to KDB447498 D01 General RF Exposure Guidance v06: 4.3. General SAR test exclusion guidance

c) For frequencies below 100 MHz, the following may be considered for SAR test exclusion (also illustrated in Appendix C):

- 1) For *test separation distances* > 50 mm and < 200 mm, the power threshold at the corresponding test separation distance at 100 MHz in step b) is multiplied by $[1 + \log(100/f_{\text{(MHz)}})]$
- 2) For *test separation distances* ≤ 50 mm, the power threshold determined by the equation in c) 1) for 50 mm and 100 MHz is multiplied by $\frac{1}{2}$
- 3) SAR measurement procedures are not established below 100 MHz

Measurement Result:

For NFC, the power of EUT: E Field@3m is 75.67dBuV/m = -19.53 dBm(0.011mW)

Note: $E[\text{dB}\mu\text{V}/\text{m}] = \text{EIRP}[\text{dBm}] + 95.2$ for $d = 3$ m.

SAR test exclusion threshold for NFC(13.56MHz) separation distance < 50 mm

$$=[474*(1 + \log(100/f_{\text{(MHz)}}))]/2$$

$$= 443\text{mW}$$

$$>0.011\text{mW}$$

==== END OF REPORT =====