



FCC TEST REPORT

Test report
On Behalf of
Streamax Technology Co.,Ltd
For
Tablet
Model No.: Smart Pad

FCC ID: 2AM6L-SPAD

Prepared for : Streamax Technology Co.,Ltd
21-23/F, Building B1, Zhiyuan, No. 1001, Xueyuan Avenue, Nanshan District, Shenzhen,
Guangdong,P.R. China

Prepared By : Shenzhen HUAKE Testing Technology Co., Ltd.
1F, B2 Building, Junfeng Zhongcheng Zhizao Innovation Park, Fuhai Street, Bao'an
District, Shenzhen City, China

Date of Test: Aug. 15, 2018~Dec. 24, 2018

Date of Report: Dec. 24, 2018

Report Number: HUAKE180817833E



TEST RESULT CERTIFICATION

Applicant's name: Streamax Technology Co.,Ltd
Address.....: 21-23/F, Building B1, Zhiyuan, No. 1001, Xueyuan Avenue, Nanshan District, Shenzhen, Guangdong,P.R. China
Manufacture's Name.....: Streamax Technology Co.,Ltd
Address.....: 21-23/F, Building B1, Zhiyuan, No. 1001, Xueyuan Avenue, Nanshan District, Shenzhen, Guangdong,P.R. China
Factory's Name: Streamax Electronics Co.,Ltd.
Address.....: 5th-6thFloor, West, Chuangxiang 2nd Building, Yanxiang Technology Park, 11# High-tech West Road, Guangming District, Shenzhen, Guangdong Province, P.R. China
Product description: Tablet
 Brand Name: Streamax
 Mode Name: Smart Pad
Standards.....: FCC Rules and Regulations Part 15 Subpart C Section 15.247
 ANSI C63.10: 2013

This publication may be reproduced in whole or in part for non-commercial purposes as long as the Shenzhen HUAKE Testing Technology Co., Ltd. is acknowledged as copyright owner and source of the material. Shenzhen HUAKE Testing Technology Co., Ltd. takes no responsibility for and will not assume liability for damages resulting from the reader's interpretation of the reproduced material due to its placement and context.

Date of Test.....:
 Date (s) of performance of tests: **Aug. 15, 2018~Dec. 24, 2018**
 Date of Issue: **Dec. 24, 2018**
 Test Result: **Pass**

Testing Engineer : 

 (Gary Qian)

Technical Manager : 

 (Eden Hu)

Authorized Signatory : 

 (Jason Zhou)



Revision	Issue Date	Revisions	Revised By
V1.0	Dec. 24, 2018	Initial Issue	Jason Zhou



TABLE OF CONTENTS

1. VERIFICATION OF CONFORMITY	6
1.1. PRODUCT DESCRIPTION.....	6
1.2. TABLE OF CARRIER FREQUENCIES.....	7
1.3. RECEIVER INPUT BANDWIDTH.....	8
1.4. EXAMPLE OF A HOPPING SEQUENCY IN DATA MODE.....	8
1.5. EQUALLY AVERAGE USE OF FREQUENCIES AND BEHAVIOUR.....	8
1.6. RELATED SUBMITTAL(S) / GRANT (S).....	9
1.7. TEST METHODOLOGY.....	9
1.8. SPECIAL ACCESSORIES.....	9
1.9. EQUIPMENT MODIFICATIONS.....	9
2. MEASUREMENT UNCERTAINTY	10
3. DESCRIPTION OF TEST MODES	11
4. SYSTEM TEST CONFIGURATION	12
4.1. CONFIGURATION OF EUT SYSTEM.....	12
4.2. EQUIPMENT USED IN EUT SYSTEM.....	12
4.3. SUMMARY OF TEST RESULTS.....	13
5. TEST FACILITY	14
6. PEAK OUTPUT POWER	16
6.1. MEASUREMENT PROCEDURE.....	16
6.2. TEST SET-UP (BLOCK DIAGRAM OF CONFIGURATION).....	16
6.3. LIMITS AND MEASUREMENT RESULT.....	17
7. 20DB BANDWIDTH	20
8.1. MEASUREMENT PROCEDURE.....	20
7.2. TEST SET-UP (BLOCK DIAGRAM OF CONFIGURATION).....	20
7.3. LIMITS AND MEASUREMENT RESULTS.....	20
8. CONDUCTED SPURIOUS EMISSION	23
8.1. MEASUREMENT PROCEDURE.....	23
8.2. TEST SET-UP (BLOCK DIAGRAM OF CONFIGURATION).....	23
8.3. MEASUREMENT EQUIPMENT USED.....	24
8.4. LIMITS AND MEASUREMENT RESULT.....	24
9. RADIATED EMISSION	30
9.1. MEASUREMENT PROCEDURE.....	30
9.2. TEST SETUP.....	31
9.3. LIMITS AND MEASUREMENT RESULT.....	32
9.4. TEST RESULT.....	33



- 10. BAND EDGE EMISSION.....36**
 - 10.1. MEASUREMENT PROCEDURE.....36
 - 10.2. TEST SET-UP.....36
 - 10.3. RADIATED TEST RESULT.....37
 - 10.4 CONDUCTED TEST RESULT.....38
- 11. NUMBER OF HOPPING FREQUENCY.....40**
 - 11.1. MEASUREMENT PROCEDURE.....40
 - 11.2. TEST SETUP (BLOCK DIAGRAM OF CONFIGURATION)40
 - 11.3. MEASUREMENT EQUIPMENT USED.....40
 - 11.4. LIMITS AND MEASUREMENT RESULT.....40
- 12. TIME OF OCCUPANCY (DWELL TIME)41**
 - 12.1. MEASUREMENT PROCEDURE.....41
 - 12.2. TEST SETUP (BLOCK DIAGRAM OF CONFIGURATION)41
 - 12.3. MEASUREMENT EQUIPMENT USED.....41
 - 12.4. LIMITS AND MEASUREMENT RESULT42
- 13. FREQUENCY SEPARATION43**
 - 13.1. MEASUREMENT PROCEDURE.....43
 - 13.2. TEST SETUP (BLOCK DIAGRAM OF CONFIGURATION)43
 - 13.3. MEASUREMENT EQUIPMENT USED.....43
 - 13.4. LIMITS AND MEASUREMENT RESULT43
- APPENDIX A: PHOTOGRAPHS OF TEST SETUP44**



1. VERIFICATION OF CONFORMITY

1.1. PRODUCT DESCRIPTION

Equipment	Tablet
Model Name	Smart Pad
Hardware Version	1480
Software Version	RMVST_SPAD
FCC ID	2AM6L-SPAD
Antenna Type	PIFA Antenna
Antenna Gain	1.0dBi
BT Operation frequency	2.402 GHz to 2.480GHz
Number of Channels	79(For BR/EDR)
Modulation Type	GFSK, $\pi/4$ -DQPSK, 8DPSK
Power Supply	DC 12V



1.2. TABLE OF CARRIER FREQUENCIES

Frequency Band	Channel Number	Frequency
2400~2483.5MHZ	0	2402MHZ
	1	2403MHZ
	:	:
	38	2440 MHZ
	39	2441 MHZ
	40	2442 MHZ
	:	:
	77	2479 MHZ
	78	2480 MHZ



1.3. RECEIVER INPUT BANDWIDTH

The input bandwidth of the receiver is 1.3MHz. In every connection one Bluetooth device is the master and the other one is slave. The master determines the hopping sequence. The slave follows this sequence. Both devices shift between RX and TX time slot according to the clock of the master. Additionally the type of connection (e.g. single or multislotted packet) is set up at the beginning of the connection. The master adapts its hopping frequency and its TX/RX timing according to the packet type of the connection. Also the slave of the connection will use these settings.

Repeating of a packet has no influence on the hopping sequence. The hopping sequence generated by the master of the connection will be followed in any case. That means, a repeated packet will not be sent on the same frequency, it is sent on the next frequency of the hopping sequence.

1.4. EXAMPLE OF A HOPPING SEQUENCE IN DATA MODE

Example of a 79 hopping sequence in data mode:

40,21,44,23,42,53,46,55,48,33,52,35,50,65,54,67
56,37,60,39,58,69,62,71,64,25,68,27,66,57,70,59
72,29,76,31,74,61,78,63,01,41,05,43,03,73,07,75
09,45,13,47,11,77,15,00,64,49,66,53,68,02,70,06
01, 51, 03, 55, 05, 04

1.5. EQUALLY AVERAGE USE OF FREQUENCIES AND BEHAVIOUR

The generation of the hopping sequence in connection mode depends essentially on two input values:

1. LAP/UAP of the master of the connection.
2. Internal master clock

The LAP (lower address part) are the 24 LSB's of the 48 BD_ADDRESS. The BD_ADDRESS is an unambiguous number of every Bluetooth unit. The UAP (upper address part) are the 24 MSB's of the 48 BD_ADDRESS.

The internal clock of a Bluetooth unit is derived from a free running clock which is never adjusted and is never turned off. For synchronization with other units only offsets are used. It has no relation to the time of the day. Its resolution is at least half the RX/TX slot length of 312.5µs. The clock has a cycle of about one day (23h30). In most cases it is implemented as a 28-bit counter. For the deriving of the hopping sequence the entire LAP (24 bits), 4 LSB's (4 bits) (Input 1) and the 27 MSB's of the clock (Input 2) are used. With these input values different mathematical procedures (permutations, additions, XOR-operations) are performed to generate the sequence. This will be done at the beginning of every new transmission.

Regarding short transmissions the Bluetooth system has the following behavior:

The first connection between the two devices is established, a hopping sequence was generated. For transmitting the wanted data the complete hopping sequence was not used. The connection ended.

The second connection will be established. A new hopping sequence is generated. Due to the fact the Bluetooth clock has a different value, because the period between the two transmissions is longer (and it cannot be shorter) than the minimum resolution of the clock (312.5µs). The hopping sequence will always differ from the first one.



1.6. RELATED SUBMITTAL(S) / GRANT (S)

This submittal(s) (test report) is intended for **FCC ID: 2AM6L-SPAD** filing to comply with Section 15.247 of the FCC Part 15, Subpart C Rules.

1.7. TEST METHODOLOGY

Both conducted and radiated testing was performed according to the procedures in ANSI C63.10 (2013). Radiated testing was performed at an antenna to EUT distance 3 meters.

1.8. SPECIAL ACCESSORIES

Refer to section 5.2.

1.9. EQUIPMENT MODIFICATIONS

Not available for this EUT intended for grant.



2. MEASUREMENT UNCERTAINTY

Test	Measurement Uncertainty	Notes
Transmitter power conducted	± 0.57 dB	(1)
Transmitter power Radiated	± 2.20 dB	(1)
Conducted spurious emission 9KHz-40 GHz	± 2.20 dB	(1)
Occupied Bandwidth	± 0.01 ppm	(1)
Radiated Emission 30~1000MHz	± 4.10 dB	(1)
Radiated Emission Above 1GHz	± 4.32 dB	(1)
Conducted Disturbance 0.15~30MHz	± 3.20 dB	(1)

Note: This uncertainty represents an expanded uncertainty expressed at approximately the 95% confidence level using a coverage factor of $k=2$.



3. DESCRIPTION OF TEST MODES

NO.	TEST MODE DESCRIPTION
1	Low channel GFSK
2	Middle channel GFSK
3	High channel GFSK
4	Low channel $\pi/4$ -DQPSK
5	Middle channel $\pi/4$ -DQPSK
6	High channel $\pi/4$ -DQPSK
7	Low channel 8DPSK
8	Middle channel 8DPSK
9	High channel 8DPSK
10	Normal Hopping

Note:

1. All the test modes can be supply by Built-in Li-ion battery, only the result of the worst case was recorded in the report, if no other cases.
2. For Radiated Emission, 3axis were chosen for testing for each applicable mode.



4. SYSTEM TEST CONFIGURATION

4.1. CONFIGURATION OF EUT SYSTEM

Configuration:

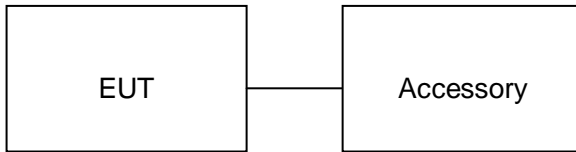

4.2. EQUIPMENT USED IN EUT SYSTEM

Item	Equipment	Model No.	ID or Specification	Remark
1	Tablet	Smart Pad	2AM6L-SPAD	EUT
2	Battery	N/A	DC 3.7V/2400mAh	Accessory
3	Data Hub	N/A	N/A	Accessory
4	Front Panel	N/A	N/A	Accessory



4.3. SUMMARY OF TEST RESULTS

FCC RULES	DESCRIPTION OF TEST	RESULT
§15.247	Peak Output Power	Compliant
§15.247	20 dB Bandwidth	Compliant
§15.247	Spurious Emission	Compliant
§15.209	Radiated Emission	Compliant
§15.247	Band Edges	Compliant
§15.207	Power Line Conduction Emission	N/A
§15.247	Number of Hopping Frequency	Compliant
§15.247	Time of Occupancy	Compliant
§15.247	Frequency Separation	Compliant



5. TEST FACILITY

Site	Shenzhen HUAKE Testing Technology Co., Ltd.
Location	1F, B2 Building, Junfeng Zhongcheng Zhizao Innovation Park, Fuhai Street, Bao'an District, Shenzhen City, China
Designation Number	CN1229
Test Firm Registration Number : 616276	

ALL TEST EQUIPMENT LIST

RF Test Room				
Equipment	Manufacturer	Model	Serial Number	Calibration Due
Power meter	Agilent	E4417B	HKE-107	Dec. 28, 2018
Power Sensor	Agilent	E9327A	HKE-113	Dec. 28, 2018
RF cable	Times	1-40G	HKE-034	Dec. 28, 2018
RF automatic control unit	Tonscend	JS0806-2	HKE-060	Dec. 28, 2018
Spectrum analyzer	Agilent	N9020A	HKE-048	Dec. 28, 2018
RF Cable (9KHz-26.5GHz)	Tonscend	170660	N/A	Dec. 28, 2018
Signal generator	Agilent	N5183A	HKE-071	Dec. 28, 2018
Receiver	R&S	ESCI-7	HKE-010	Dec. 28, 2018
Spectrum analyzer	Agilent	N9020A	HKE-048	Dec. 28, 2018
Preamplifier	EMCI	EMC051845SE	HKE-015	Dec. 28, 2018
Preamplifier	Agilent	83051A	HKE-016	Dec. 28, 2018
Loop antenna	Schwarzbeck	FMZB 1519 B	HKE-014	Dec. 28, 2018
Broadband antenna	Schwarzbeck	VULB 9163	HKE-012	Dec. 28, 2018
Horn antenna	Schwarzbeck	9120D	HKE-013	Dec. 28, 2018
Antenna Mast	Keleto	CC-A-4M	N/A	N/A
Position controller	Taiwan MF	MF7802	HKE-011	Dec. 28, 2018
Radiated test software	Tonscend	TS+ Rev 2.5.0.0	HKE-082	N/A
RF cable (9KHz-1GHz)	Times	381806-001	N/A	N/A
RF cable	Times	1-40G	HKE-034	Dec. 28, 2018



Horn Ant (18G-40GHz)	Schwarzbeck	BBHA 9170	HKE-094	Feb. 28, 2020
Horn Ant (18G-40GHz)	ETS	QWH_SL_18_40_K_SG	HKE-092	Feb. 28, 2020



6. PEAK OUTPUT POWER

6.1. MEASUREMENT PROCEDURE

For peak power test:

1. Connect EUT RF output port to the Spectrum Analyzer through an RF attenuator
2. Set the EUT Work on the top, middle and the bottom operation frequency individually.
3. Use the following spectrum analyzer settings:
 - 1) Span : Approximately five times the 20 dB bandwidth, centered on a hopping channel.
 - 2) RBW > 20 dB bandwidth of the emission being measured.
 - 3) VBW \geq RBW.
 - 4) Sweep: Auto.
 - 5) Detector function: Peak.
 - 6) Trace: Max hold.
4. Record the maximum power from the Spectrum Analyzer.

Note : The EUT was tested according for compliance ANSI C63.10 (2013) requirements.

6.2. TEST SET-UP (BLOCK DIAGRAM OF CONFIGURATION)

PEAK POWER TEST SETUP

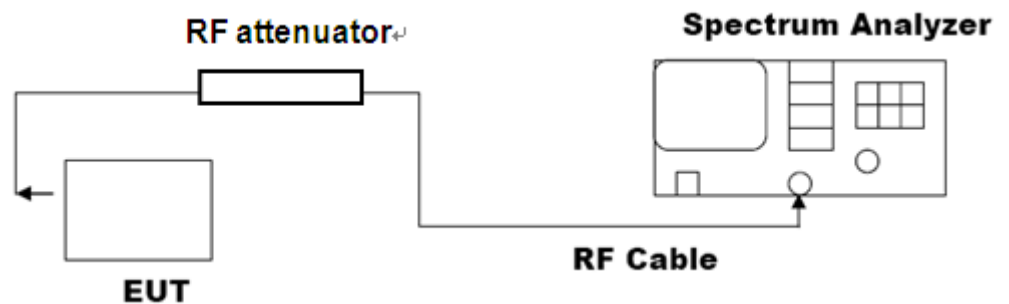

**6.3. LIMITS AND MEASUREMENT RESULT**

Mode	Frequency (GHz)	Peak Power (dBm)	Applicable Limits (dBm)	Pass or Fail
GFSK	2.402	2.079	30	Pass
	2.441	3.806	30	Pass
	2.480	4.568	30	Pass

Mode	Frequency (GHz)	Peak Power (dBm)	Applicable Limits (dBm)	Pass or Fail
π /4-DQPSK	2.402	0.931	30	Pass
	2.441	2.779	30	Pass
	2.480	3.437	30	Pass

Mode	Frequency (GHz)	Peak Power (dBm)	Applicable Limits (dBm)	Pass or Fail
8DPSK	2.402	0.888	30	Pass
	2.441	2.711	30	Pass
	2.480	3.385	30	Pass



Test Graph

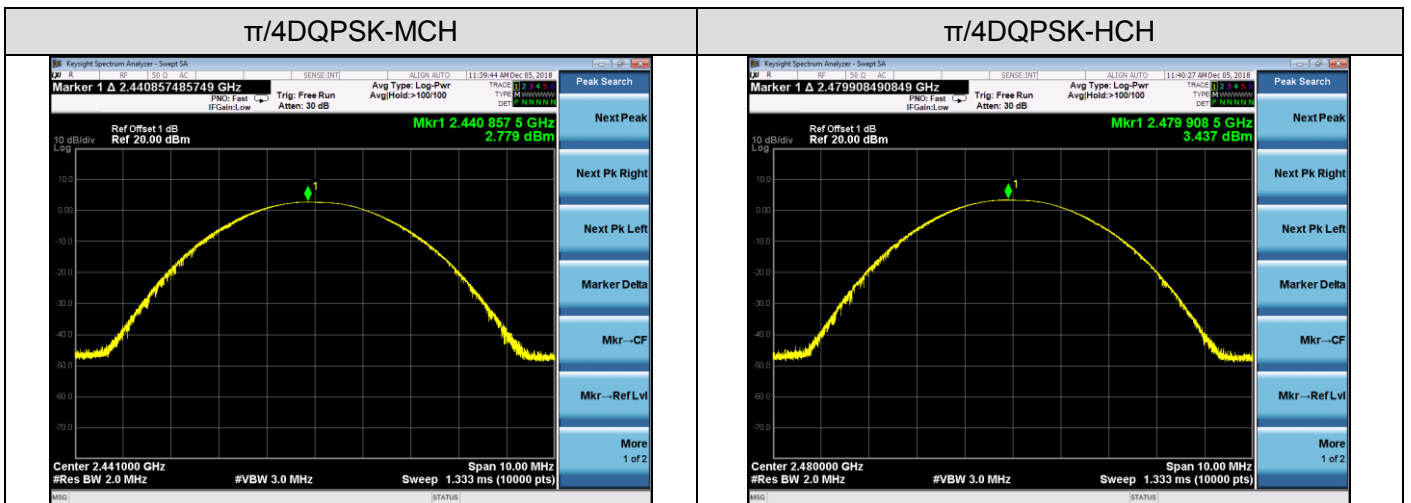
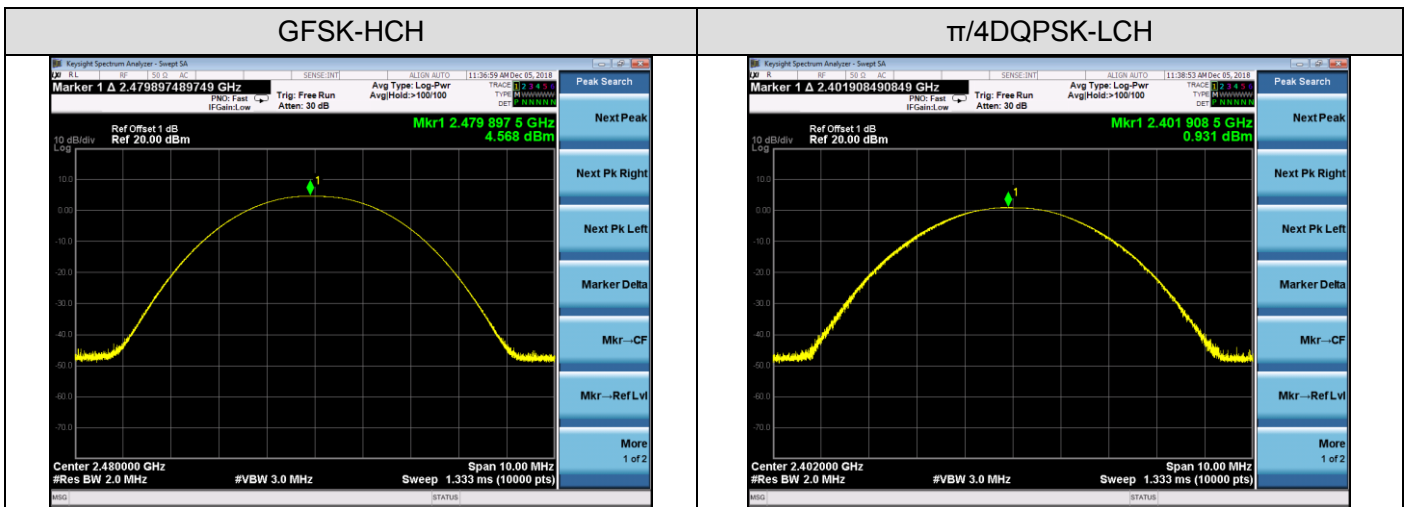
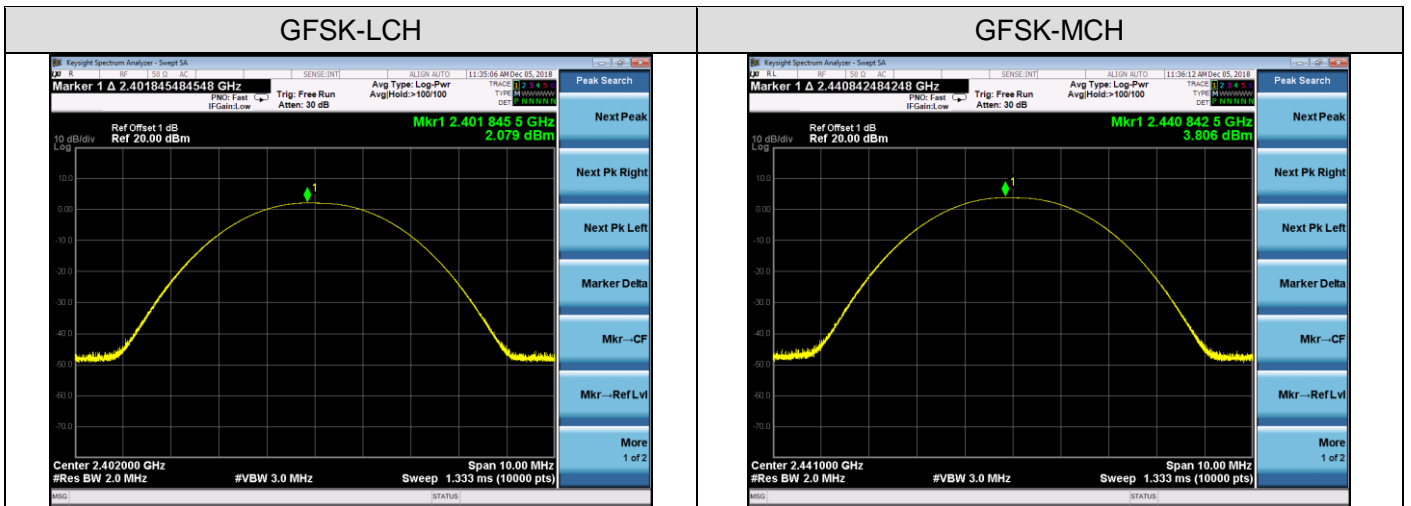



8DPSK-LCH

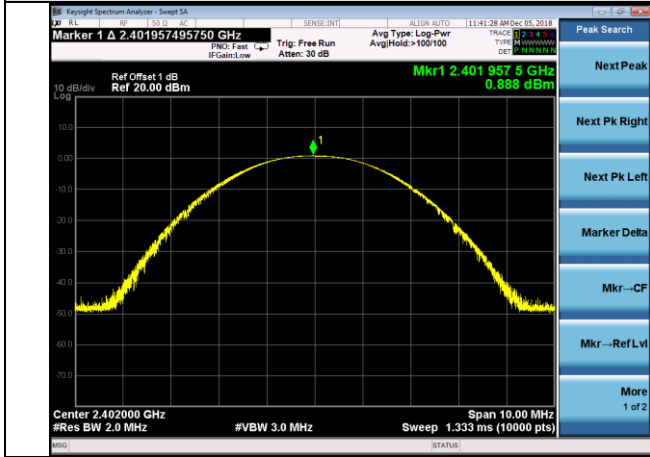

8DPSK-MCH

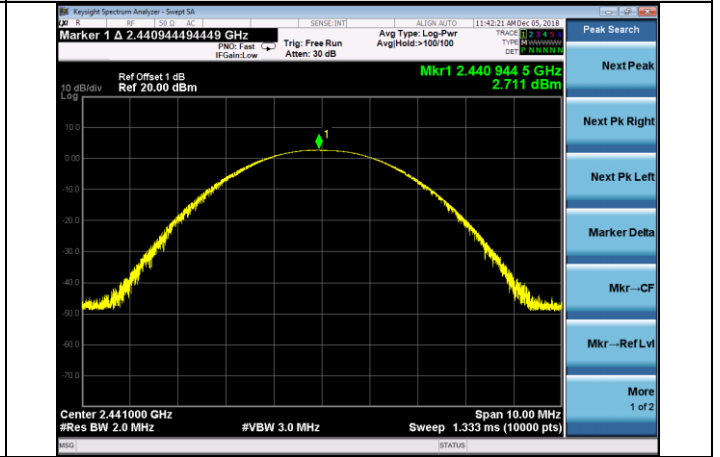

8DPSK-HCH

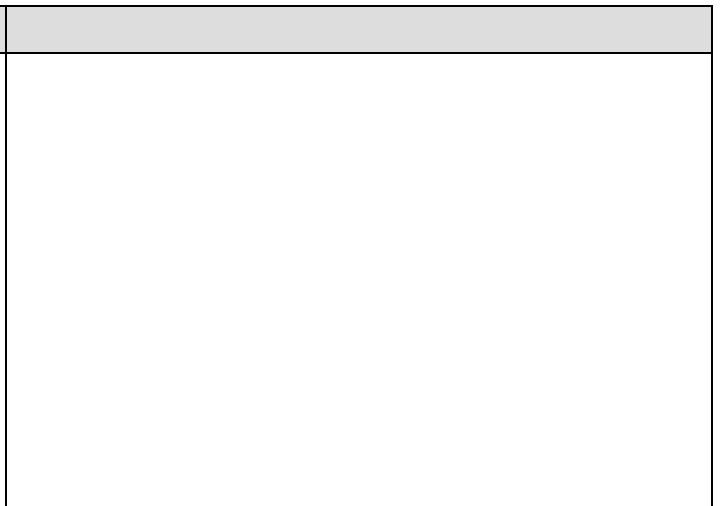
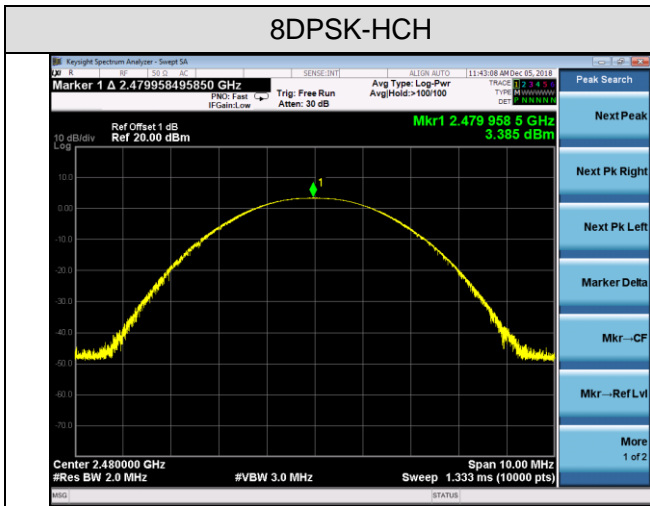



7. 20DB BANDWIDTH

8.1. MEASUREMENT PROCEDURE

1. Connect EUT RF output port to the Spectrum Analyzer through an RF attenuator
2. Set the EUT Work on the top, the middle and the bottom operation frequency individually.
3. Set Span = approximately 2 to 3 times the 20 dB bandwidth, centered on a hopping channel
RBW \geq 1% of the 20 dB bandwidth, VBW \geq RBW; Sweep = auto; Detector function = peak
4. Set SPA Trace 1 Max hold, then View.

7.2. TEST SET-UP (BLOCK DIAGRAM OF CONFIGURATION)

7.3. LIMITS AND MEASUREMENT RESULTS

Mode	Channel.	20dB Bandwidth [KHz]	Verdict
GFSK	LCH	823.0	PASS
GFSK	MCH	825.3	PASS
GFSK	HCH	829.0	PASS
$\pi/4$ DQPSK	LCH	1.126	PASS
$\pi/4$ DQPSK	MCH	1.125	PASS
$\pi/4$ DQPSK	HCH	1.124	PASS
8DPSK	LCH	1.114	PASS
8DPSK	MCH	1.114	PASS
8DPSK	HCH	1.115	PASS



Test Graph

GFSK-LCH

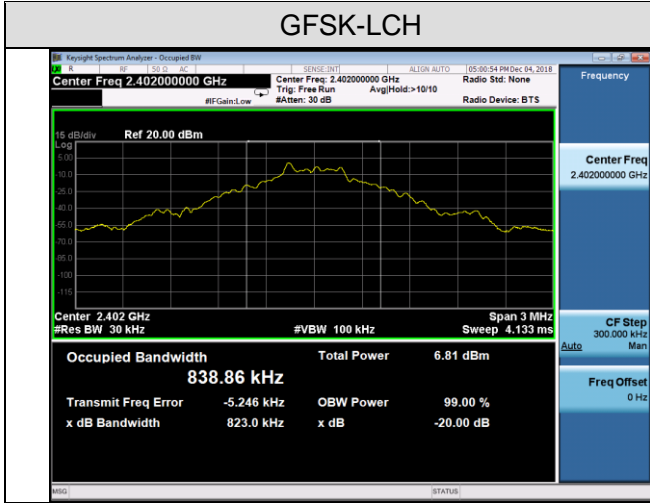

GFSK-MCH

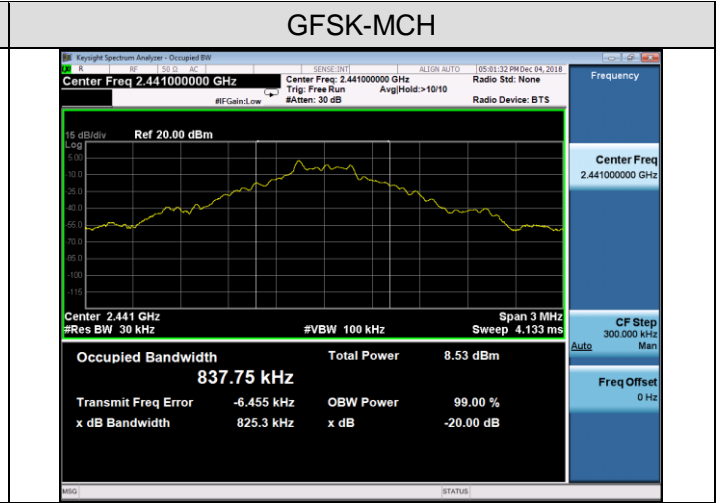

GFSK-HCH

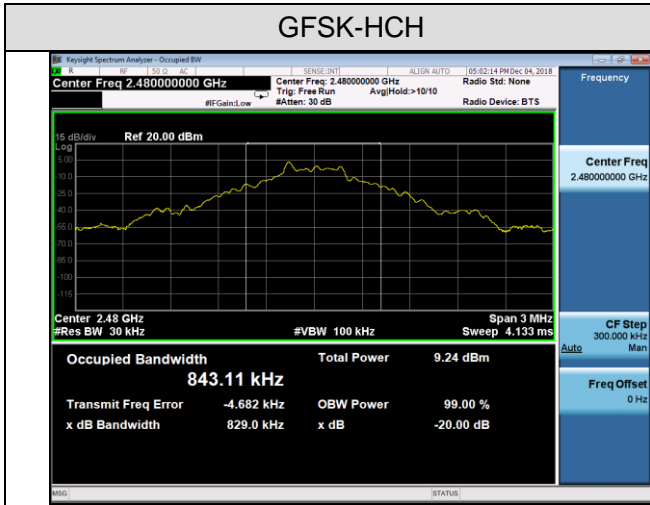

π /4DQPSK-LCH

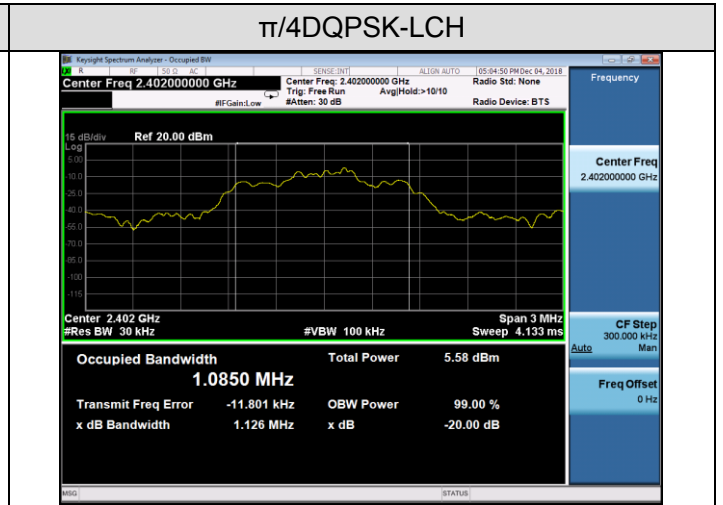

π /4DQPSK-MCH

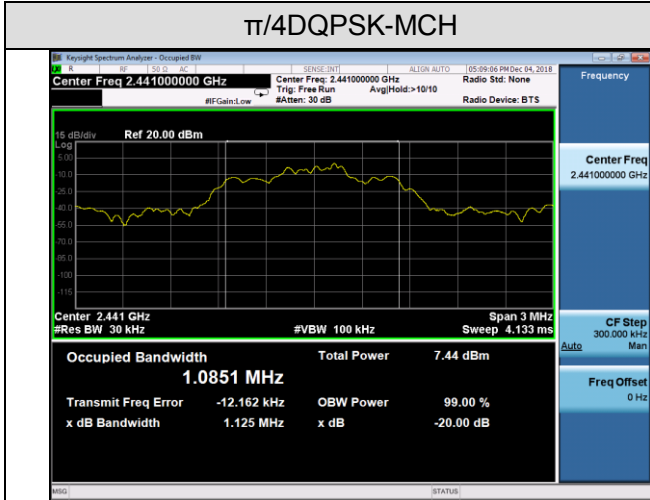

π /4DQPSK-HCH

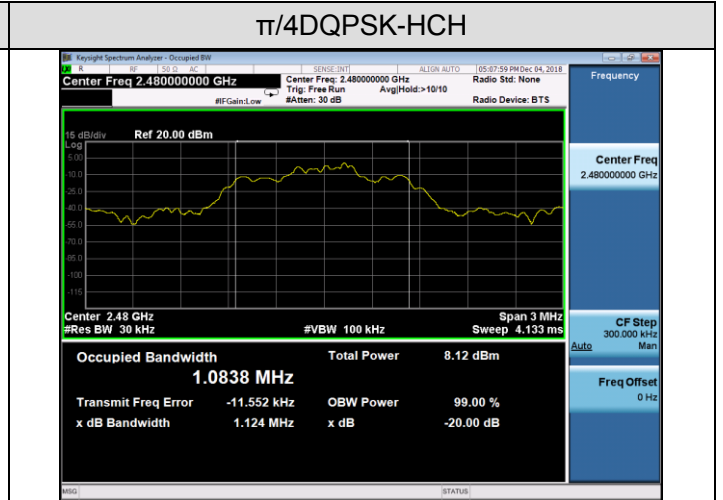



8DPSK-LCH

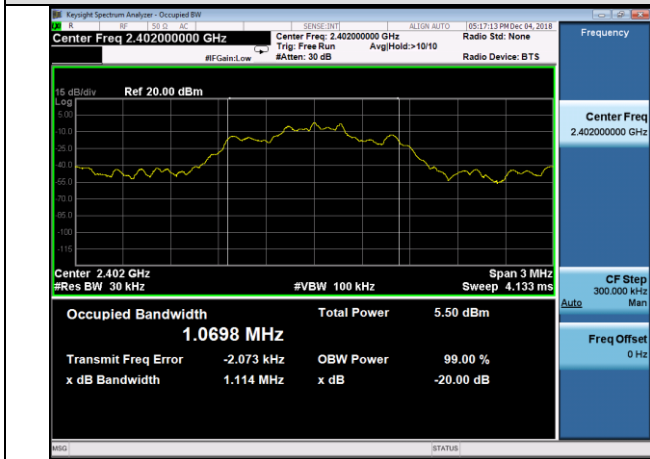

8DPSK-MCH

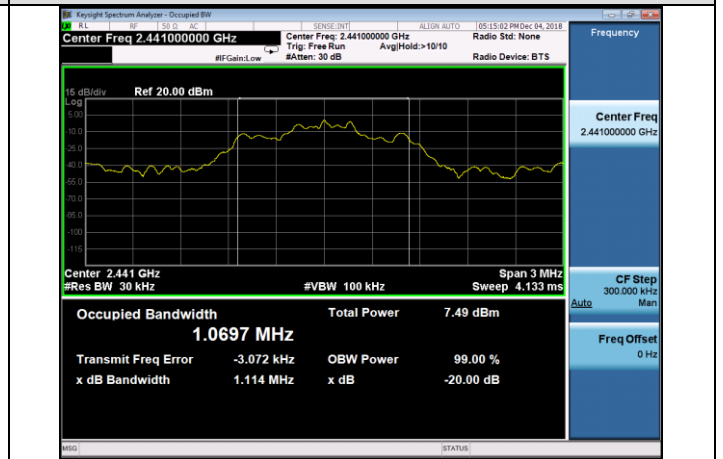

8DPSK-HCH

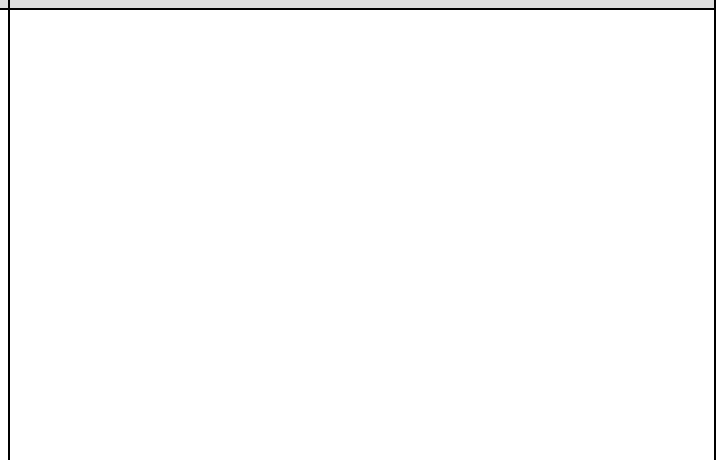
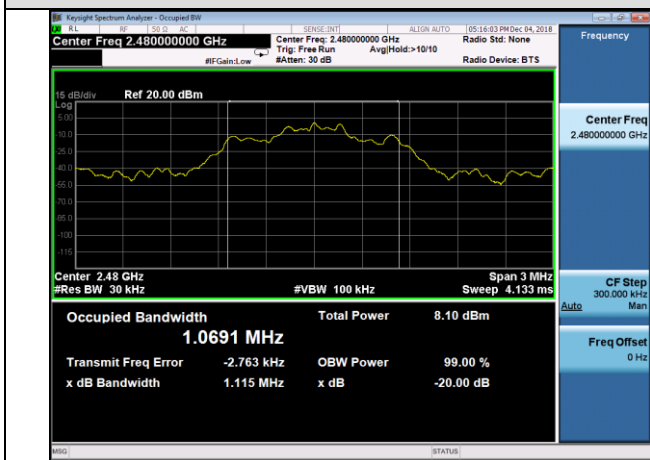



8. CONDUCTED SPURIOUS EMISSION

8.1. MEASUREMENT PROCEDURE

1. Connect EUT RF output port to the Spectrum Analyzer through an RF attenuator
2. Set the EUT Work on the top, the Middle and the bottom operation frequency individually.
3. Set the Span = wide enough to capture the peak level of the in-band emission and all spurious emissions from the lowest frequency generated in the EUT up through the 10th harmonic.
RBW = 100 kHz; VBW \geq RBW; Sweep = auto; Detector function = peak.
4. Set SPA Trace 1 Max hold, then View.

Note: The EUT was tested according for compliance ANSI C63.10 (2013) requirements. Owing to satisfy the requirements of the number of measurement points, we set the RBW=1MHz, VBW $>$ RBW, scan up through 10th harmonic, and consider the tested results as the worst case, if the tested results conform to the requirement, we can deem that the real tested results(set the RBW=100KHz, VBW $>$ RBW) are conform to the requirement.

8.2. TEST SET-UP (BLOCK DIAGRAM OF CONFIGURATION)

The same as described in section 8.2



8.3. MEASUREMENT EQUIPMENT USED

The same as described in section 6

8.4. LIMITS AND MEASUREMENT RESULT

LIMITS AND MEASUREMENT RESULT		
Applicable Limits	Measurement Result	
	Test Data	Criteria
In any 100 KHz Bandwidth Outside the frequency band in which the spread spectrum intentional radiator is operating, the radio frequency power that is produce by the intentional radiator shall be at least 20 dB below that in 100KHz bandwidth within the band that contains the highest level of the desired power. In addition, radiation emissions which fall in the restricted bands, as defined in §15.205(a), must also comply with the radiated emission limits specified in§15.209(a)	Refer Test Graph	PASS



Test Graph

GFSK-LCH

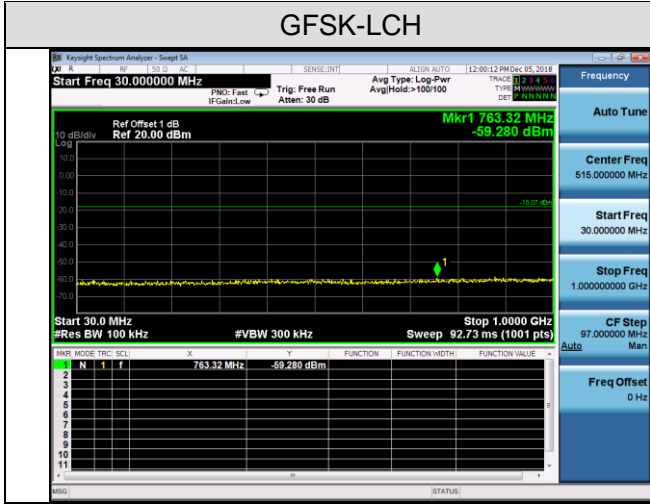

GFSK-LCH

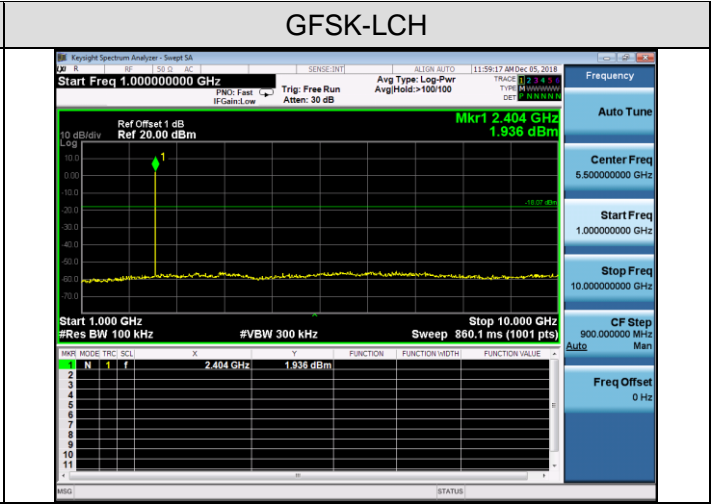

GFSK-LCH

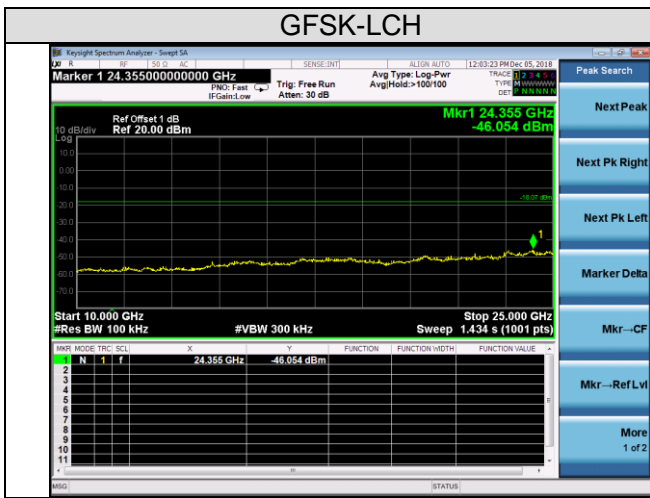

GFSK-MCH

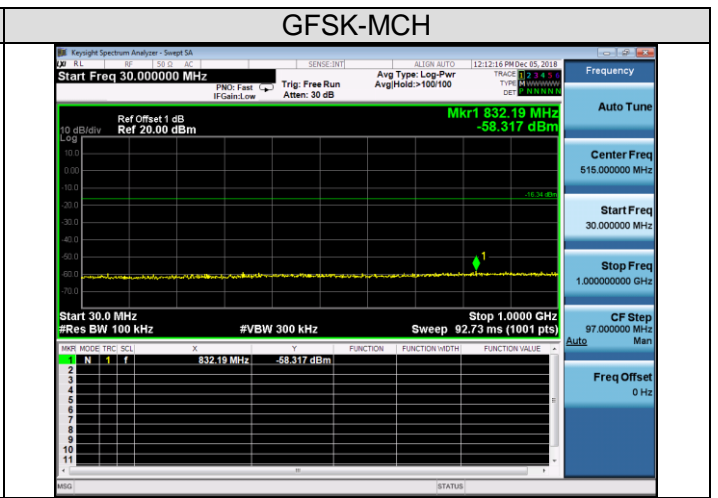

GFSK-MCH

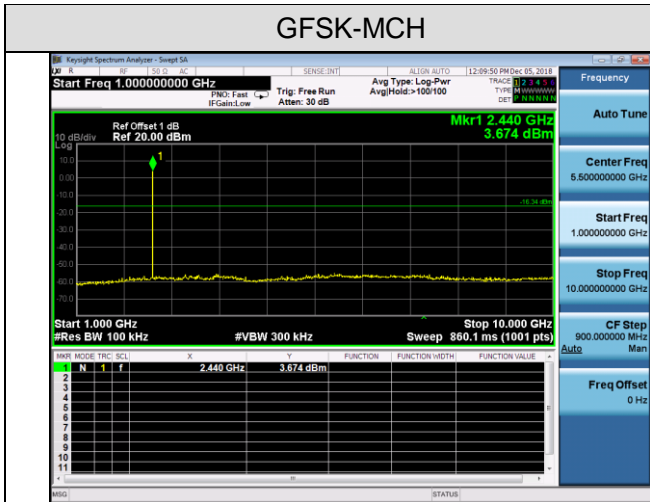

GFSK-MCH

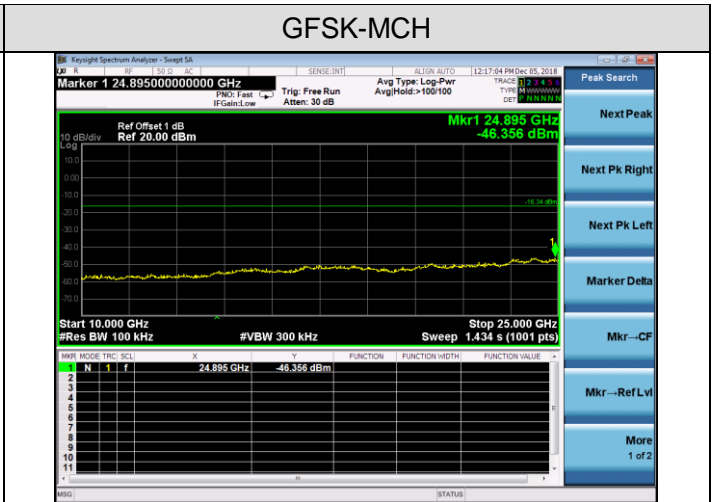

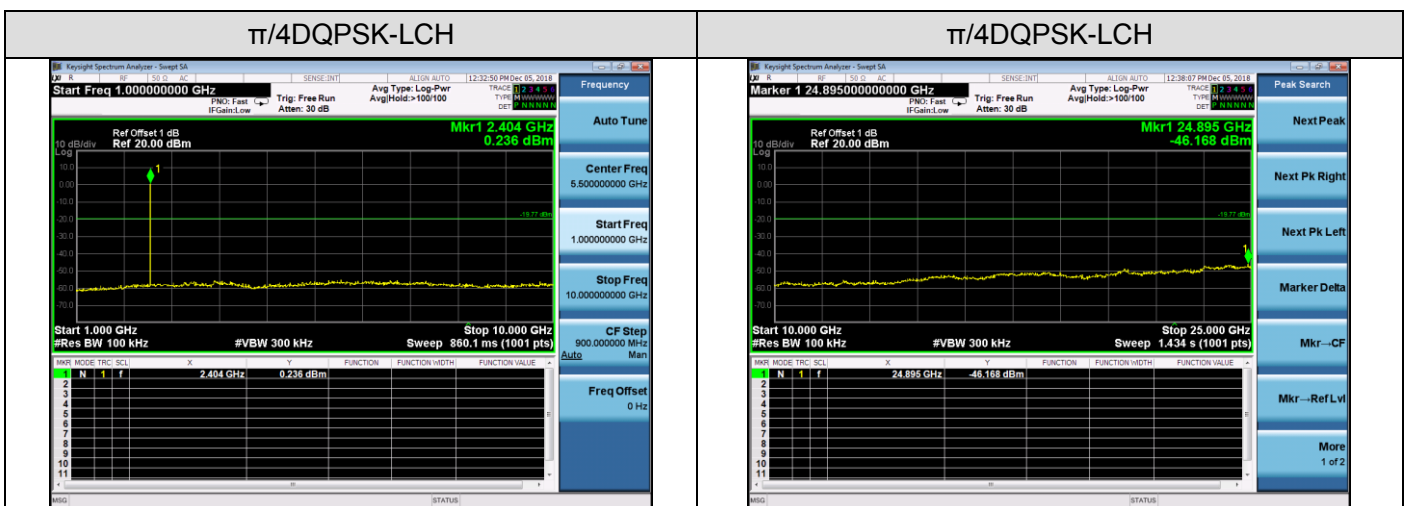
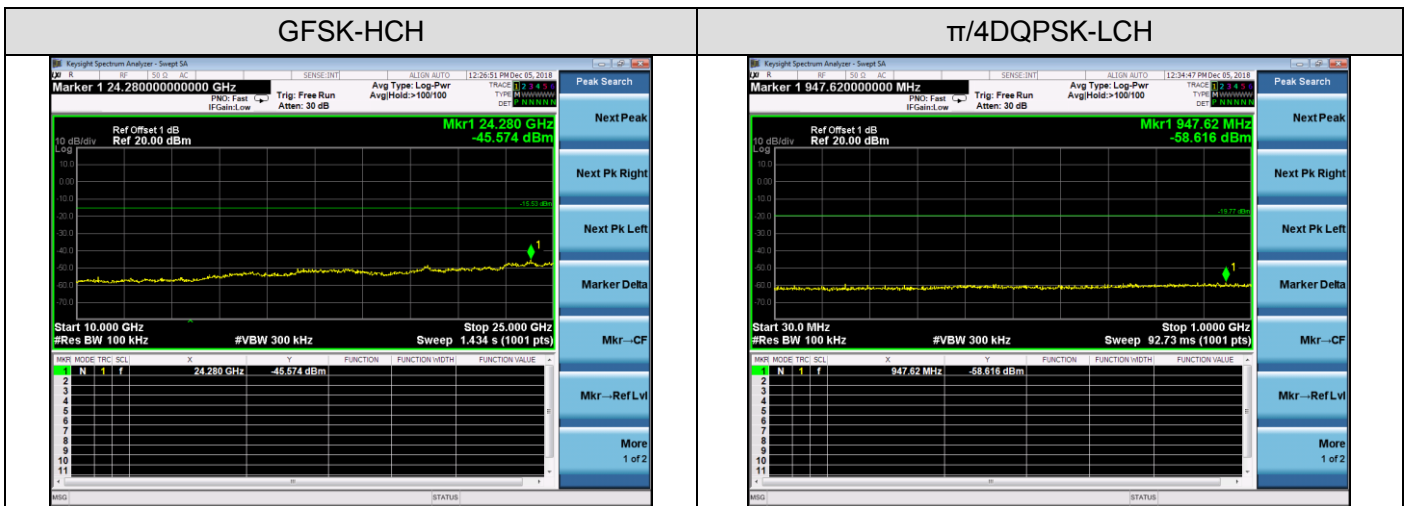
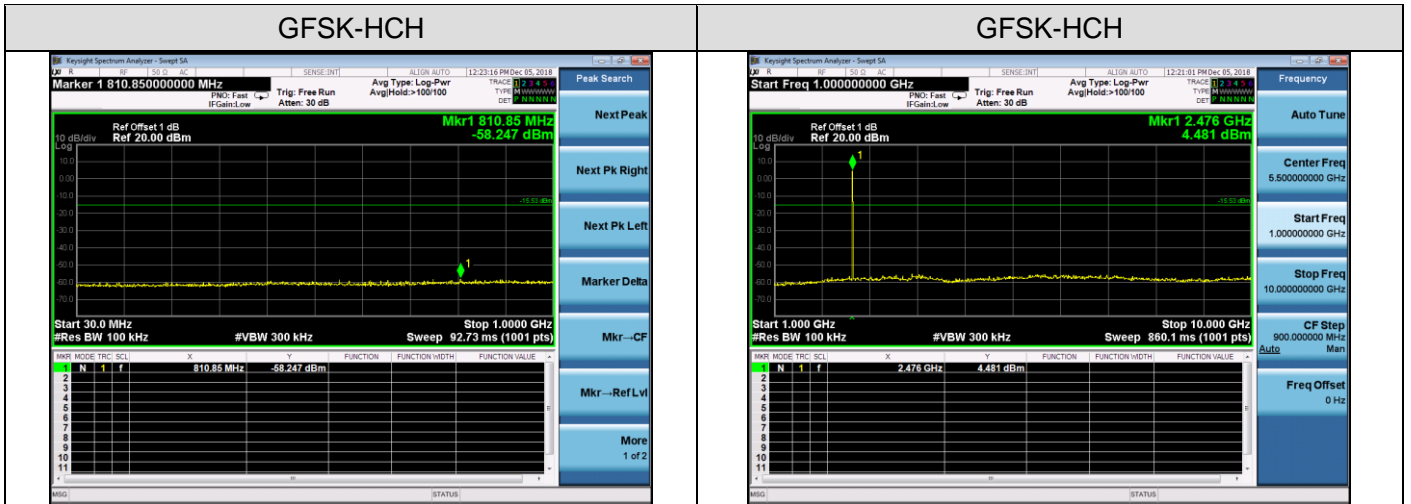



π /4DQPSK-MCH

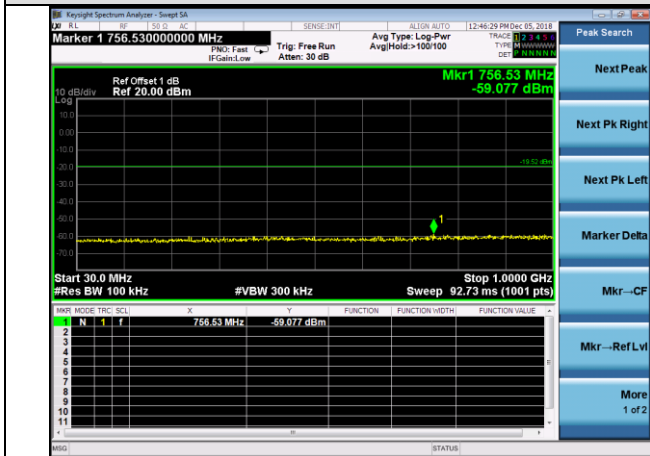

π /4DQPSK-MCH

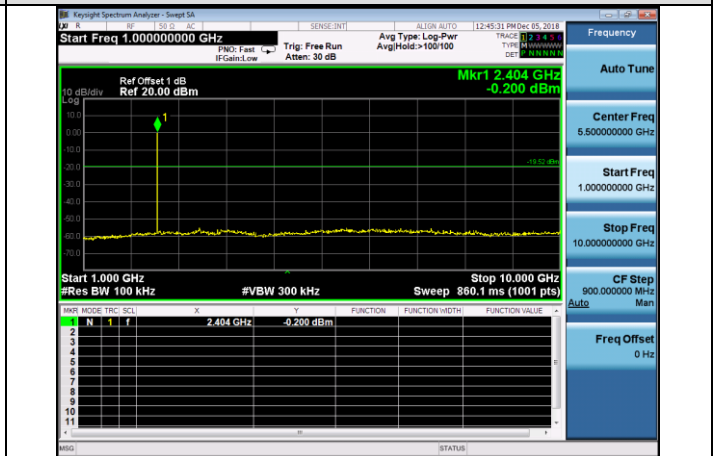

π /4DQPSK-MCH

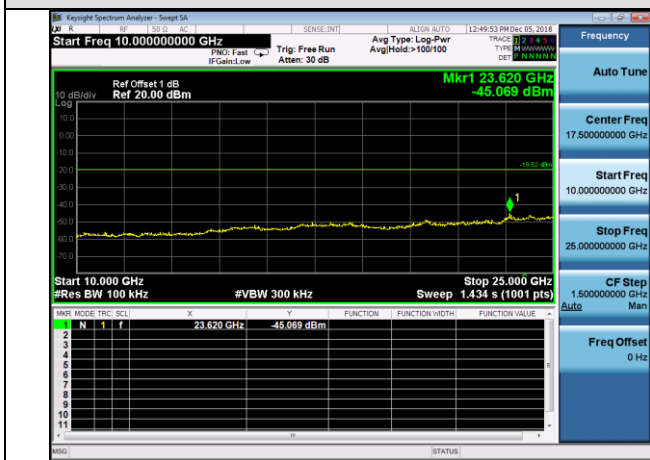

π /4DQPSK-HCH

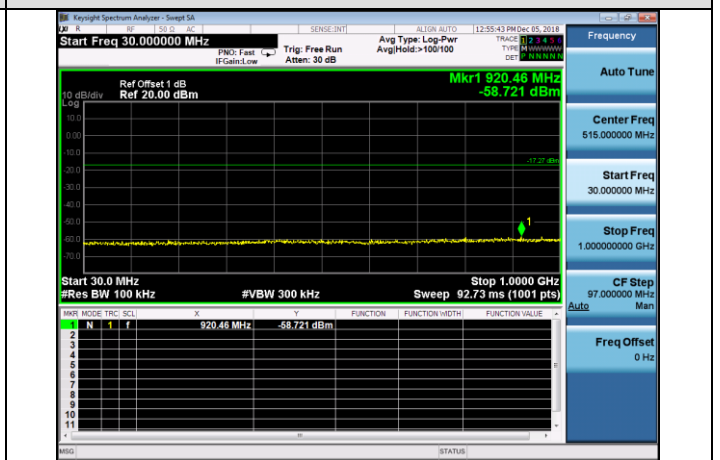

π /4DQPSK-HCH

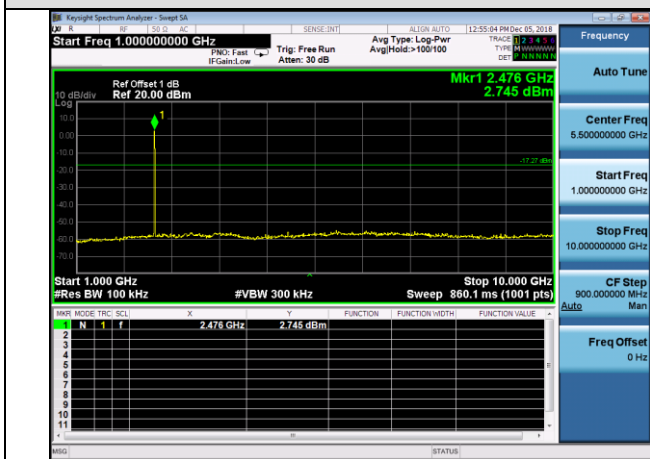

π /4DQPSK-HCH

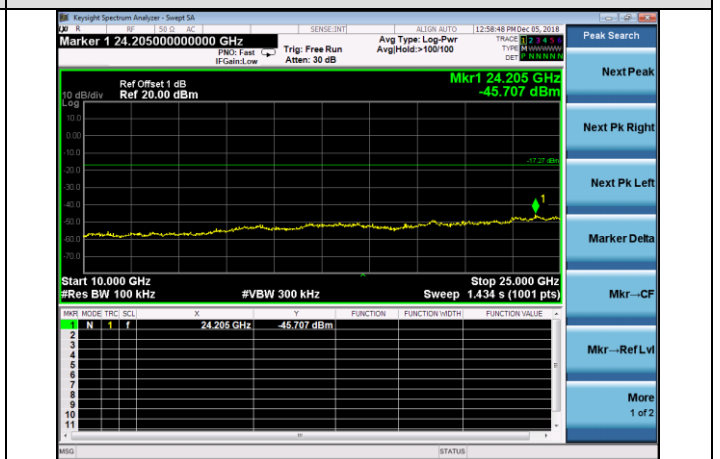

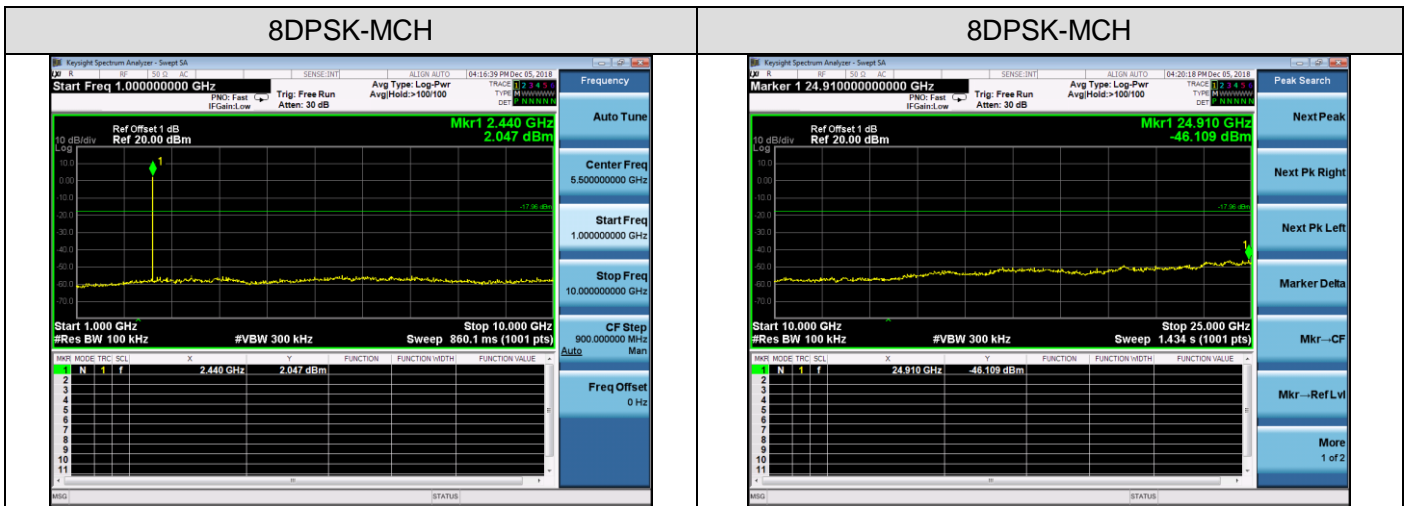
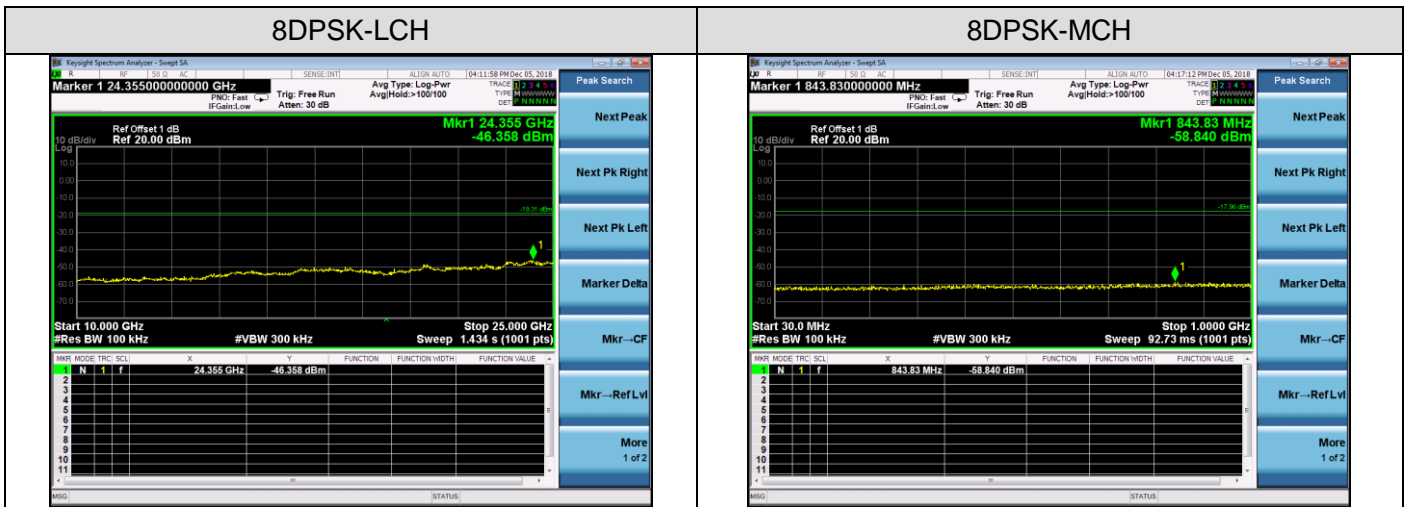
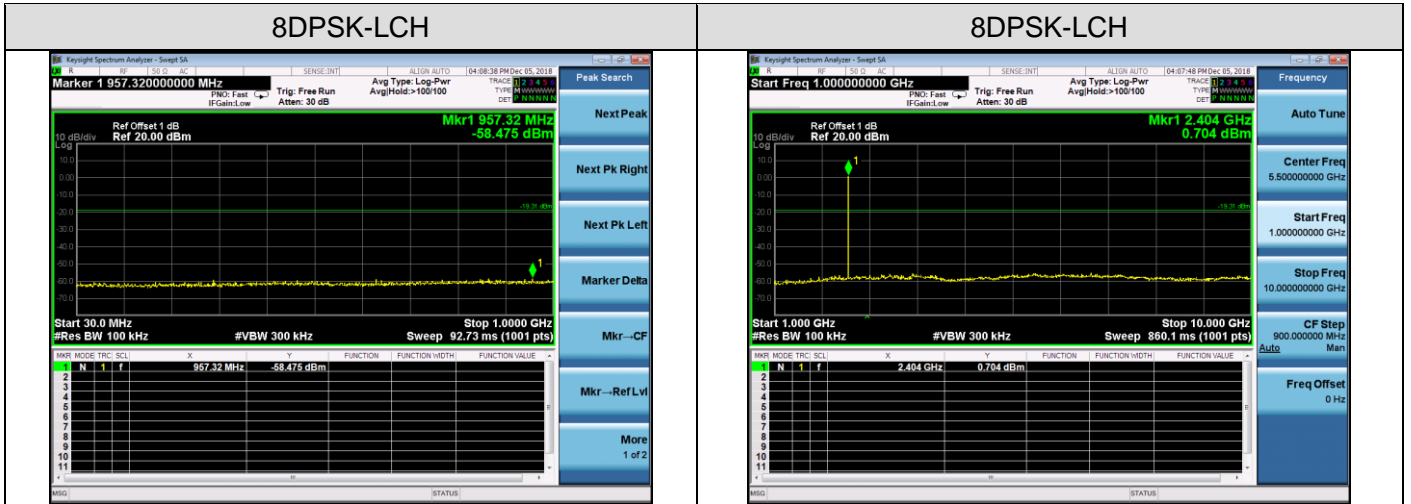



8DPSK-HCH

8DPSK-HCH

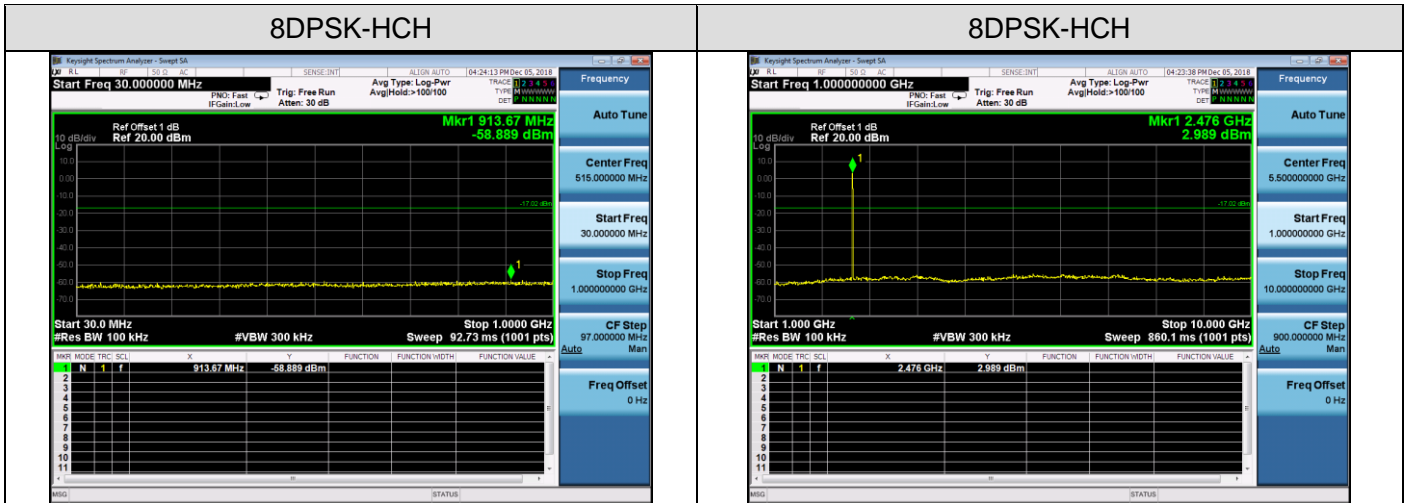

8DPSK-HCH

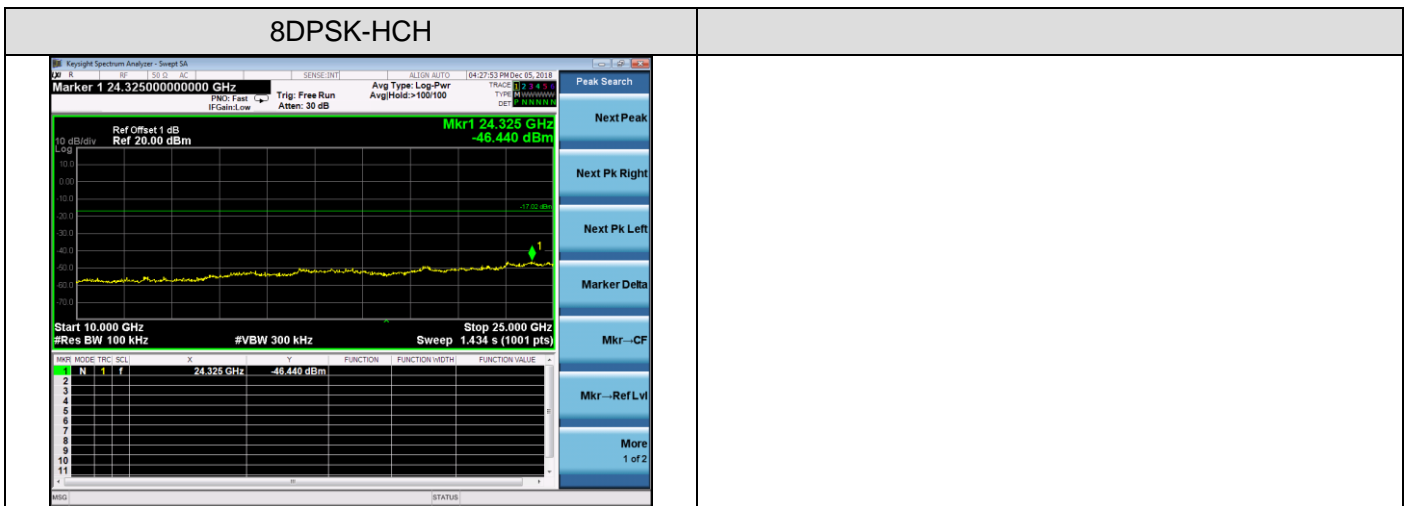



9. RADIATED EMISSION

9.1. MEASUREMENT PROCEDURE

1. The EUT was placed on the top of the turntable 0.8 or 1.5 meter above ground. The phase center of the receiving antenna mounted on the top of a height-variable antenna tower was placed 3 meters far away from the turntable.
2. Power on the EUT and all the supporting units. The turntable was rotated by 360 degrees to determine the position of the highest radiation.
3. The height of the broadband receiving antenna was varied between one meter and four meters above ground to find the maximum emissions field strength of both horizontal and vertical polarization.
4. For each suspected emissions, the antenna tower was scan (from 1 M to 4 M) and then the turntable was rotated (from 0 degree to 360 degrees) to find the maximum reading.
5. Set the test-receiver system to Peak or CISPR quasi-peak Detect Function with specified bandwidth under Maximum Hold Mode.
6. For emissions above 1GHz, use 1MHz VBW and RBW for peak reading. Then 1MHz RBW and 10Hz VBW for average reading in spectrum analyzer. Place the measurement antenna away from each area of the EUT determined to be a source of emissions at the specified measurement distance, while keeping the measurement antenna aimed at the source of emissions at each frequency of significant emissions, with polarization oriented for maximum response. The measurement antenna may have to be higher or lower than the EUT, depending on the radiation pattern of the emission and staying aimed at the emission source for receiving the maximum signal. The final measurement antenna elevation shall be that which maximizes the emissions. The measurement antenna elevation for maximum emissions shall be restricted to a range of heights of from 1 m to 4 m above the ground or reference ground plane.
7. When the radiated emissions limits are expressed in terms of the average value of the emissions, and pulsed operation is employed, the measurement field strength shall be determined by averaging over one complete pulse train, including blanking intervals, as long as the pulse train does not exceed 0.1 seconds. As an alternative (provided the transmitter operates for longer than 0.1 seconds) or in cases where the pulse train exceeds 0.1 seconds, the measured field strength shall be determined from the average absolute voltage during a 0.1 second interval during which the field strength is at its maximum values.
8. If the emissions level of the EUT in peak mode was 3 dB lower than the average limit specified, then testing will be stopped and peak values of EUT will be reported, otherwise, the emissions which do not have 3 dB margin will be repeated one by one using the quasi-peak method for below 1GHz.
9. For testing above 1GHz, the emissions level of the EUT in peak mode was lower than average limit (that means the emissions level in peak mode also complies with the limit in average mode), then testing will be stopped and peak values of EUT will be reported, otherwise, the emissions will be measured in average mode again and reported.
10. In case the emission is lower than 30MHz, loop antenna has to be used for measurement and the recorded data should be QP measured by receiver. High - Low scan is not required in this case.

9.2. TEST SETUP

RADIATED EMISSION TEST-SETUP FREQUENCY BELOW 30MHZ

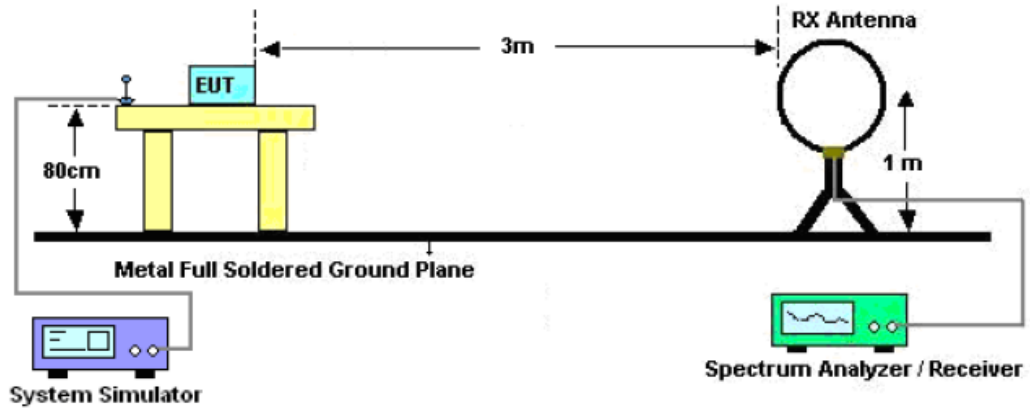

RADIATED EMISSION TEST SETUP 30MHz-1000MHz

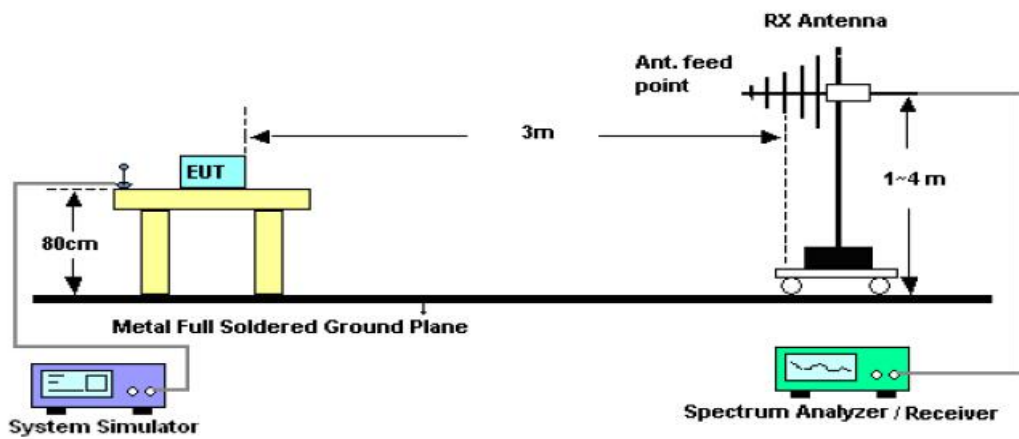

RADIATED EMISSION TEST SETUP ABOVE 1000MHz

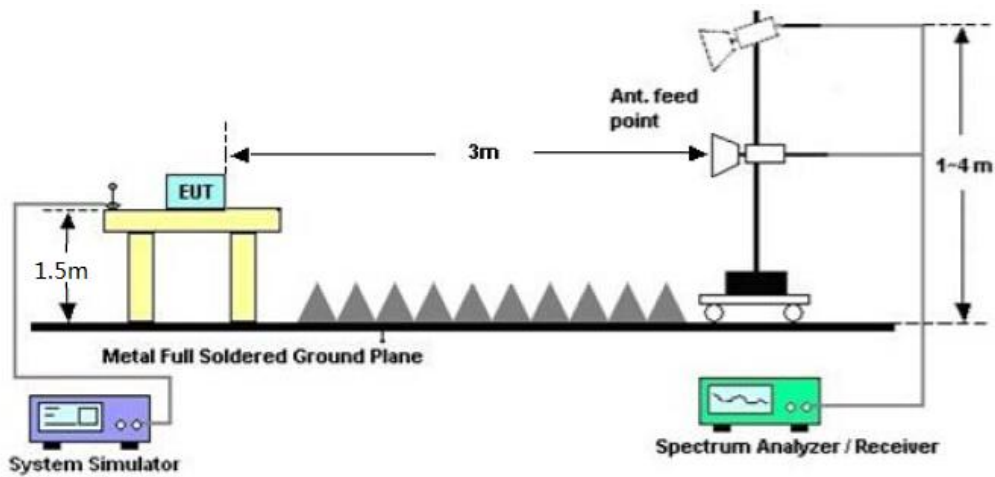



9.3. LIMITS AND MEASUREMENT RESULT

15.209(a) Limit in the below table has to be followed

Frequencies (MHz)	Field Strength (micorvolts/meter)	Measurement Distance (meters)
0.009~0.490	2400/F(KHz)	300
0.490~1.705	24000/F(KHz)	30
1.705~30.0	30	30
30~88	100	3
88~216	150	3
216~960	200	3
Above 960	500	3



9.4. TEST RESULT

RADIATED EMISSION BELOW 30MHZ

No emission found between lowest internal used/generated frequencies to 30MHz.

RADIATED EMISSION BELOW 1GHZ

RADIATED EMISSION TEST- (30MHZ-1GHZ) -HORIZONTAL

66.9 dBuV/m

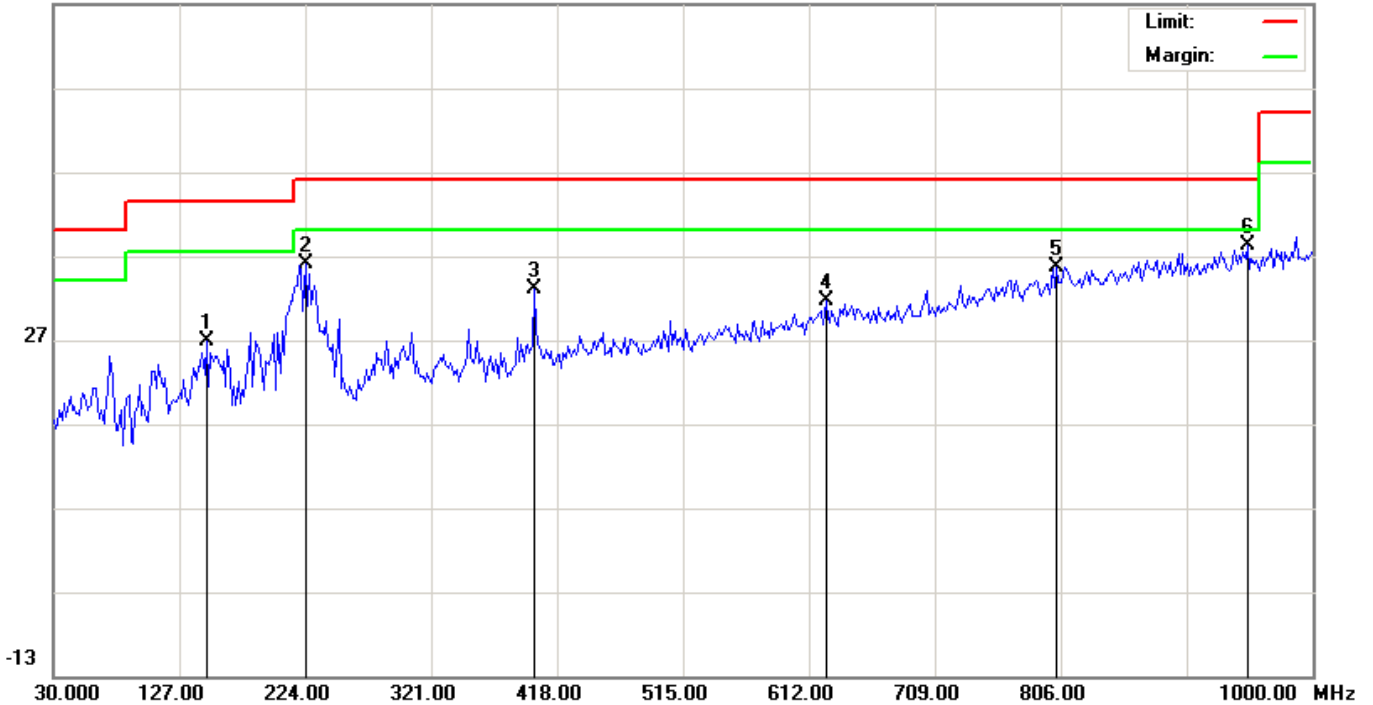

No.	Mk	Freq.	Reading	Factor	Measurement	Limit	Over	Detector	Antenna Height	Table Degree	Comment
		MHz	dBuV	dB/m	dBuV/m	dBuV/m	dB		cm	degree	
1		148.0167	6.50	20.37	26.87	43.50	-16.63	peak			
2		224.0000	16.85	19.06	35.91	46.00	-10.09	peak			
3		400.2167	7.54	25.42	32.96	46.00	-13.04	peak			
4		624.9333	1.45	30.21	31.66	46.00	-14.34	peak			
5		802.7667	1.41	34.18	35.59	46.00	-10.41	peak			
6	*	949.8833	1.73	36.53	38.26	46.00	-7.74	peak			

RESULT: PASS



RADIATED EMISSION TEST- (30MHZ-1GHZ) -VERTICAL

66.9 dBuV/m

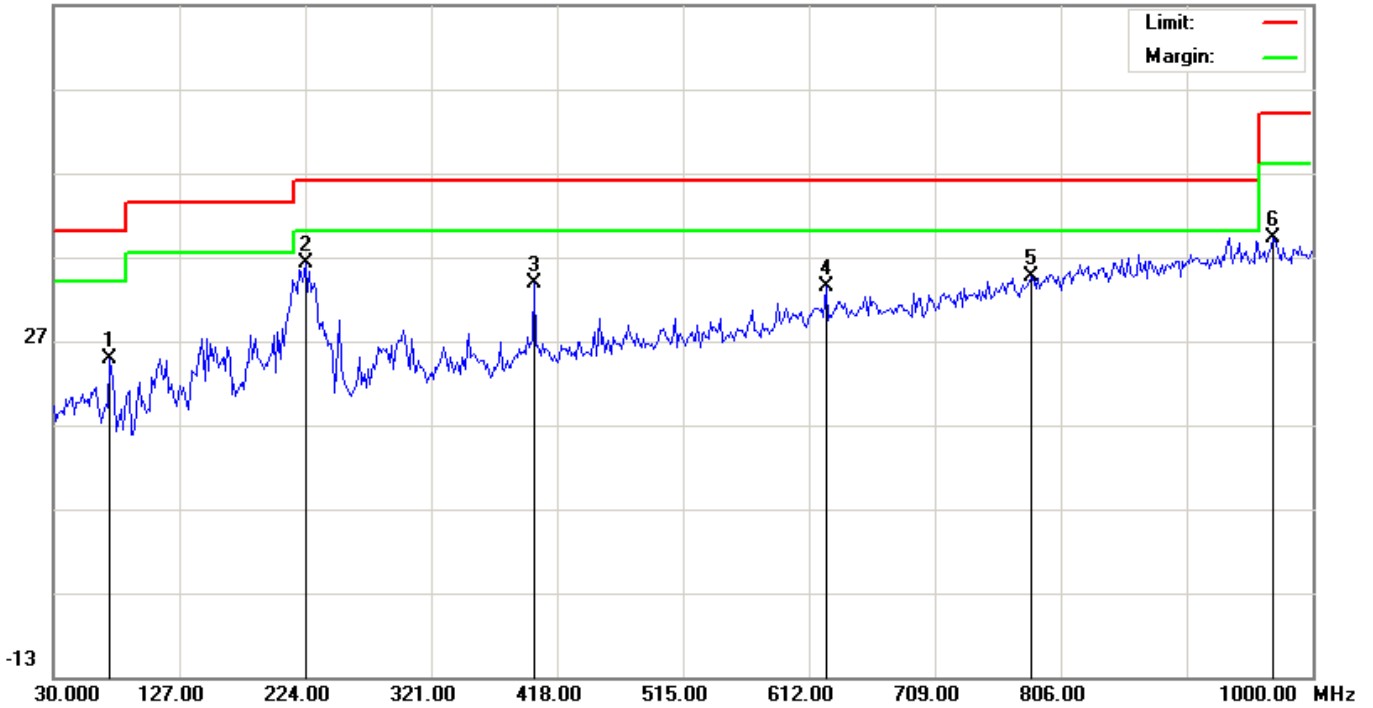

No.	Mk	Freq.	Reading	Factor	Measurement	Limit	Over	Detector	Antenna Height	Table Degree	Comment
		MHz	dBuV	dB/m	dBuV/m	dBuV/m	dB		cm	degree	
1		73.6500	7.58	17.15	24.73	40.00	-15.27	peak			
2	*	224.0000	17.17	19.06	36.23	46.00	-9.77	peak			
3		400.2167	8.38	25.42	33.80	46.00	-12.20	peak			
4		624.9333	3.17	30.21	33.38	46.00	-12.62	peak			
5		783.3667	0.85	33.67	34.52	46.00	-11.48	peak			
6		969.2833	2.50	36.77	39.27	54.00	-14.73	peak			

RESULT: PASS

Note: 1. Factor=Antenna Factor + Cable loss, Margin=Measurement-Limit.

2. The "Factor" value can be calculated automatically by software of measurement system.

3. All test modes for different EUT are pre-tested. The low channel for GFSK mode is the worst case and recorded in the report.



RADIATED EMISSION TEST- (ABOVE 1GHZ)

Frequency (MHz)	Emission Level (dB μ V/m)	Limits (dB μ V/m)	Margin (dB)	Detector Type	Comment
Low Channel (2402 MHz)					
4804	51.39	74	-22.61	Pk	Vertical
4804	36.42	54	-17.58	AV	Vertical
4804	50.34	74	-23.66	Pk	Horizontal
4804	38.19	54	-15.81	AV	Horizontal
Mid Channel (2441 MHz)					
4882	52.42	74	-21.58	Pk	Vertical
4882	38.19	54	-15.81	AV	Vertical
4882	51.65	74	-22.35	Pk	Horizontal
4882	37.33	54	-16.67	AV	Horizontal
High Channel (2480 MHz)					
4960	50.99	74	-23.01	pk	Vertical
4960	35.34	54	-18.66	AV	Vertical
4960	50.42	74	-23.58	pk	Horizontal
4960	40.19	54	-13.81	AV	Horizontal

RESULT: PASS**Note:**

1. 1GHz~25GHz:(Scan with GFSK, $\pi/4$ -DQPSK,8DPSK, the worst case is GFSK Mode, No recording in the test report at least have 20dB margin)
2. Margin = Emission Level - Limit



10. BAND EDGE EMISSION

10.1. MEASUREMENT PROCEDURE

1. The transmitter output is connected to a spectrum analyzer. The resolution bandwidth is set to 100kHz. The video bandwidth is set to 300kHz.
2. Transmitter set to the normal hopping mode at 2.4 and 2.4835 GHz.

10.2. TEST SET-UP

Radiated same as 10.2

Conducted set up

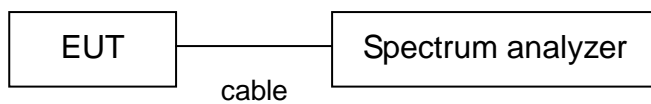

**10.3. RADIATED TEST RESULT**

Frequency	Emission Level	Limits	Margin	Detector	Comment
(MHz)	(dB μ V/m)	(dB μ V/m)	(dB)	Type	
GFSK					
2399.9	50.14	74	-23.86	peak	Vertical
2399.9	38.85	54	-15.15	AVG	Vertical
2399.9	49.36	74	-24.64	peak	Horizontal
2399.9	39.42	54	-14.58	AVG	Horizontal
2483.6	52.18	74	-21.82	peak	Vertical
2483.6	34.94	54	-19.06	AVG	Vertical
2483.6	51.99	74	-22.01	peak	Horizontal
2483.6	36.84	54	-17.16	AVG	Horizontal
$\pi/4$ -DQPSK					
2399.9	49.44	74	-24.56	peak	Vertical
2399.9	39.62	54	-14.38	AVG	Vertical
2399.9	49.85	74	-24.15	peak	Horizontal
2399.9	39.11	54	-14.89	AVG	Horizontal
2483.6	51.30	74	-22.70	peak	Vertical
2483.6	38.93	54	-15.07	AVG	Vertical
2483.6	49.72	74	-24.28	peak	Horizontal
2483.6	38.26	54	-15.74	AVG	Horizontal
8DPSK					
2399.9	50.08	74	-23.92	peak	Vertical
2399.9	38.04	54	-15.96	AVG	Vertical
2399.9	49.29	74	-24.71	peak	Horizontal
2399.9	39.07	54	-14.93	AVG	Horizontal
2483.6	49.80	74	-24.20	peak	Vertical
2483.6	35.07	54	-18.93	AVG	Vertical
2483.6	52.43	74	-21.57	peak	Horizontal
2483.6	39.32	54	-14.68	AVG	Horizontal

RESULT: PASS

Note: The other modes radiation emission have enough 20dB margin.

$$\text{Margin} = \text{Emission Level} - \text{Limit}$$



10.4 CONDUCTED TEST RESULT

Test Graph

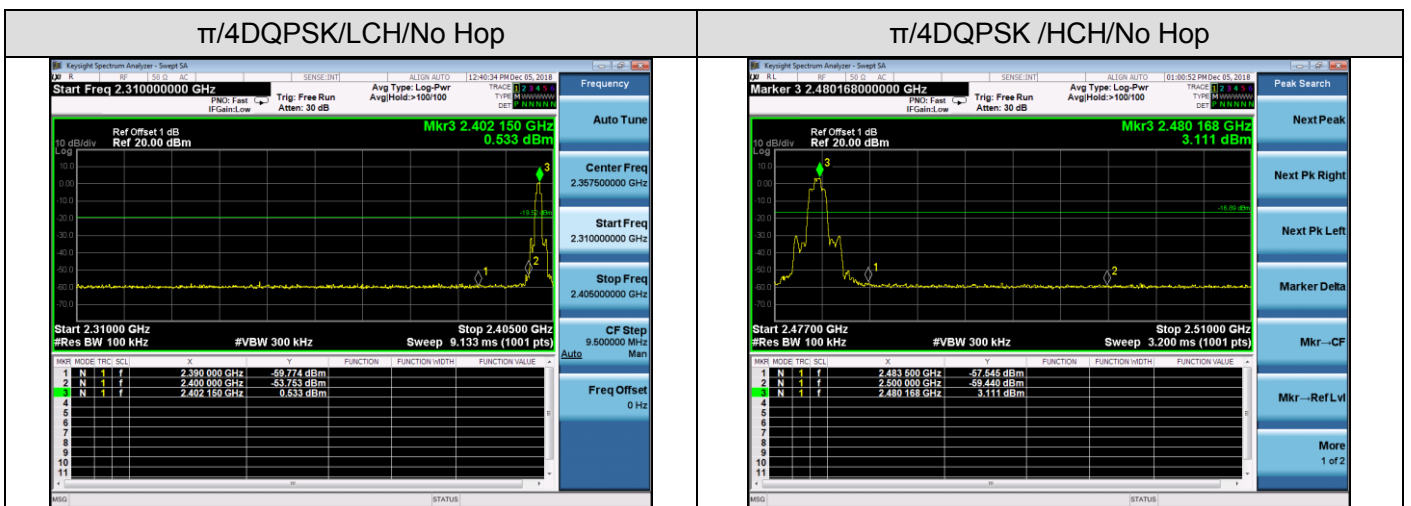
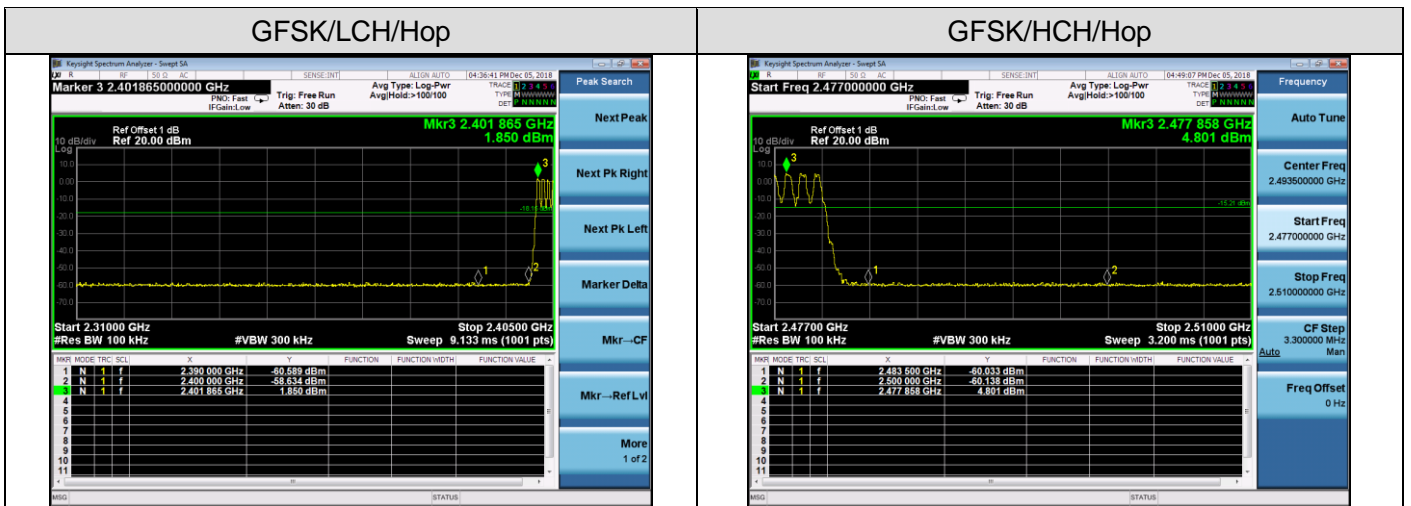
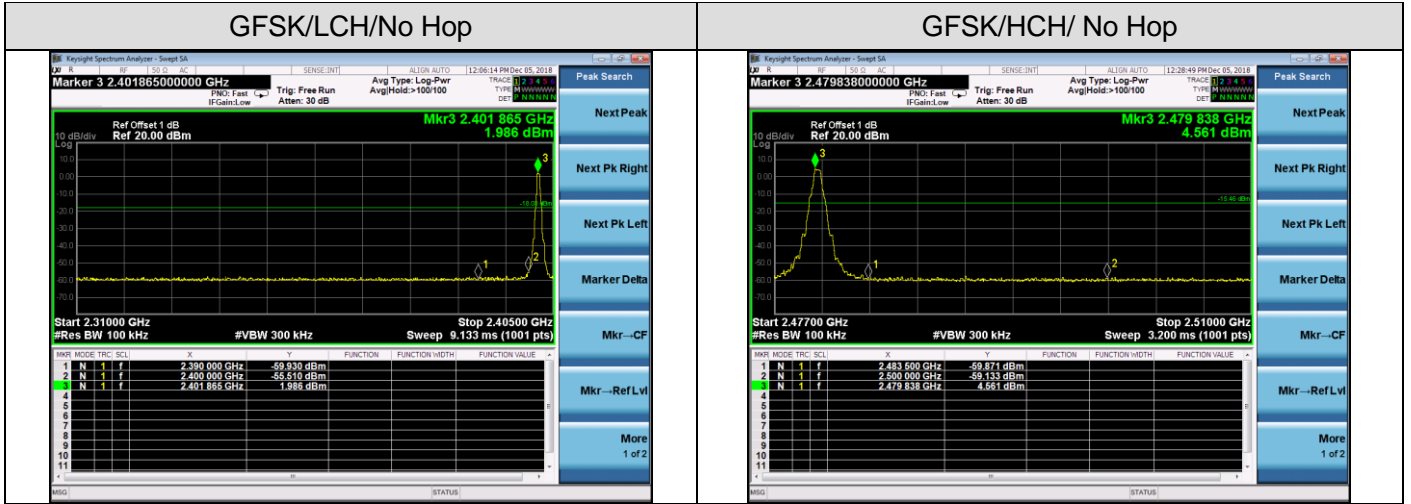

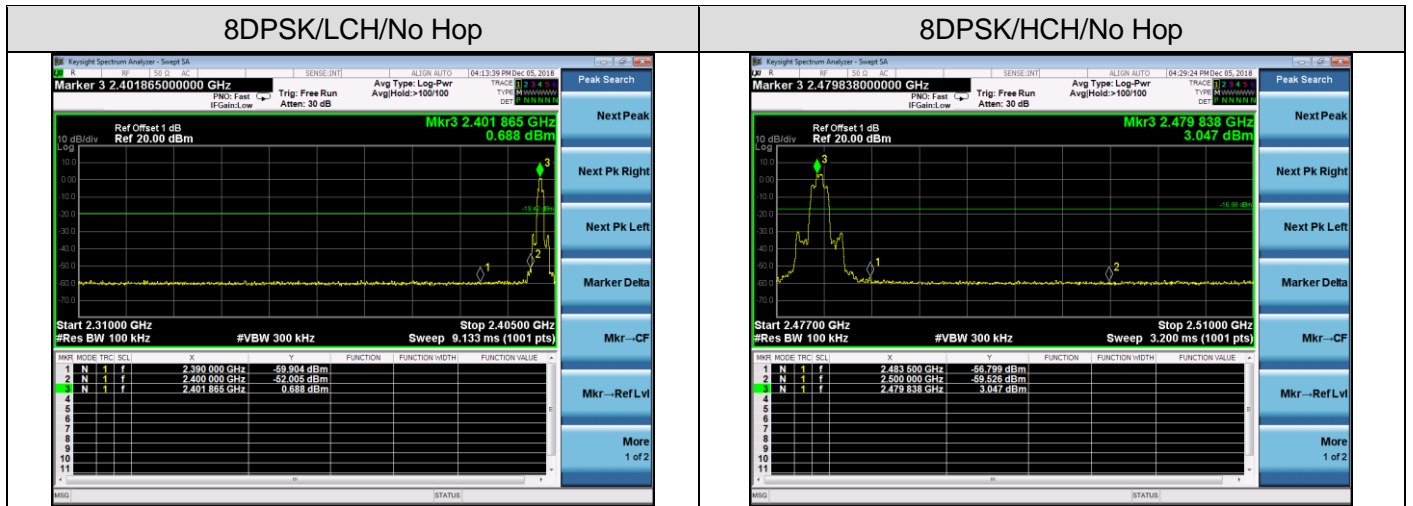

Note: All modes were tested, only the worst case record in the report.



12. TIME OF OCCUPANCY (DWELL TIME)

12.1. MEASUREMENT PROCEDURE

The EUT shall have its hopping function enabled. Use the following spectrum analyzer settings:

1. Span: Zero span, centered on a hopping channel.
2. RBW shall be \leq channel spacing and where possible RBW should be set $\gg 1/T$, where T is the expected dwell time per channel.
3. Sweep: As necessary to capture the entire dwell time per hopping channel; where possible use a video trigger and trigger delay so that the transmitted signal starts a little to the right of the start of the plot. The trigger level might need slight adjustment to prevent triggering when the system hops on an adjacent channel.
4. Detector function: Peak. Trace: Max hold.
5. Use the marker-delta function to determine the transmit time per hop.
6. Using the following equation:

The dwell time is calculated with the following formula:

$$\text{Dwell time} = t_{\text{pulse}} \times n_{\text{hops}} / \text{number of channels} \times 31.6 \text{ s}$$

Where:

t_{pulse} is the measured pulse time (pls. refer the plots of the spectrum analyser above) [s],

n_{hops} is the number of hops per second in the actual operating mode of the transmitter [1/s].

The hopping rate of the system is 1600 hops per second and the system uses 79 channels. For this reason one time slot has a length of 625 μs .

With the used hopping mode (DH5) a packet need 5 timeslots for transmitting and the next timeslot for receiving. So the system makes in worst case 266,67 hops per second in transmit mode ($n_{\text{hops}} = 266.667$ 1/s)

12.2. TEST SETUP (BLOCK DIAGRAM OF CONFIGURATION)

Same as described in section 8.2

12.3. MEASUREMENT EQUIPMENT USED

The same as described in section 6



12.4. LIMITS AND MEASUREMENT RESULT

Channel.	Burst Width [ms/hop/ch]	Dwell Time[ms]	Verdict	Limit (ms)
LCH	2.867	305.8137	PASS	400
MCH	2.867	305.8137	PASS	400
HCH	2.867	305.8137	PASS	400

Note: The DH5 for GFSK modulation is the worst case and recorded in the report.

Test Graph

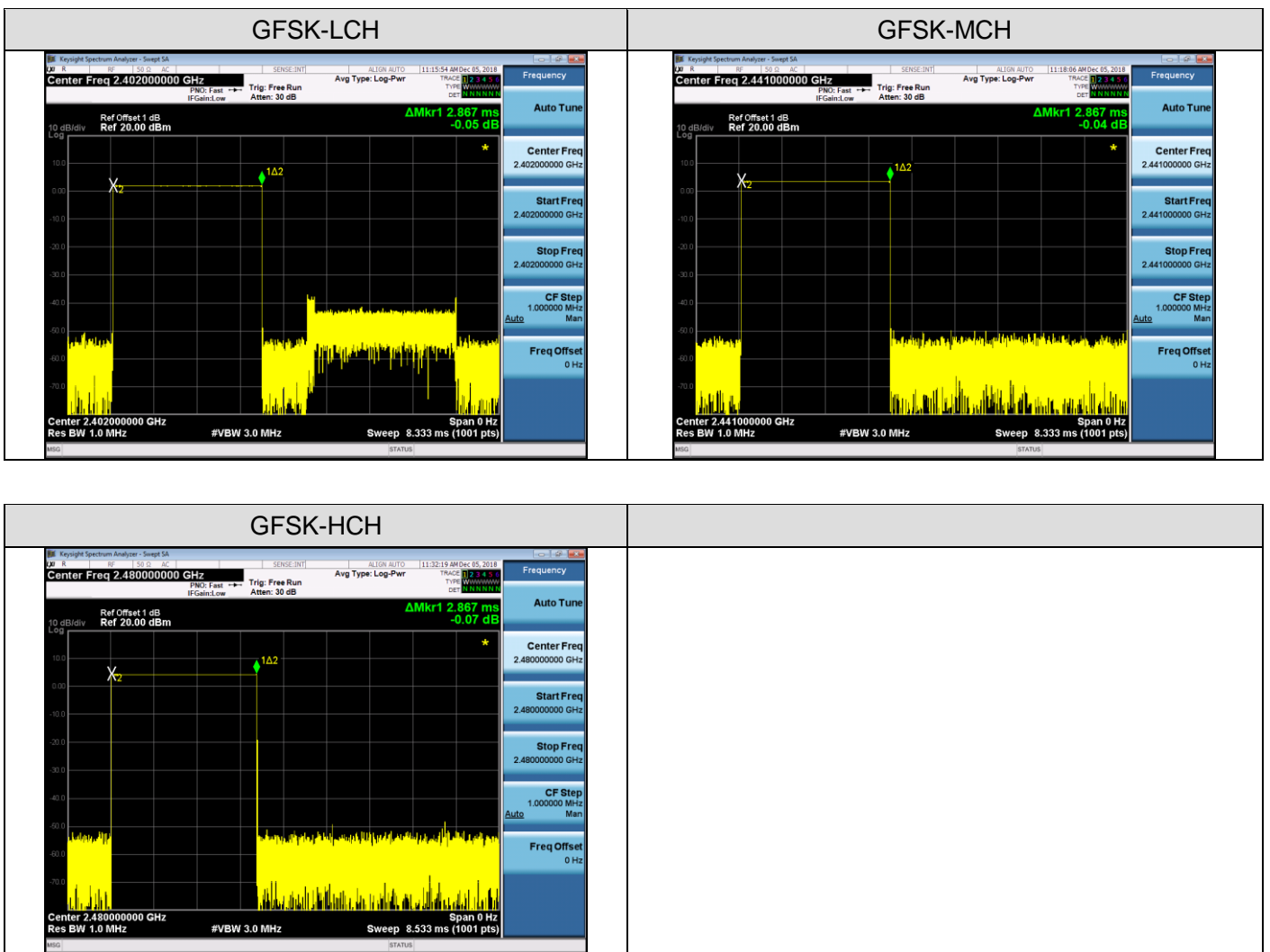



13. FREQUENCY SEPARATION

13.1. MEASUREMENT PROCEDURE

1. Place the EUT on the table and set it in transmitting mode
2. Remove the antenna from the EUT and then connect a low RF cable from the antenna port to the spectrum analyzer
3. Set Span = wide enough to capture the peaks of two adjacent channels Resolution (or IF) Bandwidth (RBW) \geq 1% of the span Video (or Average) Bandwidth (VBW) \geq RBW; Sweep = auto; Detector function = peak; Trace = max hold

13.2. TEST SETUP (BLOCK DIAGRAM OF CONFIGURATION)

Same as described in section 6.2

13.3. MEASUREMENT EQUIPMENT USED

The same as described in section 6.3

13.4. LIMITS AND MEASUREMENT RESULT

Mode	Channel.	Carrier Frequency Separation [MHz]	Verdict
GFSK	Hop	-1.002	PASS

Note: All modes were tested, only the worst case record in the report.

Test Graph

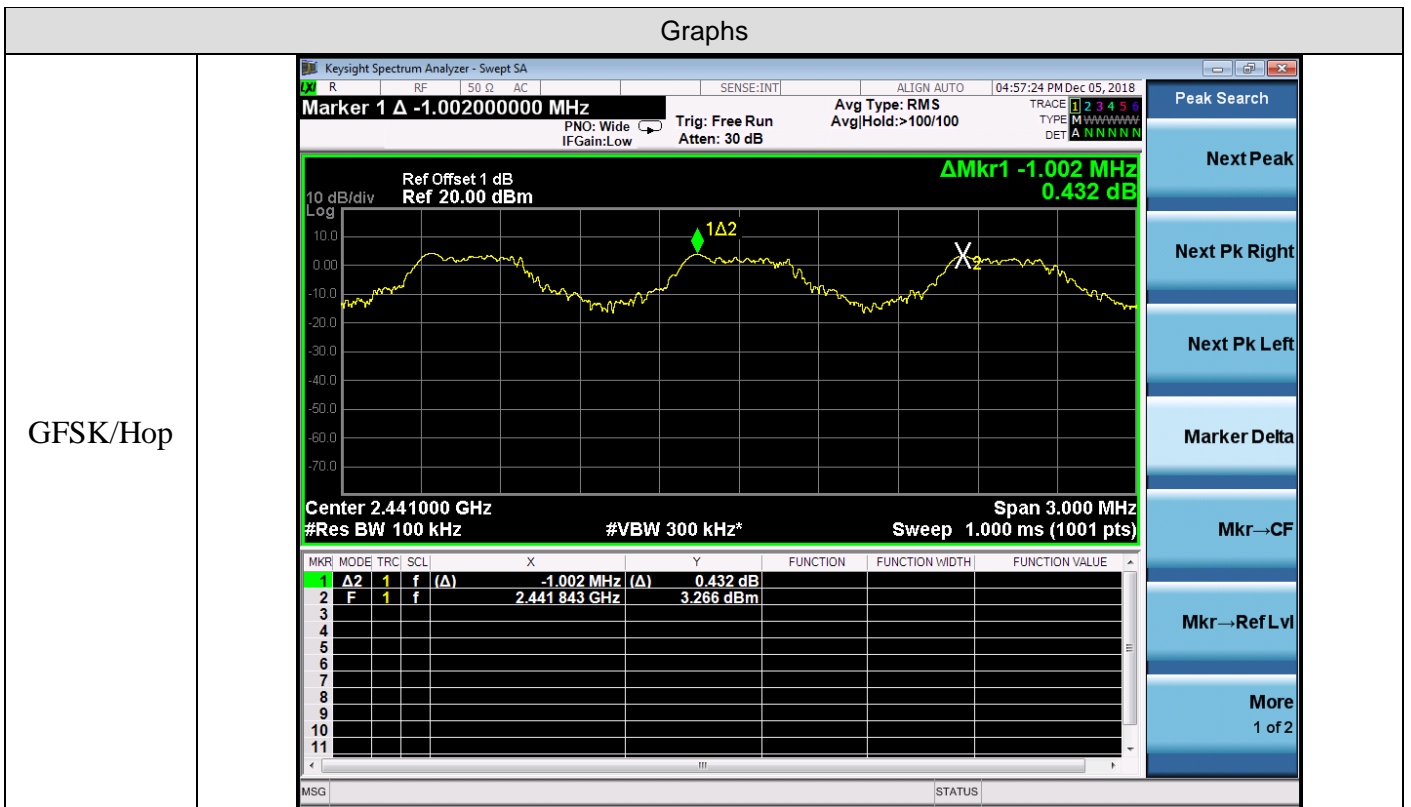



APPENDIX A: PHOTOGRAPHS OF TEST SETUP

RADIATED SPURIOUS EMISSION

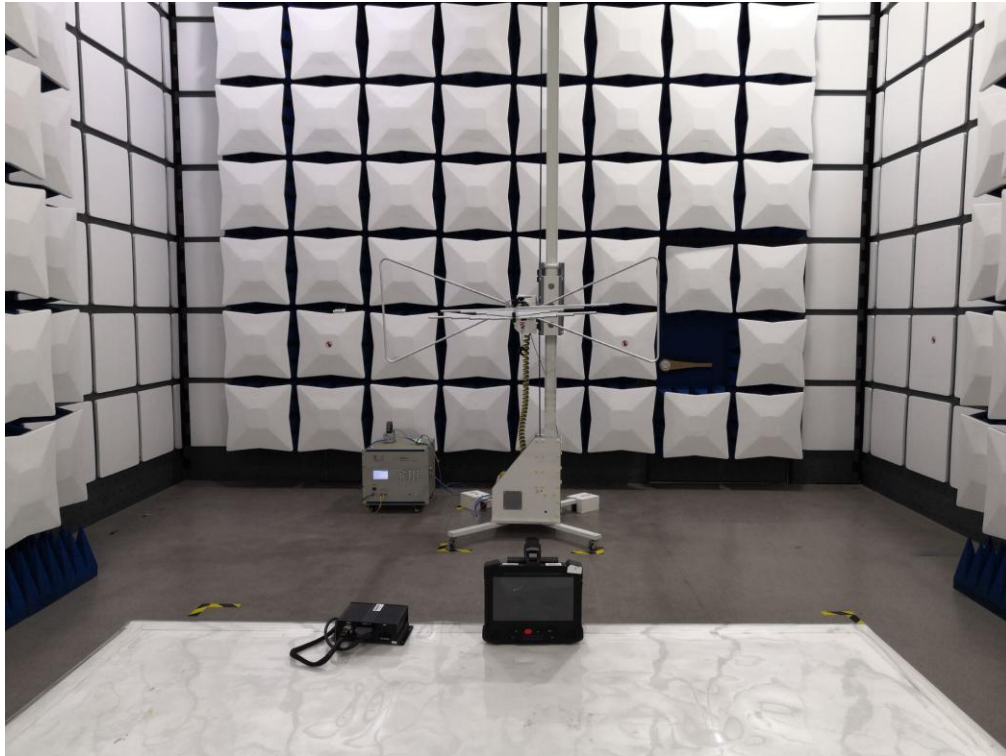

RADIATED EMISSION ABOVE 1G TEST SETUP



----END OF REPORT----