

# TEST REPORT

**FCC ID: 2AM6L-M1NTKH**

**Product: MDVR**

**Model No.: M1N-TKH0401**

**Additional Model No.: N/A**

**Trade Mark: N/A**

**Report No.: TCT210423E044**

**Issued Date: May 26, 2021**

Issued for:

**Streamax Technology Co., Ltd.**

**21-23/F, Building B1, Zhiyuan, No. 1001, Xueyuan Avenue, Nanshan District,  
Shenzhen, Guangdong, 518055 China**

Issued By:

**Shenzhen Tongce Testing Lab.**

**TCT Testing Industrial Park, Fuqiao 5th Industrial Zone, Fuhai Street, Bao'an  
District, Shenzhen, Guangdong, 518103, People's Republic of China**

**TEL: +86-755-27673339**

**FAX: +86-755-27673332**

**Note:** *This report shall not be reproduced except in full, without the written approval of Shenzhen Tongce Testing Lab.*

*This document may be altered or revised by Shenzhen Tongce Testing Lab personnel only, and shall be noted in the revision section of the document. The test results in the report only apply to the tested sample.*

## TABLE OF CONTENTS

<b>1. Test Certification .....</b>	<b>3</b>
<b>2. Test Result Summary .....</b>	<b>4</b>
<b>3. EUT Description.....</b>	<b>5</b>
<b>4. General Information.....</b>	<b>5</b>
4.1. Test environment and mode.....	6
4.2. Test Mode.....	8
4.3. Description of Support Units.....	9
4.4. Configuration of Tested System .....	10
4.5. Measurement Results Explanation Example.....	10
<b>5. Facilities and Accreditations .....</b>	<b>11</b>
5.1. Facilities .....	11
5.2. Location .....	11
5.3. Measurement Uncertainty.....	11
<b>6. Test Results and Measurement Data .....</b>	<b>12</b>
6.1. Conducted Output Power Measurement .....	12
6.2. Peak to Average Ratio.....	14
6.3. 99% Occupied Bandwidth and 26dB Bandwidth Measurement .....	19
6.4. Band Edge and Conducted Spurious Emission Measurement .....	24
6.5. Effective Radiated Power and Effective Isotropic Radiated Power Measurement .....	31
6.6. Field Strength of Spurious Radiation Measurement .....	37
6.7. Frequency Stability Measurement .....	43

**Appendix A: Photographs of Test Setup**

**Appendix B: Photographs of EUT**

## 1. Test Certification

<b>Product:</b>	MDVR
<b>Model No.:</b>	M1N-TKH0401
<b>Additional Model No.:</b>	N/A
<b>Trade Mark:</b>	N/A
<b>Applicant:</b>	Streamax Technology Co., Ltd.
<b>Address:</b>	21-23/F, Building B1, Zhiyuan, No. 1001, Xueyuan Avenue, Nanshan District, Shenzhen, Guangdong, 518055 China
<b>Manufacturer:</b>	Streamax Technology Co., Ltd.
<b>Address:</b>	21-23/F, Building B1, Zhiyuan, No. 1001, Xueyuan Avenue, Nanshan District, Shenzhen, Guangdong, 518055 China
<b>Date of Test:</b>	Apr. 26, 2021 – May 25, 2021
<b>Applicable Standards:</b>	FCC CFR Title 47 Part 2 FCC CFR Title 47 Part22 FCC CFR Title 47 Part24 FCC CFR Title 47 Part27

The above equipment has been tested by Shenzhen Tongce Testing Lab and found compliance with the requirements set forth in the technical standards mentioned above. The results of testing in this report apply only to the product/system, which was tested. Other similar equipment will not necessarily produce the same results due to production tolerance and measurement uncertainties.

Tested By:



---

Brews Xu

Date:

May 25, 2021

Reviewed By:



---

Beryl Zhao

Date:

May 26, 2021

Approved By:



---

Tomsin

Date:

May 26, 2021

## 2. Test Result Summary

Requirement	CFR 47 Section	Result
Conducted Output Power	§22.913; §2.1046 §24.232; §27.50(d)	PASS
Peak-to-Average Ratio	§2.1046; §24.232(d) §22.913; §27.50(d)	PASS
Effective Radiated Power	§2.1046; §22.913(a) §24.232; §27.50(d)	PASS
Equivalent Isotropic Radiated Power	§2.1046; §22.913(a) §24.232; §27.50(d)	PASS
Occupied Bandwidth	§2.1049	PASS
Band Edge	§2.1051 §22.917(a) §24.238(a) §27.53(g)	PASS
Conducted Spurious Emission	§2.1051; §22.917 §24.238; §27.53(h)	PASS
Field Strength of Spurious Radiation	§2.1053; §22.917(a) §24.238; §27.53(g)	PASS
Frequency Stability for Temperature & Voltage	§2.1055; §22.355 §24.235; ;§27.54	PASS

**Note:**

1. PASS: Test item meets the requirement.
2. Fail: Test item does not meet the requirement.
3. N/A: Test case does not apply to the test object.
4. The test result judgment is decided by the limit of test standard.

### 3. EUT Description

<b>Product:</b>	MDVR
<b>Model No.:</b>	M1N-TKH0401
<b>Additional Model No.:</b>	N/A
<b>Trade Mark:</b>	<b>N/A</b>
<b>3G Version:</b>	WCDMA: R99 HSDPA: Release 5 HSUPA: Release 6
<b>Tx Frequency:</b>	WCDMA Band V: 826.4MHz ~ 846.6MHz WCDMA Band IV: 1712.4MHz ~ 1752.6MHz WCDMA Band II: 1852.4MHz ~ 1907.6MHz
<b>Rx Frequency:</b>	WCDMA Band V: 871.4MHz ~ 891.6MHz WCDMA Band IV: 2112.4MHz ~ 2152.6MHz WCDMA Band II: 1932.4MHz ~ 1987.6MHz
<b>Maximum Output Power to Antenna:</b>	WCDMA Band V: 23.21dBm WCDMA Band IV: 23.21dBm WCDMA Band II: 23.15dBm
<b>99% Occupied Bandwidth:</b>	WCDMA Band V: 4M16F9W WCDMA Band IV: 4M13F9W WCDMA Band II: 4M14F9W
<b>Type of Modulation:</b>	WCDMA/HSDPA/HSUPA: QPSK
<b>Antenna Type:</b>	Internal Antenna
<b>Antenna Gain:</b>	WCDMA Band V: 1.9dBi WCDMA Band IV: 1.27dBi WCDMA Band II: 0.54dBi
<b>Power Supply:</b>	DC 12V

**Note:** The antenna gain listed in this report is provided by applicant, and the test laboratory is not responsible for this parameter.

## 4. General Information

### 4.1. Test environment and mode

Operating Environment:	
Temperature:	25.0 °C
Humidity:	56 % RH
Atmospheric Pressure:	1010 mbar
Test Mode:	
Operation mode:	Keep the EUT in communication with CMU200 and select channel with modulation

The sample was placed 0.8m & 1.5m for the measurement below & above 1GHz above the ground plane of 3m chamber. Measurements in both horizontal and vertical polarities were performed. During the test, each emission was maximized by: having the EUT continuously working, investigated all operating modes, rotated about all 3 axis (X, Y & Z) and considered typical configuration to obtain worst position, manipulating interconnecting cables, rotating the turntable, varying antenna height from 1m to 4m in both horizontal and vertical polarizations. The emissions worst-case( Z axis) are shown in Test Results of the following pages.

**Description Operation Frequency**

WCDMA Band IV		WCDMA Band V		WCDMA Band II	
Channel:	Frequency (MHz)	Channel:	Frequency (MHz)	Channel:	Frequency (MHz)
1312	1712.4	4132	826.40	9262	1852.40
....	....	4133	826.60	9263	1852.60
....	....	....	....	....	....
....	....	4182	836.40	9399	1879.80
1413	1732.6	4183	836.60	9400	1880.00
....	....	4184	836.80	9401	1880.20
....	....	...	...	...	...
1513	1752.6	4233	846.60	9538	1907.60

## 4.2. Test Mode

Antenna port conducted and radiated test items were performed according to KDB 971168 D01 Power Meas. License Digital Systems v03r01 with maximum output power. Radiated measurements were performed with rotating EUT in different three orthogonal test planes to find the maximum emission.

Radiated emissions were investigated as following frequency range:

1. 30 MHz to 10000 MHz for WCDMA Band V.
2. 30 MHz to 20000 MHz for WCDMA Band II and WCDMA Band IV.

All modes and data rates and positions were investigated.

Test modes are chosen to be reported as the worst case configuration below:

Test Mode		
Band	Radiated TCs	Conducted TCs
WCDMA Band V	HSPA Link	HSPA Link
WCDMA Band IV	HSPA Link	HSPA Link
WCDM Band II	HSPA Link	HSPA Link

**Note:** The maximum power levels are chosen to test as the worst case configuration as follows:  
RMC 12.2Kbps mode for WCDMA band V, WCDMA band IV and WCDMA band II, only these modes were used for all tests. In addition to above worst-case test, below investigating on all data rates and all modes are compliance with each FCC test case which has specific test limits. For spurious emissions at antenna port, the EUT was investigated the band edges on low and high channels, and the unwanted spurious emissions on middle channel for all modes, the results are PASS, then only the worst-results were reported in the test report.



### 4.3. Description of Support Units

The EUT has been tested as an independent unit together with other necessary accessories or support units. The following support units or accessories were used to form a representative test configuration during the tests.

Equipment	Model No.	Serial No.	FCC ID	Trade Name
/	/	/	/	/

**Note:**

1. All the equipment/cables were placed in the worst-case configuration to maximize the emission during the test.
2. Grounding was established in accordance with the manufacturer's requirements and conditions for the intended use.

#### 4.4. Configuration of Tested System

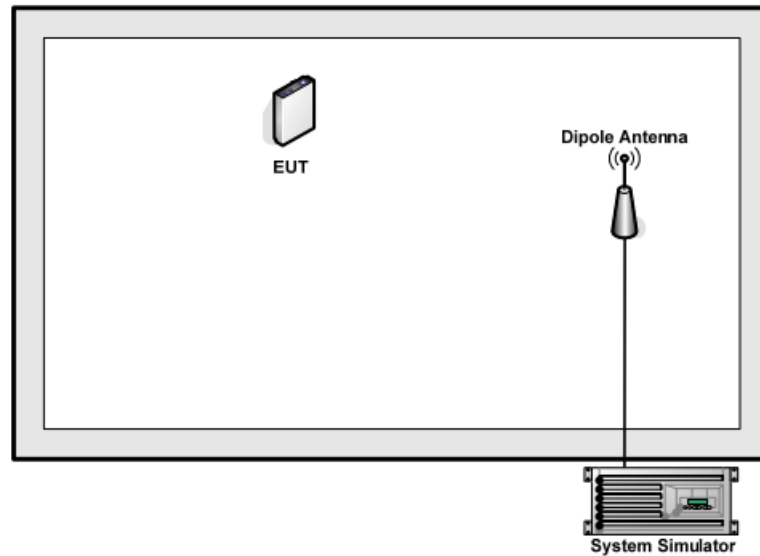

#### 4.5. Measurement Results Explanation Example

**For all conducted test items:**

The offset level is set in the spectrum analyzer to compensate the RF cable loss and attenuator factor between RF conducted output port and spectrum analyzer. With the offset compensation, the spectrum analyzer reading level will be exactly the RF output level. The spectrum analyzer offset is derived from RF cable loss and attenuator factor.

*Offset = RF cable loss + attenuator factor.*

The following shows an offset computation example with RF cable loss 3 dB and a 5dB attenuator.

Example:  $Offset (dB) = RF\ cable\ loss (dB) + attenuator\ factor (dB)$   
 $= 8(dB)$

## 5. Facilities and Accreditations

### 5.1. Facilities

The test facility is recognized, certified, or accredited by the following organizations:

- FCC - Registration No.: 645098

Shenzhen Tongce Testing Lab

Designation Number: CN1205

The 3m Semi-anechoic chamber has been registered and fully described in a report with the (FCC) Federal Communications Commission. The acceptance letter from the FCC is maintained in our files.

- IC - Registration No.: 10668A-1

CAB identifier: CN0031

The 3m Semi-anechoic chamber of SHENZHEN TONGCE TESTING LAB has been registered by Certification and Engineering Bureau of Industry Canada for radio equipment testing

### 5.2. Location

Shenzhen Tongce Testing Lab

Address: TCT Testing Industrial Park, Fuqiao 5th Industrial Zone, Fuhai Street, Bao'an District, Shenzhen, Guangdong, 518103, People's Republic of China

TEL: +86-755-27673339

### 5.3. Measurement Uncertainty

The reported uncertainty of measurement  $y \pm U$ , where expanded uncertainty  $U$  is based on a standard uncertainty multiplied by a coverage factor of  $k=2$ , providing a level of confidence of approximately 95 %.

No.	Item	MU
1	Conducted Emission	$\pm 2.56\text{dB}$
2	RF power, conducted	$\pm 0.12\text{dB}$
3	Spurious emissions, conducted	$\pm 0.11\text{dB}$
4	All emissions, radiated(<1G)	$\pm 3.92\text{dB}$
5	All emissions, radiated(>1G)	$\pm 4.28\text{dB}$
6	Temperature	$\pm 0.1^\circ\text{C}$
7	Humidity	$\pm 1.0\%$

## 6. Test Results and Measurement Data

### 6.1. Conducted Output Power Measurement

#### 6.1.1. Test Specification

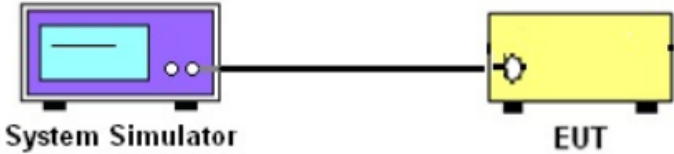
<b>Test Requirement:</b>	FCC part 22.913(a) and FCC part 24.232(b) FCC part 27.50(d);
<b>Test Method:</b>	FCC KDB 971168 D01 v03r01
<b>Operation mode:</b>	Refer to item 4.1
<b>Limits:</b>	WCDMA Band V:7W WCDMA Band II: 2W WCDMA Band IV:1W
<b>Test Setup:</b>	 <p>The diagram illustrates the test setup. On the left is a purple box labeled 'System Simulator' with a screen and two buttons. A black cable connects it to a yellow box on the right labeled 'EUT' (Equipment Under Test).</p>
<b>Test Procedure:</b>	<ol style="list-style-type: none"> <li>1. The transmitter output port was connected to the system simulator.</li> <li>2. Set EUT at maximum power through system simulator.</li> <li>3. Select lowest, middle, and highest channels for each band and different modulation.</li> <li>4. Measure the maximum burst average power for GSM and maximum average power for other modulation signal.</li> </ol>
<b>Test Result:</b>	PASS

#### 6.1.2. Test Instruments

Equipment	Manufacturer	Model	Serial Number	Calibration Due
System simulator	R&S	CMU200	110188	Sep. 11, 2021
RF cable (9kHz-40GHz)	TCT	RE-05	N/A	Sep. 02, 2021
Antenna Connector	TCT	RFC-02	N/A	Sep. 02, 2021

**Note:** The calibration interval of the above test instruments is 12 months and the calibrations are traceable to international system unit (SI).

**6.1.3. Test data**

**Conducted Power Measurement Results:**

Average Conducted Power (*Unit: dBm)						
Band	WCDMA Band V			WCDMA Band II		
Channel	4132	4183	4233	9262	9400	9538
Frequency(MHz)	826.4	836.6	846.6	1852.4	1880.0	1907.6
WCDMA RMC 12.2K	23.21	22.95	23.11	22.86	23.02	23.15
HSDPA Subtest-1	22.73	22.62	22.63	22.70	22.86	22.89
HSDPA Subtest-2	22.44	22.32	22.38	22.19	22.32	22.42
HSDPA Subtest-3	22.05	22.00	22.02	22.03	22.12	22.17
HSDPA Subtest-4	21.95	21.76	21.87	21.89	21.96	22.03
HSUPA Subtest-1	21.70	21.62	21.67	21.70	21.75	21.87
HSUPA Subtest-2	21.62	21.44	21.47	21.57	21.61	21.72
HSUPA Subtest-3	21.36	21.29	21.36	21.31	21.43	21.29
HSUPA Subtest-4	21.03	20.91	20.98	20.83	20.90	20.94
HSUPA Subtest-5	20.83	20.67	20.73	20.55	20.66	20.77

Conducted Power (*Unit: dBm)			
Band	WCDMA Band IV		
Channel	1312	1413	1513
Frequency(MHz)	1712.4	1732.6	1752.6
WCDMA RMC 12.2K	23.21	22.99	23.13
HSDPA Subtest-1	22.74	22.38	22.62
HSDPA Subtest-2	22.45	22.37	22.25
HSDPA Subtest-3	22.22	21.91	22.03
HSDPA Subtest-4	22.02	21.84	21.87
HSUPA Subtest-1	21.72	21.57	21.77
HSUPA Subtest-2	21.61	21.44	21.61
HSUPA Subtest-3	21.50	21.38	21.48
HSUPA Subtest-4	20.92	20.83	21.04
HSUPA Subtest-5	20.48	20.37	20.49

## 6.2. Peak to Average Ratio

### 6.2.1. Test Specification

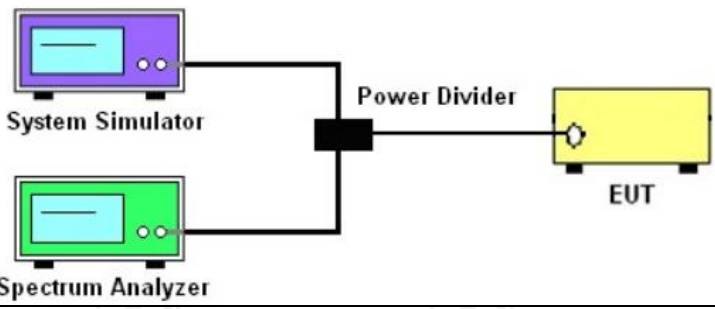
<b>Test Requirement:</b>	FCC part 24.232(d) ; FCC part 22.913; FCC part 27.50(d);
<b>Test Method:</b>	ANSI C63.26:2013
<b>Operation mode:</b>	Refer to item 4.1
<b>Limit:</b>	The peak-to-average ratio (PAR) of the transmission may not exceed 13 dB.
<b>Test Setup:</b>	
<b>Test Procedure:</b>	<ol style="list-style-type: none"> <li>1. The testing follows FCC KDB 971168 D01v03r01 Section 5.7.1.</li> <li>2. The EUT was connected to spectrum analyzer and system simulator via a power divider.</li> <li>3. Set EUT to transmit at maximum output power.</li> <li>4. For GSM/EGPRS operating modes, signal gating is implemented on the spectrum analyzer by triggering from the system simulator.</li> <li>5. Set the CCDF (Complementary Cumulative Distribution Function) option of the spectrum analyzer. Record the maximum PAPR level associated with a probability of 0.1%.</li> </ol>
<b>Test Result:</b>	PASS

### 6.2.2. Test Instruments

Equipment	Manufacturer	Model	Serial Number	Calibration Due
System simulator	R&S	CMU200	110188	Sep. 11, 2021
Spectrum Analyzer	R&S	FSU	200054	Sep. 11, 2021
RF cable (9kHz-40GHz)	TCT	RE-05	N/A	Sep. 02, 2021
Antenna Connector	TCT	RFC-02	N/A	Sep. 02, 2021

**Note:** The calibration interval of the above test instruments is 12 months and the calibrations are traceable to international system unit (SI).

**6.2.3. Test Data**

Cellular Band									
Mode	WCDMA Band V (HSUPA)			WCDMA Band IV (HSUPA)			WCDMA Band II (HSUPA)		
Channel	4132	4183	4233	1312	1413	1513	9262	9400	9538
Frequency (MHz)	826.4	836.6	846.6	1712.4	1732.6	1752.6	1852.4	1880	1907.6
Peak-to-Average Ratio (dB)	2.88	2.95	2.92	2.95	3.27	3.11	3.08	2.95	3.01

Test plots as follows:

WCDMA Band V 12.2K

Peak-to-Average Ratio on Channel 4132

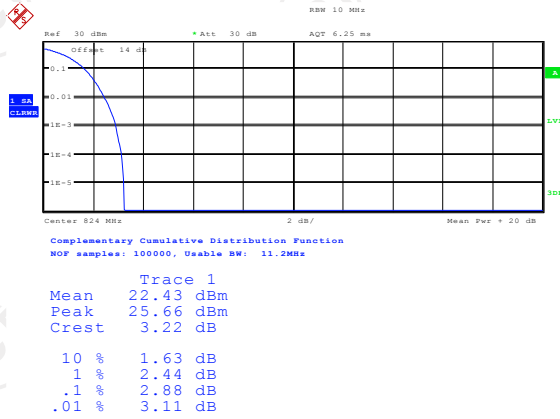

Date: 25.MAY.2021, 15:30:38

Peak-to-Average Ratio on Channel 4183

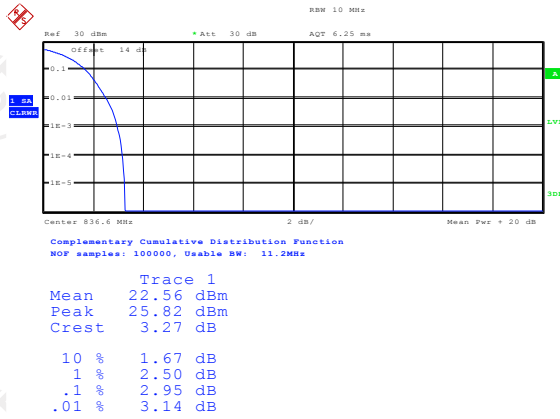

Date: 25.MAY.2021 15:31:02

Peak-to-Average Ratio on Channel 4233

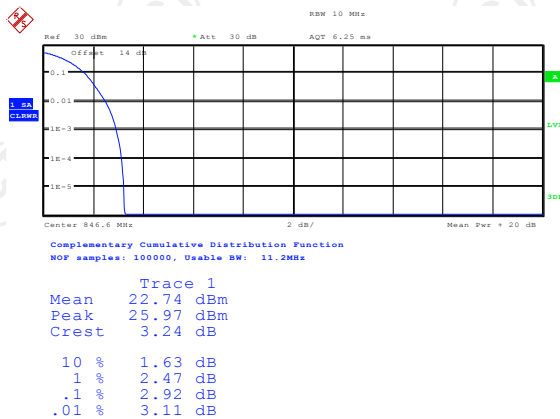

Date: 25.MAY.2021 15:31:48



WCDMA Band IV 12.2Kbps

Peak-to-Average Ratio on Channel 1312

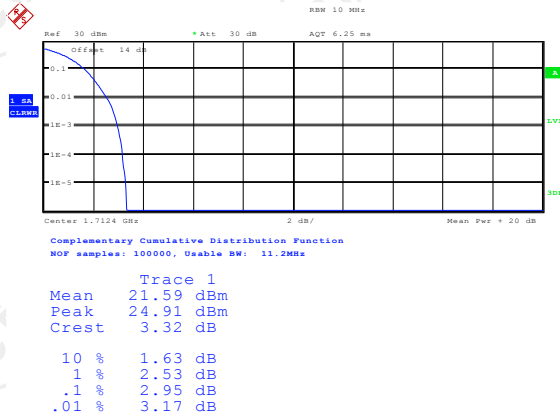

Date: 25.MAY.2021, 15:32:51

Peak-to-Average Ratio on Channel 1413

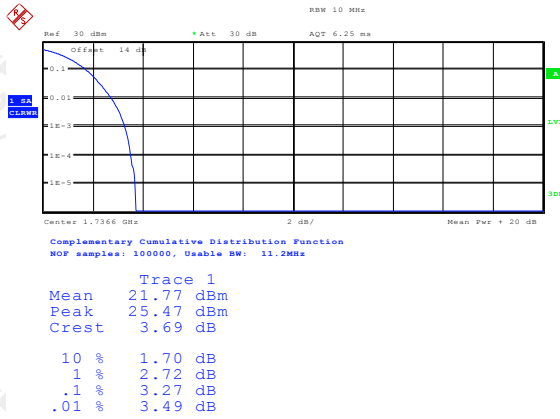

Date: 25.MAY.2021 15:33:16

Peak-to-Average Ratio on Channel 1513

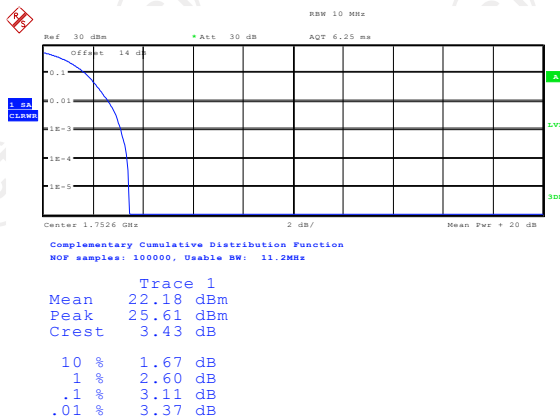

Date: 25.MAY.2021 15:33:39

WCDMA Band II 12.2Kbps

Peak-to-Average Ratio on Channel 9262

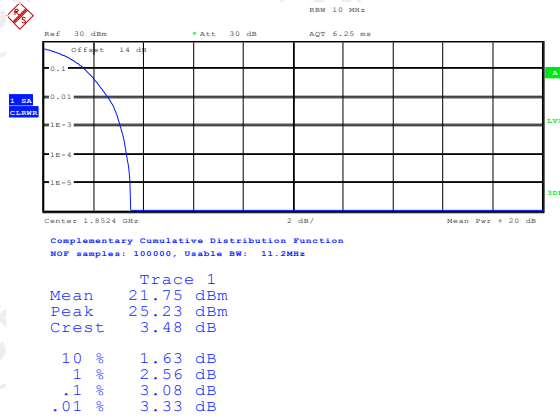

Date: 25.MAY.2021, 15:34:07

Peak-to-Average Ratio on Channel 9400

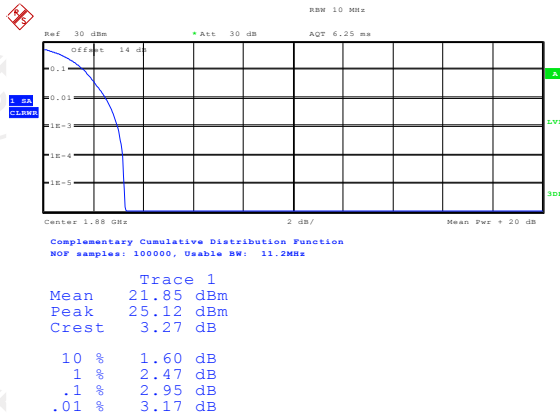

Date: 25.MAY.2021 15:34:29

Peak-to-Average Ratio on Channel 9538

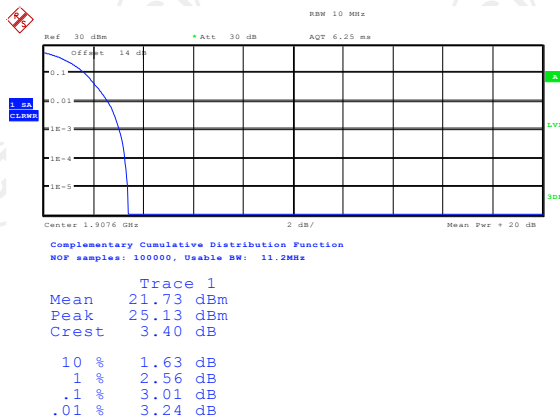

Date: 25.MAY.2021 15:41:04

### 6.3. 99% Occupied Bandwidth and 26dB Bandwidth Measurement

#### 6.3.1. Test Specification

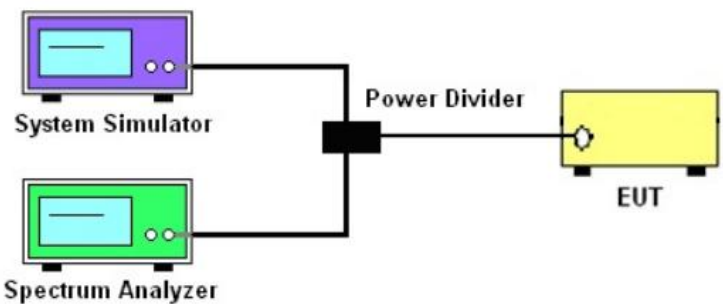
<b>Test Requirement:</b>	FCC part 2.1049
<b>Test Method:</b>	FCC KDB 971168 D01v03r01
<b>Operation mode:</b>	Refer to item 4.1
<b>Limit:</b>	N/A
<b>Test Setup:</b>	 <p>The diagram illustrates the test setup. A System Simulator (purple) and a Spectrum Analyzer (green) are connected to a Power Divider (black). The Power Divider is connected to the EUT (yellow).</p>
<b>Test Procedure:</b>	<ol style="list-style-type: none"> <li>1. The testing follows FCC KDB 971168 D01v03r01 Section 4.2.</li> <li>2. The EUT was connected to the spectrum analyzer and system simulator via a power divider.</li> <li>3. The RF output of the EUT was connected to the spectrum analyzer by RF cable and attenuator. The path loss was compensated to the results for each measurement.</li> <li>4. The 99% occupied bandwidth were measured, set RBW= 1% of span, VBW= 3*RBW, sample detector, trace maximum hold.</li> <li>5. The 26dB bandwidth were measured, set RBW= 1% of EBW, VBW= 3*RBW, peak detector, trace maximum hold.</li> </ol>
<b>Test Result:</b>	PASS

#### 6.3.2. Test Instruments

Equipment	Manufacturer	Model	Serial Number	Calibration Due
System simulator	R&S	CMU200	110188	Sep. 11, 2021
Spectrum Analyzer	R&S	FSU	200054	Sep. 11, 2021
RF cable (9kHz-40GHz)	TCT	RE-05	N/A	Sep. 02, 2021
Antenna Connector	TCT	RFC-02	N/A	Sep. 02, 2021

**Note:** The calibration interval of the above test instruments is 12 months and the calibrations are traceable to international system unit (SI).

6.3.3. Test data

Cellular Band			
Mode	WCDMA Band V (HSUPA)		
Channel	4132	4183	4233
Frequency (MHz)	826.4	836.6	846.6
99% OBW (MHz)	4.16	4.15	4.15
26dB BW (MHz)	4.73	4.71	4.74

Cellular Band			
Mode	WCDMA Band IV (HSUPA)		
Channel	1312	1413	1513
Frequency (MHz)	1712.4	1732.6	1752.6
99% OBW (MHz)	4.13	4.13	4.13
26dB BW (MHz)	4.73	4.71	4.71

Cellular Band			
Mode	WCDMA Band II (HSUPA)		
Channel	9262	9400	9538
Frequency (MHz)	1852.4	1880	1907.6
99% OBW (MHz)	4.13	4.14	4.13
26dB BW (MHz)	4.73	4.73	4.73

Test plots as follows:

Band: WCDMA Band V Test Mode: HSUPA Link (QPSK)

26dB&99% Occupied Bandwidth Plot on Channel 4132

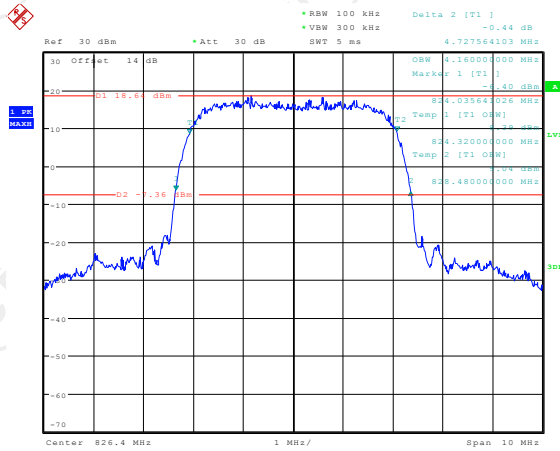

Date: 25.MAY.2021 15:05:39

26dB&99% Occupied Bandwidth Plot on Channel 4183

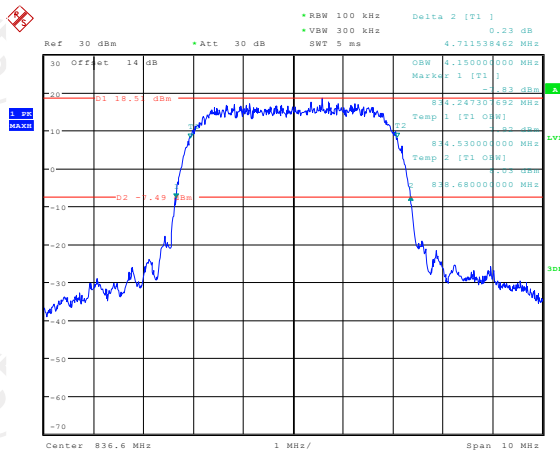

Date: 25.MAY.2021 15:06:49

26dB&99% Occupied Bandwidth Plot on Channel 4233

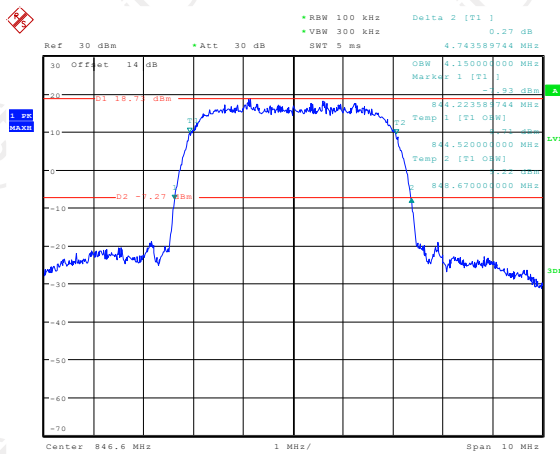

Date: 25.MAY.2021 15:07:44

Band: WCDMA Band IV Test Mode: HSUPA Link (QPSK)

26dB&99% Occupied Bandwidth Plot on Channel 1312

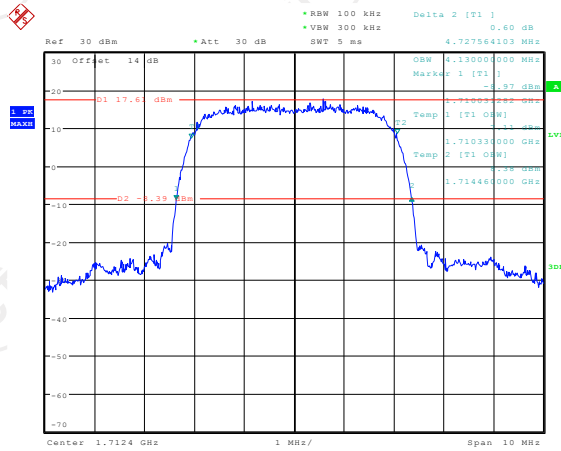

Date: 25.MAY.2021 15:19:19

26dB&99% Occupied Bandwidth Plot on Channel 1413

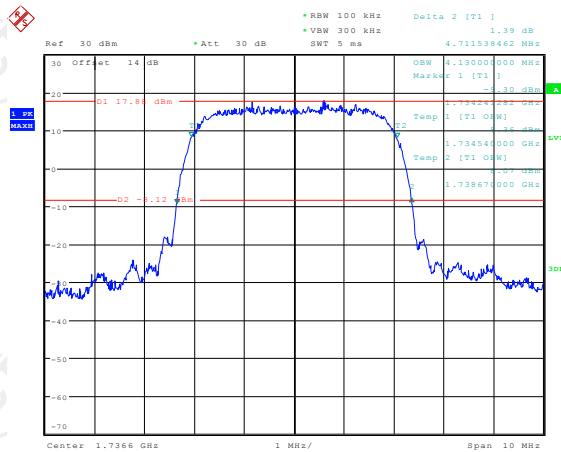

Date: 25.MAY.2021 15:21:44

26dB&99% Occupied Bandwidth Plot on Channel 1513

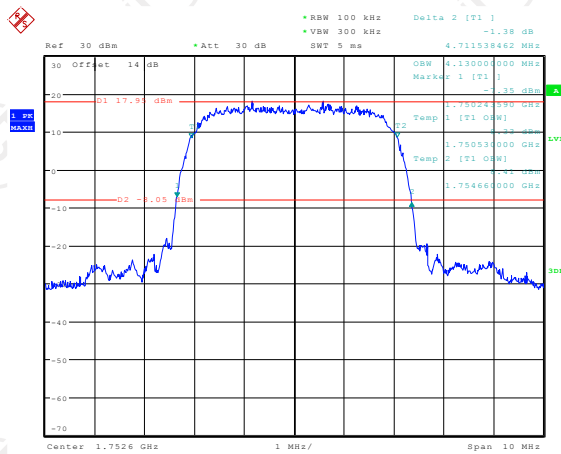

Date: 25.MAY.2021 15:22:52

Band: WCDMA Band II Test Mode: HSUPA Link (QPSK)

26dB&99% Occupied Bandwidth Plot on Channel 9262

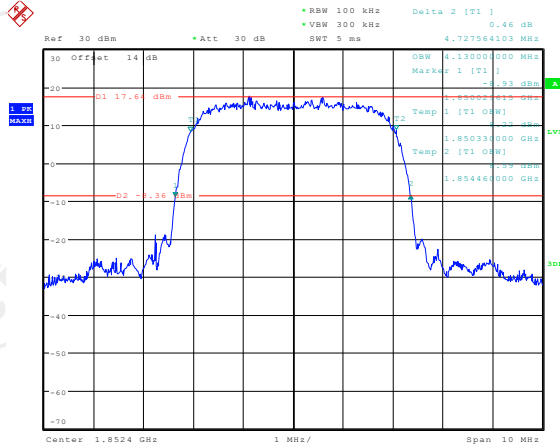

Date: 25.MAY.2021 15:15:12

26dB&99% Occupied Bandwidth Plot on Channel 9400

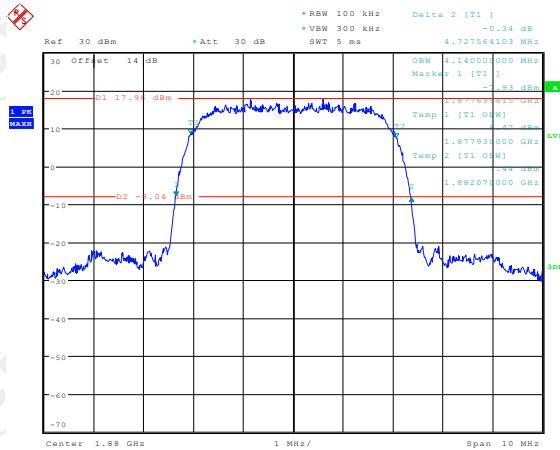

Date: 25.MAY.2021 15:16:23

26dB&99% Occupied Bandwidth Plot on Channel 9538

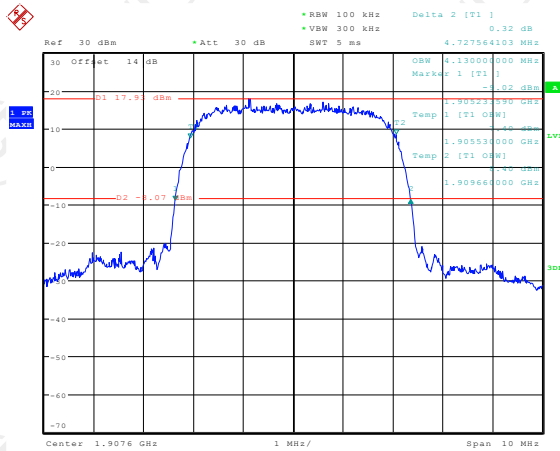

Date: 25.MAY.2021 15:17:38

## 6.4. Band Edge and Conducted Spurious Emission Measurement

### 6.4.1. Test Specification

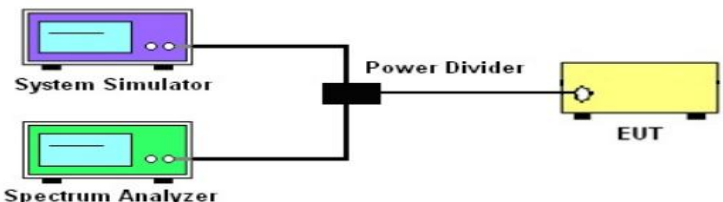
<b>Test Requirement:</b>	FCC part22.917(a) and FCC part24.238(a) FCC part27.53(h)
<b>Test Method:</b>	FCC KDB 971168 D01v03r01
<b>Operation mode:</b>	Refer to item 4.1
<b>Limit:</b>	-13dBm
<b>Test Setup:</b>	 <p>The diagram illustrates the test setup. A System Simulator (purple box) and a Spectrum Analyzer (green box) are connected to a Power Divider (black box). The Power Divider is connected to the EUT (yellow box).</p>
<b>Test Procedure:</b>	<ol style="list-style-type: none"> <li>1. The testing follows FCC KDB 971168 D01v03r01 Section 6.0.</li> <li>2. The EUT was connected to the spectrum analyzer and system simulator via a power divider.</li> <li>3. The RF output of EUT was connected to the spectrum analyzer by an RF cable and attenuator. The path loss was compensated to the results for each measurement.</li> <li>4. The band edges of low and high channels for the highest RF powers were measured.</li> <li>5. The conducted spurious emission for the whole frequency range was taken.</li> <li>6. The RF fundamental frequency should be excluded against the limit line in the operating frequency band.</li> <li>7. The limit line is derived from <math>43 + 10\log(P)</math> dB below the transmitter power  <math>P(\text{Watts}) = P(W) - [43 + 10\log(P)] (\text{dB}) = [30 + 10\log(P)] (\text{dBm}) - [43 + 10\log(P)] (\text{dB}) = -13\text{dBm}</math>.</li> </ol>
<b>Test Result:</b>	PASS

### 6.4.2. Test Instruments

Equipment	Manufacturer	Model	Serial Number	Calibration Due
System simulator	R&S	CMU200	110188	Sep. 11, 2021
Spectrum Analyzer	R&S	FSU	200054	Sep. 11, 2021
RF cable (9kHz-40GHz)	TCT	RE-05	N/A	Sep. 02, 2021
Antenna Connector	TCT	RFC-02	N/A	Sep. 02, 2021

**Note:** The calibration interval of the above test instruments is 12 months and the calibrations are traceable to international system unit (SI).



6.4.3. Test data

Test plots as follows:

Band:	WCDMA Band V	Test Mode:	HSUPA Link (QPSK)
-------	--------------	------------	-------------------

Lower Band Edge Plot on Channel 4132

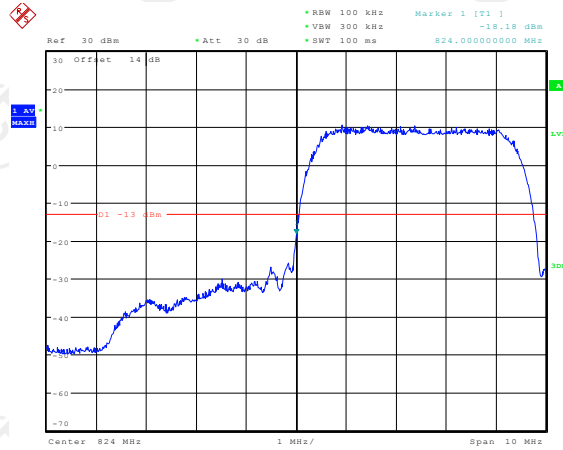

Date: 25.MAY.2021 15:30:00

Higher Band Edge Plot on Channel 4233

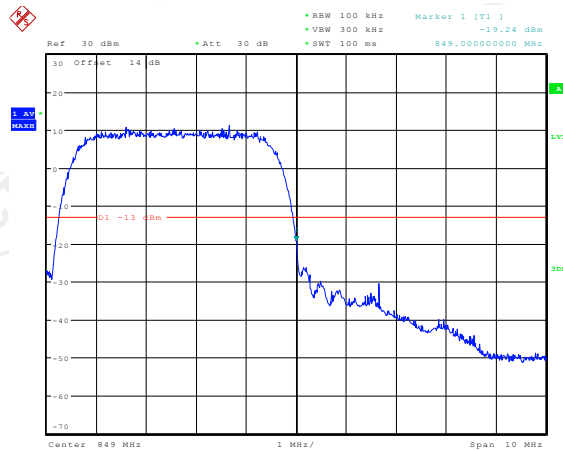

Date: 25.MAY.2021 15:29:06

Band:	WCDMA Band IV	Test Mode:	HSUPA Link (QPSK)
-------	---------------	------------	-------------------

Lower Band Edge Plot on Channel 1312

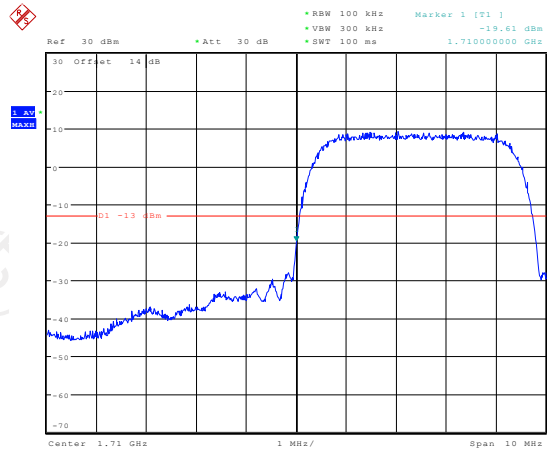

Date: 25 MAY 2021 15:24:33

Higher Band Edge Plot on Channel 1513

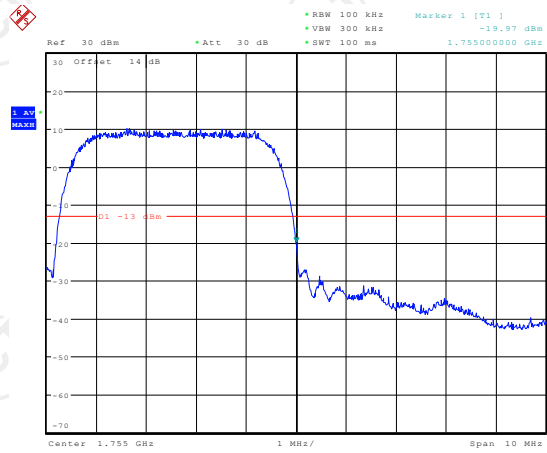

Date: 25.MAY.2021 15:23:56

Band:	WCDMA Band II	Test Mode:	HSUPA Link (QPSK)
-------	---------------	------------	-------------------

### Lower Band Edge Plot on Channel 9262

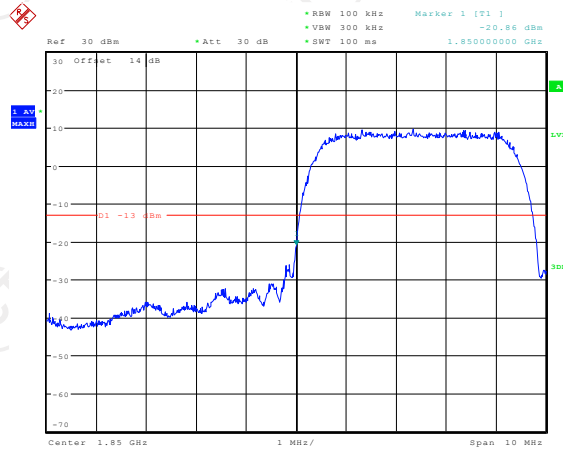

Date: 25.MAY.2021 15:27:51

### Higher Band Edge Plot on Channel 9538

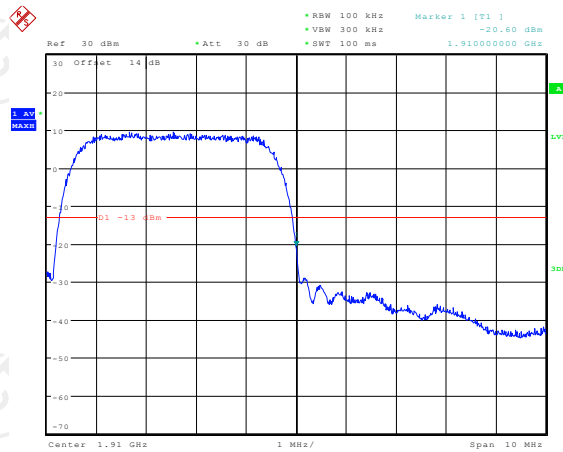

Date: 25.MAY.2021 15:27:24

Band: WCDMA Band V Test Mode: HSUPA Link (QPSK)

Conducted Spurious Emission on Channel 4132

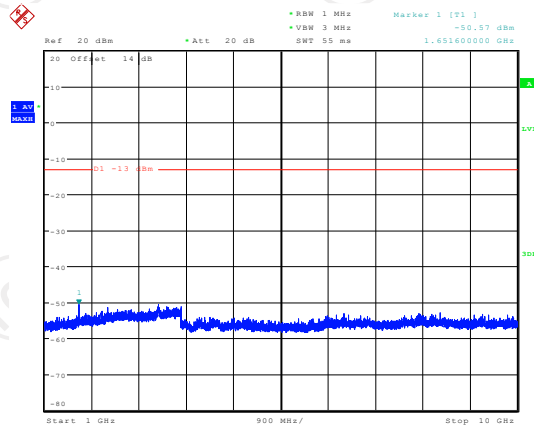
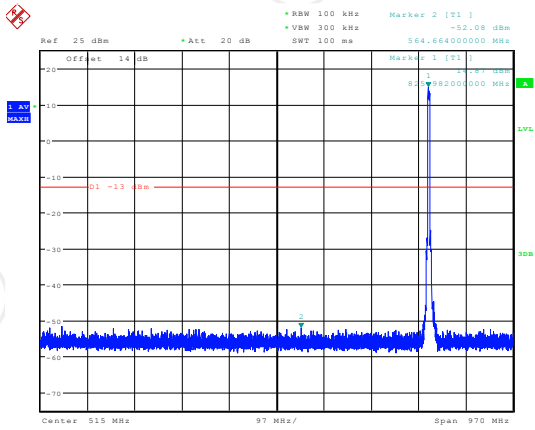

Date: 25.MAY.2021 16:05:37

Date: 25.MAY.2021 16:06:27

Conducted Spurious Emission on Channel 4183

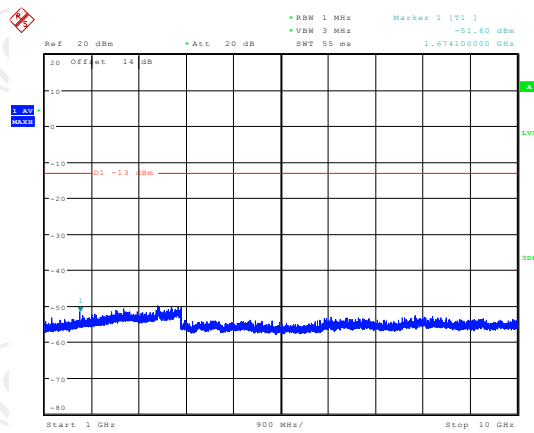
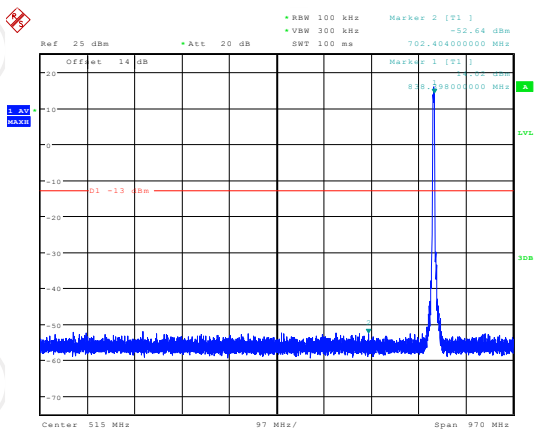

Date: 25.MAY.2021 16:04:36

Date: 25.MAY.2021 16:09:42

Conducted Spurious Emission on Channel 4233

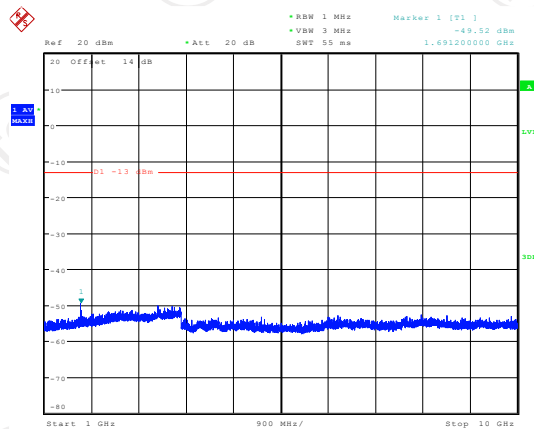
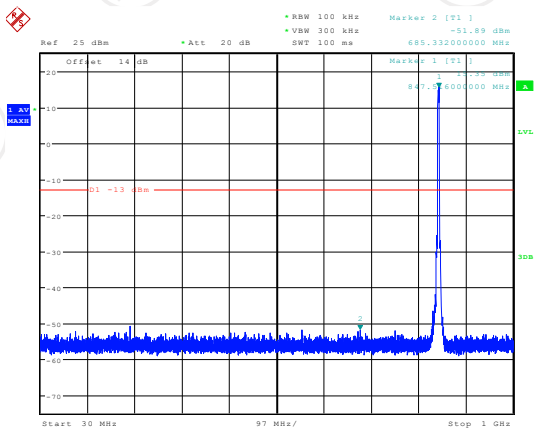

Date: 25.MAY.2021 16:03:50

Date: 25.MAY.2021 16:11:02

Band: WCDMA Band IV Test Mode: HSUPA Link (QPSK)

Conducted Spurious Emission on Channel 1312

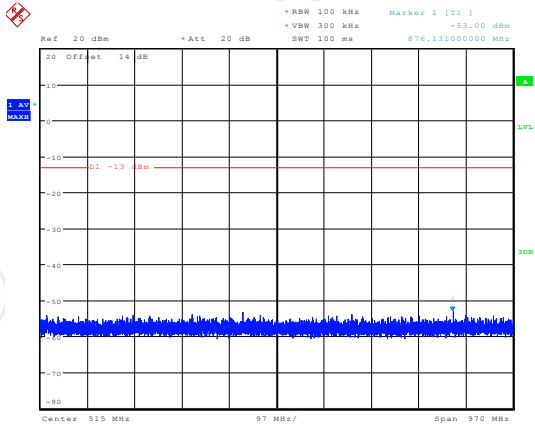

Date: 25.MAY.2021 15:56:14

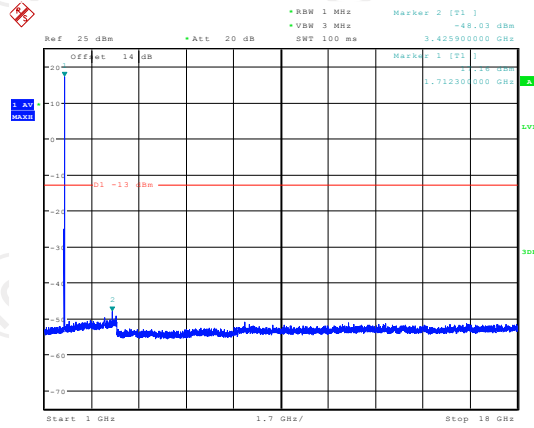

Date: 25.MAY.2021 15:57:15

Conducted Spurious Emission on Channel 1413

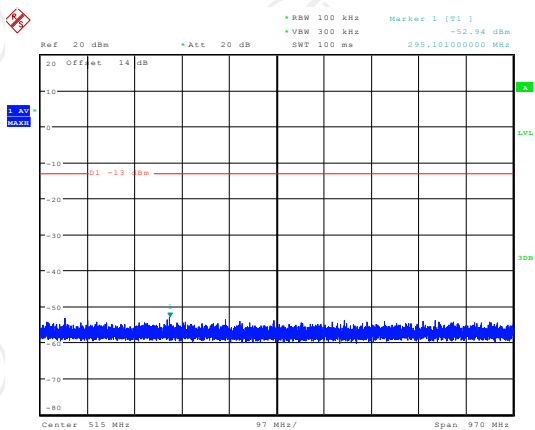

Date: 25.MAY.2021 15:55:41

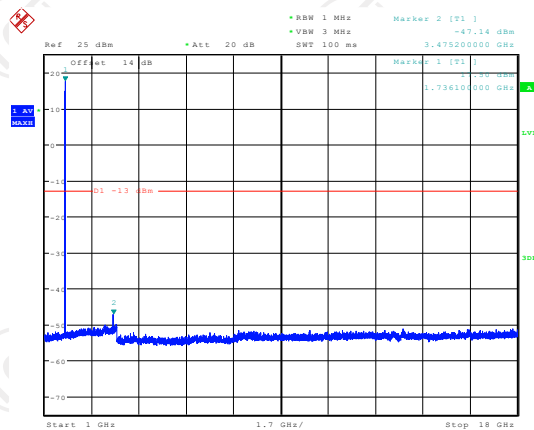

Date: 25.MAY.2021 16:00:38

Conducted Spurious Emission on Channel 1513

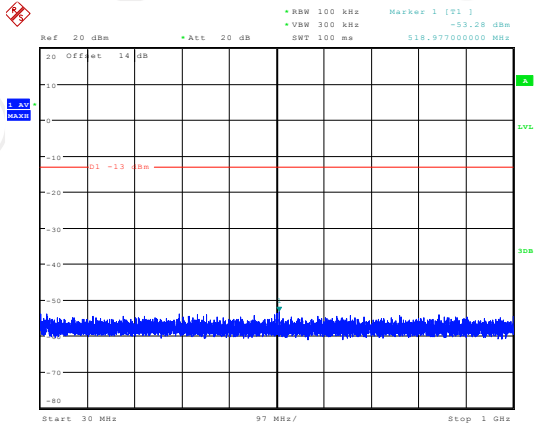

Date: 25.MAY.2021 15:54:51

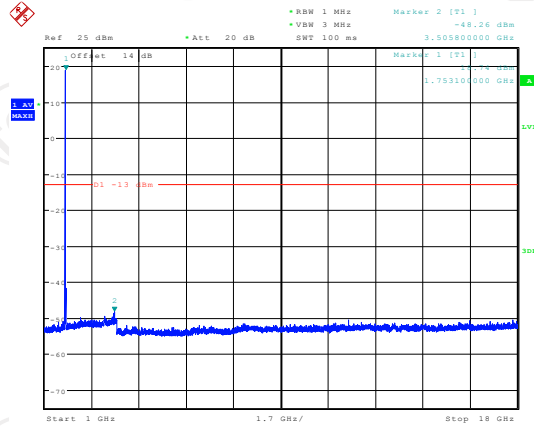

Date: 25.MAY.2021 16:02:37

Band: WCDMA Band II Test Mode: HSUPA Link (QPSK)

Conducted Spurious Emission on Channel 9262

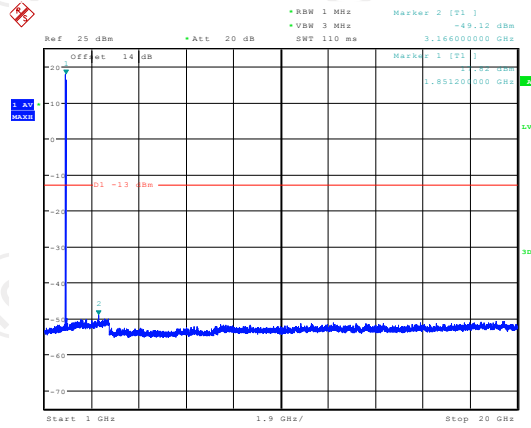
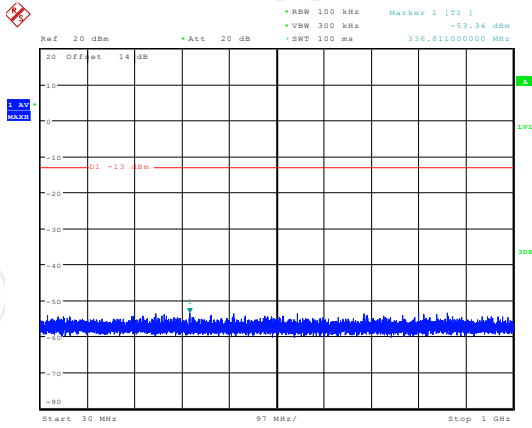

Conducted Spurious Emission on Channel 9400

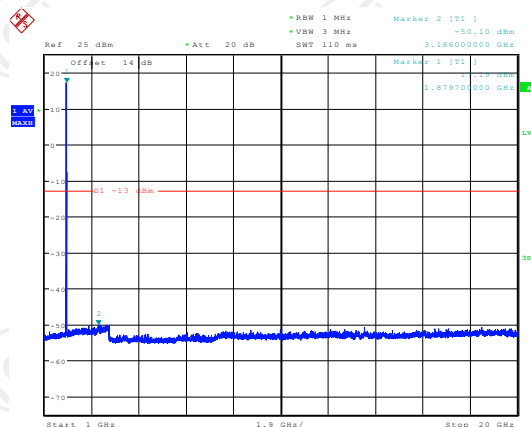
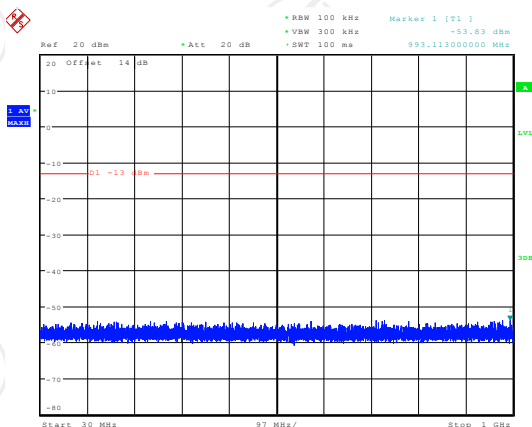

Conducted Spurious Emission on Channel 9538

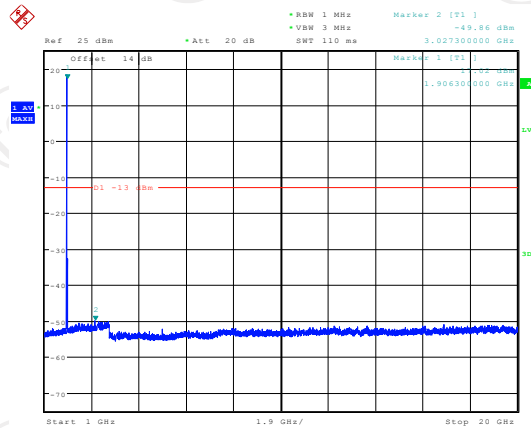
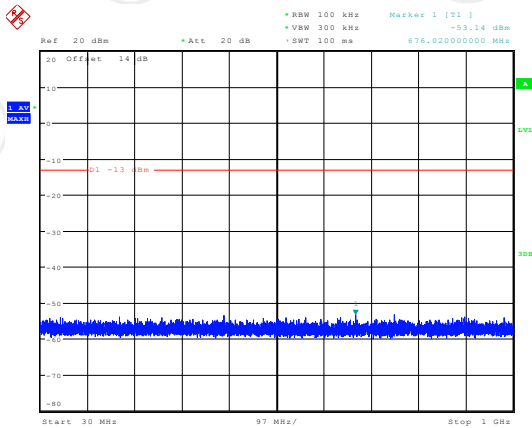

WCDMA Band II Conducted Spurious Emission for Below 1G

Channel	RBW (KHz)	Test result (dBm)	RBW (MHz)	Calculate result (dBm)	Limit (-13dBm)
9262	100	-53.34	1	-43.34	Pass
9400	100	-53.83	1	-43.83	Pass
9538	100	-53.14	1	-43.14	Pass

WCDMA Band IV Conducted Spurious Emission for Below 1G

Channel	RBW (KHz)	Test result (dBm)	RBW (MHz)	Calculate result (dBm)	Limit (-13dBm)
1312	100	-53.00	1	-43.00	Pass
1413	100	-52.94	1	-42.94	Pass
1513	100	-53.28	1	-43.28	Pass

Compensate 10dB is for Exchange rate of RBW

Exchange rate of RBW =  $10 \cdot \log_{10}(\text{Reference bandwidth}/\text{RBW at measurement}) = 10[\text{dB}]$   
where Reference bandwidth = 1 MHz

## 6.5. Effective Radiated Power and Effective Isotropic Radiated Power Measurement

### 6.5.1. Test Specification

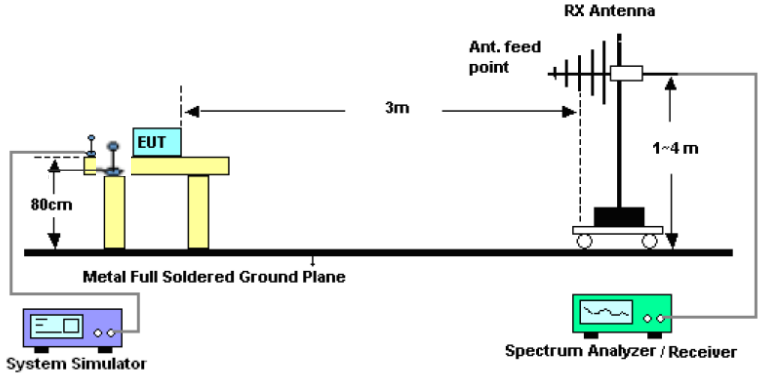
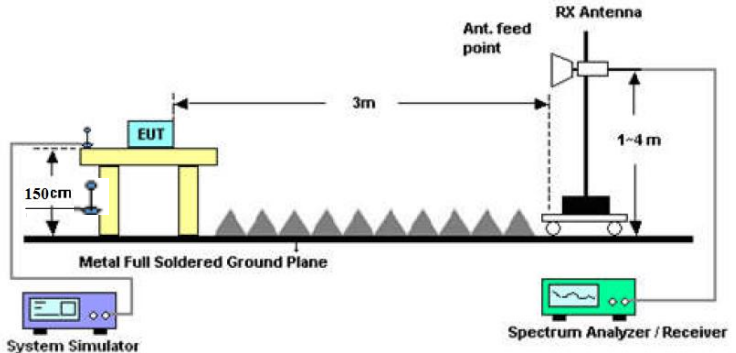
<b>Test Requirement:</b>	FCC part 22.913(a) and FCC part 24.232(c) FCC part 27.50(d)	
<b>Test Method:</b>	FCC KDB 971168 D01v03r01	
<b>Receiver Setup:</b>	WCDMA/HSPA	
	SPAN	10MHz
	RBW	100kHz
	VBW	300kHz
	Detector	RMS
	Trace	Average
	Average Type	Power
Sweep Count	100	
<b>Limit:</b>	WCDMA Band V: 7W ERP WCDMA Band II: 2W EIRP WCDMA Band IV: 1W EIRP	
<b>Test Setup:</b>	From 30MHz to 1GHz 	
	Above 1GHz 	
<b>Test Procedure:</b>	1. The testing follows FCC KDB 971168 D01v03r01 Section 5.8. and ANSI / TIA-603-D-2010 Section	



	<p>2.2.17.</p> <ol style="list-style-type: none"> <li>2. The EUT was placed on a non-conductive rotating platform 0.8 meters high in a semi-anechoic chamber. The radiated emission at the fundamental frequency was measured at 3 m with a test antenna and a spectrum analyzer with RMS detector per section 5. of KDB 971168 D01v03.</li> <li>3. Key the transmitter, then rotate the EUT 360° azimuthally and record spectrum analyzer power level (LVL) measurements at angular increments that are sufficiently small to permit resolution of all peaks. If a standard radiation test site is used, raise and lower the test antenna to obtain a maximum reading at each angular increment.</li> <li>4. Replace the transmitter under test with a substitution antenna. The center of the antenna should be at the same location as the center of the antenna under test.</li> <li>5. Connect the antenna to a signal generator with a known output power and record the path loss (in dB) as LOSS. If a standard radiation test site is used, raise and lower the test antenna to obtain a maximum reading. LOSS = Generator Output Power (dBm) – Analyzer reading (dBm)</li> <li>6. Determine the effective radiated output power at each angular position from the readings in steps 3) and 5) using the following equation: ERP (dBm) = LVL (dBm) + LOSS (dB)</li> <li>7. The maximum ERP is the maximum value determined in the preceding step.</li> <li>8. Calculating ERP: ERP (dBm) = Output Power (dBm) - Losses (dB) + Antenna Gain (dBd) Antenna Gain (dBd) = Antenna Gain (dBi) - 2.15 EIRP = ERP + 2.15</li> </ol>
<b>Test results:</b>	<b>PASS</b>

### 6.5.2. Test Instruments

Radiated Emission Test Site (966)				
Name of Equipment	Manufacturer	Model	Serial Number	Calibration Due
System simulator	R&S	CMU200	110188	Sep. 11, 2021
Spectrum Analyzer	ROHDE&SCHW ARZ	R&S	FSQ40	Sep. 11, 2021
Signal Generator	HP	83623B	3614A00396	Sep. 02, 2021
Broadband Antenna	Schwarzbeck	VULB9163	340	Sep. 04, 2022
Horn Antenna	Schwarzbeck	BBHA 9120D	631	Sep. 04, 2022
Broadband Antenna	Schwarzbeck	VULB9163	412	Sep. 04, 2022
Horn Antenna	Schwarzbeck	BBHA 9120D	1201	Sep. 04, 2022
Horn Antenna	A-INFO	LB-180400-KF	J211020657	Sep. 04, 2022
Dipole Antenna	TCT	TCT-RF	N/A	Sep. 02, 2021
Line-4	TCT	RE-high-04	N/A	Sep. 02, 2021
Line-8	TCT	RE-01	N/A	Jul. 27, 2021
Antenna Mast	Keleto	RE-AM	N/A	N/A
EMI Test Software	Shurple Technology	EZ-EMC	N/A	N/A

**Note:** The calibration interval of the above test instruments is 12 months and the calibrations are traceable to international system unit (SI).

**6.5.3. Test Data**

**Test Result of ERP**

WCDMA Band V (HSUPA) Radiated Power ERP					
Horizontal Polarization (Antenna Pol.)					
Frequency (MHz)	(EUT Pol.)	LVL (dBm)	Correction Factor (dB)	ERP (dBm)	ERP (W)
826.4	H	3.35	21.62	22.82	0.19
836.6	H	3.51	21.54	22.90	0.19
846.6	H	3.67	21.44	22.96	0.20
Vertical Polarization (Antenna Pol.)					
Frequency (MHz)	(EUT Pol.)	LVL (dBm)	Correction Factor (dB)	ERP (dBm)	ERP (W)
826.4	H	3.29	21.62	22.76	0.19
836.6	H	3.41	21.54	22.80	0.19
846.6	H	3.75	21.44	23.04	0.20

\* ERP = LVL (dBm) + Correction Factor (dB) – 2.15

Correction Factor= S.G. Power - Cable loss + Antenna Gain- SPA. Reading

**Test Result of EIRP**

WCDMA Band IV (HSUPA) Radiated Power EIRP					
Horizontal Polarization (Antenna Pol.)					
Frequency (MHz)	(EUT Pol.)	LVL (dBm)	Correction Factor (dB)	EIRP (dBm)	EIRP (W)
1712.4	H	3.98	18.33	22.31	0.17
1732.6	H	4.14	18.15	22.29	0.17
1752.6	H	4.35	18.24	22.59	0.18
Vertical Polarization (Antenna Pol.)					
Frequency (MHz)	(EUT Pol.)	LVL (dBm)	Correction Factor (dB)	EIRP (dBm)	EIRP (W)
1712.4	H	3.91	18.33	22.24	0.17
1732.6	H	4.12	18.15	22.27	0.17
1752.6	H	4.39	18.24	22.63	0.18

\* EIRP = LVL (dBm) + Correction Factor (dB)

Correction Factor= S.G. Power - Cable loss + Antenna Gain- SPA. Reading

WCDMA Band II (HSUPA) Radiated Power EIRP					
Horizontal Polarization (Antenna Pol.)					
Frequency (MHz)	(EUT Pol.)	LVL (dBm)	Correction Factor (dB)	EIRP (dBm)	EIRP (W)
1852.4	H	1.05	21.62	22.67	0.18
1880.0	H	1.29	21.54	22.83	0.19
1907.6	H	1.31	21.48	22.79	0.19
Vertical Polarization (Antenna Pol.)					
Frequency (MHz)	(EUT Pol.)	LVL (dBm)	Correction Factor (dB)	EIRP (dBm)	EIRP (W)
1852.4	H	0.97	21.62	22.59	0.18
1880.0	H	1.18	21.54	22.72	0.19
1907.6	H	1.23	21.48	22.71	0.19

\* EIRP = LVL (dBm) + Correction Factor (dB)

Correction Factor= S.G. Power - Cable loss + Substitution Antenna Gain- SPA. Reading

## 6.6. Field Strength of Spurious Radiation Measurement

### 6.6.1. Test Specification

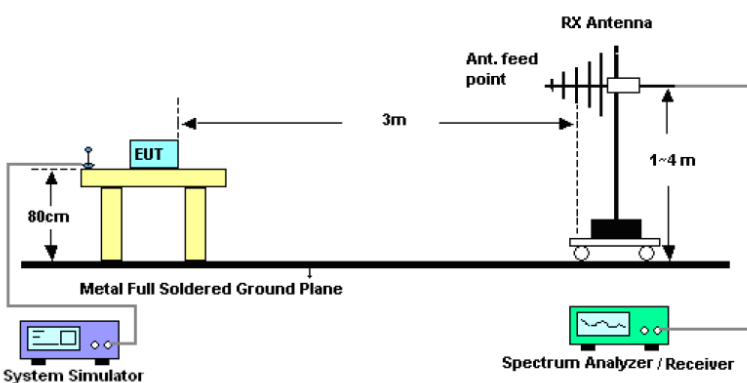
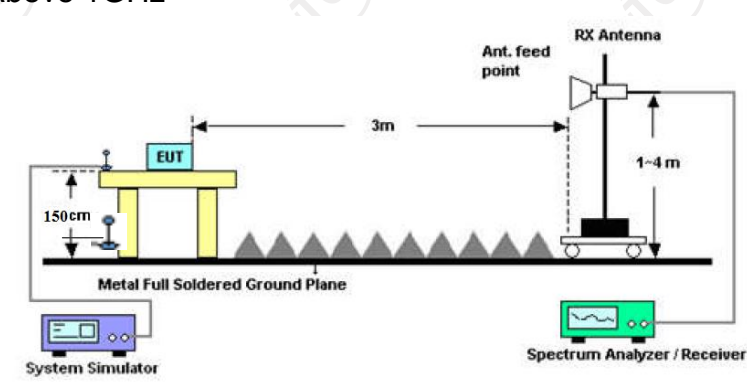
<b>Test Requirement:</b>	FCC part 22.917(a) and FCC part 24.238(a) FCC part 27.53(h)
<b>Test Method:</b>	FCC KDB 971168 D01v03r01
<b>Operation mode:</b>	Refer to item 4.1
<b>Limit:</b>	-13dBm
<b>Test setup:</b>	<p>For 30MHz~1GHz</p>  <p>Above 1GHz</p> 
<b>Test Procedure:</b>	<ol style="list-style-type: none"> <li>1. The testing follows FCC KDB 971168 D01v03r01 Section 6 and ANSI / TIA-603-D-2010 Section 2.2.12.</li> <li>2. The EUT was placed on a rotatable wooden table 0.8 meters above the ground.</li> <li>3. The EUT was set 3 meters from the receiving antenna, which was mounted on the antenna tower.</li> <li>4. The table was rotated 360 degrees to determine the position of the highest spurious emission.</li> <li>5. The height of the receiving antenna is varied between one meter and four meters to search for the maximum spurious emission for both horizontal and vertical polarizations.</li> <li>6. Make the measurement with the spectrum analyzer's</li> </ol>

	<p>RBW = 1MHz, VBW = 3MHz, taking record of maximum spurious emission.</p> <p>7. A horn antenna was substituted in place of the EUT and was driven by a signal generator.</p> <p>8. Tune the output power of signal generator to the same emission level with EUT maximum spurious emission.</p> <p>9. Taking the record of output power at antenna port.</p> <p>10. Repeat step 7 to step 8 for another polarization.</p> <p>11. EIRP (dBm) = S.G. Power – Tx Cable Loss + Tx Antenna Gain</p> <p>12. ERP (dBm) = EIRP - 2.15</p> <p>13. The RF fundamental frequency should be excluded against the limit line in the operating frequency band.</p> <p>14. The limit line is derived from 43 + 10log(P) dB below the transmitter power P(Watts)</p> <p>= P(W) - [43 + 10log(P)] (dB)</p> <p>= [30 + 10log(P)] (dBm) - [43 + 10log(P)] (dB)</p> <p>= -13dBm.</p>
<b>Test results:</b>	PASS
<b>Remark:</b>	All modulations have been tested, but only the worst modulation show in this test item.

**6.6.2. Test Instruments**

Radiated Emission Test Site (966)				
Name of Equipment	Manufacturer	Model	Serial Number	Calibration Due
System simulator	R&S	CMU200	110188	Sep. 11, 2021
Spectrum Analyzer	ROHDE&SCHW ARZ	R&S	FSQ40	Sep. 11, 2021
Signal Generator	HP	83623B	3614A00396	Sep. 02, 2021
Broadband Antenna	Schwarzbeck	VULB9163	340	Sep. 04, 2022
Horn Antenna	Schwarzbeck	BBHA 9120D	631	Sep. 04, 2022
Broadband Antenna	Schwarzbeck	VULB9163	412	Sep. 04, 2022
Horn Antenna	Schwarzbeck	BBHA 9120D	1201	Sep. 04, 2022
Horn Antenna	A-INFO	LB-180400-KF	J211020657	Sep. 04, 2022
Dipole Antenna	TCT	TCT-RF	N/A	Sep. 02, 2021
Line-4	TCT	RE-high-04	N/A	Sep. 02, 2021
Line-8	TCT	RE-01	N/A	Jul. 27, 2021
Antenna Mast	Keleto	RE-AM	N/A	N/A
EMI Test Software	Shurple Technology	EZ-EMC	N/A	N/A

**Note:** The calibration interval of the above test instruments is 12 months and the calibrations are traceable to international system unit (SI).

### 6.6.3. Test Data

#### Frequency Range (9 kHz-30MHz)

Frequency (MHz)	Level@3m (dB $\mu$ V/m)	Limit@3m (dB $\mu$ V/m)
--	--	--
--	--	--
--	--	--
--	--	--

**Note:** 1. Emission Level=Reading+ Cable loss+Antenna factor-Amp factor

2. The emission levels are 20 dB below the limit value, which are not reported. It is deemed to comply with the requirement



<b>Band</b>	<b>WCDMA Band V</b>	<b>Test channel:</b>	<b>Lowest</b>
<b>Test mode:</b>	<b>RMC 12.2Kbps Link (QPSK)</b>	<b>Temperature :</b>	<b>25°C</b>
		<b>Relative Humidity:</b>	<b>56%</b>

**Note:** Spurious emissions within 30-1000MHz were found more than 20dB below limit line.

Frequency (MHz)	Spurious Emission				Limit (dBm)	Result
	Polarization	Level (dBm)	Correction Factor (dB)	Spurious emissions (dBm)		
1652.8	Vertical	-68.19	23.14	-45.05	-13.00	PASS
2479.2	V	-77.39	23.23	-54.16		
3305.6	V	-75.94	23.34	-52.60		
1652.8	Horizontal	-66.69	23.14	-43.55		
2479.2	H	-76.12	23.23	-52.89		
3305.6	H	-77.91	23.34	-54.57		

<b>Band</b>	<b>WCDMA Band V</b>	<b>Test channel:</b>	<b>Middle</b>
<b>Test mode:</b>	<b>RMC 12.2Kbps Link (QPSK)</b>	<b>Temperature :</b>	<b>25°C</b>
		<b>Relative Humidity:</b>	<b>56%</b>

**Note:** Spurious emissions within 30-1000MHz were found more than 20dB below limit line.

Frequency (MHz)	Spurious Emission				Limit (dBm)	Result
	Polarization	Level (dBm)	Correction Factor (dB)	Spurious emissions (dBm)		
1672.8	Vertical	-67.14	23.17	-43.97	-13.00	PASS
2509.2	V	-76.18	23.26	-52.92		
3345.6	V	-76.62	23.38	-53.24		
1672.8	Horizontal	-65.49	23.17	-42.32		
2509.2	H	-79.41	23.26	-56.15		
3345.6	H	-76.94	23.38	-53.56		

<b>Band</b>	<b>WCDMA Band V</b>	<b>Test channel:</b>	<b>Highest</b>
<b>Test mode:</b>	<b>RMC 12.2Kbps Link (QPSK)</b>	<b>Temperature :</b>	<b>25°C</b>
		<b>Relative Humidity:</b>	<b>56%</b>

**Note:** Spurious emissions within 30-1000MHz were found more than 20dB below limit line.

Frequency (MHz)	Spurious Emission				Limit (dBm)	Result
	Polarization	Level (dBm)	Correction Factor (dB)	Spurious emissions (dBm)		
1693.2	Vertical	-69.99	23.20	-46.79	-13.00	PASS
2539.8	V	-76.67	23.29	-53.38		
3386.4	V	-80.60	23.42	-57.18		
1693.2	Horizontal	-66.95	23.20	-43.75		
2539.8	H	-77.13	23.29	-53.84		
3386.4	H	-79.92	23.42	-56.50		

<b>Band</b>	<b>WCDMA Band IV</b>	<b>Test channel:</b>	<b>Lowest</b>
<b>Test mode:</b>	<b>RMC 12.2Kbps Link (QPSK)</b>	<b>Temperature :</b>	<b>25°C</b>
		<b>Relative Humidity:</b>	<b>56%</b>

**Note:** Spurious emissions within 30-1000MHz were found more than 20dB below limit line.

Frequency (MHz)	Spurious Emission				Limit (dBm)	Result
	Polarization	Level (dBm)	Correction Factor (dB)	Spurious emissions (dBm)		
2452.3	Vertical	-78.15	23.16	-54.99	-13.00	PASS
3424.8	V	-77.41	23.37	-54.04		
5137.2	V	-79.42	23.65	-55.77		
2452.3	Horizontal	-76.85	23.16	-53.69		
3424.8	H	-78.21	23.37	-54.84		
5137.2	H	-76.56	23.65	-52.91		

<b>Band</b>	<b>WCDMA Band IV</b>	<b>Test channel:</b>	<b>Middle</b>
<b>Test mode:</b>	<b>RMC 12.2Kbps Link (QPSK)</b>	<b>Temperature :</b>	<b>25°C</b>
		<b>Relative Humidity:</b>	<b>56%</b>

**Note:** Spurious emissions within 30-1000MHz were found more than 20dB below limit line.

Frequency (MHz)	Spurious Emission				Limit (dBm)	Result
	Polarization	Level (dBm)	Correction Factor (dB)	Spurious emissions (dBm)		
2641.3	Vertical	-78.73	23.30	-55.43	-13.00	PASS
3465.2	V	-75.33	23.42	-51.91		
5197.8	V	-80.14	23.73	-56.41		
2641.3	Horizontal	-76.77	23.30	-53.47		
3465.2	H	-79.43	23.42	-56.01		
5197.8	H	-78.55	23.73	-54.82		

<b>Band</b>	<b>WCDMA Band IV</b>	<b>Test channel:</b>	<b>Highest</b>
<b>Test mode:</b>	<b>RMC 12.2Kbps Link (QPSK)</b>	<b>Temperature :</b>	<b>25°C</b>
		<b>Relative Humidity:</b>	<b>56%</b>

**Note:** Spurious emissions within 30-1000MHz were found more than 20dB below limit line.

Frequency (MHz)	Spurious Emission				Limit (dBm)	Result
	Polarization	Level (dBm)	Correction Factor (dB)	Spurious emissions (dBm)		
3102.2	Vertical	-76.80	23.35	-53.45	-13.00	PASS
3505.2	V	-77.92	23.45	-54.47		
5257.8	V	-74.59	23.82	-50.77		
3102.2	Horizontal	-77.81	23.35	-54.46		
3505.2	H	-76.76	23.45	-53.31		
5257.8	H	-80.92	23.82	-57.10		

<b>Band</b>	<b>WCDMA Band II</b>	<b>Test channel:</b>	<b>Lowest</b>
<b>Test mode:</b>	<b>RMC 12.2Kbps Link (QPSK)</b>	<b>Temperature :</b>	<b>25°C</b>
		<b>Relative Humidity:</b>	<b>56%</b>

**Note:** Spurious emissions within 30-1000MHz were found more than 20dB below limit line.

Frequency (MHz)	Spurious Emission				Limit (dBm)	Result
	Polarization	Level (dBm)	Correction Factor (dB)	Spurious emissions (dBm)		
3704.8	Vertical	-66.05	23.53	-42.52	-13.00	PASS
5557.2	V	-78.34	23.78	-54.56		
7409.6	V	-80.32	23.92	-56.40		
3704.8	Horizontal	-68.73	23.53	-45.20		
5557.2	H	-76.63	23.78	-52.85		
7409.6	H	-79.89	23.92	-55.97		

<b>Band</b>	<b>WCDMA Band II</b>	<b>Test channel:</b>	<b>Middle</b>
<b>Test mode:</b>	<b>RMC 12.2Kbps Link (QPSK)</b>	<b>Temperature :</b>	<b>25°C</b>
		<b>Relative Humidity:</b>	<b>56%</b>

**Note:** Spurious emissions within 30-1000MHz were found more than 20dB below limit line.

Frequency (MHz)	Spurious Emission				Limit (dBm)	Result
	Polarization	Level (dBm)	Correction Factor (dB)	Spurious emissions (dBm)		
3760.0	Vertical	-68.99	23.58	-45.41	-13.00	PASS
5640.0	V	-77.75	23.85	-53.90		
7520.0	V	-80.88	23.99	-56.89		
3760.0	Horizontal	-69.73	23.58	-46.15		
5640.0	H	-75.83	23.85	-51.98		
7520.0	H	-79.42	23.99	-55.43		

<b>Band</b>	<b>WCDMA Band II</b>	<b>Test channel:</b>	<b>Highest</b>
<b>Test mode:</b>	<b>RMC 12.2Kbps Link (QPSK)</b>	<b>Temperature :</b>	<b>25°C</b>
		<b>Relative Humidity:</b>	<b>56%</b>

**Note:** Spurious emissions within 30-1000MHz were found more than 20dB below limit line.

Frequency (MHz)	Spurious Emission				Limit (dBm)	Result
	Polarization	Level (dBm)	Correction Factor (dB)	Spurious emissions (dBm)		
3815.2	Vertical	-70.06	23.62	-46.44	-13.00	PASS
5722.8	V	-80.78	23.90	-56.88		
7630.4	V	-81.04	24.05	-56.99		
3815.2	Horizontal	-68.18	23.62	-44.56		
5722.8	H	-76.97	23.90	-53.07		
7630.4	H	-81.36	24.05	-57.31		

## 6.7. Frequency Stability Measurement

### 6.7.1. Test Specification

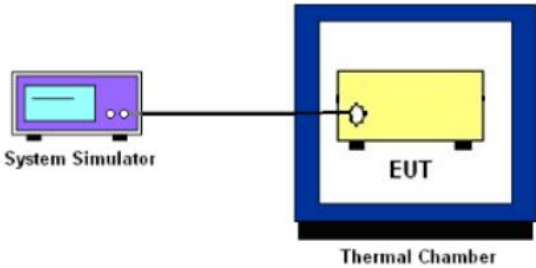
<b>Test Requirement:</b>	FCC Part 2.1055 ; FCC Part 22.355 ; FCC Part 24.235 FCC Part 27.54
<b>Test Method:</b>	FCC KDB 971168 D01v03r01
<b>Operation mode:</b>	Refer to item 4.1
<b>Limit:</b>	FCC Part 22.355 : $\pm 2.5$ ppm FCC Part 24.235 : The frequency stability shall be sufficient to ensure that the fundamental emission stays within the authorized frequency block.
<b>Test Setup:</b>	 <p>The diagram shows a purple 'System Simulator' connected by a cable to a yellow 'EUT' (Equipment Under Test) which is housed inside a blue 'Thermal Chamber'.</p>
<b>Test Procedure:</b>	<p><b>Test Procedures for Temperature Variation</b></p> <ol style="list-style-type: none"> <li>1. The testing follows FCC KDB 971168 D01v03r01 Section 9.0.</li> <li>2. The EUT was set up in the thermal chamber and connected with the system simulator.</li> <li>3. With power OFF, the temperature was decreased to <math>-30^{\circ}\text{C}</math> and the EUT was stabilized before testing. Power was applied and the maximum change in frequency was recorded within one minute.</li> <li>4. With power OFF, the temperature was raised in <math>10^{\circ}\text{C}</math> steps up to <math>50^{\circ}\text{C}</math>. The EUT was stabilized at each step for at least half an hour. Power was applied and the maximum frequency change was recorded within one minute.</li> </ol> <p><b>Test Procedures for Voltage Variation</b></p> <ol style="list-style-type: none"> <li>1. The testing follows FCC KDB 971168 D01v03r01 Section 9.0.</li> <li>2. The EUT was placed in a temperature chamber at <math>25 \pm 5^{\circ}\text{C}</math> and connected with the system simulator.</li> <li>3. The power supply voltage to the EUT was varied from BEP to 115% of the nominal value measured at the input to the EUT.</li> <li>4. The variation in frequency was measured for the worst case.</li> </ol>
<b>Test Result:</b>	PASS
<b>Remark:</b>	All three channels of all modulations have been tested, but only the worst channel and the worst modulation show in this test item.

**6.7.2. Test Instruments**

Equipment	Manufacturer	Model	Serial Number	Calibration Due
System simulator	R&S	CMU200	110188	Sep. 11, 2021
Programable tempratuce and humidity chamber	JQ	JQ-2000	N/A	Sep. 02, 2021
DC power supply	Kingrang	KR3005K	N/A	Sep. 02, 2021
RF cable (9kHz-40GHz)	TCT	RE-04	N/A	Sep. 02, 2021
Antenna Connector	TCT	RFC-03	N/A	Sep. 02, 2021

**Note:** The calibration interval of the above test instruments is 12 months and the calibrations are traceable to international system unit (SI).

6.7.3. Test Data

Test Result of Temperature Variation

Band :	WCDMA Band V	Channel:	4183
Limit (ppm) :	2.5ppm	Frequency:	836.6MHz
Temperature (°C)	HSUPA Deviation (ppm)		Result
50	0.020		PASS
40	0.017		
30	0.015		
20	0.014		
10	0.013		
0	0.015		
-10	0.018		
-20	0.019		
-30	0.022		

Band :	WCDMA Band IV	Channel:	1413
Limit (ppm) :	Note1	Frequency:	1732.6
Temperature (°C)	HSUPA Deviation (ppm)		Result
50	0.017		PASS
40	0.015		
30	0.013		
20	0.012		
10	0.011		
0	0.010		
-10	0.012		
-20	0.015		
-30	0.016		

<b>Band :</b>	<b>WCDMA Band II</b>	<b>Channel:</b>	<b>9400</b>
<b>Limit (ppm) :</b>	<b>Note1</b>	<b>Frequency:</b>	<b>1880MHz</b>
<b>Temperature (°C)</b>	<b>HSUPA Deviation (ppm)</b>		<b>Result</b>
50	0.020		PASS
40	0.019		
30	0.017		
20	0.015		
10	0.014		
0	0.012		
-10	0.015		
-20	0.016		
-30	0.019		

**Note1:** The frequency fundamental emissions stay within the authorized frequency block based on the frequency deviation measured is small.

**Test Result of Voltage Variation**

Band & Channel	Mode	Voltage (Volt)	Deviation (ppm)	Limit (ppm)	Result
WCDMA Band IV CH1413	RMC 12.2Kbps	13.2	-0.013	2.5	PASS
		12	-0.015		
		BEP	-0.016		
WCDMA Band V CH4183	RMC 12.2Kbps	13.2	-0.012		
		12	-0.013		
		BEP	-0.010		
WCDMA Band II CH9400	RMC 12.2Kbps	13.2	-0.015	(Note 3.)	
		12	-0.012		
		BEP	-0.014		

**Note:**

1. Normal Voltage = 12V.
2. The frequency fundamental emissions stay within the authorized frequency block based on the frequency deviation measured is small.



## Appendix A: Photographs of Test Setup

Product: MDVR  
Model: M1N-TKH0401  
Radiated Emission

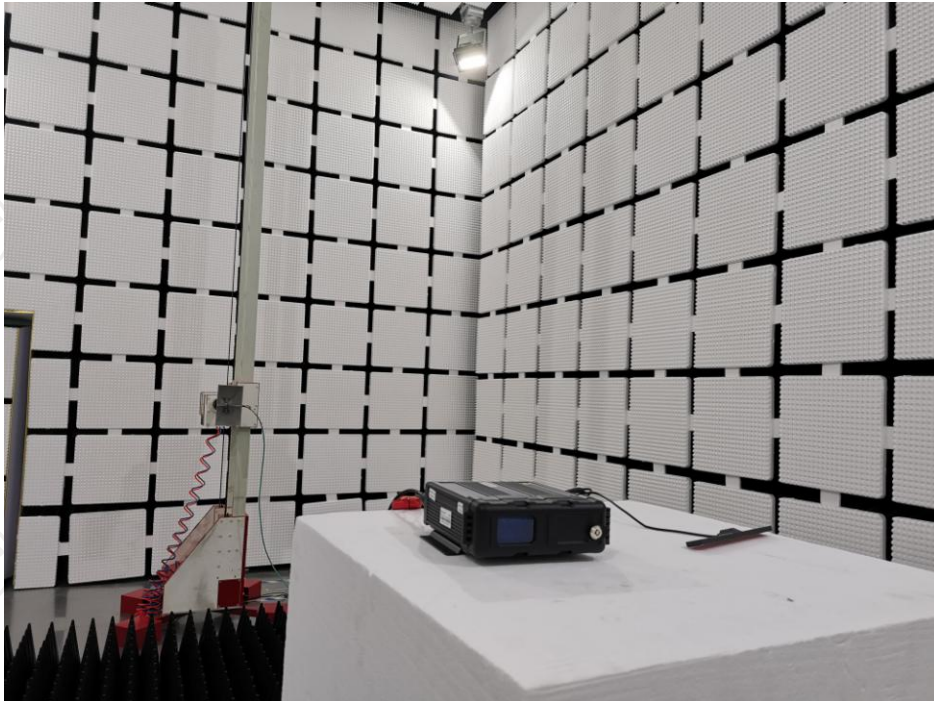
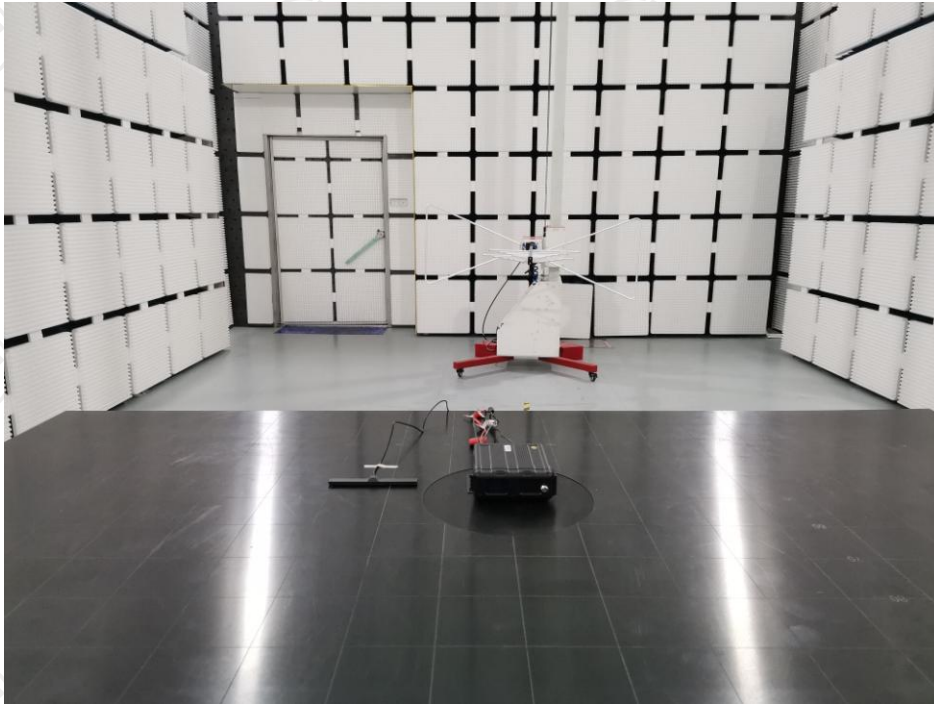

## Appendix B: Photographs of EUT

Refer to the test report No. TCT210423E030

**\*\*\*\*\*END OF REPORT\*\*\*\*\***