



**FCC Part 24test Report  
Part 24 Subpart E**

**Report Reference No.**.....: HK2402210730-5E  
**FCC ID**.....: 2AM6L-M1N2  
Compiled by  
( position+printed name+signature)..: File administrators Len Liao

Supervised by  
( position+printed name+signature)..: Technique principal Sliver Wan

Approved by  
( position+printed name+signature)..: Manager Jason Zhou

Date of issue.....: Mar. 07, 2024

**Testing Laboratory Name** .....: **Shenzhen HUAK Testing Technology Co., Ltd.**

Address .....: 1-2/F., Building B2, Junfeng Zhongcheng Zhizao Innovation Park,  
Heping, Fuhai Street, Bao'an District, Shenzhen, Guangdong, China

**Applicant's name**.....: **Streamax Technology Co., Ltd.**

Address .....: 21-23/F, Building B1, Zhiyuan, No. 1001, Xueyuan Avenue,  
Nanshan District, Shenzhen, Guangdong 518055, China

**Test specification** .....

Standard .....: **FCC CFR Title 47 Part 2, Part 24E**

TRF Originator.....: Shenzhen HUAK Testing Technology Co., Ltd.

**Shenzhen HUAK Testing Technology Co., Ltd.All rights reserved.**

This publication may be reproduced in whole or in part for non-commercial purposes as long as the Shenzhen HUAK Testing Technology Co., Ltd.as copyright owner and source of the material. Shenzhen HUAK Testing Technology Co., Ltd.takes no responsibility for and will not assume liability for damages resulting from the reader's interpretation of the reproduced material due to its placement and context.

**Test item description** .....: MDVR

Trade Mark .....: N/A

**Manufacturer**.....: **Streamax Technology Co., Ltd.**

Model/Type reference.....: M1N 2.0

Series Models .....: N/A

Modulation Type.....: QPSK, 16QAM

Rating .....: DC 12V from DC Power

Hardware version .....: V1.0

Software version.....: V1.0

Result.....: **PASS**



# TEST REPORT

<b>Test Report No. :</b>	<b>HK2402210730-5E</b>	Mar. 07, 2024
		Date of issue

Equipment under Test : MDVR

Model /Type : M1N 2.0

Series Models : N/A

**Applicant** : **Streamax Technology Co., Ltd.**

Address : 21-23/F, Building B1, Zhiyuan, No. 1001, Xueyuan Avenue, Nanshan District, Shenzhen, Guangdong 518055, China

**Manufacturer** : **Streamax Technology Co., Ltd.**

Address : 21-23/F, Building B1, Zhiyuan, No. 1001, Xueyuan Avenue, Nanshan District, Shenzhen, Guangdong 518055, China

<b>Test Result:</b>	<b>PASS</b>
---------------------	-------------

The test report merely corresponds to the test sample. It is not permitted to copy extracts of these test result without the written permission of the test laboratory.



## Contents

<b>1</b>	<b>Test Standards .....</b>	<b>5</b>
<b>2</b>	<b>Summary .....</b>	<b>6</b>
2.1	General Remarks	6
2.2	Product Description	6
2.3	Equipment Under Test	6
2.4	Short Description of The Equipment Under Test (EUT)	6
2.5	Test Frequency List	7
2.6	Normal Accessory Setting	7
2.7	EUT Configuration	7
2.8	Related Submittal(s) / Grant (s)	7
2.9	Modifications	7
2.10	GeneralTest Conditions/Configurations	8
<b>3</b>	<b>Test Environment .....</b>	<b>9</b>
3.1	Information of The Test Laboratory	9
3.2	Environmental Conditions	9
3.3	Test Description	9
3.4	Equipments Used During The Test	10
<b>4</b>	<b>Test Conditions and Results .....</b>	<b>11</b>
4.1	Output Power	11
4.2	Peak-to-Average Ratio (PAR)	17
4.3	Occupied Bandwidth and Emission Bandwidth	24
4.4	Band Edge Compliance	31
4.5	Spurious Emssion on Antenna Port	38
4.6	Radiated Spurious Emssion	57
4.7	Frequency Stability	65
<b>5</b>	<b>Test Setup Photos of the EUT .....</b>	<b>67</b>
<b>6</b>	<b>Photos of the EUT .....</b>	<b>68</b>



**\*\* Modified History \*\***

<b>Revision</b>	<b>Description</b>	<b>Issued Data</b>	<b>Remark</b>
Revision 1.0	Initial Test Report Release	Mar. 07, 2024	Jason Zhou

The results shown in this test report refer only to the sample(s) tested unless otherwise stated and the sample(s) are retained for 30 days only. The document is issued by HUAK, this document cannot be reproduced except in full with our prior written permission. The more details and the authenticity of the report will be confirmed at <http://www.cer-mark.com>.

TEL : +86-755 2302 9901 FAX : +86-755 2302 9901 E-mail : [service@cer-mark.com](mailto:service@cer-mark.com)

Address: 1-2F., Building B2, Junfeng Zhongcheng Zhizao Innovation Park, Heping Community, Fuhai Street, Bao'an District, Shenzhen, Guangdong, China



## **1 Test Standards**

The tests were performed according to following standards:

[FCC Part 24](#): Public Mobile Services.

[TIA/EIA 603 D June 2010](#): Land Mobile FM or PM Communications Equipment Measurement and Performance Standards.

[47 CFR FCC Part 15 Subpart B](#): Unintentional Radiators.

[FCC Part 2](#): Frequency Allocations And Radio Treaty Matters; General Rules And Regulations.

[KDB971168 D01:v02r02](#): Measurement Guidance For Certification Of Licensed Digital Transmitters.

[ANSI C63.4:2014](#): Methods of Measurement of Radio-Noise Emissions from Low-Voltage Electrical and Electronic Equipment in the Range of 9 kHz to 40 GHz.



## 2 Summary

### 2.1 General Remarks

Date of receipt of test sample	:	Feb. 21, 2024
Testing commenced on	:	Feb. 21, 2024
Testing concluded on	:	Mar. 07, 2024

### 2.2 Product Description

The Streamax Technology Co., Ltd.'s Model: M1N 2.0 or the "EUT" as referred to in this report; more general information as follows,for more details, refer to the user's manual of the EUT.

Name of EUT:	MDVR
Model/Type reference:	M1N 2.0
Series Models:	N/A
Power supply:	DC12V from DC Power
Modulation Type:	QPSK,16QAM
Antenna Type:	External Antenna
Antenna Gain:	2dBi
Operation Frequency Band:	LTE Band 2
Operation frequency:	LTE Band 2: 1850~1910 MHz(TX), 1930~1990 MHz(TX)
LTE Release:	R8
Extreme temp. Tolerance:	-30°C to +70°C
Extreme vol. Limits:	10.2VDC to 13.8VDC (nominal: 12VDC)

### 2.3 Equipment Under Test

#### Power supply system utilised

Power supply voltage	:	<input type="radio"/> 120V/ 60 Hz	<input type="radio"/> 115V/60Hz
		<input checked="" type="radio"/> 12 V DC	<input type="radio"/> 24 V DC
		<input type="radio"/> Other (specified in blank below)	

### 2.4 Short Description of The Equipment Under Test (EUT)

#### 2.4.1 General Description

This is a MDVR.

For more details, refer to the user's manual of the EUT.



### 2.5 Test Frequency List

TX Channel Bandwidth	Frequency (MHz)	channel
1.4 MHz	1850.7	18607
	1880.0	18900
	1909.3	19193
3 MHz	1851.5	18615
	1880.0	18900
	1908.5	19185
5 MHz	1852.5	18625
	1880.0	18900
	1907.5	19175
10 MHz	1855.0	18650
	1880.0	18900
	1905.0	19150
15 MHz	1857.5	18675
	1880.0	18900
	1902.5	19125
20 MHz	1860.0	18700
	1880.0	18900
	1900.0	19100

### 2.6 Normal Accessory Setting

Fully charged battery was used during the test.

### 2.7 EUT Configuration

The following peripheral devices and interface cables were connected during the measurement:

- - supplied by the manufacturer
- - supplied by the lab

<input type="radio"/>	Power Cable	Length (m) :	/
		Shield :	/
		Detachable :	/
<input type="radio"/>	Multimeter	Manufacturer :	/
		Model No. :	/

### 2.8 Related Submittal(s) / Grant (s)

This submittal(s) (test report) is intended for FCC ID: 2AM6L-M1N2 filing to comply with FCC Part 24, Rules.

### 2.9 Modifications

No modifications were implemented to meet testing criteria.



### 2.10 General Test Conditions/Configurations

#### 2.10.1 Test Environment

Environment Parameter	Selected Values During Tests	
Relative Humidity	Ambient	
Temperature	TN	Ambient
Voltage	VL	10.2V
	VN	12.0V
	VH	13.8V

NOTE: VL=lower extreme test voltage VN=nominal voltage  
 VH=upper extreme test voltage TN=normal temperature





### 3 Test Environment

#### 3.1 Information of The Test Laboratory

Shenzhen HUAKE Testing Technology Co., Ltd.  
Add.: 1-2/F., Building B2, Junfeng Zhongcheng Zhizao Innovation Park, Heping,  
Fuhai Street, Bao'an District, Shenzhen, Guangdong, China

Testing Laboratory Authorization:

A2LA Accreditation Code is 4781.01.  
FCC Designation Number is CN1229.  
Canada IC CAB identifier is CN0045.  
CNAS Registration Number is L9589.

#### 3.2 Environmental Conditions

During the measurement the environmental conditions were within the listed ranges:

Temperature:	15-35 ° C
Humidity:	30-60 %
Atmospheric pressure:	950-1050mbar

#### 3.3 Test Description

##### PCSBand (1850-1915MHz pairedwith 1930-1995MHz)

Test Item	FCCRuleNo.	Requirements	Verdict
Effective(Isotropic)Radiated Output Power	Part§2.1046, Part§24.232	EIRP ≤ 2W	Pass
Peak-Average Ratio	Part§2.1046, Part§24.232	FCC:Limit≤13dB	Pass
Bandwidth	Part§2.1049 RSS-133	OBW: Nolimit. EBW: Nolimit.	Pass
Band Edges Compliance	Part§2.1051, Part§24.238	≤ -13dBm/1%*EBW, In1MHz bands immediately outside and adjacent to The frequency block.	Pass
Spurious Emission at Antenna Terminals	Part§2.1051, Part§24.238	≤-13dBm/1MHz, from 9kHz to10th harmonics but outside authorized Operating frequency ranges.	Pass
Field Strength of Spurious Radiation	Part§2.1053, Part§24.238	≤ -13dBm/1MHz.	Pass
Frequency Stability	Part§2.1055, Part§24.235	FCC:within authorized frequency block.	Pass

NOTE 1:For the verdict, the "N/A" denotes "not applicable", the "N/T" denotes "not tested".

Remark:

1. The measurement uncertainty is not included in the test result.



3.4 Equipments Used During The Test

Test Equipment	Manufacturer	Model No.	Serial No.	Calibration Date	Calibration Due Date
LISN	ENV216	R&S	HKE-059	2024/02/20	2025/02/19
LISN	R&S	ENV216	HKE-002	2024/02/20	2025/02/19
Broadband antenna	Schwarzbeck	VULB 9163	HKE-012	2024/02/21	2026/02/20
Receiver	R&S	ESR-7	HKE-010	2024/02/20	2025/02/19
Spectrum analyzer	Agilent	N9020A	HKE-048	2024/02/20	2025/02/19
RF automatic control unit	Tonscend	JS0806-2	HKE-060	2024/02/20	2025/02/19
Horn antenna	Schwarzbeck	9120D	HKE-013	2024/02/21	2026/02/20
Loop antenna	Schwarzbeck	FMZB 1519 B	HKE-014	2024/02/21	2026/02/20
Preamplifier	EMCI	EMC051845SE	HKE-015	2024/02/20	2025/02/19
Preamplifier	Agilent	83051A	HKE-016	2024/02/20	2025/02/19
Temperature and humidity meter	Boyang	HTC-1	HKE-075	2024/02/20	2025/02/19
High pass filter unit	Tonscend	JS0806-F	HKE-055	2024/02/20	2025/02/19
RF cable	Times	1-40G	HKE-034	2024/02/20	2025/02/19
Power meter	Agilent	E4419B	HKE-085	2024/02/20	2025/02/19
Power Sensor	Agilent	E9300A	HKE-086	2024/02/20	2025/02/19
Wireless Communication Test Set	R&S	CMU200	HKE-026	2024/02/20	2025/02/19
High gain antenna	Schwarzbeck	LB-180400KF	HKE-054	2024/02/21	2026/02/20
Horn antenna	Schwarzbeck	9120D	HKE-135	2024/02/21	2026/02/20
High gain antenna	Schwarzbeck	LB-180400KF	HKE-128	2024/02/21	2026/02/20
Broadband antenna	Schwarzbeck	VULB 9163	HKE-087	2024/02/21	2026/02/20
Signal generator	Agilent	E4433B	HKE-120	2024/02/20	2025/02/19
Signal generator	Agilent	E4421B	HKE-121	2024/02/20	2025/02/19

The results shown in this test report refer only to the sample(s) tested unless otherwise stated and the sample(s) are retained for 30 days only. The document is issued by HUAKE, this document cannot be reproduced except in full with our prior written permission. The more details and the authenticity of the report will be confirmed at <http://www.cer-mark.com>.

TEL : +86-755 2302 9901 FAX : +86-755 2302 9901 E-mail : [service@cer-mark.com](mailto:service@cer-mark.com)

Add: 1-2F., Building B2, Junfeng Zhongcheng Zhizao Innovation Park, Heping Community, Fuhai Street, Bao'an District, Shenzhen, Guangdong, China

## 4 Test Conditions and Results

### 4.1 Output Power

#### 4.1.1 Conducted Output Power

##### TEST APPLICABLE

During the process of testing, the EUT was controlled via R&S Digital Radio Communication tester (CMW500) to ensure max power transmission and proper modulation. This result contains output power and EIRP measurements for the EUT. In all cases, output power is within the specified limits.

##### TEST CONFIGURATION

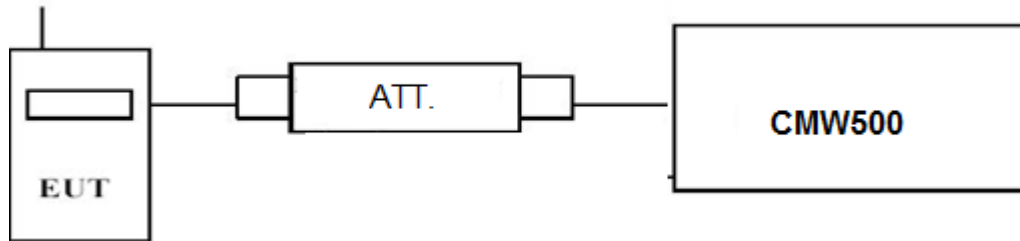

##### TEST PROCEDURE

###### **Conducted Power Measurement:**

- Place the EUT on a bench and set it in transmitting mode.
- Connect a low loss RF cable from the antenna port to a CMW500 by an Att.
- EUT Communicate with CMW500 then selects a channel for testing.
- Add a correction factor to the display CMW500, and then test.

##### TEST RESULTS

*Remark:*

- We measured all RB Configuration refer 3GPP TS136 521 for each Channel Bandwidth of LTE FDD Band 2;

LTE FDD Band 2				
TX Channel Bandwidth	Frequency (MHz)	RB Size/Offset	Burst Average Power [dBm]	
			QPSK	16QAM
1.4 MHz	1850.7	1 RB low	23.86	22.89
		1 RB high	24.13	23.18
		50% RB mid	23.83	22.84
		100% RB	23.90	22.86
	1880.0	1 RB low	23.88	22.32
		1 RB high	23.83	22.86
		50% RB mid	22.87	21.94
		100% RB	23.58	22.79
	1909.3	1 RB low	23.45	22.46
		1 RB high	23.47	22.37
		50% RB mid	23.63	22.40
		100% RB	23.62	22.39
3 MHz	1851.5	1 RB low	23.79	22.65
		1 RB high	23.82	23.19
		50% RB mid	23.95	22.75
		100% RB	22.87	21.96
	1880.0	1 RB low	22.90	21.83



5 MHz	1908.5	1 RB high	22.85	22.05	
		50% RB mid	22.88	21.94	
		100% RB	23.41	22.45	
	1852.5	1 RB low	23.22	22.35	
		1 RB high	23.65	22.60	
		50% RB mid	22.61	21.69	
	10 MHz	1880.0	100% RB	22.48	21.76
			1 RB low	23.88	22.45
			1 RB high	24.03	23.15
1907.5		50% RB mid	23.98	22.79	
		1 RB low	22.86	21.84	
		1 RB high	22.93	22.03	
15 MHz		1855.0	50% RB mid	22.94	21.87
			100% RB	23.67	22.70
			1 RB low	23.55	22.24
	1880.0	1 RB high	23.72	22.59	
		50% RB mid	22.47	21.59	
		100% RB	22.45	21.66	
	20 MHz	1855.0	1 RB low	23.84	23.36
			1 RB high	23.87	23.16
			50% RB mid	24.07	22.88
1880.0		100% RB	23.05	22.18	
		1 RB low	23.10	22.09	
		1 RB high	22.95	21.79	
20 MHz		1905.0	50% RB mid	22.91	21.89
			100% RB	23.68	22.63
			1 RB low	23.62	22.58
	1857.5	1 RB high	23.54	23.10	
		50% RB mid	22.64	21.51	
		100% RB	22.63	21.56	
	20 MHz	1880.0	1 RB low	23.82	22.97
			1 RB high	23.77	22.70
			50% RB mid	23.73	22.81
1902.5		100% RB	22.97	22.96	
		1 RB low	22.46	22.74	
		1 RB high	23.19	23.18	
20 MHz		1860.0	50% RB mid	22.74	21.81
			100% RB	23.55	22.62
			1 RB low	23.40	22.97
	1880.0	1 RB high	23.47	22.65	
		50% RB mid	22.54	22.63	
		100% RB	22.99	22.99	
	20 MHz	1900.0	1 RB low	23.78	23.60
			1 RB high	24.02	23.72
			50% RB mid	23.96	23.25
1880.0		100% RB	22.93	21.92	
		1 RB low	22.85	21.89	
		1 RB high	22.89	21.95	
1860.0	50% RB mid	22.88	21.93		
	100% RB	23.63	22.73		
	1 RB low	23.98	23.46		
1860.0	1 RB high	23.53	23.14		
	50% RB mid	22.64	21.72		
	100% RB	22.59	21.74		

The results shown in this test report refer only to the sample(s) tested unless otherwise stated and the sample(s) are retained for 30 days only. The document is issued by HUAKE, this document cannot be reproduced except in full with our prior written permission. The more details and the authenticity of the report will be confirmed at <http://www.cer-mark.com>.

TEL : +86-755 2302 9901 FAX : +86-755 2302 9901 E-mail : service@cer-mark.com

Add: 1-2F., Building B2, Junfeng Zhongcheng Zhizao Innovation Park, Heping Community, Fuhai Street, Bao'an District, Shenzhen, Guangdong, China

## 4.1.2. Radiated Output Power

### LIMIT

This is the test for the maximum radiated power from the EUT.

Rule Part 24.232(b) specifies, "Mobile/portable stations are limited to 2 watts e.i.r.p.

### TEST CONFIGURATION

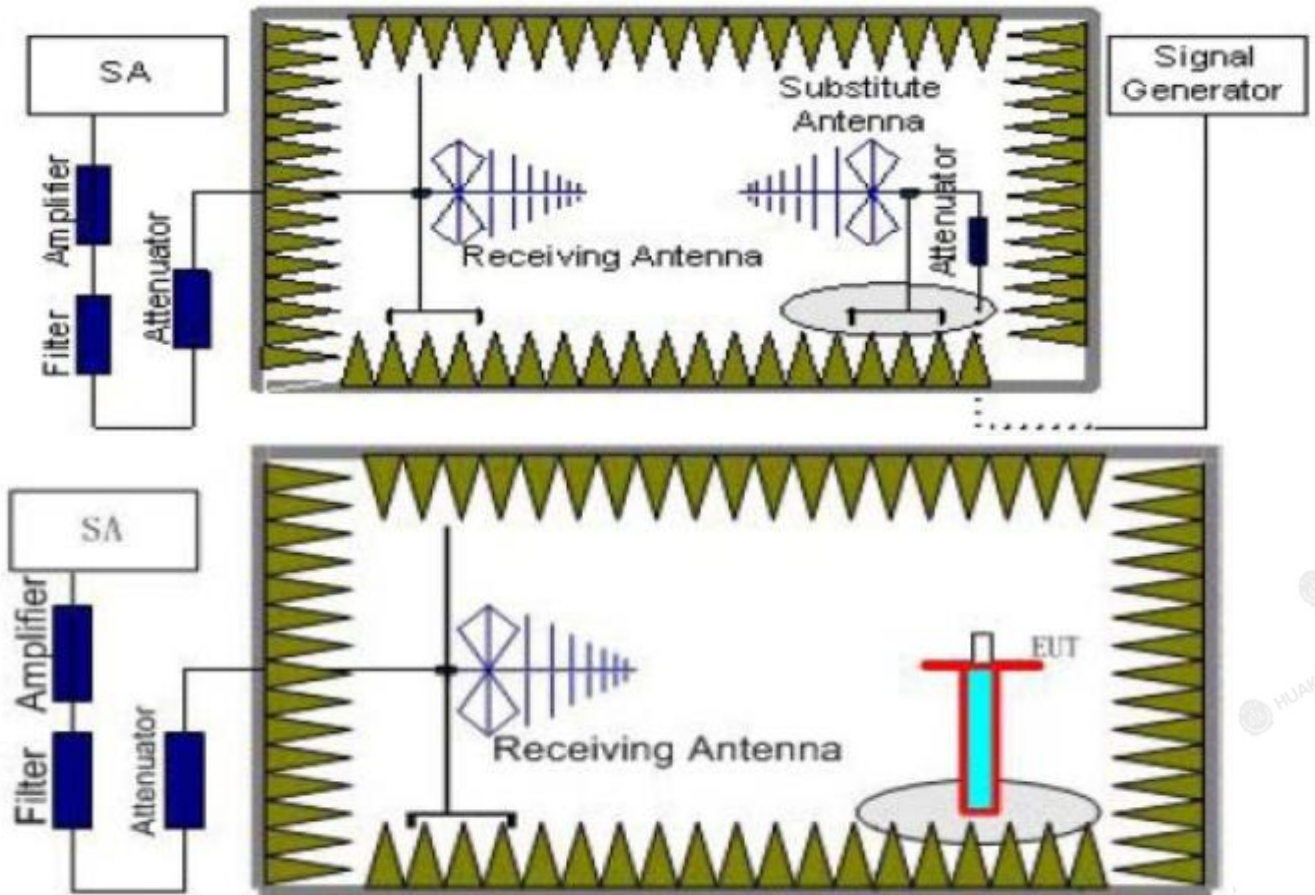

### TEST PROCEDURE

1. EUT was placed on a 1.50 meter high non-conductive stand at a 3 meter test distance from the receive antenna. A receiving antenna was placed on the antenna mast 3 meters from the EUT for emission measurements. The height of receiving antenna is 1.50m. Detected emissions were maximized at each frequency by rotating the EUT through 360° and adjusting the receiving antenna polarization. The radiated emission measurements of all transmit frequencies in three channels (High, Middle, Low) were measured with peak detector.
2. A log-periodic antenna or double-ridged waveguide horn antenna shall be substituted in place of the EUT. The log-periodic antenna will be driven by a signal generator and the level will be adjusted till the same power value on the spectrum analyzer or receiver. The level of the spurious emissions can be calculated through the level of the signal generator, cable loss, the gain of the substitution antenna and the reading of the spectrum analyzer or receiver.
3. The EUT is then put into continuously transmitting mode at its maximum power level during the test. Set Test Receiver or Spectrum RBW=1MHz, VBW=3MHz, And the maximum value of the receiver should be recorded as (P<sub>r</sub>).
4. The EUT shall be replaced by a substitution antenna. In the chamber, an substitution antenna for the frequency band of interest is placed at the reference point of the chamber. An RF Signal source for the frequency band of interest is connected to the substitution antenna with a cable that has been constructed to not interfere with the radiation pattern of the antenna.



- A power ( $P_{Mea}$ ) is applied to the input of the substitution antenna, and adjust the level of the signal generator output until the value of the receiver reach the previously recorded ( $P_r$ ). The power of signal source ( $P_{Mea}$ ) is recorded. The test should be performed by rotating the test item and adjusting the receiving antenna polarization.
- A amplifier should be connected to the Signal Source output port. And the cable should be connect between the Amplifier and the Substitution Antenna. The cable loss ( $P_{cl}$ ), the Substitution Antenna Gain ( $G_a$ ) and the Amplifier Gain ( $P_{Ag}$ ) should be recorded after test.  
The measurement results are obtained as described below:  
Power(EIRP)= $P_{Mea} - P_{cl} + G_a$   
We used SMF100A micowave signal generator which signal level can up to 33dBm,so we not used power Amplifier for substitution test; The measurement results are amend as described below:  
Power(EIRP)= $P_{Mea} - P_{cl} + G_a$
- This value is EIRP since the measurement is calibrated using an antenna of known gain (2.15 dBi) and known input power.
- ERP can be calculated from EIRP by subtracting the gain of the dipole,  $ERP = EIRP - 2.15dBi$ .

**TEST RESULTS**

**Radiated Measurement:**

Remark:

- We measured all RB Configuration refer 3GPP TS136 521 for each Channel Bandwidth of LTE FDD Band 2; recorded worst case for each Channel Bandwidth of LTE FDD Band 2.
- $EIRP = P_{Mea}(dBm) - P_{cl}(dB) + P_{Ag}(dB) + G_a(dBi)$
- We measured both Horizontal and Vertical direction, recorded worst case direction.

**LTE FDD Band 2\_Channel Bandwidth 1.4MHz\_QPSK**

Frequency (MHz)	$P_{Mea}$ (dBm)	$P_{cl}$ (dB)	$G_a$ Antenna Gain(dB)	$P_{Ag}$ (dB)	Burst Average EIRP (dBm)	Limit (dBm)	Margin (dB)	Polarization
1850.7	-12.36	3.41	10.24	33.6	28.07	33.01	4.94	V
1880.0	-14.98	3.49	10.24	33.6	25.37	33.01	7.64	V
1909.3	-16.45	3.55	10.23	33.6	23.83	33.01	9.18	V

**LTE FDD Band 2\_Channel Bandwidth 3MHz\_QPSK**

Frequency (MHz)	$P_{Mea}$ (dBm)	$P_{cl}$ (dB)	$G_a$ Antenna Gain(dB)	$P_{Ag}$ (dB)	Burst Average EIRP (dBm)	Limit (dBm)	Margin (dB)	Polarization
1851.5	-14.19	3.41	10.24	33.6	26.24	33.01	6.77	V
1880.0	-14.06	3.49	10.24	33.6	26.29	33.01	6.72	V
1908.5	-15.02	3.55	10.23	33.6	25.26	33.01	7.75	V

**LTE FDD Band 2\_Channel Bandwidth 5MHz\_QPSK**

Frequency (MHz)	$P_{Mea}$ (dBm)	$P_{cl}$ (dB)	$G_a$ Antenna Gain(dB)	$P_{Ag}$ (dB)	Burst Average EIRP (dBm)	Limit (dBm)	Margin (dB)	Polarization
1852.5	-14.94	3.41	10.24	33.6	25.49	33.01	7.52	V
1880.0	-14.99	3.49	10.24	33.6	25.36	33.01	7.65	V
1907.5	-14.13	3.55	10.23	33.6	26.15	33.01	6.86	V



LTE FDD Band 2\_Channel Bandwidth 10MHz\_QPSK

Frequency (MHz)	P <sub>Mea</sub> (dBm)	P <sub>cl</sub> (dB)	G <sub>a</sub> Antenna Gain(dB)	P <sub>Aq</sub> (dB)	Burst Average EIRP (dBm)	Limit (dBm)	Margin (dB)	Polarization
1855.0	-15.96	3.41	10.24	33.6	24.47	33.01	8.54	V
1880.0	-14.5	3.49	10.24	33.6	25.85	33.01	7.16	V
1905.0	-14.85	3.55	10.23	33.6	25.43	33.01	7.58	V

LTE FDD Band 2\_Channel Bandwidth 15MHz\_QPSK

Frequency (MHz)	P <sub>Mea</sub> (dBm)	P <sub>cl</sub> (dB)	G <sub>a</sub> Antenna Gain(dB)	P <sub>Aq</sub> (dB)	Burst Average EIRP (dBm)	Limit (dBm)	Margin (dB)	Polarization
1857.5	-14.25	3.41	10.24	33.6	26.18	33.01	6.83	V
1880.0	-14.72	3.49	10.24	33.6	25.63	33.01	7.38	V
1902.5	-14.86	3.55	10.23	33.6	25.42	33.01	7.59	V

LTE FDD Band 2\_Channel Bandwidth 20MHz\_QPSK

Frequency (MHz)	P <sub>Mea</sub> (dBm)	P <sub>cl</sub> (dB)	G <sub>a</sub> Antenna Gain(dB)	P <sub>Aq</sub> (dB)	Burst Average EIRP (dBm)	Limit (dBm)	Margin (dB)	Polarization
1860.0	-12.94	3.41	10.24	33.6	27.49	33.01	5.52	V
1880.0	-13.17	3.49	10.24	33.6	27.18	33.01	5.83	V
1900.0	-14.92	3.55	10.23	33.6	25.36	33.01	7.65	V

LTE FDD Band 2\_Channel Bandwidth 1.4MHz\_16QAM

Frequency (MHz)	P <sub>Mea</sub> (dBm)	P <sub>cl</sub> (dB)	G <sub>a</sub> Antenna Gain(dB)	P <sub>Aq</sub> (dB)	Burst Average EIRP (dBm)	Limit (dBm)	Margin (dB)	Polarization
1850.7	-14.14	3.41	10.24	33.6	26.29	33.01	6.72	V
1880.0	-14.37	3.49	10.24	33.6	25.98	33.01	7.03	V
1909.3	-14.11	3.55	10.23	33.6	26.17	33.01	6.84	V

LTE FDD Band 2\_Channel Bandwidth 3MHz\_16QAM

Frequency (MHz)	P <sub>Mea</sub> (dBm)	P <sub>cl</sub> (dB)	G <sub>a</sub> Antenna Gain(dB)	P <sub>Aq</sub> (dB)	Burst Average EIRP (dBm)	Limit (dBm)	Margin (dB)	Polarization
1851.5	-15.37	3.41	10.24	33.6	25.06	33.01	7.95	V
1880.0	-15.25	3.49	10.24	33.6	25.1	33.01	7.91	V
1908.5	-15.94	3.55	10.23	33.6	24.34	33.01	8.67	V

LTE FDD Band 2\_Channel Bandwidth 5MHz\_16QAM

Frequency (MHz)	P <sub>Mea</sub> (dBm)	P <sub>cl</sub> (dB)	G <sub>a</sub> Antenna Gain(dB)	P <sub>Aq</sub> (dB)	Burst Average EIRP (dBm)	Limit (dBm)	Margin (dB)	Polarization
1852.5	-14.66	3.41	10.24	33.6	25.77	33.01	7.24	V
1880.0	-13.71	3.49	10.24	33.6	26.64	33.01	6.37	V
1907.5	-16.11	3.55	10.23	33.6	24.17	33.01	8.84	V

The results shown in this test report refer only to the sample(s) tested unless otherwise stated and the sample(s) are retained for 30 days only. The document is issued by HUAKE, this document cannot be reproduced except in full with our prior written permission. The more details and the authenticity of the report will be confirmed at <http://www.cer-mark.com>.

TEL : +86-755 2302 9901 FAX : +86-755 2302 9901 E-mail : service@cer-mark.com

Add: 1-2F., Building B2, Junfeng Zhongcheng Zhizao Innovation Park, Heping Community, Fuhai Street, Bao'an District, Shenzhen, Guangdong, China



LTE FDD Band 2 Channel Bandwidth 10MHz 16QAM

Frequency (MHz)	P <sub>Mea</sub> (dBm)	P <sub>cl</sub> (dB)	G <sub>a</sub> Antenna Gain(dB)	P <sub>Aq</sub> (dB)	Burst Average EIRP (dBm)	Limit (dBm)	Margin (dB)	Polarization
1855.0	-14.68	3.41	10.24	33.6	25.75	33.01	7.26	V
1880.0	-13.69	3.49	10.24	33.6	26.66	33.01	6.35	V
1905.0	-15.23	3.55	10.23	33.6	25.05	33.01	7.96	V

LTE FDD Band 2 Channel Bandwidth 15MHz 16QAM

Frequency (MHz)	P <sub>Mea</sub> (dBm)	P <sub>cl</sub> (dB)	G <sub>a</sub> Antenna Gain(dB)	P <sub>Aq</sub> (dB)	Burst Average EIRP (dBm)	Limit (dBm)	Margin (dB)	Polarization
1857.5	-12.75	3.41	10.24	33.6	27.68	33.01	5.33	V
1880.0	-14.58	3.49	10.24	33.6	25.77	33.01	7.24	V
1902.5	-14.06	3.55	10.23	33.6	26.22	33.01	6.79	V

LTE FDD Band 2 Channel Bandwidth 20MHz 16QAM

Frequency (MHz)	P <sub>Mea</sub> (dBm)	P <sub>cl</sub> (dB)	G <sub>a</sub> Antenna Gain(dB)	P <sub>Aq</sub> (dB)	Burst Average EIRP (dBm)	Limit (dBm)	Margin (dB)	Polarization
1860.0	-14.25	3.41	10.24	33.6	26.18	33.01	6.83	V
1880.0	-12.51	3.49	10.24	33.6	27.84	33.01	5.17	V
1900.0	-14.75	3.55	10.23	33.6	25.53	33.01	7.48	V

The results shown in this test report refer only to the sample(s) tested unless otherwise stated and the sample(s) are retained for 30 days only. The document is issued by HUAK, this document cannot be reproduced except in full with our prior written permission. The more details and the authenticity of the report will be confirmed at <http://www.cer-mark.com>.

TEL : +86-755 2302 9901 FAX : +86-755 2302 9901 E-mail : [service@cer-mark.com](mailto:service@cer-mark.com)

Add: 1-2F., Building B2, Junfeng Zhongcheng Zhizao Innovation Park, Heping Community, Fuhai Street, Bao'an District, Shenzhen, Guangdong, China





### 4.2 Peak-to-Average Ratio (PAR)

#### LIMIT

The Peak-to-Average Ratio (PAR) of the transmission may not exceed 13 dB.

#### TEST CONFIGURATION

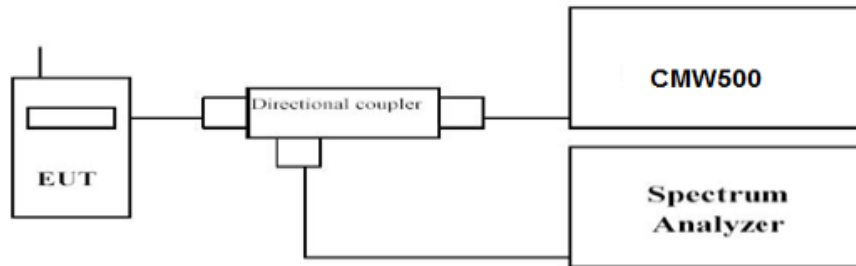

#### TEST PROCEDURE

1. Refer to instrument’s analyzer instruction manual for details on how to use the power statistics/CCDF function;
2. Set resolution/measurement bandwidth  $\geq$  signal’s occupied bandwidth;
3. Set the number of counts to a value that stabilizes the measured CCDF curve;
4. Set the measurement interval as follows:
  - 1). for continuous transmissions, set to 1 ms;
  - 2). for burst transmissions, employ an external trigger that is synchronized with the EUT burst timing sequence, or use the internal burst trigger with a trigger level that allows the burst to stabilize and set the measurement interval to a time that is less than or equal to the burst duration.
5. Record the maximum PAPR level associated with a probability of 0.1%.

#### TEST RESULTS

Remark:

1. We measured all RB Configuration refer 3GPP TS136 521 for each Channel Bandwidth of LTE FDD Band 2; recorded worst case for each Channel Bandwidth of LTE FDD Band 2.

LTE FDD Band 2				
TX Channel Bandwidth	Frequency (MHz)	RB Size/Offset	PAPR(dB)	
			QPSK	16QAM
1.4 MHz	1850.7	1RB#0	4.26	5.23
	1880.0		8.43	4.94
	1909.3		3.97	8.45
3 MHz	1851.5	1RB#0	8.46	5.31
	1880.0		4.16	8.46
	1908.5		8.48	8.46
5 MHz	1852.5	1RB#0	4.36	5.20
	1880.0		4.13	8.45
	1907.5		8.50	4.90
10 MHz	1855.0	1RB#0	8.45	5.39
	1880.0		4.18	5.05
	1905.0		4.41	5.28
15 MHz	1857.5	1RB#0	4.52	8.44
	1880.0		8.48	5.19
	1902.5		4.43	5.30
20 MHz	1860.0	1RB#0	4.45	5.32
	1880.0		4.30	8.48
	1900.0		8.49	5.52

The results shown in this test report refer only to the sample(s) tested unless otherwise stated and the sample(s) are retained for 30 days only. The document is issued by HUAKE, this document cannot be reproduced except in full with our prior written permission. The more details and the authenticity of the report will be confirmed at <http://www.cer-mark.com>.



LTE FDD Band 2 – 1.4 MHz Channel BandwidthPAPR

QPSK

16QAM

Low Channel

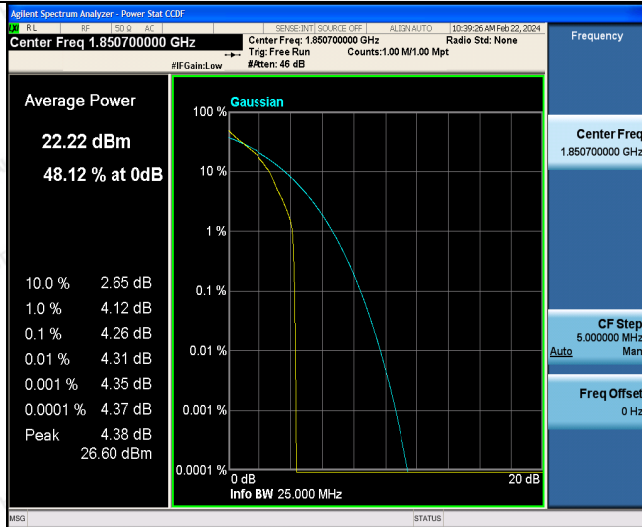

1RB#0

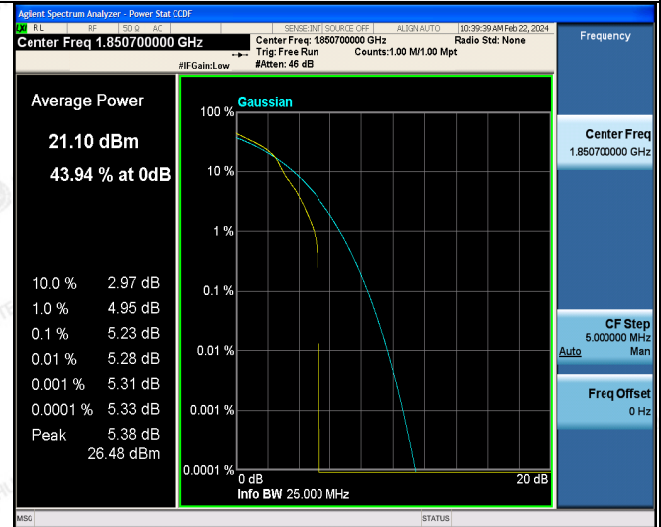

1RB#0

Middle Channel

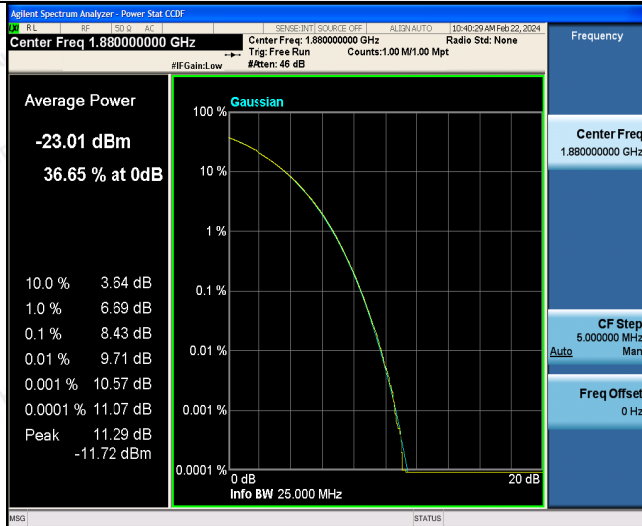

1RB#0

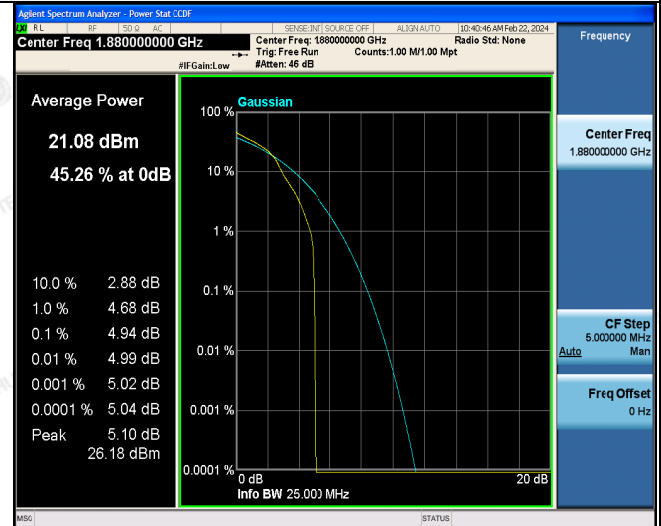

1RB#0

High Channel

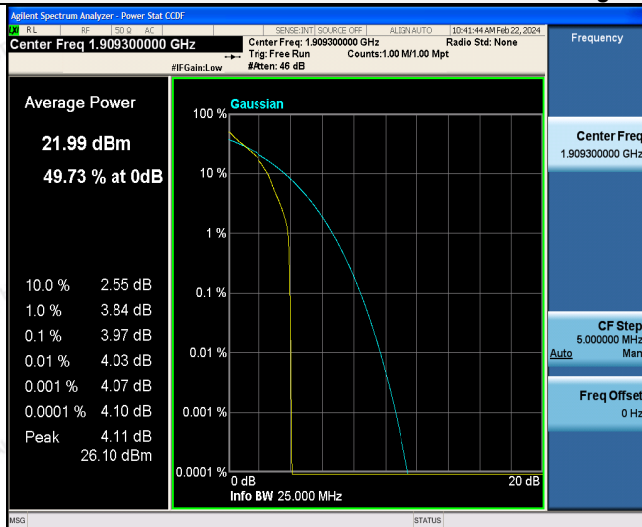

1RB#0

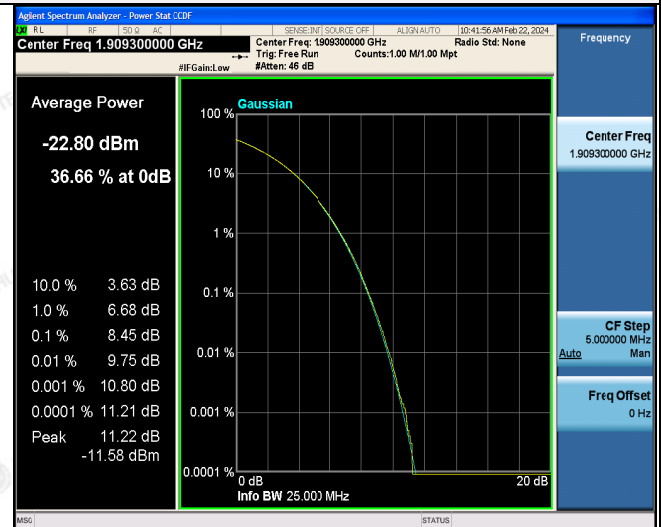

1RB#0

The results shown in this test report refer only to the sample(s) tested unless otherwise stated and the sample(s) are retained for 30 days only. The document is issued by HUAJ, this document cannot be reproduced except in full with our prior written permission. The more details and the authenticity of the report will be confirmed at http://www.cer-mark.com.

TEL : +86-755 2302 9901 FAX : +86-755 2302 9901 E-mail : service@cer-mark.com

Add: 1-2F., Building B2, Junfeng Zhongcheng Zhizao Innovation Park, Heping Community, Fuhai Street, Bao'an District, Shenzhen, Guangdong, China



LTE FDD Band 2-3MHz Channel BandwidthPAPR

QPSK

16QAM

Low Channel

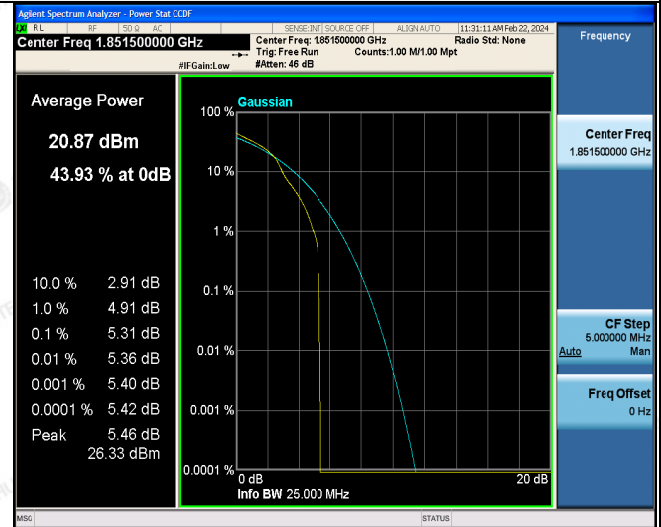
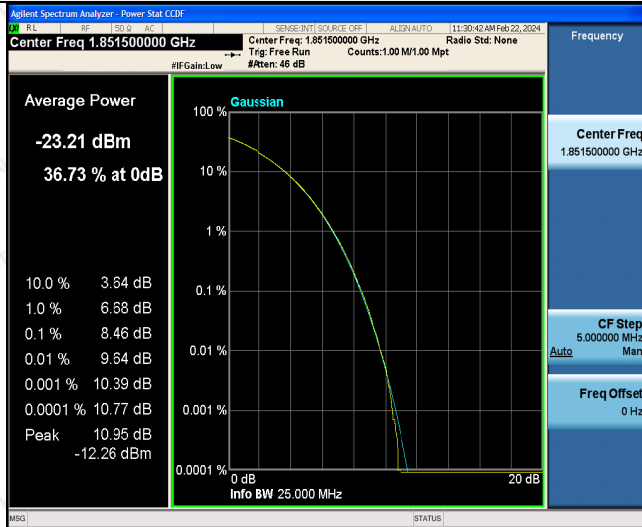

1RB#0

1RB#0

Middle Channel

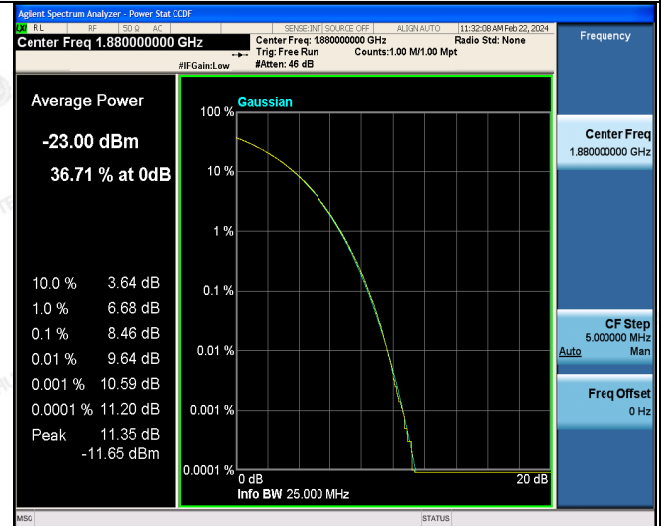
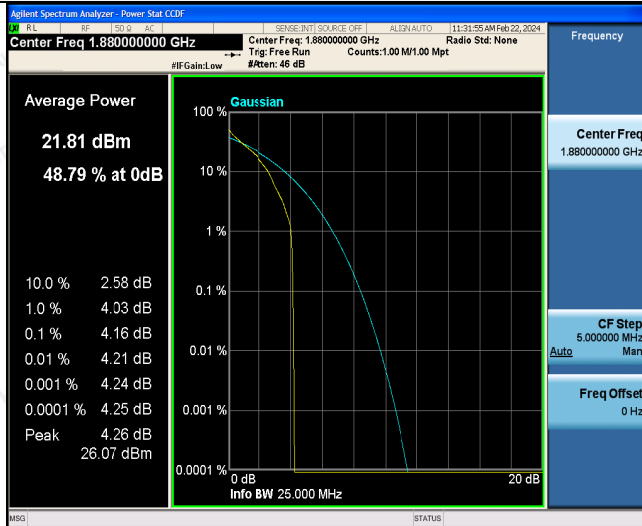

1RB#0

1RB#0

High Channel

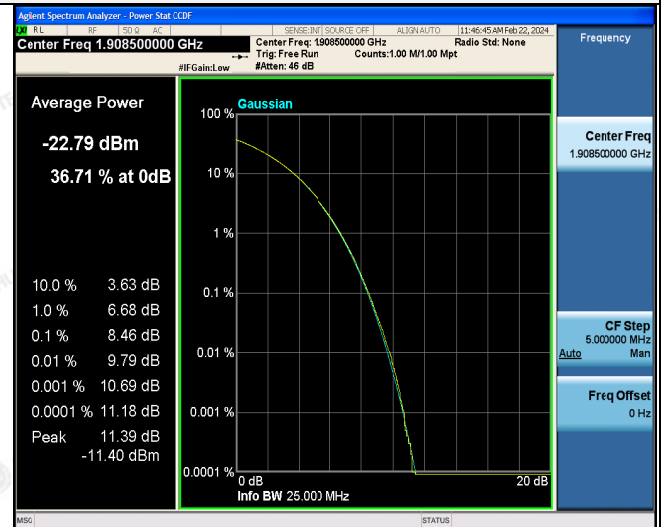
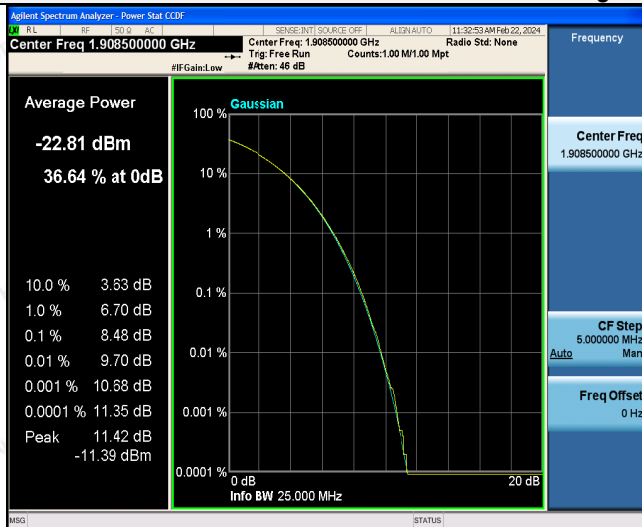

1RB#0

1RB#0

The results shown in this test report refer only to the sample(s) tested unless otherwise stated and the sample(s) are retained for 30 days only. The document is issued by HUAJ, this document cannot be reproduced except in full with our prior written permission. The more details and the authenticity of the report will be confirmed at http://www.cer-mark.com.

TEL : +86-755 2302 9901 FAX : +86-755 2302 9901 E-mail : service@cer-mark.com

Add: 1-2F., Building B2, Junfeng Zhongcheng Zhizao Innovation Park, Heping Community, Fuhai Street, Bao'an District, Shenzhen, Guangdong, China



LTE FDD Band 2-5MHz Channel BandwidthPAPR

QPSK

16QAM

Low Channel

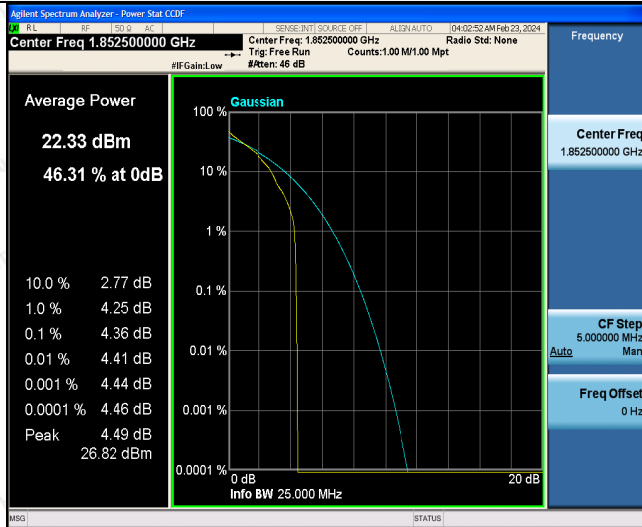

1RB#0

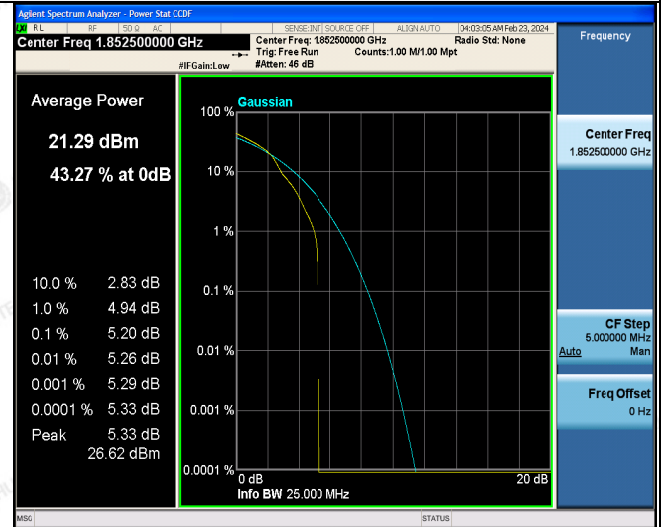

1RB#0

Middle Channel

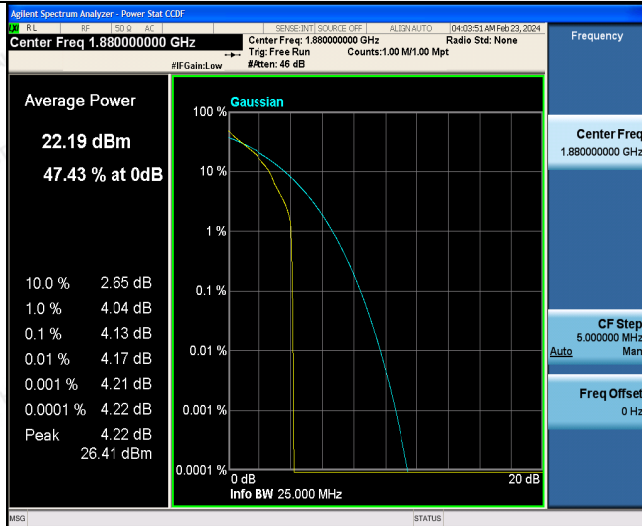

1RB#0

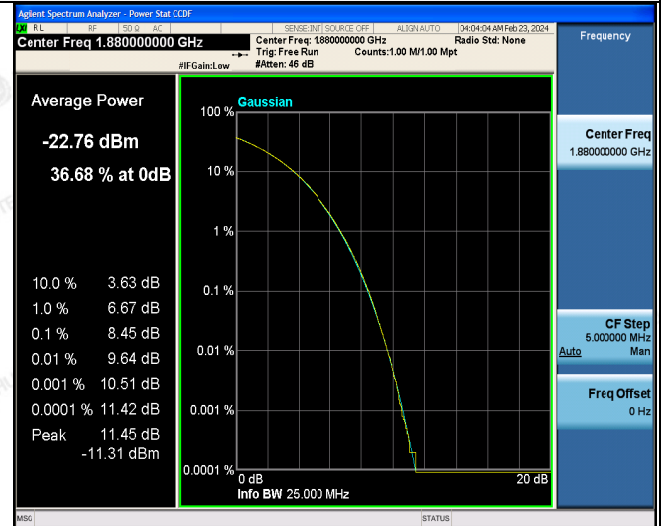

1RB#0

High Channel

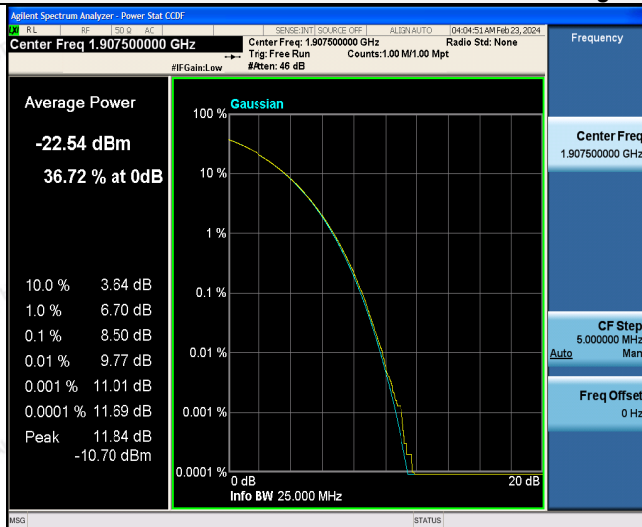

1RB#0

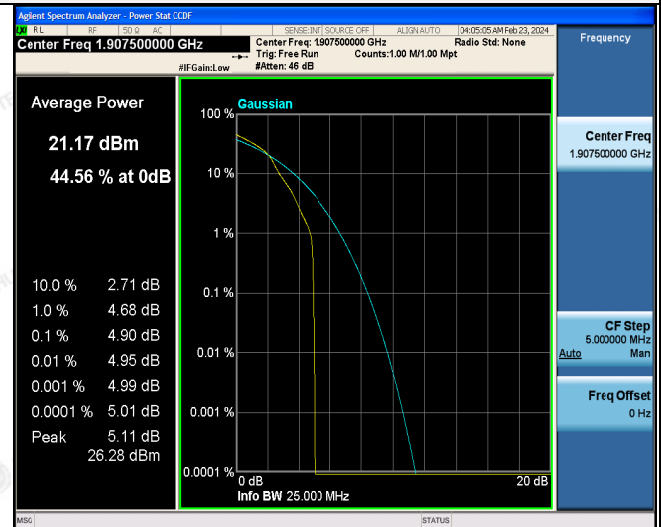

1RB#0

The results shown in this test report refer only to the sample(s) tested unless otherwise stated and the sample(s) are retained for 30 days only. The document is issued by HUAJ, this document cannot be reproduced except in full with our prior written permission. The more details and the authenticity of the report will be confirmed at http://www.cer-mark.com.

TEL : +86-755 2302 9901 FAX : +86-755 2302 9901 E-mail : service@cer-mark.com

Add: 1-2F., Building B2, Junfeng Zhongcheng Zhizao Innovation Park, Heping Community, Fuhai Street, Bao'an District, Shenzhen, Guangdong, China



LTE FDD Band 2-10MHz Channel BandwidthPAPR

QPSK

16QAM

Low Channel

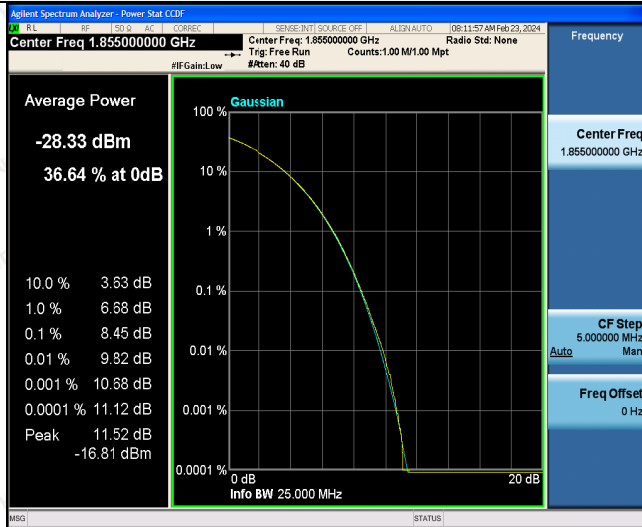

1RB#0

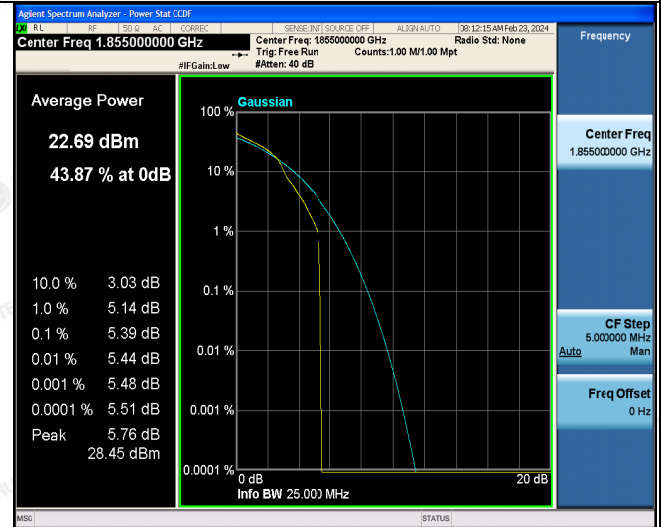

1RB#0

Middle Channel

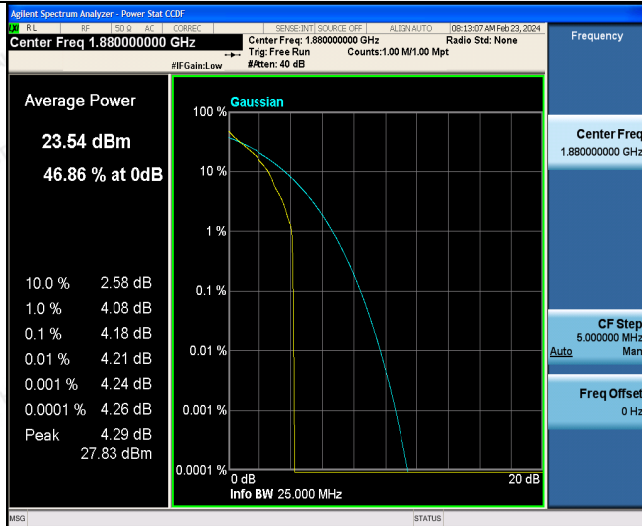

1RB#0

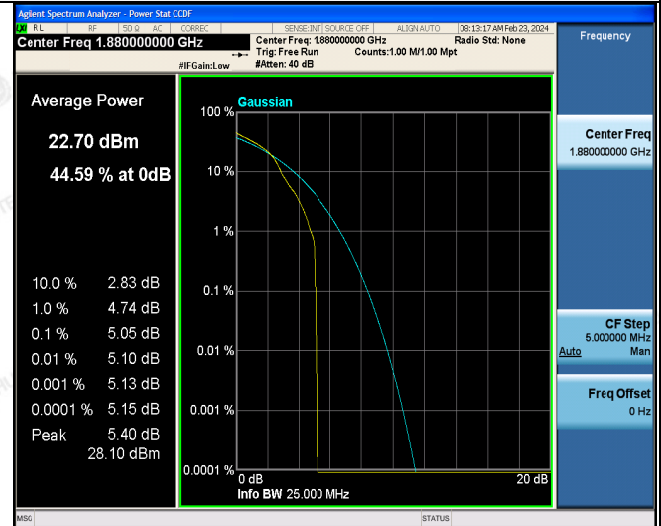

1RB#0

High Channel

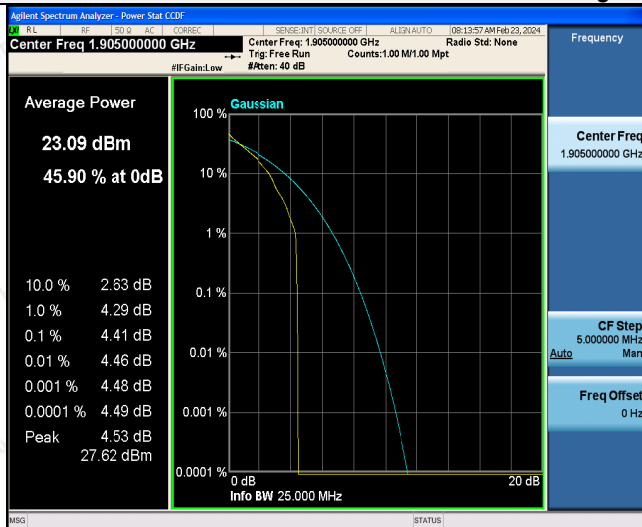

1RB#0

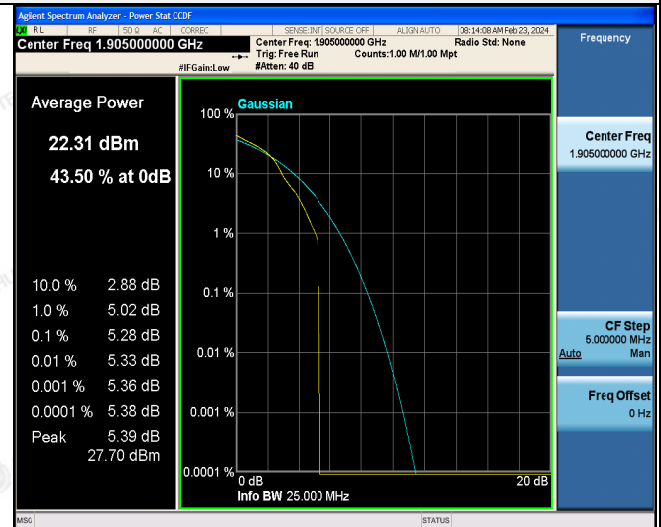

1RB#0

The results shown in this test report refer only to the sample(s) tested unless otherwise stated and the sample(s) are retained for 30 days only. This document is issued by HUAJ, this document cannot be reproduced except in full with our prior written permission. The more details and the authenticity of the report will be confirmed at http://www.cer-mark.com.

TEL : +86-755 2302 9901 FAX : +86-755 2302 9901 E-mail : service@cer-mark.com

Add: 1-2F., Building B2, Junfeng Zhongcheng Zhizao Innovation Park, Heping Community, Fuhai Street, Bao'an District, Shenzhen, Guangdong, China



LTE FDD Band 2- 15 MHz Channel Bandwidth PAPP

QPSK

16QAM

Low Channel

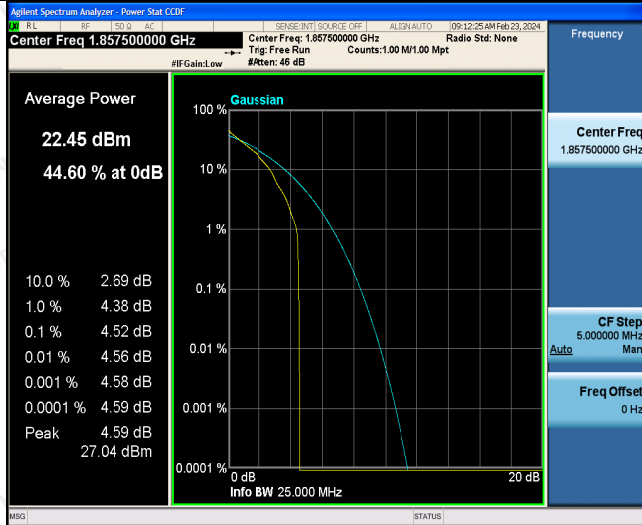

1RB#0

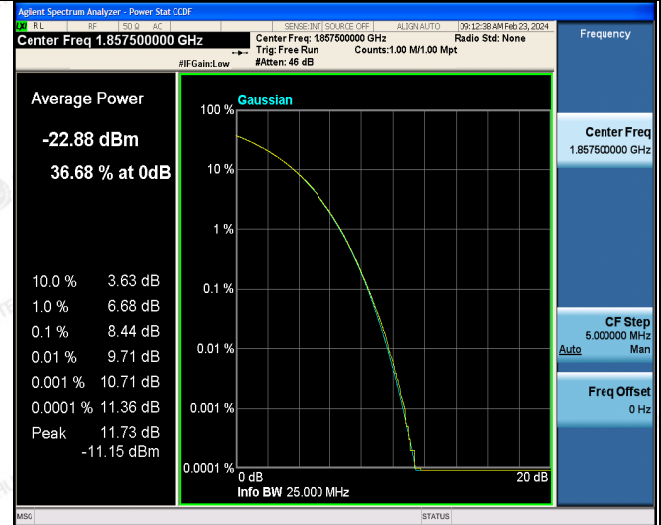

1RB#0

Middle Channel

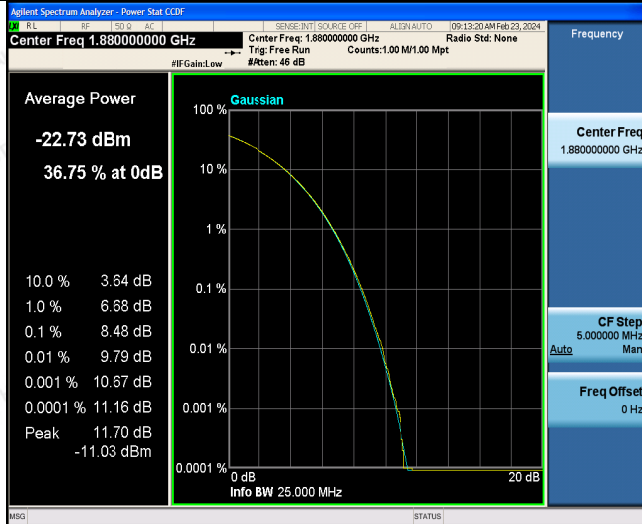

1RB#0

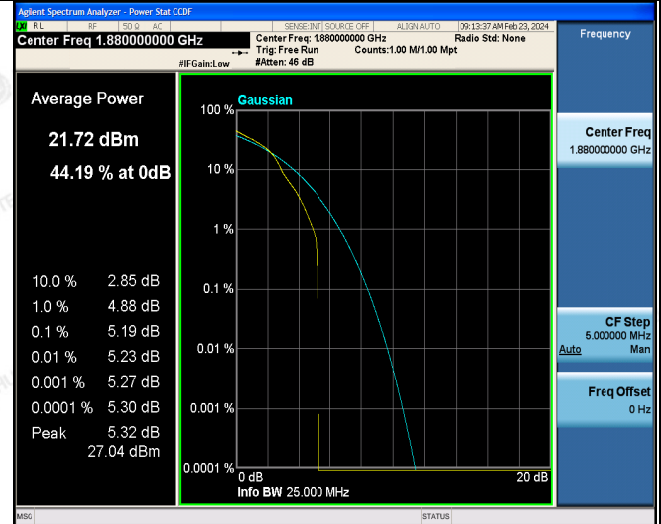

1RB#0

High Channel

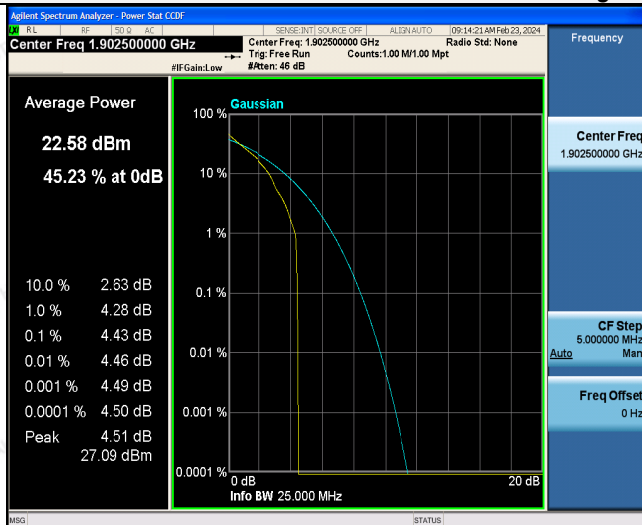

1RB#0

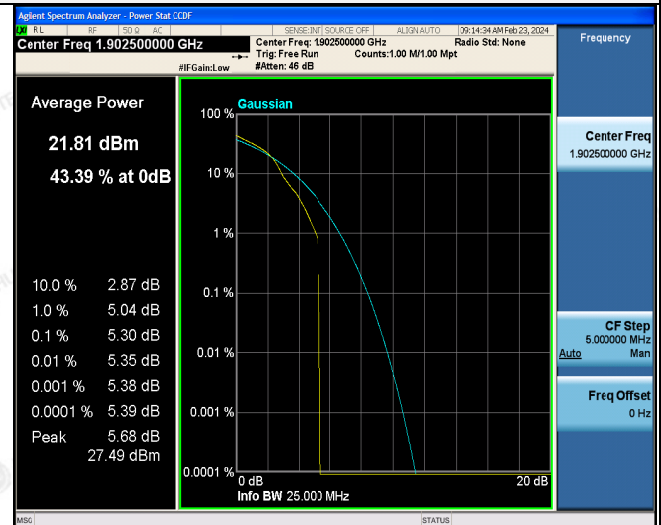

1RB#0

The results shown in this test report refer only to the sample(s) tested unless otherwise stated and the sample(s) are retained for 30 days only. The document is issued by HUAJ, this document cannot be reproduced except in full with our prior written permission. The more details and the authenticity of the report will be confirmed at http://www.cer-mark.com.

TEL : +86-755 2302 9901 FAX : +86-755 2302 9901 E-mail : service@cer-mark.com

Add: 1-2F., Building B2, Junfeng Zhongcheng Zhizao Innovation Park, Heping Community, Fuhai Street, Bao'an District, Shenzhen, Guangdong, China



LTE FDD Band 2-20MHz Channel BandwidthPAPR

QPSK

16QAM

Low Channel



1RB#0

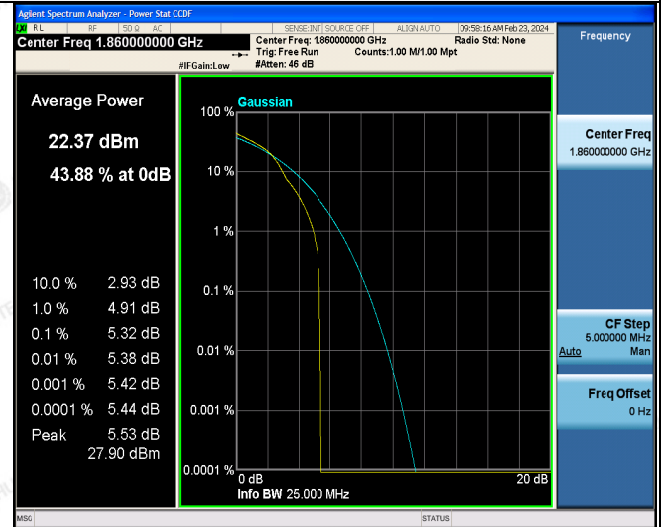

1RB#0

Middle Channel

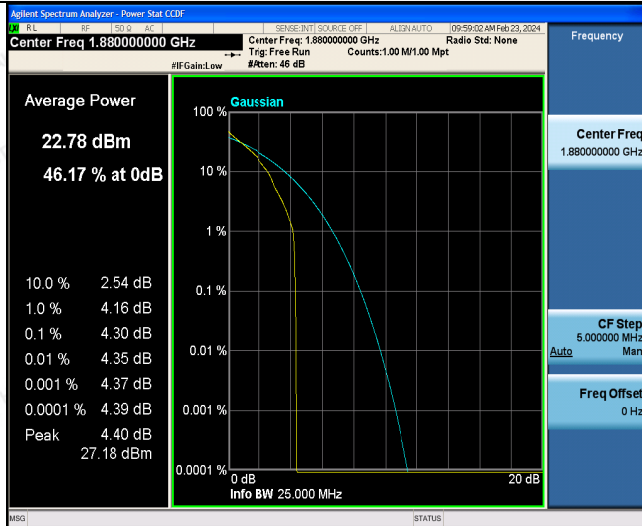

1RB#0

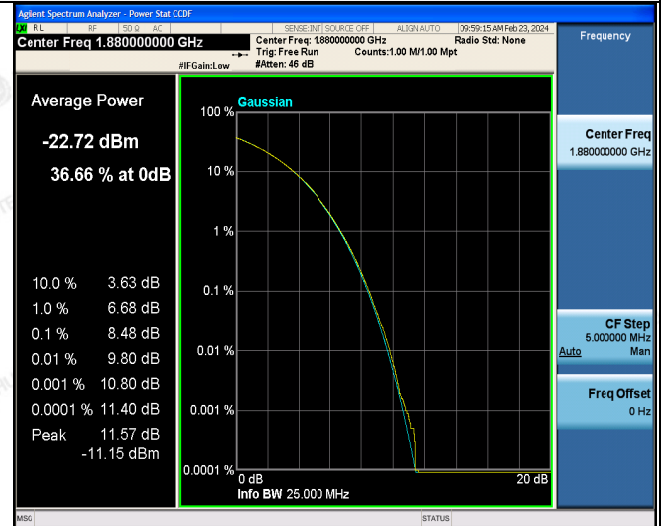

1RB#0

High Channel

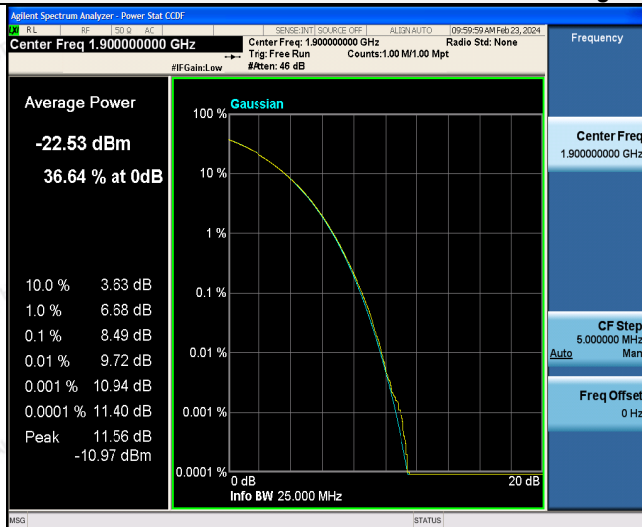

1RB#0

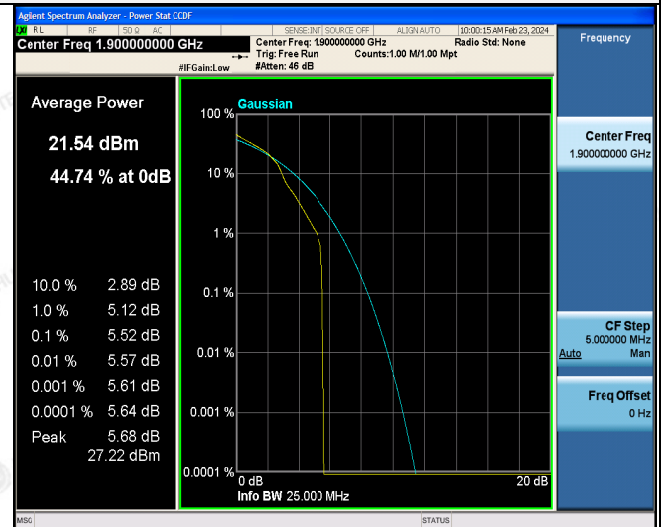

1RB#0

The results shown in this test report refer only to the sample(s) tested unless otherwise stated and the sample(s) are retained for 30 days only. The document is issued by HUAJ, this document cannot be reproduced except in full with our prior written permission. The more details and the authenticity of the report will be confirmed at http://www.cer-mark.com.

TEL : +86-755 2302 9901 FAX : +86-755 2302 9901 E-mail : service@cer-mark.com

Add: 1-2F., Building B2, Junfeng Zhongcheng Zhizao Innovation Park, Heping Community, Fuhai Street, Bao'an District, Shenzhen, Guangdong, China

**4.3 Occupied Bandwidth and Emission Bandwidth**

**LIMIT**

N/A

**TEST CONFIGURATION**

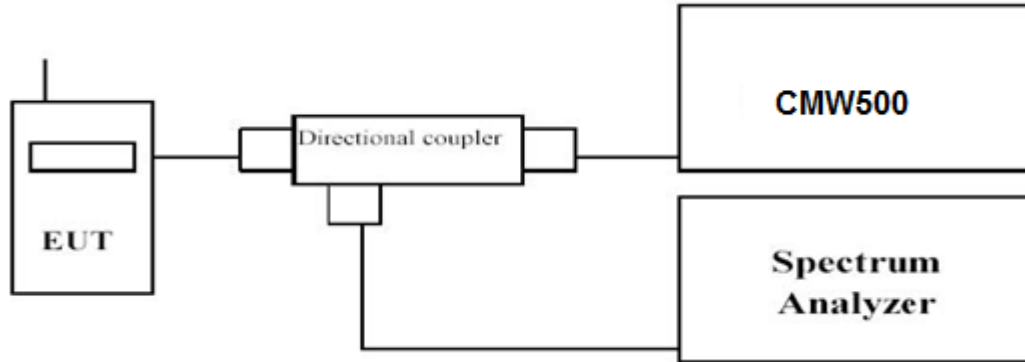

**TEST PROCEDURE**

The transmitter output was connected to a calibrated coaxial cable and coupler, the other end of which was connected to a spectrum analyzer. The occupied bandwidth was measured with the spectrum analyzer at low, middle and high channel in each band. The -26dBc Emission bandwidth was also measured and recorded. Set RBW was set to about 1% of emission BW, VBW ≥ 3 times RBW. -26dBc display line was placed on the screen (or 99% bandwidth), the occupied bandwidth is the delta frequency between the two points where the display line intersects the signal trace.

**TEST RESULTS**

Remark:

1. We were tested all RB Configuration refer 3GPP TS136 521 for each Channel Bandwidth of LTE FDD Band 2; recorded worst case for each Channel Bandwidth of LTE FDD Band 2.

LTE FDD Band 2						
TX Channel Bandwidth	RB Size/Offset	Frequency (MHz)	-26dBc Emission bandwidth (MHz)		99% Occupied bandwidth (MHz)	
			QPSK	16QAM	QPSK	16QAM
1.4 MHz	6RB#0	1850.7	1.287	1.289	1.0938	1.0979
		1880.0	1.300	1.280	1.0941	1.0893
		1909.3	1.285	1.304	1.0916	1.0972
3 MHz	15RB#0	1851.5	2.948	2.972	2.7035	2.6971
		1880.0	2.975	2.965	2.7072	2.6951
		1908.5	2.969	2.980	2.7015	2.6958
5 MHz	25RB#0	1852.5	4.975	5.033	4.5266	4.5235
		1880.0	5.010	4.995	4.5018	4.5022
		1907.5	5.030	5.016	4.5125	4.5155
10 MHz	50RB#0	1855.0	9.897	9.840	8.9915	8.9757
		1880.0	9.826	9.856	8.9588	8.9622
		1905.0	9.913	9.838	8.9660	8.9737
15 MHz	75RB#0	1857.5	14.73	14.74	13.475	13.460
		1880.0	14.83	14.68	13.446	13.442
		1902.5	14.70	14.69	13.458	13.448
20 MHz	100RB#0	1860.0	19.56	19.38	17.933	17.889
		1880.0	19.36	19.40	17.838	17.949
		1900.0	19.37	19.32	17.893	17.908

The results shown in this test report refer only to the sample(s) tested unless otherwise stated and the sample(s) are retained for 30 days only. The document is issued by HUAKE, this document cannot be reproduced except in full with our prior written permission. The more details and the authenticity of the report will be confirmed at <http://www.cer-mark.com>.





LTE FDD Band 2 – 1.4 MHz Channel Bandwidth Occupied Bandwidth and Emission Bandwidth

QPSK

16QAM

Low Channel

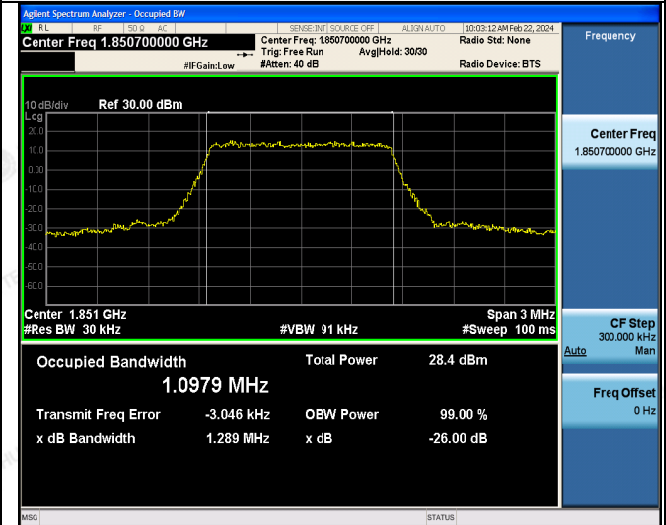
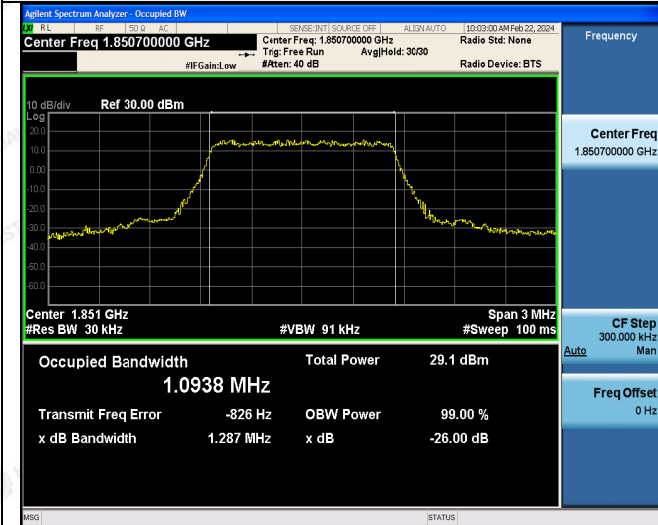

6RB#0

6RB#0

Middle Channel

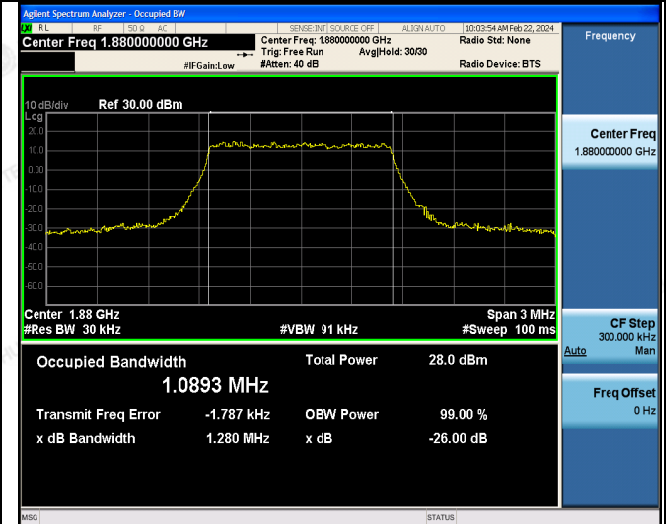
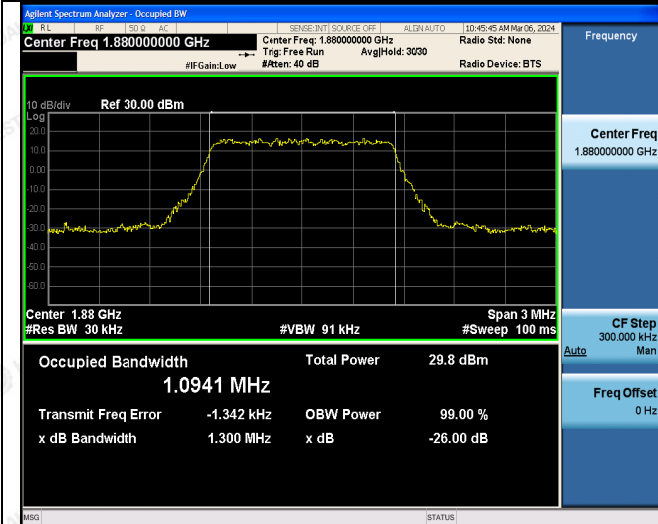

6RB#0

6RB#0

High Channel

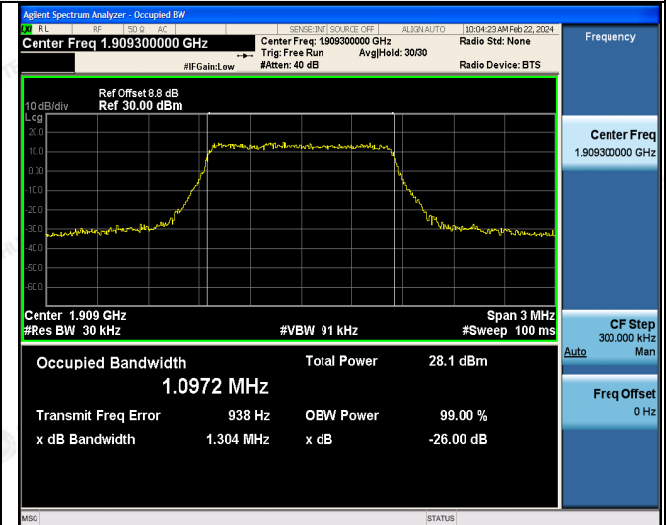
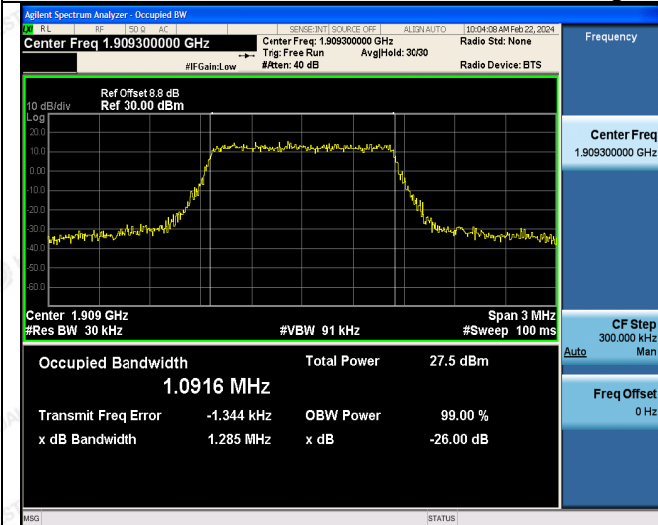

6RB#0

6RB#0

The results shown in this test report refer only to the sample(s) tested unless otherwise stated and the sample(s) are retained for 30 days only. The document is issued by HUAJ, this document cannot be reproduced except in full with our prior written permission. The more details and the authenticity of the report will be confirmed at http://www.cer-mark.com.

TEL : +86-755 2302 9901 FAX : +86-755 2302 9901 E-mail : service@cer-mark.com

Add: 1-2F., Building B2, Junfeng Zhongcheng Zhizao Innovation Park, Heping Community, Fuhai Street, Bao'an District, Shenzhen, Guangdong, China



LTE FDD Band 2-3MHz Channel Bandwidth Occupied Bandwidth and Emission Bandwidth

QPSK

16QAM

Low Channel

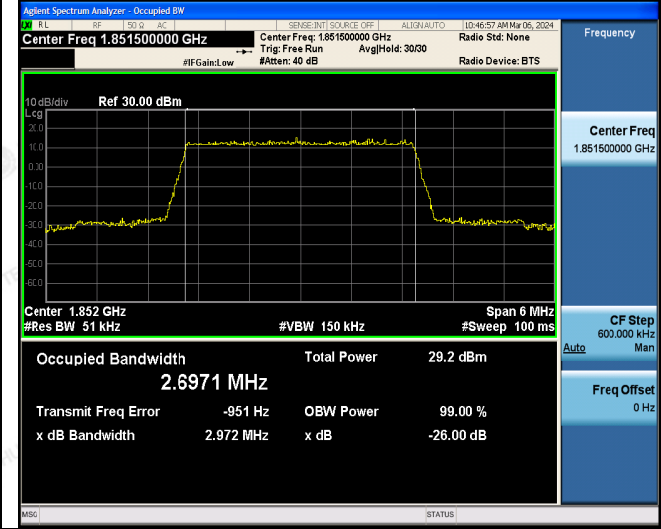
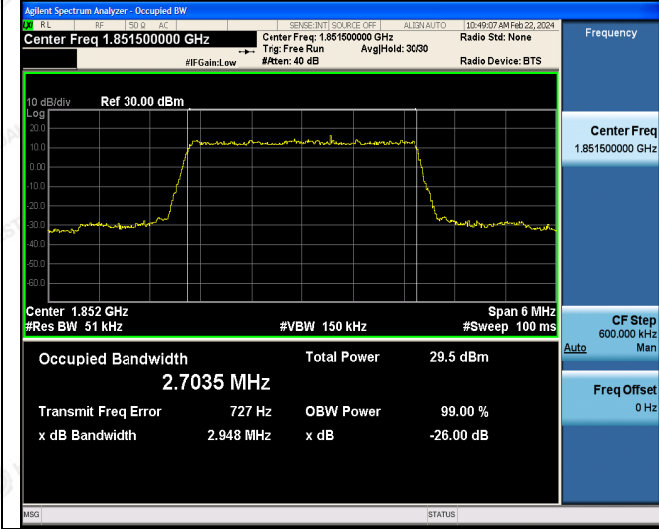

15RB#0

15RB#0

Middle Channel

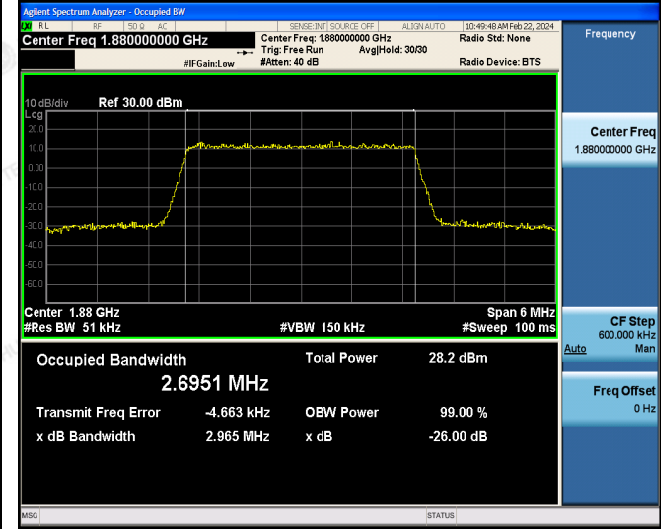
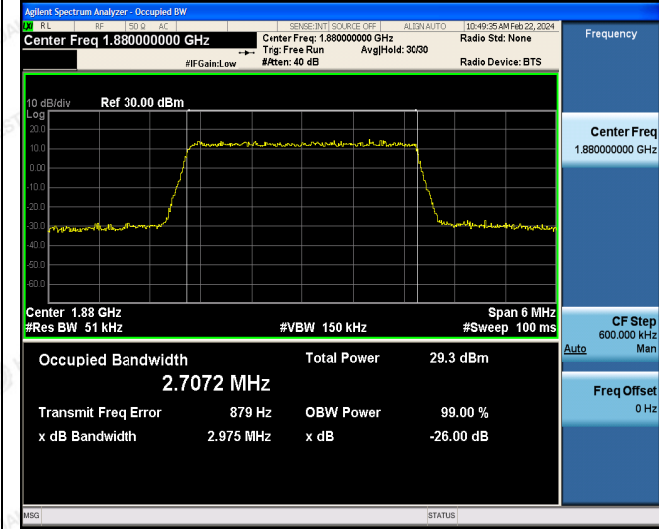

15RB#0

15RB#0

High Channel

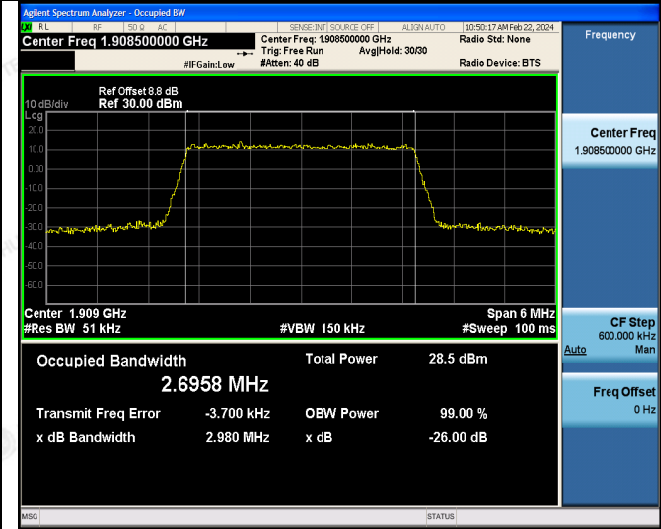
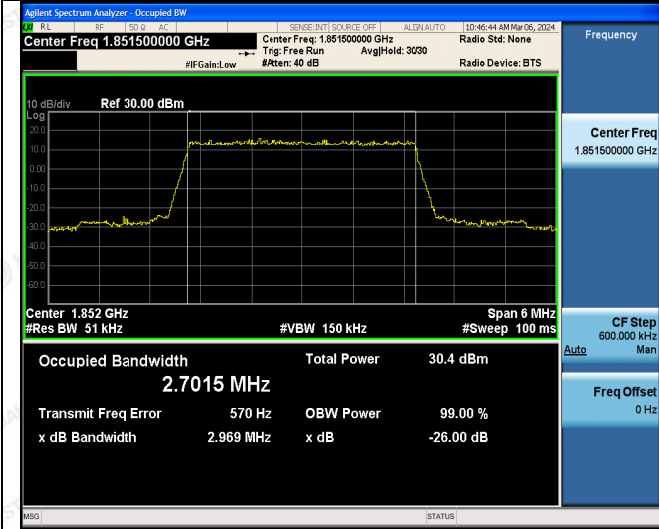

15RB#0

15RB#0

The results shown in this test report refer only to the sample(s) tested unless otherwise stated and the sample(s) are retained for 30 days only. The document is issued by HUAJ, this document cannot be reproduced except in full with our prior written permission. The more details and the authenticity of the report will be confirmed at http://www.cer-mark.com.

TEL : +86-755 2302 9901 FAX : +86-755 2302 9901 E-mail : service@cer-mark.com

Add: 1-2F., Building B2, Junfeng Zhongcheng Zhizao Innovation Park, Heping Community, Fuhai Street, Bao'an District, Shenzhen, Guangdong, China



LTE FDD Band 2-5MHz Channel Bandwidth Occupied Bandwidth and Emission Bandwidth

QPSK

16QAM

Low Channel

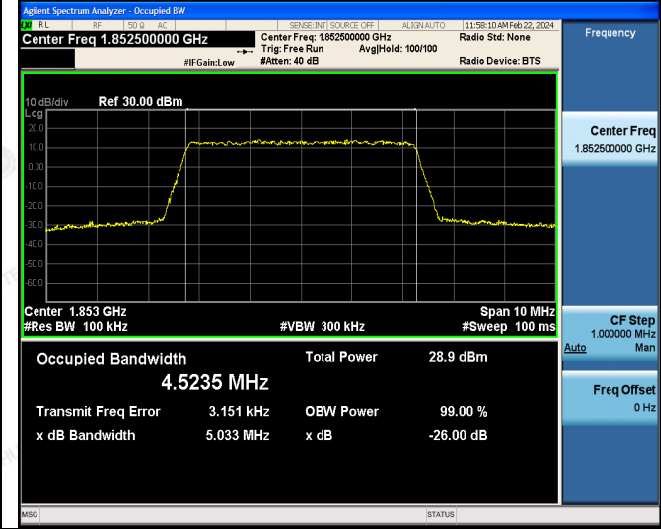
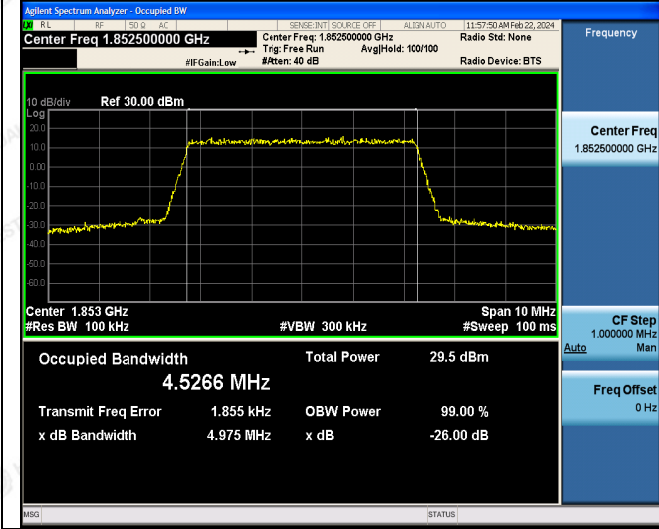

25RB#0

25RB#0

Middle Channel

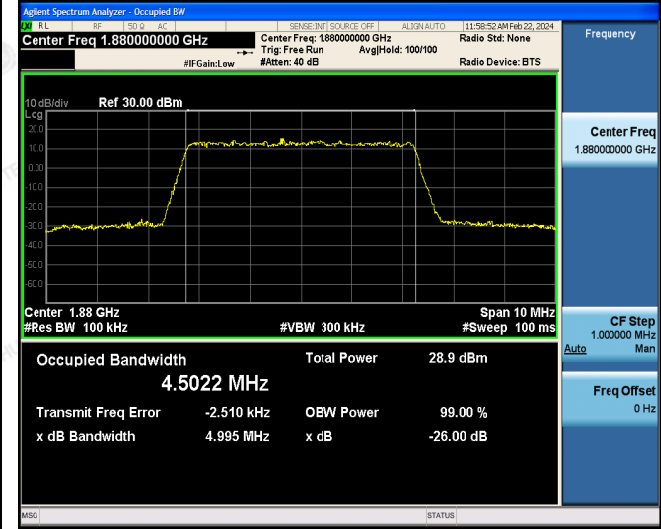
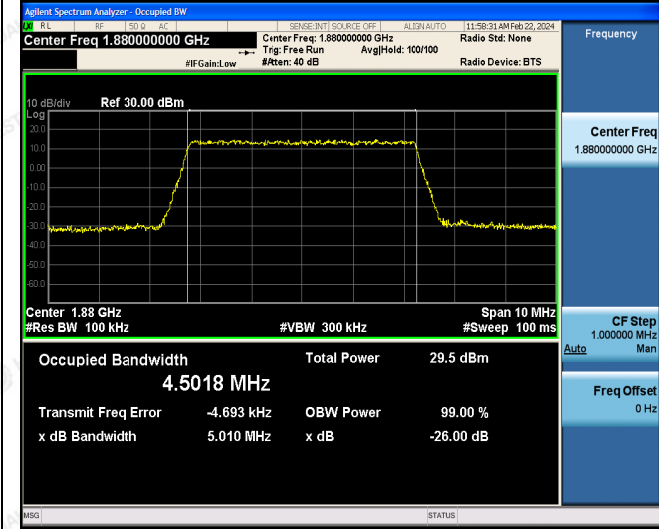

25RB#0

25RB#0

High Channel

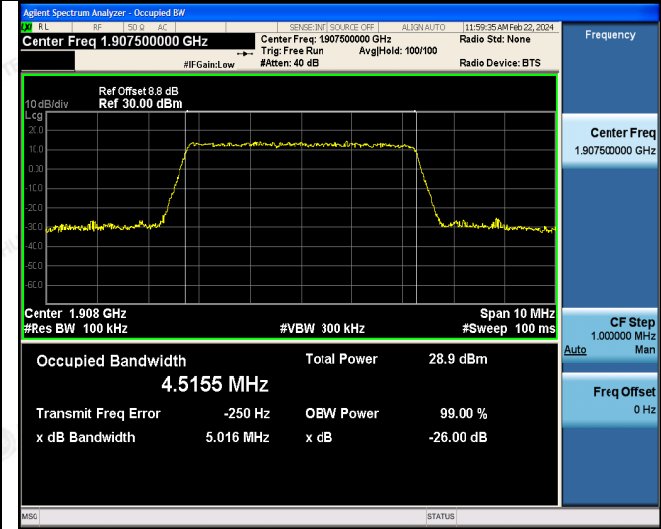
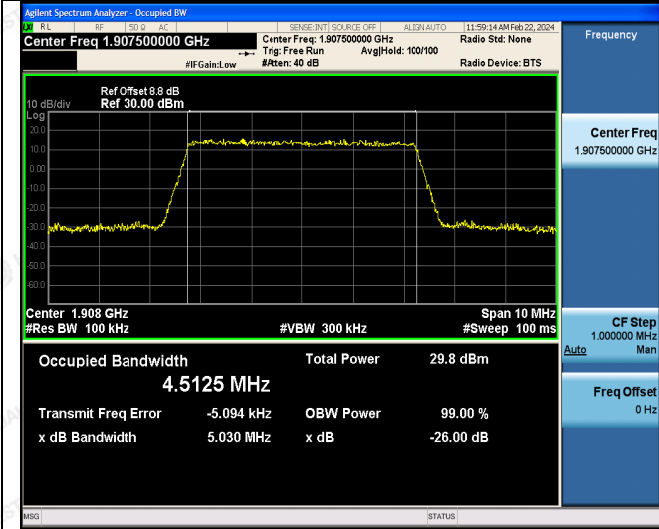

25RB#0

25RB#0

The results shown in this test report refer only to the sample(s) tested unless otherwise stated and the sample(s) are retained for 30 days only. The document is issued by HUAJ, this document cannot be reproduced except in full with our prior written permission. The more details and the authenticity of the report will be confirmed at http://www.cer-mark.com.

TEL : +86-755 2302 9901 FAX : +86-755 2302 9901 E-mail : service@cer-mark.com

Add: 1-2F., Building B2, Junfeng Zhongcheng Zhizao Innovation Park, Heping Community, Fuhai Street, Bao'an District, Shenzhen, Guangdong, China



LTE FDD Band 2-10MHz Channel Bandwidth Occupied Bandwidth and Emission Bandwidth

QPSK

16QAM

Low Channel

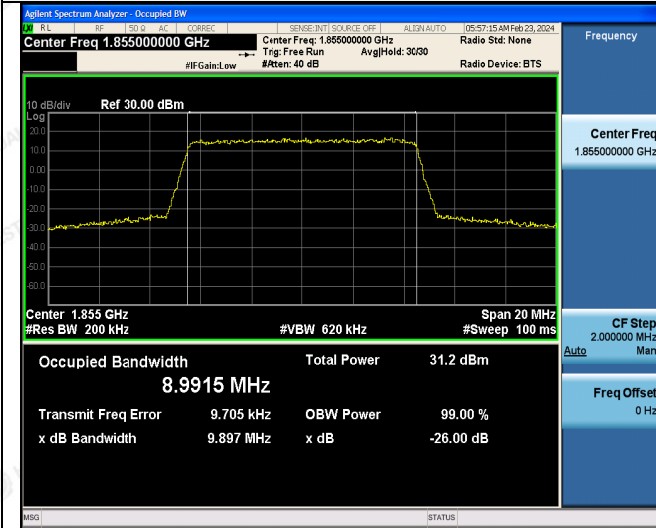

50RB#0

50RB#0

Middle Channel

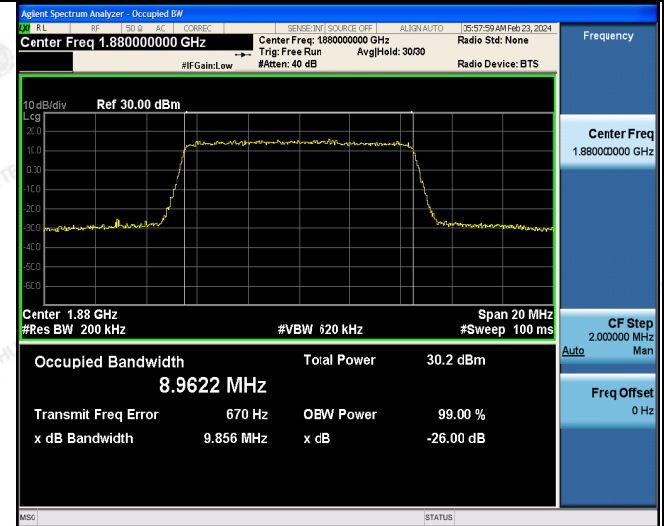
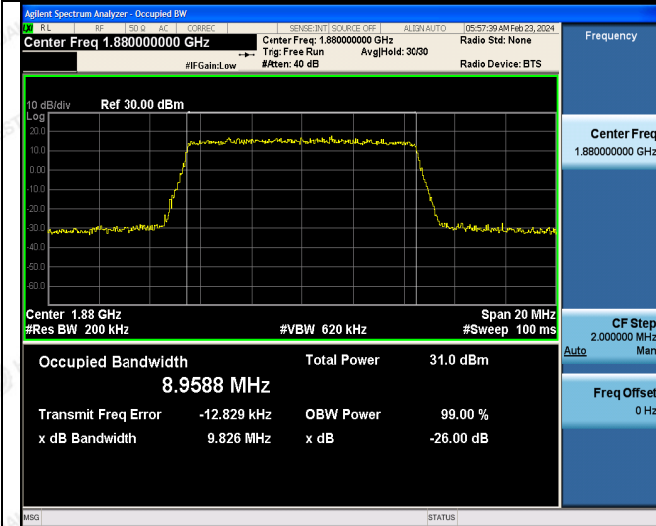

50RB#0

50RB#0

High Channel

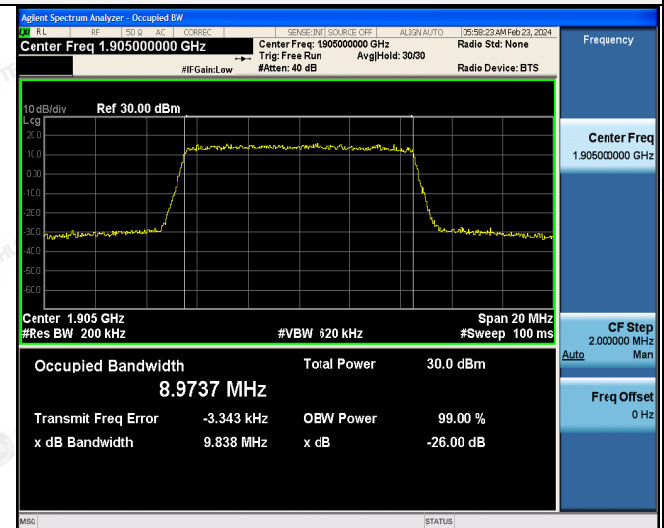
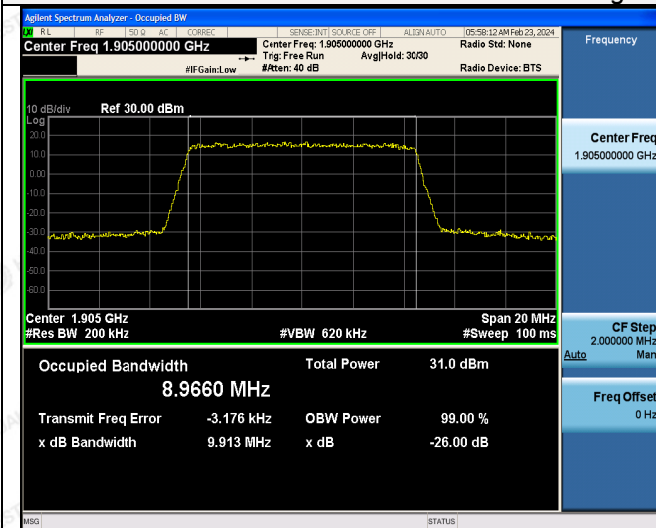

50RB#0

50RB#0

The results shown in this test report refer only to the sample(s) tested unless otherwise stated and the sample(s) are retained for 30 days only. The document is issued by HUAJ, this document cannot be reproduced except in full with our prior written permission. The more details and the authenticity of the report will be confirmed at http://www.cer-mark.com.

TEL : +86-755 2302 9901 FAX : +86-755 2302 9901 E-mail : service@cer-mark.com

Add: 1-2F., Building B2, Junfeng Zhongcheng Zhizao Innovation Park, Heping Community, Fuhai Street, Bao'an District, Shenzhen, Guangdong, China



LTE FDD Band 2-15MHz Channel Bandwidth Occupied Bandwidth and Emission Bandwidth

QPSK

16QAM

Low Channel

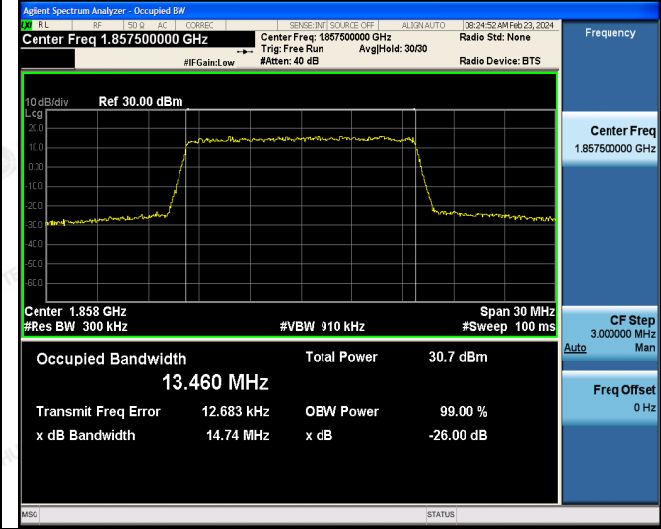
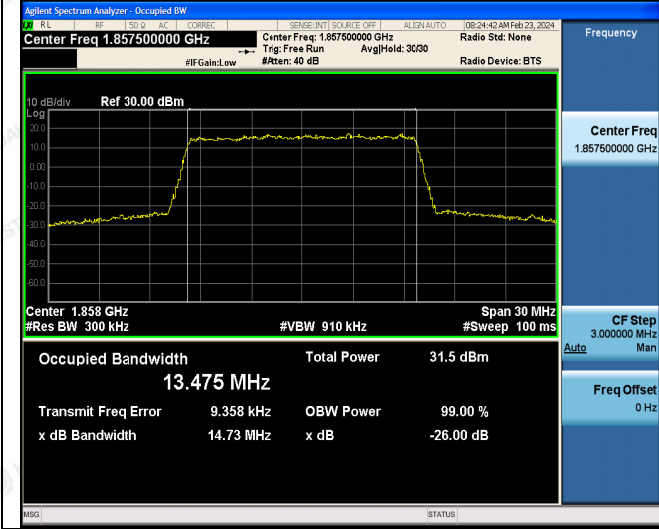

Middle Channel

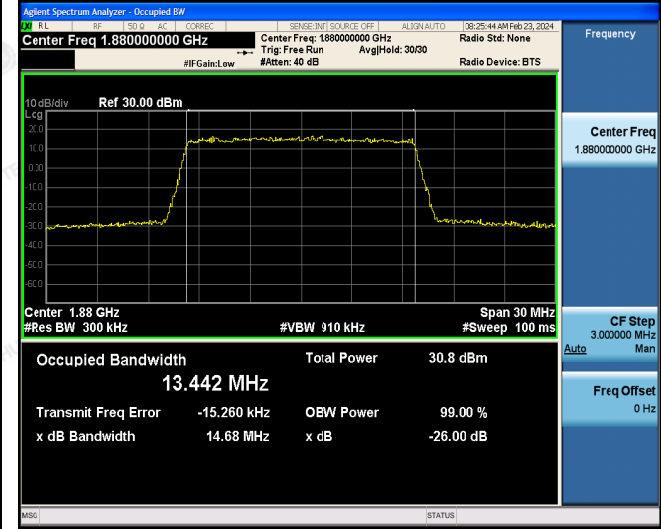
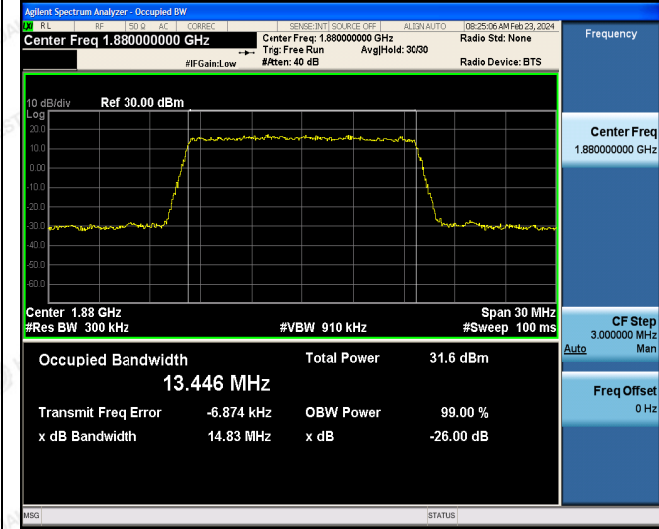

High Channel

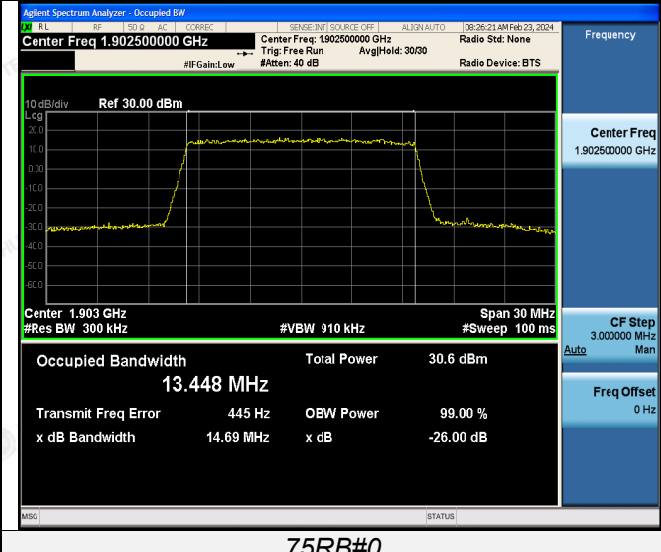
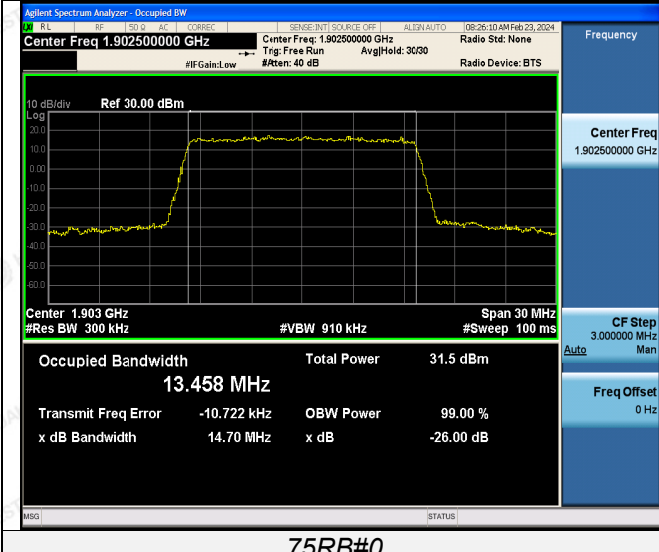

The results shown in this test report refer only to the sample(s) tested unless otherwise stated and the sample(s) are retained for 30 days only. The document is issued by HUAJ, this document cannot be reproduced except in full with our prior written permission. The more details and the authenticity of the report will be confirmed at http://www.cer-mark.com.

TEL : +86-755 2302 9901 FAX : +86-755 2302 9901 E-mail : service@cer-mark.com

Add: 1-2F., Building B2, Junfeng Zhongcheng Zhizao Innovation Park, Heping Community, Fuhai Street, Bao'an District, Shenzhen, Guangdong, China



LTE FDD Band 2-20MHz Channel Bandwidth Occupied Bandwidth and Emission Bandwidth

QPSK

16QAM

Low Channel

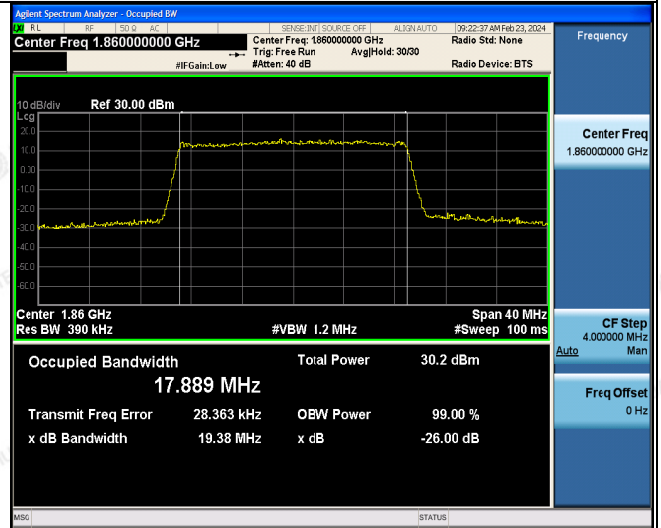
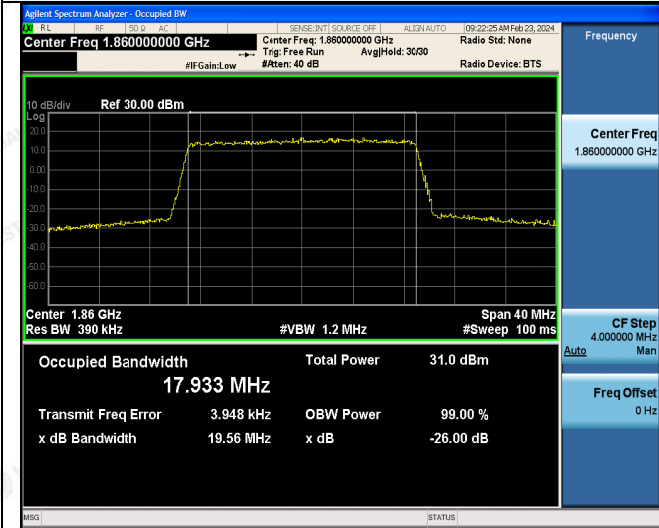

100RB#0

100RB#0

Middle Channel

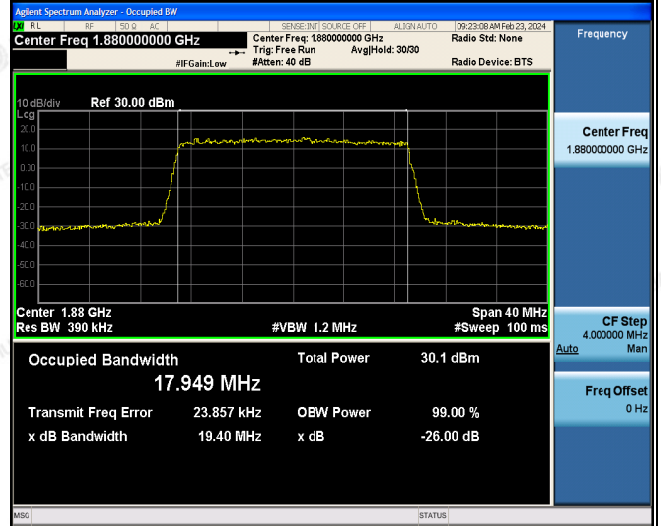
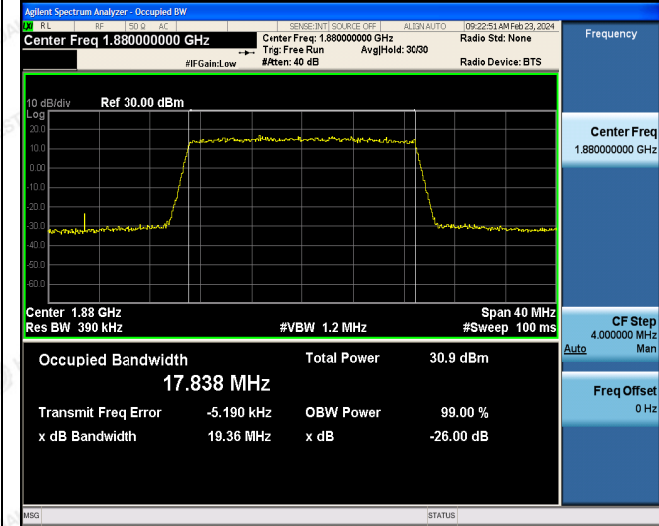

100RB#0

100RB#0

High Channel

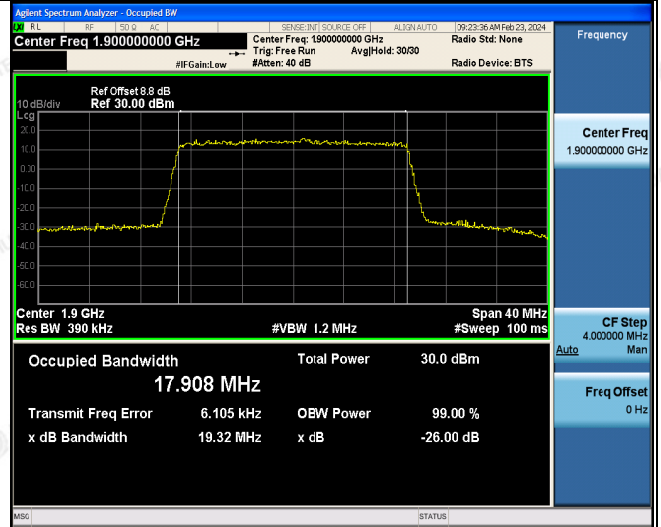
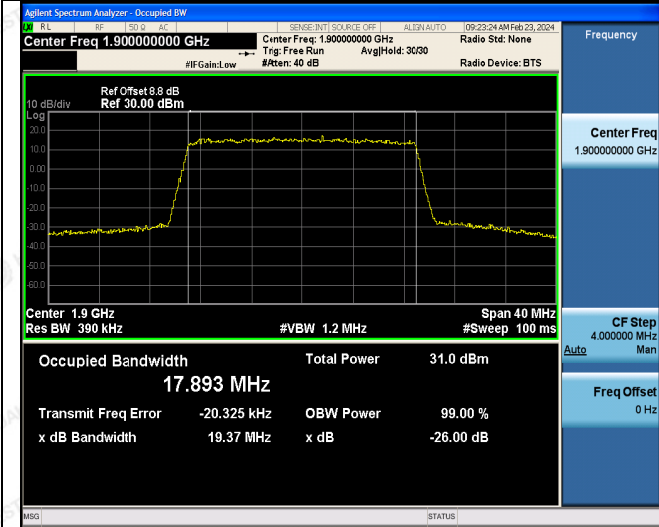

100RB#0

100RB#0

The results shown in this test report refer only to the sample(s) tested unless otherwise stated and the sample(s) are retained for 30 days only. The document is issued by HUAJ, this document cannot be reproduced except in full with our prior written permission. The more details and the authenticity of the report will be confirmed at http://www.cer-mark.com.

TEL : +86-755 2302 9901 FAX : +86-755 2302 9901 E-mail : service@cer-mark.com

Add: 1-2F., Building B2, Junfeng Zhongcheng Zhizao Innovation Park, Heping Community, Fuhai Street, Bao'an District, Shenzhen, Guangdong, China



#### 4.4 Band Edge Compliance

##### LIMIT

Per FCC §24.238 the power of any emission outside of the authorized operating frequency ranges must be attenuated below the transmitting power (P) by a factor of at least  $43 + 10\log(P)$  dB.

##### TEST CONFIGURATION

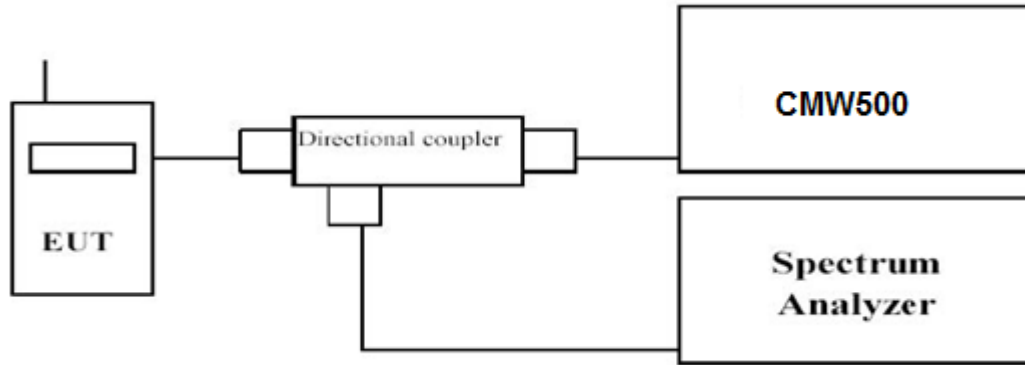

##### TEST PROCEDURE

1. The transmitter output port was connected to base station.
2. The RF output of EUT was connected to the power meter by RF cable and attenuator, the path loss was compensated to the results for each measurement.
3. Set EUT at maximum power through base station.
4. Select lowest and highest channels for each band and different modulation.
5. Measure Band edge using RMS (Average) detector by spectrum.

##### TEST RESULTS

Remark:

1. We were tested all RB Configuration refer 3GPP TS136 521 for each Channel Bandwidth of LTE FDD Band 2; recorded worst case for each Channel Bandwidth of LTE FDD Band 2.



LTE FDD Band 2 – 1.4 MHz Channel Bandwidth Band Edge Compliance

QPSK

16QAM

Low Channel

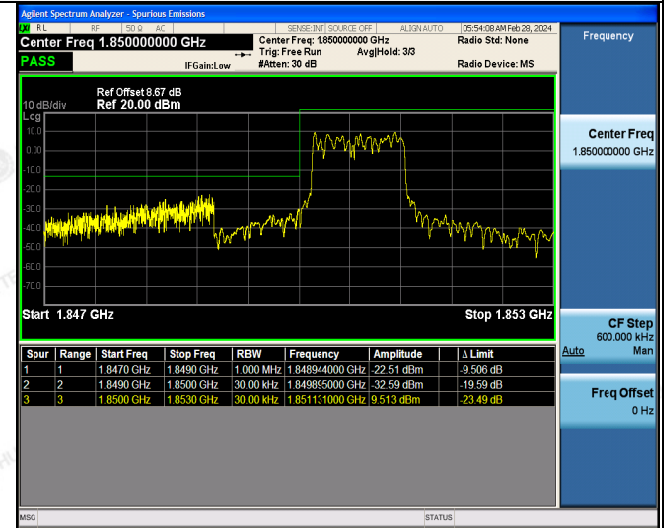
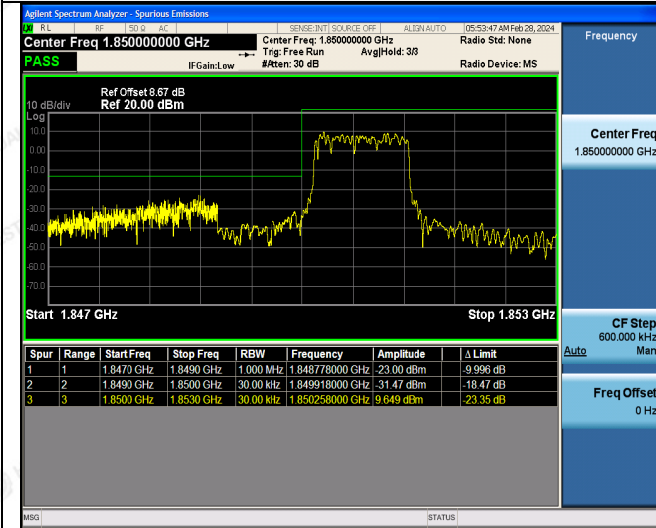

6RB#0

6RB#0

High Channel

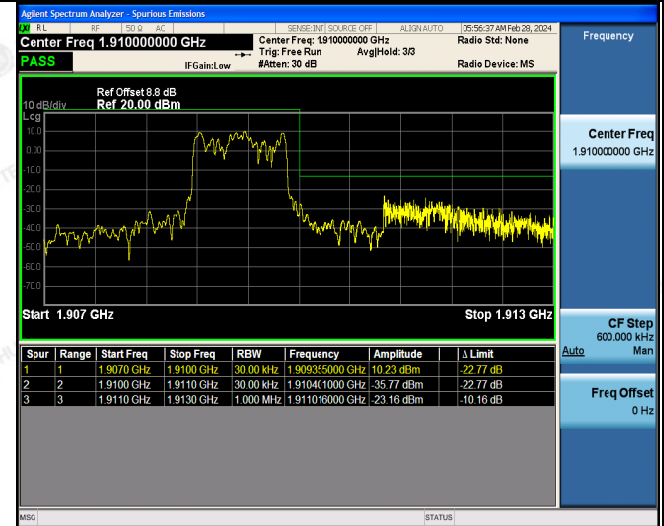
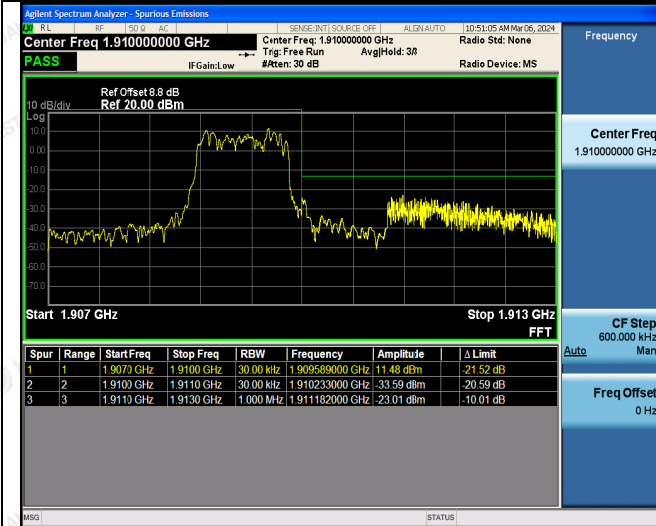

6RB#0

6RB#0

The results shown in this test report refer only to the sample(s) tested unless otherwise stated and the sample(s) are retained for 30 days only. The document is issued by HUAJ, this document cannot be reproduced except in full with our prior written permission. The more details and the authenticity of the report will be confirmed at http://www.cer-mark.com.

TEL : +86-755 2302 9901 FAX : +86-755 2302 9901 E-mail : service@cer-mark.com

Add: 1-2F., Building B2, Junfeng Zhongcheng Zhizao Innovation Park, Heping Community, Fuhai Street, Bao'an District, Shenzhen, Guangdong, China





LTE FDD Band 2-3MHz Channel Bandwidth Band Edge Compliance

QPSK

16QAM

Low Channel

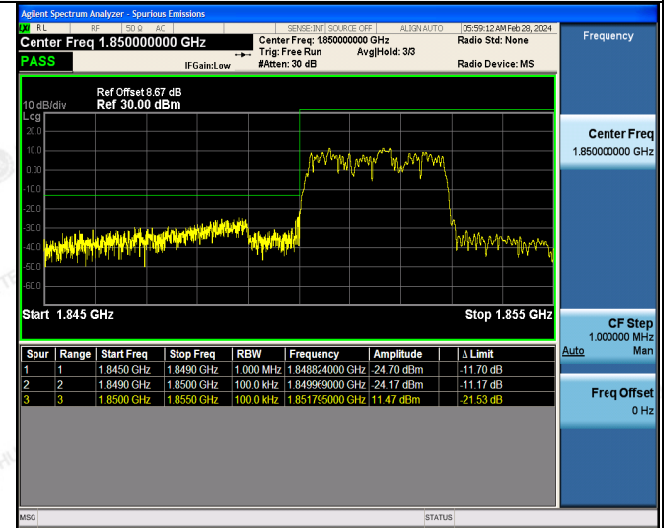
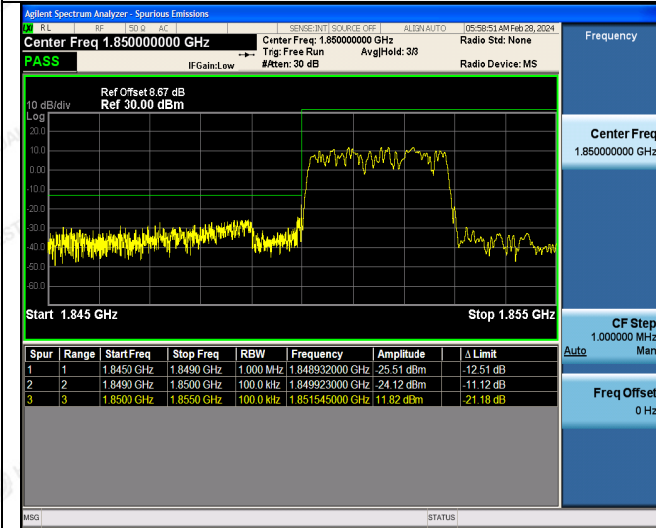

15RB#0

15RB#0

High Channel

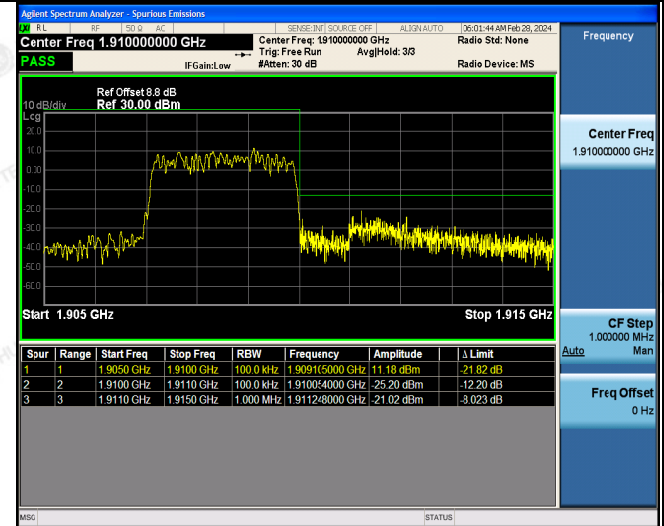
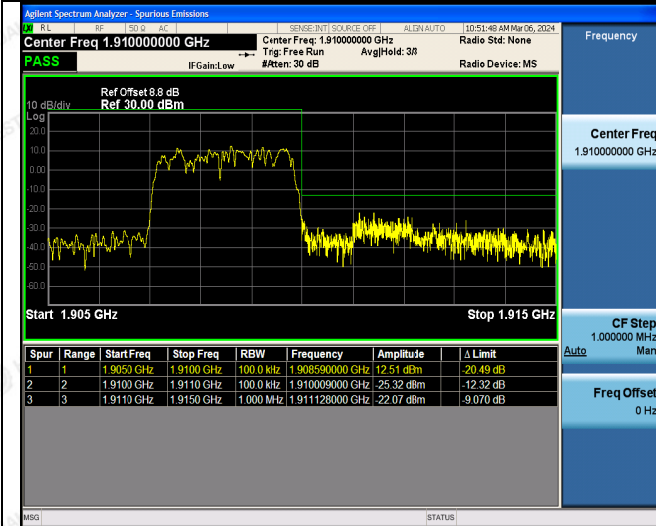

15RB#0

15RB#0

The results shown in this test report refer only to the sample(s) tested otherwise stated and the sample(s) are retained for 30 days only. The document is issued by HUAJ, this document cannot be reproduced except in full with our prior written permission. The more details and the authenticity of the report will be confirmed at http://www.cer-mark.com.

TEL : +86-755 2302 9901 FAX : +86-755 2302 9901 E-mail : service@cer-mark.com

Add: 1-2F., Building B2, Junfeng Zhongcheng Zhizao Innovation Park, Heping Community, Fuhai Street, Bao'an District, Shenzhen, Guangdong, China



LTE FDD Band 2-5MHz Channel Bandwidth Band Edge Compliance

QPSK

16QAM

Low Channel

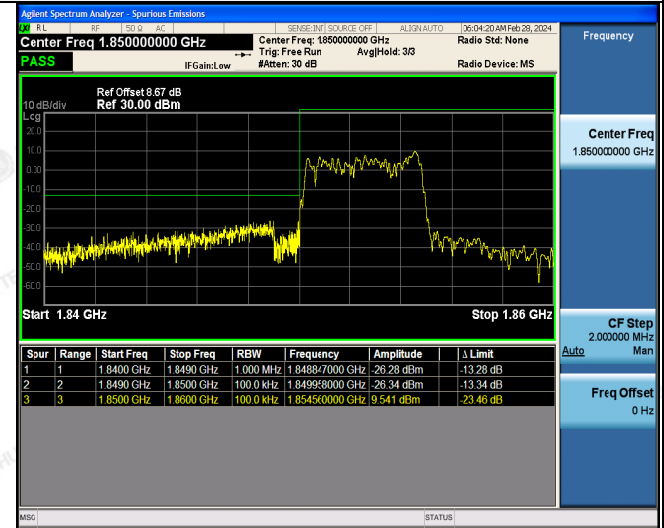
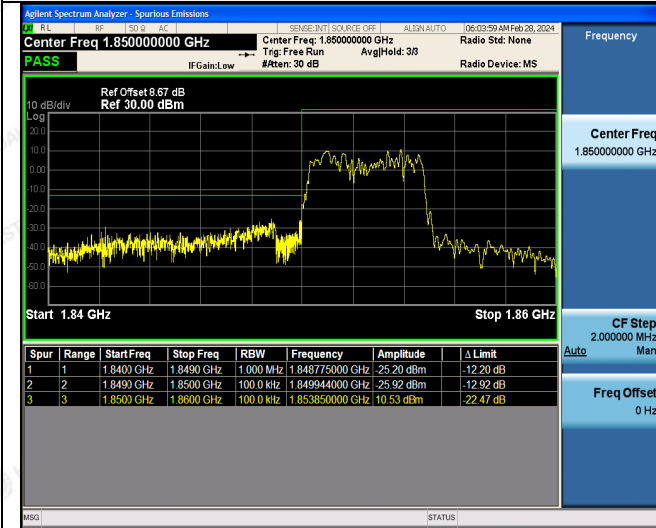

25RB#0

25RB#0

High Channel

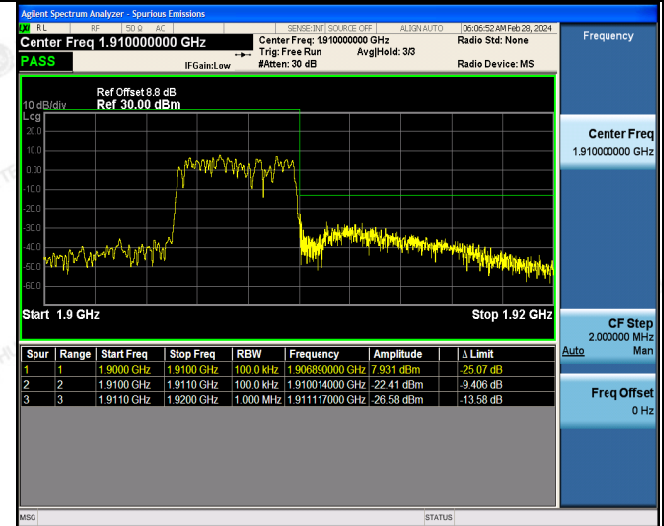
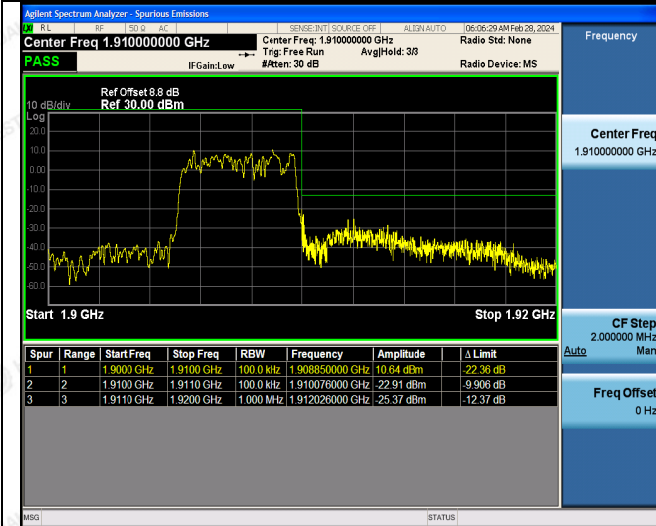

25RB#0

25RB#0

The results shown in this test report refer only to the sample(s) tested unless otherwise stated and the sample(s) are retained for 30 days only. The document is issued by HUAJ, this document cannot be reproduced except in full with our prior written permission. The more details and the authenticity of the report will be confirmed at http://www.cer-mark.com.

TEL : +86-755 2302 9901 FAX : +86-755 2302 9901 E-mail : service@cer-mark.com

Add: 1-2F., Building B2, Junfeng Zhongcheng Zhizao Innovation Park, Heping Community, Fuhai Street, Bao'an District, Shenzhen, Guangdong, China