



**TEST REPORT**  
**FCC CFR Title 47 Part 2, Part 90R**

**Report Reference No.**.....: HK2402210730-10E

**FCC ID**.....: 2AM6L-M1N2

Compiled by  
( position+printed name+signature)..: File administrators Len Liao

Supervised by  
( position+printed name+signature)..: Technique principal Sliver Wan

Approved by  
( position+printed name+signature)..: Manager Jason Zhou

Date of issue.....: Mar. 07, 2024

**Testing Laboratory Name** .....: **Shenzhen HUAKE Testing Technology Co., Ltd.**

Address .....: 1-2/F., Building B2, Junfeng Zhongcheng Zhizao Innovation Park,  
Heping, Fuhai Street, Bao'an District, Shenzhen, Guangdong,  
China

**Applicant's name**.....: **Streamax Technology Co., Ltd.**

Address .....: 21-23/F, Building B1, Zhiyuan, No. 1001, Xueyuan Avenue,  
Nanshan District, Shenzhen, Guangdong 518055, China

**Test specification** .....

Standard.....: **FCC CFR Title 47 Part 2, Part 90R**

TRF Originator.....: Shenzhen HUAKE Testing Technology Co., Ltd.

**Shenzhen HUAKE Testing Technology Co., Ltd. All rights reserved.**

This publication may be reproduced in whole or in part for non-commercial purposes as long as the Shenzhen HUAKE Testing Technology Co., Ltd. as copyright owner and source of the material. Shenzhen HUAKE Testing Technology Co., Ltd. takes no responsibility for and will not assume liability for damages resulting from the reader's interpretation of the reproduced material due to its placement and context.

**Test item description** .....

Trade Mark .....: N/A

**Manufacturer**.....: **Streamax Technology Co., Ltd.**

Model/Type reference.....: M1N 2.0

Listed Models .....: N/A

Modulation Type.....: QPSK, 16QAM

Rating .....: DC 12V from DC Power

Hardware version .....: V1.0

Software version .....: V1.0

Result.....: **PASS**



TEST REPORT

<b>Test Report No. :</b>	<b>HK2402210730-10E</b>	Mar. 07, 2024
		Date of issue

Equipment under Test : MDVR

Model /Type : M1N 2.0

Listed Models : N/A

**Applicant** : **Streamax Technology Co., Ltd.**

Address : 21-23/F, Building B1, Zhiyuan, No. 1001, Xueyuan Avenue, Nanshan District, Shenzhen, Guangdong 518055, China

**Manufacturer** : **Streamax Technology Co., Ltd.**

Address : 21-23/F, Building B1, Zhiyuan, No. 1001, Xueyuan Avenue, Nanshan District, Shenzhen, Guangdong 518055, China

<b>Test result</b>	<b>Pass</b>
--------------------	-------------

The test report merely corresponds to the test sample.  
 It is not permitted to copy extracts of these test result without the written permission of the test laboratory.



## Contents

<b>1</b>	<b>SUMMARY</b>	<b>4</b>
1.1	TEST STANDARDS	4
1.2	Test Description	4
1.3	Information of the Test Laboratory	5
1.4	Statement of the measurement uncertainty	5
<b>2</b>	<b>GENERAL INFORMATION</b>	<b>6</b>
2.1	General Remarks	6
2.2	Product Description	6
2.3	Equipment under Test	6
2.4	Test frequency list	6
2.5	Environmental conditions	7
2.6	Description of Test Modes	7
2.7	Equipments Used during the Test	8
2.8	Modifications	8
<b>3</b>	<b>TEST CONDITIONS AND RESULTS</b>	<b>9</b>
3.1	Output Power	9
3.2	Peak-to-Average Ratio (PAR)	13
3.3	Occupied Bandwidth and Emission Bandwidth	16
3.4	Band Edge compliance	19
3.5	Spurious Emission	22
3.6	Frequency Stability under Temperature & Voltage Variations	30
<b>4</b>	<b>TEST SETUP PHOTOS OF THE EUT</b>	<b>32</b>
<b>5</b>	<b>PHOTOS OF THE EUT</b>	<b>33</b>



**1.1 TEST STANDARDS**

The tests were performed according to following standards:

[FCC Part 90](#) : PRIVATE LAND MOBILE RADIO SERVICES (Subpart R—Regulations Governing the Licensing and Use of Frequencies in the 763-775 and 793-805 MHz Bands)

47 CFR FCC Part 15 Subpart B: - Unintentional Radiators

[FCC Part 2](#): FREQUENCY ALLOCATIONS AND RADIO TREATY MATTERS; GENERAL RULES AND REGULATIONS

**1.2 Test Description**

Test Item	Section in CFR 47	Result
RF Output Power	Part 2.1046 90.542	Pass
Peak-to-Average Ratio	KDB 971168 D01(5.7)	Pass
99% & -26 dB Occupied Bandwidth	Part 2.1049	Pass
Spurious Emissions at Antenna Terminal	Part 90.543(e)	Pass
Out of band emission, Band Edge	Part 2.1051 Part 90.543	Pass
Frequency stability	part2.1055	Pass



### 1.3 Information of the Test Laboratory

Shenzhen HUAK Testing Technology Co., Ltd.  
Add.: 1-2/F., Building B2, Junfeng Zhongcheng Zhizao Innovation Park, Heping,  
Fuhai Street, Bao'an District, Shenzhen, Guangdong, China

Testing Laboratory Authorization:

A2LA Accreditation Code is 4781.01.  
FCC Designation Number is CN1229.  
Canada IC CAB identifier is CN0045.  
CNAS Registration Number is L9589.

### 1.4 Statement of the measurement uncertainty

The data and results referenced in this document are true and accurate. The reader is cautioned that there may be errors within the calibration limits of the equipment and facilities. The measurement uncertainty was calculated for all measurements listed in this test report acc. to CISPR 16 - 4 „Specification for radio disturbance and immunity measuring apparatus and methods – Part 4: Uncertainty in EMC Measurements“ and is documented in the Shenzhen HUAK Testing Technology Co., Ltd.quality system acc. to DIN EN ISO/IEC 17025. Furthermore, component and process variability of devices similar to that tested may result in additional deviation. The manufacturer has the sole responsibility of continued compliance of the device.

Hereafter the best measurement capability for Shenzhen HUAK Testing Technology Co., Ltd.is reported:

Test	Range	Measurement Uncertainty	Notes
Radiated Emission	30~1000MHz	4.10dB	(1)
Radiated Emission	Above 1GHz	4.32dB	(1)
Conducted Disturbance	0.15~30MHz	3.20dB	(1)

(1) This uncertainty represents an expanded uncertainty expressed at approximately the 95% confidence level using a coverage factor of k=2.



## 2 GENERAL INFORMATION

### 2.1 General Remarks

Date of receipt of test sample	:	Feb. 21, 2024
Testing commenced on	:	Feb. 21, 2024
Testing concluded on	:	Mar. 07, 2024

### 2.2 Product Description

Name of EUT	MDVR
Model/Type reference:	M1N 2.0
List Model:	N/A
Model Difference:	N/A
Power supply:	DC 12V From Power Box
Adapter Information	N/A
Modulation Type	QPSK,16QAM
Antenna Type	External Antenna
Operation Frequency Band	LTE Band 14
Operation frequency	LTE Band 14: 788~798 MHz
LTE Release	R8
Extreme temp. Tolerance	-30°C to +50°C
Extreme vol. Limits	N/A

### 2.3 Equipment under Test

#### Power supply system utilised

Power supply voltage	:	<input type="radio"/> 120V/ 60 Hz	<input type="radio"/> 115V/60Hz
		<input checked="" type="radio"/> 12 V DC	<input type="radio"/> 24 V DC
		<input type="radio"/> Other (specified in blank below)	

### 2.4 Test frequency list

TX Channel Bandwidth	Frequency (MHz)	channel
5 MHz	790.5	23305
	793	23330
	795.5	23355
10 MHz	/	/
	793	23330
	/	/



### 2.5 Environmental conditions

During the measurement the environmental conditions were within the listed ranges:

Normal Temperature:	25°C
Relative Humidity:	55 %
Air Pressure:	101 kPa

### 2.6 Description of Test Modes

The EUT has been tested under typical operating condition. The CMW500 used to control the EUT staying in continuous transmitting and receiving mode for testing. Regards to the frequency band operation: the lowest, middle and highest frequency of channel were selected to perform the test, then shown on this report.

Note:

1. For the ERP/EIRP and radiated emission test, every axis (X, Y, Z) was verified, and show the worst result on this report.
2. Test method and refer to 3GPP TS136521.



2.7 Equipments Used during the Test

Test Equipment	Manufacturer	Model No.	Serial No.	Calibration Date	Calibration Due Date
LISN	ENV216	R&S	HKE-059	2024/02/20	2025/02/19
LISN	R&S	ENV216	HKE-002	2024/02/20	2025/02/19
Broadband antenna	Schwarzbeck	VULB 9163	HKE-012	2024/02/21	2026/02/20
Receiver	R&S	ESR-7	HKE-010	2024/02/20	2025/02/19
Spectrum analyzer	Agilent	N9020A	HKE-048	2024/02/20	2025/02/19
RF automatic control unit	Tonscend	JS0806-2	HKE-060	2024/02/20	2025/02/19
Horn antenna	Schwarzbeck	9120D	HKE-013	2024/02/21	2026/02/20
Loop antenna	Schwarzbeck	FMZB 1519 B	HKE-014	2024/02/21	2026/02/20
Preamplifier	EMCI	EMC051845SE	HKE-015	2024/02/20	2025/02/19
Preamplifier	Agilent	83051A	HKE-016	2024/02/20	2025/02/19
Temperature and humidity meter	Boyang	HTC-1	HKE-075	2024/02/20	2025/02/19
High pass filter unit	Tonscend	JS0806-F	HKE-055	2024/02/20	2025/02/19
RF cable	Times	1-40G	HKE-034	2024/02/20	2025/02/19
Power meter	Agilent	E4419B	HKE-085	2024/02/20	2025/02/19
Power Sensor	Agilent	E9300A	HKE-086	2024/02/20	2025/02/19
Wireless Communication Test Set	R&S	CMW500	HKE-026	2024/02/20	2025/02/19
Horn Antenna	Schwarzbeck	BBHA 9170	HKE-017	2024/02/21	2026/02/20
High gain antenna	Schwarzbeck	LB-180400KF	HKE-054	2024/02/21	2026/02/20
Horn antenna	Schwarzbeck	9120D	HKE-135	2024/02/21	2026/02/20
High gain antenna	Schwarzbeck	LB-180400KF	HKE-128	2024/02/21	2026/02/20
Broadband antenna	Schwarzbeck	VULB 9163	HKE-087	2024/02/20	2026/02/19
Signal generator	Agilent	E4433B	HKE-120	2024/02/20	2025/02/19
Signal generator	Agilent	E4421B	HKE-121	2024/02/20	2025/02/19

2.8 Modifications

No modifications were implemented to meet testing criteria.







- level is detected by the measuring receiver.
- f. The transmitter shall then be rotated through 360° in the horizontal plane, until the maximum signal level is detected by the measuring receiver.
- g. The test antenna shall be raised and lowered again through the specified range of height until a maximum signal level is detected by the measuring receiver.
- h. The maximum signal level detected by the measuring receiver shall be noted.
- i. The transmitter shall be replaced by a substitution antenna.
- j. The substitution antenna shall be orientated for vertical polarization and the length of the substitution antenna shall be adjusted to correspond to the frequency of the transmitter.
- k. The substitution antenna shall be connected to a calibrated signal generator.
- l. If necessary, the input attenuator setting of the measuring receiver shall be adjusted in order to increase the sensitivity of the measuring receiver.
- m. The test antenna shall be raised and lowered through the specified range of height to ensure that the maximum signal is received.
- n. The input signal to the substitution antenna shall be adjusted to the level that produces a level detected by the measuring receiver, that is equal to the level noted while the transmitter radiated power was measured, corrected for the change of input attenuator setting of the measuring receiver.
- o. The measurement shall be repeated with the test antenna and the substitution antenna orientated for horizontal polarization.
- p. The measure of the effective radiated power is the larger of the two levels recorded at the input to the substitution antenna, corrected for gain of the substitution antenna if necessary.
- q. Test site anechoic chamber refer to ANSI C63.4.

**TEST RESULTS**

**Conducted Measurement:**

Band	Bandwidth	Modulation	Channel	RB Configuration	Result(dBm)	Verdict
Band14	5MHz	QPSK	23305	1RB#0	24.11	PASS
Band14	5MHz	QPSK	23305	1RB#12	23.99	PASS
Band14	5MHz	QPSK	23305	1RB#24	24.17	PASS
Band14	5MHz	QPSK	23305	12RB#13	23.16	PASS
Band14	5MHz	QPSK	23305	12RB#0	23.20	PASS
Band14	5MHz	QPSK	23305	12RB#6	23.23	PASS
Band14	5MHz	QPSK	23305	25RB#0	23.23	PASS
Band14	5MHz	QPSK	23330	1RB#0	24.09	PASS
Band14	5MHz	QPSK	23330	1RB#12	24.15	PASS
Band14	5MHz	QPSK	23330	1RB#24	24.12	PASS
Band14	5MHz	QPSK	23330	12RB#6	23.09	PASS
Band14	5MHz	QPSK	23330	12RB#0	23.12	PASS
Band14	5MHz	QPSK	23330	12RB#13	23.21	PASS
Band14	5MHz	QPSK	23330	25RB#0	23.15	PASS
Band14	5MHz	QPSK	23355	1RB#24	24.15	PASS
Band14	5MHz	QPSK	23355	1RB#12	24.15	PASS
Band14	5MHz	QPSK	23355	1RB#0	24.02	PASS
Band14	5MHz	QPSK	23355	12RB#6	22.16	PASS
Band14	5MHz	QPSK	23355	12RB#0	23.17	PASS
Band14	5MHz	QPSK	23355	12RB#13	23.27	PASS

The results shown in this test report refer only to the sample(s) tested unless otherwise stated and the sample(s) are retained for 30 days only. The document is issued by HUAK, this document cannot be reproduced except in full with our prior written permission. The more details and the authenticity of the report will be confirmed at <http://www.cer-mark.com>.



Band14	5MHz	QPSK	23355	25RB#0	23.12	PASS
Band14	5MHz	16QAM	23305	1RB#0	23.02	PASS
Band14	5MHz	16QAM	23305	1RB#12	22.77	PASS
Band14	5MHz	16QAM	23305	1RB#24	23.16	PASS
Band14	5MHz	16QAM	23305	12RB#0	22.07	PASS
Band14	5MHz	16QAM	23305	12RB#13	22.21	PASS
Band14	5MHz	16QAM	23305	12RB#6	22.26	PASS
Band14	5MHz	16QAM	23305	25RB#0	22.27	PASS
Band14	5MHz	16QAM	23330	1RB#0	23.08	PASS
Band14	5MHz	16QAM	23330	1RB#12	23.12	PASS
Band14	5MHz	16QAM	23330	1RB#24	23.08	PASS
Band14	5MHz	16QAM	23330	12RB#0	22.16	PASS
Band14	5MHz	16QAM	23330	12RB#13	22.08	PASS
Band14	5MHz	16QAM	23330	12RB#6	22.04	PASS
Band14	5MHz	16QAM	23330	25RB#0	22.28	PASS
Band14	5MHz	16QAM	23355	1RB#12	23.06	PASS
Band14	5MHz	16QAM	23355	1RB#0	23.17	PASS
Band14	5MHz	16QAM	23355	1RB#24	22.75	PASS
Band14	5MHz	16QAM	23355	12RB#13	22.11	PASS
Band14	5MHz	16QAM	23355	12RB#6	22.30	PASS
Band14	5MHz	16QAM	23355	12RB#0	22.23	PASS
Band14	5MHz	16QAM	23355	25RB#0	22.20	PASS
Band14	10MHz	QPSK	23330	1RB#0	24.23	PASS
Band14	10MHz	QPSK	23330	1RB#49	23.95	PASS
Band14	10MHz	QPSK	23330	1RB#24	24.15	PASS
Band14	10MHz	QPSK	23330	25RB#0	23.28	PASS
Band14	10MHz	QPSK	23330	25RB#25	23.24	PASS
Band14	10MHz	QPSK	23330	25RB#12	23.24	PASS
Band14	10MHz	QPSK	23330	50RB#0	23.21	PASS
Band14	10MHz	16QAM	23330	1RB#49	23.24	PASS
Band14	10MHz	16QAM	23330	1RB#24	23.61	PASS
Band14	10MHz	16QAM	23330	1RB#0	23.40	PASS
Band14	10MHz	16QAM	23330	25RB#12	22.27	PASS
Band14	10MHz	16QAM	23330	25RB#0	22.29	PASS
Band14	10MHz	16QAM	23330	25RB#25	22.15	PASS
Band14	10MHz	16QAM	23330	50RB#0	22.18	PASS

The results shown in this test report refer only to the sample(s) tested unless otherwise stated and the sample(s) are retained for 30 days only. The document is issued by HUAKE, this document cannot be reproduced except in full with our prior written permission. The more details and the authenticity of the report will be confirmed at <http://www.cer-mark.com>.

TEL : +86-755 2302 9901 FAX : +86-755 2302 9901 E-mail : [service@cer-mark.com](mailto:service@cer-mark.com)

Add: 1-2F., Building B2, Junfeng Zhongcheng Zhizao Innovation Park, Heping Community, Fuhai Street, Bao'an District, Shenzhen, Guangdong, China



**Radiated Measurement:**

Remark:

1. We were tested all RB Configuration refer 3GPP TS136 521 for each Channel Bandwidth of LTE FDD Band 14; recorded worst case for each Channel Bandwidth of LTE FDD Band 14.
2.  $EIRP = P_{Mea}(dBm) - P_{cl}(dB) + P_{Ag}(dB) + G_a(dBi)$ ,  $EIRP = ERP + 2.15$

**LTE FDD Band 14 Channel Bandwidth 5MHz\_QPSK**

Frequency (MHz)	P <sub>Mea</sub> (dBm)	P <sub>cl</sub> (dB)	G <sub>a</sub> Antenna Gain(dB)	Correction (dB)	EIRP (dBm)	ERP (dBm)	Limit (dBm)	Margin (dB)	Polarization
790.5	-18.33	3.06	9.68	34.8	23.09	20.94	34.77	13.83	V
793.0	-17.9	3.17	9.68	34.8	23.41	21.26	34.77	13.51	V
795.5	-16.99	3.22	9.75	34.8	24.34	22.19	34.77	12.58	V
790.5	-18.7	3.06	9.68	34.8	22.72	20.57	34.77	14.2	H
793.0	-17.29	3.17	9.68	34.8	24.02	21.87	34.77	12.9	H
795.5	-17.42	3.22	9.75	34.8	23.91	21.76	34.77	13.01	H

**LTE FDD Band 14 Channel Bandwidth 10MHz\_QPSK**

Frequency (MHz)	P <sub>Mea</sub> (dBm)	P <sub>cl</sub> (dB)	G <sub>a</sub> Antenna Gain(dB)	Correction (dB)	EIRP (dBm)	ERP (dBm)	Limit (dBm)	Margin (dB)	Polarization
793.0	-15.98	3.22	9.75	34.8	25.35	23.2	34.77	11.57	V
793.0	-17.98	3.06	9.68	34.8	23.44	21.29	34.77	13.48	H

**LTE FDD Band 14 Channel Bandwidth 5MHz\_16QAM**

Frequency (MHz)	P <sub>Mea</sub> (dBm)	P <sub>cl</sub> (dB)	G <sub>a</sub> Antenna Gain(dB)	Correction (dB)	EIRP (dBm)	ERP (dBm)	Limit (dBm)	Margin (dB)	Polarization
790.5	-18.63	3.06	9.68	34.8	22.79	20.64	34.77	14.13	V
793.0	-18.19	3.17	9.68	34.8	23.12	20.97	34.77	13.8	V
795.5	-16.67	3.22	9.75	34.8	24.66	22.51	34.77	12.26	V
790.5	-18.88	3.06	9.68	34.8	22.54	20.39	34.77	14.38	H
793.0	-17.37	3.17	9.68	34.8	23.94	21.79	34.77	12.98	H
795.5	-17.27	3.22	9.75	34.8	24.06	21.91	34.77	12.86	H

**LTE FDD Band 14 Channel Bandwidth 10MHz\_16QAM**

Frequency (MHz)	P <sub>Mea</sub> (dBm)	P <sub>cl</sub> (dB)	G <sub>a</sub> Antenna Gain(dB)	Correction (dB)	EIRP (dBm)	ERP (dBm)	Limit (dBm)	Margin (dB)	Polarization
793.0	-15.84	3.22	9.75	34.8	25.49	23.34	34.77	11.43	V
793.0	-18.08	3.06	9.68	34.8	23.34	21.19	34.77	13.58	H



### 3.2 Peak-to-Average Ratio (PAR)

#### LIMIT

The Peak-to-Average Ratio (PAR) of the transmission may not exceed 13 dB.

#### TEST CONFIGURATION

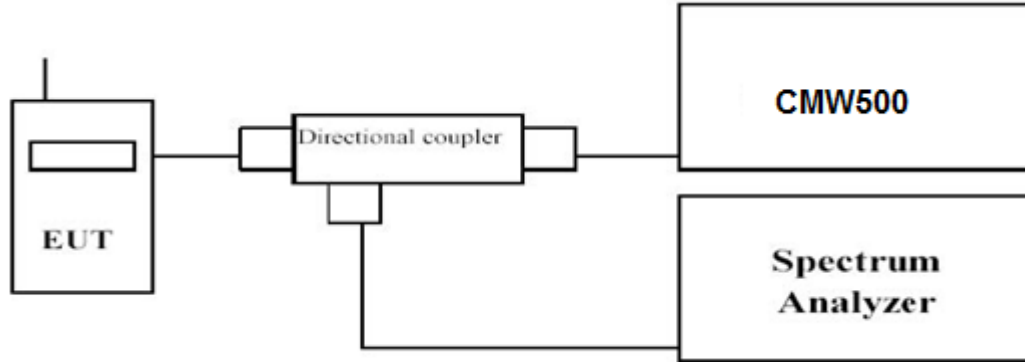

#### TEST PROCEDURE

1. Refer to instrument’s analyzer instruction manual for details on how to use the power statistics/CCDF function;
2. Set resolution/measurement bandwidth  $\geq$  signal’s occupied bandwidth;
3. Set the number of counts to a value that stabilizes the measured CCDF curve;
4. Set the measurement interval as follows:
  - 1). for continuous transmissions, set to 1 ms,
  - 2). for burst transmissions, employ an external trigger that is synchronized with the EUT burst timing sequence, or use the internal burst trigger with a trigger level that allows the burst to stabilize and set the measurement interval to a time that is less than or equal to the burst duration.
5. Record the maximum PAPR level associated with a probability of 0.1%.

#### TEST RESULTS

Remark:

1. We were tested all RB Configuration refer 3GPP TS136 521 for each Channel Bandwidth of LTE Band 14; recorded worst case for each Channel Bandwidth of LTE Band 14.

LTE Band 14				
TX Channel Bandwidth	Frequency (MHz)	RB Size/Offset	PAPR (dB)	
			QPSK	16QAM
5 MHz	790.5	1RB#0	8.50	5.31
	793		7.61	5.92
	795.5		8.27	5.32
10 MHz	793	1RB#0	4.44	6.78



LTE Band 14-5MHz Channel Bandwidth PAPR

QPSK

16QAM



1RB#0

1RB#0

Low Channel

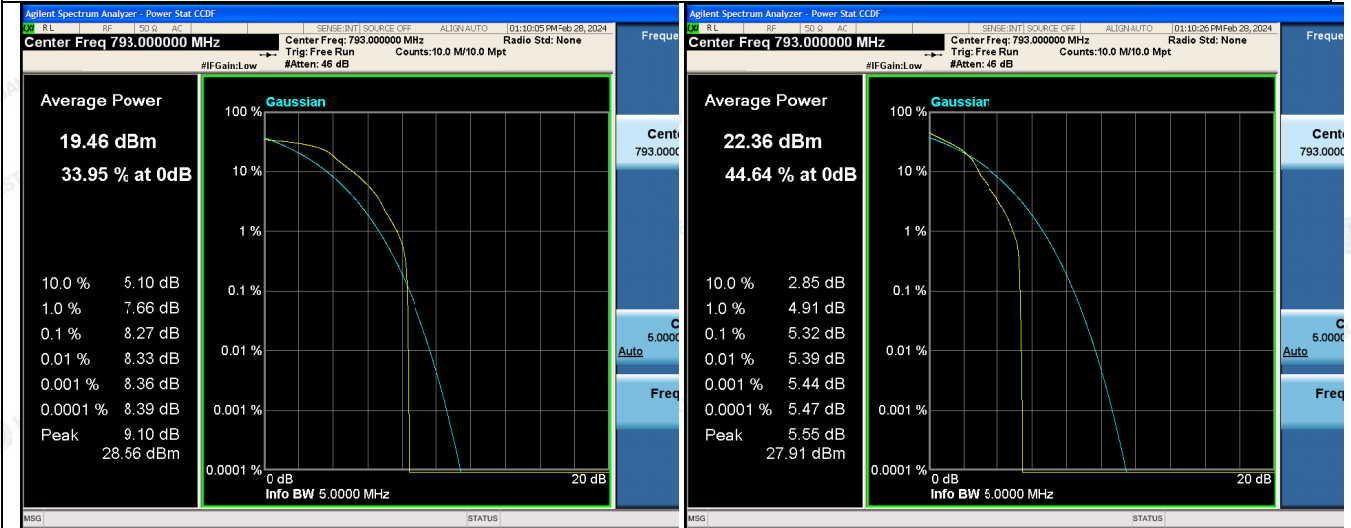

1RB#0

1RB#0

Middle Channel



1RB#0

1RB#0

High Channel

The results shown in this test report refer only to the sample(s) tested unless otherwise stated and the sample(s) are retained for 30 days only. The document is issued by HUAKE, this document cannot be reproduced except in full with our prior written permission. The more details and the authenticity of the report will be confirmed at <http://www.cer-mark.com>.

TEL : +86-755 2302 9901 FAX : +86-755 2302 9901 E-mail : service@cer-mark.com

Add: 1-2F., Building B2, Junfeng Zhongcheng Zhizao Innovation Park, Heping Community, Fuhai Street, Bao'an District, Shenzhen, Guangdong, China



LTE Band 14-10MHz Channel Bandwidth PAPR

QPSK

16QAM

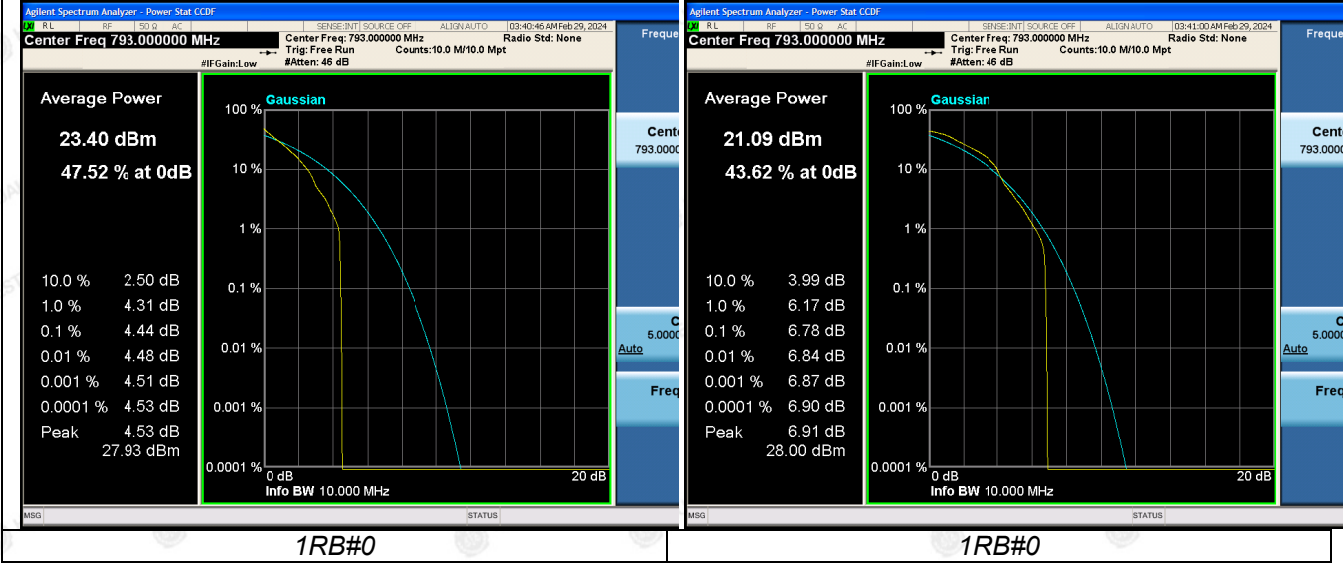

1RB#0

1RB#0

The results shown in this test report refer only to the sample(s) tested unless otherwise stated and the sample(s) are retained for 30 days only. The document is issued by HUAJ, this document cannot be reproduced except in full with our prior written permission. The more details and the authenticity of the report will be confirmed at <http://www.cer-mark.com>.

TEL : +86-755 2302 9901 FAX : +86-755 2302 9901 E-mail : service@cer-mark.com

Add: 1-2F., Building B2, Junfeng Zhongcheng Zhizao Innovation Park, Heping Community, Fuhai Street, Bao'an District, Shenzhen, Guangdong, China

### 3.3 Occupied Bandwidth and Emission Bandwidth

#### LIMIT

No specific occupied bandwidth requirements in part 2.1049.

Part 90.209 (a) Each authorization issued to a station licensed under this part will show an emission designator representing the class of emission authorized. The designator will be prefixed by a specified necessary bandwidth. This number does not necessarily indicate the bandwidth occupied by the emission at any instant. In those cases where part 2.202 of this chapter does not provide a formula for the computation of necessary bandwidth, the occupied bandwidth, as defined in part 2 of this chapter, may be used in lieu of the necessary bandwidth.

#### TEST CONFIGURATION

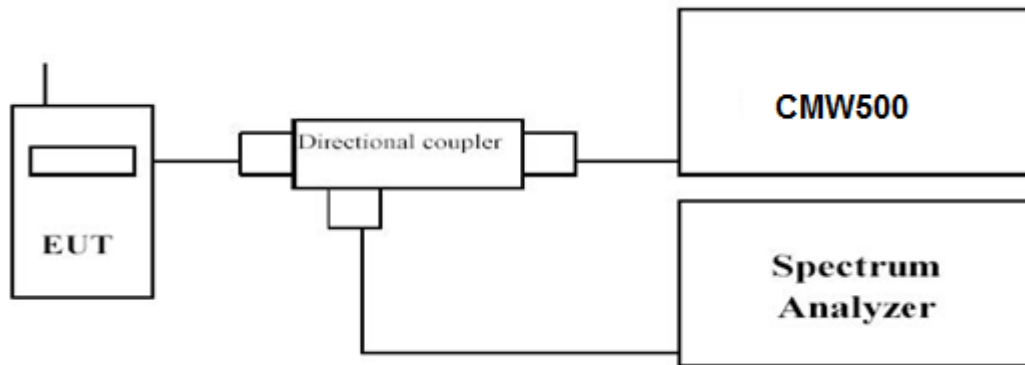

#### TEST PROCEDURE

The transmitter output was connected to a calibrated coaxial cable and coupler, the other end of which was connected to a spectrum analyzer. The occupied bandwidth was measured with the spectrum analyzer at low, middle and high channel in each band. The -26dBc Emission bandwidth was also measured and recorded. Set RBW was set to about 1% of emission BW, VBW≥3 times RBW.

-26dBc display line was placed on the screen (or 99% bandwidth), the occupied bandwidth is the delta frequency between the two points where the display line intersects the signal trace.

#### TEST RESULTS

Remark:

1. We were tested all RB Configuration refer 3GPP TS136 521 for each Channel Bandwidth of LTE Band 14; recorded worst case for each Channel Bandwidth of LTE Band 14.

LTE Band 14						
TX Channel Bandwidth	RB Size/Offset	Frequency (MHz)	-26dBc Emission bandwidth (MHz)		99% Occupied bandwidth (MHz)	
			QPSK	16QAM	QPSK	16QAM
5 MHz	25RB#0	790.5	4.983	5.047	4.4983	4.5222
		793	5.013	5.010	4.4994	4.5049
		795.5	4.979	4.995	4.5057	4.5038
10 MHz	50RB#0	793	9.839	9.811	8.9372	8.9418





LTE Band 14-5MHz Channel Bandwidth

QPSK

16QAM

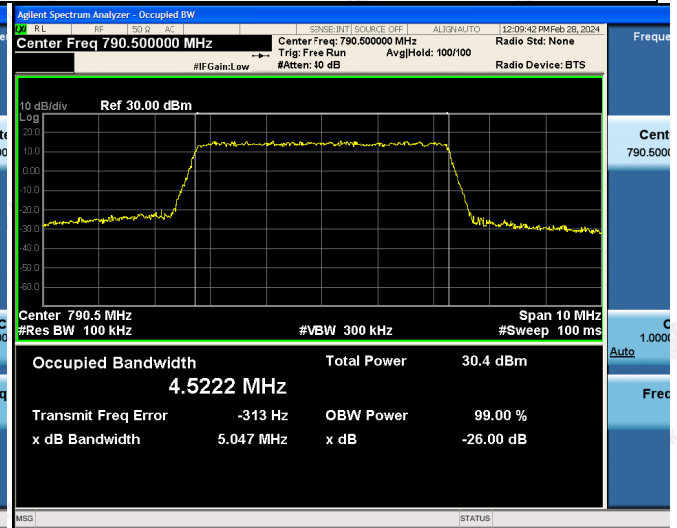
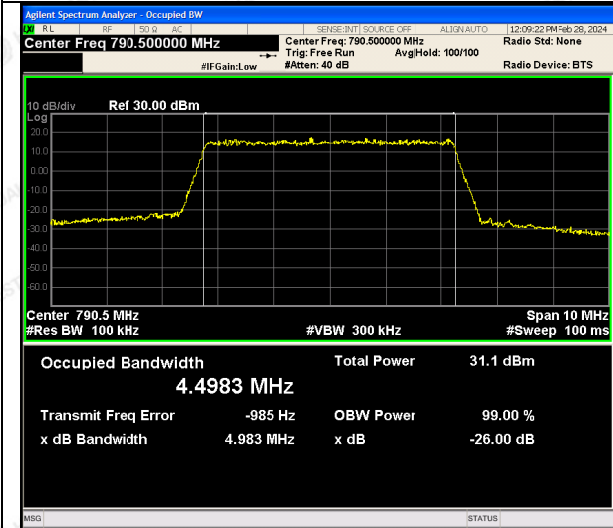

25RB#0

25RB#0

Low Channel

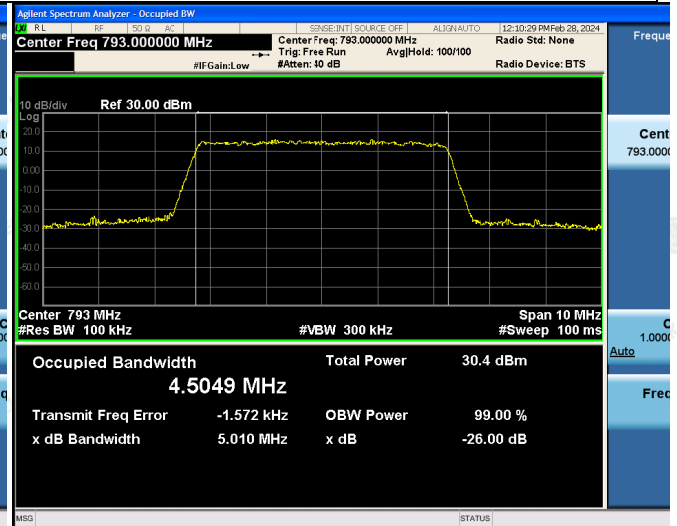
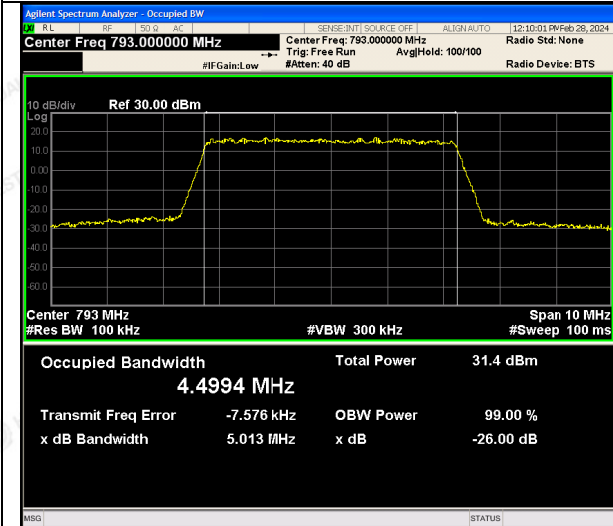

25RB#0

25RB#0

Middle Channel

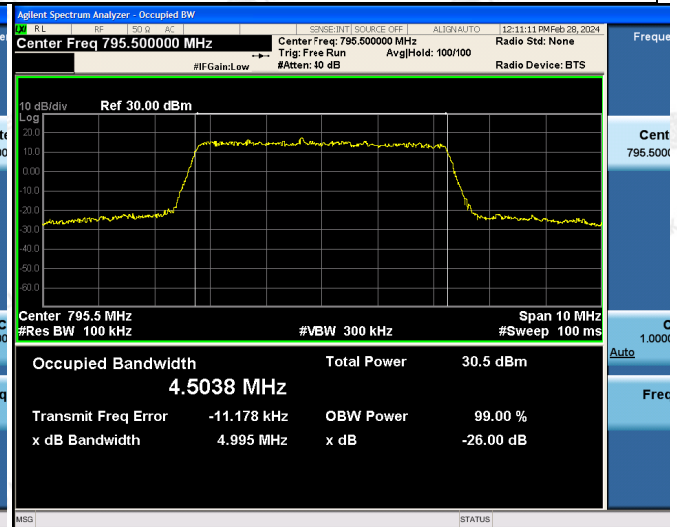
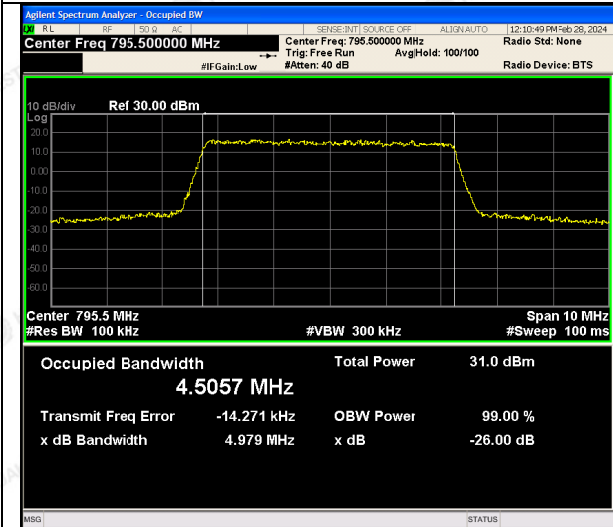

25RB#0

25RB#0

High Channel

The results shown in this test report refer only to the sample(s) tested unless otherwise stated and the sample(s) are retained for 30 days only. This document is issued by HUAJ, this document cannot be reproduced except in full with our prior written permission. The more details and the authenticity of the report will be confirmed at http://www.cer-mark.com.

TEL : +86-755 2302 9901 FAX : +86-755 2302 9901 E-mail : service@cer-mark.com

Add: 1-2F., Building B2, Junfeng Zhongcheng Zhizao Innovation Park, Heping Community, Fuhai Street, Bao'an District, Shenzhen, Guangdong, China

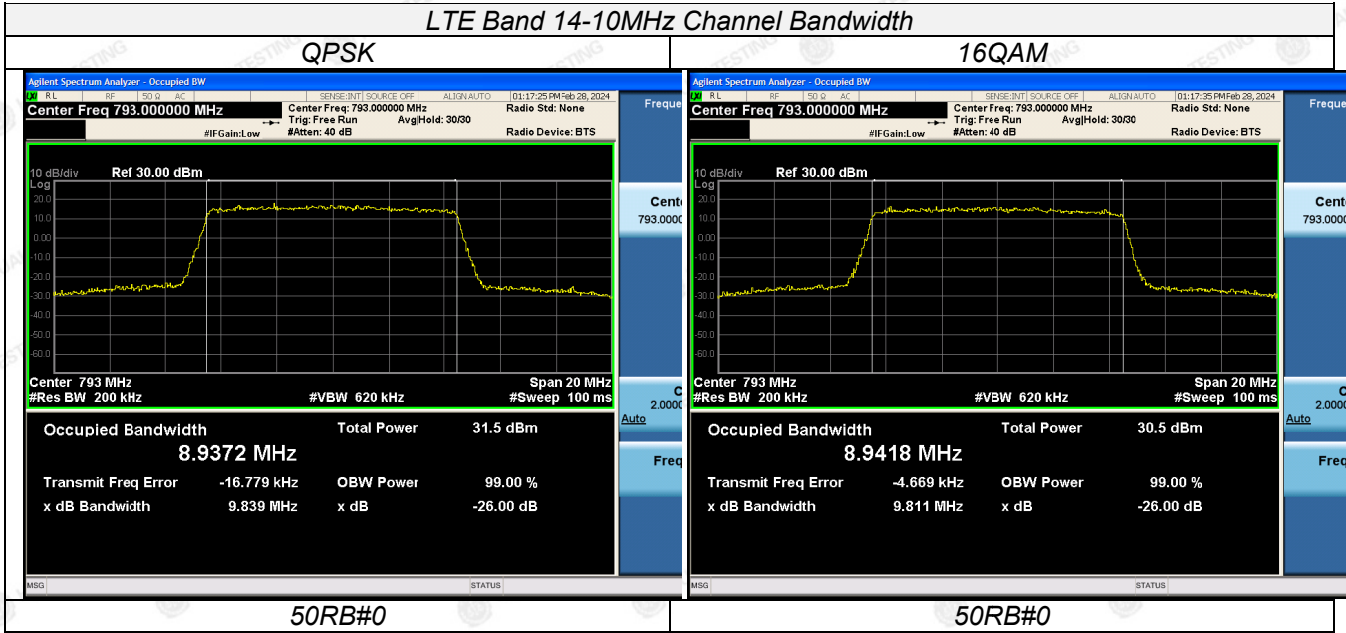

The results shown in this test report refer only to the sample(s) tested unless otherwise stated and the sample(s) are retained for 30 days only. The document is issued by HUAJ, this document cannot be reproduced except in full with our prior written permission. The more details and the authenticity of the report will be confirmed at <http://www.cer-mark.com>.

TEL : +86-755 2302 9901    FAX : +86-755 2302 9901    E-mail : service@cer-mark.com

Add: 1-2F., Building B2, Junfeng Zhongcheng Zhizao Innovation Park, Heping Community, Fuhai Street, Bao'an District, Shenzhen, Guangdong, China



### 3.4 Band Edge compliance

#### LIMIT

90.543 Emission limitations (e) For operations in the 758-768 MHz and the 788-798 MHz bands, the power of any emission outside the licensee's frequency band(s) of operation shall be attenuated below the transmitter power (P) within the licensed band(s) of operation, measured in watts, in accordance with the following:

(1) On all frequencies between 769-775 MHz and 799-805 MHz, by a factor not less than  $76 + 10 \log (P)$  dB in a 6.25 kHz band segment, for base and fixed stations.

(2) On all frequencies between 769-775 MHz and 799-805 MHz, by a factor not less than  $65 + 10 \log (P)$  dB in a 6.25 kHz band segment, for mobile and portable stations.

(3) On any frequency between 775-788 MHz, above 805 MHz, and below 758 MHz, by at least  $43 + 10 \log (P)$  dB.

(4) Compliance with the provisions of paragraphs (e)(1) and (2) of this section is based on the use of measurement instrumentation such that the reading taken with any resolution bandwidth setting should be adjusted to indicate spectral energy in a 6.25 kHz segment.

(5) Compliance with the provisions of paragraph (e)(3) of this section is based on the use of measurement instrumentation employing a resolution bandwidth of 100 kHz or greater. However, in the 100 kHz bands immediately outside and adjacent to the frequency block, a resolution bandwidth of 30 kHz may be employed.

(f) For operations in the 758-775 MHz and 788-805 MHz bands, all emissions including harmonics in the band 1559-1610 MHz shall be limited to  $-70$  dBW/MHz equivalent isotropically radiated power (EIRP) for wideband signals, and  $-80$  dBW EIRP for discrete emissions of less than 700 Hz bandwidth. For the purpose of equipment authorization, a transmitter shall be tested with an antenna that is representative of the type that will be used with the equipment in normal operation.

#### TEST CONFIGURATION

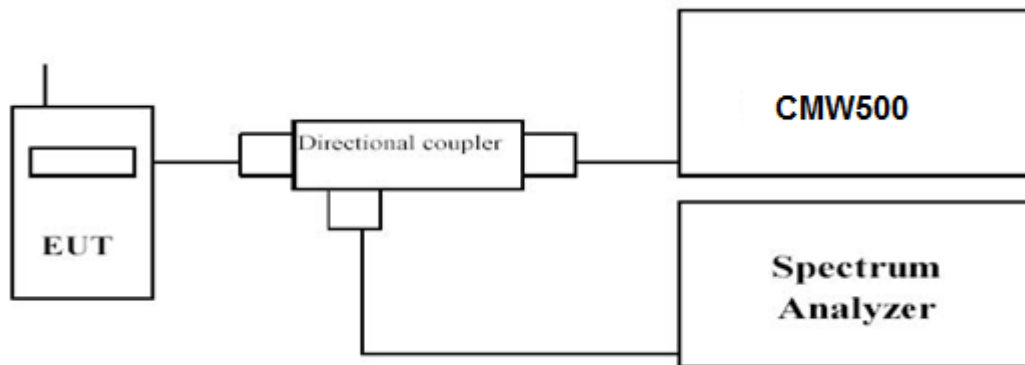

#### TEST PROCEDURE

1. The transmitter output port was connected to base station.
2. The RF output of EUT was connected to the power meter by RF cable and attenuator, the path loss was compensated to the results for each measurement.
3. Set EUT at maximum power through base station.
4. Select lowest and highest channels for each band and different modulation.
5. Measure Band edge using RMS (Average) detector by spectrum

#### TEST RESULTS

Remark:

1. We were tested all RB Configuration refer 3GPP TS136 521 for each Channel Bandwidth of LTE Band 14; recorded worst case for each Channel Bandwidth of LTE Band 14.



LTE Band 14-5MHz Channel Bandwidth Band Edge Compliance

QPSK

16QAM

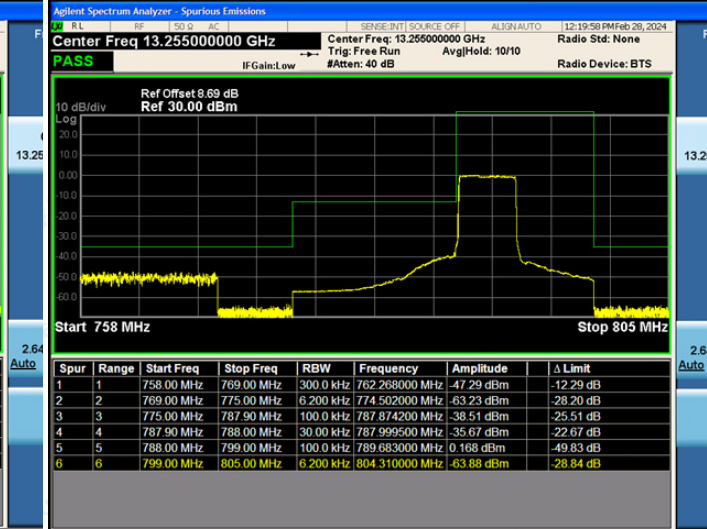
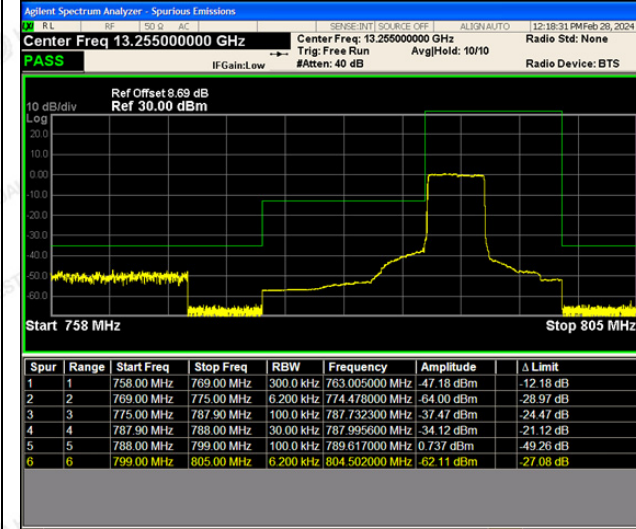

25RB#0

25RB#0

Low Channel

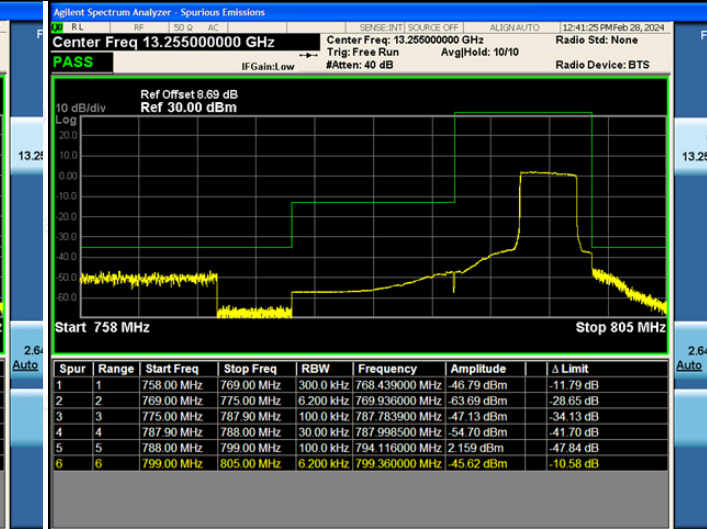
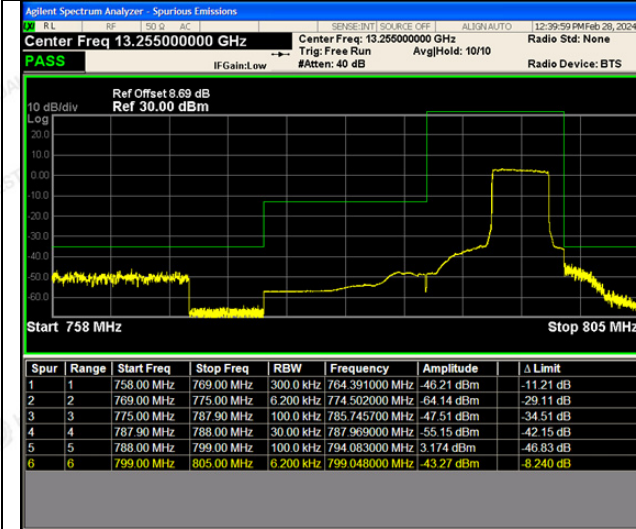

25RB#0

25RB#0

High Channel

The results shown in this test report refer only to the sample(s) tested unless otherwise stated and the sample(s) are retained for 30 days only. The document is issued by HUAJ, this document cannot be reproduced except in full with our prior written permission. The more details and the authenticity of the report will be confirmed at http://www.cer-mark.com.

TEL : +86-755 2302 9901 FAX : +86-755 2302 9901 E-mail : service@cer-mark.com

Add: 1-2F., Building B2, Junfeng Zhongcheng Zhizao Innovation Park, Heping Community, Fuhai Street, Bao'an District, Shenzhen, Guangdong, China



LTE Band 14-10MHz Channel Bandwidth Band Edge Compliance

QPSK

16QAM

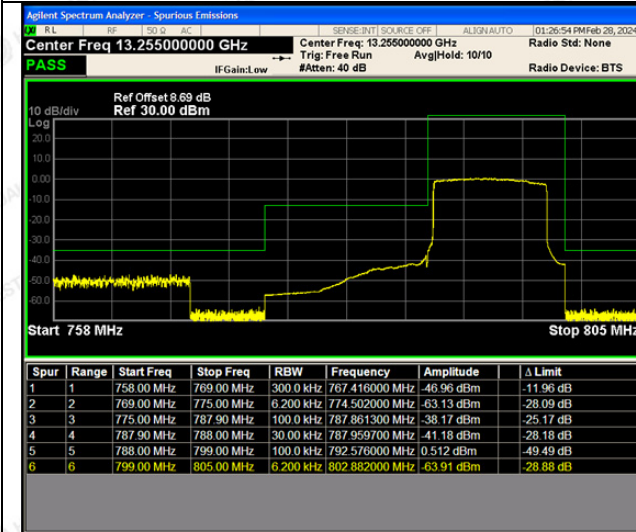

50RB#0

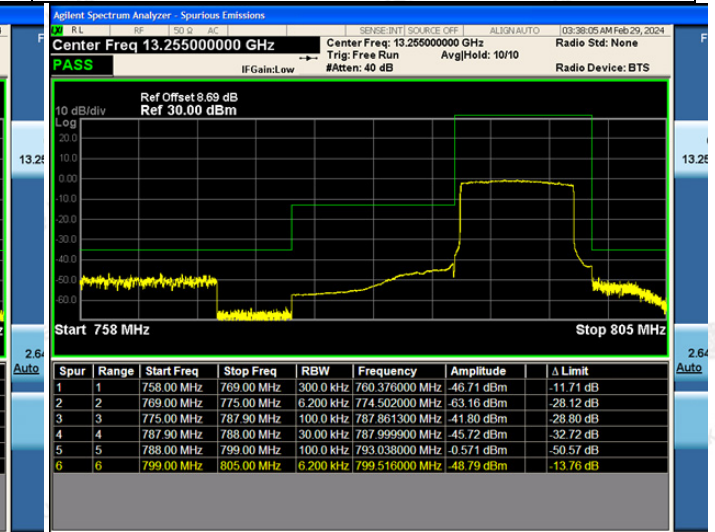

50RB#0

The results shown in this test report refer only to the sample(s) tested unless otherwise stated and the sample(s) are retained for 30 days only. The document is issued by HUAKE, this document cannot be reproduced except in full with our prior written permission. The more details and the authenticity of the report will be confirmed at <http://www.cer-mark.com>.

TEL : +86-755 2302 9901 FAX : +86-755 2302 9901 E-mail : service@cer-mark.com

Add: 1-2F., Building B2, Junfeng Zhongcheng Zhizao Innovation Park, Heping Community, Fuhai Street, Bao'an District, Shenzhen, Guangdong, China

### 3.5 Spurious Emission

#### LIMIT

90.543 Emission limitations (e) For operations in the 758-768 MHz and the 788-798 MHz bands, the power of any emission outside the licensee's frequency band(s) of operation shall be attenuated below the transmitter power (P) within the licensed band(s) of operation, measured in watts, in accordance with the following:

(1) On all frequencies between 769-775 MHz and 799-805 MHz, by a factor not less than  $76 + 10 \log (P)$  dB in a 6.25 kHz band segment, for base and fixed stations.

(2) On all frequencies between 769-775 MHz and 799-805 MHz, by a factor not less than  $65 + 10 \log (P)$  dB in a 6.25 kHz band segment, for mobile and portable stations.

(3) On any frequency between 775-788 MHz, above 805 MHz, and below 758 MHz, by at least  $43 + 10 \log (P)$  dB.

(4) Compliance with the provisions of paragraphs (e)(1) and (2) of this section is based on the use of measurement instrumentation such that the reading taken with any resolution bandwidth setting should be adjusted to indicate spectral energy in a 6.25 kHz segment.

(5) Compliance with the provisions of paragraph (e)(3) of this section is based on the use of measurement instrumentation employing a resolution bandwidth of 100 kHz or greater. However, in the 100 kHz bands immediately outside and adjacent to the frequency block, a resolution bandwidth of 30 kHz may be employed.

(f) For operations in the 758-775 MHz and 788-805 MHz bands, all emissions including harmonics in the band 1559-1610 MHz shall be limited to  $-70$  dBW/MHz equivalent isotropically radiated power (EIRP) for wideband signals, and  $-80$  dBW EIRP for discrete emissions of less than 700 Hz bandwidth. For the purpose of equipment authorization, a transmitter shall be tested with an antenna that is representative of the type that will be used with the equipment in normal operation.

#### TEST CONFIGURATION

Conducted Spurious Measurement:

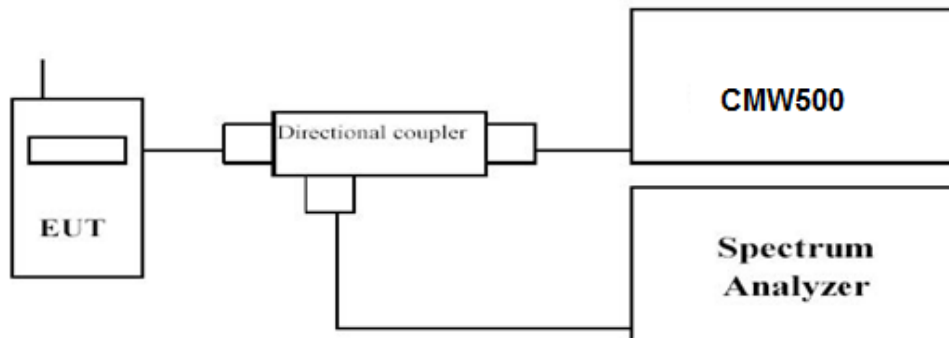

Radiated Spurious Measurement:

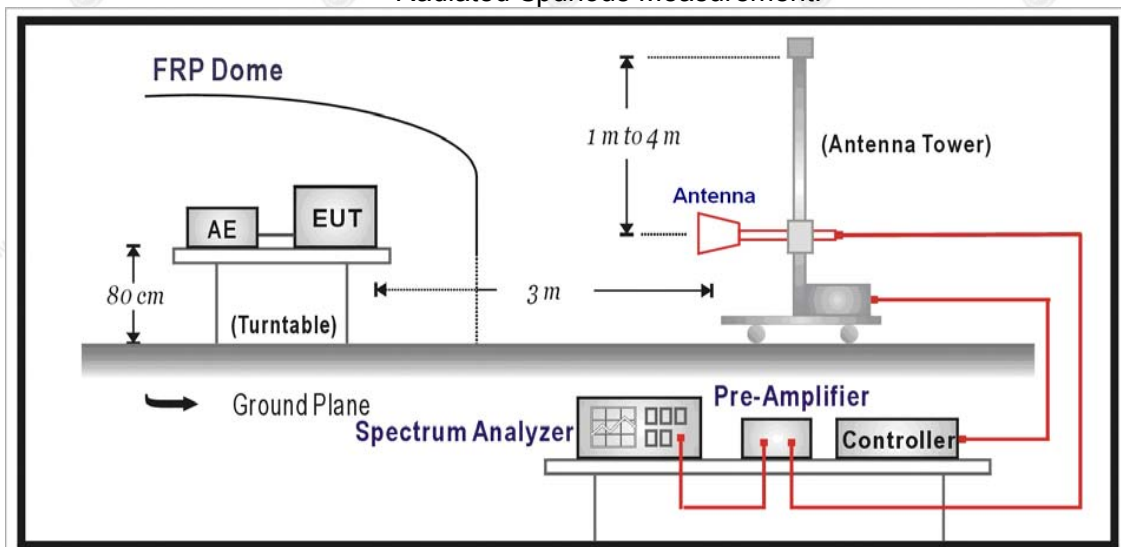



The EUT was setup according to EIA/TIA 603D

**Conducted Spurious Measurement:**

- a. Place the EUT on a bench and set it in transmitting mode.
- b. Connect a low loss RF cable from the antenna port to a spectrum analyzer and CMW500 by a Directional Couple.
- c. EUT Communicate with CMW500, then select a channel for testing.
- d. Add a correction factor to the display of spectrum, and then test.
- e. The resolution bandwidth of the spectrum analyzer was set sufficient scans were taken to show the out of band Emission if any up to 10<sup>th</sup> harmonic.
- f. Please refer to following tables for test antenna conducted emissions.

Working Frequency	Sub range (GHz)	RBW	VBW	Sweep time (s)
LTE FDD Band 14	0.000009~0.000015	1KHz	3KHz	Auto
	0.000015~0.03	10KHz	30KHz	Auto
	0.03~26.5	1 MHz	3 MHz	Auto

**Radiated Spurious Measurement:**

- a. The EUT shall be placed at the specified height on a support, and in the position closest to normal use as declared by provider.
- b. The test antenna shall be oriented initially for vertical polarization and shall be chosen to correspond to the frequency of the transmitter
- c. The output of the test antenna shall be connected to the measuring receiver.
- d. The transmitter shall be switched on and the measuring receiver shall be tuned to the frequency of the transmitter under test.
- e. The test antenna shall be raised and lowered through the specified range of height until a maximum signal level is detected by the measuring receiver.
- f. The transmitter shall then be rotated through 360° in the horizontal plane, until the maximum signal level is detected by the measuring receiver.
- g. The test antenna shall be raised and lowered again through the specified range of height until a maximum signal level is detected by the measuring receiver.
- h. The maximum signal level detected by the measuring receiver shall be noted.
- i. The transmitter shall be replaced by a substitution antenna.
- j. The substitution antenna shall be orientated for vertical polarization and the length of the substitution antenna shall be adjusted to correspond to the frequency of the transmitter.
- k. The substitution antenna shall be connected to a calibrated signal generator.
- l. If necessary, the input attenuator setting of the measuring receiver shall be adjusted in order to increase the sensitivity of the measuring receiver.
- m. The test antenna shall be raised and lowered through the specified range of height to ensure that the maximum signal is received.
- n. The input signal to the substitution antenna shall be adjusted to the level that produces a level detected by the measuring receiver, that is equal to the level noted while the transmitter radiated power was measured, corrected for the change of input attenuator setting of the measuring receiver.
- o. The measurement shall be repeated with the test antenna and the substitution antenna orientated for horizontal polarization.
- p. The measure of the effective radiated power is the larger of the two levels recorded at the input to the substitution antenna, corrected for gain of the substitution antenna if necessary.
- q. The resolution bandwidth of the spectrum analyzer was set at 100 kHz for Part 22 and 1MHz for Part 24. The frequency range was checked up to 10th harmonic.
- r. Test site anechoic chamber refer to ANSI C63.

**TEST RESULTS**

**Remark:**

1. We were tested all RB Configuration refer 3GPP TS136 521 for each Channel Bandwidth of LTE Band 14; recorded worst case for each Channel Bandwidth of LTE Band 14.



Conducted Measurement:

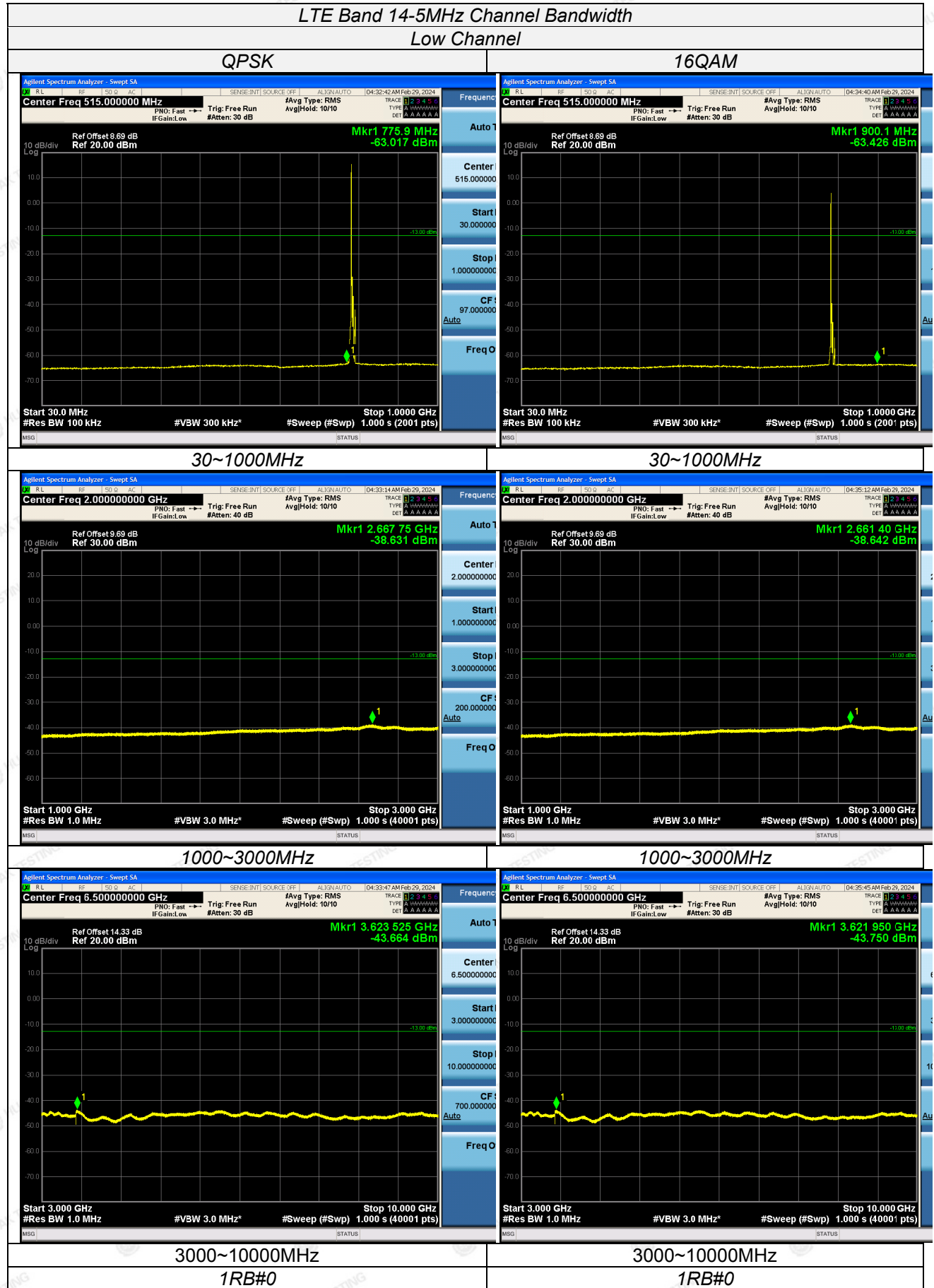

The results shown in this test report refer only to the sample(s) tested unless otherwise stated and the sample(s) are retained for 30 days only. This document is issued by HUAKE, this document cannot be reproduced except in full with our prior written permission. The more details and the authenticity of the report will be confirmed at <http://www.cer-mark.com>.

TEL : +86-755 2302 9901 FAX : +86-755 2302 9901 E-mail : service@cer-mark.com

Add: 1-2F., Building B2, Junfeng Zhongcheng Zhizao Innovation Park, Heping Community, Fuhai Street, Bao'an District, Shenzhen, Guangdong, China





LTE Band 14-5MHz Channel Bandwidth  
Middle Channel

QPSK

16QAM

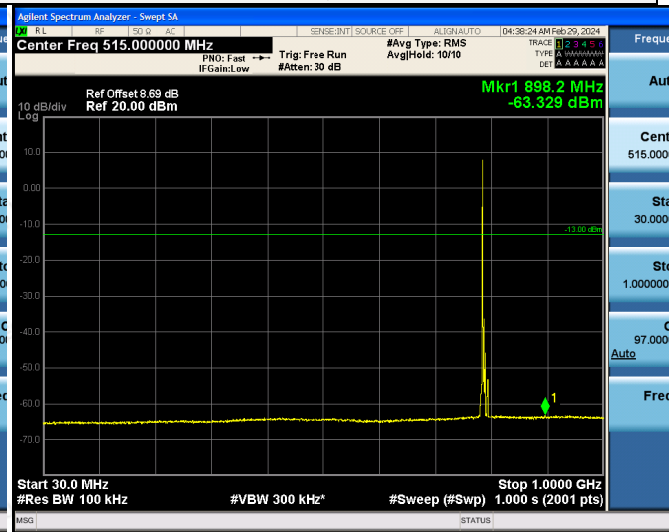
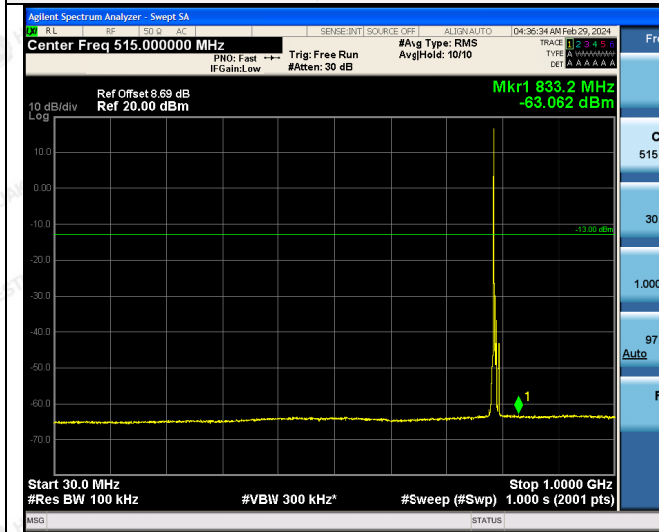

30~1000MHz

30~1000MHz

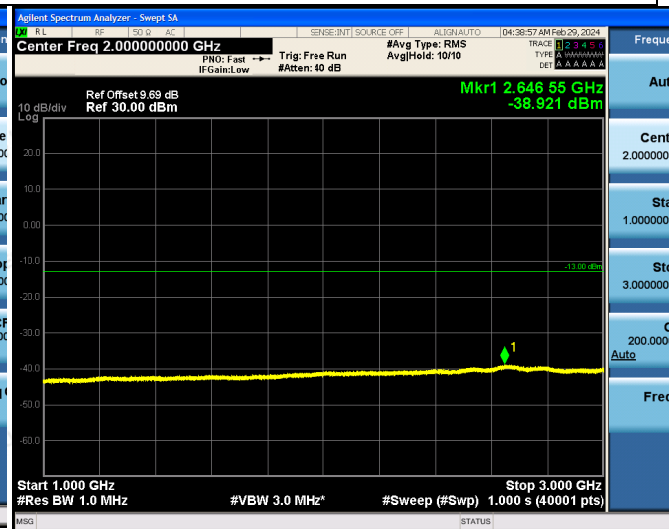

1000~3000MHz

1000~3000MHz

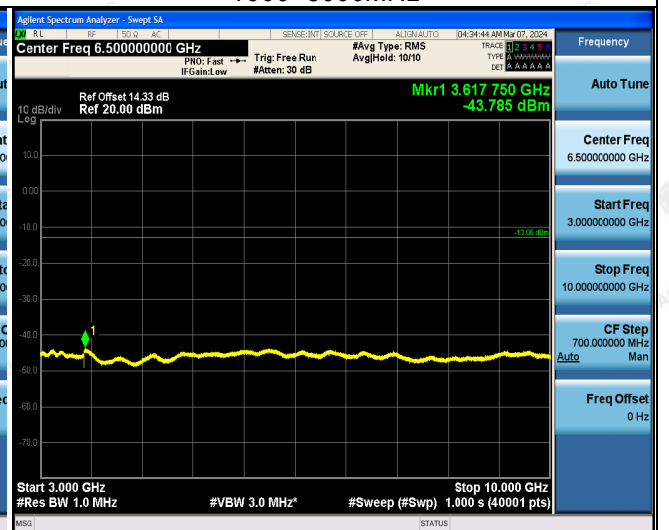
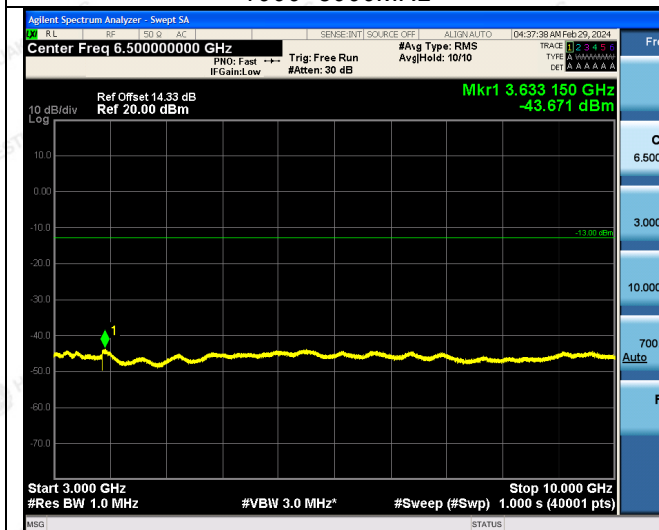

3000~10000MHz

3000~10000MHz

1RB#0

1RB#0



LTE Band 14-5MHz Channel Bandwidth  
High Channel

QPSK

16QAM

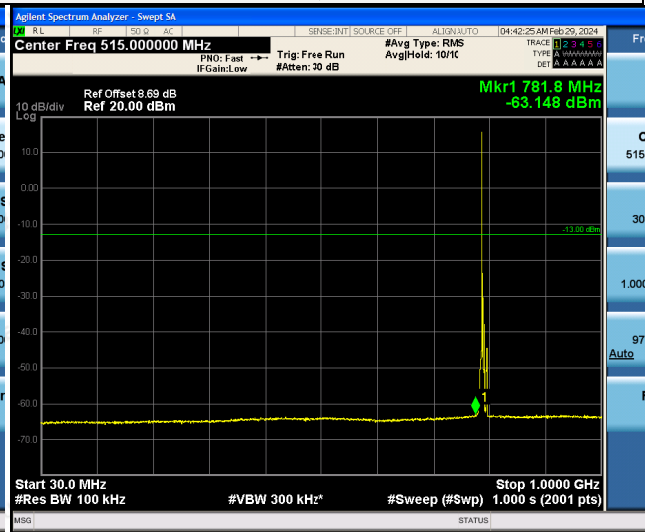
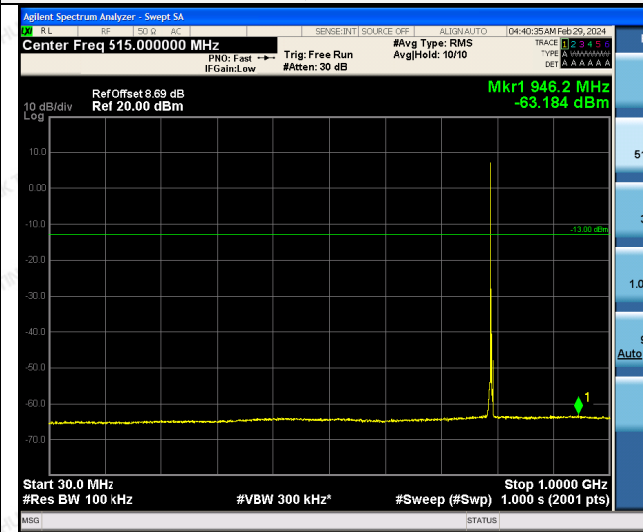

30~1000MHz

30~1000MHz

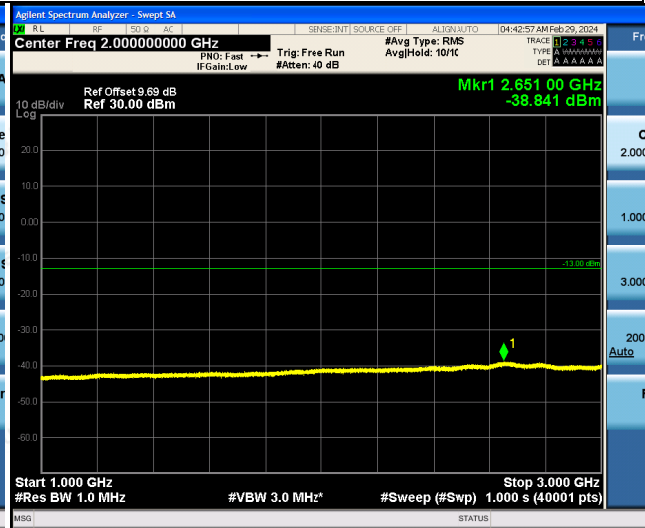

1000~3000MHz

1000~3000MHz

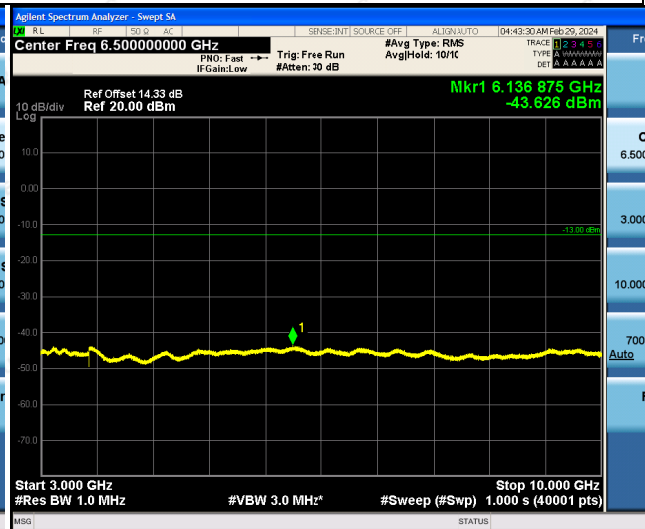
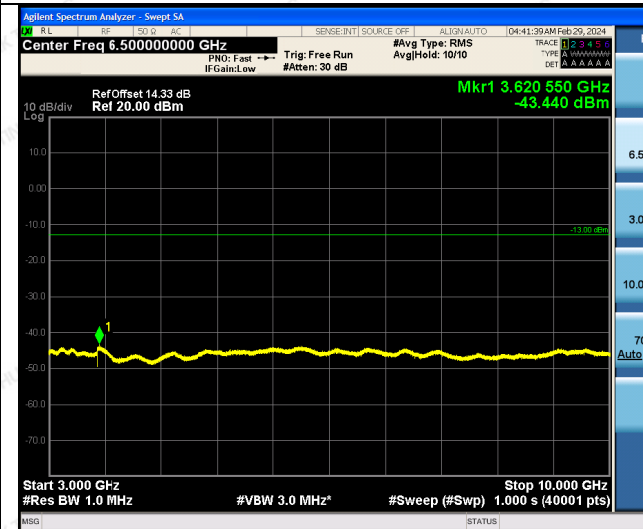

3000~10000MHz

3000~10000MHz

1RB#0

1RB#0

The results shown in this test report refer only to the sample(s) tested unless otherwise stated and the sample(s) are retained for 30 days only. This document is issued by HUAJ, this document cannot be reproduced except in full with our prior written permission. The more details and the authenticity of the report will be confirmed at <http://www.cer-mark.com>.

TEL : +86-755 2302 9901 FAX : +86-755 2302 9901 E-mail : service@cer-mark.com

Add: 1-2F., Building B2, Junfeng Zhongcheng Zhizao Innovation Park, Heping Community, Fuhai Street, Bao'an District, Shenzhen, Guangdong, China



LTE Band 14-10MHz Channel Bandwidth

QPSK

16QAM

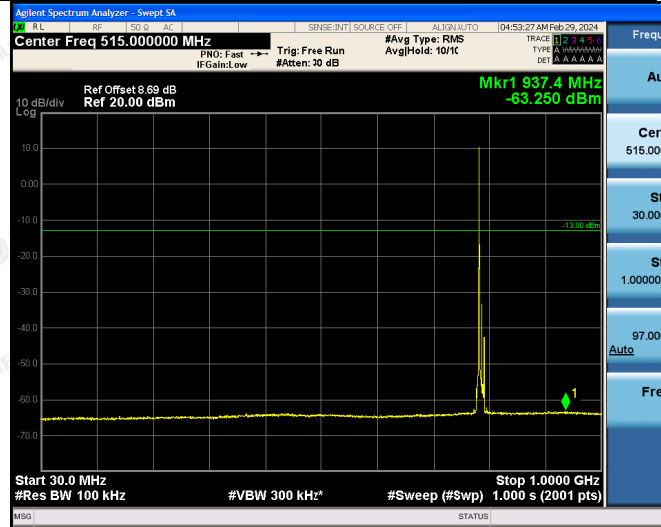
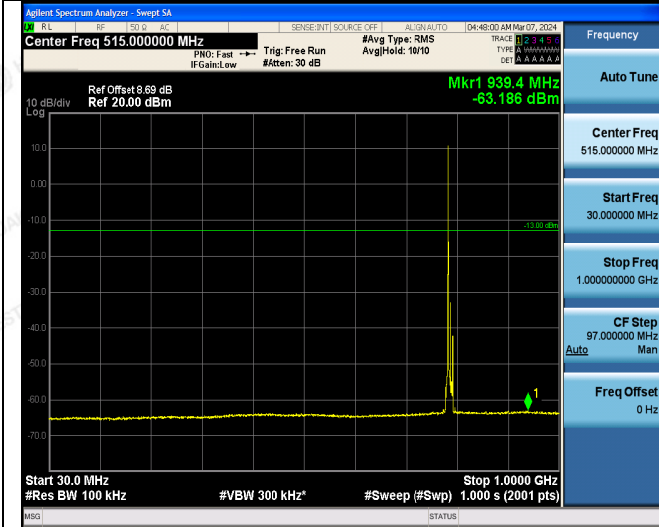

30~1000MHz

30~1000MHz

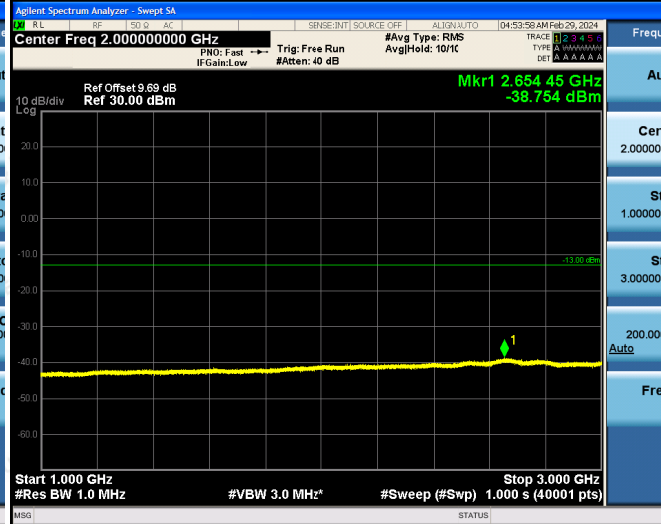
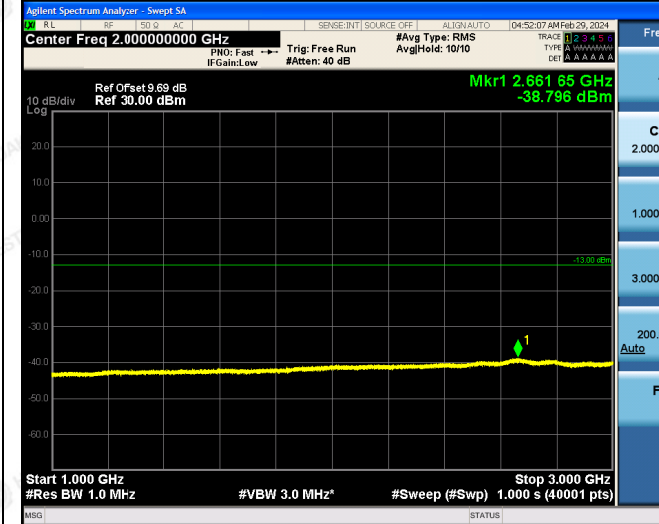

1000~3000MHz

1000~3000MHz

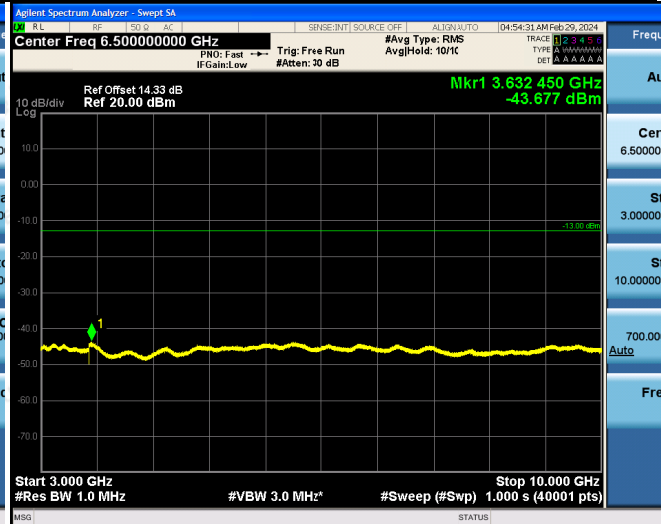
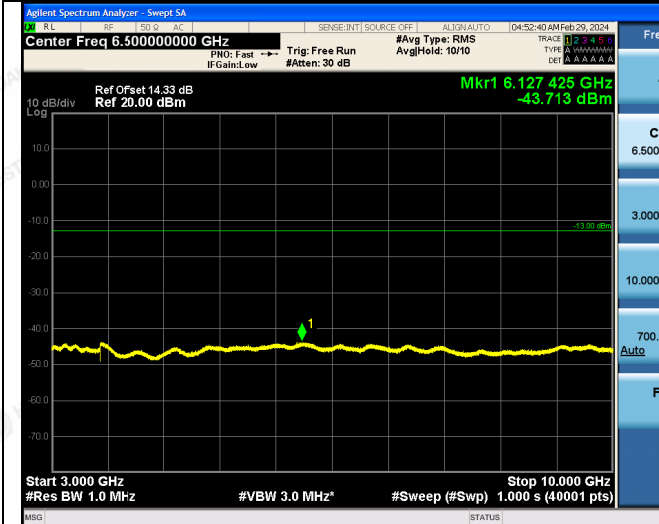

3000~10000MHz

3000~10000MHz

1RB#0

1RB#0

The results shown in this test report refer only to the sample(s) tested unless otherwise stated and the sample(s) are retained for 30 days only. This document is issued by HUAKE, this document cannot be reproduced except in full with our prior written permission. The more details and the authenticity of the report will be confirmed at <http://www.cer-mark.com>.

TEL : +86-755 2302 9901 FAX : +86-755 2302 9901 E-mail : service@cer-mark.com

Add: 1-2F., Building B2, Junfeng Zhongcheng Zhizao Innovation Park, Heping Community, Fuhai Street, Bao'an District, Shenzhen, Guangdong, China



**Remark:**

1. We were tested all RB Configuration refer 3GPP TS136 521 for each Channel Bandwidth of LTE FDD Band 14; recorded worst case for each Channel Bandwidth of LTE FDD Band 14.
2.  $EIRP = P_{Mea}(dBm) - P_{cl}(dB) + G_a(dBi)$
3. We were not recorded other points as values lower than limits.
4.  $Margin = Limit - EIRP, ERP = EIRP - 2.15dBi$

**LTE FDD Band 14 Channel Bandwidth 5MHz\_QPSK\_Low Channel**

Frequency (MHz)	PMea (dBm)	Pcl (dB)	Diatance	Ga Antenna Gain(dB)	ERP (dBm)	Limit (dBm)	Margin (dB)	Polarization
1581	-54.14	4.02	3	12.21	-45.95	-40.00	5.95	H
2371.5	-47.42	5.11	3	13.26	-39.27	-13.00	26.27	H
1581	-59.16	4.02	3	12.21	-50.97	-40.00	10.97	V
2371.5	-53.34	5.11	3	13.26	-45.19	-13.00	32.19	V

**LTE FDD Band 14 Channel Bandwidth 5MHz\_QPSK\_Middle Channel**

Frequency (MHz)	PMea (dBm)	Pcl (dB)	Diatance	Ga Antenna Gain(dB)	ERP (dBm)	Limit (dBm)	Margin (dB)	Polarization
1586	-53.84	4.02	3	12.21	-45.65	-40.00	5.65	H
2379	-47.09	5.11	3	13.26	-38.94	-13.00	25.94	H
1586	-59.17	4.02	3	12.21	-50.98	-40.00	10.98	V
2379	-53.81	5.11	3	13.26	-45.66	-13.00	32.66	V

**LTE FDD Band 14 Channel Bandwidth 5MHz\_QPSK\_High Channel**

Frequency (MHz)	PMea (dBm)	Pcl (dB)	Diatance	Ga Antenna Gain(dB)	ERP (dBm)	Limit (dBm)	Margin (dB)	Polarization
1591	-54.12	4.02	3	12.21	-45.93	-40.00	5.93	H
2386.5	-47.9	5.11	3	13.26	-39.75	-13.00	26.75	H
1591	-59.34	4.02	3	12.21	-51.15	-40.00	11.15	V
2386.5	-53.86	5.11	3	13.26	-45.71	-13.00	32.71	V

**LTE FDD Band 14 Channel Bandwidth 10MHz\_QPSK\_Middle Channel**

Frequency (MHz)	PMea (dBm)	Pcl (dB)	Diatance	Ga Antenna Gain(dB)	ERP (dBm)	Limit (dBm)	Margin (dB)	Polarization
1586	-55.08	4.02	3	12.21	-46.89	-40.00	6.89	H
2379	-46.27	5.11	3	13.26	-38.12	-13.00	25.12	H
1586	-58.91	4.02	3	12.21	-50.72	-40.00	10.72	V
2379	-53.39	5.11	3	13.26	-45.24	-13.00	32.24	V

**LTE FDD Band 14 Channel Bandwidth 5MHz\_16QAM\_Low Channel**

Frequency (MHz)	PMea (dBm)	Pcl (dB)	Diatance	Ga Antenna Gain(dB)	ERP (dBm)	Limit (dBm)	Margin (dB)	Polarization
1581	-54.73	4.02	3	12.21	-46.54	-40.00	6.54	H
2371.5	-47.45	5.11	3	13.26	-39.3	-13.00	26.3	H
1581	-59.62	4.02	3	12.21	-51.43	-40.00	11.43	V
2371.5	-53.74	5.11	3	13.26	-45.59	-13.00	32.59	V



LTE FDD Band 14\_Channel Bandwidth 5MHz\_16QAM\_Middle Channel

Frequency (MHz)	PMea (dBm)	Pcl (dB)	Diatance	Ga Antenna Gain(dB)	ERP (dBm)	Limit (dBm)	Margin (dB)	Polarization
1586	-53.47	4.02	3	12.21	-45.28	-40.00	5.28	H
2379	-47.72	5.11	3	13.26	-39.57	-13.00	26.57	H
1586	-58.47	4.02	3	12.21	-50.28	-40.00	10.28	V
2379	-53.31	5.11	3	13.26	-45.16	-13.00	32.16	V

LTE FDD Band 14\_Channel Bandwidth 5MHz\_16QAM\_High Channel

Frequency (MHz)	PMea (dBm)	Pcl (dB)	Diatance	Ga Antenna Gain(dB)	ERP (dBm)	Limit (dBm)	Margin (dB)	Polarization
1591	-55.34	4.02	3	12.21	-47.15	-40.00	7.15	H
2386.5	-47.29	5.11	3	13.26	-39.14	-13.00	26.14	H
1591	-59.06	4.02	3	12.21	-50.87	-40.00	10.87	V
2386.5	-53.19	5.11	3	13.26	-45.04	-13.00	32.04	V

LTE FDD Band 14\_Channel Bandwidth 10MHz\_16QAM\_Middle Channel

Frequency (MHz)	PMea (dBm)	Pcl (dB)	Diatance	Ga Antenna Gain(dB)	ERP (dBm)	Limit (dBm)	Margin (dB)	Polarization
1586	-54.31	4.02	3	12.21	-46.12	-40.00	6.12	H
2379	-46.48	5.11	3	13.26	-38.33	-13.00	25.33	H
1586	-58.51	4.02	3	12.21	-50.32	-40.00	10.32	V
2379	-53.69	5.11	3	13.26	-45.54	-13.00	32.54	V

The results shown in this test report refer only to the sample(s) tested unless otherwise stated and the sample(s) are retained for 30 days only. The document is issued by HUAK, this document cannot be reproduced except in full with our prior written permission. The more details and the authenticity of the report will be confirmed at <http://www.cer-mark.com>.

TEL : +86-755 2302 9901 FAX : +86-755 2302 9901 E-mail : service@cer-mark.com

Add: 1-2F., Building B2, Junfeng Zhongcheng Zhizao Innovation Park, Heping Community, Fuhai Street, Bao'an District, Shenzhen, Guangdong, China

### 3.6 Frequency Stability under Temperature & Voltage Variations

#### LIMIT

90.539 (c) The frequency stability of mobile, portable, and control transmitters operating in the narrowband segment must be 400 parts per billion or better when AFC is locked to the base station. When AFC is not locked to the base station, the frequency stability must be at least 1.0 ppm for 6.25 kHz, 1.5 ppm for 12.5 kHz (2 channel aggregate), and 2.5 ppm for 25 kHz (4 channel aggregate).

#### TEST CONFIGURATION

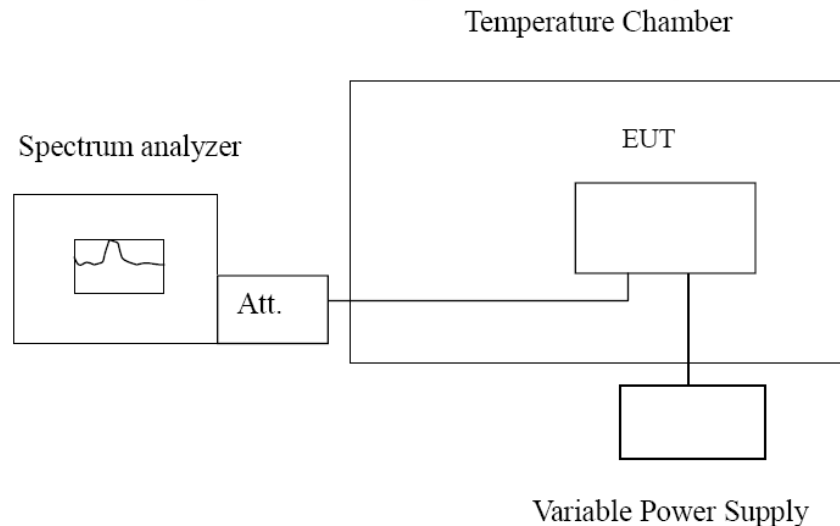

#### TEST PROCEDURE

The EUT was setup according to EIA/TIA 603D

##### **Frequency Stability Under Temperature Variations:**

In order to measure the carrier frequency under the condition of AFC lock, it is necessary to make measurements with the EUT in a "call mode". This is accomplished with the use of R&S CMW500 DIGITAL RADIO COMMUNICATION TESTER.

1. Measure the carrier frequency at room temperature.
2. Subject the EUT to overnight soak at -30°C.
3. With the EUT, powered via nominal voltage, connected to the CMW500 and in a simulated call on middle channel for LTE Band 14, measure the carrier frequency. These measurements should be made within 2 minutes of Powering up the EUT, to prevent significant self-warming.
4. Repeat the above measurements at 10°C increments from -30°C to +50°C. Allow at least 1.5 hours at each temperature, unpowered, before making measurements.
5. Re-measure carrier frequency at room temperature with nominal voltage. Vary supply voltage from minimum voltage to maximum voltage, in 0.1Volt increments re-measuring carrier frequency at each voltage. Pause at nominal voltage for 1.5 hours unpowered, to allow any self-heating to stabilize, before continuing.
6. Subject the EUT to overnight soak at +50°C.
7. With the EUT, powered via nominal voltage, connected to the CMW500 and in a simulated call on the centre channel, measure the carrier frequency. These measurements should be made within 2 minutes of Powering up the EUT, to prevent significant self-warming.
8. Repeat the above measurements at 10 °C increments from +50°C to -30°C. Allow at least 1.5 hours at each temperature, unpowered, before making measurements
9. At all temperature levels hold the temperature to +/- 0.5°C during the measurement procedure.

##### **Frequency Stability Under Voltage Variations:**

Set chamber temperature to 20°C. Use a variable AC power supply / DC power source to power the EUT and set the voltage to rated voltage. Set the spectrum analyzer RBW low enough to obtain the desired frequency resolution and recorded the frequency.



Reduce the input voltage to specify extreme voltage variation ( $\pm 15\%$ ) and endpoint, record the maximum frequency change.

**TEST RESULTS**

Remark:

1. We tested all RB Configuration refer 3GPP TS136 521 for each Channel Bandwidth of LTE Band 14; recorded worst case.

LTE Band 14, 10MHz bandwidth (worst case of all bandwidths)

**Frequency Error vs Voltage**

Voltage (V)	Frequency error (Hz)		Frequency error (ppm)	
	QPSK	16QAM	QPSK	16QAM
10.2	-3.15	-3.10	-0.003985	-0.003922
12.0	-2.57	-4.23	-0.003251	-0.005351
13.8	-4.89	-4.94	-0.006186	-0.006249

**Frequency Error vs Temperature**

Temperature (°C)	Frequency error (Hz)		Frequency error (ppm)	
	QPSK	16QAM	QPSK	16QAM
-30°	-5.06	-5.54	-0.006401	-0.007008
-20°	-4.88	-3.45	-0.006173	-0.004364
-10°	-3.02	-4.58	-0.003820	-0.005794
0°	-4.71	-4.05	-0.005958	-0.005123
10°	-4.41	-5.19	-0.005579	-0.006565
20°	-3.56	-4.21	-0.004503	-0.005326
30°	-1.96	-4.16	-0.002479	-0.005262
40°	-2.96	-5.25	-0.003744	-0.006641
50°	-4.56	-5.15	-0.005769	-0.006515



## 4 Test Setup Photos of the EUT

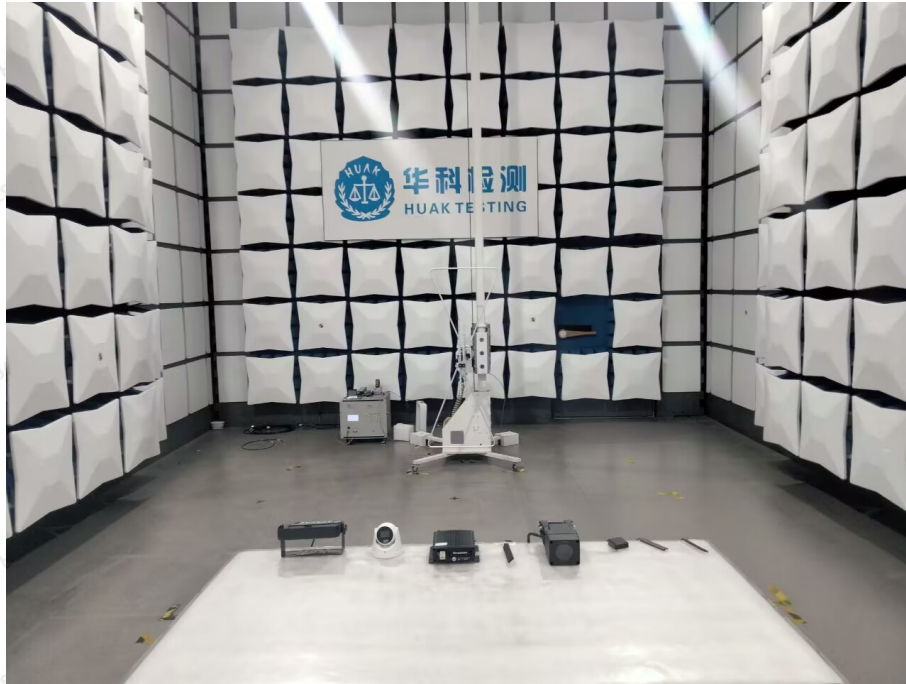

The results shown in this test report refer only to the sample(s) tested unless otherwise stated and the sample(s) are retained for 30 days only. The document is issued by HUAK, this document cannot be reproduced except in full with our prior written permission. The more details and the authenticity of the report will be confirmed at <http://www.cer-mark.com>.

TEL : +86-755 2302 9901 FAX : +86-755 2302 9901 E-mail : [service@cer-mark.com](mailto:service@cer-mark.com)

Addr: 1-2F., Building B2, Junfeng Zhongcheng Zhizao Innovation Park, Heping Community, Fuhai Street, Bao'an District, Shenzhen, Guangdong, China





## **5 PHOTOS OF THE EUT**

Reference to the report: ANNEX A of external photos and ANNEX B of internal photos

**\*\*\*\*\* End of Report \*\*\*\*\***