



**FCC Part 22 Test Report
Part 22H Subpart E**

Report Reference No. : HK2402210730-7E

FCC ID : 2AM6L-M1N2

Compiled by
(position+printedname+signature).. : File administrators Len Liao

Len Liao

Supervised by
(position+printedname+signature)... : Technique principal Sliver Wan

Sliver Wan

Approved by
(position+printedname+signature)... : Manager Jason Zhou

Jason Zhou

Date of issue : Mar. 07, 2024

Testing Laboratory Name : **Shenzhen HUAK Testing Technology Co., Ltd.**

Address : 1-2/F., Building B2, Junfeng Zhongcheng Zhizao Innovation Park,
Heping, Fuhai Street, Bao'an District, Shenzhen, Guangdong, China

Applicant's name : **Streamax Technology Co., Ltd.**

Address : 21-23/F, Building B1, Zhiyuan, No. 1001, Xueyuan Avenue, Nanshan
District, Shenzhen, Guangdong 518055, China

Test specification :

Standard : **FCC CFR Title 47 Part 2, Part 22H**

TRF Originator : Shenzhen HUAK Testing Technology Co., Ltd.

Shenzhen HUAK Testing Technology Co., Ltd. All rights reserved.

This publication may be reproduced in whole or in part for non-commercial purposes as long as the Shenzhen HUAK Testing Technology Co., Ltd. as copyright owner and source of the material. Shenzhen HUAK Testing Technology Co., Ltd. takes no responsibility for and will not assume liability for damages resulting from the reader's interpretation of the reproduced material due to its placement and context.

Test item description..... : MDVR

Trade Mark..... : N/A

Manufacturer : **Streamax Technology Co., Ltd.**

Model/Type reference : M1N 2.0

Series Models : N/A

Modulation Type : QPSK, 16QAM

Rating..... : DC 12V from DC Power

Hardware version..... : V1.0

Software version : V1.0

Result..... : **PASS**



TEST REPORT

Test Report No. :	HK2402210730-7E	Mar. 07, 2024
		Date of issue

Equipment under Test : MDVR

Model /Type : M1N 2.0

Series Models : N/A

Applicant : **Streamax Technology Co., Ltd.**

Address : 21-23/F, Building B1, Zhiyuan, No. 1001, Xueyuan Avenue, Nanshan District, Shenzhen, Guangdong 518055, China

Manufacturer : **Streamax Technology Co., Ltd.**

Address : 21-23/F, Building B1, Zhiyuan, No. 1001, Xueyuan Avenue, Nanshan District, Shenzhen, Guangdong 518055, China

Test Result:	PASS
---------------------	-------------

The test report merely corresponds to the test sample.
It is not permitted to copy extracts of these test result without the written permission of the test laboratory.



Contents

1	<u>Test Standards</u>	<u>5</u>
2	<u>Summary</u>	<u>6</u>
2.1	General Remarks	6
2.2	Product Description	6
2.3	Equipment under Test	6
2.4	Normal Accessory Setting	7
2.5	EUT Configuration	7
2.6	Related Submittal(s) / Grant (s)	7
2.7	Modifications	7
2.8	General Test Conditions/Configurations	7
3	<u>Test Environment</u>	<u>8</u>
3.1	Information of the Test Laboratory	8
3.2	Environmental Conditions	8
3.3	Test Description	8
3.4	Equipments Used During The Test	9
4	<u>Test Conditions and Results</u>	<u>10</u>
4.1	Output Power	10
4.2	Peak-to-Average Ratio (PAR)	15
4.3	Occupied Bandwidth and Emission Bandwidth	20
4.4	Band Edge Compliance	25
4.5	Spurious Emission on Antenna Port	30
4.6	Radiated Spurious Emission	43
4.7	Frequency Stability	49
5	<u>Test Setup Photos of the EUT</u>	<u>51</u>
6	<u>External and Internal photos of the EUT</u>	<u>52</u>



**** Modified History ****

Revision	Description	Issued Data	Remark
Revision 1.0	Initial Test Report Release	Mar. 07, 2024	Jason Zhou



1 Test Standards

The tests were performed according to following standards:

[FCC Part 2](#): Frequency Allocations And Radio Treaty Matters; General Rules And Regulations.

[FCC Part 22 Subpart H](#): Private Land Mobile Radio Services.

[ANSI/TIA-603-E-2016](#): Land Mobile FM or PM Communications Equipment Measurement and Performance Standards.

[ANSI C63.26-2015](#): IEEE/ANSI Standard for Compliance Testing of Transmitters Used in Licensed Radio Services.

[FCC KDB 971168D01 v03r01](#) Power Meas License Digital Systems.



2 Summary

2.1 General Remarks

Date of receipt of test sample	:	Feb. 21, 2024
Testing commenced on	:	Feb. 21, 2024
Testing concluded on	:	Mar. 07, 2024

2.2 Product Description

Name of EUT:	MDVR
Model/Type reference:	M1N 2.0
Series Models:	N/A
Power supply:	DC12V from DC Power
Modulation Type:	QPSK,16QAM
Antenna type:	External Antenna
Antenna gain:	2dBi
Operation Frequency Band:	LTE BAND 5
Operation frequency:	LTE BAND 5:824~849 MHz
LTE Release:	R8
Extreme temp. Tolerance:	-30°C to +50°C
Extreme vol. Limits:	10.2VDC to 13.8VDC (nominal: 12VDC)

2.3 Equipment under Test

Power supply system utilised

Power supply voltage	:	<input type="radio"/> 120V/ 60 Hz	<input type="radio"/> 115V/60Hz
		<input checked="" type="radio"/> 12 V DC	<input type="radio"/> 24 V DC
		<input type="radio"/> Other (specified in blank below)	



2.4 Normal Accessory Setting

Fully charged battery was used during the test.

2.5 EUT Configuration

The following peripheral devices and interface cables were connected during the measurement:

- - supplied by the manufacturer
- - supplied by the lab

<input type="radio"/>	Power Cable	Length (m) :	/
		Shield :	/
		Detachable :	/
<input type="radio"/>	Multimeter	Manufacturer :	/
		Model No. :	/

2.6 Related Submittal(s) / Grant (s)

This submittal(s) (test report) is intended filing to comply with FCC Part 22H, Rules.

2.7 Modifications

No modifications were implemented to meet testing criteria.

2.8 General Test Conditions/Configurations

2.10.1 Test Environment

Environment Parameter	Selected Values During Tests	
Relative Humidity	Ambient	
Temperature	TN	Ambient
Voltage	VL	10.2V
	VN	5.0V
	VH	13.8V

NOTE: VL=lower extreme test voltage VN=nominal voltage VH=upper extreme test voltage TN=normal temperature



3 Test Environment

3.1 Information of the Test Laboratory

Shenzhen HUAKE Testing Technology Co., Ltd.
Add.: 1-2/F., Building B2, Junfeng Zhongcheng Zhizao Innovation Park, Heping,
Fuhai Street, Bao'an District, Shenzhen, Guangdong, China

Testing Laboratory Authorization:

A2LA Accreditation Code is 4781.01.
FCC Designation Number is CN1229.
Canada IC CAB identifier is CN0045.
CNAS Registration Number is L9589.

3.2 Environmental Conditions

During the measurement the environmental conditions were within the listed ranges:

Temperature:	15-35 ° C
Humidity:	30-60 %
Atmospheric pressure:	950-1050mbar

3.3 Test Description

Band 5 (824~849 MHz)

Test Item	FCCRuleNo.	Requirements	Verdict
Effective(Isotropic) Radiated Output Power	§2.1046, §22.913(a)(2)	EIRP ≤ 2W	Pass
Peak-Average Ratio	§24.232(d)	FCC:Limit≤13dB	Pass
Modulation Characteristics	§2.1047	Digital modulation	Pass
Bandwidth	§2.1049	OBW: Nolimit. EBW: Nolimit.	Pass
Band Edges Compliance	§2.1051, §24.238	≤ -13dBm/1%*EBW, In1MHz bands immediately outside and adjacent to Thefrequency block.	Pass
Spurious Emission at AntennaTerminals	§2.1051, §24.238	≤-13dBm/1MHz, from9kHz to 10th harmonics but outside authorized Operating frequency ranges.	Pass
Field Strength of Spurious Radiation	Clause 7of KDB971168 D01 v02r02	≤ -13dBm/1MHz.	Pass
Frequency Stability	§2.1055, §22.355, §24.235	FCC:within authorized frequency block.	Pass

NOTE 1:For the verdict, the "N/A" denotes "not applicable", the "N/T" denotes "nottested".

Remark:

1. The measurement uncertainty is not included in the test result.



3.4 Equipments Used During The Test

Test Equipment	Manufacturer	Model No.	Serial No.	Calibration Date	Calibration Due Date
LISN	R&S	ENV216	HKE-059	2024/02/20	2025/02/19
LISN	R&S	ENV216	HKE-002	2024/02/20	2025/02/19
Receiver	R&S	ESR-7	HKE-010	2024/02/20	2025/02/19
Spectrum analyzer	R&S	FSP40	HKE-025	2024/02/20	2025/02/19
Spectrum analyzer	Agilent	N9020A	HKE-048	2024/02/20	2025/02/19
RF automatic control unit	Tonscend	JS0806-1	HKE-060	2024/02/20	2025/02/19
Loop antenna	Schwarzbeck	FMZB 1519 B	HKE-014	2024/02/21	2026/02/20
Bilog Broadband Antenna	Schwarzbeck	VULB9163	HKE-012	2024/02/20	2026/02/19
Horn antenna	Schwarzbeck	9120D	HKE-013	2024/02/21	2026/02/20
High gain antenna	Schwarzbeck	LB-180400KF	HKE-054	2024/02/21	2026/02/20
Preamplifier	EMCI	EMC051845SE	HKE-015	2024/02/20	2025/02/19
Preamplifier	Agilent	83051A	HKE-016	2024/02/20	2025/02/19
Preamplifier	Schwarzbeck	BBV 9743	HKE-006	2024/02/20	2025/02/19
Temperature and humidity meter	Boyang	HTC-1	HKE-075	2024/02/20	2025/02/19
High-low temperature chamber	Guangke	HT-80L	HKE-118	2024/02/20	2025/02/19
High pass filter unit	Tonscend	JS0806-F	HKE-055	2024/02/20	2025/02/19
RF Cable(below1GHz)	Times	9kHz-1GHz	HKE-117	2024/02/20	2025/02/19
RF Cable(above 1GHz)	Times	1-40G	HKE-034	2024/02/20	2025/02/19
Power meter	Agilent	E4419B	HKE-085	2024/02/20	2025/02/19
Power Sensor	Agilent	E9300A	HKE-086	2024/02/20	2025/02/19
Conducted test software	Tonscend	TS+ Rev 2.5.0.0	HKE-081	N/A	N/A
Radiated test software	Tonscend	TS+ Rev 2.5.0.0	HKE-082	N/A	N/A
RF test software	Tonscend	JS1120-B Version 2.6	HKE-083	N/A	N/A
RF test software	Tonscend	JS1120-4	HKE-113	N/A	N/A
RF test software	Tonscend	JS1120-3	HKE-114	N/A	N/A
RF test software	Tonscend	JS1120-1	HKE-115	N/A	N/A
Wireless Communication Test Set	R&S	CMW500	HKE-026	2024/02/20	2025/02/19
Wireless Communication Test Set	R&S	CMU200	HKE-029	2024/02/20	2025/02/19
High gain antenna	Schwarzbeck	LB-180400KF	HKE-054	2024/02/21	2026/02/20
Horn antenna	Schwarzbeck	9120D	HKE-135	2024/02/21	2026/02/20
High gain antenna	Schwarzbeck	LB-180400KF	HKE-128	2024/02/21	2026/02/20
Broadband antenna	Schwarzbeck	VULB 9163	HKE-087	2024/02/21	2026/02/20
Signal generator	Agilent	E4433B	HKE-120	2024/02/20	2025/02/19
Signal generator	Agilent	E4421B	HKE-121	2024/02/20	2025/02/19

The results shown in this test report refer only to the sample(s) tested unless otherwise stated and the sample(s) are retained for 30 days only. The document is issued by HUAKE, this document cannot be reproduced except in full with our prior written permission. The more details and the authenticity of the report will be confirmed at <http://www.cer-mark.com>.

TEL : +86-755 2302 9901 FAX : +86-755 2302 9901 E-mail : service@cer-mark.com

Add: 1-2F., Building B2, Junfeng Zhongcheng Zhizao Innovation Park, Heping Community, Fuhai Street, Bao'an District, Shenzhen, Guangdong, China



4 Test Conditions and Results

4.1 Output Power

4.1.1 Conducted Output Power

TEST APPLICABLE

During the process of testing, the EUT was controlled via R&S Digital Radio Communication tester (CMW500) to ensure max power transmission and proper modulation. This result contains output power and EIRP measurements for the EUT. In all cases, output power is within the specified limits.

TEST CONFIGURATION

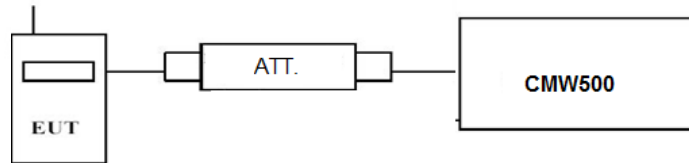

TEST PROCEDURE

Conducted Power Measurement:

- Place the EUT on a bench and set it in transmitting mode.
- Connect a low loss RF cable from the antenna port to a CMW500 by an Att.
- EUT Communicate with CMW500 then selects a channel for testing.
- Add a correction factor to the display CMW500, and then test.

TEST RESULTS

compliance *

Remark:

- We measured all RB Configuration refer 3GPP TS136 521 for each Channel Bandwidth of LTE FDD Band 5;

LTE FDD Band 5				
TX Channel Bandwidth	Frequency (MHz)	RB Size/Offset	Burst Average Power [dBm]	
			QPSK	16QAM
1.4 MHz	824.7	1 RB low	23.86	23.09
		1 RB high	24.04	23.45
		50% RB mid	23.97	23.31
		100% RB	23.98	22.86
	836.5	1 RB low	24.00	22.78
		1 RB high	23.91	22.82
		50% RB mid	23.06	22.20
		100% RB	24.43	23.73
	848.3	1 RB low	24.45	23.48
		1 RB high	24.21	23.43
		50% RB mid	24.39	23.18
		100% RB	24.46	23.07
3 MHz	825.5	1 RB low	23.80	22.87
		1 RB high	23.99	23.05
		50% RB mid	23.92	22.97
		100% RB	23.03	22.08
	836.5	1 RB low	23.01	22.10
		1 RB high	23.11	22.09

The results shown in this test report refer only to the sample(s) tested unless otherwise stated and the sample(s) are retained for 30 days only. The document is issued by HUAKE, this document cannot be reproduced except in full with our prior written permission. The more details and the authenticity of the report will be confirmed at <http://www.cer-mark.com>.



	847.5	50% RB mid	23.04	22.20
		100% RB	24.29	23.43
		1 RB low	24.13	23.20
		1 RB high	24.14	23.26
		50% RB mid	23.37	22.34
		100% RB	23.34	22.33
5 MHz	826.5	1 RB low	23.90	23.03
		1 RB high	24.14	23.27
		50% RB mid	24.14	23.23
		100% RB	23.20	22.08
	836.5	1 RB low	23.18	22.06
		1 RB high	23.29	22.21
		50% RB mid	23.07	22.22
		100% RB	24.44	23.33
	846.5	1 RB low	24.34	23.27
		1 RB high	24.45	23.53
		50% RB mid	23.51	22.31
		100% RB	23.44	22.30
10 MHz	829.0	1 RB low	23.86	22.99
		1 RB high	24.27	23.73
		50% RB mid	24.43	23.42
		100% RB	23.24	22.18
	836.5	1 RB low	23.17	22.28
		1 RB high	23.38	22.41
		50% RB mid	23.34	22.29
		100% RB	24.42	23.73
	844.0	1 RB low	24.48	23.58
		1 RB high	24.37	23.58
		50% RB mid	23.49	22.32
		100% RB	23.43	22.57

The results shown in this test report refer only to the sample(s) tested unless otherwise stated and the sample(s) are retained for 30 days only. The document is issued by HUAK, this document cannot be reproduced except in full with our prior written permission. The more details and the authenticity of the report will be confirmed at <http://www.cer-mark.com>.

TEL : +86-755 2302 9901 FAX : +86-755 2302 9901 E-mail : service@cer-mark.com

Add: 1-2F., Building B2, Junfeng Zhongcheng Zhizao Innovation Park, Heping Community, Fuhai Street, Bao'an District, Shenzhen, Guangdong, China

4.1.2. Radiated Output Power

LIMIT

This is the test for the maximum radiated power from the EUT.

Rule Part 22H.232(b) specifies, "Mobile/portable stations are limited to 7 watts e.i.r.p.

TEST CONFIGURATION

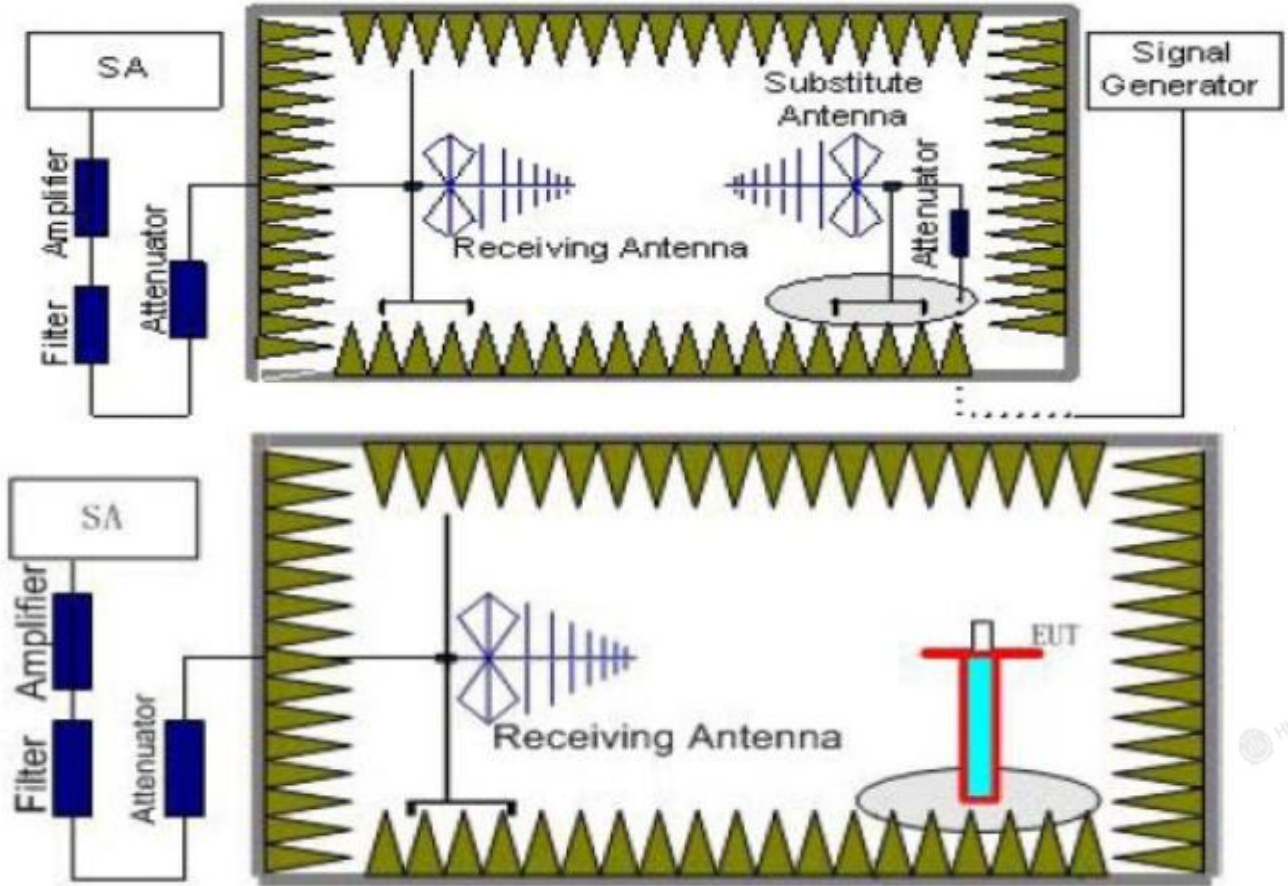

TEST PROCEDURE

1. EUT was placed on a 0.1 meter high non-conductive stand at a 3 meter test distance from the receive antenna. A receiving antenna was placed on the antenna mast 3 meters from the EUT for emission measurements. The height of receiving antenna is 0.1m. Detected emissions were maximized at each frequency by rotating the EUT through 360° and adjusting the receiving antenna polarization. The radiated emission measurements of all transmit frequencies in three channels (High, Middle, Low) were measured with peak detector.
2. A log-periodic antenna or double-ridged waveguide horn antenna shall be substituted in place of the EUT. The log-periodic antenna will be driven by a signal generator and the level will be adjusted till the same power value on the spectrum analyzer or receiver. The level of the spurious emissions can be calculated through the level of the signal generator, cable loss, the gain of the substitution antenna and the reading of the spectrum analyzer or receiver.
3. The EUT is then put into continuously transmitting mode at its maximum power level during the test. Set Test Receiver or Spectrum RBW=1MHz, VBW=3MHz, And the maximum value of the receiver should be recorded as (P_r).
4. The EUT shall be replaced by a substitution antenna. In the chamber, a substitution antenna for the frequency band of interest is placed at the reference point of the chamber. An RF Signal source for the frequency band of interest is connected to the substitution antenna with a cable that has been constructed to not interfere with the radiation pattern of the antenna. A power (P_{Mea}) is applied to the input of the substitution antenna, and adjust the level of the signal generator output until the value of the receiver.



- reach the previously recorded (P_r). The power of signal source (P_{Mea}) is recorded. The test should be performed by rotating the test item and adjusting the receiving antenna polarization.
- A amplifier should be connected to the Signal Source output port. And the cable should be connect between the Amplifier and the Substitution Antenna. The cable loss (P_{cl}), the Substitution Antenna Gain (G_a) and the Amplifier Gain (P_{Ag}) should be recorded after test.
The measurement results are obtained as described below: $Power(EIRP)=P_{Mea}-P_{Ag}-P_{cl}+G_a$
We used SMF100A microwave signal generator which signal level can up to 33dBm,so we not used power Amplifier for substitution test; The measurement results are amend as described below:
 $Power(EIRP)=P_{Mea}-P_{cl}+G_a$
- This value is EIRP since the measurement is calibrated using an antenna of known gain (2.15 dBi) and known input power.
- ERP can be calculated from EIRP by subtracting the gain of the dipole, $ERP = EIRP-2.15dBi$.

TEST RESULTS

Radiated Measurement:

Remark:

- We measured all RB Configuration refer 3GPP TS136 521 for each Channel Bandwidth of LTE FDD Band 5; recorded worst case for each Channel Bandwidth of LTE FDD Band 5.
- $EIRP=P_{Mea}(dBm)-P_{cl}(dB)+P_{Ag}(dB)+G_a(dBi)$
- We measured both Horizontal and Vertical direction, recorded worst case direction.

LTE FDDBand 5_Channel Bandwidth 1.4MHz_QPSK

Frequency (MHz)	P_{Mea} (dBm)	P_{cl} (dB)	G_a Antenna Gain(dB)	P_{Aq} (dB)	EIRP (dBm)	ERP (dBm)	Limit (dBm)	Margin (dB)	Polarization
824.7	-18.55	2.42	8.45	36.82	24.3	22.15	38.45	16.3	V
836.5	-17.19	3.46	8.45	36.82	24.62	22.47	38.45	15.98	V
848.3	-19.66	2.53	8.36	36.82	22.99	20.84	38.45	17.61	V

LTE FDDBand 5_Channel Bandwidth 3MHz_QPSK

Frequency (MHz)	P_{Mea} (dBm)	P_{cl} (dB)	G_a Antenna Gain(dB)	P_{Aq} (dB)	EIRP (dBm)	ERP (dBm)	Limit (dBm)	Margin (dB)	Polarization
825.5	-18.21	2.42	8.45	36.82	24.64	22.49	38.45	15.96	V
836.5	-16.64	3.46	8.45	36.82	25.17	23.02	38.45	15.43	V
847.5	-18.94	2.53	8.36	36.82	23.71	21.56	38.45	16.89	V

LTE FDD Band 5_Channel Bandwidth 5MHz_QPSK

Frequency (MHz)	P_{Mea} (dBm)	P_{cl} (dB)	G_a Antenna Gain(dB)	P_{Aq} (dB)	EIRP (dBm)	ERP (dBm)	Limit (dBm)	Margin (dB)	Polarization
826.5	-18.47	2.42	8.45	36.82	24.38	22.23	38.45	16.22	V
836.5	-16.53	3.46	8.45	36.82	25.28	23.13	38.45	15.32	V
846.5	-19.94	2.53	8.36	36.82	22.71	20.56	38.45	17.89	V

LTE FDD Band 5_Channel Bandwidth 10MHz_QPSK

Frequency (MHz)	P_{Mea} (dBm)	P_{cl} (dB)	G_a Antenna Gain(dB)	P_{Aq} (dB)	EIRP (dBm)	ERP (dBm)	Limit (dBm)	Margin (dB)	Polarization
829.0	-18.17	2.42	8.45	36.82	24.68	22.53	38.45	15.92	V
836.5	-15.47	3.46	8.45	36.82	26.34	24.19	38.45	14.26	V
844.0	-17.51	2.53	8.36	36.82	25.14	22.99	38.45	15.46	V

The results shown in this test report refer only to the sample(s) tested unless otherwise stated and the sample(s) are retained for 30 days only. The document is issued by HUAKE, this document cannot be reproduced except in full with our prior written permission. The more details and the authenticity of the report will be confirmed at <http://www.cer-mark.com>.



LTE FDD Band 5_Channel Bandwidth 1.4MHz_16QAM

Frequency (MHz)	P _{Mea} (dBm)	P _{cl} (dB)	G _a Antenna Gain(dB)	P _{Aq} (dB)	EIRP (dBm)	ERP (dBm)	Limit (dBm)	Margin (dB)	Polarization
824.7	-18.75	2.42	8.45	36.82	24.1	21.95	38.45	16.5	V
836.5	-17.1	3.46	8.45	36.82	24.71	22.56	38.45	15.89	V
848.3	-19.01	2.53	8.36	36.82	23.64	21.49	38.45	16.96	V

LTE FDD Band 5_Channel Bandwidth 3MHz_16QAM

Frequency (MHz)	P _{Mea} (dBm)	P _{cl} (dB)	G _a Antenna Gain(dB)	P _{Aq} (dB)	EIRP (dBm)	ERP (dBm)	Limit (dBm)	Margin (dB)	Polarization
825.5	-17.94	2.42	8.45	36.82	24.91	22.76	38.45	15.69	V
836.5	-16.69	3.46	8.45	36.82	25.12	22.97	38.45	15.48	V
847.5	-19.35	2.53	8.36	36.82	23.3	21.15	38.45	17.3	V

LTE FDD Band 5_Channel Bandwidth 5MHz_16QAM

Frequency (MHz)	P _{Mea} (dBm)	P _{cl} (dB)	G _a Antenna Gain(dB)	P _{Aq} (dB)	EIRP (dBm)	ERP (dBm)	Limit (dBm)	Margin (dB)	Polarization
826.5	-17.69	2.42	8.45	36.82	25.16	23.01	38.45	15.44	V
836.5	-17.37	3.46	8.45	36.82	24.44	22.29	38.45	16.16	V
846.5	-17.81	2.53	8.36	36.82	24.84	22.69	38.45	15.76	V

LTE FDD Band 5_Channel Bandwidth 10MHz_16QAM

Frequency (MHz)	P _{Mea} (dBm)	P _{cl} (dB)	G _a Antenna Gain(dB)	P _{Aq} (dB)	EIRP (dBm)	ERP (dBm)	Limit (dBm)	Margin (dB)	Polarization
829.0	-17.58	2.42	8.45	36.82	25.27	23.12	38.45	15.33	V
836.5	-17.19	3.46	8.45	36.82	24.62	22.47	38.45	15.98	V
844.0	-18.47	2.53	8.36	36.82	24.18	22.03	38.45	16.42	V

The results shown in this test report refer only to the sample(s) tested unless otherwise stated and the sample(s) are retained for 30 days only. The document is issued by HUAK, this document cannot be reproduced except in full with our prior written permission. The more details and the authenticity of the report will be confirmed at <http://www.cer-mark.com>.

TEL : +86-755 2302 9901 FAX : +86-755 2302 9901 E-mail : service@cer-mark.com

Add: 1-2F., Building B2, Junfeng Zhongcheng Zhizao Innovation Park, Heping Community, Fuhai Street, Bao'an District, Shenzhen, Guangdong, China



4.2 Peak-to-Average Ratio (PAR)

LIMIT

The Peak-to-Average Ratio (PAR) of the transmission may not exceed 13 dB.

TEST CONFIGURATION

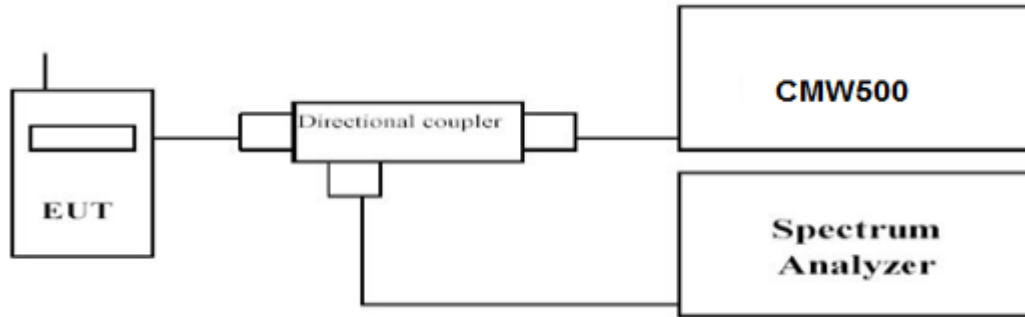

TEST PROCEDURE

1. Refer to instrument's analyzer instruction manual for details on how to use the power statistics/CCDF function;
2. Set resolution/measurement bandwidth \geq signal's occupied bandwidth;
3. Set the number of counts to a value that stabilizes the measured CCDF curve;
4. Set the measurement interval as follows:
 - 1). for continuous transmissions, set to 1 ms;
 - 2). for burst transmissions, employ an external trigger that is synchronized with the EUT burst timing sequence, or use the internal burst trigger with a trigger level that allows the burst to stabilize and set the measurement interval to a time that is less than or equal to the burst duration.
5. Record the maximum PAPR level associated with a probability of 0.1%.

TEST RESULTS

Remark:

1. We measured all RB Configuration refer 3GPP TS136 521 for each Channel Bandwidth of LTE FDD Band 5; recorded worst case for each Channel Bandwidth of LTE FDD Band 5.

LTE FDD Band 5				
TX Channel Bandwidth	Frequency (MHz)	RB Size/Offset	PAPR(dB)	
			QPSK	16QAM
1.4 MHz	824.7	1RB#0	4.58	4.93
	836.5		4.48	5.48
	848.3		4.19	6.49
3 MHz	825.5	1RB#0	4.00	5.93
	836.5		7.26	5.48
	847.5		4.10	8.23
5 MHz	826.5	1RB#0	4.08	4.96
	836.5		4.53	8.71
	846.5		8.41	8.42
10 MHz	829.0	1RB#0	4.07	5.29
	836.5		4.49	5.49
	844.0		3.92	4.85

The results shown in this test report refer only to the sample(s) tested unless otherwise stated and the sample(s) are retained for 30 days only. The document is issued by HUAK, this document cannot be reproduced except in full with our prior written permission. The more details and the authenticity of the report will be confirmed at <http://www.cer-mark.com>.



LTE FDD Band 5- 1.4 MHz Channel BandwidthPAPR

QPSK

16QAM

Low Channel

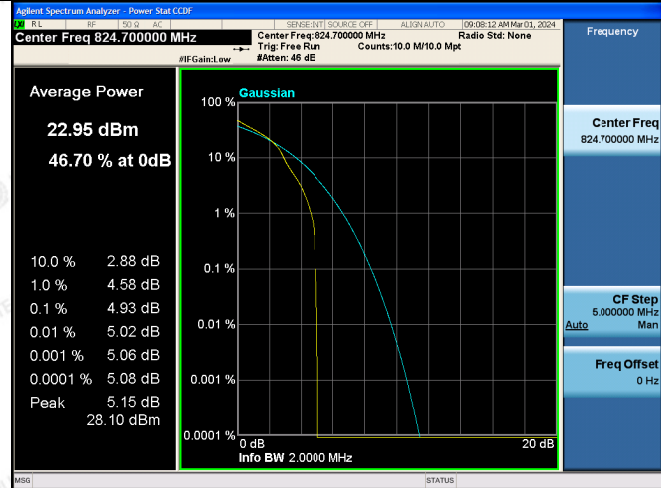
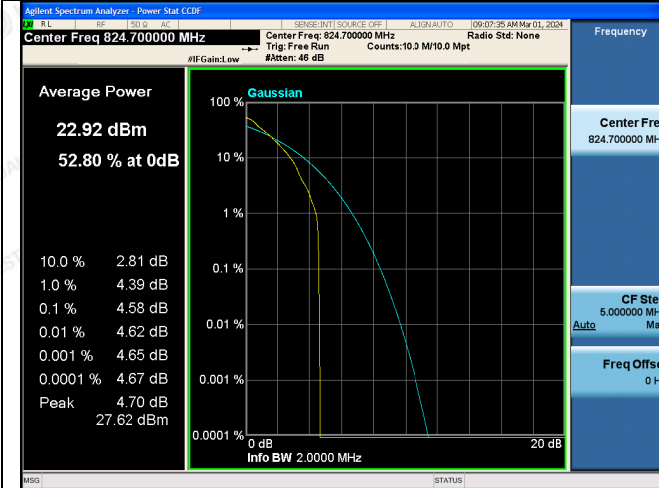

1RB#0

1RB#0

Middle Channel

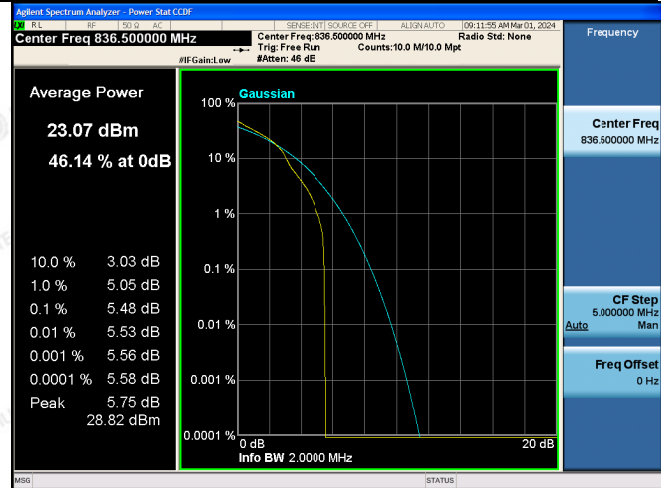
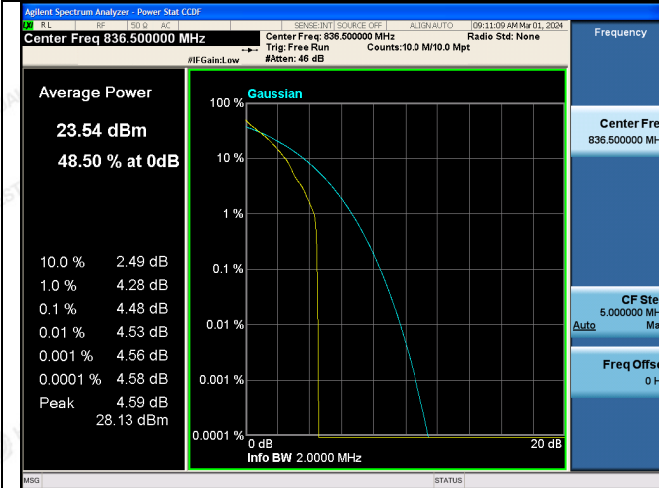

1RB#0

1RB#0

High Channel

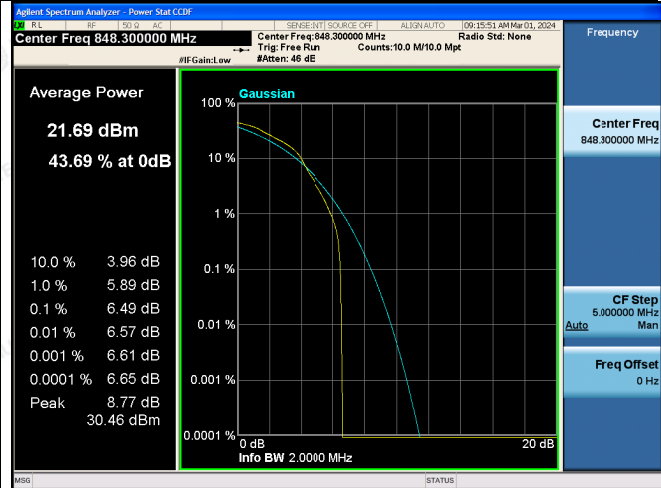
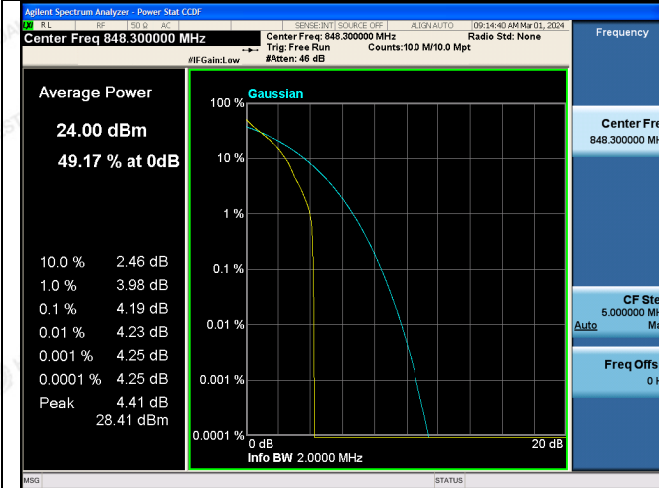

1RB#0

1RB#0

The results shown in this test report refer only to the sample(s) tested unless otherwise stated and the sample(s) are retained for 30 days only. The document is issued by HUAKE, this document cannot be reproduced except in full with our prior written permission. The more details and the authenticity of the report will be confirmed at http://www.cer-mark.com.

TEL : +86-755 2302 9901 FAX : +86-755 2302 9901 E-mail : service@cer-mark.com

Add: 1-2F., Building B2, Junfeng Zhongcheng Zhizao Innovation Park, Heping Community, Fuhai Street, Bao'an District, Shenzhen, Guangdong, China



LTE FDD Band 5-3MHz Channel BandwidthPAPR

QPSK

16QAM

Low Channel

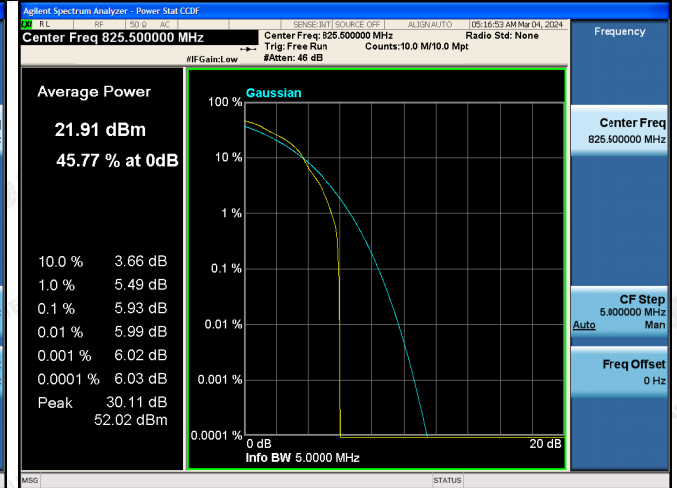
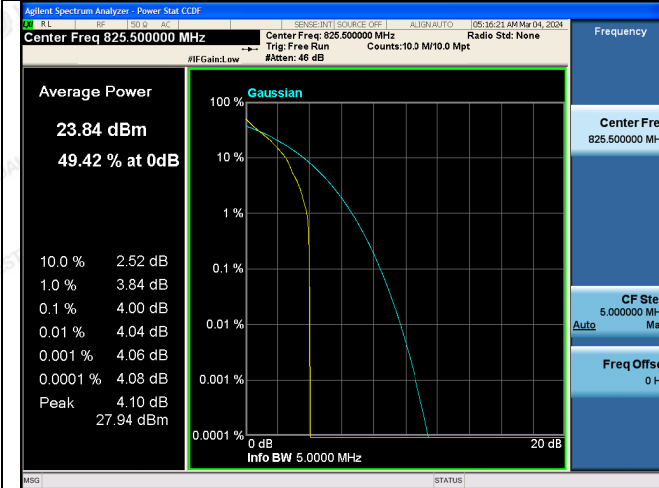

1RB#0

1RB#0

Middle Channel

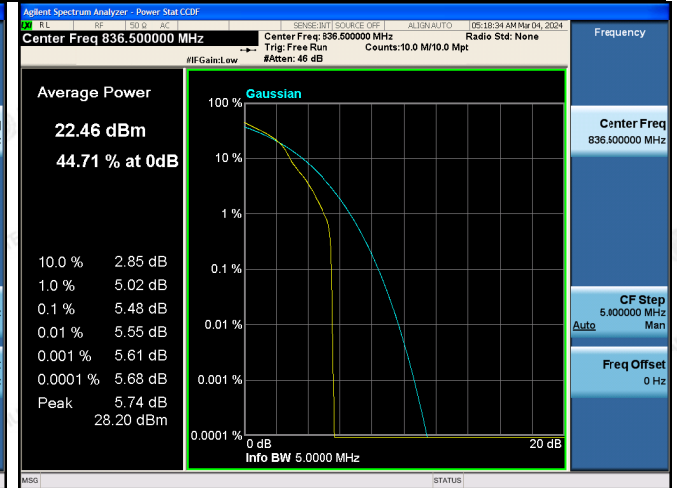
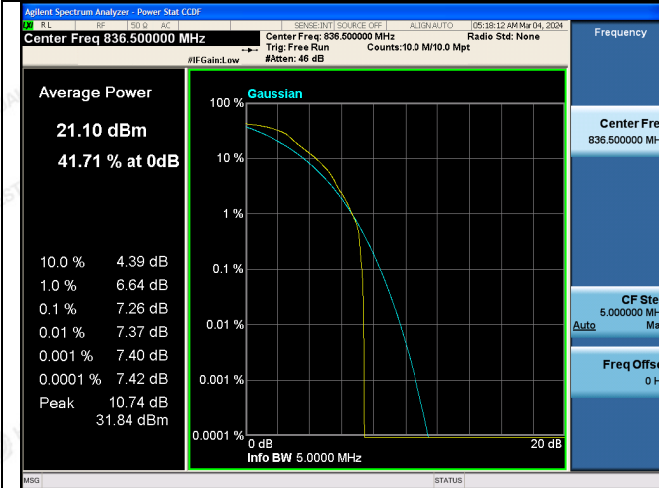

1RB#0

1RB#0

High Channel

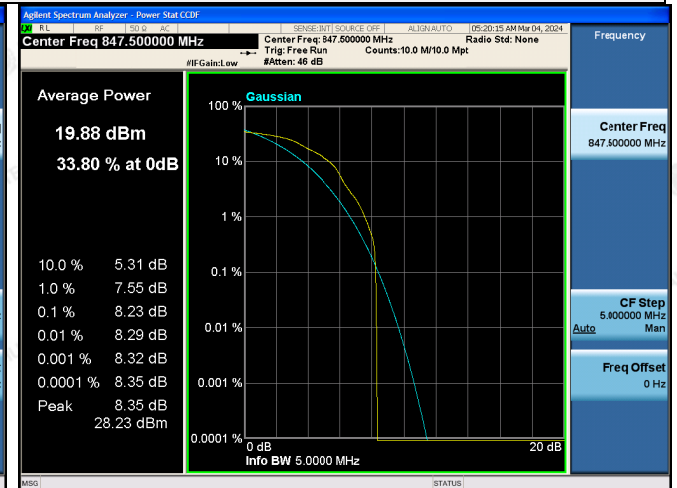
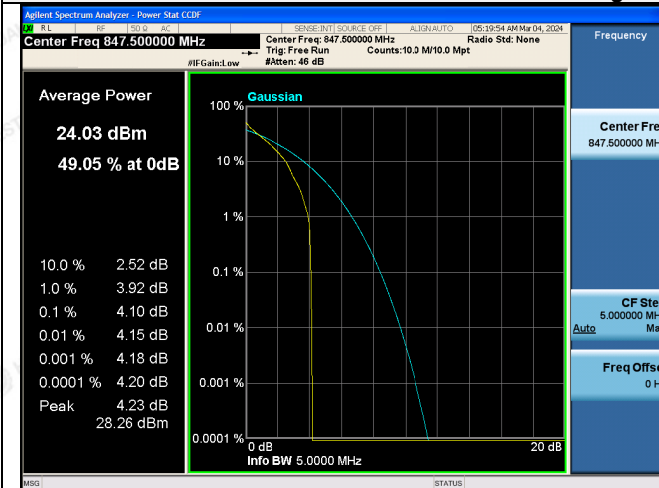

1RB#0

1RB#0

The results shown in this test report refer only to the sample(s) tested unless otherwise stated and the sample(s) are retained for 30 days only. The document is issued by HUAJ, this document cannot be reproduced except in full with our prior written permission. The more details and the authenticity of the report will be confirmed at http://www.cer-mark.com.

TEL : +86-755 2302 9901 FAX : +86-755 2302 9901 E-mail : service@cer-mark.com

Add: 1-2F., Building B2, Junfeng Zhongcheng Zhizao Innovation Park, Heping Community, Fuhai Street, Bao'an District, Shenzhen, Guangdong, China



LTE FDD Band 5-5MHz Channel BandwidthPAPR

QPSK

16QAM

Low Channel

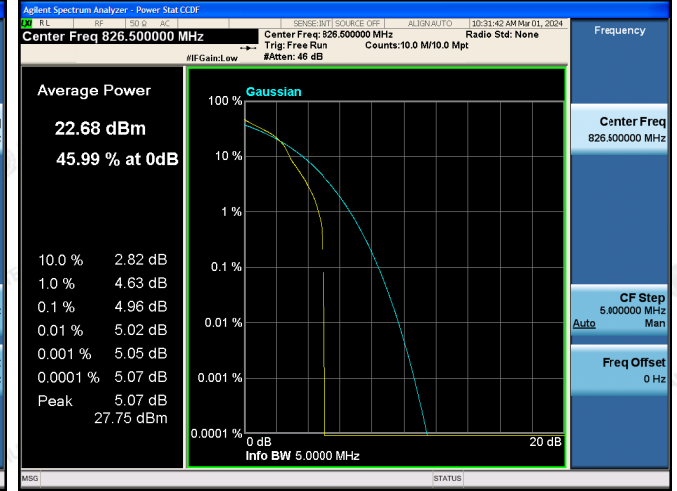
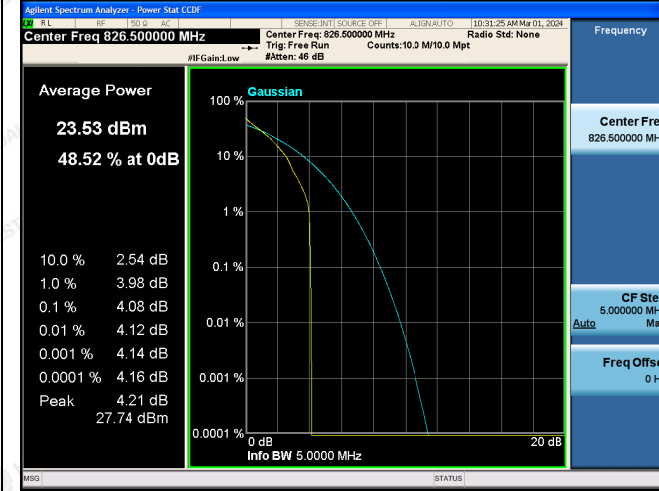

1RB#0

1RB#0

Middle Channel

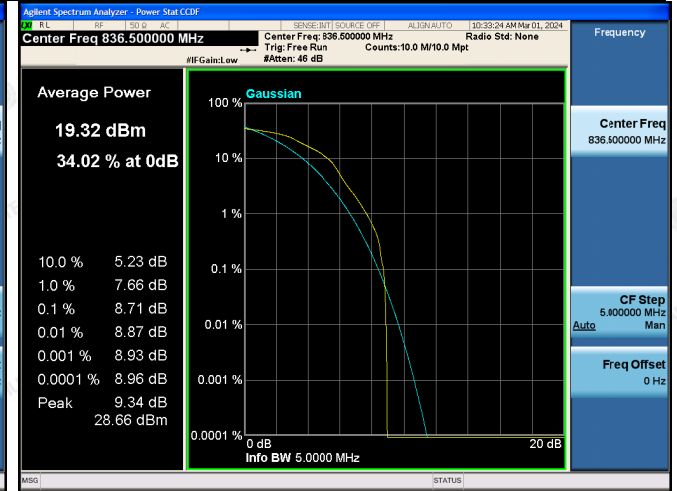
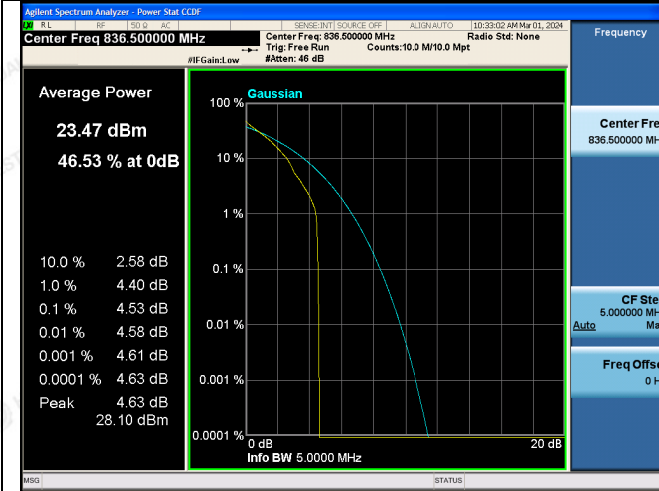

1RB#0

1RB#0

High Channel

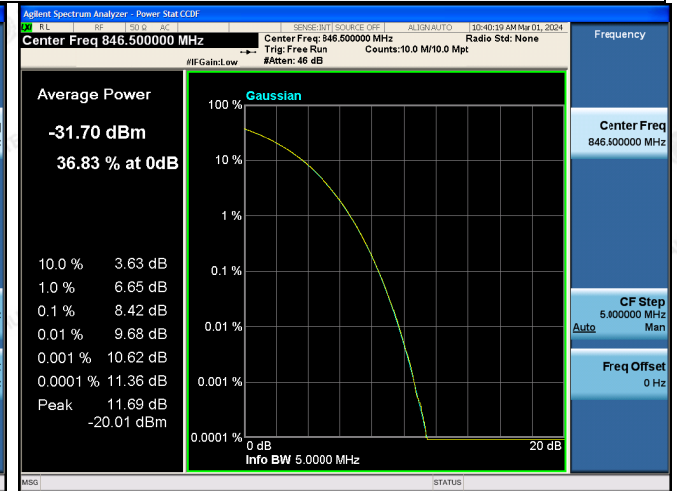
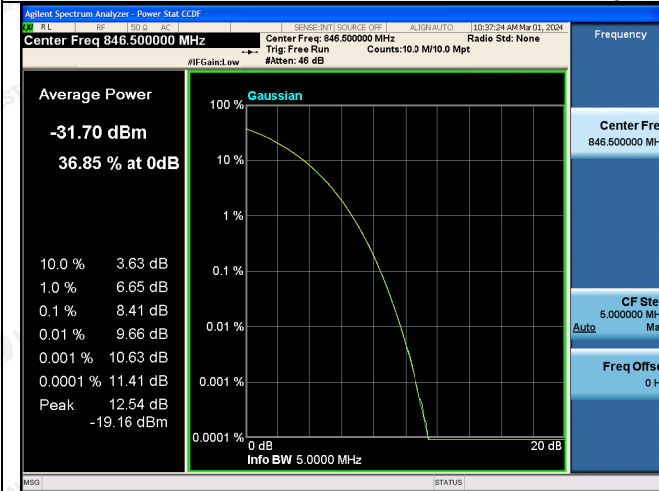

1RB#0

1RB#0

The results shown in this test report refer only to the sample(s) tested unless otherwise stated and the sample(s) are retained for 48 days only. The document is issued by HUAJ, this document cannot be reproduced except in full with our prior written permission. The more details and the authenticity of the report will be confirmed at http://www.cer-mark.com.

TEL : +86-755 2302 9901 FAX : +86-755 2302 9901 E-mail : service@cer-mark.com

Add: 1-2F., Building B2, Junfeng Zhongcheng Zhizao Innovation Park, Heping Community, Fuhai Street, Bao'an District, Shenzhen, Guangdong, China



LTE FDD Band 5-10MHz Channel Bandwidth PAPP

QPSK

16QAM

Low Channel

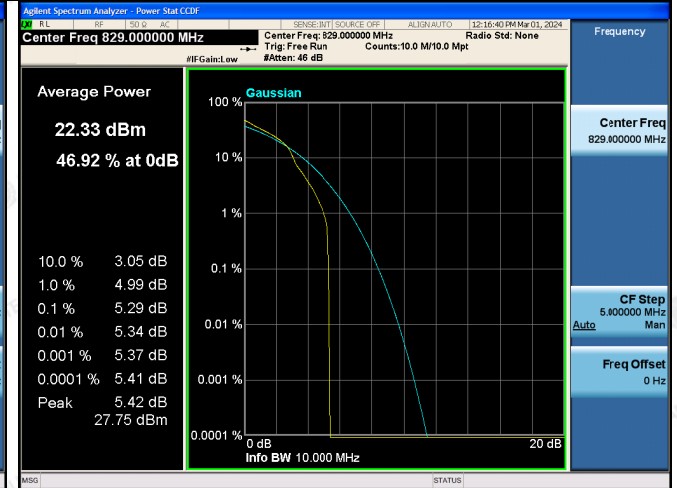
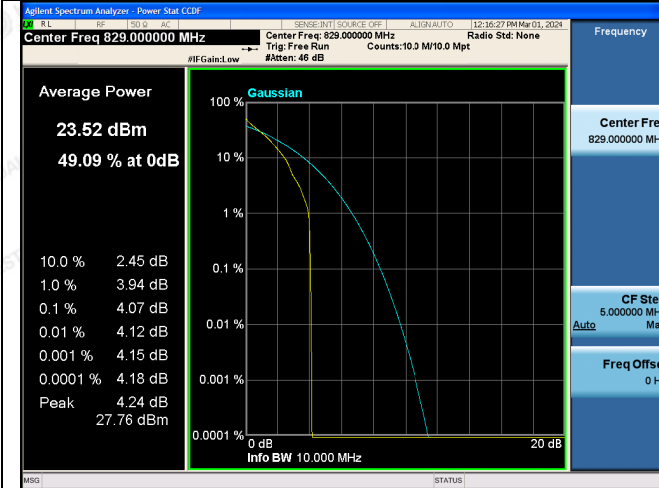

1RB#0

1RB#0

Middle Channel

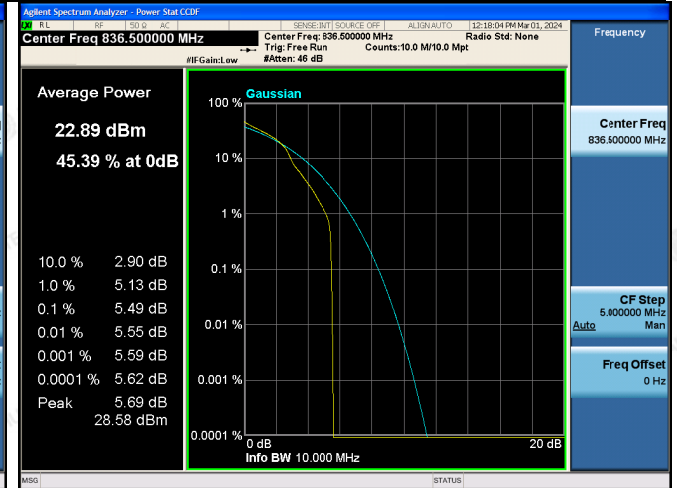
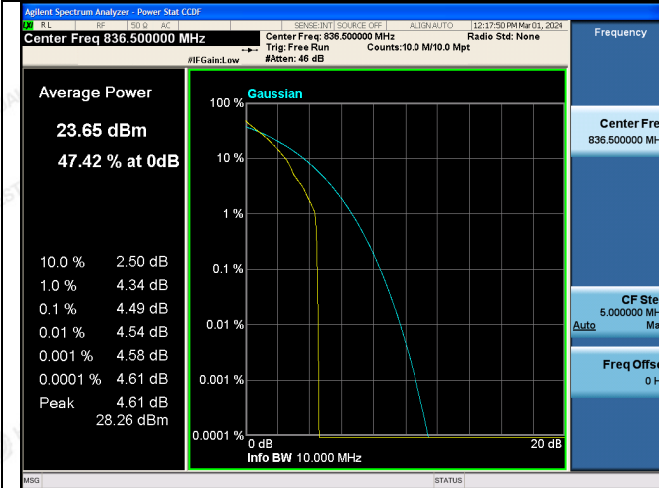

1RB#0

1RB#0

High Channel

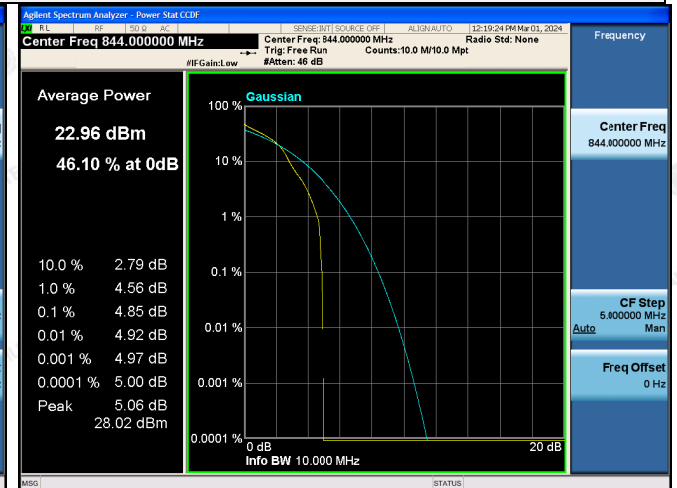
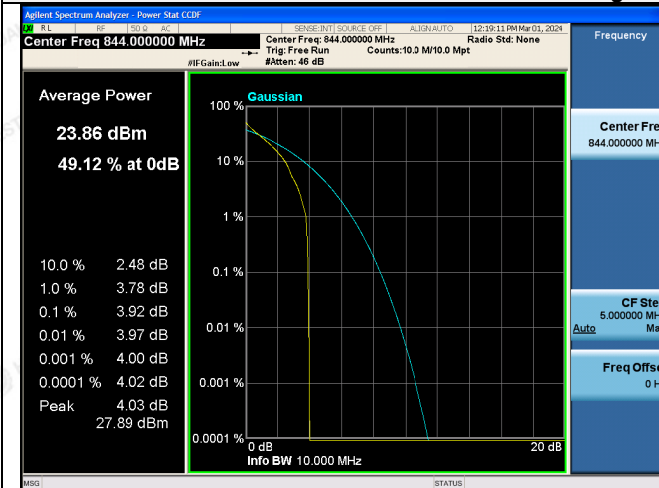

1RB#0

1RB#0

The results shown in this test report refer only to the sample(s) tested unless otherwise stated and the sample(s) are retained for 30 days only. The document is issued by HUAJ, this document cannot be reproduced except in full with our prior written permission. The more details and the authenticity of the report will be confirmed at http://www.cer-mark.com.

TEL : +86-755 2302 9901 FAX : +86-755 2302 9901 E-mail : service@cer-mark.com

Add: 1-2F., Building B2, Junfeng Zhongcheng Zhizao Innovation Park, Heping Community, Fuhai Street, Bao'an District, Shenzhen, Guangdong, China



4.3 Occupied Bandwidth and Emission Bandwidth

LIMIT

N/A

TEST CONFIGURATION

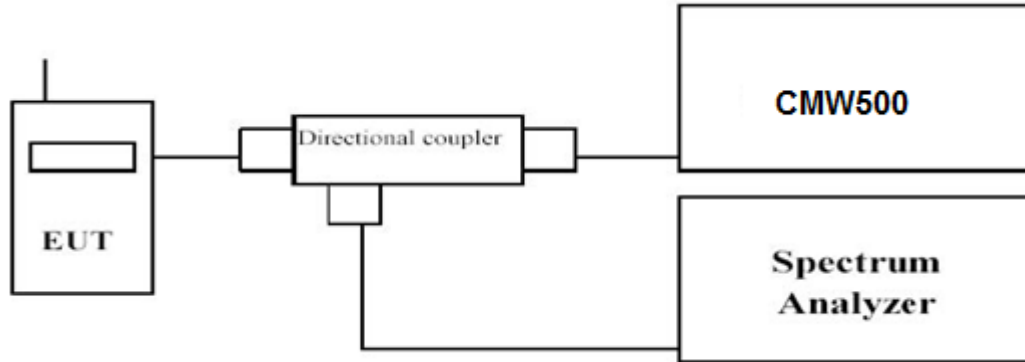

TEST PROCEDURE

The transmitter output was connected to a calibrated coaxial cable and coupler, the other end of which was connected to a spectrum analyzer. The occupied bandwidth was measured with the spectrum analyzer at low, middle and high channel in each band. The -26dBc Emission bandwidth was also measured and recorded. Set RBW was set to about 1% of emission BW, VBW ≥ 3 times RBW. -26dBc display line was placed on the screen (or 99% bandwidth), the occupied bandwidth is the delta frequency between the two points where the display line intersects the signal trace.

TEST RESULTS

Remark:

1. We were tested all RB Configuration refer 3GPP TS136 521 for each Channel Bandwidth of LTE FDD Band 5; recorded worst case for each Channel Bandwidth of LTE FDD Band 5.

LTE FDD Band 5						
TX Channel Bandwidth	RB Size/Offset	Frequency (MHz)	-26dBc Emission bandwidth (MHz)		99% Occupied bandwidth (MHz)	
			QPSK	16QAM	QPSK	16QAM
1.4 MHz	6RB#0	824.7	1.275	1.282	1.0945	1.0888
		836.5	1.302	1.310	1.0937	1.0999
		848.3	1.305	1.303	1.0947	1.0962
3 MHz	15RB#0	825.5	2.965	2.968	2.6983	2.6964
		836.5	2.963	2.951	2.6978	2.6930
		847.5	2.964	2.958	2.7022	2.6913
5 MHz	25RB#0	826.5	5.015	5.031	4.5017	4.5066
		836.5	4.998	4.983	4.5029	4.5036
		846.5	5.004	5.052	4.4988	4.5253
10 MHz	50RB#0	829.0	9.945	9.864	8.9704	8.9816
		836.5	9.846	9.856	8.9613	8.9482
		844.0	9.975	9.779	8.9784	8.9909

The results shown in this test report refer only to the sample(s) tested unless otherwise stated and the sample(s) are retained for 30 days only. The document is issued by HUAKE, this document cannot be reproduced except in full with our prior written permission. The more details and the authenticity of the report will be confirmed at <http://www.cer-mark.com>.



LTE FDD Band 5- 1.4 MHz Channel Bandwidth Occupied Bandwidth and Emission Bandwidth

QPSK

16QAM

Low Channel

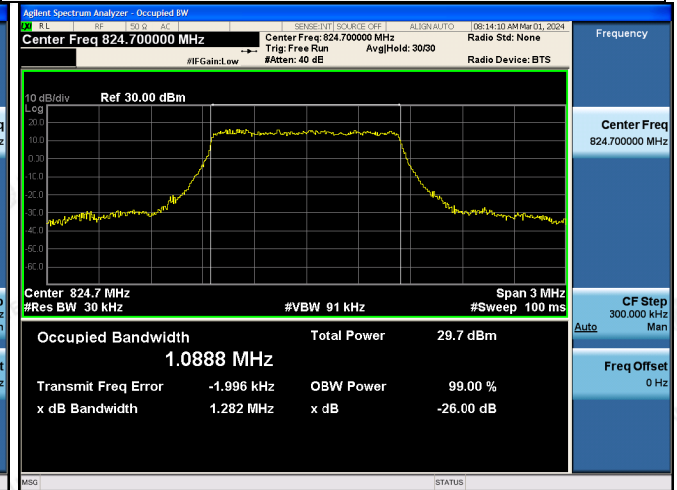
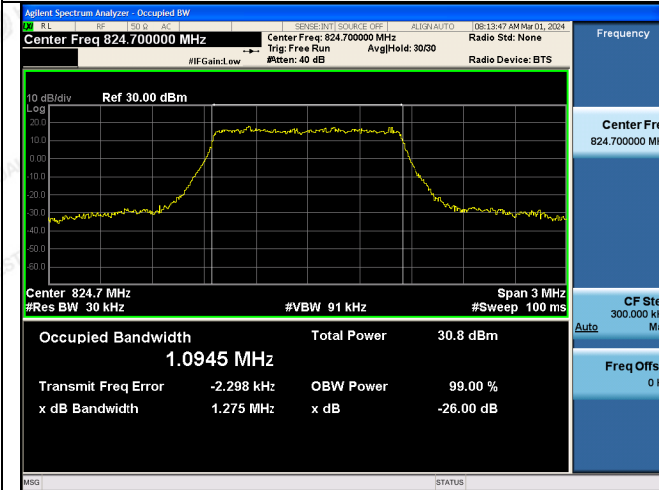

6RB#0

6RB#0

Middle Channel

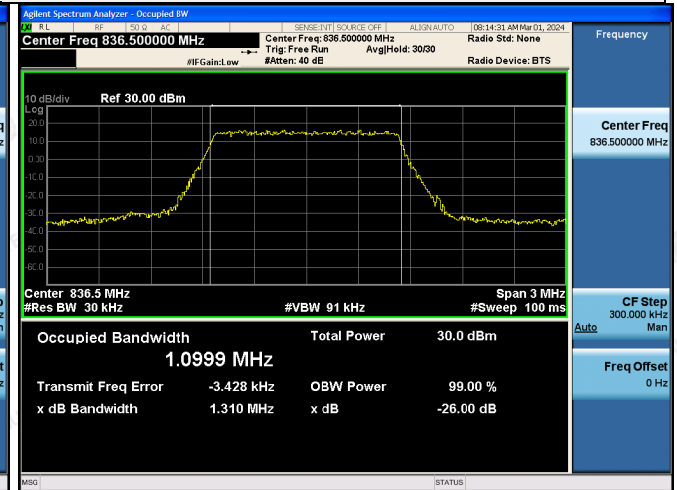
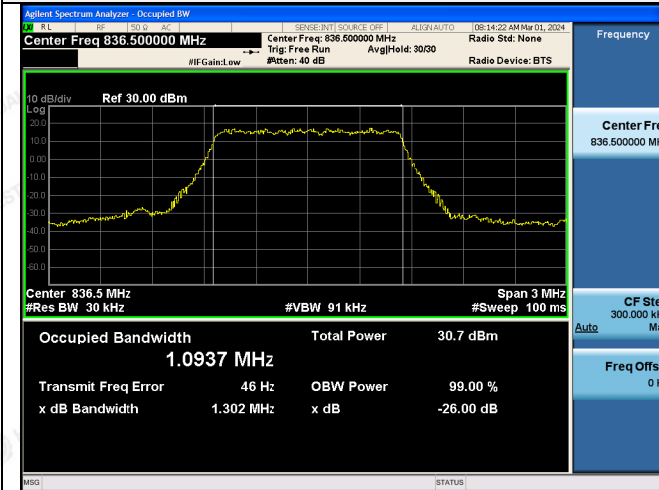

6RB#0

6RB#0

High Channel

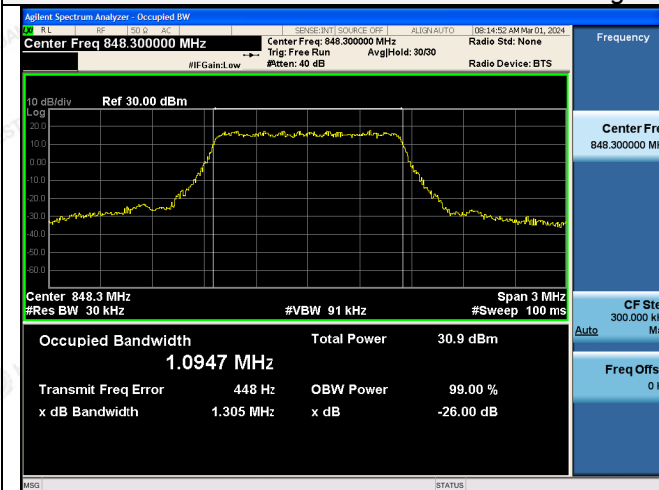

6RB#0

6RB#0

The results shown in this test report refer only to the sample(s) tested unless otherwise stated and the sample(s) are retained for 30 days only. The document is issued by HUAKE, this document cannot be reproduced except in full with our prior written permission. The more details and the authenticity of the report will be confirmed at http://www.cer-mark.com.

TEL : +86-755 2302 9901 FAX : +86-755 2302 9901 E-mail : service@cer-mark.com

Add: 1-2F., Building B2, Junfeng Zhongcheng Zhizao Innovation Park, Heping Community, Fuhai Street, Bao'an District, Shenzhen, Guangdong, China



LTE FDD Band 5-3MHz Channel Bandwidth Occupied Bandwidth and Emission Bandwidth

QPSK

16QAM

Low Channel

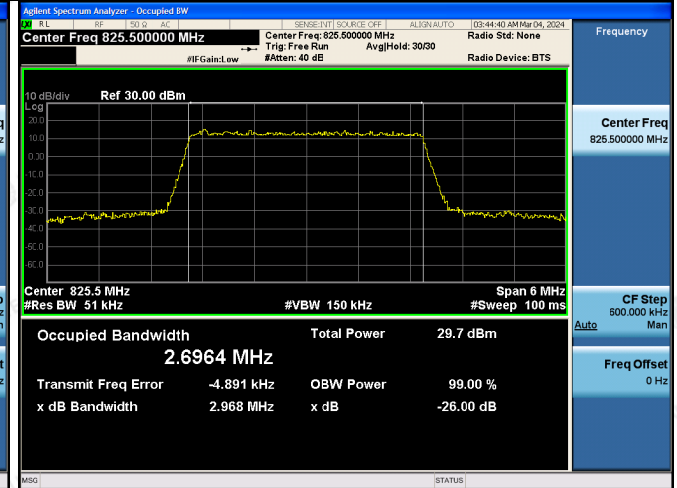
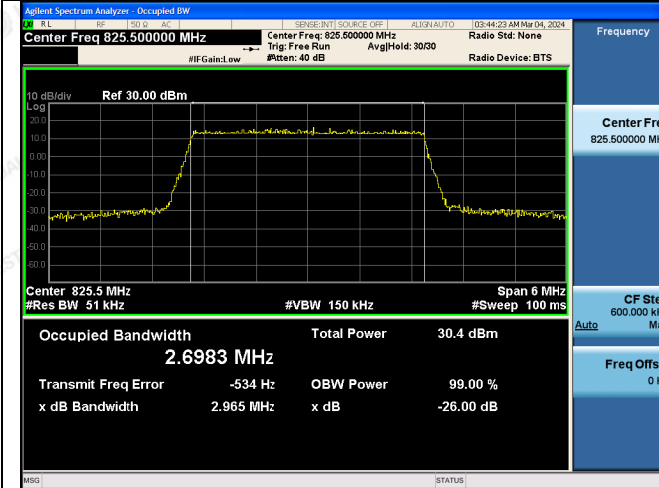

15RB#0

15RB#0

Middle Channel

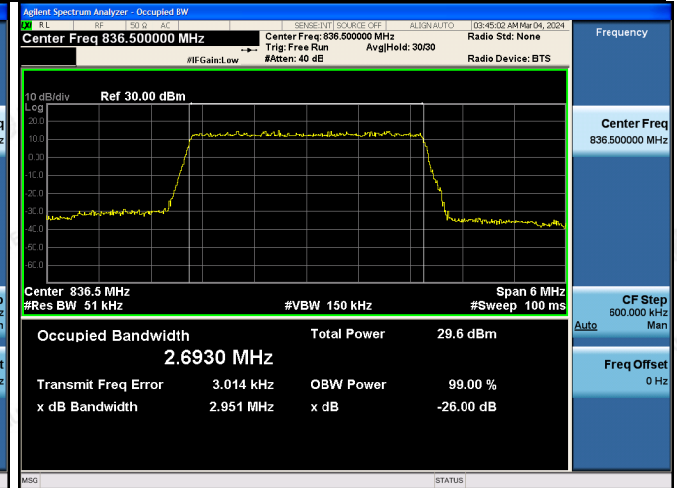
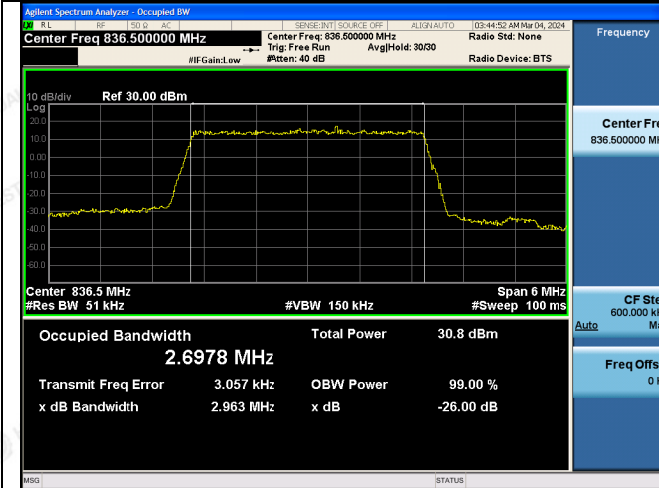

15RB#0

15RB#0

High Channel

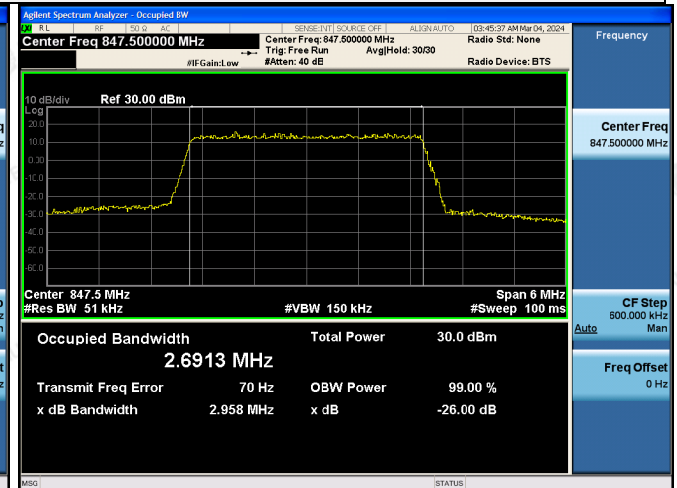
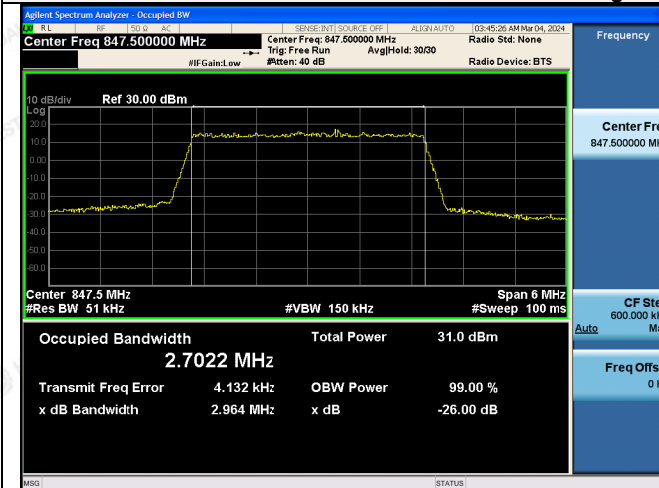

15RB#0

15RB#0

The results shown in this test report refer only to the sample(s) tested unless otherwise stated and the sample(s) are retained for 30 days only. The document is issued by HUAKE, this document cannot be reproduced except in full with our prior written permission. The more details and the authenticity of the report will be confirmed at http://www.cer-mark.com.

TEL : +86-755 2302 9901 FAX : +86-755 2302 9901 E-mail : service@cer-mark.com

Add: 1-2F., Building B2, Junfeng Zhongcheng Zhizao Innovation Park, Heping Community, Fuhai Street, Bao'an District, Shenzhen, Guangdong, China



LTE FDD Band 5-5MHz Channel Bandwidth Occupied Bandwidth and Emission Bandwidth

QPSK

16QAM

Low Channel

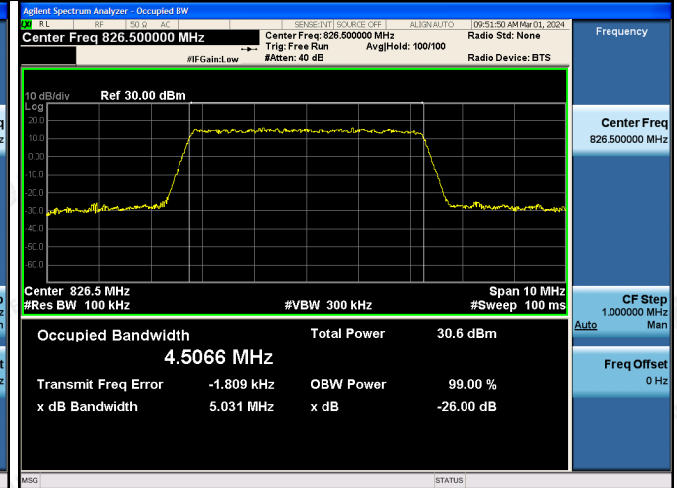
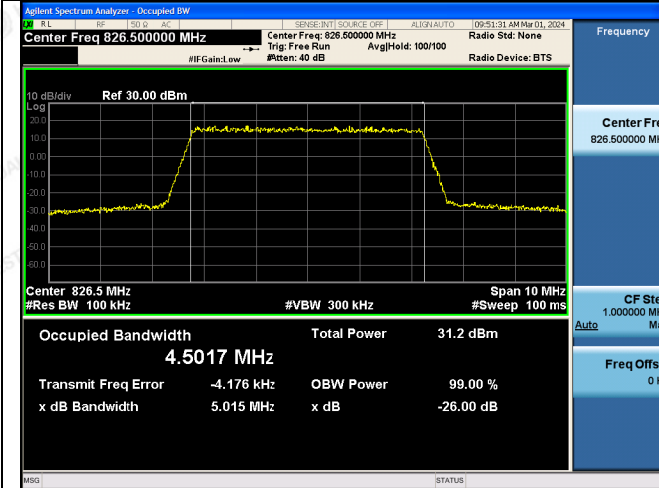

25RB#0

25RB#0

Middle Channel

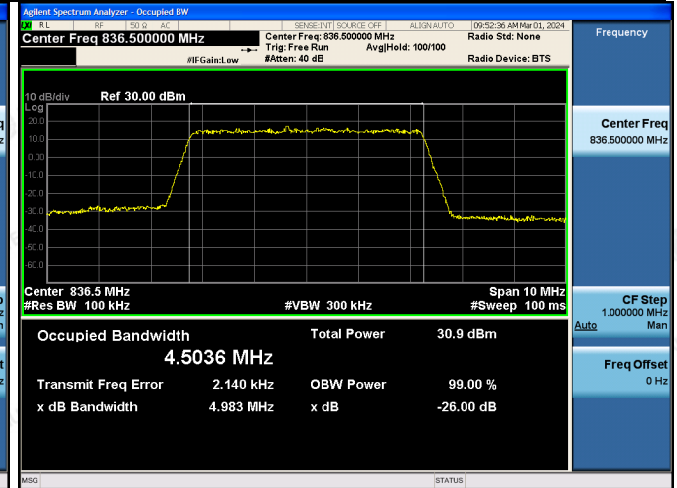
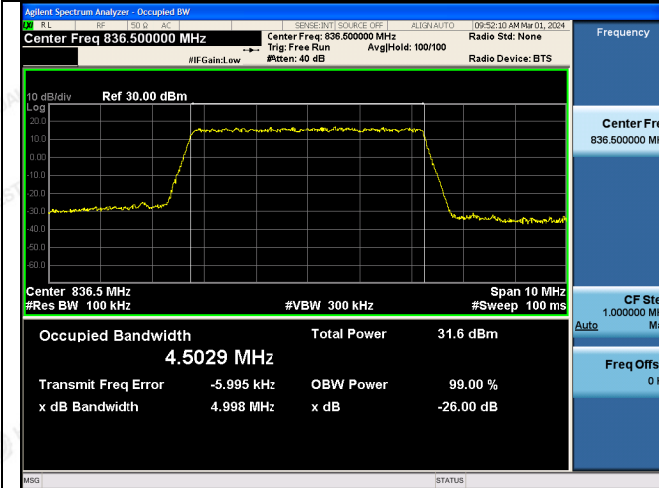

25RB#0

25RB#0

High Channel

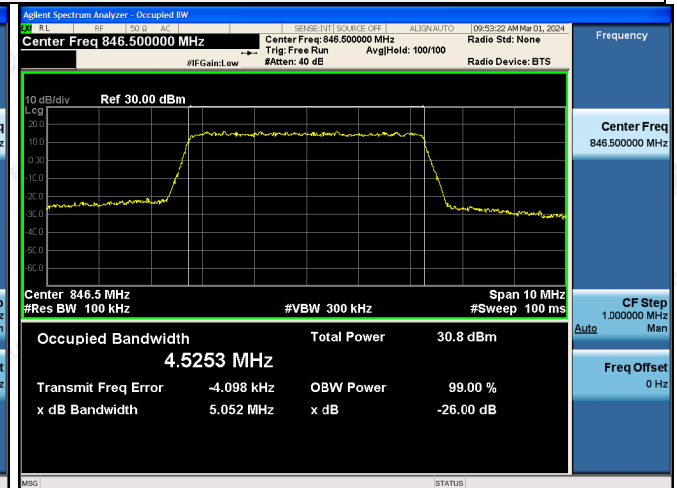
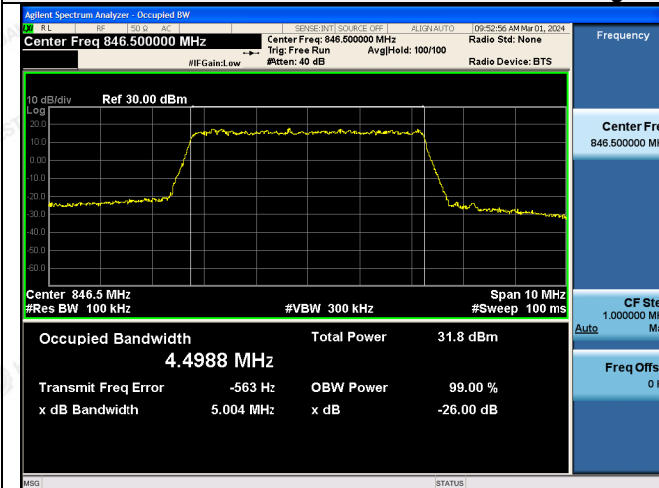

25RB#0

25RB#0

The results shown in this test report refer only to the sample(s) tested unless otherwise stated and the sample(s) are retained for 30 days only. This document is issued by HUAKE, this document cannot be reproduced except in full with our prior written permission. The more details and the authenticity of the report will be confirmed at http://www.cer-mark.com.

TEL : +86-755 2302 9901 FAX : +86-755 2302 9901 E-mail : service@cer-mark.com

Add: 1-2F., Building B2, Junfeng Zhongcheng Zhizao Innovation Park, Heping Community, Fuhai Street, Bao'an District, Shenzhen, Guangdong, China



LTE FDD Band 5-10MHz Channel Bandwidth Occupied Bandwidth and Emission Bandwidth

QPSK

16QAM

Low Channel

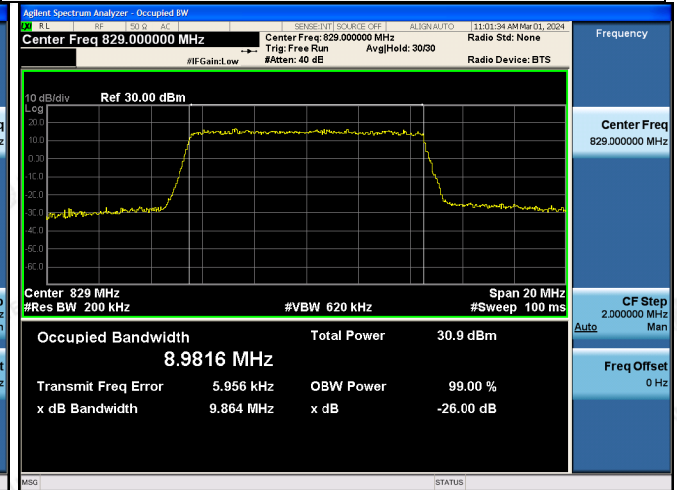
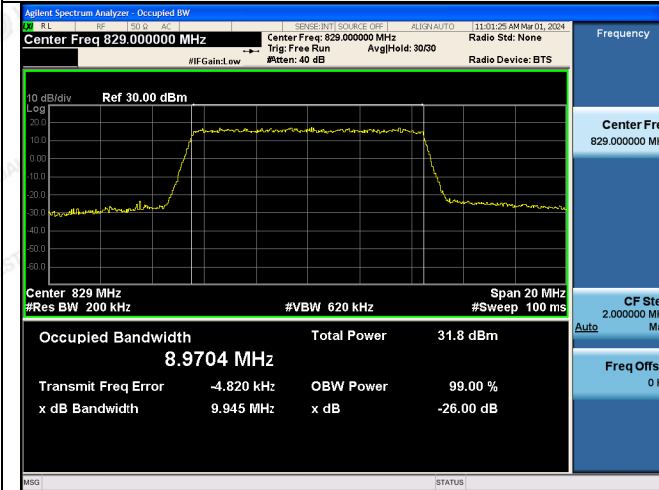

50RB#0

50RB#0

Middle Channel

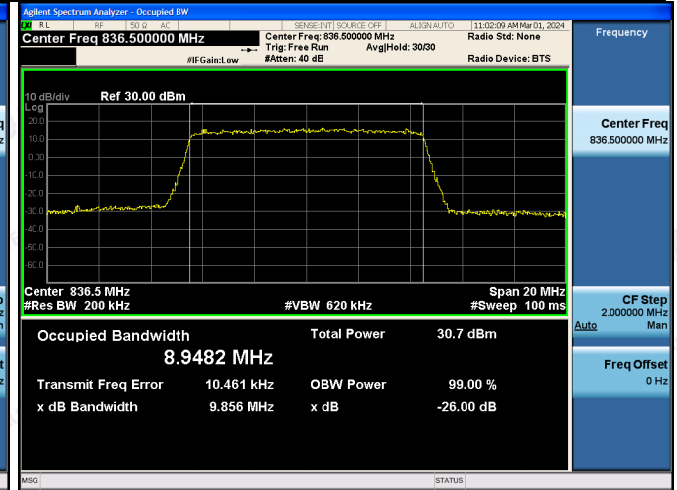
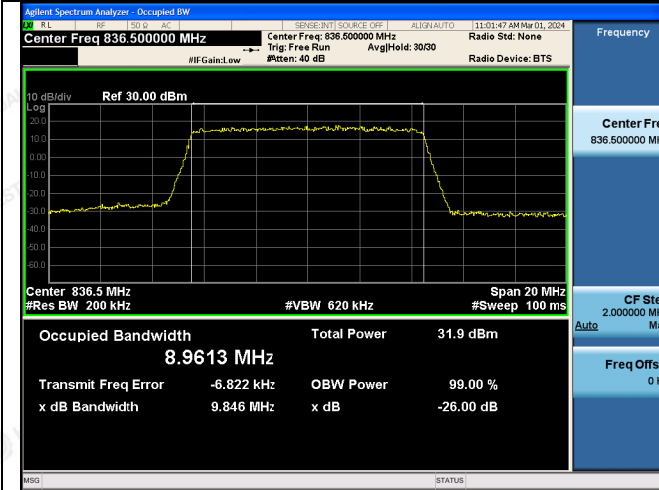

50RB#0

50RB#0

High Channel

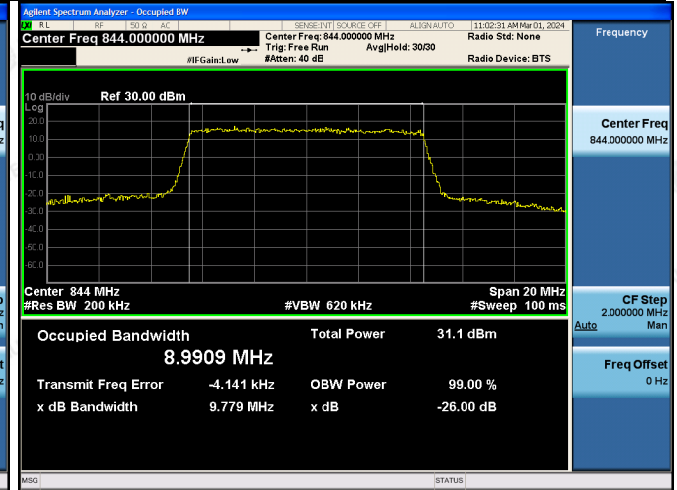
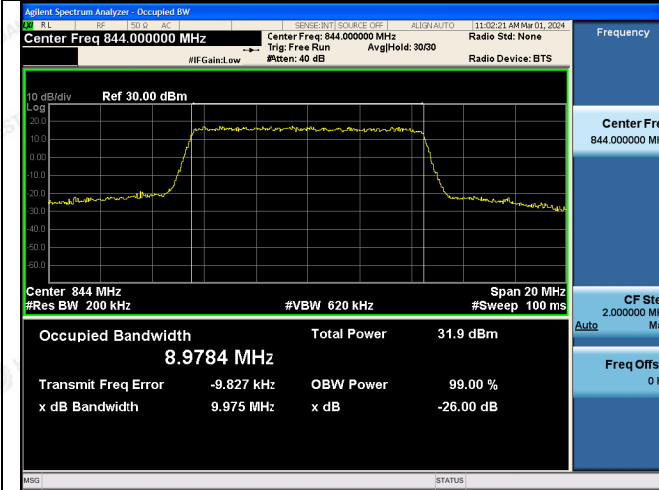

50RB#0

50RB#0

The results shown in this test report refer only to the sample(s) tested unless otherwise stated and the sample(s) are retained for 30 days only. The document is issued by HUAKE, this document cannot be reproduced except in full with our prior written permission. The more details and the authenticity of the report will be confirmed at http://www.cer-mark.com.

TEL : +86-755 2302 9901 FAX : +86-755 2302 9901 E-mail : service@cer-mark.com

Add: 1-2F., Building B2, Junfeng Zhongcheng Zhizao Innovation Park, Heping Community, Fuhai Street, Bao'an District, Shenzhen, Guangdong, China

4.4 Band Edge Compliance

LIMIT

Per FCC §24.238 the power of any emission outside of the authorized operating frequency ranges must be attenuated below the transmitting power (P) by a factor of at least $43 + 10\log(P)$ dB.

TEST CONFIGURATION

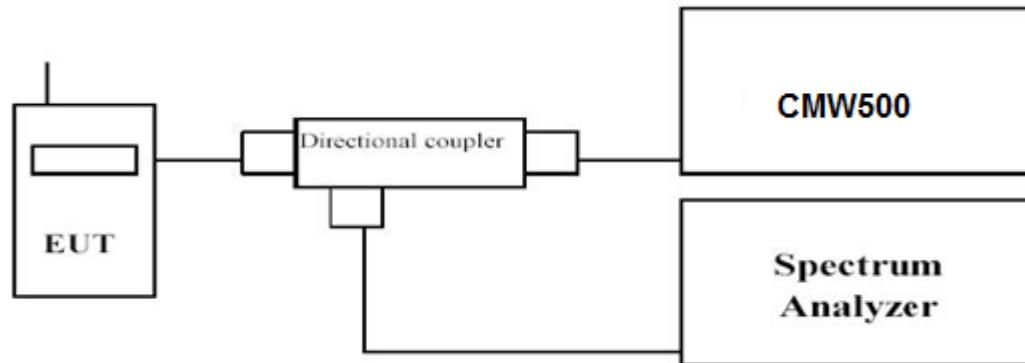

TEST PROCEDURE

1. The transmitter output port was connected to base station.
2. The RF output of EUT was connected to the power meter by RF cable and attenuator, the path loss was compensated to the results for each measurement.
3. Set EUT at maximum power through base station.
4. Select lowest and highest channels for each band and different modulation.
5. Measure Band edge using RMS (Average) detector by spectrum.

TEST RESULTS

Remark:

1. We were tested all RB Configuration refer 3GPP TS136 521 for each Channel Bandwidth of LTE FDD Band 5; recorded worst case for each Channel Bandwidth of LTE FDD Band 5.



LTE FDD Band 5- 1.4 MHz Channel Bandwidth Band Edge Compliance

QPSK

16QAM

Low Channel

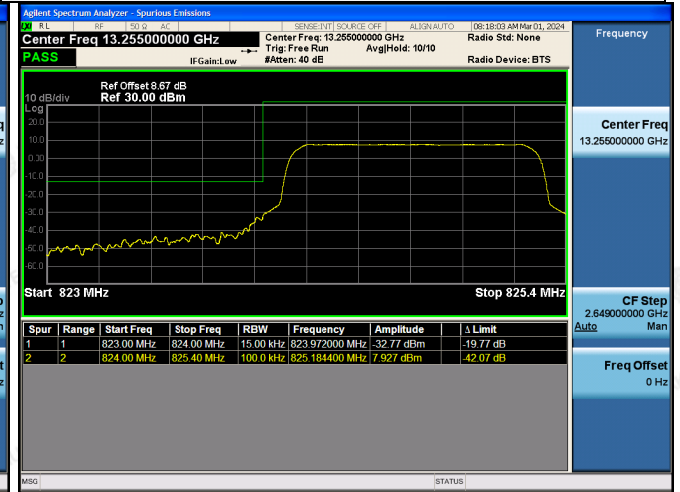
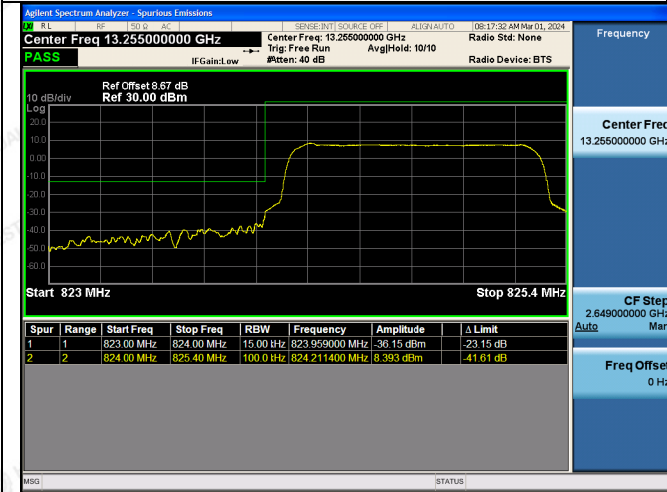

6RB#0

6RB#0

High Channel

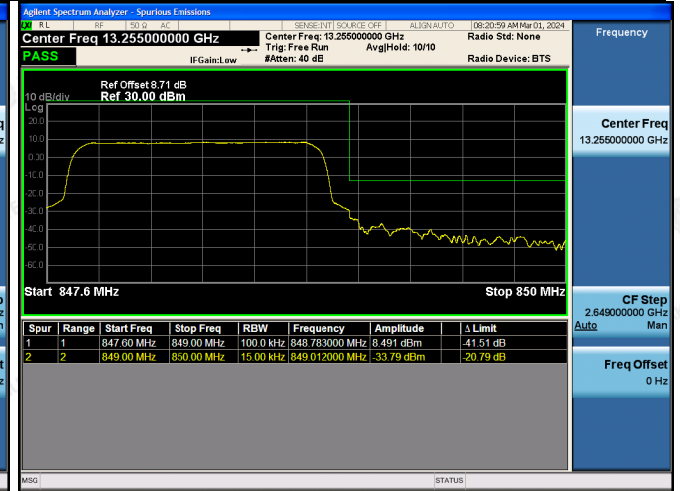
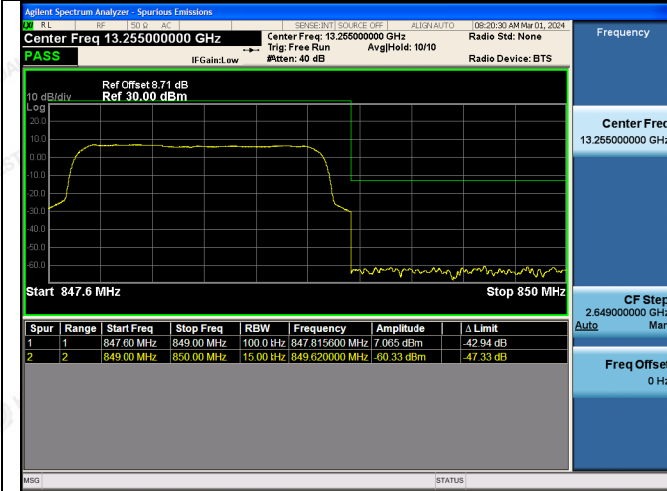

6RB#0

6RB#0

The results shown in this test report refer only to the sample(s) tested unless otherwise stated and the sample(s) are retained for 30 days only. The document is issued by HUAJ, this document cannot be reproduced except in full with our prior written permission. The more details and the authenticity of the report will be confirmed at <http://www.cer-mark.com>.

TEL : +86-755 2302 9901 FAX : +86-755 2302 9901 E-mail : service@cer-mark.com

Add: 1-2F., Building B2, Junfeng Zhongcheng Zhizao Innovation Park, Heping Community, Fuhai Street, Bao'an District, Shenzhen, Guangdong, China



LTE FDD Band 5-3MHz Channel Bandwidth Band Edge Compliance

QPSK

16QAM

Low Channel

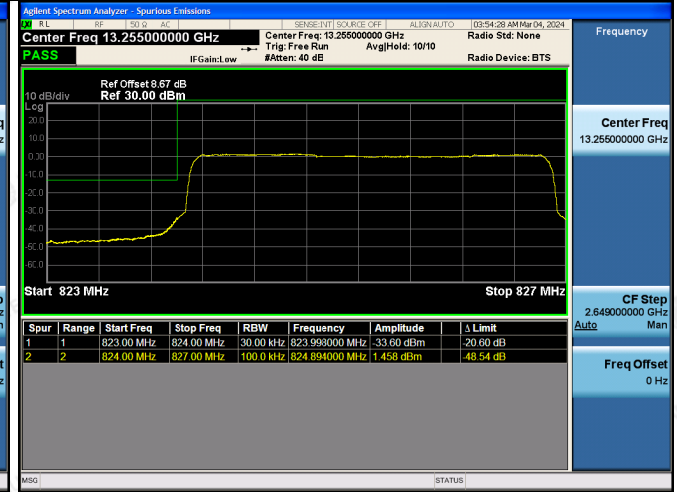
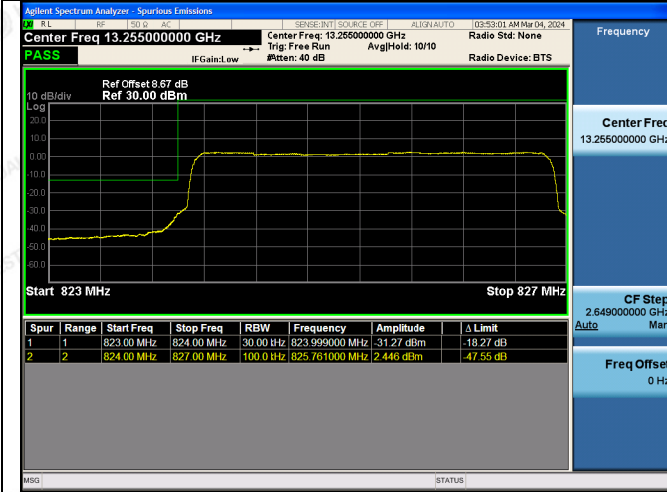

15RB#0

15RB#0

High Channel

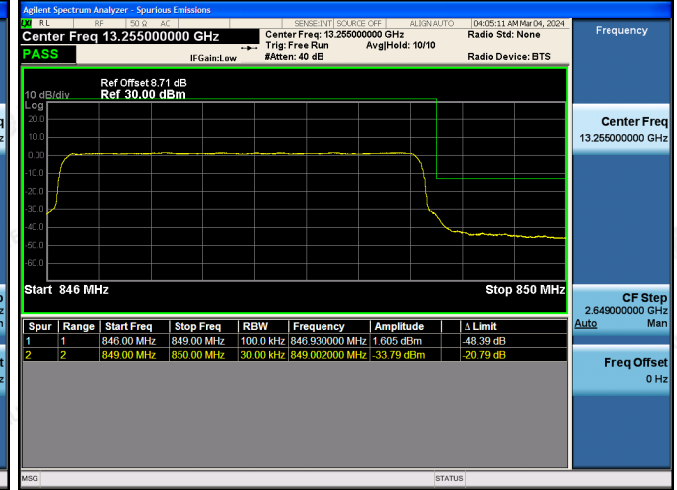
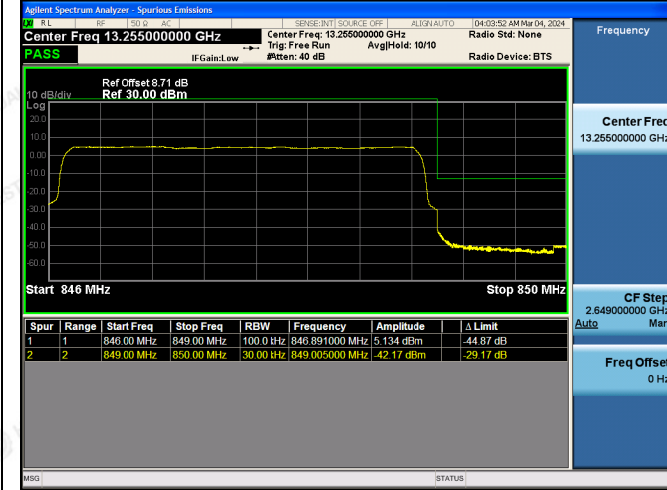

15RB#0

15RB#0

The results shown in this test report refer only to the sample(s) tested unless otherwise stated and the sample(s) are retained for 30 days only. The document is issued by HUAJ, this document cannot be reproduced except in full with our prior written permission. The more details and the authenticity of the report will be confirmed at http://www.cer-mark.com.

TEL : +86-755 2302 9901 FAX : +86-755 2302 9901 E-mail : service@cer-mark.com

Add: 1-2F., Building B2, Junfeng Zhongcheng Zhizao Innovation Park, Heping Community, Fuhai Street, Bao'an District, Shenzhen, Guangdong, China



LTE FDD Band 5-5MHz Channel Bandwidth Band Edge Compliance

QPSK

16QAM

Low Channel

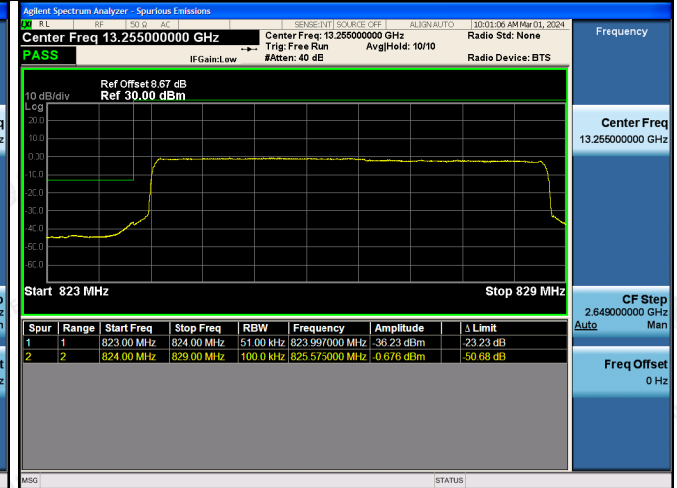
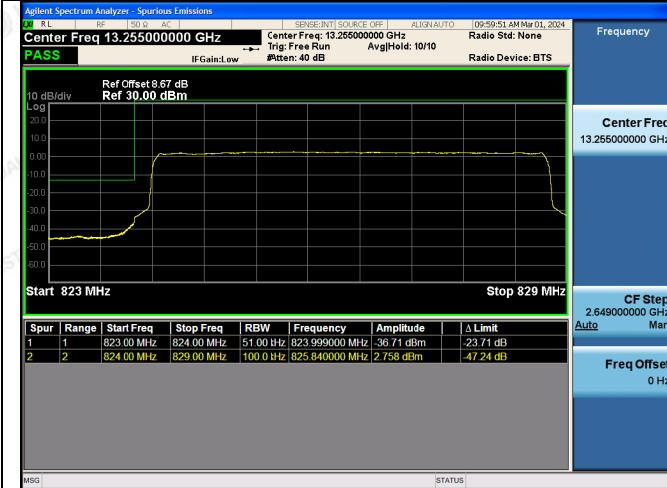

25RB#0

25RB#0

High Channel

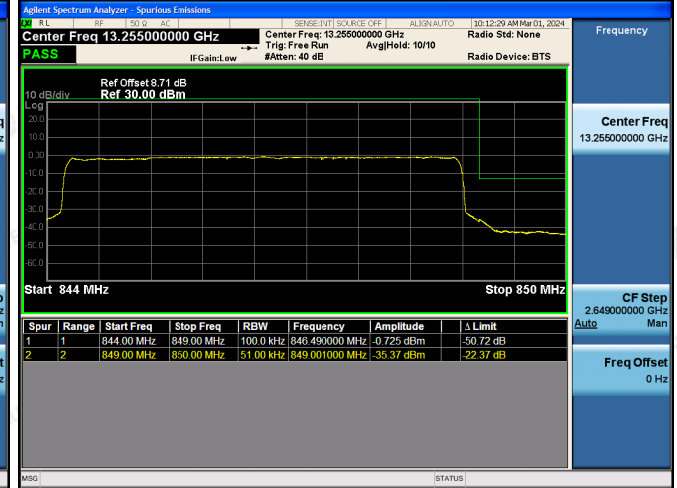
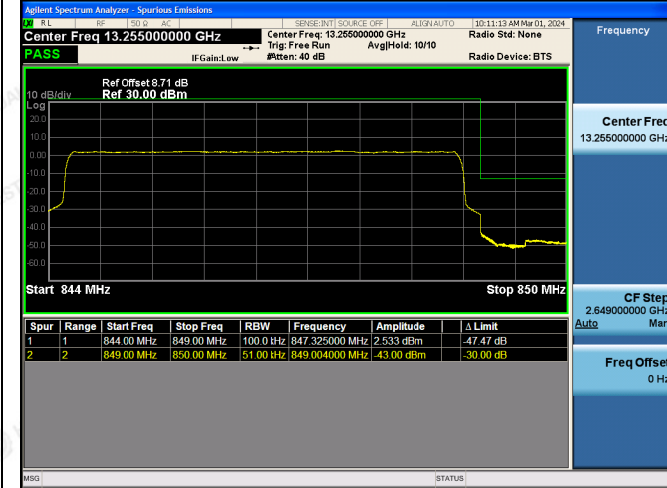

25RB#0

25RB#0

The results shown in this test report refer only to the sample(s) tested unless otherwise stated and the sample(s) are retained for 30 days only. The document is issued by HUAJ, this document cannot be reproduced except in full with our prior written permission. The more details and the authenticity of the report will be confirmed at http://www.cer-mark.com.



LTE FDD Band 5- 10 MHz Channel Bandwidth Band Edge Compliance

QPSK

16QAM

Low Channel

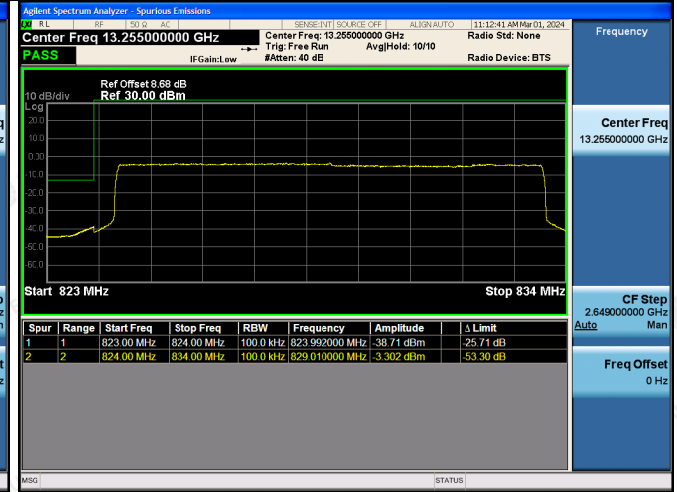
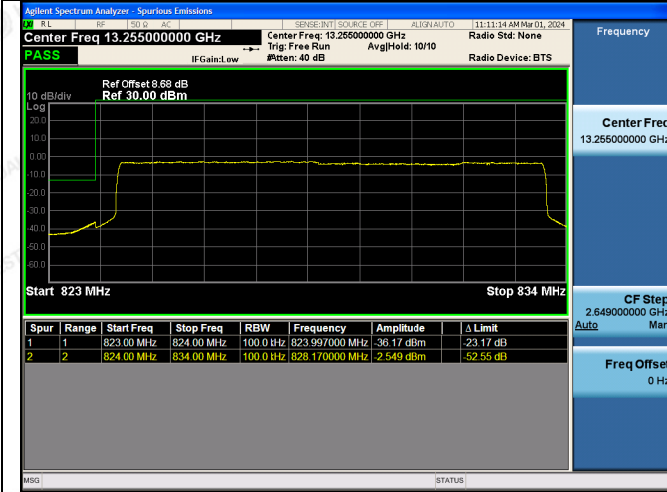

50RB#0

50RB#0

High Channel

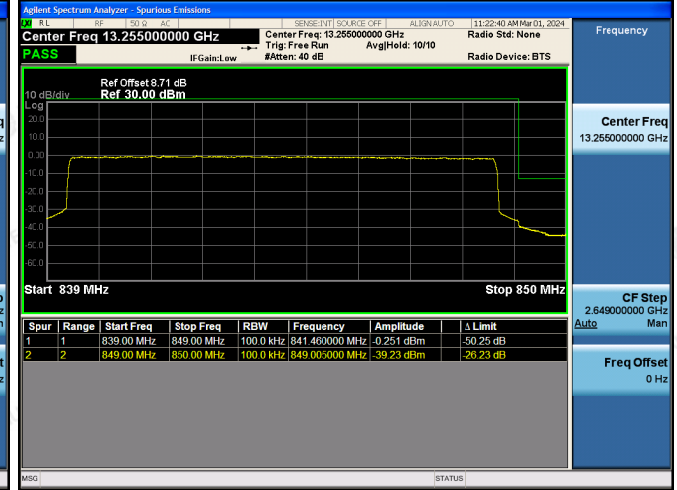
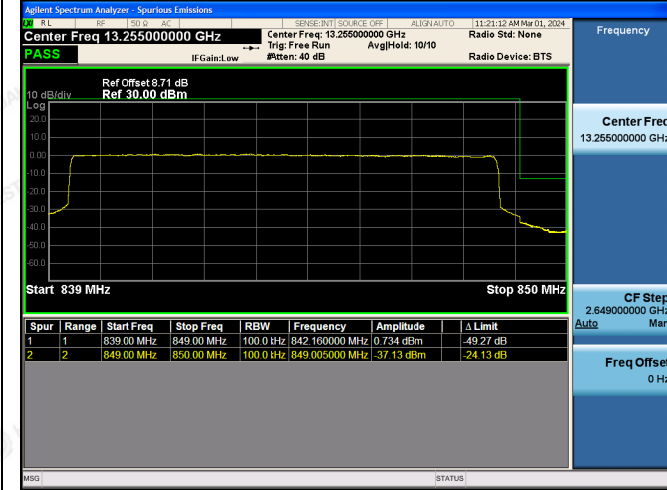

50RB#0

50RB#0

The results shown in this test report refer only to the sample(s) tested unless otherwise stated and the sample(s) are retained for 30 days only. This document is issued by HUAJ, this document cannot be reproduced except in full with our prior written permission. The more details and the authenticity of the report will be confirmed at http://www.cer-mark.com.

TEL : +86-755 2302 9901 FAX : +86-755 2302 9901 E-mail : service@cer-mark.com

Add: 1-2F., Building B2, Junfeng Zhongcheng Zhizao Innovation Park, Heping Community, Fuhai Street, Bao'an District, Shenzhen, Guangdong, China

4.5 Spurious Emission on Antenna Port

LIMIT

Per FCC §24.238, the power of any emission outside of the authorized operating frequency ranges must be attenuated below the transmitting power (P) by a factor of at least $43 + 10\log(P)$ dB.

TEST CONFIGURATION

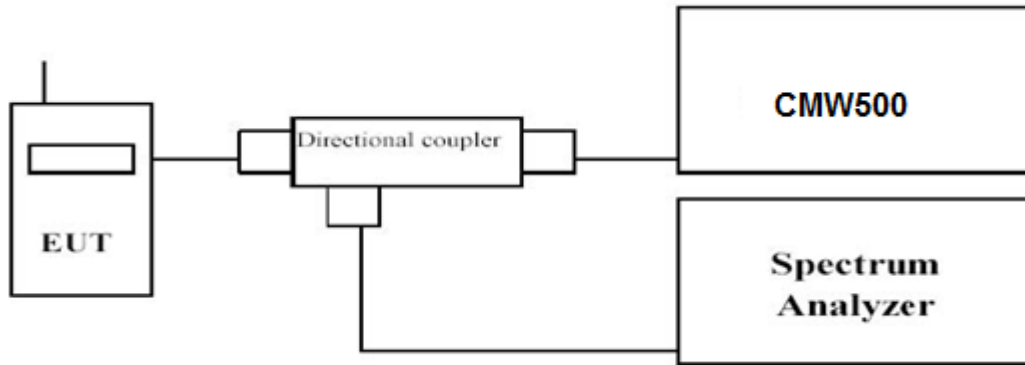

TEST PROCEDURE

The EUT was setup according to EIA/TIA 603D.

- Place the EUT on a bench and set it in transmitting mode.
- Connect a low loss RF cable from the antenna port to a spectrum analyzer and CMW500 by a Directional Coupler.
- EUT Communicate with CMW500, then select a channel for testing.
- Add a correction factor to the display of spectrum, and then test.
- The resolution bandwidth of the spectrum analyzer was set sufficient scans were taken to show the out of band Emission if any up to 10th harmonic.
- Please refer to following tables for test antenna conducted emissions.

Working Frequency	Sub range (GHz)	RBW	VBW	Sweep time (s)
LTE FDD Band 5	0.01~20	1 MHz	3 MHz	Auto

TEST RESULTS

Remark:

- We were tested all RB Configuration refer 3GPP TS136 521 for each Channel Bandwidth of LTE FDD Band 5; recorded worst case at the QPSK Mode for each Channel Bandwidth of LTE FDD Band 5.

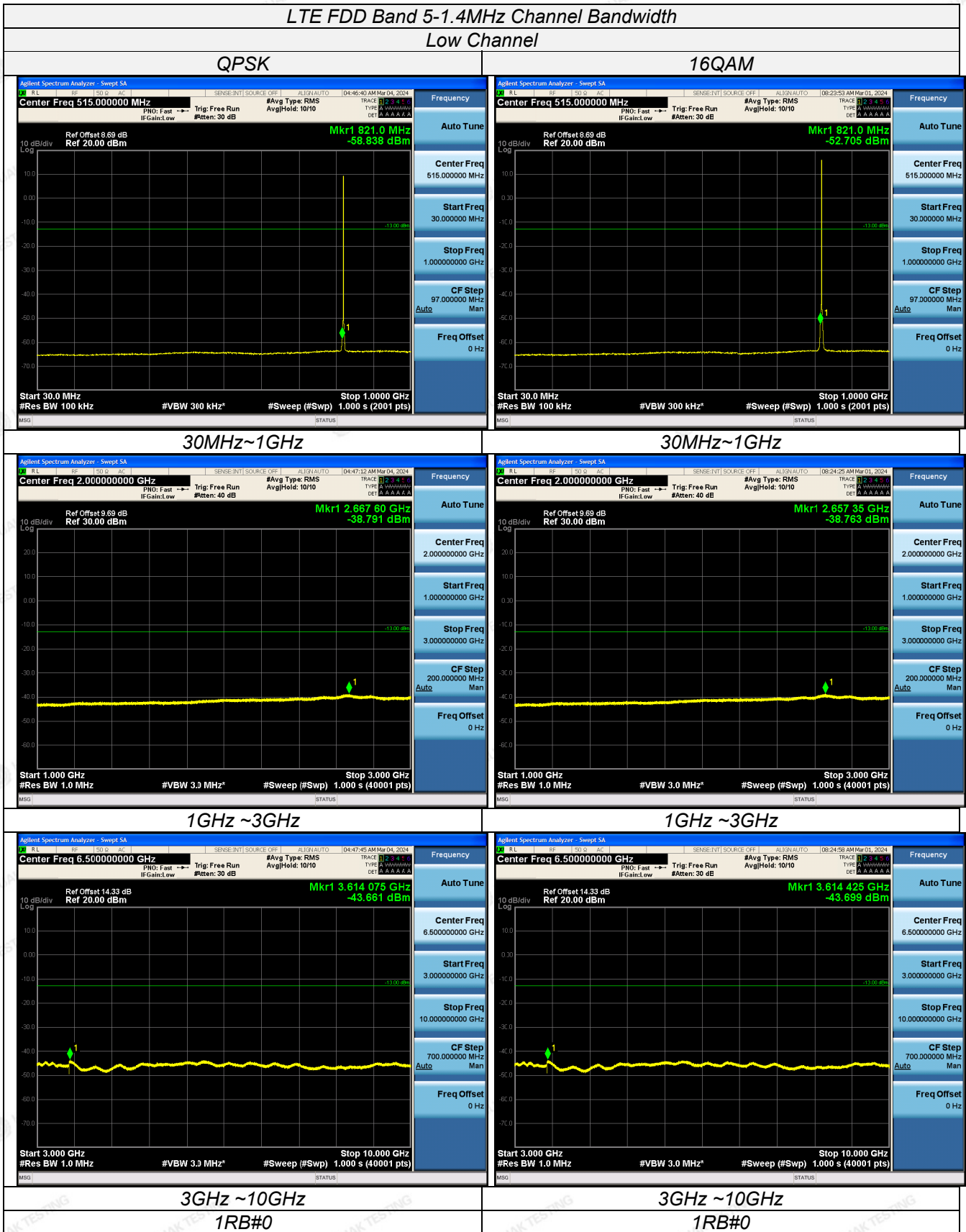

The results shown in this test report refer only to the sample(s) tested unless otherwise stated and the sample(s) are retained for 30 days only. The document is issued by HUAKE, this document cannot be reproduced except in full with our prior written permission. The more details and the authenticity of the report will be confirmed at <http://www.cer-mark.com>.

TEL : +86-755 2302 9901 FAX : +86-755 2302 9901 E-mail : service@cer-mark.com

Add: 1-2F., Building B2, Junfeng Zhongcheng Zhizao Innovation Park, Heping Community, Fuhai Street, Bao'an District, Shenzhen, Guangdong, China



LTE FDD Band 5-1.4MHz Channel Bandwidth
Middle Channel

QPSK

16QAM

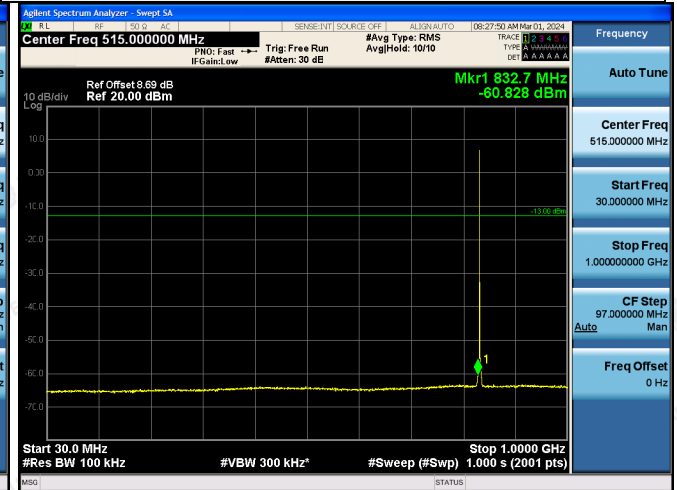
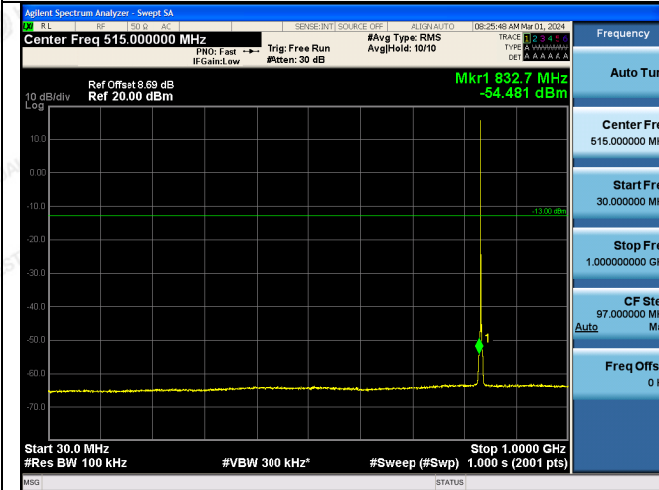

30MHz~1GHz

30MHz~1GHz

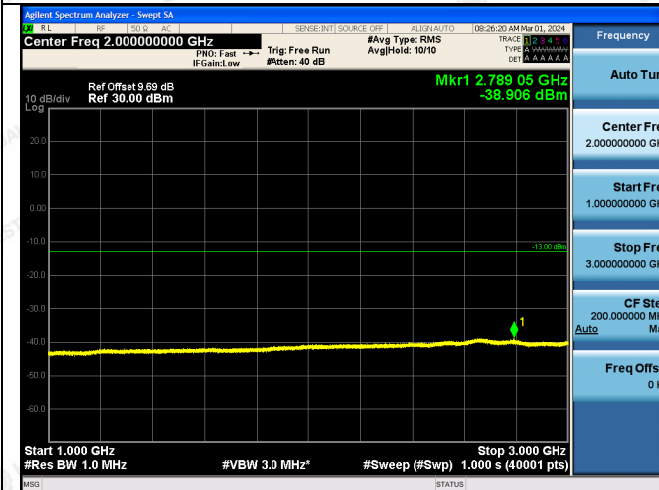

1GHz ~3GHz

1GHz ~3GHz

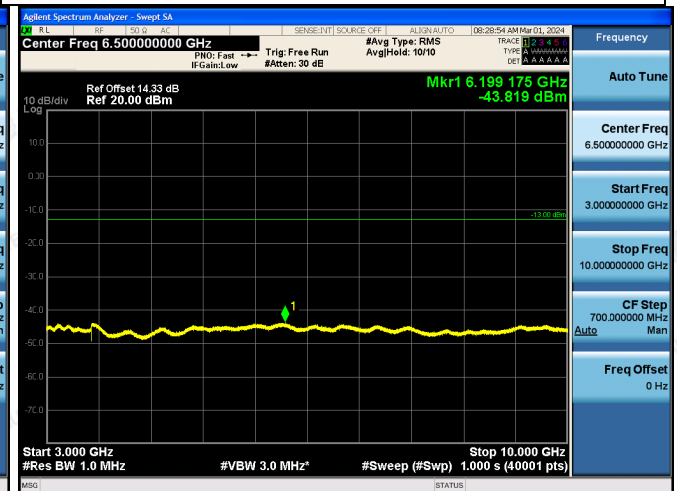
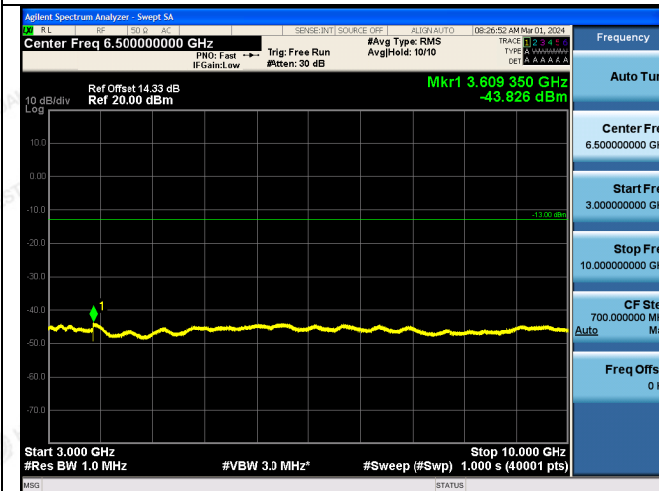

3GHz ~10GHz

3GHz ~10GHz

1RB#0

1RB#0



LTE FDD Band 5-1.4MHz Channel Bandwidth
High Channel

QPSK

16QAM

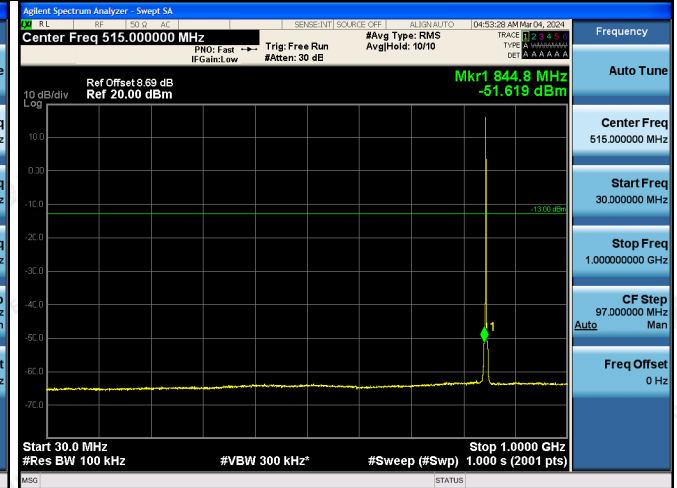
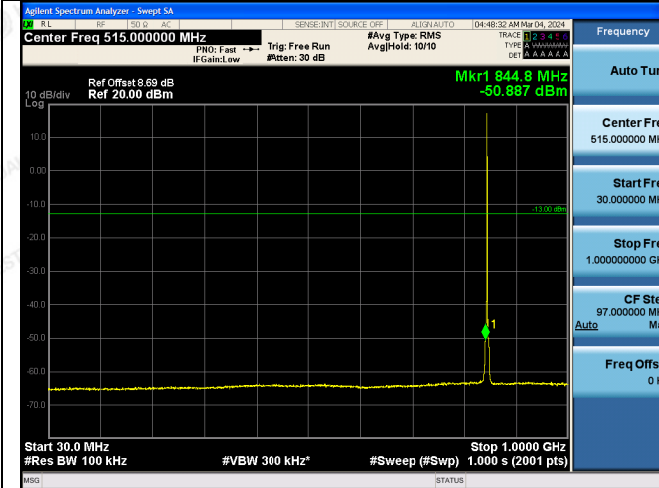

30MHz~1GHz

30MHz~1GHz

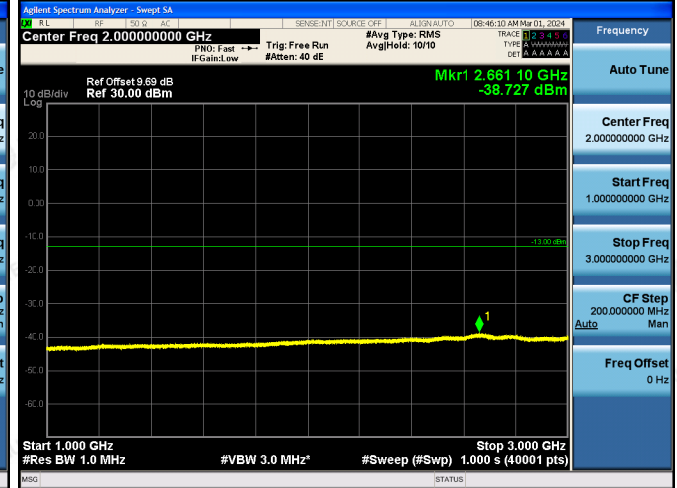
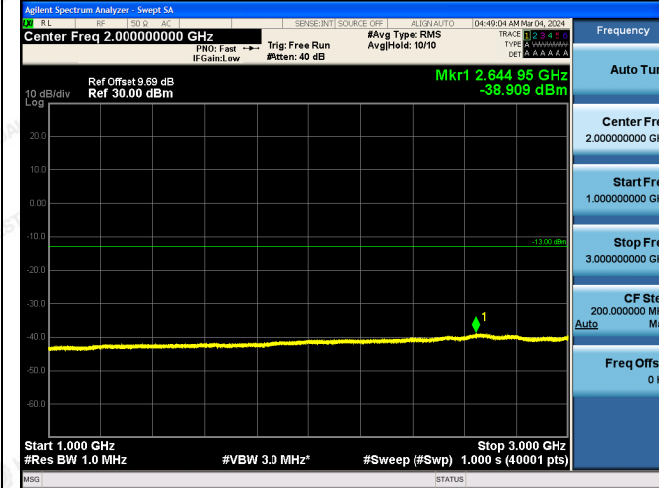

1GHz ~3GHz

1GHz ~3GHz

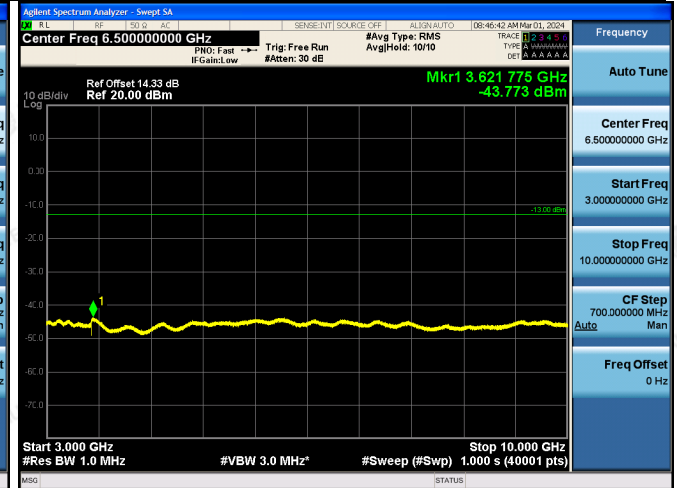
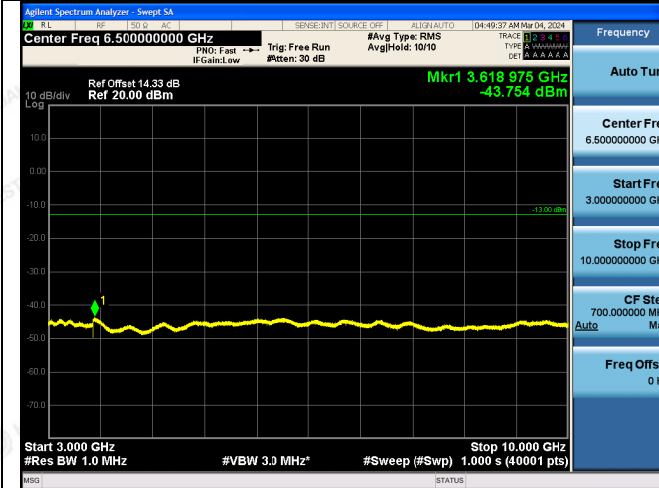

3GHz ~10GHz

3GHz ~10GHz

1RB#0

1RB#0

The results shown in this test report refer only to the sample(s) tested unless otherwise stated and the sample(s) are retained for 30 days only. The report is issued by HUAJ, this document cannot be reproduced except in full with our prior written permission. The more details and the authenticity of the report will be confirmed at <http://www.cer-mark.com>.

TEL : +86-755 2302 9901 FAX : +86-755 2302 9901 E-mail : service@cer-mark.com

Add: 1-2F., Building B2, Junfeng Zhongcheng Zhizao Innovation Park, Heping Community, Fuhai Street, Bao'an District, Shenzhen, Guangdong, China



LTE FDD Band 5-3MHz Channel Bandwidth

Low Channel

QPSK

16QAM

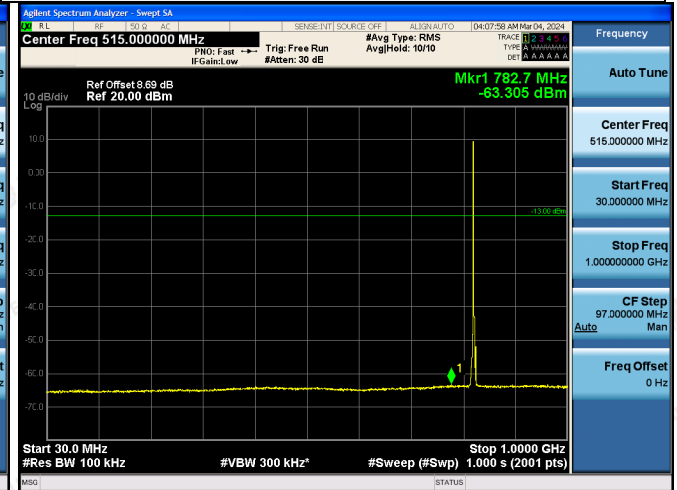
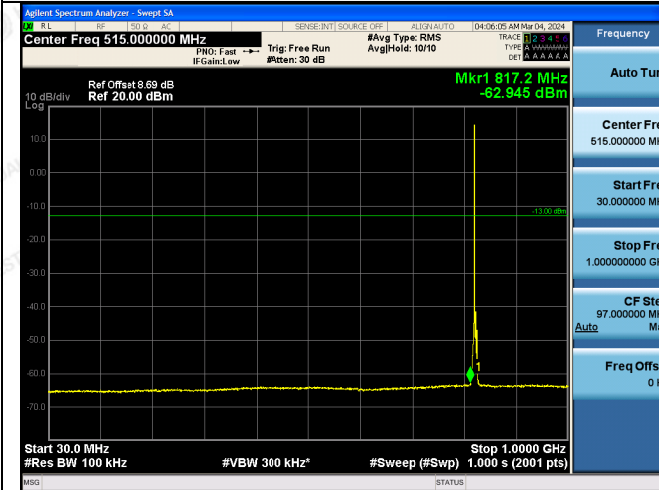

30MHz~1GHz

30MHz~1GHz

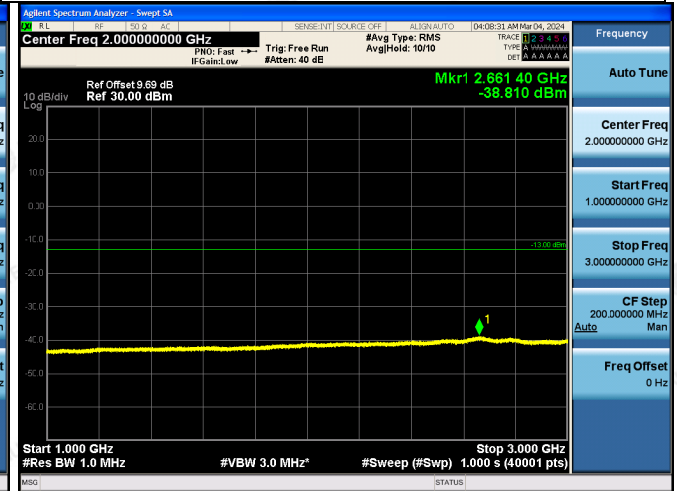
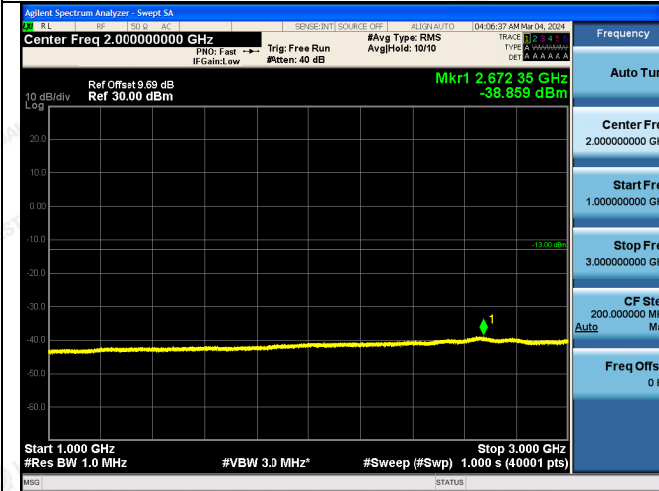

1GHz~3GHz

1GHz~3GHz

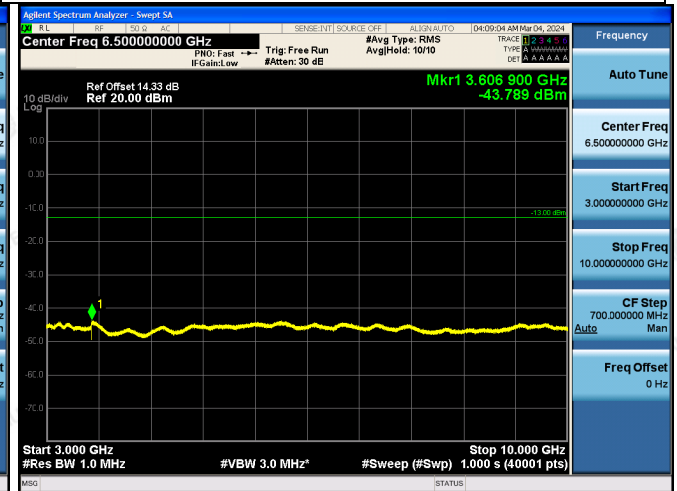
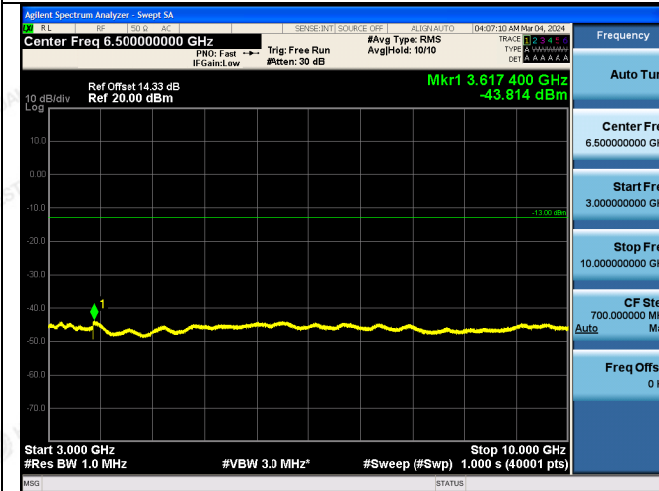

3GHz~10GHz

1RB#0

3GHz~10GHz

1RB#0

The results shown in this test report refer only to the sample(s) tested unless otherwise stated and the sample(s) are retained for 30 days only. The document is issued by HUAKE, this document cannot be reproduced except in full with our prior written permission. The more details and the authenticity of the report will be confirmed at <http://www.cer-mark.com>.

TEL : +86-755 2302 9901 FAX : +86-755 2302 9901 E-mail : service@cer-mark.com

Add: 1-2F., Building B2, Junfeng Zhongcheng Zhizao Innovation Park, Heping Community, Fuhai Street, Bao'an District, Shenzhen, Guangdong, China



LTE FDD Band 5-3MHz Channel Bandwidth
Middle Channel

QPSK

16QAM

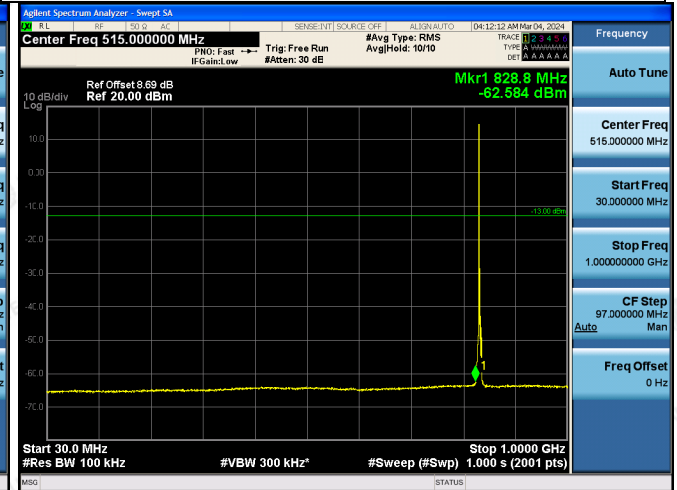
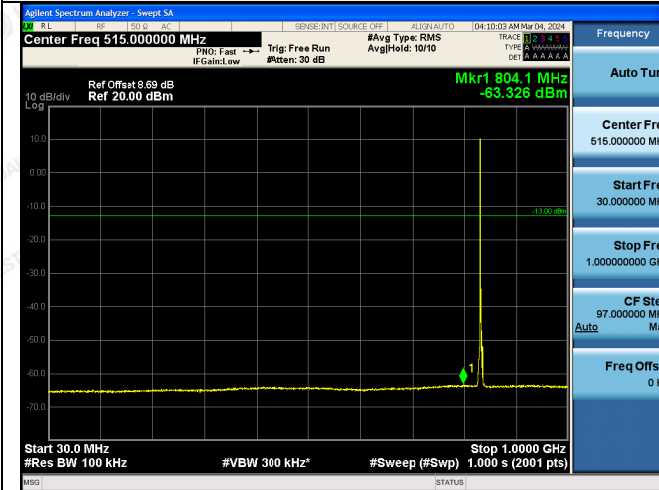

30MHz~1GHz

30MHz~1GHz

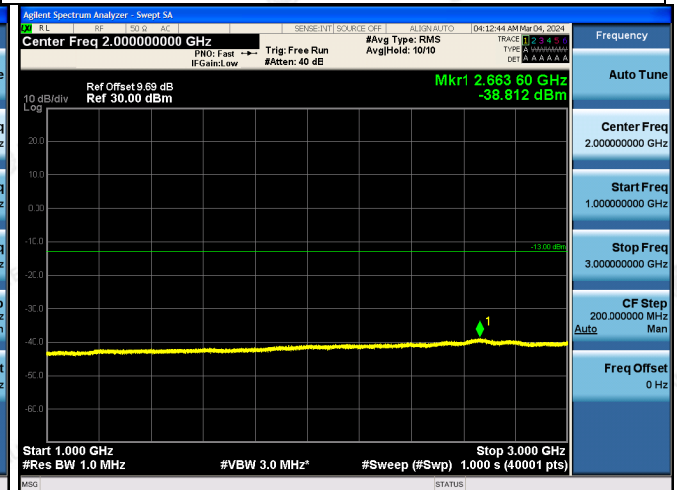
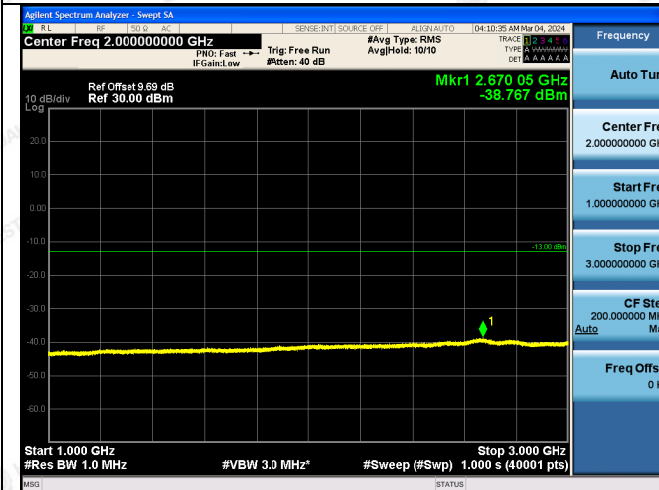

1GHz ~3GHz

1GHz ~3GHz

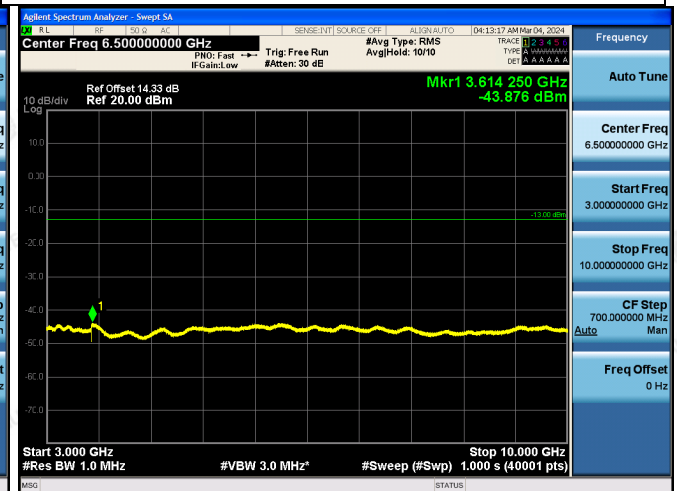
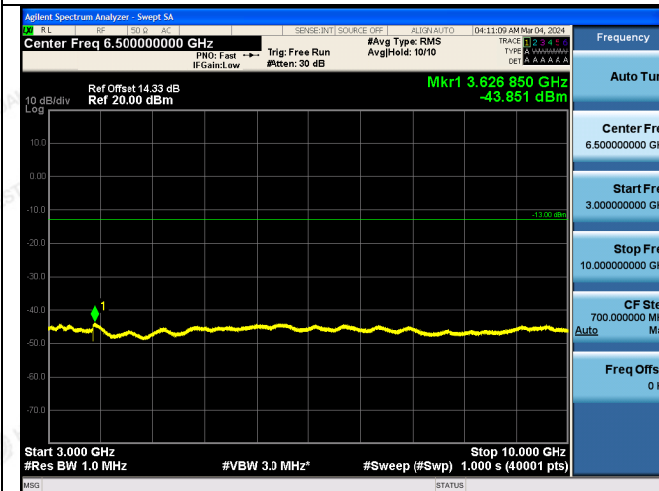

3GHz ~10GHz

3GHz ~10GHz

1RB#0

1RB#0

The results shown in this test report refer only to the sample(s) tested unless otherwise stated and the sample(s) are retained for 30 days only. The document is issued by HUAJ, this document cannot be reproduced except in full with our prior written permission. The more details and the authenticity of the report will be confirmed at <http://www.cer-mark.com>.

TEL : +86-755 2302 9901 FAX : +86-755 2302 9901 E-mail : service@cer-mark.com

Add: 1-2F., Building B2, Junfeng Zhongcheng Zhizao Innovation Park, Heping Community, Fuhai Street, Bao'an District, Shenzhen, Guangdong, China



LTE FDD Band 5-3MHz Channel Bandwidth
High Channel

QPSK

16QAM

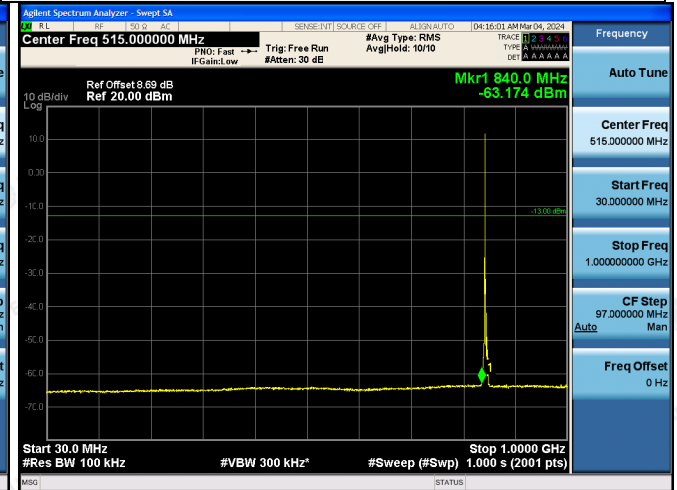
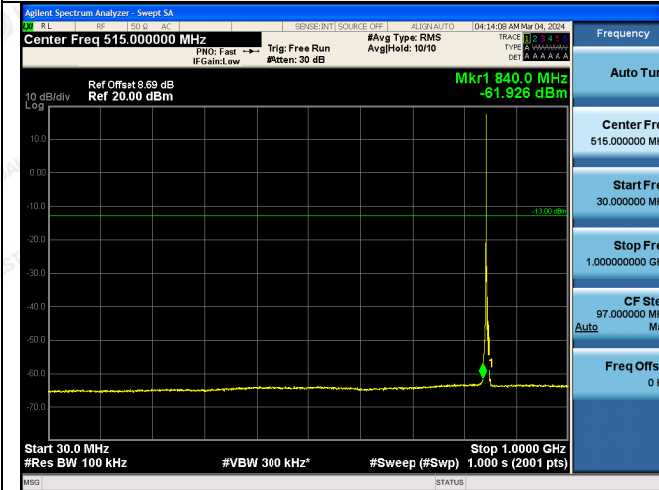

30MHz~1GHz

30MHz~1GHz

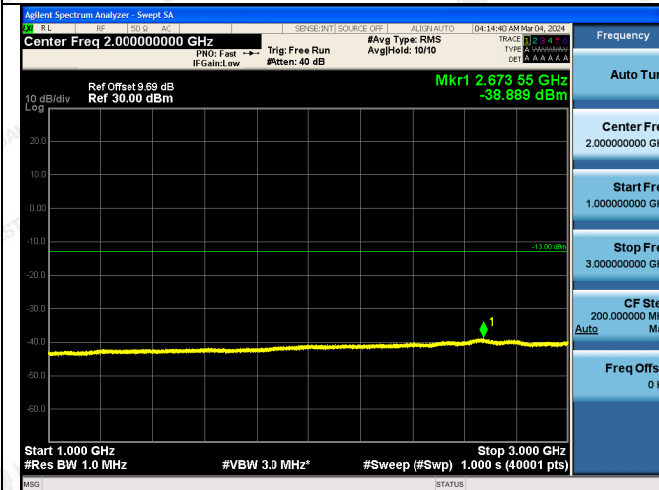

1GHz ~3GHz

1GHz ~3GHz

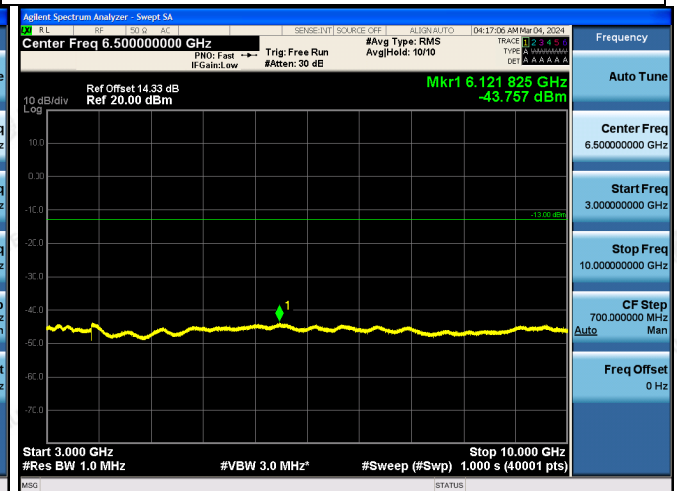
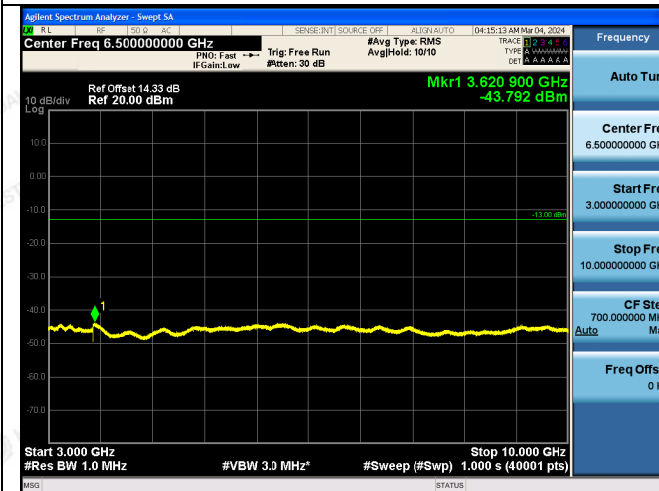

3GHz ~10GHz

3GHz ~10GHz

1RB#0

1RB#0

The results shown in this test report refer only to the sample(s) tested unless otherwise stated and the sample(s) are retained for 30 days only. The document is issued by HUAJ, this document cannot be reproduced except in full with our prior written permission. The more details and the authenticity of the report will be confirmed at <http://www.cer-mark.com>.

TEL : +86-755 2302 9901 FAX : +86-755 2302 9901 E-mail : service@cer-mark.com

Add: 1-2F., Building B2, Junfeng Zhongcheng Zhizao Innovation Park, Heping Community, Fuhai Street, Bao'an District, Shenzhen, Guangdong, China



LTE FDD Band 5-5 MHz Channel Bandwidth
Low Channel

QPSK

16QAM

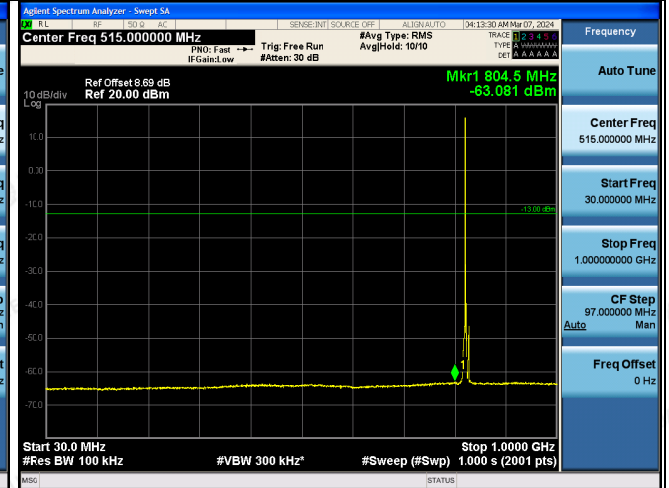
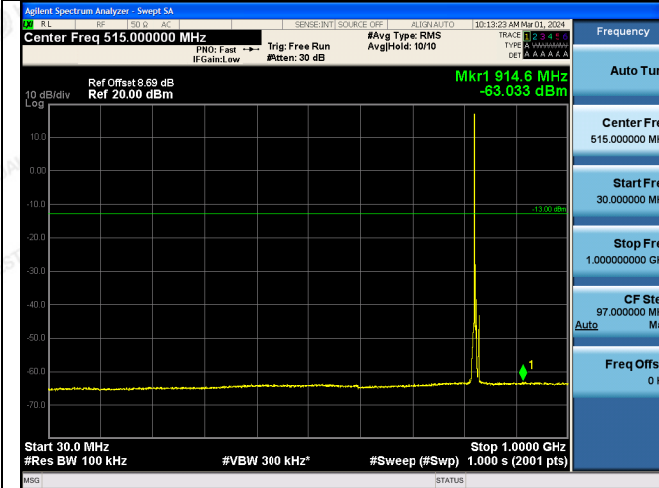

30MHz~1GHz

30MHz~1GHz

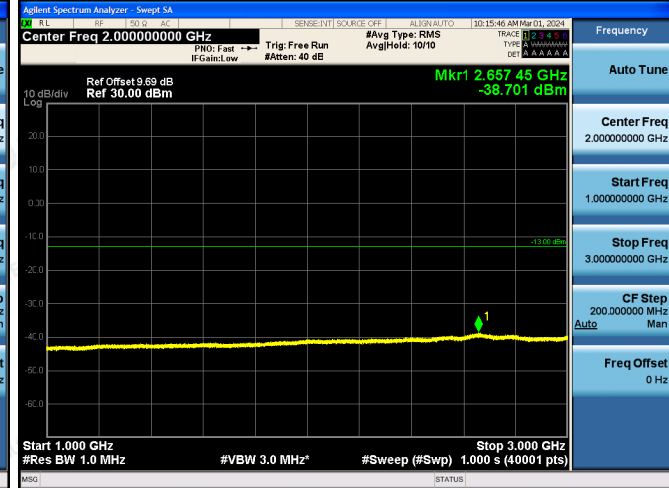
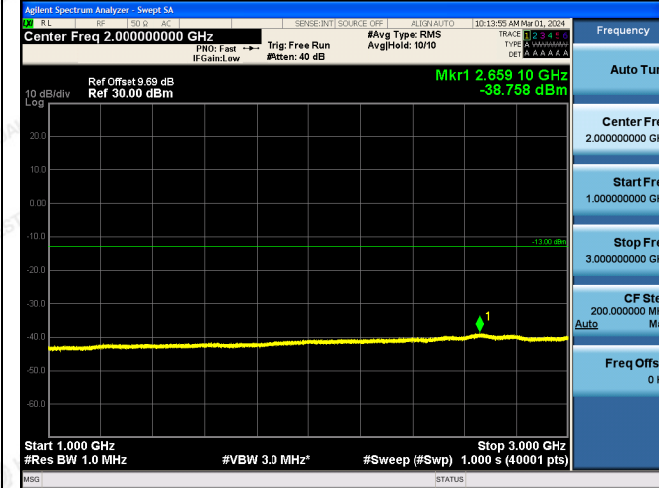

1GHz~3GHz

1GHz~3GHz

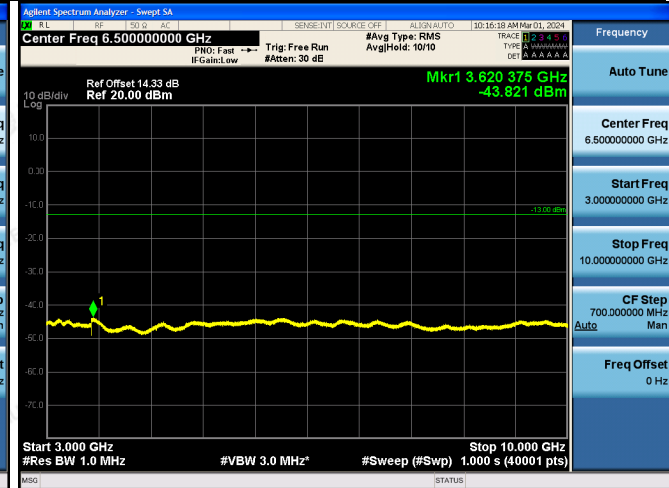
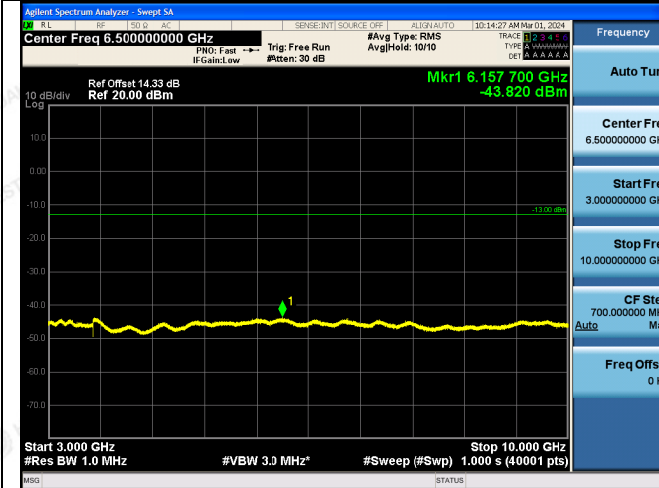

3GHz~10GHz

3GHz~10GHz

1RB#0

1RB#0

The results shown in this test report refer only to the sample(s) tested unless otherwise stated and the sample(s) are retained for 30 days only. The document is issued by HUAKE, this document cannot be reproduced except in full with our prior written permission. The more details and the authenticity of the report will be confirmed at <http://www.cer-mark.com>.

TEL : +86-755 2302 9901 FAX : +86-755 2302 9901 E-mail : service@cer-mark.com

Add: 1-2F., Building B2, Junfeng Zhongcheng Zhizao Innovation Park, Heping Community, Fuhai Street, Bao'an District, Shenzhen, Guangdong, China



LTE FDD Band 5-5 MHz Channel Bandwidth
Middle Channel

QPSK

16QAM

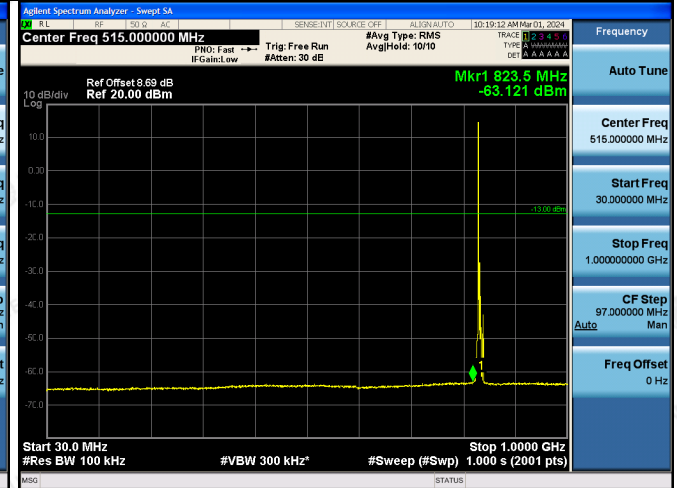
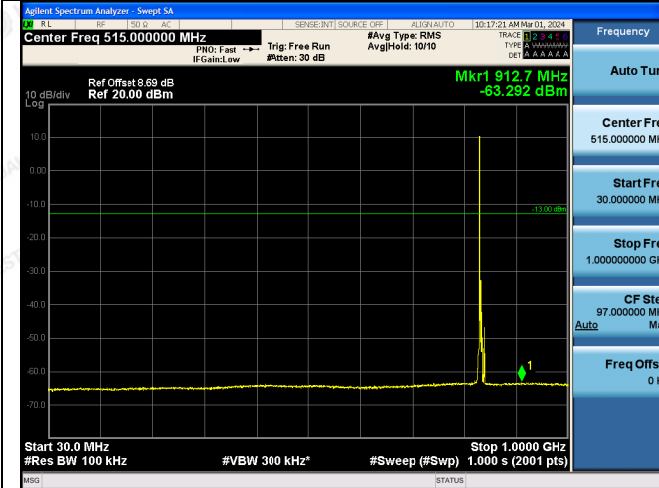

30MHz~1GHz

30MHz~1GHz

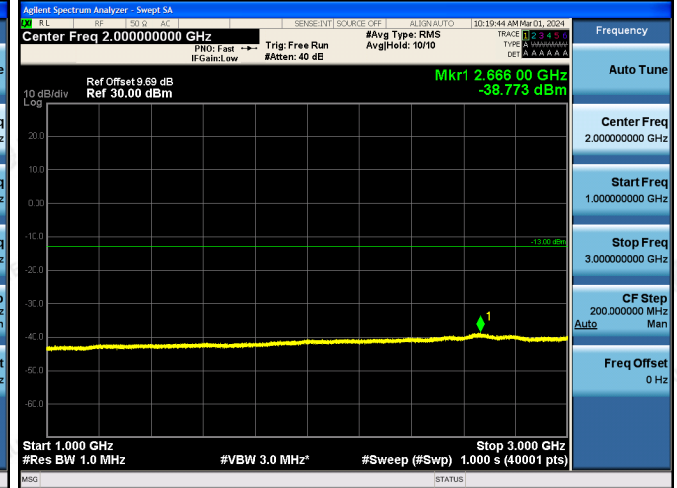
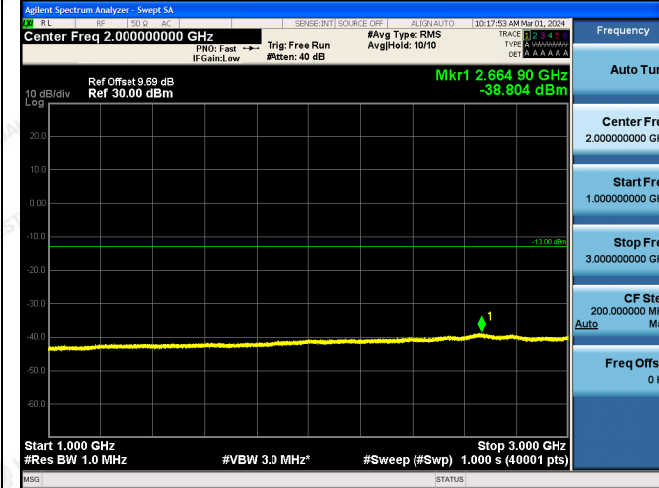

1GHz~3GHz

1GHz~3GHz

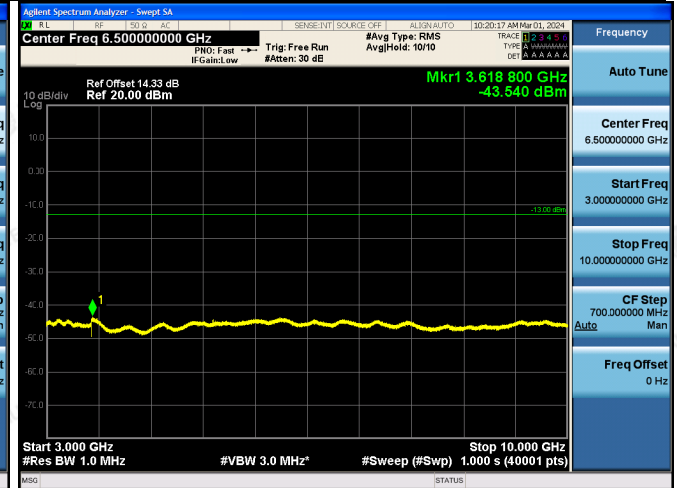
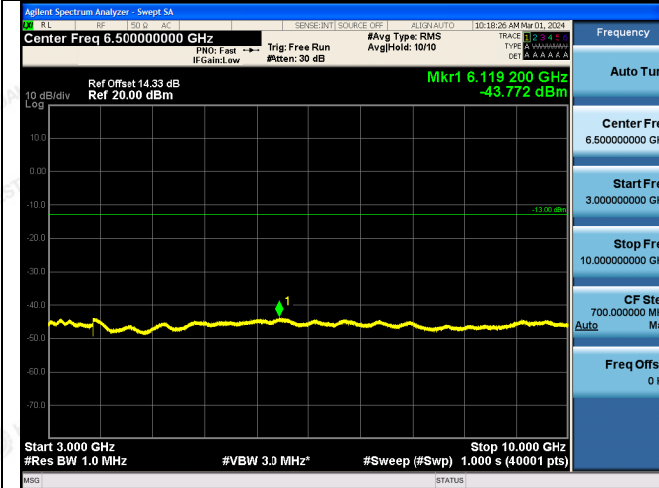

3GHz~10GHz

3GHz~10GHz

1RB#0

1RB#0



LTE FDD Band 5-5 MHz Channel Bandwidth
High Channel

QPSK

16QAM

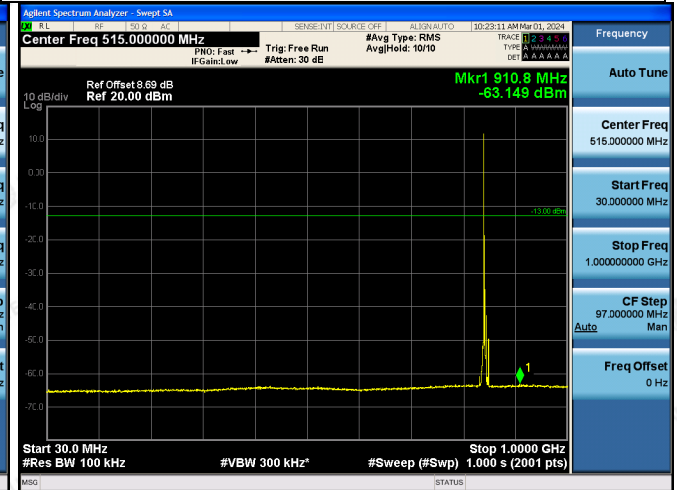
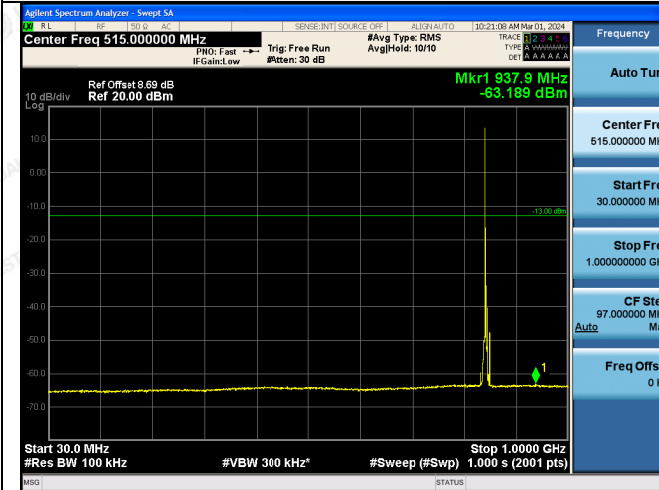

30MHz~1GHz

30MHz~1GHz

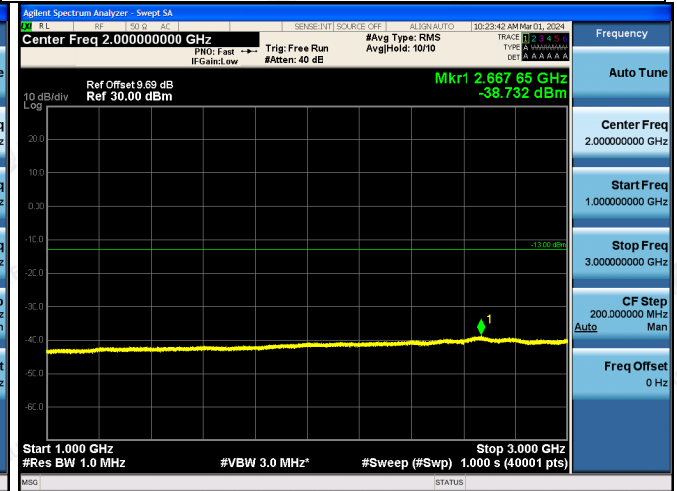
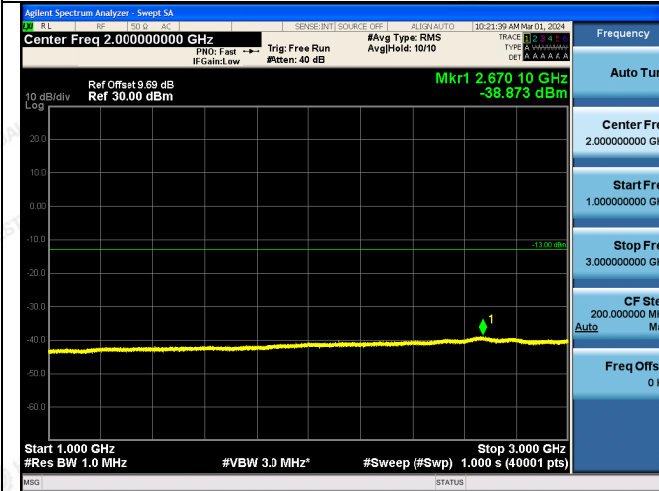

1GHz~3GHz

1GHz~3GHz

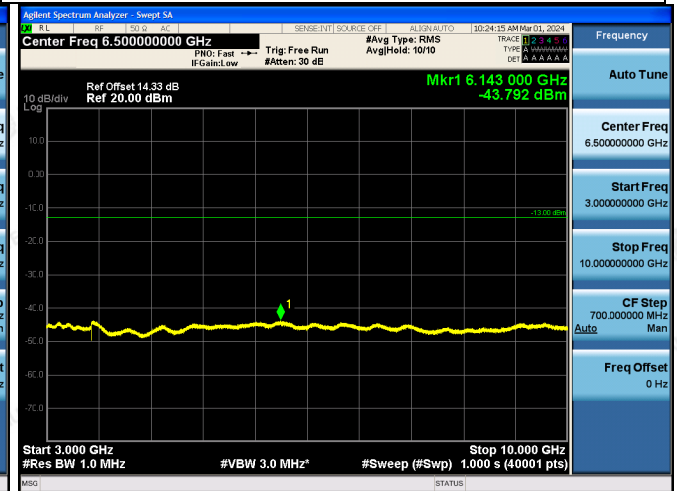
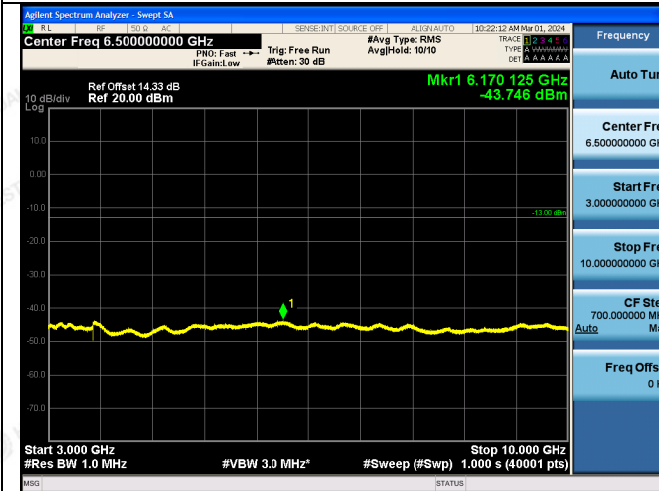

3GHz~10GHz

3GHz~10GHz

1RB#0

1RB#0

The results shown in this test report refer only to the sample(s) tested unless otherwise stated and the sample(s) are retained for 30 days only. The document is issued by HUAKE, this document cannot be reproduced except in full with our prior written permission. The more details and the authenticity of the report will be confirmed at <http://www.cer-mark.com>.

TEL : +86-755 2302 9901 FAX : +86-755 2302 9901 E-mail : service@cer-mark.com

Add: 1-2F., Building B2, Junfeng Zhongcheng Zhizao Innovation Park, Heping Community, Fuhai Street, Bao'an District, Shenzhen, Guangdong, China



LTE FDD Band 5-10 MHz Channel Bandwidth

Low Channel

QPSK

16QAM

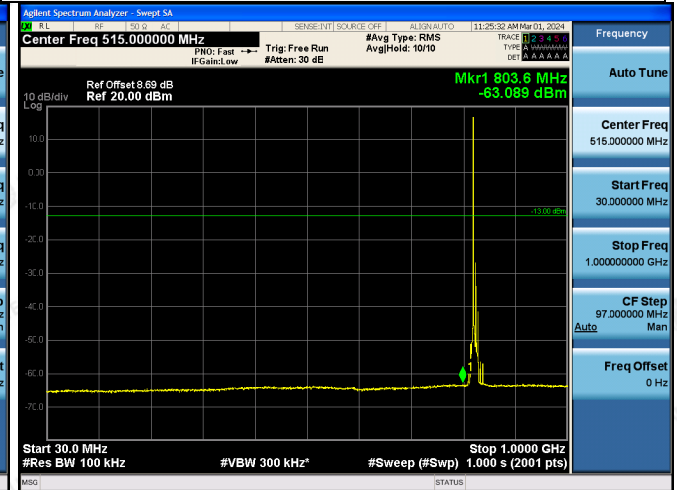
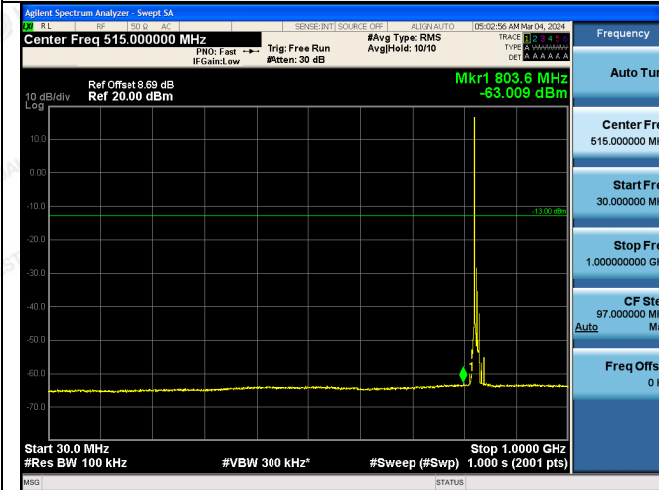

30MHz~1GHz

30MHz~1GHz

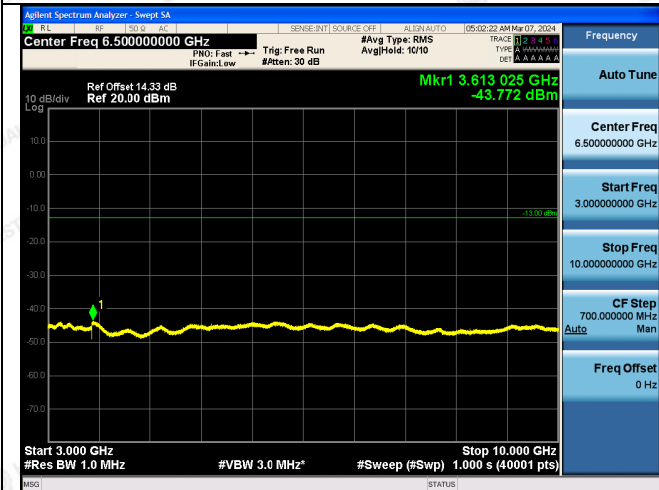

1GHz ~3GHz

1GHz ~3GHz

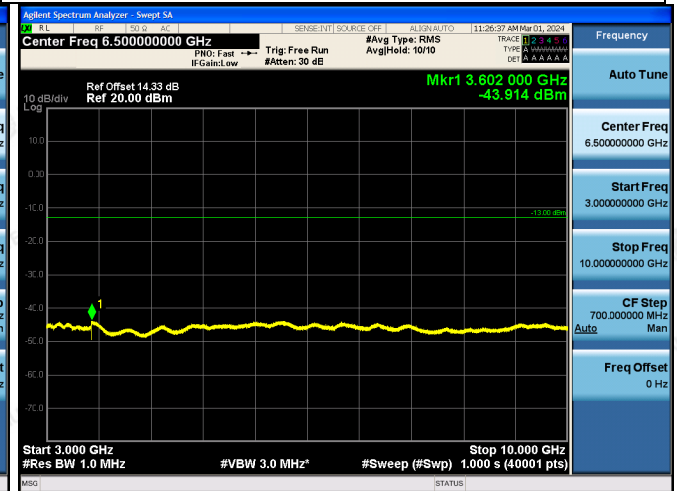
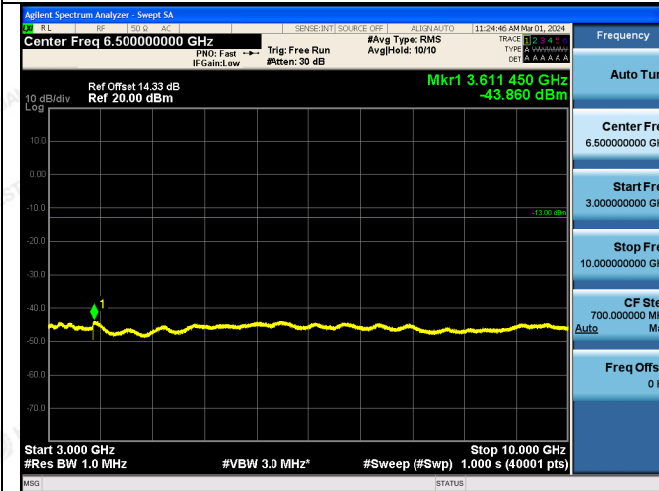

3GHz ~10GHz

1RB#0

3GHz ~10GHz

1RB#0

The results shown in this test report refer only to the sample(s) tested unless otherwise stated and the sample(s) are retained for 30 days only. This document is issued by HUAKE, this document cannot be reproduced except in full with our prior written permission. The more details and the authenticity of the report will be confirmed at <http://www.cer-mark.com>.

TEL : +86-755 2302 9901 FAX : +86-755 2302 9901 E-mail : service@cer-mark.com

Add: 1-2F., Building B2, Junfeng Zhongcheng Zhizao Innovation Park, Heping Community, Fuhai Street, Bao'an District, Shenzhen, Guangdong, China



LTE FDD Band 5-10 MHz Channel Bandwidth
Middle Channel

QPSK

16QAM

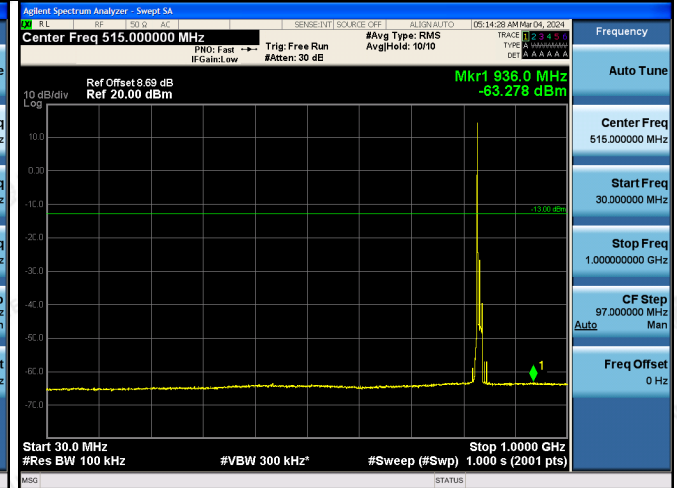
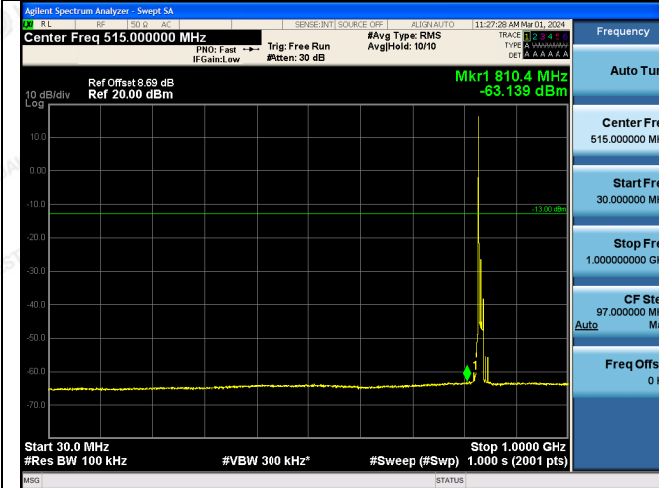

30MHz~1GHz

30MHz~1GHz

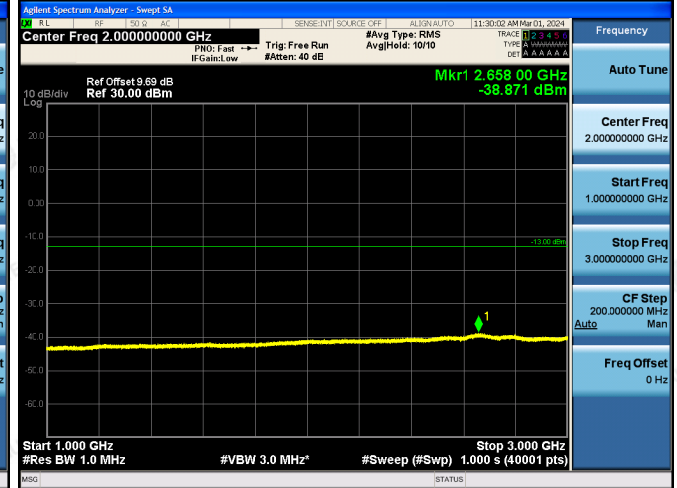
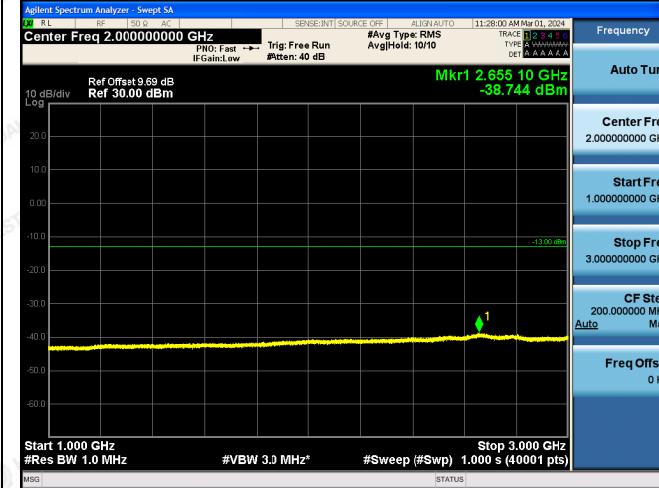

1GHz~3GHz

1GHz~3GHz

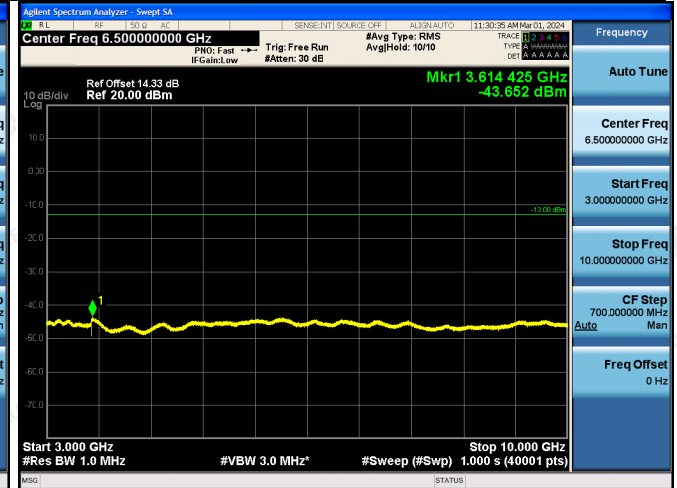
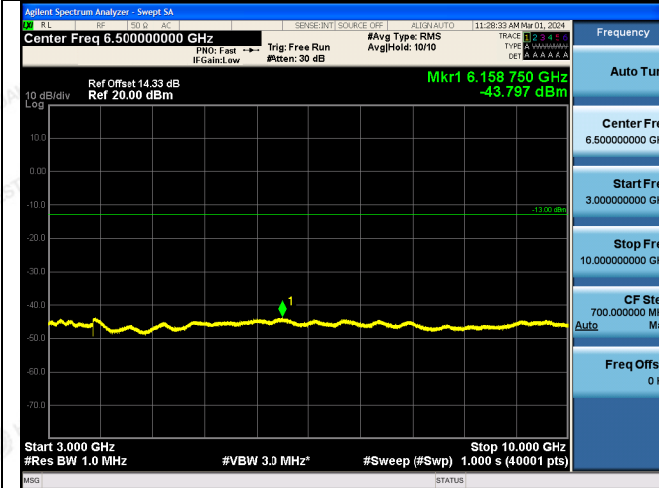

3GHz~10GHz

3GHz~10GHz

1RB#0

1RB#0

The results shown in this test report refer only to the sample(s) tested unless otherwise stated and the sample(s) are retained for 30 days only. The document is issued by HUAKE, this document cannot be reproduced except in full with our prior written permission. The more details and the authenticity of the report will be confirmed at <http://www.cer-mark.com>.

TEL : +86-755 2302 9901 FAX : +86-755 2302 9901 E-mail : service@cer-mark.com

Add: 1-2F., Building B2, Junfeng Zhongcheng Zhizao Innovation Park, Heping Community, Fuhai Street, Bao'an District, Shenzhen, Guangdong, China



LTE FDD Band 5-10 MHz Channel Bandwidth
High Channel

QPSK

16QAM

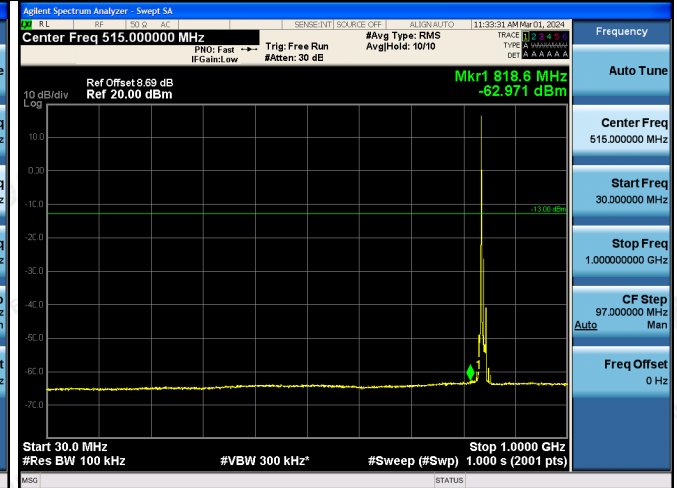
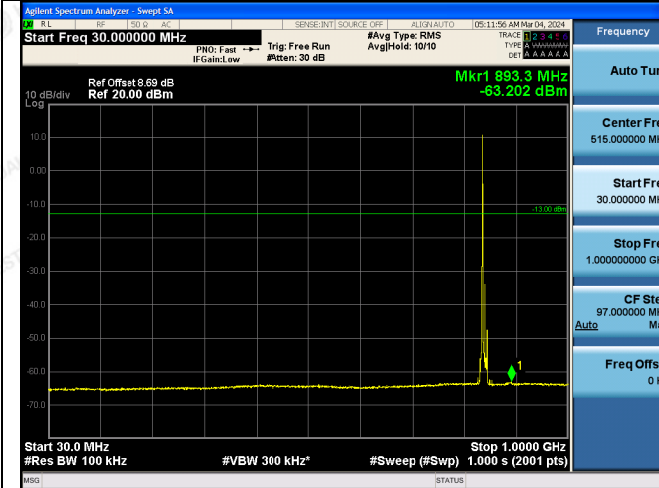

30MHz~1GHz

30MHz~1GHz

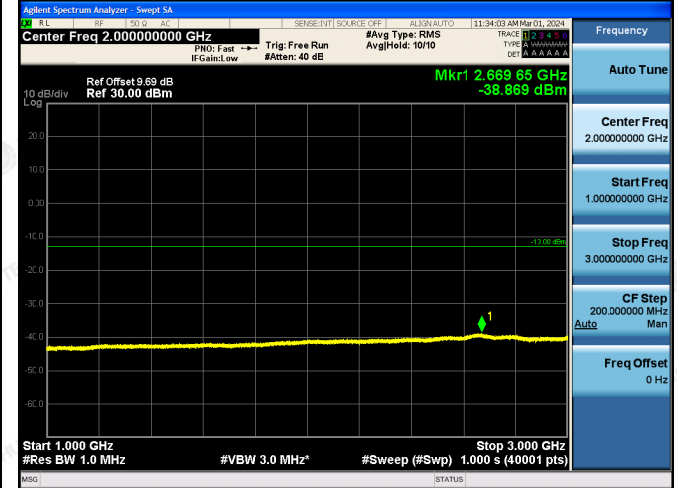
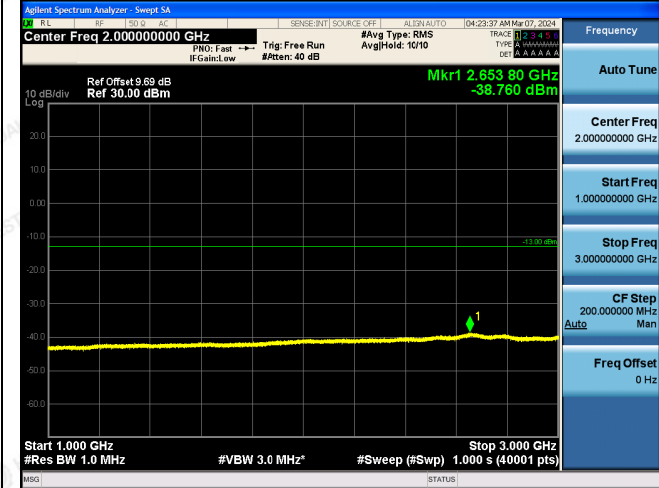

1GHz ~3GHz

1GHz ~3GHz

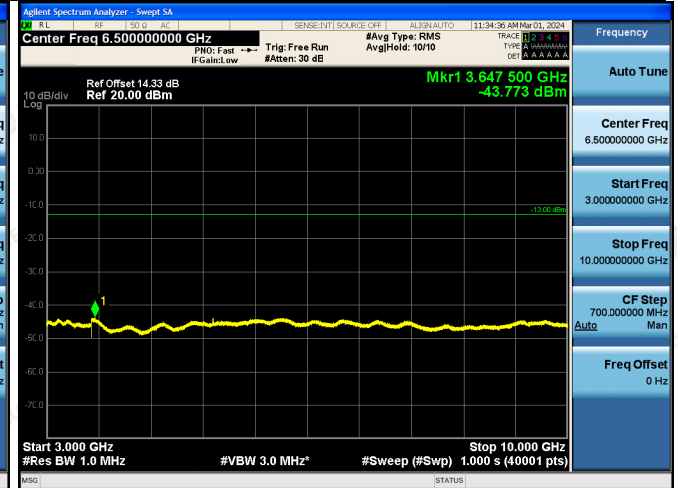
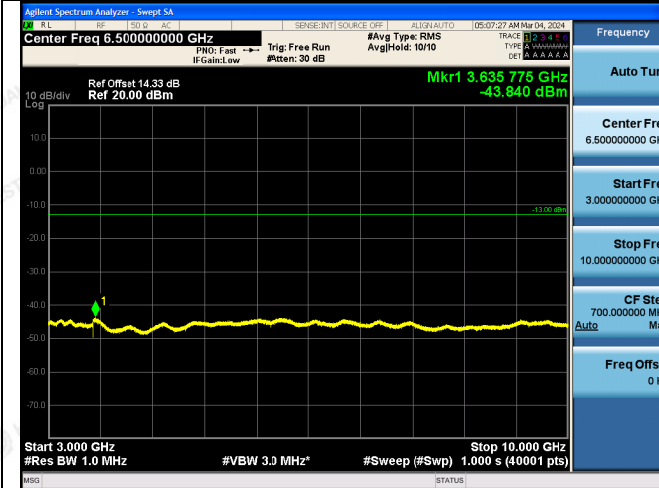

3GHz ~10GHz

3GHz ~10GHz

1RB#0

1RB#0

The results shown in this test report refer only to the sample(s) tested unless otherwise stated and the sample(s) are retained for 30 days only. The analysis is issued by HUAKE, this document cannot be reproduced except in full with our prior written permission. The more details and the authenticity of the report will be confirmed at <http://www.cer-mark.com>.

TEL : +86-755 2302 9901 FAX : +86-755 2302 9901 E-mail : service@cer-mark.com

Add: 1-2F., Building B2, Junfeng Zhongcheng Zhizao Innovation Park, Heping Community, Fuhai Street, Bao'an District, Shenzhen, Guangdong, China

4.6 Radiated Spurious Emission

TEST APPLICABLE

Per FCC §24.238, the power of any emission outside of the authorized operating frequency ranges must be attenuated below the transmitting power (P) by a factor of at least $43 + 10\log(P)$ dB.

TEST CONFIGURATION

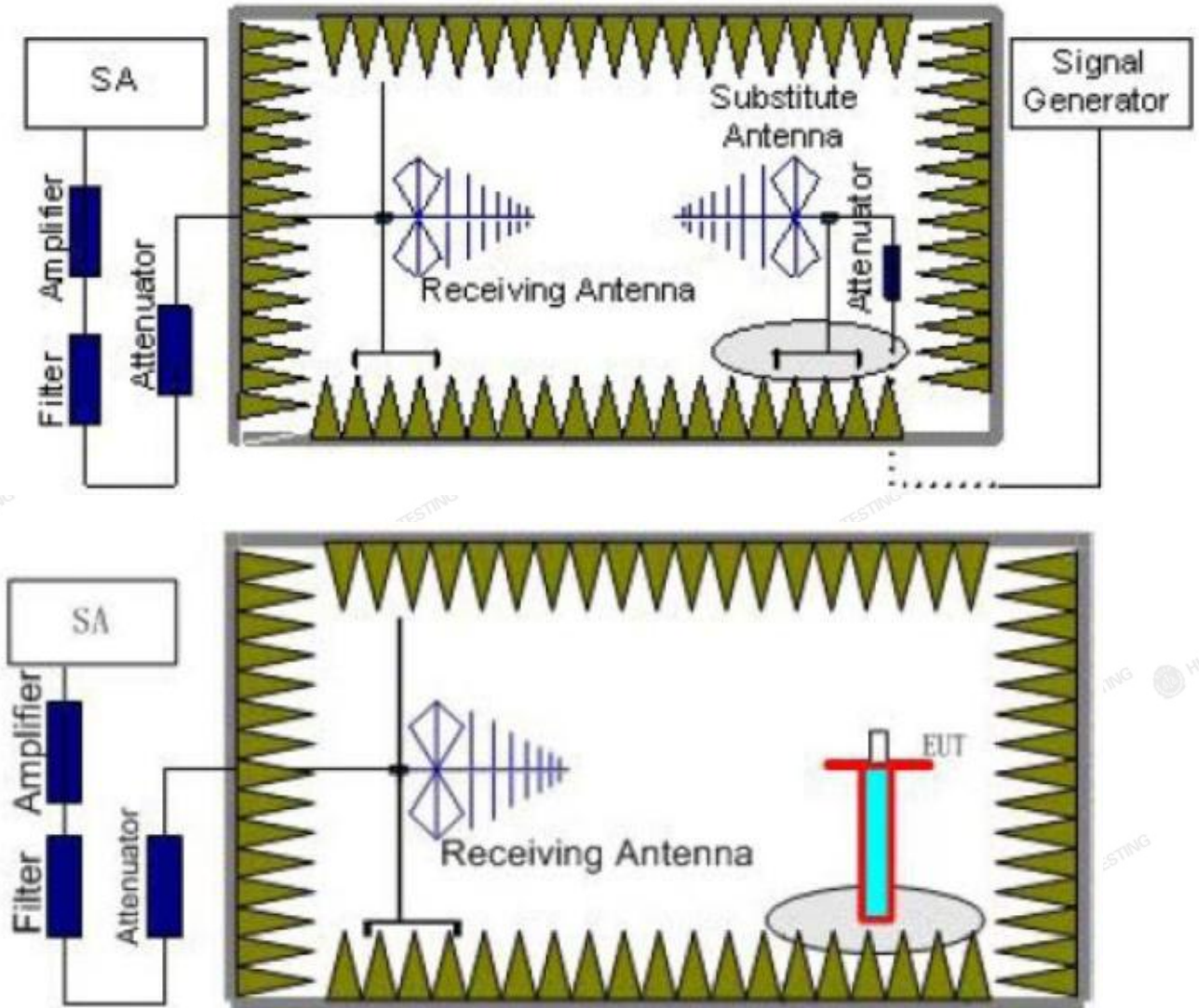

TEST PROCEDURE

1. EUT was placed on a 0.1 meter high non-conductive stand at a 3 meter test distance from the receive antenna. A receiving antenna was placed on the antenna mast 3 meters from the EUT for emission measurements. The height of receiving antenna is 0.1m. Detected emissions were maximized at each frequency by rotating the EUT through 360° and adjusting the receiving antenna polarization. The radiated emission measurements of all transmit frequencies in three channels (High, Middle, Low) were measured with peak detector.
2. A log-periodic antenna or double-ridged waveguide horn antenna shall be substituted in place of the EUT. The log-periodic antenna will be driven by a signal generator and the level will be adjusted till the same power value on the spectrum analyzer or receiver. The level of the spurious emissions can be calculated through the level of the signal generator, cable loss, the gain of the substitution antenna and the reading of the spectrum analyzer or receiver.



- The EUT is then put into continuously transmitting mode at its maximum power level during the test. Set Test Receiver or Spectrum RBW=1MHz, VBW=3MHz, And the maximum value of the receiver should be recorded as (P_r).
- The EUT shall be replaced by a substitution antenna. In the chamber, a substitution antenna for the frequency band of interest is placed at the reference point of the chamber. An RF Signal source for the frequency band of interest is connected to the substitution antenna with a cable that has been constructed to not interfere with the radiation pattern of the antenna. A power (P_{Mea}) is applied to the input of the substitution antenna, and adjust the level of the signal generator output until the value of the receiver reach the previously recorded (P_r). The power of signal source (P_{Mea}) is recorded. The test should be performed by rotating the test item and adjusting the receiving antenna polarization.
- A amplifier should be connected to the Signal Source output port. And the cable should be connect between the Amplifier and the Substitution Antenna. The cable loss (P_{cl}), the Substitution Antenna Gain (G_a) and the Amplifier Gain (P_{Ag}) should be recorded after test. The measurement results are obtained as described below:
Power(EIRP)=P_{Mea}- P_{Ag} - P_{cl}+ G_a
- This value is EIRP since the measurement is calibrated using an antenna of known gain (2.15 dBi) and known input power.
- ERP can be calculated from EIRP by subtracting the gain of the dipole, ERP = EIRP -2.15dBi.
- In order to make sure test results more clearly, we set frequency range and sweep time for difference frequency range as follows table:

Working Frequency	Subrange (GHz)	RBW	VBW	Sweep time (s)
LTE BAND 5	0.03~1	100KHz	300KHz	10
	1~20	1 MHz	3 MHz	2

TEST LIMITS

According to 24.238 specify that the power of any emission outside of the authorized operating frequency ranges must be attenuated below the transmitting power (P) by a factor of at least 43 + 10 log(P) dB. The specification that emissions shall be attenuated below the transmitter power (P) by at least 43 + 10 log (P) dB, translates in the relevant power range (1 to 0.001 W) to -13 dBm. At 1 W the specified minimum attenuation becomes 43 dB and relative to a 30 dBm (1 W) carrier becomes a limit of -13 dBm. At 0.001 W (0 dBm) the minimum attenuation is 13 dB, which again yields a limit of -13 dBm. In this way a translation of the specification from relative to absolute terms is carried out.

Frequency	Channel	Frequency Range	Verdict
LTE BAND 5	Low	30MHz -20GHz	PASS
	Middle	30MHz -20GHz	PASS
	High	30MHz -20GHz	PASS

Radiated Measurement:

Remark:

- We measured all RB Configuration refer 3GPP TS136 521 for each Channel Bandwidth of LTE BAND 5; recorded worst case for each Channel Bandwidth of LTE BAND 5.
- EIRP=P_{Mea}(dBm)-P_{cl}(dB) +G_a(dBi)
- Not recorded other points as values lower than limits.
- Margin = Limit – EIRP



LTE FDD Band 5_Channel Bandwidth 1.4MHz_QPSK_Low Channel

Frequency (MHz)	P _{Mea} (dBm)	P _{cl} (dB)	Diatance	G _a Antenna Gain(dB)	Peak EIRP (dBm)	Limit (dBm)	Margin (dB)	Polarization
1649.4	-41.97	3.00	3.00	9.58	-35.39	-13.00	22.39	H
2474.1	-42.61	3.03	3.00	10.72	-34.92	-13.00	21.92	H
1649.4	-43.22	3.00	3.00	9.68	-36.54	-13.00	23.54	V
2474.1	-40.96	3.03	3.00	10.72	-33.27	-13.00	20.27	V

LTE FDD Band 5_Channel Bandwidth 1.4MHz_QPSK_Middle Channel

Frequency (MHz)	P _{Mea} (dBm)	P _{cl} (dB)	Diatance	G _a Antenna Gain(dB)	Peak EIRP (dBm)	Limit (dBm)	Margin (dB)	Polarization
1673.0	-42.35	3.00	3.00	9.58	-35.77	-13.00	22.77	H
2509.5	-42.11	3.03	3.00	10.72	-34.42	-13.00	21.42	H
1673.0	-44.17	3.00	3.00	9.68	-37.49	-13.00	24.49	V
2509.5	-40.91	3.03	3.00	10.72	-33.22	-13.00	20.22	V

LTE FDD Band 5_Channel Bandwidth 1.4MHz_QPSK_High Channel

Frequency (MHz)	P _{Mea} (dBm)	P _{cl} (dB)	Diatance	G _a Antenna Gain(dB)	Peak EIRP (dBm)	Limit (dBm)	Margin (dB)	Polarization
1696.6	-41.41	3.00	3.00	9.58	-34.83	-13.00	21.83	H
2544.9	-42.75	3.03	3.00	10.72	-35.06	-13.00	22.06	H
1696.6	-43.11	3.00	3.00	9.68	-36.43	-13.00	23.43	V
2544.9	-42.46	3.03	3.00	10.72	-34.77	-13.00	21.77	V

LTE FDD Band 5_Channel Bandwidth 3MHz_QPSK_Low Channel

Frequency (MHz)	P _{Mea} (dBm)	P _{cl} (dB)	Diatance	G _a Antenna Gain(dB)	Peak EIRP (dBm)	Limit (dBm)	Margin (dB)	Polarization
1651.0	-42.1	3.00	3.00	9.58	-35.52	-13.00	22.52	H
2476.5	-43.24	3.03	3.00	10.72	-35.55	-13.00	22.55	H
1651.0	-43.47	3.00	3.00	9.68	-36.79	-13.00	23.79	V
2476.5	-40.99	3.03	3.00	10.72	-33.3	-13.00	20.3	V

LTE FDD Band 5_Channel Bandwidth 3MHz_QPSK_Middle Channel

Frequency (MHz)	P _{Mea} (dBm)	P _{cl} (dB)	Diatance	G _a Antenna Gain(dB)	Peak EIRP (dBm)	Limit (dBm)	Margin (dB)	Polarization
1673.0	-42.67	3.00	3.00	9.58	-36.09	-13.00	23.09	H
2509.5	-42.43	3.03	3.00	10.72	-34.74	-13.00	21.74	H
1673.0	-42.89	3.00	3.00	9.68	-36.21	-13.00	23.21	V
2509.5	-41.58	3.03	3.00	10.72	-33.89	-13.00	20.89	V

LTE FDD Band 5_Channel Bandwidth 3MHz_QPSK_High Channel

Frequency (MHz)	P _{Mea} (dBm)	P _{cl} (dB)	Diatance	G _a Antenna Gain(dB)	Peak EIRP (dBm)	Limit (dBm)	Margin (dB)	Polarization
1695.0	-41.66	3.00	3.00	9.58	-35.08	-13.00	22.08	H
2542.5	-42.67	3.03	3.00	10.72	-34.98	-13.00	21.98	H
1695.0	-42.31	3.00	3.00	9.68	-35.63	-13.00	22.63	V
2542.5	-41.54	3.03	3.00	10.72	-33.85	-13.00	20.85	V

The results shown in this test report refer only to the sample(s) tested unless otherwise stated and the sample(s) are retained for 30 days only. The document is issued by HUAKE, this document cannot be reproduced except in full with our prior written permission. The more details and the authenticity of the report will be confirmed at <http://www.cer-mark.com>.

TEL : +86-755 2302 9901 FAX : +86-755 2302 9901 E-mail : service@cer-mark.com

Add: 1-2F., Building B2, Junfeng Zhongcheng Zhizao Innovation Park, Heping Community, Fuhai Street, Bao'an District, Shenzhen, Guangdong, China



LTE FDD Band 5_Channel Bandwidth 5MHz_QPSK_Low Channel

Frequency (MHz)	P _{Mea} (dBm)	P _{cl} (dB)	Diatance	G _a Antenna Gain(dB)	Peak EIRP (dBm)	Limit (dBm)	Margin (dB)	Polarization
1653.0	-43.08	3.00	3.00	9.58	-36.5	-13.00	23.5	H
2479.5	-42.91	3.03	3.00	10.72	-35.22	-13.00	22.22	H
1653.0	-42.44	3.00	3.00	9.68	-35.76	-13.00	22.76	V
2479.5	-41.04	3.03	3.00	10.72	-33.35	-13.00	20.35	V

LTE FDD Band 5_Channel Bandwidth 5MHz_QPSK_Middle Channel

Frequency (MHz)	P _{Mea} (dBm)	P _{cl} (dB)	Diatance	G _a Antenna Gain(dB)	Peak EIRP (dBm)	Limit (dBm)	Margin (dB)	Polarization
1673.0	-43.02	3.00	3.00	9.58	-36.44	-13.00	23.44	H
2509.5	-43.82	3.03	3.00	10.72	-36.13	-13.00	23.13	H
1673.0	-42.82	3.00	3.00	9.68	-36.14	-13.00	23.14	V
2509.5	-41.18	3.03	3.00	10.72	-33.49	-13.00	20.49	V

LTE FDD Band 5_Channel Bandwidth 5MHz_QPSK_High Channel

Frequency (MHz)	P _{Mea} (dBm)	P _{cl} (dB)	Diatance	G _a Antenna Gain(dB)	Peak EIRP (dBm)	Limit (dBm)	Margin (dB)	Polarization
1693.0	-41.84	3.00	3.00	9.58	-35.26	-13.00	22.26	H
2539.5	-43.29	3.03	3.00	10.72	-35.6	-13.00	22.6	H
1693.0	-43.34	3.00	3.00	9.68	-36.66	-13.00	23.66	V
2539.5	-42.83	3.03	3.00	10.72	-35.14	-13.00	22.14	V

LTE FDD Band 5_Channel Bandwidth 10MHz_QPSK_Low Channel

Frequency (MHz)	P _{Mea} (dBm)	P _{cl} (dB)	Diatance	G _a Antenna Gain(dB)	Peak EIRP (dBm)	Limit (dBm)	Margin (dB)	Polarization
1658.0	-42.48	3.00	3.00	9.58	-35.9	-13.00	22.9	H
2487.0	-42.66	3.03	3.00	10.72	-34.97	-13.00	21.97	H
1658.0	-42.15	3.00	3.00	9.68	-35.47	-13.00	22.47	V
2487.0	-40.17	3.03	3.00	10.72	-32.48	-13.00	19.48	V

LTE FDD Band 5_Channel Bandwidth 10MHz_QPSK_Middle Channel

Frequency (MHz)	P _{Mea} (dBm)	P _{cl} (dB)	Diatance	G _a Antenna Gain(dB)	Peak EIRP (dBm)	Limit (dBm)	Margin (dB)	Polarization
1673.0	-42.56	3.00	3.00	9.58	-35.98	-13.00	22.98	H
2509.5	-43.92	3.03	3.00	10.72	-36.23	-13.00	23.23	H
1673.0	-43.21	3.00	3.00	9.68	-36.53	-13.00	23.53	V
2509.5	-41.71	3.03	3.00	10.72	-34.02	-13.00	21.02	V

LTE FDD Band 5_Channel Bandwidth 10MHz_QPSK_High Channel

Frequency (MHz)	P _{Mea} (dBm)	P _{cl} (dB)	Diatance	G _a Antenna Gain(dB)	Peak EIRP (dBm)	Limit (dBm)	Margin (dB)	Polarization
1688.0	-43.25	3.00	3.00	9.58	-36.67	-13.00	23.67	H
2532.0	-42.76	3.03	3.00	10.72	-35.07	-13.00	22.07	H
1688.0	-42.25	3.00	3.00	9.68	-35.57	-13.00	22.57	V
2532.0	-42.58	3.03	3.00	10.72	-34.89	-13.00	21.89	V

The results shown in this test report refer only to the sample(s) tested unless otherwise stated and the sample(s) are retained for 30 days only. The document is issued by HUAKE, this document cannot be reproduced except in full with our prior written permission. The more details and the authenticity of the report will be confirmed at <http://www.cer-mark.com>.

TEL : +86-755 2302 9901 FAX : +86-755 2302 9901 E-mail : service@cer-mark.com

Add: 1-2F., Building B2, Junfeng Zhongcheng Zhizao Innovation Park, Heping Community, Fuhai Street, Bao'an District, Shenzhen, Guangdong, China



LTE FDD Band 5 Channel Bandwidth 1.4MHz 16QAM Low Channel

Frequency (MHz)	P _{Mea} (dBm)	P _{cl} (dB)	Diatance	G _a Antenna Gain(dB)	Peak EIRP (dBm)	Limit (dBm)	Margin (dB)	Polarization
1649.4	-42.83	3.00	3.00	9.58	-36.25	-13.00	23.25	H
2474.1	-42.89	3.03	3.00	10.72	-35.2	-13.00	22.2	H
1649.4	-42.66	3.00	3.00	9.68	-35.98	-13.00	22.98	V
2474.1	-40.91	3.03	3.00	10.72	-33.22	-13.00	20.22	V

LTE FDD Band 5 Channel Bandwidth 1.4MHz 16QAM Middle Channel

Frequency (MHz)	P _{Mea} (dBm)	P _{cl} (dB)	Diatance	G _a Antenna Gain(dB)	Peak EIRP (dBm)	Limit (dBm)	Margin (dB)	Polarization
1673.0	-43.75	3.00	3.00	9.58	-37.17	-13.00	24.17	H
2509.5	-42.97	3.03	3.00	10.72	-35.28	-13.00	22.28	H
1673.0	-42.88	3.00	3.00	9.68	-36.2	-13.00	23.2	V
2509.5	-41.13	3.03	3.00	10.72	-33.44	-13.00	20.44	V

LTE FDD Band 5 Channel Bandwidth 1.4MHz 16QAM High Channel

Frequency (MHz)	P _{Mea} (dBm)	P _{cl} (dB)	Diatance	G _a Antenna Gain(dB)	Peak EIRP (dBm)	Limit (dBm)	Margin (dB)	Polarization
1696.6	-41.54	3.00	3.00	9.58	-34.96	-13.00	21.96	H
2544.9	-43.62	3.03	3.00	10.72	-35.93	-13.00	22.93	H
1696.6	-43.03	3.00	3.00	9.68	-36.35	-13.00	23.35	V
2544.9	-41.04	3.03	3.00	10.72	-33.35	-13.00	20.35	V

LTE FDD Band 5 Channel Bandwidth 3MHz 16QAM Low Channel

Frequency (MHz)	P _{Mea} (dBm)	P _{cl} (dB)	Diatance	G _a Antenna Gain(dB)	Peak EIRP (dBm)	Limit (dBm)	Margin (dB)	Polarization
1651.0	-43.88	3.00	3.00	9.58	-37.3	-13.00	24.3	H
2476.5	-42.77	3.03	3.00	10.72	-35.08	-13.00	22.08	H
1651.0	-43.02	3.00	3.00	9.68	-36.34	-13.00	23.34	V
2476.5	-41.84	3.03	3.00	10.72	-34.15	-13.00	21.15	V

LTE FDD Band 5 Channel Bandwidth 3MHz 16QAM Middle Channel

Frequency (MHz)	P _{Mea} (dBm)	P _{cl} (dB)	Diatance	G _a Antenna Gain(dB)	Peak EIRP (dBm)	Limit (dBm)	Margin (dB)	Polarization
1673.0	-41.74	3.00	3.00	9.58	-35.16	-13.00	22.16	H
2509.5	-43.77	3.03	3.00	10.72	-36.08	-13.00	23.08	H
1673.0	-43.79	3.00	3.00	9.68	-37.11	-13.00	24.11	V
2509.5	-41.42	3.03	3.00	10.72	-33.73	-13.00	20.73	V

LTE FDD Band 5 Channel Bandwidth 3MHz 16QAM High Channel

Frequency (MHz)	P _{Mea} (dBm)	P _{cl} (dB)	Diatance	G _a Antenna Gain(dB)	Peak EIRP (dBm)	Limit (dBm)	Margin (dB)	Polarization
1695.0	-42.54	3.00	3.00	9.58	-35.96	-13.00	22.96	H
2542.5	-42.82	3.03	3.00	10.72	-35.13	-13.00	22.13	H
1695.0	-42.99	3.00	3.00	9.68	-36.31	-13.00	23.31	V
2542.5	-42.47	3.03	3.00	10.72	-34.78	-13.00	21.78	V

The results shown in this test report refer only to the sample(s) tested unless otherwise stated and the sample(s) are retained for 30 days only. The document is issued by HUAKE, this document cannot be reproduced except in full with our prior written permission. The more details and the authenticity of the report will be confirmed at <http://www.cer-mark.com>.

TEL : +86-755 2302 9901 FAX : +86-755 2302 9901 E-mail : service@cer-mark.com

Add: 1-2F., Building B2, Junfeng Zhongcheng Zhizao Innovation Park, Heping Community, Fuhai Street, Bao'an District, Shenzhen, Guangdong, China



LTE FDD Band 5_Channel Bandwidth 5MHz_16QAM_Low Channel

Frequency (MHz)	P _{Mea} (dBm)	P _{cl} (dB)	Diatance	G _a Antenna Gain(dB)	Peak EIRP (dBm)	Limit (dBm)	Margin (dB)	Polarization
1653.0	-42.69	3.00	3.00	9.58	-36.11	-13.00	23.11	H
2479.5	-43.62	3.03	3.00	10.72	-35.93	-13.00	22.93	H
1653.0	-42.1	3.00	3.00	9.68	-35.42	-13.00	22.42	V
2479.5	-40.63	3.03	3.00	10.72	-32.94	-13.00	19.94	V

LTE FDD Band 5_Channel Bandwidth 5MHz_16QAM_Middle Channel

Frequency (MHz)	P _{Mea} (dBm)	P _{cl} (dB)	Diatance	G _a Antenna Gain(dB)	Peak EIRP (dBm)	Limit (dBm)	Margin (dB)	Polarization
1673.0	-43.39	3.00	3.00	9.58	-36.81	-13.00	23.81	H
2509.5	-42.62	3.03	3.00	10.72	-34.93	-13.00	21.93	H
1673.0	-42.81	3.00	3.00	9.68	-36.13	-13.00	23.13	V
2509.5	-42.55	3.03	3.00	10.72	-34.86	-13.00	21.86	V

LTE FDD Band 5_Channel Bandwidth 5MHz_16QAM_High Channel

Frequency (MHz)	P _{Mea} (dBm)	P _{cl} (dB)	Diatance	G _a Antenna Gain(dB)	Peak EIRP (dBm)	Limit (dBm)	Margin (dB)	Polarization
1693.0	-42.83	3.00	3.00	9.58	-36.25	-13.00	23.25	H
2539.5	-42.13	3.03	3.00	10.72	-34.44	-13.00	21.44	H
1693.0	-42.59	3.00	3.00	9.68	-35.91	-13.00	22.91	V
2539.5	-42.09	3.03	3.00	10.72	-34.4	-13.00	21.4	V

LTE FDD Band 5_Channel Bandwidth 10MHz_16QAM_Low Channel

Frequency (MHz)	P _{Mea} (dBm)	P _{cl} (dB)	Diatance	G _a Antenna Gain(dB)	Peak EIRP (dBm)	Limit (dBm)	Margin (dB)	Polarization
1658.0	-43.51	3.00	3.00	9.58	-36.93	-13.00	23.93	H
2487.0	-43.24	3.03	3.00	10.72	-35.55	-13.00	22.55	H
1658.0	-42.26	3.00	3.00	9.68	-35.58	-13.00	22.58	V
2487.0	-41.59	3.03	3.00	10.72	-33.9	-13.00	20.9	V

LTE FDD Band 5_Channel Bandwidth 10MHz_16QAM_Middle Channel

Frequency (MHz)	P _{Mea} (dBm)	P _{cl} (dB)	Diatance	G _a Antenna Gain(dB)	Peak EIRP (dBm)	Limit (dBm)	Margin (dB)	Polarization
1673.0	-42.42	3.00	3.00	9.58	-35.84	-13.00	22.84	H
2509.5	-42.23	3.03	3.00	10.72	-34.54	-13.00	21.54	H
1673.0	-43.11	3.00	3.00	9.68	-36.43	-13.00	23.43	V
2509.5	-41.68	3.03	3.00	10.72	-33.99	-13.00	20.99	V

LTE FDD Band 5_Channel Bandwidth 10MHz_16QAM_High Channel

Frequency (MHz)	P _{Mea} (dBm)	P _{cl} (dB)	Diatance	G _a Antenna Gain(dB)	Peak EIRP (dBm)	Limit (dBm)	Margin (dB)	Polarization
1688.0	-41.67	3.00	3.00	9.58	-35.09	-13.00	22.09	H
2532.0	-42.98	3.03	3.00	10.72	-35.29	-13.00	22.29	H
1688.0	-42.52	3.00	3.00	9.68	-35.84	-13.00	22.84	V
2532.0	-42.9	3.03	3.00	10.72	-35.21	-13.00	22.21	V

The results shown in this test report refer only to the sample(s) tested unless otherwise stated and the sample(s) are retained for 30 days only. The document is issued by HUAKE, this document cannot be reproduced except in full with our prior written permission. The more details and the authenticity of the report will be confirmed at <http://www.cer-mark.com>.

TEL : +86-755 2302 9901 FAX : +86-755 2302 9901 E-mail : service@cer-mark.com

Add: 1-2F., Building B2, Junfeng Zhongcheng Zhizao Innovation Park, Heping Community, Fuhai Street, Bao'an District, Shenzhen, Guangdong, China



4.7 Frequency Stability

LIMIT

According to §24.235, §2.1055 requirement, the frequency stability shall be sufficient to ensure that the fundamental emissions stay within the authorized bands of operation and should not exceed 2.5ppm.

TEST CONFIGURATION

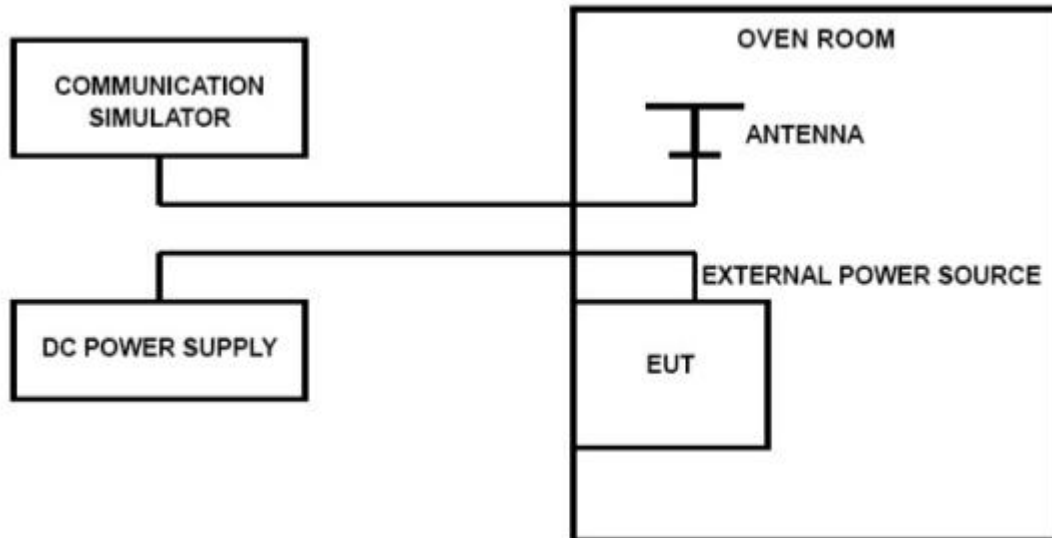

TEST PROCEDURE

The EUT was setup according to EIA/TIA 603D.

Frequency Stability Under Temperature Variations:

In order to measure the carrier frequency under the condition of AFC lock, it is necessary to make measurements with the EUT in a "call mode". This is accomplished with the use of R&S CMW500 DIGITAL RADIO COMMUNICATION TESTER.

1. Measure the carrier frequency at room temperature.
2. Subject the EUT to overnight soak at -30°C.
3. With the EUT, powered via nominal voltage, connected to the CMW500 and in a simulated call on middle channel for LTE Band 5, measure the carrier frequency. These measurements should be made within 2 minutes of Powering up the EUT, to prevent significant self-warming.
4. Repeat the above measurements at 10°C increments from -30°C to +50°C. Allow at least 1.5 hours at each temperature, unpowered, before making measurements.
5. Re-measure carrier frequency at room temperature with nominal voltage. Vary supply voltage from minimum voltage to maximum voltage, in 0.1Volt increments re-measuring carrier frequency at each voltage. Pause at nominal voltage for 1.5 hours unpowered, to allow any self-heating to stabilize, before continuing.
6. Subject the EUT to overnight soak at +50°C.
7. With the EUT, powered via nominal voltage, connected to the CMW500 and in a simulated call on the centre channel, measure the carrier frequency. These measurements should be made within 2 minutes of Powering up the EUT, to prevent significant self-warming.
8. Repeat the above measurements at 10 °C increments from +50°C to -30°C. Allow at least 1.5 hours at each temperature, unpowered, before making measurements.
9. At all temperature levels hold the temperature to +/- 0.5°C during the measurement procedure.

Frequency Stability Under Voltage Variations:

Set chamber temperature to 20°C. Use a variable AC power supply / DC power source to power the EUT and set the voltage to rated voltage. Set the spectrum analyzer RBW low enough to obtain the desired frequency resolution and recorded the frequency.

Reduce the input voltage to specify extreme voltage variation ($\pm 15\%$) and endpoint, record the maximum frequency change.



TEST RESULTS

Remark:

1. We tested all RB Configuration refer 3GPP TS136 521 for each Channel Bandwidth of LTE FDD Band 5; recorded worst case.

LTE Band 5, 1.4MHz bandwidth , QPSK (worst case of all bandwidths)

LTE FDD Band 5					
DC Power(V)	Temperature (°C)	Frequency error(Hz)	Frequency error(ppm)	Limit (ppm)	Verdict
10.2	20	-3.65	-0.004426	±2.50	PASS
12.0	20	-3.26	-0.003953	±2.50	PASS
13.8	20	-3.19	-0.003868	±2.50	PASS
12.0	-30	-3.88	-0.004705	±2.50	PASS
12.0	-20	-5.91	-0.007166	±2.50	PASS
12.0	-10	-3.50	-0.004244	±2.50	PASS
12.0	0	-3.20	-0.003880	±2.50	PASS
12.0	10	-4.02	-0.004874	±2.50	PASS
12.0	20	-4.35	-0.005275	±2.50	PASS
12.0	30	-2.53	-0.003025	±2.50	PASS
12.0	40	-3.95	-0.004722	±2.50	PASS
12.0	50	-4.32	-0.005164	±2.50	PASS

LTE Band 5, 1.4MHz bandwidth, 16QAM (worst case of all bandwidths)

LTE FDD Band 5					
DC Power(V)	Temperature (°C)	Frequency error(Hz)	Frequency error(ppm)	Limit (ppm)	Verdict
10.2	20	-3.02	-0.003662	±2.50	PASS
12.0	20	-4.71	-0.005711	±2.50	PASS
13.8	20	-3.75	-0.004547	±2.50	PASS
12.0	-30	-3.35	-0.004062	±2.50	PASS
12.0	-20	-3.75	-0.004547	±2.50	PASS
12.0	-10	-3.03	-0.003674	±2.50	PASS
12.0	0	-3.18	-0.003856	±2.50	PASS
12.0	10	-3.86	-0.004680	±2.50	PASS
12.0	20	-3.48	-0.004220	±2.50	PASS
12.0	30	-3.59	-0.004292	±2.50	PASS
12.0	40	3.20	0.003825	±2.50	PASS
12.0	50	-3.43	-0.004100	±2.50	PASS



5 Test Setup Photos of the EUT

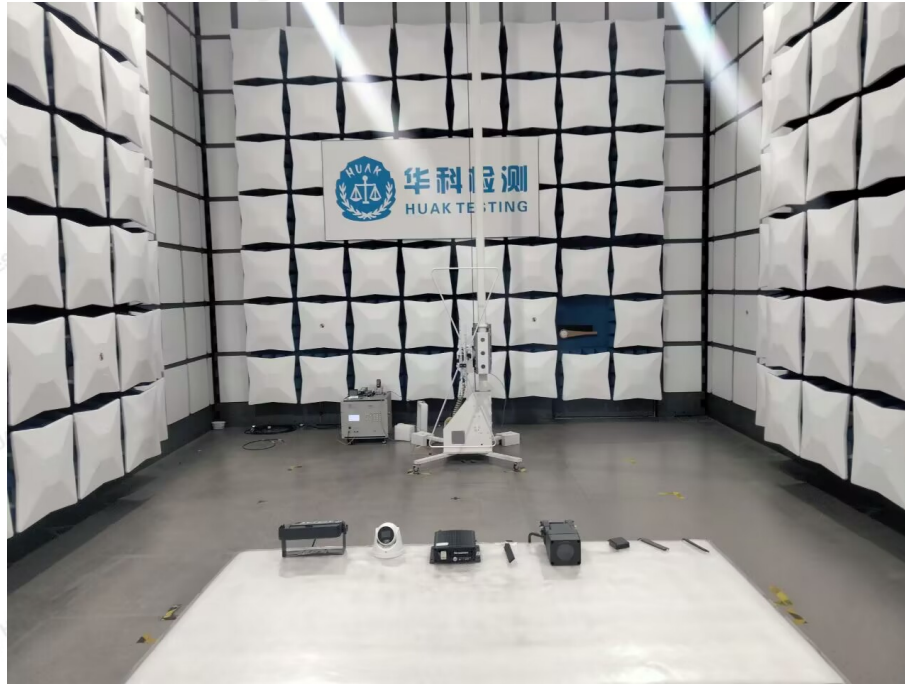

The results shown in this test report refer only to the sample(s) tested unless otherwise stated and the sample(s) are retained for 30 days only. The document is issued by HUAK, this document cannot be reproduced except in full with our prior written permission. The more details and the authenticity of the report will be confirmed at <http://www.cer-mark.com>.

TEL : +86-755 2302 9901 FAX : +86-755 2302 9901 E-mail : service@cer-mark.com

Addr: 1-2F., Building B2, Junfeng Zhongcheng Zhizao Innovation Park, Heping Community, Fuhai Street, Bao'an District, Shenzhen, Guangdong, China



6 External and Internal photos of the EUT

Reference to the report :ANNEX A of external photos and ANNEX B of internal photos.

.....**End of Report**.....

