

# FCC

## CERTIFICATION TEST REPORT

*For*

CAMERA

MODEL No.: C6D AI

FCC ID: 2AM6L-C6DAI

Trade Mark: N/A

REPORT NO: ES190925019W05

ISSUE DATE: November 4, 2019

*Prepared for*

Streamax Technology Co., Ltd.

21-23/F, Building B1, Zhiyuan, No. 1001 Xueyuan Avenue, Nanshan District,  
Shenzhen City, Guangdong Province, P.R.China

*Prepared by*

EMTEK (SHENZHEN) CO., LTD.

Bldg 69, Majialong Industry Zone, Nanshan District, Shenzhen,  
Guangdong, China

TEL: 86-755-26954280

FAX: 86-755-26954282

## Table of Contents

1	TEST RESULT CERTIFICATION .....	3
2	EUT TECHNICAL DESCRIPTION .....	4
3	SUMMARY OF TEST RESULT.....	6
3.1	TEST ITEM.....	6
3.2	OUTLINE OF EUT .....	7
4	TEST METHODOLOGY .....	9
4.1	GENERAL DESCRIPTION OF APPLIED STANDARDS.....	9
4.2	MEASUREMENT EQUIPMENT USED.....	9
4.3	DESCRIPTION OF TEST MODES .....	10
5	FACILITIES AND ACCREDITATIONS .....	12
5.1	FACILITIES.....	12
5.2	LABORATORY ACCREDITATIONS AND LISTINGS.....	12
6	TEST SYSTEM UNCERTAINTY .....	13
7	SETUP OF EQUIPMENT UNDER TEST.....	14
7.1	RADIO FREQUENCY TEST SETUP 1 .....	14
7.2	RADIO FREQUENCY TEST SETUP 2.....	14
7.3	SUPPORT EQUIPMENT .....	16
8	TEST REQUIREMENTS.....	17
8.1	RF POWER OUTPUT.....	17
8.2	EFFECTIVE (ISOTROPIC) RADIATED POWER .....	18
8.3	MODULATION CHARACTERISTICS .....	20
8.4	OCCUPIED BANDWIDTH.....	21
8.5	BAND EDGE EMISSION.....	23
8.6	EMISSION MASK.....	24
8.7	OUT OF BAND EMISSIONS AT ANTENNA TERMINALS.....	25
8.8	FIELD STRENGTH OF SPURIOUS RADIATION.....	26
8.9	FREQUENCY STABILITY .....	28
8.10	PEAK TO AVERAGE RATIO .....	29
	APPENDIX A: TEST DATA FOR RF POWER OUTPUT .....	30
	APPENDIX B: TEST DATA FOR EFFECTIVE (ISOTROPIC) RADIATED POWER .....	47
	APPENDIX C: TEST DATA FOR OCCUPIED BANDWIDTH .....	64
	APPENDIX D: TEST DATA FOR BAND EDGE EMISSION.....	99
	APPENDIX E: EMISSION MASK.....	170
	APPENDIX F: TEST DATA FOR OUT OF BAND EMISSIONS AT ANTENNA TERMINALS .....	177
	APPENDIX G: TEST DATA FOR FIELD STRENGTH OF SPURIOUS RADIATION .....	211
	APPENDIX H: TEST DATA FOR FREQUENCY STABILITY .....	228
	APPENDIX I: TEST DATA FOR PEAK TO AVERAGE RATIO .....	287

**1 TEST RESULT CERTIFICATION**

Applicant : Streamax Technology Co., Ltd.  
 Address : 21-23/F, Building B1, Zhiyuan, No. 1001 Xueyuan Avenue, Nanshan District, Shenzhen City, Guangdong Province, P.R.China  
 Manufacturer : Streamax Technology Co., Ltd.  
 Address : 21-23/F, Building B1, Zhiyuan, No. 1001 Xueyuan Avenue, Nanshan District, Shenzhen City, Guangdong Province, P.R.China  
 EUT : CAMERA  
 Model Name : C6D AI  
 Trademark : N/A

Measurement Procedure Used:

APPLICABLE STANDARDS	
STANDARD	TEST RESULT
FCC 47 CFR Part 2, Subpart J FCC 47 CFR Part 22, Subpart H FCC 47 CFR Part 24, Subpart E FCC 47 CFR Part 27 FCC 47 CFR Part 90(R)	<b>PASS</b>

The above equipment was tested by EMTEK (SHENZHEN) CO., LTD. The test data, data evaluation, test procedures, and equipment configurations shown in this report were made in accordance with the procedures given in ANSI C63.25 (2015) and the energy emitted by the sample EUT tested as described in this report is in compliance with the requirements of FCC Rules Part 2, 22(H), 24(E), 27, 90(R)

The test results of this report relate only to the tested sample identified in this report

Date of Test : October 08,2019 to October 31, 2019

Prepared by : *Sewen Guo*  
Sewen Guo /Editor

Reviewer : *Joe Xia*  
Joe Xia/Editor

Approve & Authorized Signer : *Lisa Wang*  
Lisa Wang/Manager



## 2 EUT TECHNICAL DESCRIPTION

Characteristics	Description
<b>Device Type</b>	Fixation Equipment For LTE
<b>Operation Band:</b>	FDD-LTE Band 2
	FDD-LTE Band 4
	FDD-LTE Band 5
	FDD-LTE Band 12
	FDD-LTE Band 13
	FDD-LTE Band 14
	FDD-LTE Band 66
	FDD-LTE Band 71
<b>Modulation:</b>	QPSK, 16QAM
<b>Operating Frequency Range(s):</b>	FDD-LTE Band 2: Tx: 1850-1910MHz, Rx: 1930-1990MHz
	FDD-LTE Band 4: Tx: 1710-1755MHz, Rx: 2110-2155MHz
	FDD-LTE Band 5: Tx: 824-849MHz, Rx: 869-894MHz
	FDD-LTE Band 12: Tx: 699-716MHz, Rx: 729-746MHz
	FDD-LTE Band 13: Tx: 777-787MHz, Rx: 746-756MHz
	FDD-LTE Band 14: Tx: 788-798MHz, Rx: 758-768MHz
	FDD-LTE Band 66: Tx: 1710-1780MHz, Rx: 2110-2200MHz
	FDD-LTE Band 71: Tx: 663-698MHz, Rx: 617-652MHz
<b>Supported Channel Bandwidth:</b>	LTE BAND2 <input checked="" type="checkbox"/> 1.4MHz, <input checked="" type="checkbox"/> 3MHz, <input checked="" type="checkbox"/> 5MHz, <input checked="" type="checkbox"/> 10MHz, <input checked="" type="checkbox"/> 15MHz, <input checked="" type="checkbox"/> 20MHz,
	LTE BAND4 <input checked="" type="checkbox"/> 1.4MHz, <input checked="" type="checkbox"/> 3MHz, <input checked="" type="checkbox"/> 5MHz, <input checked="" type="checkbox"/> 10MHz, <input checked="" type="checkbox"/> 15MHz, <input checked="" type="checkbox"/> 20MHz,
	LTE BAND5 <input checked="" type="checkbox"/> 1.4MHz, <input checked="" type="checkbox"/> 3MHz, <input checked="" type="checkbox"/> 5MHz, <input checked="" type="checkbox"/> 10MHz
	LTE BAND12 <input checked="" type="checkbox"/> 1.4MHz, <input checked="" type="checkbox"/> 3MHz, <input checked="" type="checkbox"/> 5MHz, <input checked="" type="checkbox"/> 10MHz
	LTE BAND13 <input checked="" type="checkbox"/> 5MHz, <input checked="" type="checkbox"/> 10MHz
	LTE BAND14 <input checked="" type="checkbox"/> 5MHz, <input checked="" type="checkbox"/> 10MHz
	LTE BAND66 <input checked="" type="checkbox"/> 1.4MHz, <input checked="" type="checkbox"/> 3MHz, <input checked="" type="checkbox"/> 5MHz, <input checked="" type="checkbox"/> 10MHz, <input checked="" type="checkbox"/> 15MHz, <input checked="" type="checkbox"/> 20MHz,
	LTE BAND71 <input checked="" type="checkbox"/> 5MHz, <input checked="" type="checkbox"/> 10MHz, <input checked="" type="checkbox"/> 15MHz, <input checked="" type="checkbox"/> 20MHz,

<b>Max.RF Output Power</b>	LTE BAND2: 22.95 dBm
	LTE BAND4: 22.93 dBm
	LTE BAND5: 22.95 dBm
	LTE BAND12: 22.88 dBm
	LTE BAND13: 22.90 dBm
	LTE BAND14: 23.34 dBm
	LTE BAND66: 22.98 dBm
	LTE BAND71: 23.39 dBm
<b>TX and RX Antenna:</b>	Ant1 (Main Antenna)-Support Transmit and Receive Ant2 (Slave Antenna)-Only Support Receive Remark: Ant2 cannot work independently, it only assists receiving function with the main antenna
<b>Antenna Type</b>	External Antenna
<b>Antenna Gain</b>	3.09 dBi for LTE BAND2 4.53 dBi for LTE BAND4 2.52 dBi for LTE BAND5 1.92 dBi for LTE BAND12 2.17 dBi for LTE BAND13 2.78 dBi for LTE BAND14 4.53 dBi for LTE BAND66 1.69 dBi for LTE BAND71
<b>Power supply</b>	<input checked="" type="checkbox"/> DC 12V/24V for DC power
<b>Temperature Range</b>	-40°C ~ +70°C

**Note:** for more details, please refer to the User's manual of the EUT.

### 3 SUMMARY OF TEST RESULT

#### 3.1 TEST ITEM

FCC Rule	Test Parameter	Verdict	Remark
2.1046	RF Power Output	PASS	
22.913, 24.232, 27.50, 90.542 (a)(7)	Equivalent (Isotropic) Radiated Power	PASS	
2.1047	Modulation Characteristics	PASS	
2.1049	Occupied Bandwidth	PASS	
2.1051, 22.917, 24.238, 27.53, 90.691	Out of Band Emissions at Antenna Terminals	PASS	
2.1053 90.543 (e)(2)(3)	Band Edge Emission	PASS	
2.1053, 22.917, 24.238, 27.53, 90.691 90.543 (e)(3) 90.543 (f)	Field Strength of Spurious Radiation	PASS	
2.1055, 22.355, 24.235, 27.54, 90.213 90.539 (e)	Frequency Stability versus Temperature	PASS	
	Frequency Stability versus Voltage	PASS	
24.232, 27.50	Peak to Average Ratio	PASS	
2.1051 90.210(n)	Emission Mask (Mask B)	PASS	
NOTE1: N/A (Not Applicable)			

#### RELATED SUBMITTAL(S) / GRANT(S):

This submittal(s) (test report) is intended for FCC ID: 2AM6L-C6DAI filing to comply with FCC 47 CFR Part 2, 22(H), 24(E), 27, 90(R)

The system is compliance with Subpart B is authorized under a SDOC procedure

### 3.2 OUTLINE OF EUT

The C6D AI sample, for LTE band supporting B2/B4/B5/B12/B13/B14/B66/B71, configurations information are as following table:

Test Mode List		
Test Mode	Description	Remark
TM1	FDD-LTE Band 2	Low, Middle, High Channels
TM2	FDD-LTE Band 4	Low, Middle, High Channels
TM3	FDD-LTE Band 5	Low, Middle, High Channels
TM4	FDD-LTE Band 12	Low, Middle, High Channels
TM5	FDD-LTE Band 13	Low, Middle, High Channels
TM6	FDD-LTE Band 14	Low, Middle, High Channels
TM7	FDD-LTE Band 66	Low, Middle, High Channels
TM8	FDD-LTE Band 71	Low, Middle, High Channels

List for test frequency of each band

Test Mode	Bandwidth (MHz)	Frequency (MHz)		
		Low CH	Middle CH	High CH
FDD-LTE Band 2	1.4	1850.7	1880	1909.3
	3	1851.5	1880	1908.5
	5	1852.5	1880	1907.5
	10	1855	1880	1905
	15	1857.5	1880	1902.5
	20	1860	1880	1900
FDD-LTE Band 4	1.4	1710.7	1732.5	1754.3
	3	1711.5	1732.5	1763.5
	5	1712.5	1732.5	1762.5
	10	1715	1732.5	1750
	15	1717.5	1732.5	1747.5
	20	1720	1732.5	1745
FDD-LTE Band 5	1.4	824.7	836.5	848.3
	3	825.5	836.5	847.5
	5	826.5	836.5	846.5
	10	829	836.5	844
FDD-LTE Band 12	1.4	699.7	707.5	715.3
	3	700.5	707.5	714.5
	5	701.5	707.5	713.5
	10	704	707.5	711
FDD-LTE Band 13	5	779.5	782	784.5
	10	782	782	782
FDD-LTE Band 14	5	790.5	793	795.5
	10	793	793	793

Test Mode	Bandwidth (MHz)	Frequency (MHz)		
		Low CH	Middle CH	High CH
FDD-LTE Band 66	1.4	1710.7	1745	1779.3
	3	1711.5	1745	1778.3
	5	1712.5	1745	1777.5
	10	1715	1745	1775
	15	1717.5	1745	1772.5
	20	1720	1745	1770
FDD-LTE Band 71	5	665.5	680.5	695.5
	10	668	680.5	693
	15	670.5	680.5	690.5
	20	673	680.5	688



## 4 TEST METHODOLOGY

### 4.1 GENERAL DESCRIPTION OF APPLIED STANDARDS

According to its specifications, the EUT must comply with the requirements of the following standards:

FCC 47 CFR Part 2, Subpart J

FCC 47 CFR Part 22H

FCC 47 CFR Part 24E

FCC 47 CFR Part 27

FCC 47 CFR Part 90(R)

KDB971168 D01: v02r02

KDB 412172 D01: v01r01

ANSI/TIA-603-D-2010, ANSI C63.26:2015

### 4.2 MEASUREMENT EQUIPMENT USED

#### 4.2.1 Radiated Emission Test Equipment

EQUIPMENT TYPE	MFR	MODEL NUMBER	SERIAL NUMBER	LAST CAL.
EMI Test Receiver	R & S	ESU	1302.6005.26	May 20, 2019
Pre-Amplifier	HP	8447D	2944A07999	May 19, 2019
Bilog Antenna	Schwarzbeck	VULB9163	142	May 19, 2019
Bilog Antenna	Schwarzbeck	VULB9163	141	May 19, 2019
Loop Antenna	ARA	PLA-1030/B	1029	May 19, 2019
Horn Antenna	Schwarzbeck	BBHA 9170	BBHA9170399	May 20, 2019
Horn Antenna	Schwarzbeck	BBHA 9120	D143	May 19, 2019
Cable	Schwarzbeck	AK9513	ACRX1	May 20, 2019
Cable	Rosenberger	N/A	FP2RX2	May 20, 2019
Cable	Schwarzbeck	AK9513	CRPX1	May 20, 2019
Cable	Schwarzbeck	AK9513	CRRX2	May 20, 2019
Cable	H+B	0.5M SF104-26.5	289147/4	May 20, 2019
Cable	H+B	3M SF104-26.5	295838/4	May 20, 2019
Cable	H+B	6M SF104-26.5	295840/4	May 20, 2019

#### 4.2.2 Radio Frequency Test Equipment

EQUIPMENT TYPE	MFR	MODEL NUMBER	SERIAL NUMBER	LAST CAL.
Spectrum Analyzer	Agilent	E4407B	88156318	May 20, 2019
Power meter	Anritsu	ML2495A	0824006	May 20, 2019
Power sensor	Anritsu	MA2411B	0738172	May 20, 2019
Spectrum Analyzer	Agilent	N9010A	My53470879	May 20, 2019
Spectrum Analyzer	R & S	FSV30	103040	May 20, 2019
Spectrum Analyzer	R & S	FSV40	132.1-3008K39-100967-AP	May 20, 2019
Universal Radio Communication	R&S	CMW500	1201.0002K50-140822zk	May 20, 2019
Power Splitter	MInI-CIrcuits	ZFRSC-183-S +	S F808201417	May 20, 2019
Attenuator	Weinschel Associates	WA14	18-10-12	May 20, 2019
Temp. / Humidity Chamber	Kingson	THS-M1	242	May 20, 2019

**Remark:** Each piece of equipment is scheduled for calibration once a year.

### 4.3 DESCRIPTION OF TEST MODES

The EUT has been tested under its typical operating condition. The CMW500 used to control the EUT staying in continuous transmitting and receiving mode for testing.

The EUT configuration for testing is installed on RF field strength measurement to meet the Commissions requirement and operating in a manner which intends to maximize its emission characteristics in a continuous normal application.

During all testing, EUT is in link mode with base station emulator at maximum power level.

The Transmitter was operated in the normal operating mode. The TX frequency was fixed which was for the purpose of the measurements.

Test of channel included the lowest and middle and highest frequency to perform the test, then record on this report.

Pre-defined engineering program for regulatory testing used to control the EUT for staying in continuous transmitting and receiving mode is programmed.

■ Test Mode and system config

Configure the CMW500 call box to support all LTE tests in respect to the 3GPP 36.521.

UE term. Conn: User defined Channels

Exp. Nominal Power Mode: According to UL Power Control Settings

RS EPRE: -75.0 dBm/15kHz Full Cell BW Power: -50.2 dBm

PSS Power Offset = SSS Power Offset = PBCH Power Offset = PCFICH Power Offset = PDCCH Power Offset = 0.0 dB

PHICH Power Offset = -12 dB

OCNG ON

PDSCH Power Offset PA: 0 dB, Power Ratio Index PB: 0 (rhoB/rhoA: 1)

Active TPC Setup: Max Power

Security Settings: Authentication OFF, NAS Security OFF, AS Security OFF

Integrity Algorithm: NULL

Milenage OFF

Configure the desired channel, BW, resource block allocation and modulation.

Connect to test set.

Set CMW500 TPC Setup to Max Power (Up power control command).

According to 3GPP 36.521, V9.1.0., the output power level for Power Class 3 LTE is to be 23.0dBm + 2.7dB. The lower limit is shifted down by the MPR amount allowed for certain configurations.

Maximum Power Reduction (MPR) is allowed due to higher order modulation and transmit bandwidth configurations. These MPR levels reduce the lower limit of each output power by the either 1 or 2dB per 3GPP 36.521.

Modulation	Channel bandwidth / Transmission bandwidth configuration[RB]						MPR (dB)
	1.4MHz	3MHz	5MHz	10MHz	15MHz	20MHz	
QPSK	> 5	> 4	> 8	> 12	> 16	> 18	≤ 1
16 QAM	≤ 5	≤ 4	≤ 8	≤ 12	≤ 16	≤ 18	≤ 1
16 QAM	> 5	> 4	> 8	> 12	> 16	> 18	≤ 2

■ Test Environment

Environment Parameter	Selected Values During Tests	
Relative Humidity	Ambient	
Temperature	TN	Ambient
Ambient	VL	DC8V
	VN	DC 24V
	VH	DC 36V
NOTE: VL= Lower Extreme Test Voltage VN= Nominal Voltage VH= Upper Extreme Test Voltage TN= Normal Temperature		

## 5 FACILITIES AND ACCREDITATIONS

### 5.1 FACILITIES

All measurement facilities used to collect the measurement data are located at

Bldg 69, Majialong Industry Zone District, Nanshan District, Shenzhen, China

The sites are constructed in conformance with the requirements of ANSI C63.7, ANSI C63.26 and CISPR Publication 22.

### 5.2 LABORATORY ACCREDITATIONS AND LISTINGS

#### Site Description

EMC Lab. : Accredited by CNAS, 2018.11.30  
The certificate is valid until 2022.10.28  
The Laboratory has been assessed and proved to be in compliance with CNAS-CL01:2006 (identical to ISO/IEC 17025:2017)  
The Certificate Registration Number is L2291.

Accredited by TUV Rheinland Shenzhen 2018.03.30  
The Laboratory has been assessed according to the requirements ISO/IEC 17025.

Accredited by FCC, August 09, 2018  
Designation Number: CN1204  
Test Firm Registration Number: 882943  
Accredited by A2LA, August 08, 2018  
The Certificate Registration Number is 4321.01

Accredited by Industry Canada, November 09, 2018  
The Conformity Assessment Body Identifier is CN0008.

Name of Firm : EMTEK(SHENZHEN) CO., LTD.  
Site Location : Bldg 69, Majialong Industry Zone,  
Nanshan District, Shenzhen, Guangdong, China

## 6 TEST SYSTEM UNCERTAINTY

The following measurement uncertainty levels have been estimated for tests performed on the apparatus:

Parameter	Uncertainty
Radio Frequency	$\pm 1 \times 10^{-5}$
RF Power Output	$\pm 1.0\text{dB}$
Radiated Emission Test	$\pm 2.0\text{dB}$
Occupied Bandwidth Test	$\pm 1.0\text{dB}$
Band Edge Test	$\pm 3\text{dB}$
All emission, radiated	$\pm 3\text{dB}$
Antenna Port Emission	$\pm 3\text{dB}$
Temperature	$\pm 0.5^{\circ}\text{C}$
Humidity	$\pm 3\%$

Measurement Uncertainty for a level of Confidence of 95%

## 7 SETUP OF EQUIPMENT UNDER TEST

### 7.1 RADIO FREQUENCY TEST SETUP 1

The component's antenna ports(s) of the EUT are connected to the measurement instrument per an appropriate attenuator. The EUT is controlled by PC/software to emit the specified signals for the purpose of measurements.

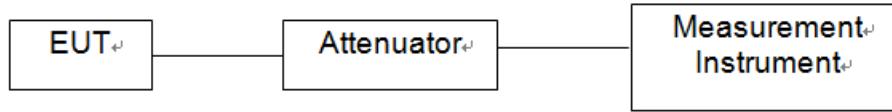

### 7.2 RADIO FREQUENCY TEST SETUP 2

The test site semi-anechoic chamber has met the requirement of NSA tolerance 4 dB according to the standards: ANSI C63.10. The test distance is 3m. The setup is according to the requirements in Section 13.1.4.1 of ANSI C63.26-2015 and CAN/CSA-CEI/IEC CISPR 22.

Below 30MHz:

The EUT is placed on a turntable 0.8 meters above the ground in the chamber, 3 meter away from the antenna (loop antenna). The Antenna should be positioned with its plane vertical at the specified distance from the EUT and rotated about its vertical axis for maximum response at each azimuth about the EUT. The center of the loop shall be 1 m above the ground. For certain applications, the loop antenna plane may also need to be positioned horizontally at the specified distance from the EUT.

Above 30MHz:

The EUT is placed on a turntable 0.8 meters above the ground in the chamber, 3 meter away from the antenna. The maximal emission value is acquired by adjusting the antenna height, polarisation and turntable azimuth. Normally, the height range of antenna is 1 m to 4 m, the azimuth range of turntable is 0° to 360°, and the receive antenna has two polarizations Vertical (V) and Horizontal (H).

Above 1GHz:

(Note: the FCC's permission to use 1.5m as an alternative per TCBC Conf call of Dec. 2, 2014.)

The EUT is placed on a turntable 1.5 meters above the ground in the chamber, 3 meter away from the antenna. The maximal emission value is acquired by adjusting the antenna height, polarisation and turntable azimuth. Normally, the height range of antenna is 1 m to 4 m, the azimuth range of turntable is 0° to 360°, and the receive antenna has two polarizations Vertical (V) and Horizontal (H).

(a) Radiated Emission Test Set-Up, Frequency Below 30MHz

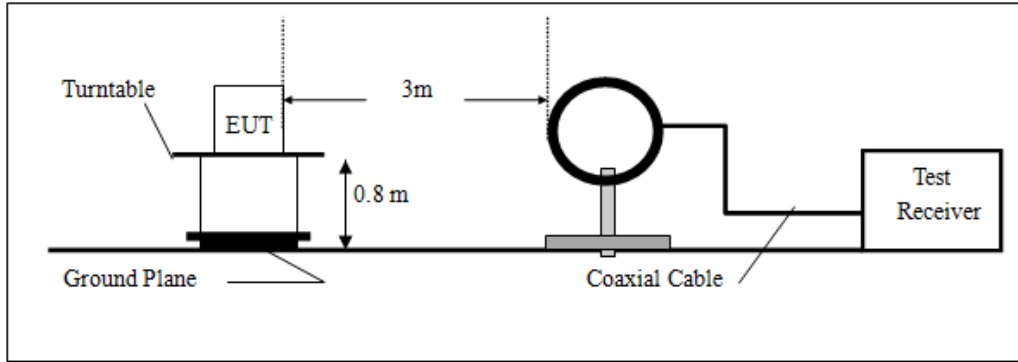

(b) Radiated Emission Test Set-Up, Frequency Below 1000MHz

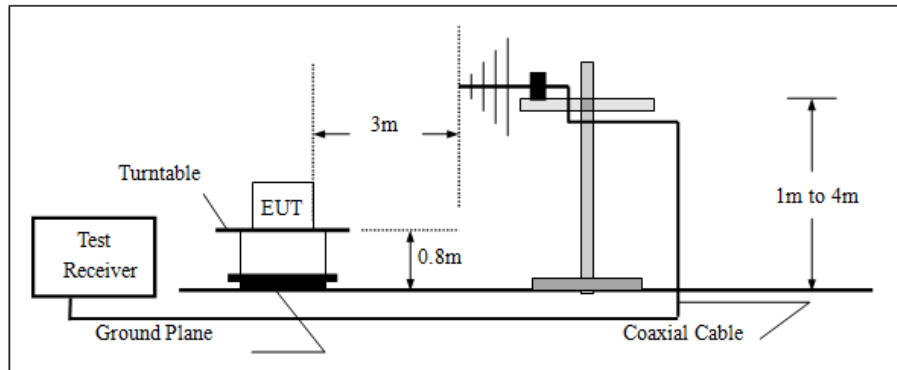

(c) Radiated Emission Test Set-Up, Frequency above 1000MHz

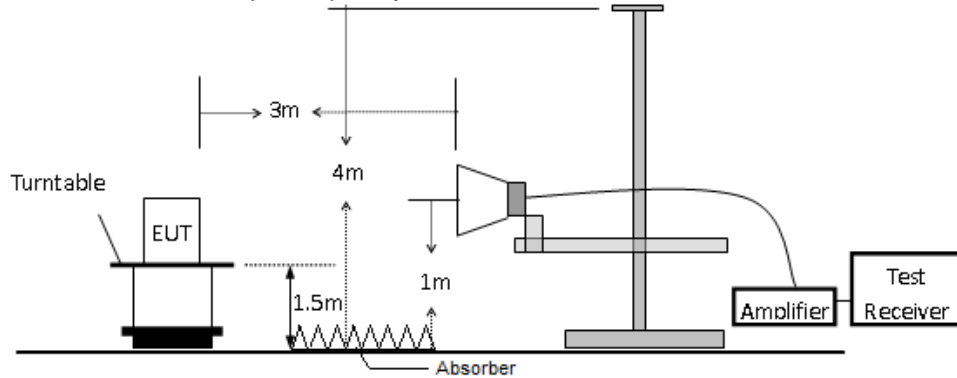

### 7.3 SUPPORT EQUIPMENT

Item	Equipment	Mfr/Brand	Model/Type No.	FCC ID	Note
N/A	N/A	N/A	N/A	N/A	N/A

**Notes:**

1. All the equipment/cables were placed in the worst-case configuration to maximize the emission during the test.
2. Grounding was established in accordance with the manufacturer's requirements and conditions for the intended use.



## 8 TEST REQUIREMENTS

### 8.1 RF POWER OUTPUT

#### 8.1.1 Conformance Limit

No limit requirement.

#### 8.1.2 Test Configuration

Test according to clause 7.1 radio frequency test setup 1

#### 8.1.3 Test Procedure

Connect the EUT to Universal Radio Communication Tester CMU500 via the antenna connector. A call is set up by the SS according to the generic call set up procedure on a channel with ARFCN in the ARFCN range, power control level set to Max power. The frequency band is set as selected frequency, The RF output of the transmitter was connected to base station simulator.

Set EUT at maximum average power by base station simulator.

Set RBW = 1-5% of the OBW, not to exceed 1 MHz.

Set VBW  $\geq 3 \times$  RBW.

Number of points in sweep  $\geq 2 \times$  span / RBW. (This gives bin-to-bin spacing  $\leq$  RBW/2, so that narrowband signals are not lost between frequency bins.)

Sweep time = auto.

Detector = RMS (power averaging).

Set sweep trigger to "free run".

Trace average at least 100 traces in power averaging (i.e., RMS) mode; however, the number of traces to be averaged shall be increased above 100 as needed such that the average accurately represents the true average over the on and off periods of the transmitter.

Compute power by integrating the spectrum across the OBW of the signal using the instrument's band power measurement function with band limits set equal to the OBW band edges. If the instrument does not have a band power function, sum the spectrum levels (in power units) at intervals equal to the RBW extending across the entire OBW of the spectrum.

Add  $10 \log(1/x)$ , where x is the duty cycle, to the measured power in order to compute the average power during the actual transmission times (because the measurement represents an average over both the on and off times of the transmission). For example, add  $10 \log(1/0.25) = 6$  dB if the duty cycle is a constant 25%.

Measure lowest, middle, and highest channels for each bandwidth and different modulation.

Measure and record the results in the test report.

#### 8.1.4 Test Results

Pass

Note: The details please see Appendix A.

## 8.2 EFFECTIVE (ISOTROPIC) RADIATED POWER

### 8.2.1 Conformance Limit

LTE BAND2	FCC Part 24.232
Mobile and portable stations are limited to 2 watts EIRP and the equipment must employ a means for limiting power to the minimum necessary for successful communications.	
LTE BAND4 (66)	FCC Part 27.50
Fixed, mobile, and portable (hand-held) stations operating in the 1710-1755 MHz band and mobile and portable stations operating in the 1695-1710 MHz and 1755-1780 MHz bands are limited to 1 watt EIRP. Fixed stations operating in the 1710-1755 MHz band are limited to a maximum antenna height of 10 meters above ground. Mobile and portable stations operating in these bands must employ a means for limiting power to the minimum necessary for successful communications.	
LTE BAND5	FCC Part 22.913, Part 90.635
According to Part 22.913(a) the ERP of mobile transmitters and auxiliary test transmitters must not exceed 7 Watts; According to Part 90.635(b), the maximum output power of the transmitter for mobile stations is 100 watts (20 dBw);	
LTE BAND12 (71)	FCC Part 27.50
Portable stations (hand-held devices) in the 600 MHz uplink band and the 698-746 MHz band, and fixed and mobile stations in the 600 MHz uplink band are limited to 3 watts ERP.	
LTE BAND13	FCC Part 27.50
Portable stations (hand-held devices) transmitting in the 746-757 MHz, 776-788 MHz, and 805-806 MHz bands are limited to 3 watts ERP	
LTE BAND14	FCC Part 90
The ERP of portable station transmitters must not exceed 3 Watts According to KDB 412172 D01 Power Approach, ERP = EIRP -2.15	

### 8.2.2 Test Configuration

Test according to clause 7.3 radio frequency test setup 3

### 8.2.3 Test Procedure

Connect the EUT to Universal Radio Communication Tester CMU500 via the antenna connector. A call is set up by the SS according to the generic call set up procedure on a channel with ARFCN in the Mid ARFCN range, power control level set to Max power. MS TXPWR\_MAX\_CCH is set to the maximum value supported by the Power Class of the Mobile under test

The instrument must have an available measurement/resolution bandwidth that is equal to or exceeds the OBW. If this capability is available, then the following procedure can be used to determine the total peak output power.

- a) Set the RBW  $\geq$  OBW.
- b) Set VBW  $\geq$  3  $\times$  RBW.
- c) Set span  $\geq$  2  $\times$  RBW
- d) Sweep time = auto couple.
- e) Detector = peak.
- f) Ensure that the number of measurement points  $\geq$  span/RBW.
- g) Trace mode = max hold.
- h) Allow trace to fully stabilize.
- i) Use the peak marker function to determine the peak amplitude level.

The EUT was placed on a turn table which is 0.8m above ground plane. Maximum procedure was performed on the six highest emissions to ensure EUT compliance. And also, each emission was to be maximized by changing the polarization of receiving antenna both horizontal and vertical. Repeat above procedures until all frequency measured was complete.

A receiving antenna was placed on the antenna mast 3 meters from the EUT for emission measurements. The height of receiving antenna is 1.5m. The test setup refers to figure below. Detected emissions were maximized at each frequency by rotating the EUT through 360° and adjusting the receiving antenna polarization. The radiated emission measurements of all transmit frequencies in three channels (High, Middle, Low) were measured with peak detector.

The EUT is then put into continuously transmitting mode at its maximum power level during the test. And the maximum value of the receiver should be recorded as (Pr).

The EUT shall be replaced by a substitution antenna. The test setup refers to figure below. In the chamber, an substitution antenna for the frequency band of interest is placed at the reference point of the chamber. An RF Signal source for the frequency band of interest is connected to the substitution antenna with a cable that has been constructed to not interfere with the radiation pattern of the antenna. A power (PMea) is applied to the input of the substitution antenna, and adjust the level of the signal generator output until the value of the receiver reach the previously recorded (Pr). The power of signal source (PMea) is recorded. The test should be performed by rotating the test item and adjusting the receiving antenapolarization.

A amplifier should be connected to the Signal Source output port. And the cable should be connect between the Amplifier and the Substitution Antenna.

The cable loss (Pcl) ,the Substitution Antenna Gain (Ga) and the Amplifier Gain (PAg) should be recorded after test.

The measurement results are obtained as described below:

Power(EIRP)=PMea- PAg - Pcl - Ga

This value is EIRP since the measurement is calibrated using an antenna of known gain (2.15 dBi) and known input power.

ERP can be calculated from EIRP by subtracting the gain of the dipole,

According to KDB 412172 D01 Power Approach,

$EIRP = P_T + G_T - L_C$ ,  $ERP = EIRP - 2.15$ , where

$P_T$  = transmitter output power in dBm

$G_T$  = gain of the transmitting antenna in dBi

$L_C$  = signal attenuation in the connecting cable between the transmitter and antenna in dB

#### 8.2.4 Test Results

Pass

Note: The details please see Appendix B.

### **8.3 MODULATION CHARACTERISTICS**

#### **8.3.1 Conformance Limit**

No specific modulation characteristics requirement limits.

#### **8.3.2 Test Configuration**

Test according to clause 7.1 radio frequency test setup 1

#### **8.3.3 Test Procedure**

Connect the EUT to Universal Radio Communication Tester CMU200 or CMU500 via the antenna connector. A call is set up by the SS according to the generic call set up procedure on a channel with ARFCN in the Mid ARFCN range, power control level set to Max power. MS TXPWR\_MAX\_CCH is set to the maximum value supported by the Power Class of the Mobile under test, The frequency band is set as selected frequency, test method was according to 3GPP TS 51.010 and 3GPP TS 34.121. and 3GPP2 C.S0011/TIA-98-E for 1XRTT.and 3GPP2 C.S0033-0/tia-866 for Rel.0 and 3GPP2 C.S0033-A for Rev.A The waveform quality and constellation of the was tested.

#### **8.3.4 Test Results**

Pass

## 8.4 OCCUPIED BANDWIDTH

### 8.4.1 Conformance Limit

No specific modulation characteristics requirement limits.

### 8.4.2 Test Configuration

Test according to clause 7.1 radio frequency test setup 1

### 8.4.3 Test Procedure

Connect the EUT to Universal Radio Communication Tester CMU500 via the antenna connector. A call is set up by the SS according to the generic call set up procedure on a channel with ARFCN in the Mid ARFCN range, power control level set to Max power. MS TXPWR\_MAX\_CCH is set to the maximum value supported by the Power Class of the Mobile under test,

#### ■ 99% Occupied bandwidth

The following procedure shall be used for measuring (99 %) power bandwidth

- a) The spectrum analyzer center frequency is set to the nominal EUT channel center frequency. The frequency span for the spectrum analyzer shall be set wide enough to capture all modulation products including the emission skirts (i.e., two to five times the OBW).
- b) The nominal IF filter bandwidth (3 dB RBW) shall be in the range of 1 to 5 % of the anticipated OBW, and the VBW shall be at least 3 times the RBW.
- c) Set the reference level of the instrument as required to keep the signal from exceeding the maximum input mixer level for linear operation. In general, the peak of the spectral envelope must be at least  $10\log(\text{OBW} / \text{RBW})$  below the reference level.
- d) NOTE—Steps a) through c) may require iteration to adjust within the specified tolerances.
- e) Set the detection mode to peak, and the trace mode to max hold.
- f) Use the 99 % power bandwidth function of the spectrum analyzer (if available) and report the measured bandwidth.
- g) If the instrument does not have a 99 % power bandwidth function, the trace data points are to be recovered and directly summed in linear power terms. The recovered amplitude data points, beginning at the lowest frequency, are placed in a running sum until 0.5 % of the total is reached; that frequency is recorded as the lower frequency. The process is repeated until 99.5 % of the total is reached; that frequency is recorded as the upper frequency. The 99 % power bandwidth is the difference between these two frequencies.
- h) The OBW shall be reported by providing plot(s) of the measuring instrument display. The frequency and amplitude axes and scale shall be clearly labeled. Tabular data may be reported in addition to the plot(s).

#### ■ 26 dB Occupied bandwidth

The reference value is the highest level of the spectral envelope of the modulated signal.

- a) The spectrum analyzer center frequency is set to the nominal EUT channel center frequency. The span range for the spectrum analyzer shall be between two and five times the anticipated OBW.
- b) The nominal resolution bandwidth (RBW) shall be in the range of 1 to 5 % of the anticipated OBW, and the VBW shall be at least 3 times the RBW.
- c) Set the reference level of the instrument as required to prevent the signal from exceeding the maximum input mixer level for linear operation. In general, the peak of the spectral envelope must be at least  $10\log(\text{OBW} / \text{RBW})$  below the reference level.
- d) NOTE—Steps a) through c) may require iteration to adjust within the specified tolerances.
- e) The dynamic range of the spectrum analyzer at the selected RBW shall be at least 10 dB below the target “-X dB down” requirement (i.e., if the requirement calls for measuring the -26 dB OBW, the spectrum analyzer noise floor at the selected RBW shall be at least 36 dB below the reference value).
- f) Set the detection mode to peak, and the trace mode to max hold.
- g) Determine the reference value: Set the EUT to transmit a modulated signal. Allow the trace to stabilize. Set the spectrum analyzer marker to the highest level of the displayed trace (this is the reference value).
- h) Determine the “-X dB down amplitude” as equal to (Reference Value – X). Alternatively, this calculation

can be performed by the analyzer by using the marker-delta function.

i) Place two markers, one at the lowest and the other at the highest frequency of the envelope of the spectral display such that each marker is at or slightly below the “-X dB down amplitude” determined in step g). If a marker is below this “-X dB down amplitude” value it shall be placed as close as possible to this value. The OBW is the positive frequency difference between the two markers.

j) The occupied bandwidth shall be reported by providing plot(s) of the measuring instrument display. The frequency and amplitude axes and scale shall be clearly labeled. Tabular data may be reported in addition to the plot(s)

#### **8.4.4 Test Results**

Pass

Note: The details please see Appendix C.

## 8.5 BAND EDGE EMISSION

### 8.5.1 Conformance Limit

LTE BAND5	FCC Part 22.917, Part 90.691
≤ -13 dBm/1%*EBW, in 1 MHz bands immediately outside and adjacent to the frequency block.	
LTE BAND2	FCC Part 24.238
≤ -13 dBm/1%*EBW, in 1 MHz bands immediately outside and adjacent to the frequency block.	
LTE BAND4 (66)	FCC Part 27.53(h)
≤ -13 dBm/1%*EBW, in 1 MHz bands immediately outside and adjacent to the frequency block.	
LTE BAND7	FCC Part 27.53(m)
For mobile digital stations, the attenuation factor shall be not less than 40 + 10 log (P) dB on all frequencies between the channel edge and 5 megahertz from the channel edge, 43 + 10 log (P) dB on all frequencies between 5 megahertz and X megahertz from the channel edge, and 55 + 10 log (P) dB on all frequencies more than X megahertz from the channel edge, where X is the greater of 6 megahertz or the actual emission bandwidth as defined in paragraph (m)(6) of this section. In addition, the attenuation factor shall not be less than 43 + 10 log (P) dB on all frequencies between 2490.5 MHz and 2496 MHz and 55 + 10 log (P) dB at or below 2490.5 MHz. Mobile Satellite Service licensees operating on frequencies below 2495 MHz may also submit a documented interference complaint against BRS licensees operating on channel BRS Channel 1 on the same terms and conditions as adjacent channel BRS or EBS licensees	
LTE BAND12 (71)	FCC Part 27.53(g)
≤ -13 dBm/1%*EBW, in 1 MHz bands immediately outside and adjacent to the frequency block.	
LTE BAND13	FCC Part 27.53(c)
≤ -13 dBm/1%*EBW, in 1 MHz bands immediately outside and adjacent to the frequency block.	
LTE BAND14	FCC Part 90
For operations in the 758-768 MHz and the 788-798 MHz bands	
(1) On all frequencies between 769-775 MHz and 799-805 MHz, by a factor not less than 76 + 10 log (P) dB in a 6.25 kHz band segment, for base and fixed stations.	
(2) On all frequencies between 769-775 MHz and 799-805 MHz, by a factor not less than 65 + 10 log (P) dB in a 6.25 kHz band segment, for mobile and portable stations.	
(3) On any frequency between 775-788 MHz, above 805 MHz, and below 758 MHz, by at least 43 + 10 log (P) dB.	

### 8.5.2 Test Configuration

Test according to clause 7.1 radio frequency test setup 1

### 8.5.3 Test Procedure

Connect the EUT to Universal Radio Communication Tester CMU500 via the antenna connector. A call is set up by the SS according to the generic call set up procedure on a channel with ARFCN in the Mid ARFCN range, power control level set to Max power. MS TXPWR\_MAX\_CCH is set to the maximum value supported by the Power Class of the Mobile under test,

Spectrum Analyzer is set as below:  
 SET RBW ≥ 1% of Emission BW.  
 SET VBW about three times of RBW  
 Detector: RMS  
 Trace mode= max hold.

### 8.5.4 Test Results

Pass

Note: The details please see Appendix D.

## 8.6 EMISSION MASK

### 8.6.1 Conformance Limit

LTE BAND14

FCC Part 90

Emission Mask B

For transmitters that are equipped with an audio low-pass filter, the power of any emission must be attenuated below the unmodulated carrier power (P) as follows:

(1) On any frequency removed from the assigned frequency by more than 50 percent, but not more than 100 percent of the authorized bandwidth: At least 25 dB.

(2) On any frequency removed from the assigned frequency by more than 100 percent, but not more than 250 percent of the authorized bandwidth: At least 35 dB.

(3) On any frequency removed from the assigned frequency by more than 250 percent of the authorized bandwidth: At least  $43 + 10 \log (P)$  dB.

### 8.6.2 Test Configuration

Test according to clause 7.1 radio frequency test setup 1

### 8.6.3 Test Procedure

Connect the EUT to Universal Radio Communication Tester CMU500 via the antenna connector. A call is set up by the SS according to the generic call set up procedure on a channel with ARFCN in the Mid ARFCN range, power control level set to Max power. MS TXPWR\_MAX\_CCH is set to the maximum value supported by the Power Class of the Mobile under test,

Spectrum Analyzer is set as below:

SET RBW :100KHz.

SET VBW about three times of RBW

Detector: RMS

Trace mode= max hold.

### 8.6.4 Test Results

Pass

Note: The details please see Appendix E.



## 8.7 OUT OF BAND EMISSIONS AT ANTENNA TERMINALS

### 8.7.1 Conformance Limit

LTE BAND2	FCC Part 24.238
Out of band emissions. The power of any emission outside of the authorized operating frequency ranges must be attenuated below the transmitting power (P) by a factor of at least $43 + 10 \log(P)$ dB.	
LTE BAND4(66)	FCC Part 27.53(h)
Out of band emissions. The power of any emission outside of the authorized operating frequency ranges must be attenuated below the transmitting power (P) by a factor of at least $43 + 10 \log(P)$ dB.	
LTE BAND5	FCC Part 22.917
Out of band emissions. The power of any emission outside of the authorized operating frequency ranges must be attenuated below the transmitting power (P) by a factor of at least $43 + 10 \log(P)$ dB.	
LTE BAND12(71)	FCC Part 27.53(g)
Out of band emissions. The power of any emission outside of the authorized operating frequency ranges must be attenuated below the transmitting power (P) by a factor of at least $43 + 10 \log(P)$ dB.	
LTE BAND13	FCC Part 27.53(c)
Out of band emissions. The power of any emission outside of the authorized operating frequency ranges must be attenuated below the transmitting power (P) by a factor of at least $43 + 10 \log(P)$ dB.	
LTE BAND14	FCC Part 90
The power of any emission outside of the authorized operating frequency ranges must be lower than the transmitter power (P) by a factor of at least $43 + 10 \log(P)$ dB.	

The specification that emissions shall be attenuated below the transmitter power (P) by at least  $43 + 10 \log(P)$  dB, translates in the relevant power range (1 to 0.001 W) to -13 dBm. At 1 W the specified minimum attenuation becomes 43 dB and relative to a 30 dBm (1 W) carrier becomes a limit of -13 dBm. At 0.001 W (0 dBm) the minimum attenuation is 13 dB, which again yields a limit of -13 dBm. In this way a translation of the specification from relative to absolute terms is carried out.

### 8.7.2 Test Configuration

Test according to clause 7.1 radio frequency test setup 1

### 8.7.3 Test Procedure

The transmitter output (antenna port) was connected to the spectrum analyzer  
Connect the EUT to Universal Radio Communication Tester CMU200 or CMU500 via the antenna connector.  
A call is set up by the SS according to the generic call set up procedure on a channel with ARFCN in the Mid ARFCN range, power control level set to Max power. MS TXPWR\_MAX\_CCH is set to the maximum value supported by the Power Class of the Mobile under test,

Spectrum Analyzer is set as below:

9kHz~150kHz, RBW = 1KHz, VBW  $\geq 3 \times$ RBW,

150kHz~30MHz, RBW = 10KHz, VBW  $\geq 3 \times$ RBW,

30MHz~1GHz, RBW = 100 kHz, VBW = 300 kHz. Above 1GHz, RBW = 1 MHz, VBW = 3 MHz.

Detector: Peak

Trace mode= max hold.

### 8.7.4 Test Results

Pass

Note: The details please see Appendix F.

## 8.8 FIELD STRENGTH OF SPURIOUS RADIATION

### 8.8.1 Conformance Limit

LTE BAND2	FCC Part 24.238
Out of band emissions. The power of any emission outside of the authorized operating frequency ranges must be attenuated below the transmitting power (P) by a factor of at least $43 + 10 \log(P)$ dB.	
LTE BAND4 (66)	FCC Part 27.53(h)
Out of band emissions. The power of any emission outside of the authorized operating frequency ranges must be attenuated below the transmitting power (P) by a factor of at least $43 + 10 \log(P)$ dB.	
LTE BAND5	FCC Part 22.917
Out of band emissions. The power of any emission outside of the authorized operating frequency ranges must be attenuated below the transmitting power (P) by a factor of at least $43 + 10 \log(P)$ dB.	
LTE BAND12 (71)	FCC Part 27.53(g)
Out of band emissions. The power of any emission outside of the authorized operating frequency ranges must be attenuated below the transmitting power (P) by a factor of at least $43 + 10 \log(P)$ dB.	
LTE BAND13	FCC Part 27.53(c)
Out of band emissions. The power of any emission outside of the authorized operating frequency ranges must be attenuated below the transmitting power (P) by a factor of at least $43 + 10 \log(P)$ dB.	
LTE BAND14	FCC Part 90
For operations in the 758-775 MHz and 788-805 MHz bands, all emissions including harmonics in the band 1559–1610 MHz shall be limited to -70 dBW/MHz equivalent isotropically radiated power (EIRP) for wideband signals, and -80 dBW EIRP for discrete emissions of less than 700 Hz bandwidth. For the purpose of equipment authorization, a transmitter shall be tested with an antenna that is representative of the type that will be used with the equipment in normal operation.	

The specification that emissions shall be attenuated below the transmitter power (P) by at least  $43 + 10 \log(P)$  dB, translates in the relevant power range (1 to 0.001 W) to -13 dBm. At 1 W the specified minimum attenuation becomes 43 dB and relative to a 30 dBm (1 W) carrier becomes a limit of -13 dBm. At 0.001 W (0 dBm) the minimum attenuation is 13 dB, which again yields a limit of -13 dBm. In this way a translation of the specification from relative to absolute terms is carried out.

### 8.8.2 Test Configuration

Test according to clause 7.3 radio frequency test setup 3

### 8.8.3 Test Procedure

Connect the EUT to Universal Radio Communication Tester CMU200 or CMU500 via the antenna connector. A call is set up by the SS according to the generic call set up procedure on a channel with ARFCN in the Mid ARFCN range, power control level set to Max power. MS TXPWR\_MAX\_CCH is set to the maximum value supported by the Power Class of the Mobile under test.

Compliance with these rules is based on the use of measurement instrumentation employing a resolution bandwidth of 100 kHz or greater. In the 1 MHz bands immediately outside and adjacent to the frequency block a resolution bandwidth of at least one percent of the emission bandwidth of the fundamental emission of the transmitter may be employed. A narrower resolution bandwidth is permitted in all cases to improve measurement accuracy provided the measured power is integrated over the full required measurement bandwidth (i.e. 100 kHz or 1 percent of emission bandwidth, as specified). The emission bandwidth is defined as the width of the signal between two points, one below the carrier center frequency and one above the carrier center frequency, outside of which all emissions are attenuated at least 26 dB below the transmitter power.

then the following procedure can be used to determine spurious emission

- RBW = 1 MHz for  $f \geq 1$  GHz(1GHz to 25GHz), 100 kHz for  $f < 1$  GHz(30MHz to 1GHz), 200Hz for  $f < 150$ KHz(9KHz to 150KHz), 9KHz for  $f < 30$ MHz(150KHz to 30KHz)
- Set VBW  $\geq 3 \times$  RBW.
- Set span wide enough to fully capture the emission being measured
- Sweep time = auto couple.

- e) Detector = peak.
- f) Ensure that the number of measurement points  $\geq$  span/RBW.
- g) Trace mode = max hold.
- h) Allow trace to fully stabilize.
- i) Use the peak marker function to determine the peak amplitude level.

Step1. The EUT was placed on a rotatable wooden table with 0.8 meter above ground.

Step2. The EUT was set 3 meters from the receiving antenna, which was mounted on the antenna tower.

Step3. The table was rotated 360 degrees to determine the position of the highest spurious emission.

Step4. The height of the receiving antenna is varied between one meter and four meters to search the maximum spurious emission for both horizontal and vertical polarizations.

Step5. Make the measurement with the spectrum analyzer's RBW , VBW , taking the record of maximum spurious emission.

Step6. A horn antenna was substituted in place of the EUT and was driven by a signal generator.

Step7. Tune the output power of signal generator to the same emission level with EUT maximum spurious emission.

Step8. Taking the record of output power at antenna port.

Step9. Repeat step 7 to step 8 for another polarization.

Step10. Emission level (dBm) = output power + substitution Gain. Test Results

#### **8.8.4 Test Results**

Pass

Note: The details please see Appendix G.

## 8.9 FREQUENCY STABILITY

### 8.9.1 Conformance Limit

The frequency stability shall be measured by variation of ambient temperature and variation of primary supply voltage to ensure that the fundamental emission stays within the authorized frequency block. The frequency stability of the transmitter shall be maintained within  $\pm 0.00025\%$  ( $\pm 2.5\text{ppm}$ ) of the center frequency.

Band 14: The frequency stability of the transmitter shall be maintained within  $\pm 1.25\text{ ppm}$  of the center frequency.

### 8.9.2 Test Configuration

Test according to clause 7.2 conducted emission test setup2.

### 8.9.3 Test Procedure

Connect the EUT to Universal Radio Communication Tester CMU200 or CMU500 via the antenna connector. A call is set up by the SS according to the generic call set up procedure on a channel with ARFCN in the ARFCN range, power control level set to Max power. MS TXPWR\_MAX\_CCH is set to the maximum value supported by the Power Class of the Mobile under test.

EUT was placed at temperature chamber and connected to an external power supply.

Temperature and voltage condition shall be tested to confirm frequency stability.

(a) Frequency measurements shall be made at the extremes of the specified temperature range and at intervals of not more than  $10^{\circ}$  centigrade through the range. A period of time sufficient to stabilize all of the components of the oscillator circuit at each temperature level shall be allowed prior to frequency measurement. The short-term transient effects on the frequency of the transmitter due to keying (except for broadcast transmitters) and any heating element cycling normally occurring at each ambient temperature level also shall be shown. Only the portion or portions of the transmitter containing the frequency determining and stabilizing circuitry need be subjected to the temperature variation test.

(b) The frequency stability shall be measured with variation of primary supply voltage as follows:

(1) Vary primary supply voltage from 95 to 105 percent of the nominal value for other than hand carried battery equipment.

(2) For hand carried, battery powered equipment, reduce primary supply voltage to the battery operating end point, which shall be specified by the manufacturer.

### 8.9.4 Test Results

Pass

Note: The details please see Appendix H.

## 8.10 PEAK TO AVERAGE RATIO

### 8.10.1 Conformance Limit

#### LTE BAND2

#### FCC Part 24.232

Power measurements for transmissions by stations authorized under this section may be made either in accordance with a Commission-approved average power technique or in compliance with paragraph (e) of this section. In both instances, equipment employed must be authorized in accordance with the provisions of §24.51. In measuring transmissions in this band using an average power technique, the peak-to-average ratio (PAR) of the transmission may not exceed 13 dB.

#### LTE BAND4(66)

#### FCC Part 27.50

Equipment employed must be authorized in accordance with the provisions of §24.51. Power measurements for transmissions by stations authorized under this section may be made either in accordance with a Commission-approved average power technique or in compliance with paragraph (d)(6) of this section. In measuring transmissions in this band using an average power technique, the peak-to-average ratio (PAR) of the transmission may not exceed 13 dB.

### 8.10.2 Test Configuration

Test according to clause 7.1 conducted emission test setup1.

### 8.10.3 Test Procedure

The EUT was connected to Spectrum Analyzer and Base Station via power divider.

The RF output of EUT was connected to the spectrum analyzer by RF cable and attenuator. The path loss was compensated to the results for each measurement.

Set the number of counts to a value that stabilizes the measured CCDF curve.

Set the measurement interval to 1 ms.

Record the maximum PAPR level associated with a probability of 0.1%.

- a) Refer to instrument's analyzer instruction manual for details on how to use the power statistics/CCDF function;
- b) Set resolution/measurement bandwidth  $\geq$  signal's occupied bandwidth;
- c) Set the number of counts to a value that stabilizes the measured CCDF curve;
- d) Set the measurement interval as follows:
  - 1) for continuous transmissions, set to 1 ms,
  - 2) for burst transmissions, employ an external trigger that is synchronized with the EUT burst timing sequence, or use the internal burst trigger with a trigger level that allows the burst to stabilize and set the measurement interval to a time that is less than or equal to the burst duration.
- e) Record the maximum PAPR level associated with a probability of 0.1%.

### 8.10.4 Test Results

Pass

Note: The details please see Appendix I.

### APPENDIX A: TEST DATA FOR RF POWER OUTPUT

Band/BW	Modulation	RB Size	RB Offset	Low CH 18607	Mid CH 18900	High CH 19193
				1850.7 MHz	1880.0 MHz	1909.3 MHz
2/1.4	QPSK	1	0	22.55	22.80	22.36
		1	2	22.63	22.61	22.34
		1	5	22.48	22.13	22.11
		3	0	22.05	22.86	21.92
		3	1	22.62	22.18	22.26
		3	3	22.08	22.85	22.29
	16QAM	6	0	22.13	22.59	21.95
		1	0	22.28	22.58	22.78
		1	2	22.84	21.89	22.71
		1	5	22.77	22.70	22.60
		3	0	22.73	21.99	22.07
		3	1	22.89	22.64	22.27
		3	3	22.63	21.94	22.62
		6	0	22.68	22.02	22.71

Band/BW	Modulation	RB Size	RB Offset	Low CH 18615	Mid CH 18900	High CH 19185
				1851.5 MHz	1880.0 MHz	1908.5 MHz
2/3	QPSK	1	0	22.27	22.85	22.23
		1	7	22.56	22.55	22.75
		1	14	22.81	22.16	22.84
		8	0	22.09	22.42	22.78
		8	3	22.53	22.56	22.2
		8	7	22.45	22.77	22.65
		15	0	22.45	22.04	22.22
	16QAM	1	0	22.38	22.28	22.54
		1	7	22.07	21.93	22.04
		1	14	22.28	22.29	22.24
		8	0	22.5	22.87	22.66
		8	3	22.89	22.88	22.75
		8	7	22.02	22.82	22.44
		15	0	22.05	22.65	22.53

Band/BW	Modulation	RB Size	RB Offset	Low CH 18625	Mid CH 18900	High CH 19175
				1852.5 MHz	1880.0 MHz	1907.5 MHz
2/5	QPSK	1	0	22.64	22.73	22.36
		1	12	22.66	22.59	21.94
		1	24	22.29	22.01	21.93
		12	0	22.26	22.26	22.69
		12	6	22.2	22.85	21.89
		12	13	22.57	22.46	21.91
		25	0	22.81	22.39	22.61
	16QAM	1	0	22.08	22.11	22.05
		1	12	22.55	21.97	22.59
		1	24	22.2	22.37	22.11
		12	0	22.49	21.9	22.87
		12	6	22.53	22.82	22.75
		12	13	21.93	22.42	22.18
		25	0	22.88	22.35	22.46

Band/BW	Modulation	RB Size	RB Offset	Low CH 18650	Mid CH 18900	High CH 19150
				1855.0 MHz	1880.0 MHz	1905.0 MHz
2/10	QPSK	1	0	22.84	22.42	22.82
		1	24	22.86	22.6	22.02
		1	49	22.2	22.28	22.15
		25	0	22.64	22.17	22.67
		25	12	22.4	22.32	22.21
		25	25	22.23	22.12	22.68
		50	0	22.72	22.09	21.93
	16QAM	1	0	22.66	22.25	22.27
		1	24	21.95	21.92	22.41
		1	49	22.26	22.55	22.77
		25	0	22.49	22.1	22.06
		25	12	22.49	22.35	22.48
		25	25	22.77	22.14	22.29
		50	0	21.91	22.27	22.81

Band/BW	Modulation	RB Size	RB Offset	Low CH 18675	Mid CH 18900	High CH 19125
				1857.5 MHz	1880.0 MHz	1902.5 MHz
2/15	QPSK	1	0	22.77	22.76	22.3
		1	37	22.05	22.64	22.22
		1	74	22.37	22.91	22.35
		36	0	22.67	22.14	22.44
		36	19	22.7	22.42	22.14
		36	39	22.19	22.43	22.25
	16QAM	75	0	22.24	22.68	22.2
		1	0	22.11	22.23	22.07
		1	37	22.21	21.94	22.06
		1	74	22.91	22.29	22.3
		36	0	22.17	22.78	21.98
		36	19	21.92	22.19	22.18
		36	39	22.65	22.8	22.75
		75	0	22.87	22.58	22.66

Band/BW	Modulation	RB Size	RB Offset	Low CH 18700	Mid CH 18900	High CH 19100
				1860.0 MHz	1880.0 MHz	1900.0 MHz
2/20	QPSK	1	0	22.74	22.91	22.56
		1	50	22.14	22.64	22.05
		1	99	21.98	22.54	22.04
		50	0	22.43	22.81	22.54
		50	25	22.63	<b>22.95</b>	21.97
		50	50	21.94	22.14	21.95
		100	0	22.74	22.71	22.49
	16QAM	1	0	22.04	22.78	22.2
		1	50	21.9	22.07	22.06
		1	99	22.12	22.41	22.62
		50	0	22.39	22.12	22.79
		50	25	22.32	22.75	22.27
		50	50	22.02	<b>22.90</b>	22.5
		100	0	22.65	22.85	22.28



Band/BW	Modulation	RB Size	RB Offset	Low CH 19957	Mid CH 20175	High CH 20393
				Frequency 1710.7 MHz	Frequency 1732.5 MHz	Frequency 1754.3 MHz
4/1.4	QPSK	1	0	22.79	22.79	22.72
		1	2	22.1	22.09	22.75
		1	5	22.49	22.06	22.42
		3	0	22.02	22.24	22.67
		3	1	22.88	22.88	22.52
		3	3	22.38	22.8	22.47
	6	0	22.02	22.58	22.01	
	16QAM	1	0	22.14	22.56	22.67
		1	2	22.03	22.76	22.58
		1	5	22.84	22.57	22.79
		3	0	22.25	22.23	22.84
		3	1	22.15	22.07	22.78
		3	3	21.94	22.75	22.72
		6	0	22.29	22.13	21.95

Band/BW	Modulation	RB Size	RB Offset	Low CH 19965	Mid CH 20175	High CH 20385
				Frequency 1711.5 MHz	Frequency 1732.5 MHz	Frequency 1753.5 MHz
4/3	QPSK	1	0	22.58	22.66	22.52
		1	7	22.46	22.78	22.41
		1	14	22.3	22.21	22.83
		8	0	22.38	22.17	22.37
		8	3	22.27	22.84	22.45
		8	7	22.3	22.2	22.68
		15	0	22.19	22.07	22.84
	16QAM	1	0	22.54	22.05	22.32
		1	7	22.81	22.89	22.45
		1	14	22.7	22.3	22.24
		8	0	21.92	22.26	22.73
		8	3	21.95	22.63	22.61
		8	7	22.78	22.83	22.12
		15	0	22.38	22.48	22.34

Band/BW	Modulation	RB Size	RB Offset	Low CH 19975	Mid CH 20175	High CH 20375
				Frequency 1712.5 MHz	Frequency 1732.5 MHz	Frequency 1752.5 MHz
4/5	QPSK	1	0	22.22	22.64	22.14
		1	12	22.68	22.33	22.14
		1	24	22.82	22.8	22.15
		12	0	22.64	22.25	22.11
		12	6	22.34	22.73	22.26
		12	13	22.5	22.24	22.18
		25	0	22.52	22.33	22.17
	16QAM	1	0	22.44	22.17	22.41
		1	12	21.89	22.58	22.18
		1	24	21.92	22.3	22.76
		12	0	22.19	22.3	22.11
		12	6	21.9	22.3	22.84
		12	13	22.31	22.03	22.53
		25	0	22.72	22	22.56

Band/BW	Modulation	RB Size	RB Offset	Low CH 20000	Mid CH 20175	High CH 20350
				Frequency 1715 MHz	Frequency 1732.5 MHz	Frequency 1750 MHz
4/10	QPSK	1	0	22.69	22.68	22.78
		1	24	22.48	22.61	22.61
		1	49	22.27	22.3	22.36
		25	0	22.85	22.4	22.02
		25	12	22.52	22.26	22.87
		25	25	22.87	22.02	22.32
		50	0	22.76	22.46	22.61
	16QAM	1	0	22.34	22.65	22.14
		1	24	22.75	22.26	22.39
		1	49	22.79	22.26	22.38
		25	0	21.94	22.29	22.76
		25	12	22.55	22.65	22.27
		25	25	22.17	22.23	22.53
		50	0	22.24	22.09	22.51

Band/BW	Modulation	RB Size	RB Offset	Low CH 20025	Mid CH 20175	High CH 20325
				Frequency 1717.5 MHz	Frequency 1732.5 MHz	Frequency 1747.5 MHz
4/15	QPSK	1	0	22.69	22.46	22.09
		1	37	22.86	22.86	22.5
		1	74	22.12	22.69	21.89
		36	0	22.52	22.01	21.91
		36	19	22.06	22.36	22.5
		36	39	22.43	22.51	22.47
		75	0	22.49	22.66	22.76
	16QAM	1	0	22.04	22.82	22.38
		1	37	22.88	22.79	22.16
		1	74	22.38	22.78	22.31
		36	0	22.73	22.85	21.9
		36	19	22.58	22.53	22.16
		36	39	22.28	21.99	22.57
		75	0	22.65	22.21	21.98

Band/BW	Modulation	RB Size	RB Offset	Low CH 20050	Mid CH 20175	High CH 20300
				Frequency 1720 MHz	Frequency 1732.5 MHz	Frequency 1745 MHz
4/20	QPSK	1	0	22.65	22.34	22.37
		1	50	22.17	22.56	22.2
		1	99	22.54	21.91	22.39
		50	0	22.29	22.84	21.97
		50	25	22.53	22.31	22.87
		50	50	22.71	<b>22.92</b>	22.84
		100	0	22.87	22.82	22.81
	16QAM	1	0	21.94	22.53	22.09
		1	50	22.4	22.16	22.71
		1	99	22.88	22.59	22.09
		50	0	21.92	22.64	22.01
		50	25	22.56	22.43	22.65
		50	50	22.19	<b>22.93</b>	22.84
		100	0	22.65	22.53	22.29

Band/BW	Modulation	RB Size	RB Offset	Low CH 26697	Mid CH (26915)	High CH 27033
				Frequency (824.7) MHz	Frequency (836.5)MHz	Frequency (848.3) MHz
5/1.4	QPSK	1	0	22.62	22.42	22.37
		1	2	22.65	21.91	22.52
		1	5	22.46	22.73	21.99
		3	0	21.92	22.88	22.81
		3	1	22.5	22.31	22.42
		3	3	22.87	22.76	22.79
		6	0	22.43	22.37	22.28
	16QAM	1	0	22.18	22.55	21.98
		1	2	22.68	22.71	22.59
		1	5	22.59	22.01	22.51
		3	0	22.7	22.44	22.68
		3	1	22.82	22.06	22.08
		3	3	22.21	21.94	22.73
		6	0	22.48	22.28	22.87

Band/BW	Modulation	RB Size	RB Offset	Low CH (26805)	Mid CH (26915)	High CH (27025)
				Frequency (825.5)MHz	Frequency (836.5)MHz	Frequency (847.5)MHz
5/3	QPSK	1	0	22.21	22.62	22.51
		1	7	22.71	22.51	22.79
		1	14	22.84	22.22	22.7
		8	0	21.9	22.25	22.46
		8	3	22.56	22.86	22.27
		8	7	21.98	22.62	21.96
		15	0	22.65	22.67	22.4
	16QAM	1	0	22.65	22.23	22.18
		1	7	22.25	22.63	22.23
		1	14	22.33	22.22	22.27
		8	0	22.19	22.71	22.3
		8	3	22.37	22.16	22.62
		8	7	22.77	22.67	22.24
		15	0	22.09	22.55	21.92

Band/BW	Modulation	RB Size	RB Offset	Low CH (26815)	Mid CH (26915)	High CH (27015)
				Frequency (826.5)MHz	Frequency (836.5)MHz	Frequency (846.5)MHz
5/5	QPSK	1	0	22.54	22.61	22.54
		1	12	22.06	22.5	22.84
		1	24	22.42	22.65	22.71
		12	0	22.27	22.67	21.92
		12	6	22.79	22.48	22.42
		12	13	22.2	22.36	22.28
		25	0	22.09	22.77	22.03
	16QAM	1	0	22.18	21.91	22.28
		1	12	21.98	22.22	22.04
		1	24	22.05	22.83	22.27
		12	0	22.04	22.33	22.27
		12	6	22.04	22.64	22.89
		12	13	22.32	22.7	22.54
		25	0	22.01	22.24	22.01

Band/BW	Modulation	RB Size	RB Offset	Low CH (26840)	Mid CH (26915)	High CH (26990)
				Frequency (829)MHz	Frequency (836.5)MHz	Frequency (844)MHz
5/10	QPSK	1	0	22.85	22.62	22.66
		1	24	22.47	21.96	22.81
		1	49	22.83	22.06	22.53
		25	0	22.13	<b>22.92</b>	22.78
		25	12	22.45	22.41	22.35
		25	25	22.84	22.13	22.81
		50	0	22.57	22.14	22.80
	16QAM	1	0	22.41	22.54	22.07
		1	24	22.44	22.19	22.35
		1	49	<b>22.95</b>	22.22	22.46
		25	0	22.91	22.29	22.11
		25	12	22.08	22.32	22.84
		25	25	21.99	22.54	22.24
		50	0	22.09	21.9	22.49

Band/BW	Modulation	RB Size	RB Offset	Low CH 23017	Mid CH 23095	High CH 23173
				Frequency 699.7 MHz	Frequency 707.5 MHz	Frequency 715.3 MHz
12/1.4	QPSK	1	0	22.33	22.57	22.58
		1	2	22.57	22.54	22.08
		1	5	22.2	22.39	22.25
		3	0	22.62	22.17	22.22
		3	1	22.51	22.19	22.55
		3	3	22.17	22.16	22.01
		6	0	22.82	21.95	22.51
	16QAM	1	0	22.82	21.98	22.22
		1	2	22.08	22.43	22.71
		1	5	22.16	22.66	22.22
		3	0	21.97	22.03	22.72
		3	1	22.06	22.11	22.22
		3	3	22.18	22.29	22.46
		6	0	22.58	22.51	22.57

Band/BW	Modulation	RB Size	RB Offset	Low CH 23025	Mid CH 23095	High CH 23165
				Frequency 700.5 MHz	Frequency 707.5 MHz	Frequency 714.5 MHz
12/3	QPSK	1	0	22.87	22.25	22.84
		1	7	22.33	21.96	22.36
		1	14	22.34	22.21	22.05
		8	0	22.46	22.32	22.74
		8	3	22.29	22.79	22.1
		8	7	22.41	22.69	22.75
		15	0	22.23	22.47	22.56
	16QAM	1	0	22.52	22.85	22.01
		1	7	22.06	21.95	22.27
		1	14	22.52	22.45	22.4
		8	0	22.04	22.85	22.05
		8	3	22.14	22.8	22.74
		8	7	22.75	22.01	22.15
		15	0	22.67	22.29	22.66

Band/BW	Modulation	RB Size	RB Offset	Low CH 23035	Mid CH 23095	High CH 23155
				Frequency 701.5 MHz	Frequency 707.5 MHz	Frequency 713.5 MHz
12/5	QPSK	1	0	22.27	22.82	22.23
		1	12	22.69	22.18	21.96
		1	24	22.28	22.72	22.32
		12	0	22.52	22.38	22.6
		12	6	22.08	22.48	22.5
		12	13	22.51	22.84	22.7
		25	0	21.94	22.53	22.87
	16QAM	1	0	22.5	22.04	22.02
		1	12	22.58	22.87	22.5
		1	24	22.17	22.38	22.14
		12	0	22.18	22.58	22.22
		12	6	22.07	22.44	22.72
		12	13	22.65	21.98	22.37
		25	0	22.63	22.38	22.16

Band/BW	Modulation	RB Size	RB Offset	Low CH 23060	Mid CH 23095	High CH 23130
				Frequency 704 MHz	Frequency 707.5 MHz	Frequency 711 MHz
12/10	QPSK	1	0	22.41	22.88	21.94
		1	24	22.68	22.5	22.78
		1	49	21.92	22.75	22.04
		25	0	22.76	22.81	22.28
		25	12	21.98	22.16	<b>22.88</b>
		25	25	21.94	22.69	22.14
		50	0	22.24	22.22	22.52
	16QAM	1	0	22.76	22.05	22.55
		1	24	<b>22.87</b>	22.81	22.80
		1	49	22.12	22.36	22.16
		25	0	22.39	22.85	22.81
		25	12	22.83	22.12	22.16
		25	25	22.11	21.91	22.43
		50	0	22.57	22.39	22.81

Band/BW	Modulation	RB Size	RB Offset	CH 23205	CH 23230	CH 23255
				779.5 MHz	782.0 MHz	784.5 MHz
13 / 5	QPSK	1	0	22.85	22.19	22.74
		1	12	22.69	22.6	22.83
		1	24	22.46	22.05	22.32
		12	0	21.97	22.61	22.6
		12	6	22.76	22.46	22.41
		12	13	22.29	22.04	22.78
		25	0	21.94	22.05	22.71
	16QAM	1	0	22.72	22.46	22.51
		1	12	22.55	22.87	22.25
		1	24	22.18	22.47	22.57
		12	0	22.78	22.65	22.44
		12	6	22.16	22.08	22.84
		12	13	22.78	22.24	22.82
		25	0	22.64	22.19	22.27

Band/BW	Modulation	RB Size	RB Offset	CH	CH 23230	CH
				MHz	782.0 MHz	MHz
13 / 10	QPSK	1	0	/	22.85	/
		1	24	/	22.75	/
		1	49	/	22.32	/
		25	0	/	22.77	/
		25	12	/	<b>22.89</b>	/
		25	25	/	22.78	/
		50	0	/	22.39	/
	16QAM	1	0	/	22.21	/
		1	24	/	21.99	/
		1	49	/	22.19	/
		25	0	/	22.07	/
		25	12	/	22.58	/
		25	25	/	22.59	/
		50	0	/	<b>22.90</b>	/



Band/BW	Modulation	RB Size	RB Offset	CH 23305	CH 23330	CH 23355
				790.5 MHz	793.0 MHz	795.5 MHz
14 / 5	QPSK	1	0	23.16	22.87	22.59
		1	12	22.69	22.65	23.18
		1	24	23.14	22.43	23.27
		12	0	23.08	22.73	<b>23.34</b>
		12	6	22.48	22.58	22.41
		12	13	22.6	23.25	22.79
		25	0	23.11	22.44	22.72
	16QAM	1	0	22.59	23.02	22.69
		1	12	22.87	22.4	22.8
		1	24	22.63	<b>23.27</b>	23.09
		12	0	22.68	23.28	22.75
		12	6	22.48	22.9	22.82
		12	13	22.48	23.2	22.68
		25	0	23.08	23.11	23.31

Band/BW	Modulation	RB Size	RB Offset	CH	CH 23330	CH
				MHz	793 MHz	MHz
14 / 10	QPSK	1	0	/	22.64	/
		1	24	/	22.41	/
		1	49	/	22.42	/
		25	0	/	<b>23.12</b>	/
		25	12	/	22.61	/
		25	25	/	22.79	/
		50	0	/	22.83	/
	16QAM	1	0	/	22.74	/
		1	24	/	22.97	/
		1	49	/	22.51	/
		25	0	/	<b>23.11</b>	/
		25	12	/	22.92	/
		25	25	/	22.87	/
		50	0	/	22.54	/

Band/BW	Modulation	RB Size	RB Offset	Low CH 131979	Mid CH 132322	High CH 132665
				1710.7 MHz	1745 MHz	1779.3 MHz
66/1.4	QPSK	1	0	22.08	22.35	22.7
		1	2	22.63	22.86	21.93
		1	5	22.43	22.66	22.35
		3	0	22.27	22.14	22.78
		3	1	22.65	22.03	22.25
		3	3	22.53	21.91	22.06
	16QAM	6	0	21.94	22.33	21.95
		1	0	22.06	22.32	22.32
		1	2	22.11	22.65	22.55
		1	5	22.88	22.32	22.08
		3	0	22.5	22.03	22.83
		3	1	22.89	22.6	22.87
		3	3	21.97	22.05	22.78
		6	0	22.89	22.13	22.24

Band/BW	Modulation	RB Size	RB Offset	Low CH 131987	Mid CH 132322	High CH 132647
				1711.5 MHz	1745 MHz	1778.5 MHz
66/3	QPSK	1	0	22.69	22.16	21.95
		1	7	22.25	22.77	22.81
		1	14	22.53	22.52	22.78
		8	0	21.97	22.53	22.63
		8	3	22.21	22.42	22.55
		8	7	22.88	22.26	22.77
		15	0	22.4	22.6	22.24
	16QAM	1	0	22.35	22.56	22.11
		1	7	22.74	22.51	22.28
		1	14	22.38	22.54	22.27
		8	0	22.66	21.98	22.14
		8	3	22.44	22.08	22.47
		8	7	21.95	22.21	22.76
		15	0	22.35	22.42	21.94

Band/BW	Modulation	RB Size	RB Offset	Low CH 131997	Mid CH 132322	High CH 132647
				1712.5 MHz	1745 MHz	1777.5 MHz
66/5	QPSK	1	0	22.84	22.23	22.85
		1	12	22.65	22.02	22.72
		1	24	21.96	22.73	22.1
		12	0	22.53	22.17	21.95
		12	6	22.83	22.06	22.8
		12	13	22.27	22.34	22.5
		25	0	22.59	22.28	22.15
	16QAM	1	0	22.49	22.27	21.99
		1	12	22.34	22.44	22.35
		1	24	22.85	21.99	22.44
		12	0	22.26	21.98	22.72
		12	6	22.24	22.79	22.67
		12	13	22.22	22.83	22.55
		25	0	22.69	22.34	21.99

Band/BW	Modulation	RB Size	RB Offset	Low CH 132047	Mid CH 132322	High CH 132622
				1715 MHz	1745 MHz	1775 MHz
66/10	QPSK	1	0	22.79	22.53	22.34
		1	24	22.86	22.46	22.65
		1	49	22.74	22.64	22.28
		25	0	22.31	22.48	22.88
		25	12	22.16	22.27	22.38
		25	25	21.96	22.41	22.34
		50	0	22.46	22.79	22.53
	16QAM	1	0	22.53	22.06	22.73
		1	24	22.17	22.01	22.22
		1	49	22.82	22.66	22.82
		25	0	22.63	22.51	22.57
		25	12	22.31	22.31	22.47
		25	25	22.56	22.17	22.65
		50	0	22.11	22.63	22.39

Band/BW	Modulation	RB Size	RB Offset	Low CH 132047	Mid CH 132322	High CH 132597
				1717.5 MHz	1745 MHz	1772.5 MHz
66/15	QPSK	1	0	22.04	22.02	22.74
		1	37	22.17	22.04	22.54
		1	74	22.04	22.31	22.73
		36	0	22.64	22.81	22.78
		36	19	21.98	22.33	22.77
		36	39	22.57	22.05	22.89
		75	0	22.37	22.2	22.15
	16QAM	1	0	22.29	22.29	22.36
		1	37	22.46	22.57	22.59
		1	74	22.16	22.45	22.78
		36	0	22.85	22.01	22.49
		36	19	22.62	22.39	22.14
		36	39	22.26	22.86	22.23
		75	0	22.18	22.5	22.19

Band/BW	Modulation	RB Size	RB Offset	Low CH 132072	Mid CH 132322	High CH 132572
				1720 MHz	1745 MHz	1770 MHz
66/20	QPSK	1	0	22.31	22.15	22.87
		1	50	22.65	22.64	22.56
		1	99	22.26	22.38	22.57
		50	0	22.53	22.22	22.09
		50	25	22.24	22.09	22.90
		50	50	22.34	<b>22.92</b>	22.37
		100	0	22.18	22.72	22.44
	16QAM	1	0	22.48	21.92	22.63
		1	50	22.93	22.06	22.61
		1	99	22.55	22.21	22.58
		50	0	22.96	<b>22.98</b>	22.62
		50	25	22.64	22.14	22.08
		50	50	22.54	22.49	22.77
		100	0	22.04	21.98	22.18

Band/BW	Modulation	RB Size	RB Offset	Low CH 133147	Mid CH 133297	High CH 133447
				665.5 MHz	680.5 MHz	695.5 MHz
71/5	QPSK	1	0	23.05	23.36	23.01
		1	12	23.15	23.12	23.29
		1	24	22.92	22.90	22.86
		12	0	23.09	23.19	23.27
		12	6	22.53	22.79	23.06
		12	13	23.13	23.12	23.24
		25	0	22.71	22.77	23.12
	16QAM	1	0	22.77	22.93	22.63
		1	12	22.45	22.93	23.28
		1	24	22.93	22.64	23.25
		12	0	22.84	22.64	23.23
		12	6	23.26	22.79	22.74
		12	13	22.58	23.26	22.57
		25	0	22.49	22.53	22.45

Band/BW	Modulation	RB Size	RB Offset	Low CH 133172	Mid CH 133297	High CH 133422
				668 MHz	680.5 MHz	693 MHz
71/10	QPSK	1	0	22.81	22.98	23.23
		1	24	22.46	22.52	23.11
		1	49	23.09	23.09	22.62
		25	0	22.49	22.42	23.22
		25	12	23.27	23.03	23.24
		25	25	23.12	22.89	22.47
		50	0	23.13	23.17	22.79
	16QAM	1	0	23.26	22.7	22.41
		1	24	22.52	22.69	22.84
		1	49	23.33	22.46	22.75
		25	0	23.23	23.14	23.12
		25	12	23.14	22.92	22.69
		25	25	23.12	22.48	23.01
		50	0	22.41	23.22	23.07

Band/BW	Modulation	RB Size	RB Offset	Low CH 133197	Mid CH 133297	High CH 133397
				670.5 MHz	680.5 MHz	693 MHz
71/15	QPSK	1	0	23.12	22.45	23.24
		1	37	22.61	23.30	22.43
		1	74	22.78	23.22	22.96
		36	0	22.98	23.20	23.11
		36	19	23.13	23.37	22.77
		36	39	22.97	22.91	<b>23.36</b>
		75	0	22.66	22.61	22.47
	16QAM	1	0	22.76	23.14	23.36
		1	37	22.87	23.32	23.28
		1	74	22.44	22.64	<b>23.39</b>
		36	0	22.76	22.74	23.29
		36	19	22.48	22.64	22.41
		36	39	23.07	23.26	22.71
		75	0	23.29	23.01	23.12

Band/BW	Modulation	RB Size	RB Offset	Low CH 133222	Mid CH 133322	High CH 133372
				673 MHz	683 MHz	688 MHz
71/20	QPSK	1	0	22.77	23.13	22.75
		1	50	22.83	22.55	22.72
		1	99	22.67	23.25	22.87
		50	0	22.63	22.78	22.48
		50	25	22.97	22.83	22.79
		50	50	22.76	22.43	22.98
		100	0	<b>23.32</b>	23.25	22.88
	16QAM	1	0	23.22	22.5	22.45
		1	50	22.96	23.3	22.98
		1	99	23.35	23.12	23.36
		50	0	22.97	<b>23.38</b>	22.47
		50	25	23.21	23.07	22.68
		50	50	22.86	22.84	23.21
		100	0	23.12	22.86	22.61

**APPENDIX B: TEST DATA FOR EFFECTIVE (ISOTROPIC) RADIATED POWER**

Band/BW	Modulation	RB Size	RB Offset	Low CH 18607	Mid CH 18900	High CH 19193
				1850.7 MHz	1880.0 MHz	1909.3 MHz
2/1.4	QPSK	1	0	21.53	21.38	21.86
		1	2	20.95	21.13	21.19
		1	5	21.17	21.33	21.42
		3	0	20.95	21.77	21.24
		3	1	21.35	21.53	21.17
		3	3	21.63	21.2	21.57
	16QAM	6	0	21.34	21.88	21.01
		1	0	21.03	21.13	21.65
		1	2	21.23	21.64	21.33
		1	5	20.9	21.41	21.17
		3	0	21.54	21.49	21.34
		3	1	21.87	21.39	20.92
		3	3	21.52	21.22	21.09
		6	0	21.26	21.88	21.09

Band/BW	Modulation	RB Size	RB Offset	Low CH 18615	Mid CH 18900	High CH 19185
				1851.5 MHz	1880.0 MHz	1908.5 MHz
2/3	QPSK	1	0	21.62	21.43	21.14
		1	7	21.73	21.74	21.87
		1	14	21.26	21.75	21.63
		8	0	21.77	21.09	21.61
		8	3	21.29	21.45	21.17
		8	7	21.36	21.06	21.12
		15	0	20.93	21.08	21.27
	16QAM	1	0	21.65	21.19	20.93
		1	7	21.62	21.46	21.54
		1	14	21.44	20.95	20.89
		8	0	21.71	20.99	21.35
		8	3	21.27	20.99	21.49
		8	7	21.51	21.42	21.84
		15	0	21.31	20.96	21.79

Band/BW	Modulation	RB Size	RB Offset	Low CH 18625	Mid CH 18900	High CH 19175
				1852.5 MHz	1880.0 MHz	1907.5 MHz
2/5	QPSK	1	0	21.01	21.45	21.68
		1	12	20.99	21.03	21.15
		1	24	21.15	21.71	21.87
		12	0	21.65	21.02	21.29
		12	6	21.06	21.46	21.82
		12	13	21.11	21.56	21.34
		25	0	21.5	21.23	21.7
	16QAM	1	0	21.84	21.72	21.09
		1	12	21.85	20.94	21.03
		1	24	21.15	21.07	21.03
		12	0	21.85	21.7	21.1
		12	6	21.3	21.8	21.23
		12	13	21.4	21.25	21.21
		25	0	21.18	21.27	21.45

Band/BW	Modulation	RB Size	RB Offset	Low CH 18650	Mid CH 18900	High CH 19150
				1855.0 MHz	1880.0 MHz	1905.0 MHz
2/10	QPSK	1	0	21.52	21.76	21.13
		1	24	21.28	21.12	21.16
		1	49	21.81	21.65	21.33
		25	0	20.91	21.45	21.54
		25	12	21.04	21.15	21.32
		25	25	21.32	21.73	21.85
		50	0	21.76	21.1	21.48
	16QAM	1	0	21.09	21.82	21.7
		1	24	21.32	21.17	21.74
		1	49	21.48	21.5	21.2
		25	0	21.53	21.88	21.7
		25	12	21.57	21.88	21.75
		25	25	21.22	21.67	21.63
		50	0	21.64	21.32	21.13



Band/BW	Modulation	RB Size	RB Offset	Low CH 18675	Mid CH 18900	High CH 19125
				1857.5 MHz	1880.0 MHz	1902.5 MHz
2/15	QPSK	1	0	21.26	21.78	21.21
		1	37	21.43	20.93	20.97
		1	74	21.11	21.38	20.97
		36	0	21.56	21.2	21.19
		36	19	21.73	21.56	21.83
		36	39	21.32	21.02	21.41
		75	0	21.39	21.45	21.04
	16QAM	1	0	21.86	21.04	21.2
		1	37	21.77	21.84	21.54
		1	74	21.84	21.05	20.96
		36	0	20.9	21.6	21.41
		36	19	21.49	21.54	20.93
		36	39	21.88	21.88	21.39
		75	0	21.42	21.61	21.27

Band/BW	Modulation	RB Size	RB Offset	Low CH 18700	Mid CH 18900	High CH 19100
				1860.0 MHz	1880.0 MHz	1900.0 MHz
2/20	QPSK	1	0	20.89	21.27	21.27
		1	50	21.85	21.44	21.41
		1	99	21.39	20.95	21.02
		50	0	20.9	20.89	21.05
		50	25	21.35	21.65	21.88
		50	50	21.17	21.27	21.66
		100	0	21.34	21.16	21.55
	16QAM	1	0	21.07	21.43	21.83
		1	50	21.86	21.36	21.89
		1	99	21.06	20.91	21.31
		50	0	21.23	21.12	21.16
		50	25	21.76	20.95	21.61
		50	50	21.82	21.09	20.98
		100	0	21.1	21.77	21.89

Band/BW	Modulation	RB Size	RB Offset	Low CH 19957	Mid CH 20175	High CH 20393
				Frequency 1710.7 MHz	Frequency 1732.5 MHz	Frequency 1754.3 MHz
4/1.4	QPSK	1	0	21.03	21.16	21.84
		1	2	21.54	21.17	21.75
		1	5	21.41	21.56	21.72
		3	0	21.57	21.55	21.37
		3	1	21.3	21.22	21.78
		3	3	21.5	21.15	21.21
		6	0	21.82	21.79	21.67
	16QAM	1	0	21.63	21.87	21.5
		1	2	21.43	21.4	21.85
		1	5	21.75	21.69	21.26
		3	0	21.26	21.67	21.02
		3	1	21.88	21.61	21.3
		3	3	21.44	21.42	21.64
		6	0	21.39	21.07	21.82

Band/BW	Modulation	RB Size	RB Offset	Low CH 19965	Mid CH 20175	High CH 20385
				Frequency 1711.5 MHz	Frequency 1732.5 MHz	Frequency 1753.5 MHz
4/3	QPSK	1	0	21.54	21.04	21.83
		1	7	21.76	21.26	21.43
		1	14	20.92	21.71	21.38
		8	0	21.73	21.38	21.63
		8	3	21.49	21.29	21.83
		8	7	20.94	21.31	21.16
		15	0	21.87	21.26	21.71
	16QAM	1	0	21.39	21.85	21.61
		1	7	21.16	21.81	20.98
		1	14	20.96	21.05	21.47
		8	0	21.28	21.05	21.11
		8	3	21.58	20.95	21.17
		8	7	21.22	21.56	21.5
		15	0	21.3	20.98	21.51

Band/BW	Modulation	RB Size	RB Offset	Low CH 19975	Mid CH 20175	High CH 20375
				Frequency 1712.5 MHz	Frequency 1732.5 MHz	Frequency 1752.5 MHz
4/5	QPSK	1	0	21.28	21.83	21.45
		1	12	21.72	21.56	21.05
		1	24	21.35	21.23	21.81
		12	0	21.15	21.73	21.43
		12	6	21.41	21.6	20.96
		12	13	21.16	21.28	20.98
		25	0	21.75	21.4	21.69
	16QAM	1	0	21.08	21.46	21.83
		1	12	21.22	21.32	21.69
		1	24	21.44	21.06	21.05
		12	0	21.49	21.54	21.8
		12	6	21.29	21.86	21.82
		12	13	20.96	21.23	21.59
		25	0	21.07	21.37	21.19

Band/BW	Modulation	RB Size	RB Offset	Low CH 20000	Mid CH 20175	High CH 20350
				Frequency 1715 MHz	Frequency 1732.5 MHz	Frequency 1750 MHz
4/10	QPSK	1	0	20.94	21.4	21.59
		1	24	21.61	21.5	21.73
		1	49	21.33	21.4	21.53
		25	0	21.23	20.97	21.13
		25	12	21.36	20.92	21.46
		25	25	21.72	21.08	21.42
		50	0	21.71	21.28	21.55
	16QAM	1	0	20.94	21.68	20.94
		1	24	21.17	21.35	21.7
		1	49	21.58	21.72	20.99
		25	0	21.85	21.37	20.97
		25	12	21.11	21.69	21.45
		25	25	21.64	21.3	21.63
		50	0	21.57	21.25	21.27

Band/BW	Modulation	RB Size	RB Offset	Low CH 20025	Mid CH 20175	High CH 20325
				Frequency 1717.5 MHz	Frequency 1732.5 MHz	Frequency 1747.5 MHz
4/15	QPSK	1	0	21.34	21.89	21.09
		1	37	21.04	21.41	21.34
		1	74	21.63	21.38	21.3
		36	0	21.12	21.71	21.13
		36	19	21.52	21.86	21.24
		36	39	21.36	21.33	21.07
		75	0	21.8	21.03	21.59
	16QAM	1	0	21.52	21.67	21.43
		1	37	21.57	21.42	21.82
		1	74	21.14	21.71	21.42
		36	0	21.81	21.06	21.52
		36	19	21.48	21.12	21.47
		36	39	21.44	21.68	20.9
		75	0	21.15	21.76	21.22

Band/BW	Modulation	RB Size	RB Offset	Low CH 20050	Mid CH 20175	High CH 20300
				Frequency 1720 MHz	Frequency 1732.5 MHz	Frequency 1745 MHz
4/20	QPSK	1	0	21.41	21.47	21.07
		1	50	21.75	21.05	21.67
		1	99	21.23	21.16	21.47
		50	0	21.47	21.87	21.01
		50	25	21.63	21.88	21.22
		50	50	21.67	21.87	21.87
		100	0	21.72	21.42	21.66
	16QAM	1	0	21.3	21.75	21.32
		1	50	21.53	21.31	20.93
		1	99	21.88	21.31	21.51
		50	0	21.45	21.73	21.73
		50	25	21.7	21.78	21.82
		50	50	21.71	21.26	21.29
		100	0	21.84	21.26	21.17

Band/BW	Modulation	RB Size	RB Offset	Low CH 26697	Mid CH (26915)	High CH 27033
				Frequency (824.7) MHz	Frequency (836.5)MHz	Frequency (848.3) MHz
5/1.4	QPSK	1	0	21.77	21.49	21.73
		1	2	21.5	21.32	21.81
		1	5	21.34	21.29	21.02
		3	0	21.76	21.11	21.09
		3	1	21.3	20.9	21.08
		3	3	21.82	21.15	21.1
		6	0	21.6	21.84	21.26
	16QAM	1	0	21.44	21.85	21.59
		1	2	21.38	21.81	20.99
		1	5	21.48	21.21	21.22
		3	0	21.76	21.21	21.14
		3	1	21.5	21.3	21.42
		3	3	21.6	21.17	20.96
		6	0	21.28	20.99	21

Band/BW	Modulation	RB Size	RB Offset	Low CH (26805)	Mid CH (26915)	High CH (27025)
				Frequency (825.5)MHz	Frequency (836.5)MHz	Frequency (847.5)MHz
5/3	QPSK	1	0	20.93	21.65	21.48
		1	7	21.16	21.15	21.26
		1	14	21.67	21.39	21.49
		8	0	21.24	21.48	21.71
		8	3	21.37	21.34	21.11
		8	7	21.25	21.14	21.11
		15	0	21.17	21.75	20.92
	16QAM	1	0	21.14	21.74	21.61
		1	7	21.18	21.69	21.19
		1	14	21.55	21.51	20.92
		8	0	21.23	21.68	21
		8	3	21.01	21.05	21.64
		8	7	21.81	21.73	21.69
		15	0	21.59	21.73	20.99

Band/BW	Modulation	RB Size	RB Offset	Low CH (26815)	Mid CH (26915)	High CH (27015)
				Frequency (826.5)MHz	Frequency (836.5)MHz	Frequency (846.5)MHz
5/5	QPSK	1	0	21.58	21.71	21.44
		1	12	21.45	21.6	21.08
		1	24	21.74	21.27	20.97
		12	0	21.51	21.71	21.74
		12	6	21.67	21.66	21.86
		12	13	21.71	21.8	21.09
		25	0	21.76	21.53	21.08
	16QAM	1	0	21.77	21.57	21.86
		1	12	21.01	21.45	20.92
		1	24	21.59	21.79	20.97
		12	0	21.43	21.87	21.01
		12	6	21.35	21.59	21.46
		12	13	21.67	21.07	21.68
		25	0	21.62	21.75	21.43

Band/BW	Modulation	RB Size	RB Offset	Low CH (26840)	Mid CH (26915)	High CH (26990)
				Frequency (829)MHz	Frequency (836.5)MHz	Frequency (844)MHz
5/10	QPSK	1	0	20.94	21.12	21.54
		1	24	21.54	21.13	21.5
		1	49	21.34	21.61	21.7
		25	0	20.97	21.11	21.41
		25	12	21.01	21.26	21.58
		25	25	21.47	21.43	21.14
		50	0	21.84	21.59	20.9
	16QAM	1	0	20.94	21.37	21.57
		1	24	21.11	21.11	21.07
		1	49	20.95	21.66	21.41
		25	0	21.74	21.54	21.48
		25	12	21.05	21.68	21.48
		25	25	21.48	20.95	21.46
		50	0	21.02	21.64	21

Band/BW	Modulation	RB Size	RB Offset	Low CH 23017	Mid CH 23095	High CH 23173
				Frequency 699.7 MHz	Frequency 707.5 MHz	Frequency 715.3 MHz
12/1.4	QPSK	1	0	20.11	19.52	20.3
		1	2	20.24	19.74	20.08
		1	5	20.35	19.7	19.41
		3	0	19.88	20.28	19.94
		3	1	20.24	19.78	19.59
		3	3	20.18	20.33	20.01
		6	0	19.47	19.92	19.57
	16QAM	1	0	20.38	20.27	19.69
		1	2	20.15	20.14	20.16
		1	5	19.71	20.26	19.78
		3	0	19.49	19.87	19.83
		3	1	20.22	19.88	19.9
		3	3	19.97	19.89	20.2
		6	0	19.95	20.3	20.19

Band/BW	Modulation	RB Size	RB Offset	Low CH 23025	Mid CH 23095	High CH 23165
				Frequency 700.5 MHz	Frequency 707.5 MHz	Frequency 714.5 MHz
12/3	QPSK	1	0	19.87	19.67	20.08
		1	7	19.62	19.63	19.94
		1	14	20.24	19.83	19.61
		8	0	20.36	20.23	19.9
		8	3	19.65	20.35	19.42
		8	7	20.21	20.23	19.83
		15	0	19.77	20.3	20.34
	16QAM	1	0	19.92	19.48	19.79
		1	7	19.7	20.29	19.85
		1	14	20.14	20.35	20.09
		8	0	20.32	19.61	19.94
		8	3	19.58	19.72	19.75
		8	7	20.14	19.47	20.28
		15	0	19.96	20.17	19.95

Band/BW	Modulation	RB Size	RB Offset	Low CH 23035	Mid CH 23095	High CH 23155
				Frequency 701.5 MHz	Frequency 707.5 MHz	Frequency 713.5 MHz
12/5	QPSK	1	0	20.35	19.54	19.45
		1	12	20.01	19.64	20.09
		1	24	19.51	19.48	19.83
		12	0	20.25	20.39	19.53
		12	6	19.63	20.05	20.09
		12	13	20.27	19.85	20.18
		25	0	19.6	19.47	19.59
	16QAM	1	0	19.74	19.79	20.37
		1	12	19.61	19.68	19.88
		1	24	19.52	20.21	20.12
		12	0	19.77	20	19.85
		12	6	19.58	20.26	19.74
		12	13	19.4	19.67	19.66
		25	0	19.55	20.23	19.9

Band/BW	Modulation	RB Size	RB Offset	Low CH 23060	Mid CH 23095	High CH 23130
				Frequency 704 MHz	Frequency 707.5 MHz	Frequency 711 MHz
12/10	QPSK	1	0	19.55	20.21	19.82
		1	24	19.77	20.18	19.9
		1	49	20.04	19.73	19.83
		25	0	20.18	20.18	20.14
		25	12	20.06	19.86	20.26
		25	25	19.77	19.91	19.9
		50	0	19.54	19.61	19.52
	16QAM	1	0	19.62	20.19	19.88
		1	24	19.63	19.4	19.85
		1	49	20.39	20.18	19.47
		25	0	19.57	20.2	19.52
		25	12	20.36	20.34	19.72
		25	25	19.44	20.33	19.65
		50	0	20.1	20.21	20.03



Band/BW	Modulation	RB Size	RB Offset	CH 23205	CH 23230	CH 23255
				779.5 MHz	782.0 MHz	784.5 MHz
13 / 5	QPSK	1	0	21.47	21.46	21.41
		1	12	21.02	21.5	20.9
		1	24	20.96	21.28	21.85
		12	0	21.57	21.14	21.06
		12	6	21.43	21.76	21.66
		12	13	21.51	21.23	21.22
		25	0	21.37	21.56	21.07
	16QAM	1	0	21.73	21.76	21.24
		1	12	21.74	21.13	21.26
		1	24	21.71	21.55	21.83
		12	0	21.01	21.43	21.68
		12	6	21.34	21.05	21.42
		12	13	20.89	21.16	21.01
		25	0	21.63	21.3	21

Band/BW	Modulation	RB Size	RB Offset	CH	CH 23230	CH
				MHz	782.0 MHz	MHz
13 / 10	QPSK	1	0	/	21.11	/
		1	24	/	21.49	/
		1	49	/	21.15	/
		25	0	/	21.2	/
		25	12	/	20.96	/
		25	25	/	21.64	/
		50	0	/	21.4	/
	16QAM	1	0	/	21.06	/
		1	24	/	21.65	/
		1	49	/	21.59	/
		25	0	/	21.79	/
		25	12	/	21.31	/
		25	25	/	21.86	/
		50	0	/	21.44	/

ERP						
Band/BW	Modulation	RB Size	RB Offset	CH 23305	CH 23330	CH 23355
				790.5 MHz	793.0 MHz	795.5 MHz
14 / 5	QPSK	1	0	21.5	21.31	21.37
		1	12	21.04	20.93	21.5
		1	24	21.25	21.58	21.28
		12	0	21.05	21.45	21.57
		12	6	21.05	21.82	21.34
		12	13	21.31	21.01	21.05
		25	0	21.45	21.06	21.38
	16QAM	1	0	21.35	21.22	21.65
		1	12	21.27	21.1	21.04
		1	24	21.39	21.1	21.21
		12	0	21.07	21.57	21.83
		12	6	21.45	21.61	21.44
		12	13	21.59	21.41	20.99
		25	0	21.35	21.13	21.24

ERP						
Band/BW	Modulation	RB Size	RB Offset	CH	CH 23330	CH
				MHz	793 MHz	MHz
14 / 10	QPSK	1	0	/	21.71	/
		1	24	/	21.83	/
		1	49	/	21.39	/
		25	0	/	21.71	/
		25	12	/	21.05	/
		25	25	/	20.97	/
		50	0	/	20.97	/
	16QAM	1	0	/	21.36	/
		1	24	/	20.95	/
		1	49	/	21.46	/
		25	0	/	21.14	/
		25	12	/	21.64	/
		25	25	/	21.31	/
		50	0	/	21.25	/

Band/BW	Modulation	RB Size	RB Offset	Low CH 131979	Mid CH 132322	High CH 132665
				1710.7 MHz	1745 MHz	1779.3 MHz
66/1.4	QPSK	1	0	19.64	19.59	20.23
		1	2	19.66	20.03	19.59
		1	5	20.13	19.8	20.07
		3	0	20.27	19.63	19.97
		3	1	19.49	20.14	20.32
		3	3	19.48	19.73	19.53
	16QAM	6	0	20.1	20.38	19.61
		1	0	20.15	19.96	19.59
		1	2	20.14	20.03	19.74
		1	5	19.73	20.29	20.27
		3	0	20.38	19.77	20.29
		3	1	19.59	19.93	19.51
		3	3	20.06	19.53	20.37
		6	0	20.16	19.7	19.44

Band/BW	Modulation	RB Size	RB Offset	Low CH 131987	Mid CH 132322	High CH 132647
				1711.5 MHz	1745 MHz	1778.5 MHz
66/3	QPSK	1	0	19.69	19.77	20.38
		1	7	20.13	19.93	19.48
		1	14	20.28	19.55	19.4
		8	0	20.16	20	20.01
		8	3	19.74	19.53	20.3
		8	7	19.7	20.01	20.28
		15	0	19.72	19.43	19.52
	16QAM	1	0	19.7	19.77	19.75
		1	7	19.39	19.94	19.72
		1	14	20.21	19.48	20.01
		8	0	20.3	20	19.42
		8	3	20.16	20.29	19.92
		8	7	20.21	19.94	20.17
		15	0	19.51	20.15	20.17

Band/BW	Modulation	RB Size	RB Offset	Low CH 131997	Mid CH 132322	High CH 132647
				1712.5 MHz	1745 MHz	1777.5 MHz
66/5	QPSK	1	0	19.78	19.47	19.71
		1	12	20.19	19.94	19.54
		1	24	19.63	20.01	20.34
		12	0	20.24	19.6	20.38
		12	6	19.6	19.72	20.15
		12	13	19.5	20.38	19.83
		25	0	20.3	20.33	19.57
	16QAM	1	0	20.33	19.6	19.6
		1	12	19.4	19.57	20.35
		1	24	19.98	19.57	19.54
		12	0	19.69	19.61	20.18
		12	6	20.33	20.02	19.99
		12	13	20.38	19.86	20.25
		25	0	20.28	20.3	19.66

Band/BW	Modulation	RB Size	RB Offset	Low CH 132047	Mid CH 132322	High CH 132622
				1715 MHz	1745 MHz	1775 MHz
66/10	QPSK	1	0	20.28	19.44	20.3
		1	24	20.1	20.34	19.51
		1	49	20	19.65	19.73
		25	0	20.34	19.74	20.09
		25	12	19.44	19.78	20.33
		25	25	20.21	20.27	20.32
		50	0	19.67	20.18	20.28
	16QAM	1	0	19.94	20.36	19.57
		1	24	19.73	20.38	20.24
		1	49	20.18	20.02	19.78
		25	0	19.42	19.71	19.68
		25	12	20.35	19.6	19.92
		25	25	19.77	20.08	19.52
		50	0	19.69	20.14	19.92

Band/BW	Modulation	RB Size	RB Offset	Low CH 132047	Mid CH 132322	High CH 132597
				1717.5 MHz	1745 MHz	1772.5 MHz
66/15	QPSK	1	0	20.28	19.45	19.93
		1	37	19.87	19.98	19.69
		1	74	20.08	19.45	19.86
		36	0	20.12	19.47	20.31
		36	19	19.62	19.97	19.51
		36	39	20.28	20.09	19.96
		75	0	19.47	19.96	19.75
	16QAM	1	0	19.96	19.42	19.64
		1	37	19.83	19.99	20.08
		1	74	19.86	19.92	20.28
		36	0	20.24	20.38	20.05
		36	19	20.04	20.05	19.58
		36	39	20.04	20.29	20
		75	0	19.98	19.56	20.27

Band/BW	Modulation	RB Size	RB Offset	Low CH 132072	Mid CH 132322	High CH 132572
				1720 MHz	1745 MHz	1770 MHz
66/20	QPSK	1	0	19.41	20.39	20.27
		1	50	20.15	19.77	20.03
		1	99	20.37	20.23	19.86
		50	0	20.29	19.46	19.68
		50	25	20.12	19.84	19.45
		50	50	20.39	19.57	20.14
		100	0	20.13	20.07	19.83
	16QAM	1	0	20.31	19.87	19.8
		1	50	20.1	19.46	19.48
		1	99	20.02	19.88	19.5
		50	0	19.99	19.96	19.94
		50	25	19.77	19.42	20.23
		50	50	19.43	20.26	20.11
		100	0	20.08	20.1	19.67

Band/BW	Modulation	RB Size	RB Offset	Low CH 133147	Mid CH 133297	High CH 133447
				665.5 MHz	680.5 MHz	695.5 MHz
71/5	QPSK	1	0	20.95	21.65	21.52
		1	12	21.35	21.04	21.79
		1	24	21.05	21.23	21.57
		12	0	21.72	21.49	21.61
		12	6	20.96	21.09	21.37
		12	13	21.3	21.46	21.68
		25	0	21.4	21.09	21.5
	16QAM	1	0	21.13	21.27	21.39
		1	12	21.51	21.36	21.11
		1	24	21.7	21.12	20.94
		12	0	21.47	21.77	21.06
		12	6	21.8	21.63	21.43
		12	13	21.32	21.55	21.27
		25	0	21.08	21.67	21.68

Band/BW	Modulation	RB Size	RB Offset	Low CH 133172	Mid CH 133297	High CH 133422
				668 MHz	680.5 MHz	693 MHz
71/10	QPSK	1	0	21.74	21.84	21.2
		1	24	21.74	21.89	20.95
		1	49	21.59	21.03	21.16
		25	0	20.98	21.67	21.16
		25	12	21.79	21.7	20.92
		25	25	21.35	21.26	21.81
		50	0	21.36	20.97	21.27
	16QAM	1	0	21	21.73	20.95
		1	24	21.72	21.52	21.12
		1	49	21.44	20.99	21.87
		25	0	21.28	21.71	21.21
		25	12	20.93	21.7	21.53
		25	25	21.28	21.03	21.1
		50	0	21.22	21.87	21.41

Band/BW	Modulation	RB Size	RB Offset	Low CH 133197	Mid CH 133297	High CH 133397
				670.5 MHz	680.5 MHz	693 MHz
71/15	QPSK	1	0	21.19	21.32	20.89
		1	37	21.62	21.72	21.62
		1	74	21.22	21.35	21.48
		36	0	20.99	21.61	21.13
		36	19	21.37	21.76	21.78
		36	39	21.35	21.14	21.51
		75	0	21.84	21.62	21.44
	16QAM	1	0	21.15	21.47	21.15
		1	37	21.59	21.15	21.22
		1	74	21.76	21.26	21.36
		36	0	21.78	21.46	21.84
		36	19	20.99	21.39	21.79
		36	39	21.66	21.23	21.81
		75	0	21.04	21.62	21.24

Band/BW	Modulation	RB Size	RB Offset	Low CH 133222	Mid CH 133322	High CH 133372
				673 MHz	683 MHz	688 MHz
71/20	QPSK	1	0	21.01	20.94	21.6
		1	50	21.66	21.15	21.8
		1	99	21.27	21.38	21.49
		50	0	21.84	21.76	21.32
		50	25	21.83	21.27	20.96
		50	50	21.46	21.62	21.77
		100	0	21.2	21.47	21.56
	16QAM	1	0	20.92	21.82	21.32
		1	50	21.34	21.74	21.79
		1	99	21.79	21.71	21.34
		50	0	21.85	21.31	21.52
		50	25	21.19	21.41	21.54
		50	50	21.79	21.41	21.13
		100	0	21.52	21.27	21.53

### APPENDIX C: TEST DATA FOR OCCUPIED BANDWIDTH

Operation Mode	Band Width	Channel Number	Channel Frequency (MHz)	QPSK		16QAM	
				Occupied Bandwidth (KHz)	Emission Bandwidth (KHz)	Occupied Bandwidth (KHz)	Emission Bandwidth (KHz)
LTE BAND2	1.4MHz	18900	1880	1099	1309	1103	1296
	3MHz	18900	1880	2700	2961	2701	2992
	5MHz	18900	1880	4516	5012	4530	5036
	10MHz	18900	1880	9032	10020	9021	10000
	15MHz	18900	1880	13477	14900	13447	14660
	20MHz	18900	1880	18346	20430	18344	20400
LTE BAND4	1.4MHz	20175	1732.5	1098	1313	1097	1306
	3MHz	20175	1732.5	2700	2984	2701	3003
	5MHz	20175	1732.5	4520	4996	4523	5035
	10MHz	20175	1732.5	9029	10010	9005	10010
	15MHz	20175	1732.5	13428	14720	13444	14670
	20MHz	20175	1732.5	18246	20260	18283	20280
LTE BAND5	1.4MHz	20525	836.5	1097	1269	1102	1283
	3MHz	20525	836.5	2699	2979	2695	2981
	5MHz	20525	836.5	4512	4970	4515	4974
	10MHz	20525	836.5	9019	9975	8982	9926
LTE BAND12	1.4MHz	23095	707.5	1099	1300	1096	1277
	3MHz	23095	707.5	2701	2977	2693	3003
	5MHz	23095	707.5	4528	4991	4534	4972
	10MHz	23095	707.5	9012	9937	8996	9889
LTE BAND13	5MHz	23230	782.0	4528	5014	4506	4991
	10MHz	23230	782.0	8996	9971	8981	9962
LTE BAND14	5MHz	23330	793.0	4509	5028	4515	4975
	10MHz	23330	793.0	9054	10060	9035	9971
LTE BAND66	1.4MHz	132322	1745.0	1096	1300	1096	1295
	3MHz	132322	1745.0	2699	2998	2699	2985
	5MHz	132322	1745.0	4530	5018	4537	5017
	10MHz	132322	1745.0	9023	10010	9028	10040
	15MHz	132322	1745.0	13474	14610	13452	14650
	20MHz	132322	1745.0	18355	20450	18331	20320
LTE BAND71	5MHz	133297	680.5	4493	4987	4499	4994
	10MHz	133297	680.5	8976	9876	8936	9914
	15MHz	133297	680.5	13320	14520	13330	14580
	20MHz	1333422	683.0	18052	20030	18045	20060



Test plots as follow:

LTE Band 2: Occupied Bandwidth and Emission Bandwidth

Test BW: 1.4MHz – Middle Channel

**QPSK**

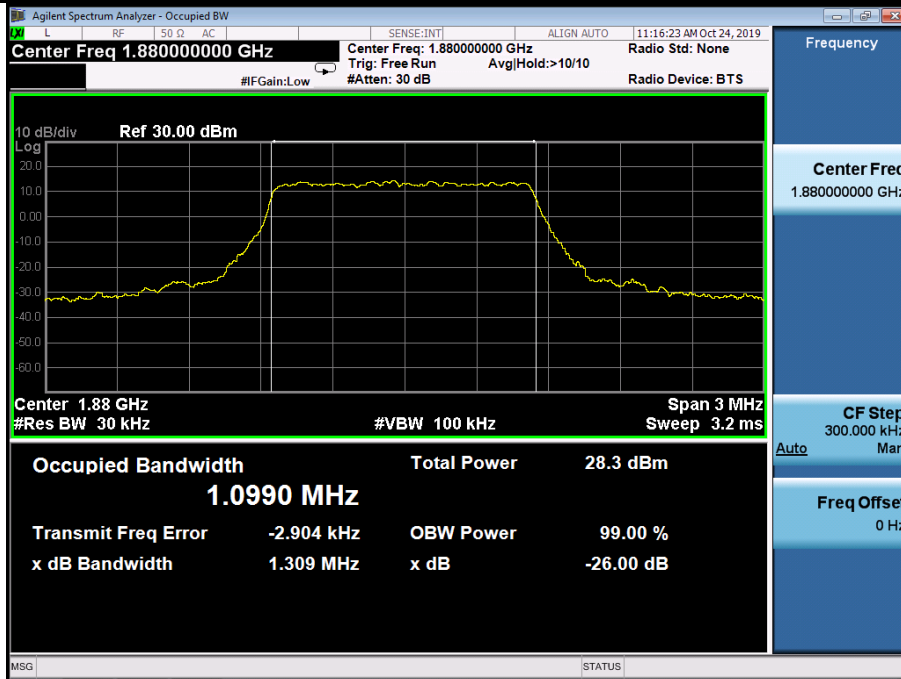

**16QAM**

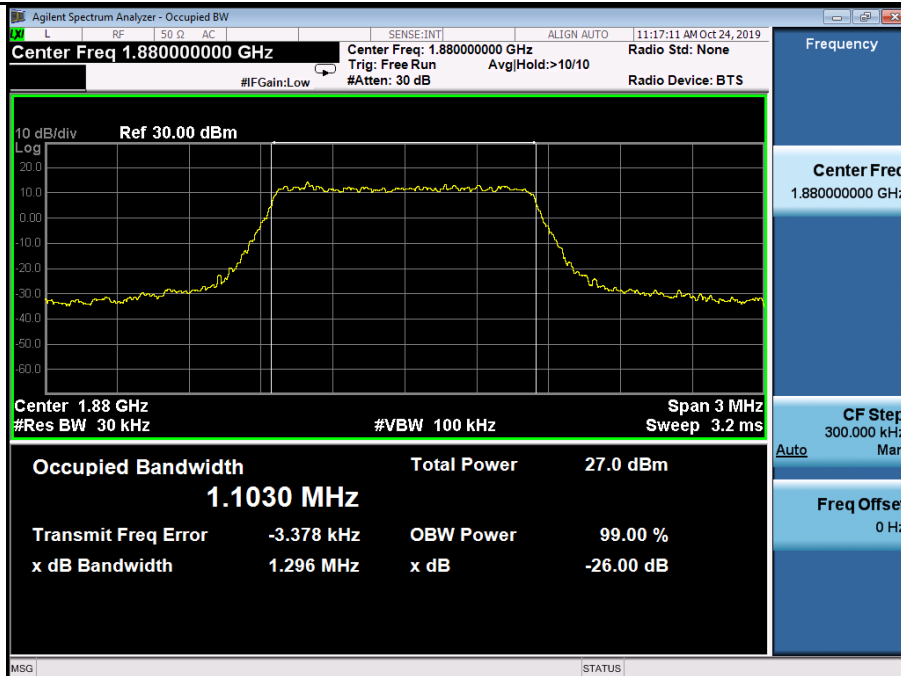

LTE Band 2: Occupied Bandwidth and Emission Bandwidth

Test BW: 3 MHz – Middle Channel

QPSK

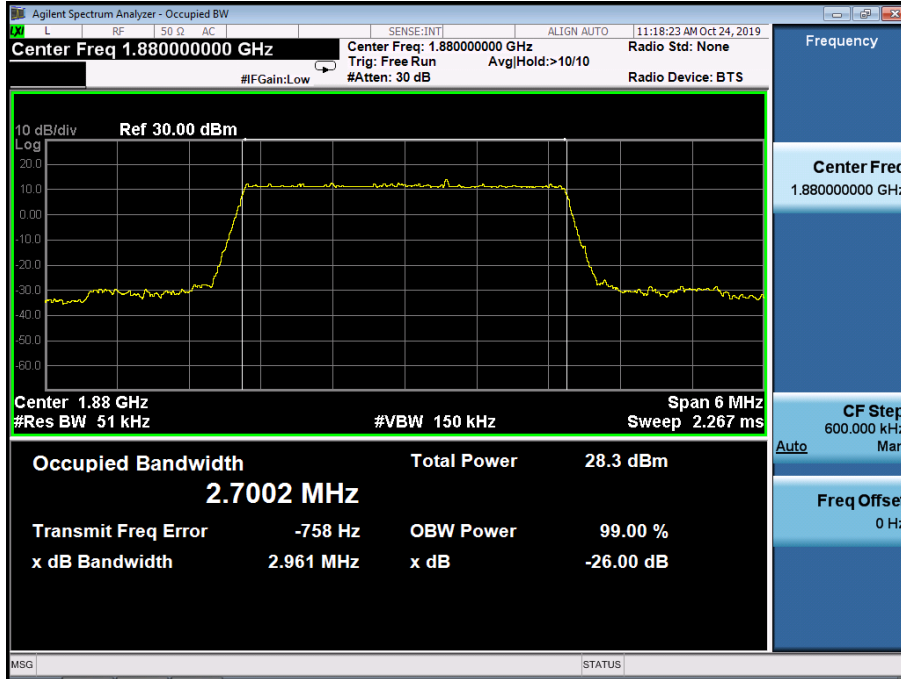

16QAM

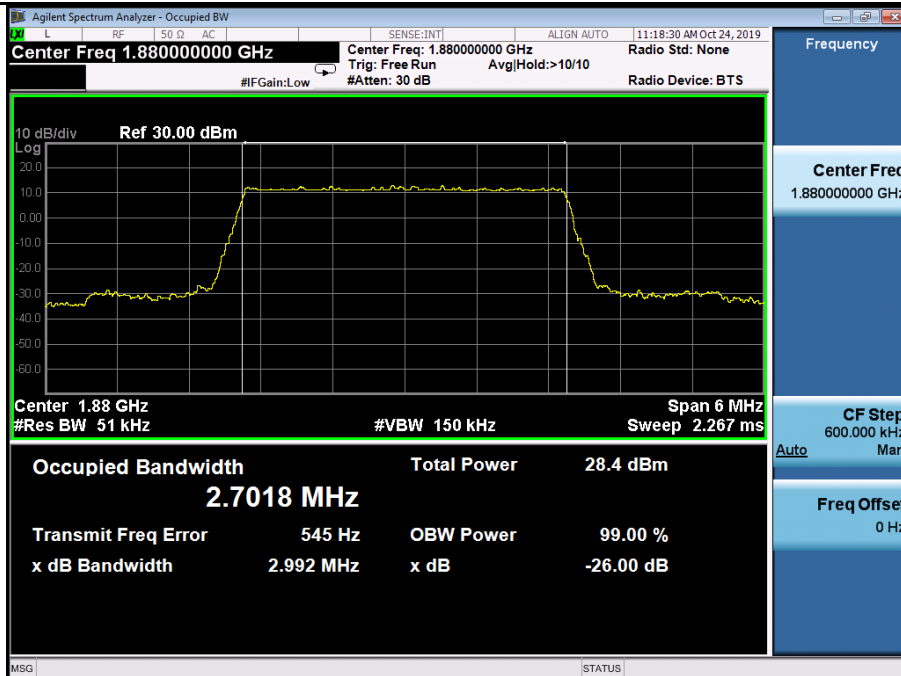

LTE Band 2: Occupied Bandwidth and Emission Bandwidth

Test BW: 5 MHz – Middle Channel

QPSK

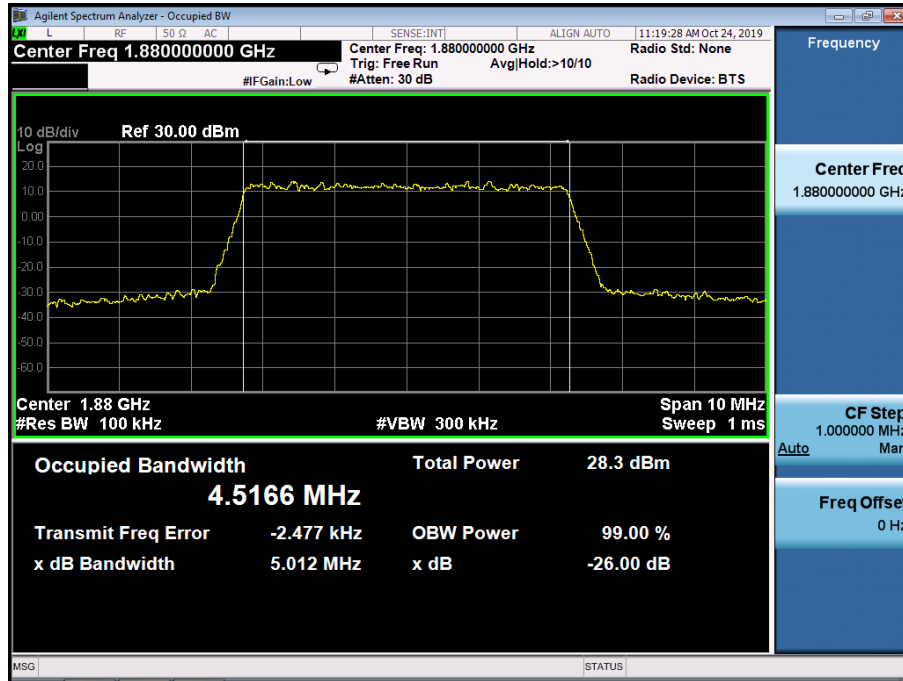

16QAM

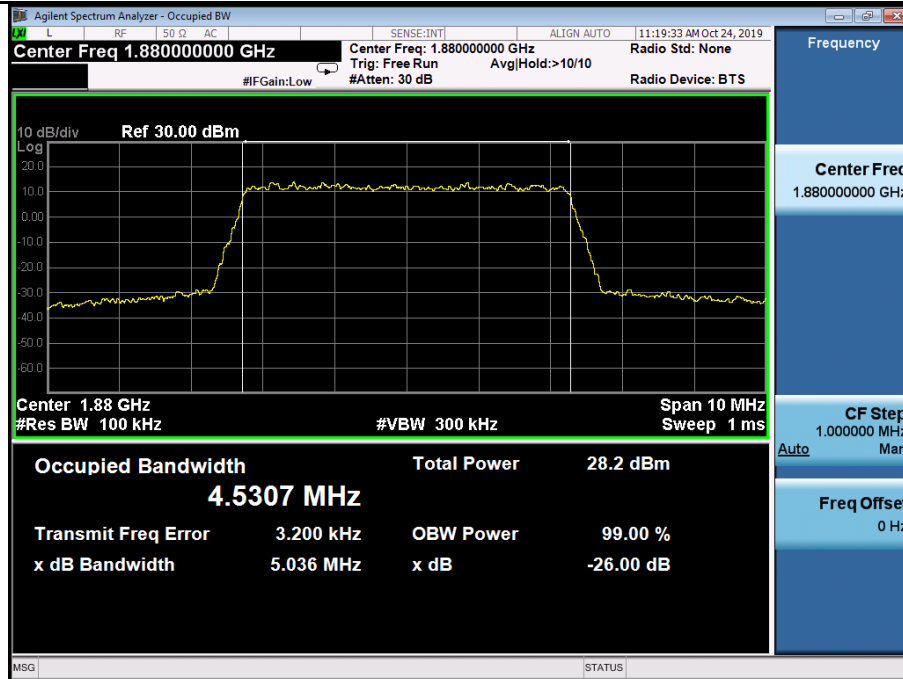

LTE Band 2: Occupied Bandwidth and Emission Bandwidth

Test BW: 10 MHz – Middle Channel

QPSK

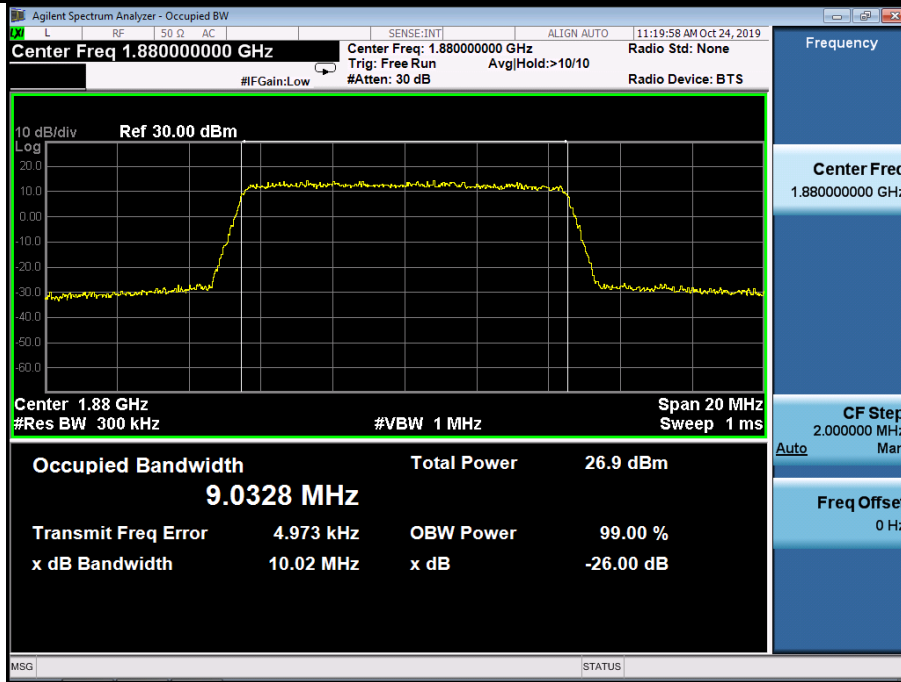

16QAM

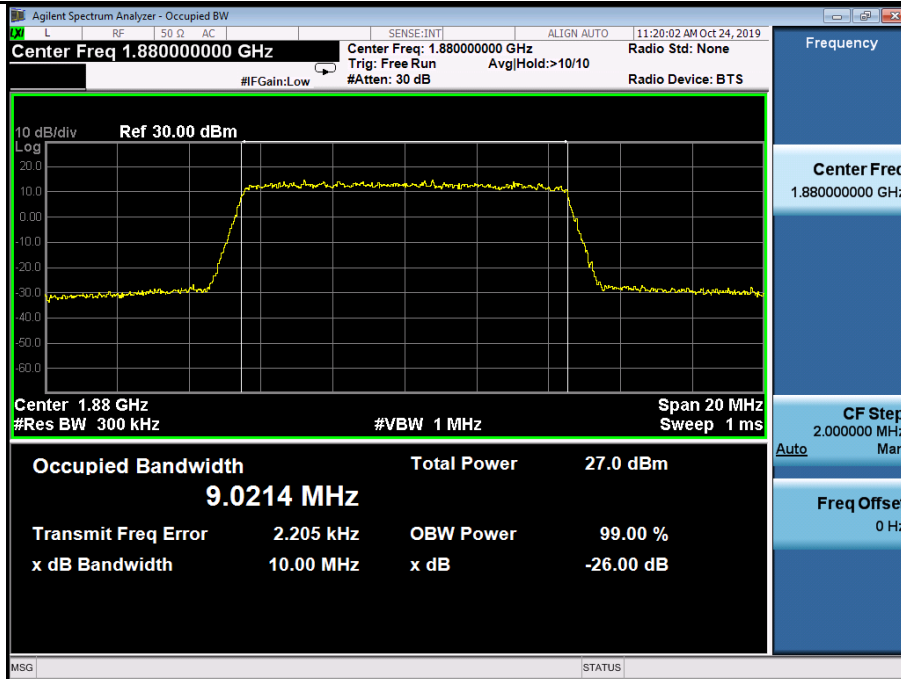

LTE Band 2: Occupied Bandwidth and Emission Bandwidth

Test BW: 15 MHz – Middle Channel

QPSK

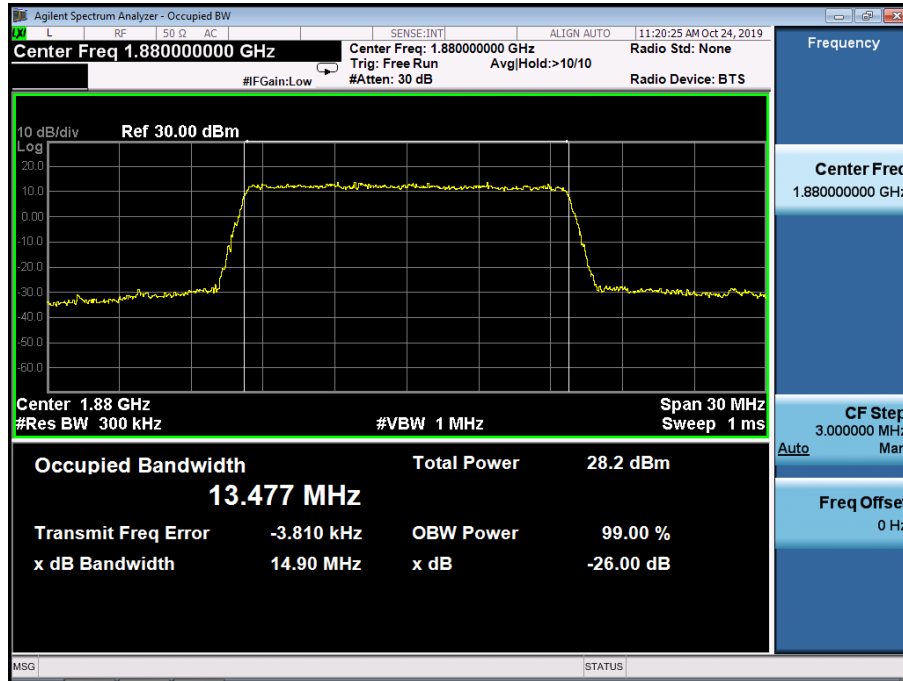

16QAM

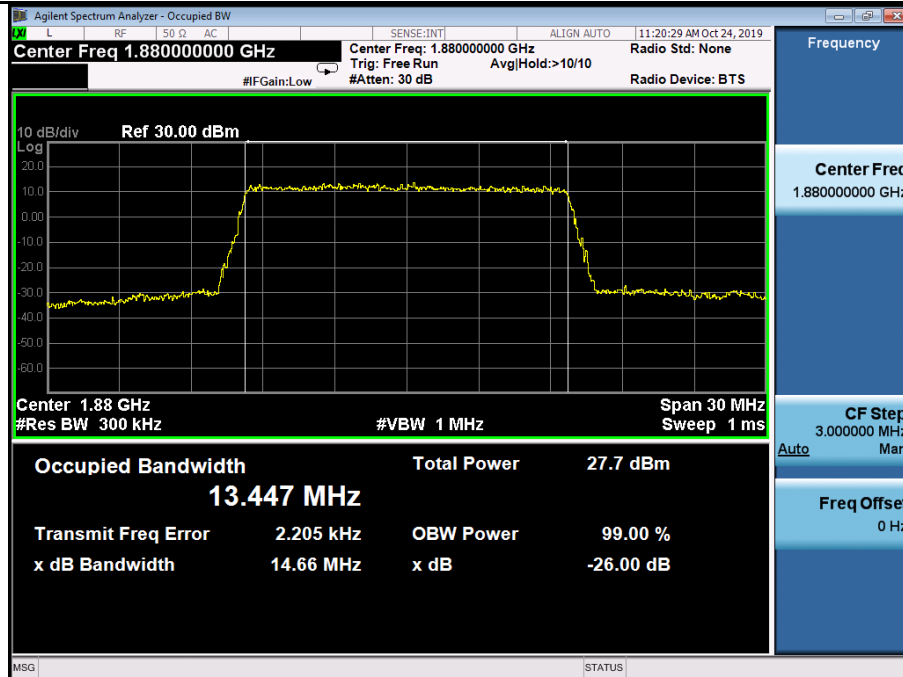

LTE Band 2: Occupied Bandwidth and Emission Bandwidth

Test BW: 20 MHz – Middle Channel

QPSK

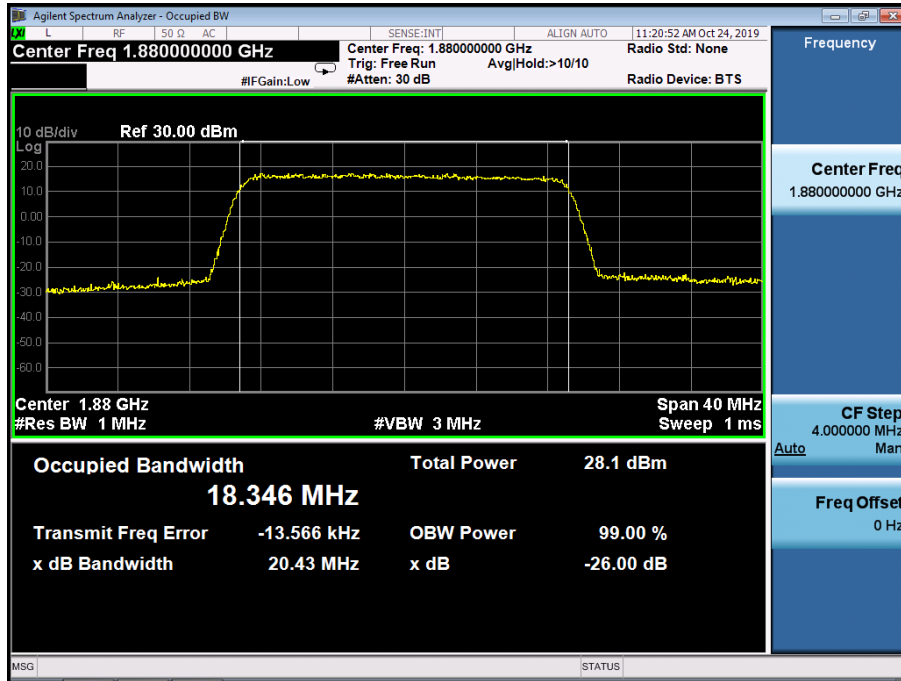

16QAM

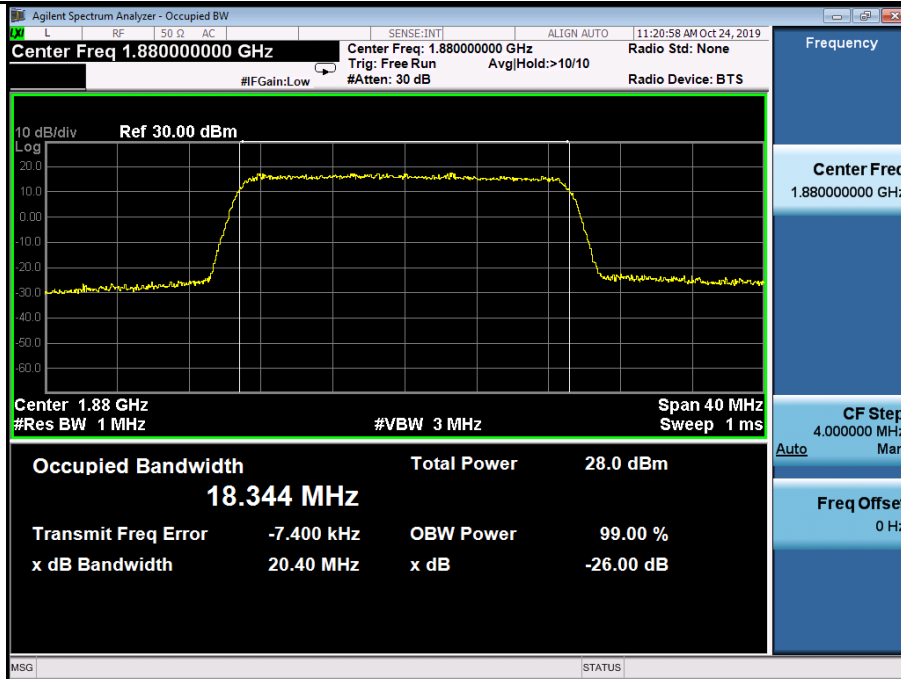

LTE Band 4: Occupied Bandwidth and Emission Bandwidth

Test BW: 1.4MHz – Middle Channel

QPSK

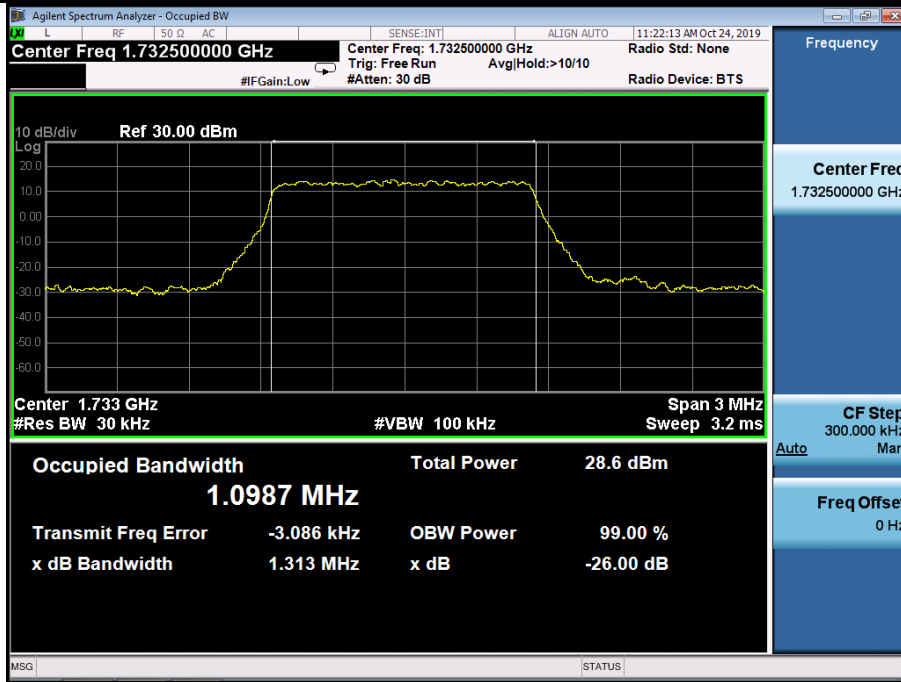

16QAM

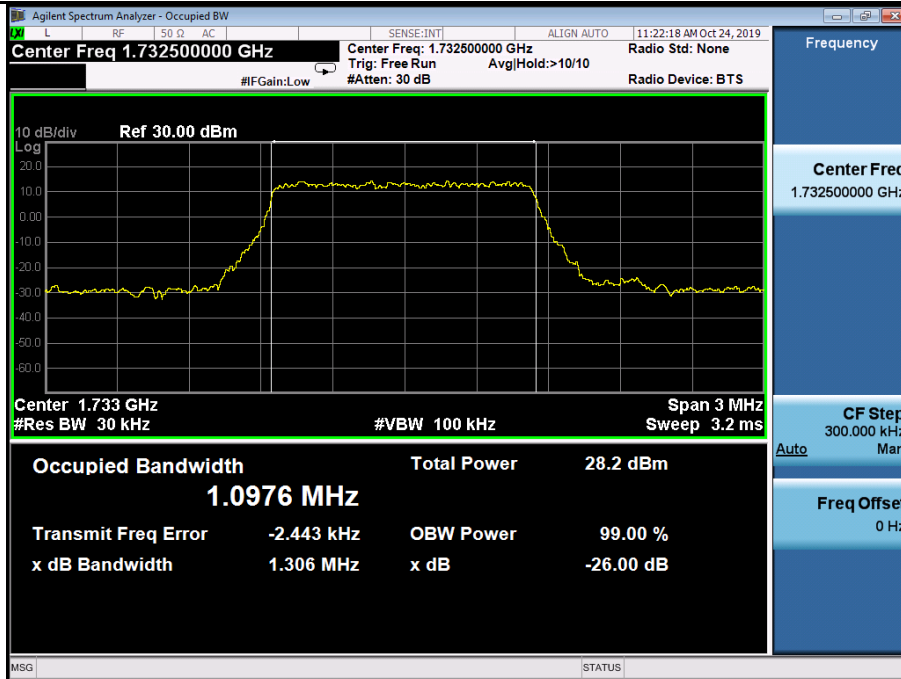

LTE Band 4: Occupied Bandwidth and Emission Bandwidth

Test BW: 3 MHz – Middle Channel

QPSK

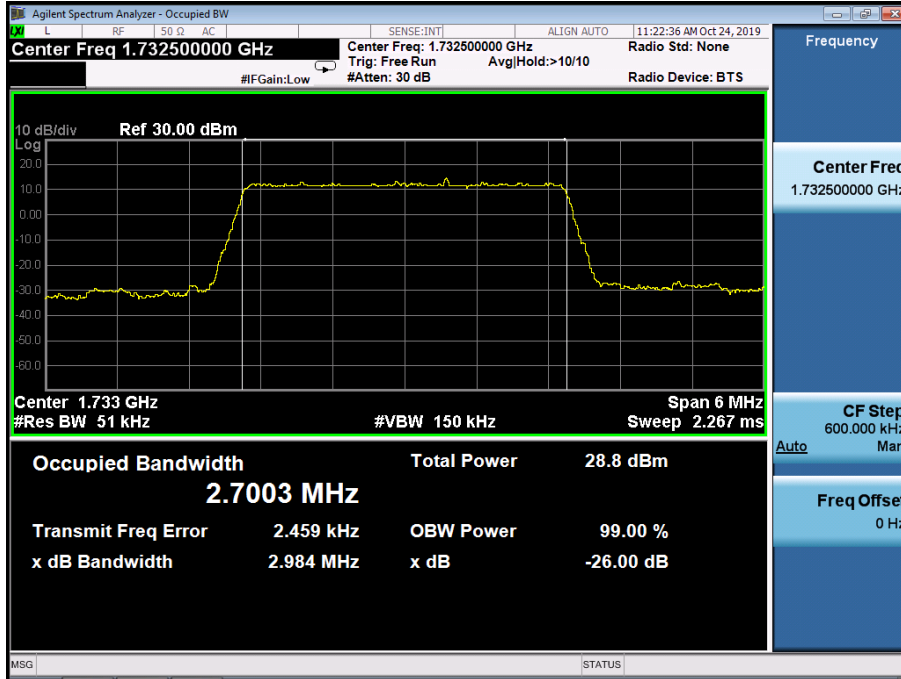

16QAM

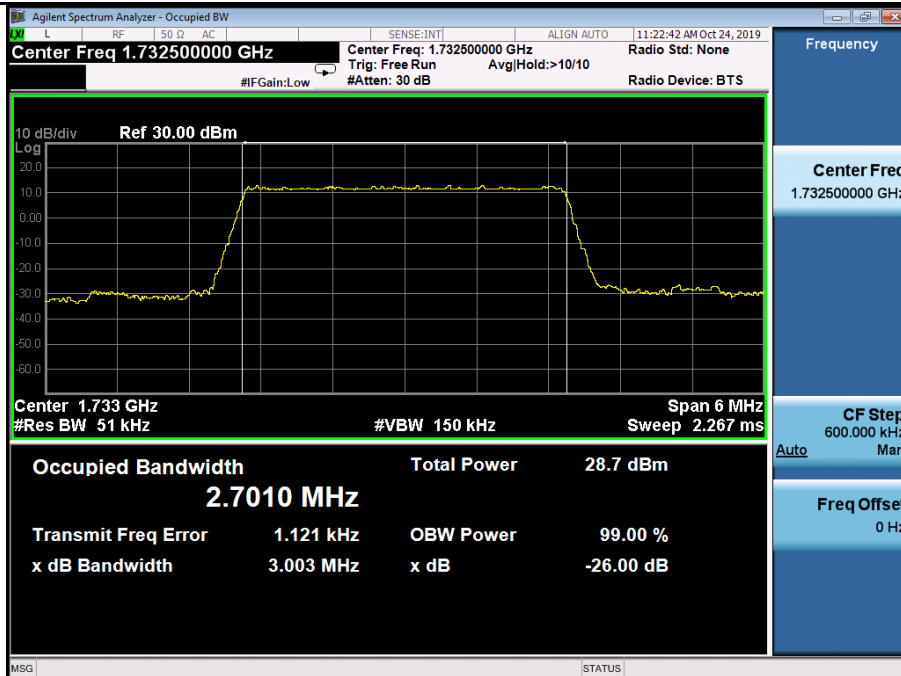



LTE Band 4: Occupied Bandwidth and Emission Bandwidth

Test BW: 5 MHz – Middle Channel

QPSK

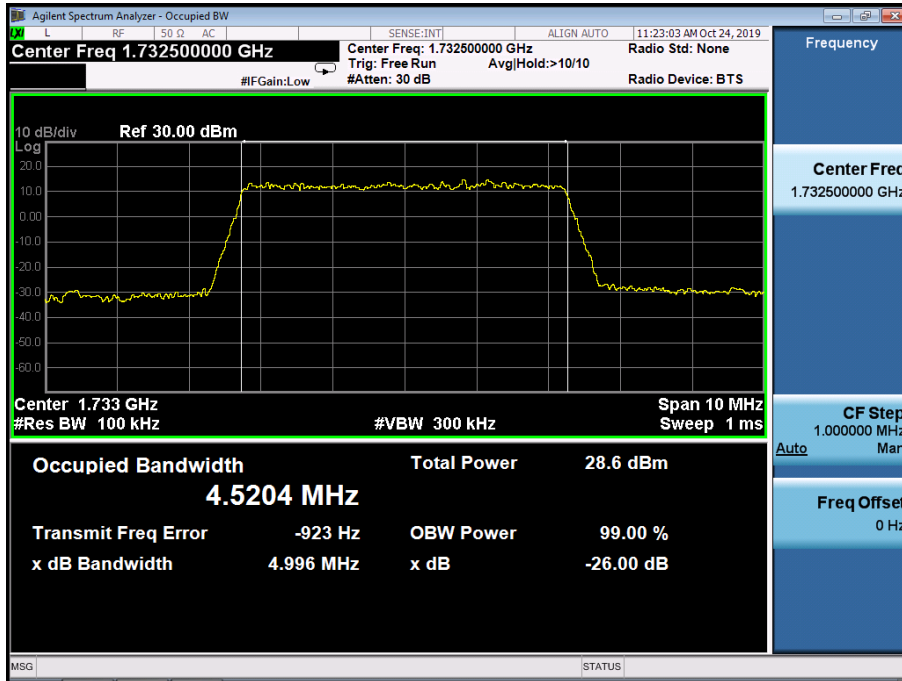

16QAM

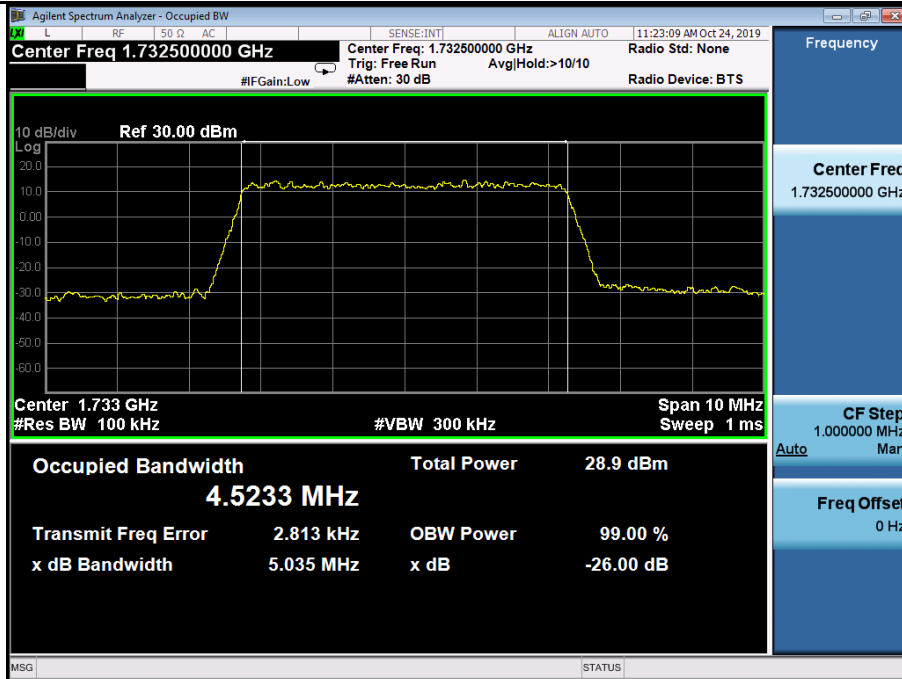

LTE Band 4: Occupied Bandwidth and Emission Bandwidth

Test BW: 10 MHz – Middle Channel

QPSK

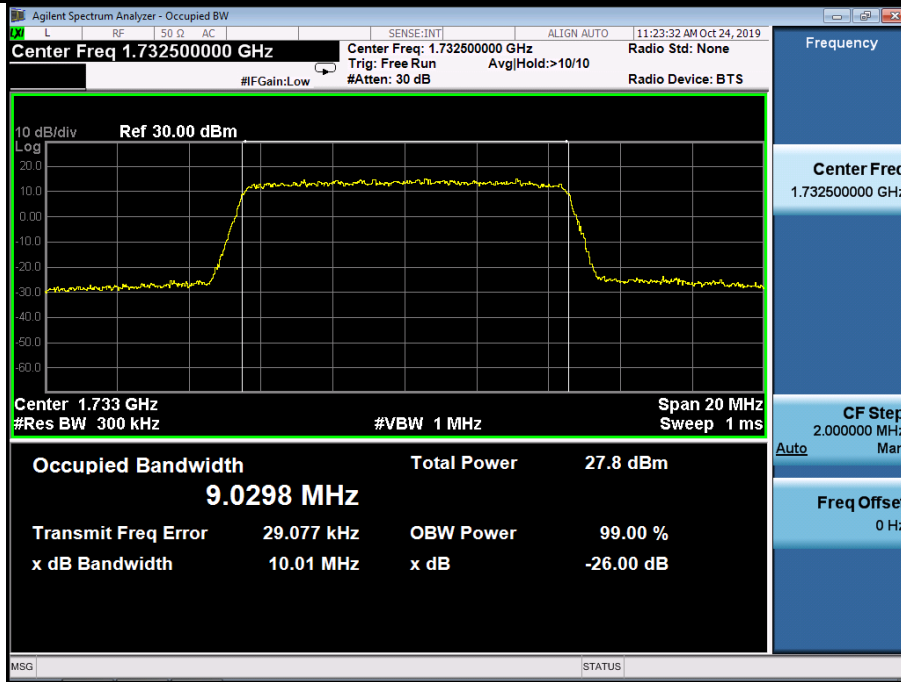

16QAM

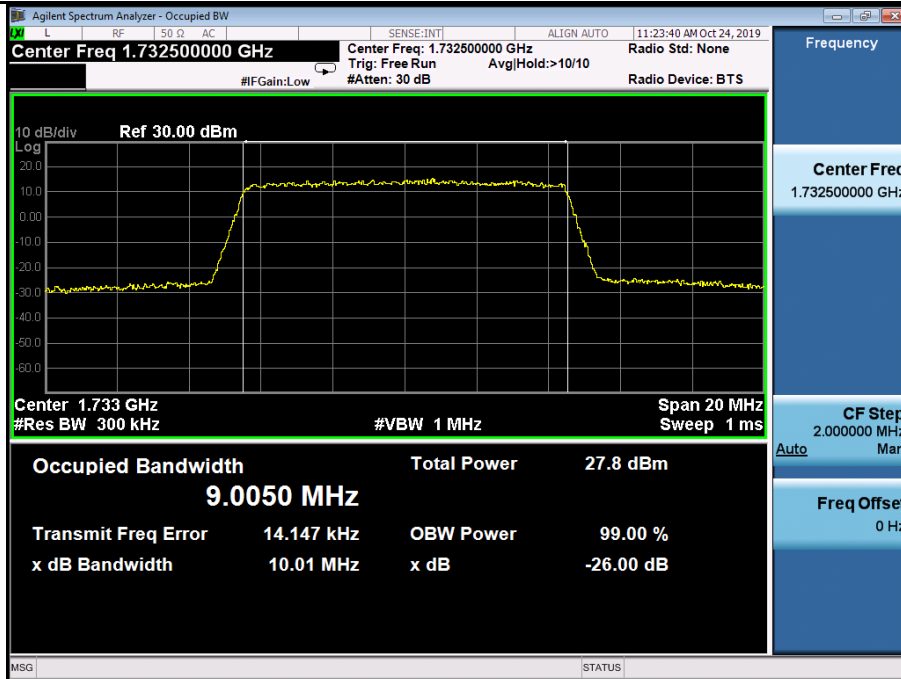

LTE Band 4: Occupied Bandwidth and Emission Bandwidth

Test BW: 15 MHz – Middle Channel

QPSK

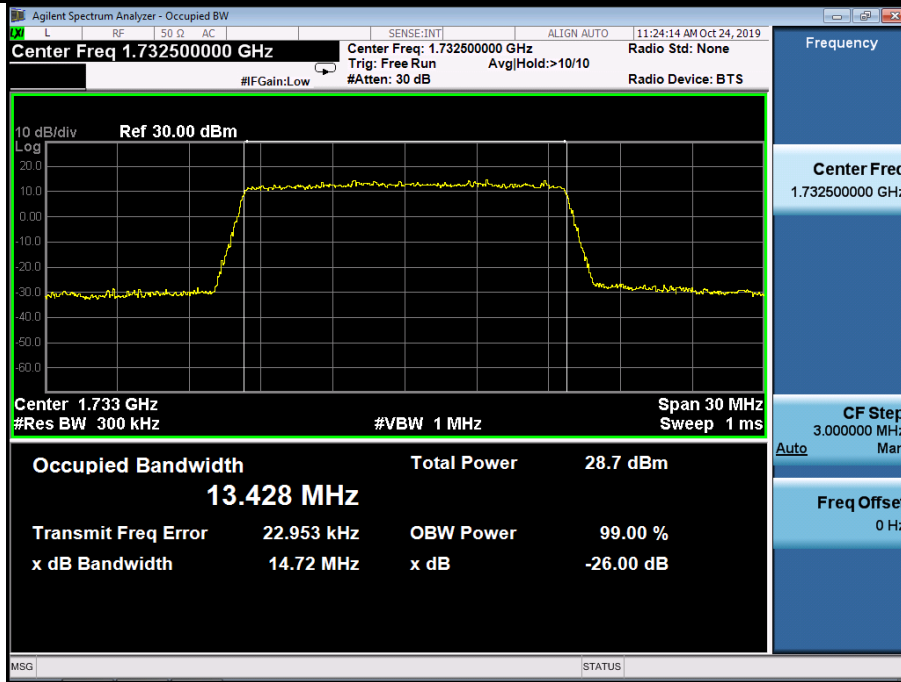

16QAM

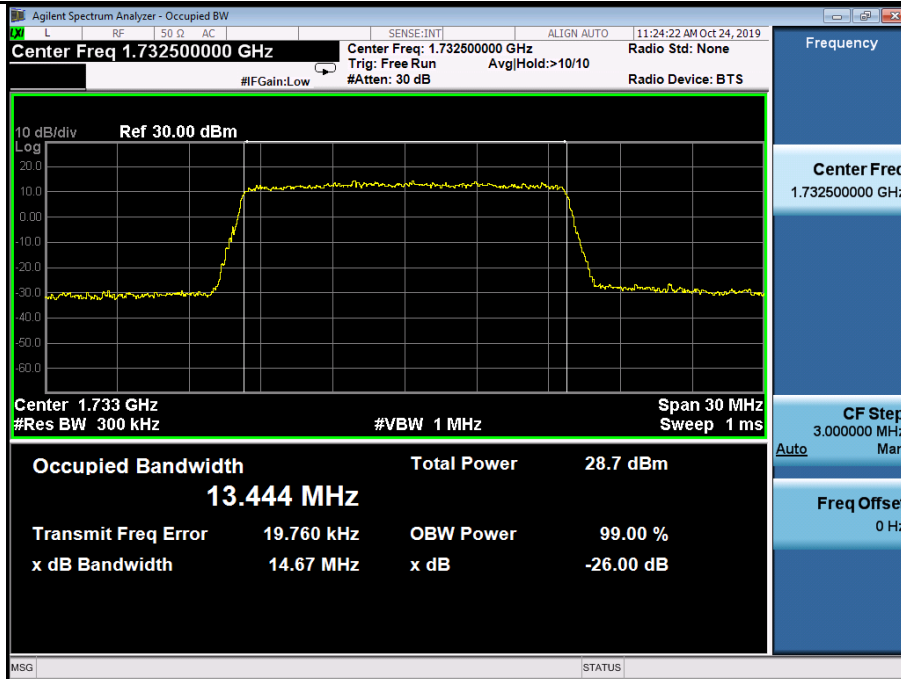

LTE Band 4: Occupied Bandwidth and Emission Bandwidth

Test BW: 20 MHz – Middle Channel

QPSK

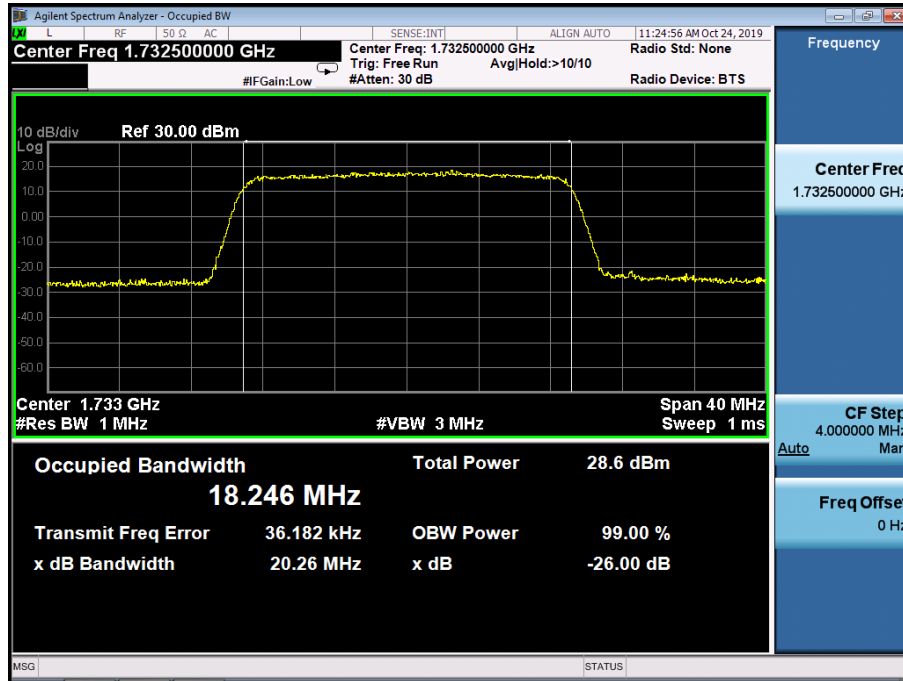

16QAM

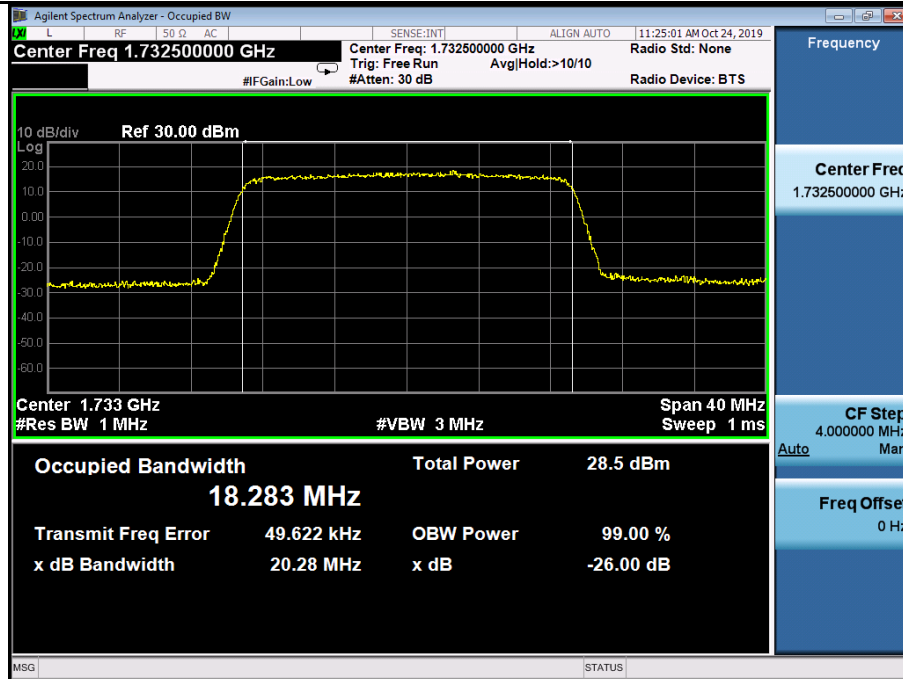

LTE Band 5: Occupied Bandwidth and Emission Bandwidth

Test BW: 1.4MHz – Middle Channel

QPSK

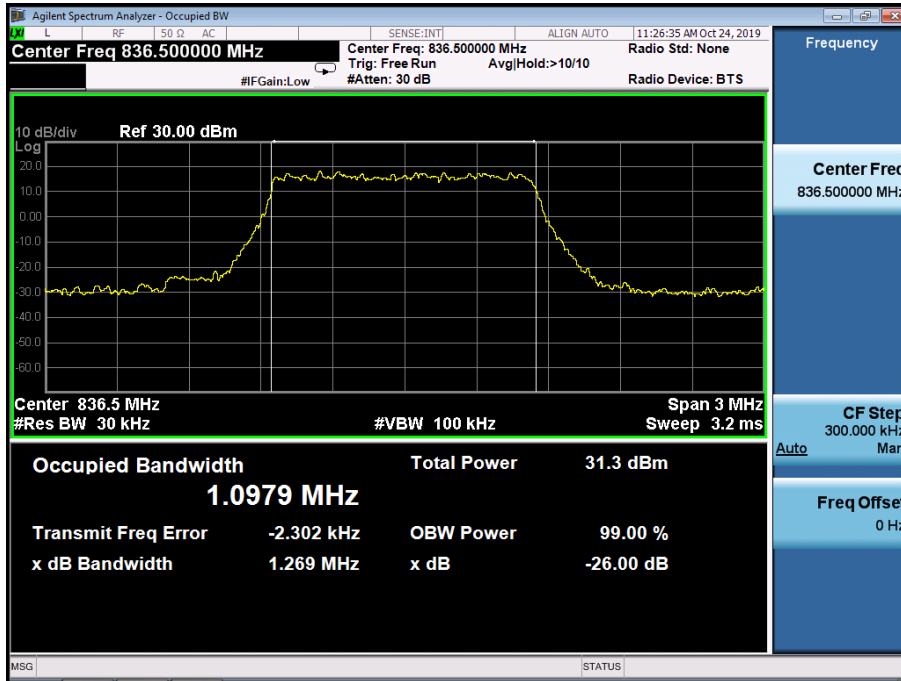

16QAM

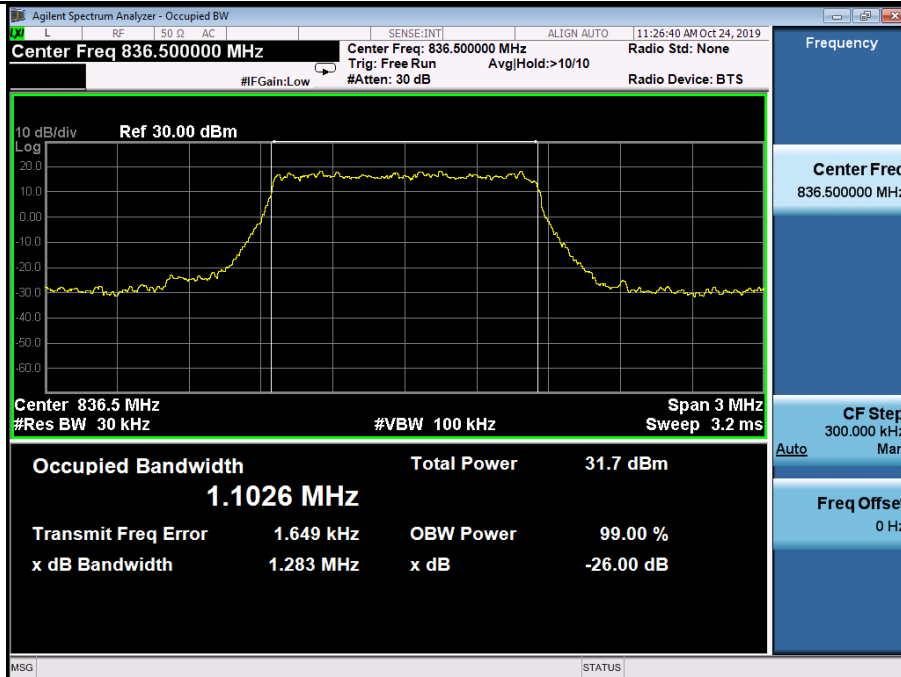

LTE Band 5: Occupied Bandwidth and Emission Bandwidth

Test BW: 3 MHz – Middle Channel

QPSK



16QAM

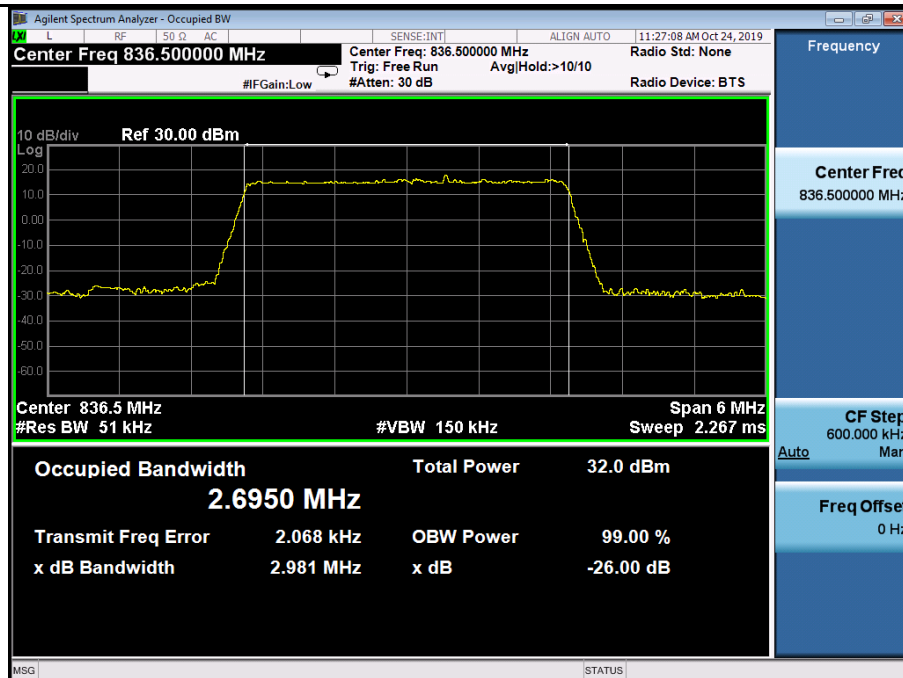

LTE Band 5: Occupied Bandwidth and Emission Bandwidth

Test BW: 5 MHz – Middle Channel

QPSK

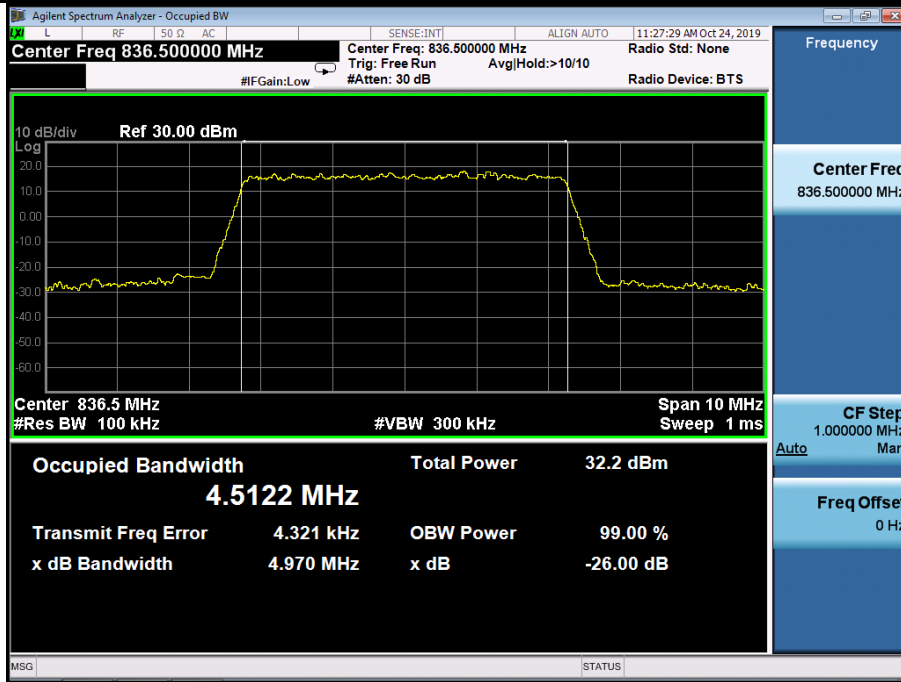

16QAM

