



# FCC TEST REPORT

**Test report  
On Behalf of  
Streamax Technology Co.,Ltd.  
For  
CAMERA  
Model No.: C6D**

**FCC ID: 2AM6L-C6D**

**Prepared for :** Streamax Technology Co.,Ltd.  
21-23/F, Building B1, Zhiyuan, No. 1001, Xueyuan Avenue, Nanshan District,  
Shenzhen, Guangdong,P.R. China.

**Prepared By :** Shenzhen HUAK Testing Technology Co., Ltd.  
1F, B2 Building, Junfeng Zhongcheng Zhizao Innovation Park, Fuhai Street,  
Bao'an District, Shenzhen City, China

**Date of Test:** Jul. 05, 2018 ~ Aug. 31, 2018

**Date of Report:** Aug. 31, 2018

**Report Number:** HUAK180903942E



### TEST RESULT CERTIFICATION

**Applicant's name** ..... : Streamax Technology Co.,Ltd.  
Address ..... : 21-23/F, Building B1, Zhiyuan, No. 1001, Xueyuan Avenue,  
Nanshan District, Shenzhen, Guangdong,P.R. China.

**Manufacture's Name**..... : Streamax Electronics Co.,Ltd.  
Address ..... : 5th-6thFloor, West, Chuangxiang 2nd Building, Yanxiang  
Technology Park, 11# High-tech West Road, Guangming District,  
Shenzhen, Guangdong Province, P.R. China .

**Product description**

Trade Mark: Streamax  
Product name..... : CAMERA  
Model and/or type reference : C6D

**Standards**..... : FCC Part 15.247  
KDB 558074 D01 DTS Meas Guidance v04

This publication may be reproduced in whole or in part for non-commercial purposes as long as the Shenzhen HUAK Testing Technology Co., Ltd. is acknowledged as copyright owner and source of the material. Shenzhen HUAK Testing Technology Co., Ltd. takes no responsibility for and will not assume liability for damages resulting from the reader's interpretation of the reproduced material due to its placement and context.

**Date of Test**..... :  
Date (s) of performance of tests..... : **Jul. 05, 2018 ~ Aug. 31, 2018**  
Date of Issue..... : **Aug. 31, 2018**  
Test Result ..... : **Pass**

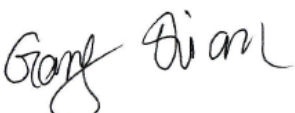
Testing Engineer :   
\_\_\_\_\_  
(Gary Qian)

Technical Manager :   
\_\_\_\_\_  
(Eden Hu)

Authorized Signatory :   
\_\_\_\_\_  
(Jason Zhou)



## Revision History

| Report Version | Revise Time | Issued Date   | Valid Version | Notes           |
|----------------|-------------|---------------|---------------|-----------------|
| V1.0           | /           | Aug. 31, 2018 | Valid         | Initial Release |



## TABLE OF CONTENTS

|  |           |
|--|-----------|
| <b>1. GENERAL INFORMATION .....</b>                              | <b>6</b>  |
| 1.1. PRODUCT DESCRIPTION .....                                   | 6         |
| 1.2. RELATED SUBMITTAL(S)/GRANT(S) .....                         | 6         |
| 1.3. TEST METHODOLOGY .....                                      | 6         |
| 1.4. TEST FACILITY .....   | 7         |
| 1.5. SPECIAL ACCESSORIES.....                                    | 7         |
| 1.6. EQUIPMENT MODIFICATIONS .....                               | 7         |
| <b>2. MEASUREMENT UNCERTAINTY .....</b>                          | <b>8</b>  |
| <b>3. SYSTEM TEST CONFIGURATION.....</b>                         | <b>9</b>  |
| 3.1. CONFIGURATION OF TESTED SYSTEM .....                        | 9         |
| 3.2. EQUIPMENT USED IN TESTED SYSTEM .....                       | 9         |
| <b>4. SUMMARY OF TEST RESULTS .....</b>                          | <b>11</b> |
| <b>5. DESCRIPTION OF TEST MODES .....</b>                        | <b>12</b> |
| <b>6. RADIATED EMISSION.....</b>                                 | <b>13</b> |
| 6.1. MEASUREMENT PROCEDURE .....                                 | 13        |
| 6.2. TEST SETUP .....  | 14        |
| 6.3. LIMITS AND MEASUREMENT RESULT.....                          | 15        |
| 6.4. TEST RESULT .....   | 16        |
| <b>7. BAND EDGE EMISSION.....</b>                                | <b>19</b> |
| 7.1. MEASUREMENT PROCEDURE .....                                 | 19        |
| 7.2. TEST SET-UP .....   | 19        |
| 7.3. RADIATED TEST RESULT.....                                   | 20        |
| <b>8. CONDUCTED TEST RESULT .....</b>                            | <b>21</b> |
| <b>9. 6DB BANDWIDTH .....</b>                                    | <b>22</b> |
| 9.1. TEST PROCEDURE .....  | 22        |
| 9.2. SUMMARY OF TEST RESULTS/PLOTS .....                         | 22        |
| <b>10. CONDUCTED OUTPUT POWER.....</b>                           | <b>23</b> |
| 10.1. MEASUREMENT PROCEDURE .....                                | 23        |
| 10.2. TEST SET-UP (BLOCK DIAGRAM OF CONFIGURATION).....          | 23        |
| 10.3. LIMITS AND MEASUREMENT RESULT.....                         | 24        |
| <b>11. MAXIMUM CONDUCTED OUTPUT POWER SPECTRAL DENSITY .....</b> | <b>25</b> |
| 11.1. MEASUREMENT PROCEDURE .....                                | 25        |
| 11.2. TEST SET-UP (BLOCK DIAGRAM OF CONFIGURATION).....          | 25        |
| 11.3. LIMITS AND MEASUREMENT RESULT.....                         | 26        |



|   |           |
|---|-----------|
| <b>12. CONDUCTED SPURIOUS EMISSION.....</b>             | <b>27</b> |
| 12.1. MEASUREMENT PROCEDURE .....                       | 27        |
| 12.2. TEST SET-UP (BLOCK DIAGRAM OF CONFIGURATION)..... | 28        |
| 12.3. MEASUREMENT EQUIPMENT USED .....                  | 28        |
| 12.4. LIMITS AND MEASUREMENT RESULT.....                | 28        |
| <b>13. APPENDIX A: PHOTOGRAPHS OF TEST SETUP .....</b>  | <b>31</b> |



## 1. GENERAL INFORMATION

### 1.1. PRODUCT DESCRIPTION

The EUT is designed as "CAMERA". It is designed by way of utilizing the GFSK technology to achieve the system operation.

A major technical description of EUT is described as following:

|                     |  |
|---------------------|--|
| Operation Frequency | 2.402 GHz to 2.480GHz                                |
| Bluetooth Version   | V4.1(BLE)  |
| Modulation          | GFSK   |
| Number of channels  | 40 Channel(37 Hopping Channel,3 advertising Channel) |
| Antenna Designation | PCB Antenna  |
| Antenna Gain        | 0.5dBi   |
| Hardware Version    | 1439.02  |
| Software Version    | V232   |
| Power Supply        | DC 9~36V   |
| Test Power Supply   | DC 12V   |

### 1.2. RELATED SUBMITTAL(S)/GRANT(S)

This submittal(s) (test report) is intended for **FCC ID: 2AM6L-C6D** filing to comply with Section 15.247of the FCC Part 15, Subpart C Rules.

### 1.3. TEST METHODOLOGY

All measurements contained in this report were conducted with KDB 558074, American National Standard for Methods of Measurement of Radio-Noise Emissions from Low-Voltage Electrical and Electronic Equipment in the range of 9 kHz to 40 GHz.

The equipment under test (EUT) was configured to measure its highest possible emission level. The test modes were adapted accordingly in reference to the Operating Instructions. The EUT was tested in all three orthogonal planes and the worse case was showed.

**1.4. TEST FACILITY**

|                            |   |
|----------------------------|---|
| <b>Test Firm</b>           | Shenzhen HUAK Testing Technology Co., Ltd.  |
| <b>Address</b>             | 1F, B2 Building, Junfeng Zhongcheng Zhizao Innovation Park, Fuhai Street, Bao'an District, Shenzhen City, China |
| <b>Designation Number</b>  | CN1229  |
| <b>Registration Number</b> | 616276  |

**1.5. SPECIAL ACCESSORIES**

Refer to section 1.2.

**1.6. EQUIPMENT MODIFICATIONS**

Not available for this EUT intended for grant.



## 2. MEASUREMENT UNCERTAINTY

| Test                                    | Measurement Uncertainty | Notes |
|---|-------------------------|-------|
| Transmitter power conducted             | $\pm 0.57$ dB           | (1)   |
| Transmitter power Radiated              | $\pm 2.20$ dB           | (1)   |
| Conducted spurious emission 9KHz-40 GHz | $\pm 2.20$ dB           | (1)   |
| Occupied Bandwidth                      | $\pm 0.01$ ppm          | (1)   |
| Radiated Emission 30~1000MHz            | $\pm 4.10$ dB           | (1)   |
| Radiated Emission Above 1GHz            | $\pm 4.32$ dB           | (1)   |
| Conducted Disturbance 0.15~30MHz        | $\pm 3.20$ dB           | (1)   |

(1) This uncertainty represents an expanded uncertainty expressed at approximately the 95% confidence level using a coverage factor of  $k=2$ .





### 3. SYSTEM TEST CONFIGURATION

#### 3.1. CONFIGURATION OF TESTED SYSTEM

Configuration:

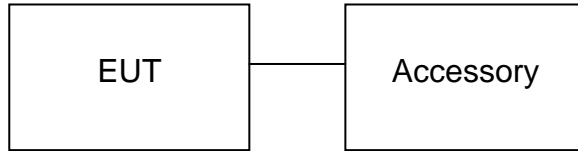

#### 3.2. EQUIPMENT USED IN TESTED SYSTEM

| Item | Equipment | Model No. | ID or Specification | Remark    |
|------|-----------|-----------|---------------------|-----------|
| 1    | CAMERA    | C6D       | 2AM6L-C6D           | EUT       |
| 2    | Antenna   | N/A       | N/A                 | Accessory |

**ALL TEST EQUIPMENT LIST**

| <b>Equipment</b>          | <b>Manufacturer</b> | <b>Model</b>    | <b>S/N</b> | <b>Cal. Due</b> |
|---------------------------|---------------------|-----------------|------------|-----------------|
| Receiver                  | R&S                 | ESCI 7          | HKE-010    | Dec. 28, 2018   |
| LISN                      | R&S                 | ENV216          | HKE-002    | Dec. 28, 2018   |
| Conducted test software   | Tonscend            | TS+ Rev 2.5.0.0 | HKE-081    | N/A             |
| Power meter               | Agilent             | E4417B          | HKE-107    | Dec. 28, 2018   |
| Power Sensor              | Agilent             | E9327A          | HKE-113    | Dec. 28, 2018   |
| RF cable                  | Times               | 1-40G           | HKE-034    | Dec. 28, 2018   |
| RF automatic control unit | Tonscend            | JS0806-2        | HKE-060    | Dec. 28, 2018   |
| Spectrum analyzer         | Agilent             | N9020A          | HKE-048    | Dec. 28, 2018   |
| RF Cable (9KHz-26.5GHz)   | Tonscend            | 170660          | N/A        | Dec. 28, 2018   |
| Signal generator          | Agilent             | N5183A          | HKE-071    | Dec. 28, 2018   |
| Receiver                  | R&S                 | ESCI-7          | HKE-010    | Dec. 28, 2018   |
| Preamplifier              | EMCI                | EMC051845SE     | HKE-015    | Dec. 28, 2018   |
| Preamplifier              | Agilent             | 83051A          | HKE-016    | Dec. 28, 2018   |
| Loop antenna              | Schwarzbeck         | FMZB 1519 B     | HKE-014    | Dec. 28, 2018   |
| Broadband antenna         | Schwarzbeck         | VULB 9163       | HKE-012    | Dec. 28, 2018   |
| Horn antenna              | Schwarzbeck         | 9120D           | HKE-013    | Dec. 28, 2018   |
| Antenna Mast              | Keleto              | CC-A-4M         | N/A        | N/A             |
| Position controller       | Taiwan MF           | MF7802          | HKE-011    | Dec. 28, 2018   |
| RF cable (9KHz-1GHz)      | Times               | 381806-001      | N/A        | N/A             |



#### 4. SUMMARY OF TEST RESULTS

| <b>FCC RULES</b>      | <b>DESCRIPTION OF TEST</b>                         | <b>RESULT</b> |
|-----------------------|--|---------------|
| §15.203               | Antenna Requirement                                | Compliant     |
| §15.209<br>§15.247(d) | Radiated Emission                                  | Compliant     |
| §15.247(d)            | Band Edges   | Compliant     |
| §15.247               | 6 dB Bandwidth                                     | Compliant     |
| §15.247(b)            | Conducted Power                                    | Compliant     |
| §15.247(e)            | Maximum Conducted Output Power SPECTRAL<br>Density | Compliant     |
| §15.207               | Line Conduction Emission                           | Compliant     |
| §15.207               | Conduction Emission                                | Compliant     |



## 5. DESCRIPTION OF TEST MODES

The EUT has been operated in three modulations: GFSK independently.

| NO. | TEST MODE DESCRIPTION |
|-----|-----------------------|
| 1   | Low channel TX        |
| 2   | Middle channel TX     |
| 3   | High channel TX       |
| 4   | Normal Operating (BT) |

**Note:**

1. All the test modes can be supply by Built-in Li-ion battery, only the result of the worst case was recorded in the report if no any records.
2. For Radiated Emission, 3axis were chosen for testing for each applicable mode.
3. EUT is operating at its maximum duty cycle>or equal 98%



## 6. RADIATED EMISSION

### 6.1. MEASUREMENT PROCEDURE

1. The EUT was placed on the top of the turntable 0.8 or 1.5 meter above ground. The phase center of the receiving antenna mounted on the top of a height-variable antenna tower was placed 3 meters far away from the turntable.
2. Power on the EUT and all the supporting units. The turntable was rotated by 360 degrees to determine the position of the highest radiation.
3. The height of the broadband receiving antenna was varied between one meter and four meters above ground to find the maximum emissions field strength of both horizontal and vertical polarization.
4. For each suspected emissions, the antenna tower was scan (from 1 M to 4 M) and then the turntable was rotated (from 0 degree to 360 degrees) to find the maximum reading.
5. Set the test-receiver system to Peak or CISPR quasi-peak Detect Function with specified bandwidth under Maximum Hold Mode.
6. For emissions above 1GHz, use 1MHz VBW and RBW for peak reading. Then 1MHz RBW and 10Hz VBW for average reading in spectrum analyzer. Place the measurement antenna away from each area of the EUT determined to be a source of emissions at the specified measurement distance, while keeping the measurement antenna aimed at the source of emissions at each frequency of significant emissions, with polarization oriented for maximum response. The measurement antenna may have to be higher or lower than the EUT, depending on the radiation pattern of the emission and staying aimed at the emission source for receiving the maximum signal. The final measurement antenna elevation shall be that which maximizes the emissions. The measurement antenna elevation for maximum emissions shall be restricted to a range of heights of from 1 m to 4 m above the ground or reference ground plane.
7. When the radiated emissions limits are expressed in terms of the average value of the emissions, and pulsed operation is employed, the measurement field strength shall be determined by averaging over one complete pulse train, including blanking intervals, as long as the pulse train does not exceed 0.1 seconds. As an alternative (provided the transmitter operates for longer than 0.1 seconds) or in cases where the pulse train exceeds 0.1 seconds, the measured field strength shall be determined from the average absolute voltage during a 0.1 second interval during which the field strength is at its maximum values.
8. If the emissions level of the EUT in peak mode was 3 dB lower than the average limit specified, then testing will be stopped and peak values of EUT will be reported, otherwise, the emissions which do not have 3 dB margin will be repeated one by one using the quasi-peak method for below 1GHz.
9. For testing above 1GHz, the emissions level of the EUT in peak mode was lower than average limit (that means the emissions level in peak mode also complies with the limit in average mode), then testing will be stopped and peak values of EUT will be reported, otherwise, the emissions will be measured in average mode again and reported.
10. In case the emission is lower than 30MHz, loop antenna has to be used for measurement and the recorded data should be QP measured by receiver. High - Low scan is not required in this case.

## 6.2. TEST SETUP

### Radiated Emission Test-Setup Frequency Below 30MHz

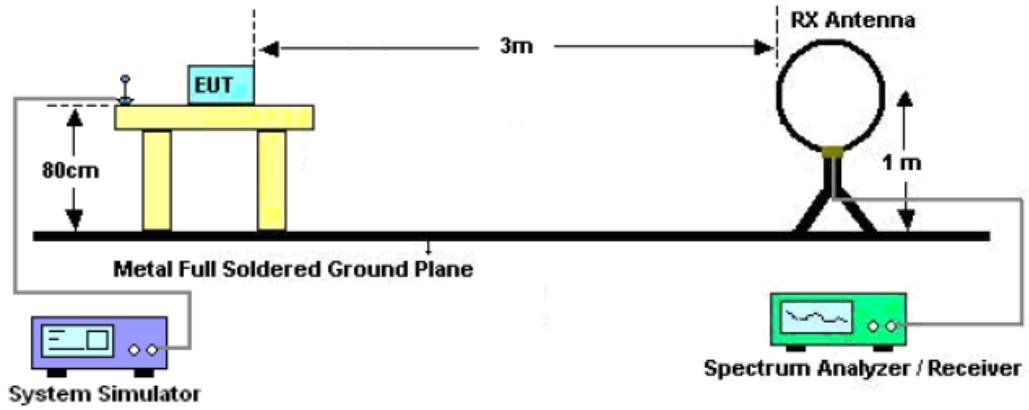

### RADIATED EMISSION TEST SETUP 30MHz-1000MHz

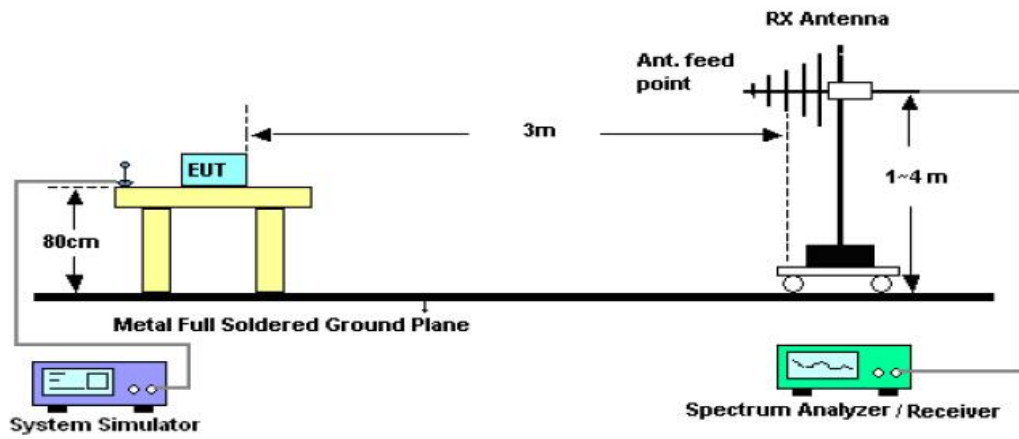

### RADIATED EMISSION TEST SETUP ABOVE 1000MHz

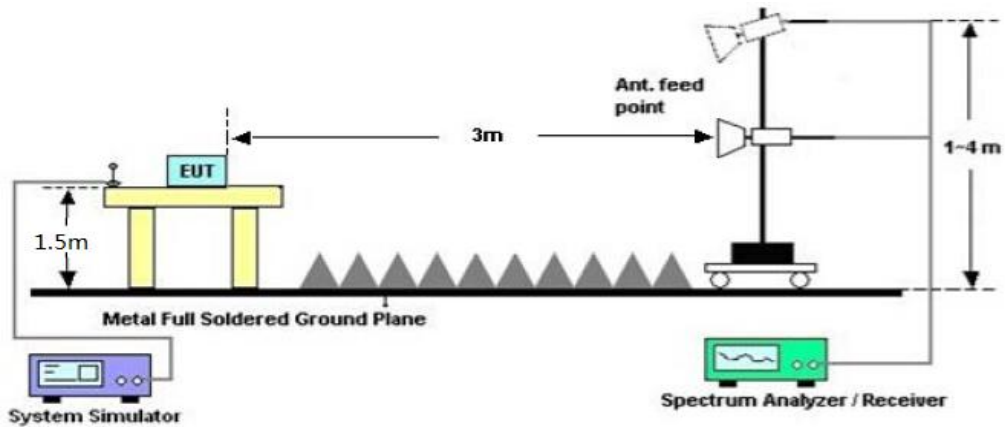



### 6.3. LIMITS AND MEASUREMENT RESULT

15.209 Limit in the below table has to be followed

| <b>Frequencies<br/>(MHz)</b> | <b>Field Strength<br/>(micorvolts/meter)</b> | <b>Measurement Distance<br/>(meters)</b> |
|------------------------------|--|--|
| 0.009~0.490                  | 2400/F(KHz)                                  | 300                                      |
| 0.490~1.705                  | 24000/F(KHz)                                 | 30                                       |
| 1.705~30.0                   | 30   | 30                                       |
| 30~88                        | 100  | 3  |
| 88~216                       | 150  | 3  |
| 216~960                      | 200  | 3  |
| Above 960                    | 500  | 3  |

Note: All modes were tested For restricted band radiated emission,  
the test records reported below are the worst result compared to other modes.



6.4. TEST RESULT

**RADIATED EMISSION BELOW 30MHZ**

No emission found between lowest internal used/generated frequencies to 30MHz.

**RADIATED EMISSION BELOW 1GHZ**

**RADIATED EMISSION TEST- (30MHZ-1GHZ) -HORIZONTAL**

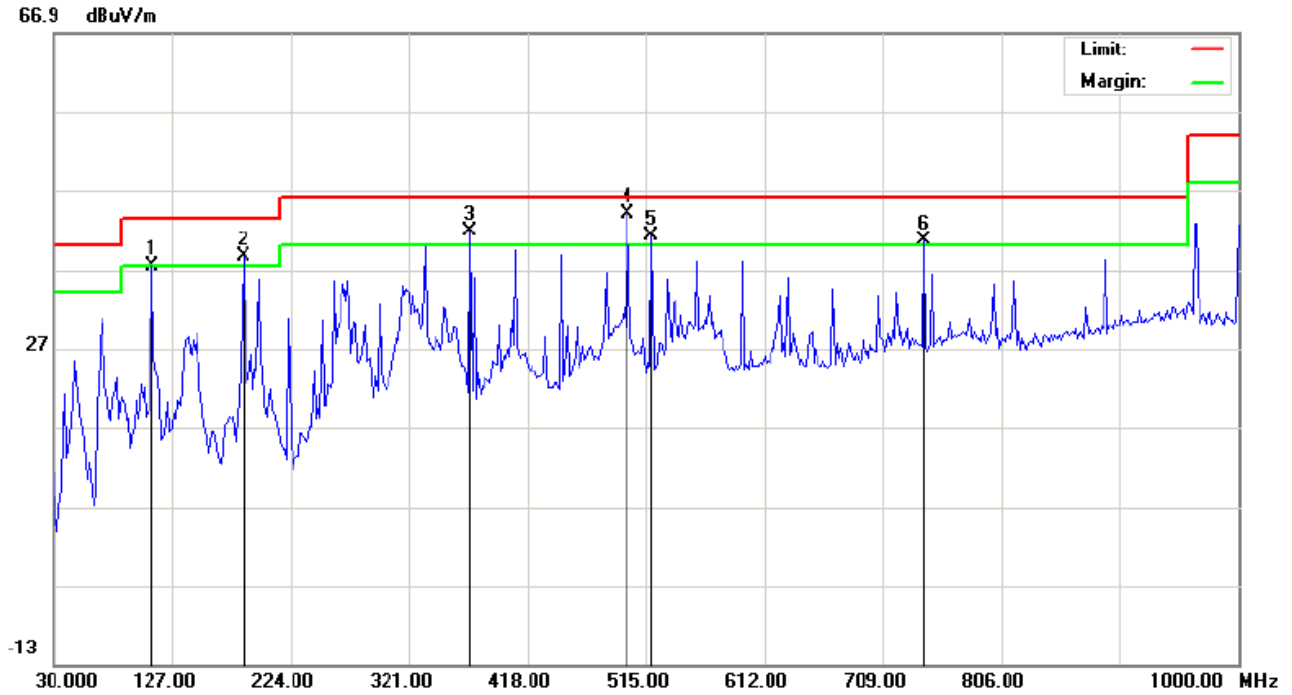

| No. | Mk | Freq.    | Reading | Factor | Measurement | Limit  | Over  | Detector | Antenna Height | Table Degree | Comment |
|-----|----|----------|---------|--------|-------------|--------|-------|----------|----------------|--------------|---------|
|     |    | MHz      | dBuV    | dB/m   | dBuV/m      | dBuV/m | dB    |          | cm             | degree       |         |
| 1   |    | 110.8333 | 29.40   | 7.98   | 37.38       | 43.50  | -6.12 | peak     |                |              |         |
| 2   | !  | 185.2000 | 27.35   | 11.31  | 38.66       | 43.50  | -4.84 | peak     |                |              |         |
| 3   | !  | 371.1167 | 22.89   | 18.88  | 41.77       | 46.00  | -4.23 | peak     |                |              |         |
| 4   | *  | 500.4500 | 22.90   | 21.14  | 44.04       | 46.00  | -1.96 | peak     |                |              |         |
| 5   | !  | 519.8500 | 19.47   | 21.67  | 41.14       | 46.00  | -4.86 | peak     |                |              |         |
| 6   | !  | 742.9500 | 14.20   | 26.43  | 40.63       | 46.00  | -5.37 | peak     |                |              |         |

**RESULT: PASS**





### RADIATED EMISSION TEST- (30MHZ-1GHZ) -VERTICAL

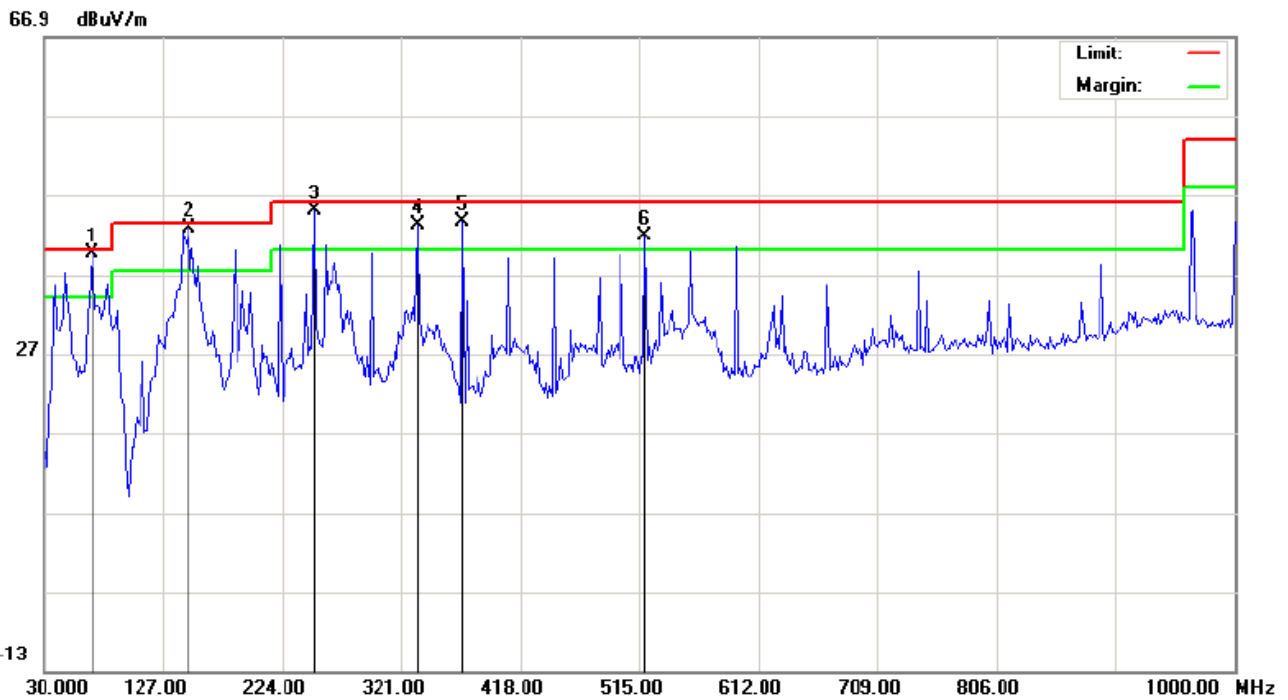

| No. | Mk | Freq.    | Reading | Factor | Measurement | Limit  | Over  | Detector | Antenna Height | Table Degree | Comment |
|-----|----|----------|---------|--------|-------------|--------|-------|----------|----------------|--------------|---------|
|     |    | MHz      | dBuV    | dB/m   | dBuV/m      | dBuV/m | dB    |          | cm             | degree       |         |
| 1   | *  | 68.8000  | 34.88   | 4.73   | 39.61       | 40.00  | -0.39 | peak     |                |              |         |
| 2   | !  | 148.0167 | 27.62   | 15.25  | 42.87       | 43.50  | -0.63 | peak     |                |              |         |
| 3   | !  | 249.8667 | 31.14   | 13.89  | 45.03       | 46.00  | -0.97 | peak     |                |              |         |
| 4   | !  | 333.9333 | 25.53   | 17.67  | 43.20       | 46.00  | -2.80 | peak     |                |              |         |
| 5   | !  | 371.1167 | 24.76   | 18.88  | 43.64       | 46.00  | -2.36 | peak     |                |              |         |
| 6   | !  | 519.8500 | 20.19   | 21.67  | 41.86       | 46.00  | -4.14 | peak     |                |              |         |

**RESULT: PASS**

**Note:** 1. Factor=Antenna Factor + Cable loss, Margin=Measurement-Limit.

2. The “Factor” value can be calculated automatically by software of measurement system.

3. All test modes for different EUT are pre-tested. The low channel for GFSK mode is the worst case and recorded in the report.

**RADIATED EMISSION ABOVE 1GHZ**

| Frequency<br>(MHz)      | Emission Level<br>(dB $\mu$ V/m) | Limits<br>(dB $\mu$ V/m) | Margin<br>(dB) | Detector<br>Type | Comment    |
|-------------------------|----------------------------------|--------------------------|----------------|------------------|------------|
| Low Channel (2402 MHz)  |                                  |                          |                |                  |            |
| 4804                    | 51.6                             | 74                       | -22.4          | Pk               | Vertical   |
| 4804                    | 39.05                            | 54                       | -14.95         | AV               | Vertical   |
| 4804                    | 51.56                            | 74                       | -22.44         | Pk               | Horizontal |
| 4804                    | 38.54                            | 54                       | -15.46         | AV               | Horizontal |
| Mid Channel (2440 MHz)  |                                  |                          |                |                  |            |
| 4880                    | 51.8                             | 74                       | -22.2          | Pk               | Vertical   |
| 4880                    | 39.22                            | 54                       | -14.78         | AV               | Vertical   |
| 4880                    | 51.75                            | 74                       | -22.25         | Pk               | Horizontal |
| 4880                    | 38.73                            | 54                       | -15.27         | AV               | Horizontal |
| High Channel (2480 MHz) |                                  |                          |                |                  |            |
| 4960                    | 51.95                            | 74                       | -22.05         | pk               | Vertical   |
| 4960                    | 39.42                            | 54                       | -14.58         | AV               | Vertical   |
| 4960                    | 51.93                            | 74                       | -22.07         | pk               | Horizontal |
| 4960                    | 38.92                            | 54                       | -15.08         | AV               | Horizontal |

**RESULT: PASS**

**Note:** 1~25GHz scan with GFSK. No recording in the test report at least have 20dB margin.

Factor = Antenna Factor + Cable Loss – Pre-amplifier.

Emission Level = Meter Reading + Factor

Margin = Emission - Level Limit



## 7. BAND EDGE EMISSION

### 7.1. MEASUREMENT PROCEDURE

#### 1) Radiated restricted band edge measurements

The radiated restricted band edge measurements are measured with an EMI test receiver connected to the receive antenna while the EUT is transmitting

#### 2) Conducted Emissions at the band edge

a) The transmitter output was connected to the spectrum analyzer

b) Set RBW=100kHz, VBW=300kHz

c) Suitable frequency span including 100kHz bandwidth from band edge

### 7.2. TEST SET-UP

Radiated same as 6.2

Conducted set up

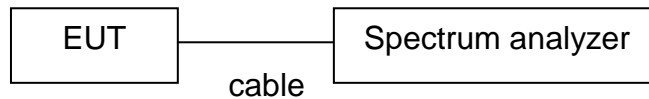

**7.3. RADIATED TEST RESULT**

| Frequency | Emission Level | Limits         | Margin | Detector | Comment    |
|-----------|----------------|----------------|--------|----------|------------|
| (MHz)     | (dB $\mu$ V/m) | (dB $\mu$ V/m) | (dB)   | Type     |            |
| GFSK      |                |                |        |          |            |
| 2399.9    | 52.43          | 74             | -21.57 | peak     | Vertical   |
| 2399.9    | 39.42          | 54             | -14.58 | AVG      | Vertical   |
| 2399.9    | 52.83          | 74             | -21.17 | peak     | Horizontal |
| 2399.9    | 39.27          | 54             | -14.73 | AVG      | Horizontal |
| 2483.6    | 52.34          | 74             | -21.66 | peak     | Vertical   |
| 2483.6    | 39.35          | 54             | -14.65 | AVG      | Vertical   |
| 2483.6    | 53.43          | 74             | -20.57 | peak     | Horizontal |
| 2483.6    | 39.78          | 54             | -14.22 | AVG      | Horizontal |

**RESULT: PASS**

**Note:** Factor=Antenna Factor + Cable loss - Amplifier gain,

Emission Level = Meter Reading + Factor

Margin= Emission Level -Limit.

The "Factor" value can be calculated automatically by software of measurement system.



### 8. CONDUCTED TEST RESULT

#### Test Graph

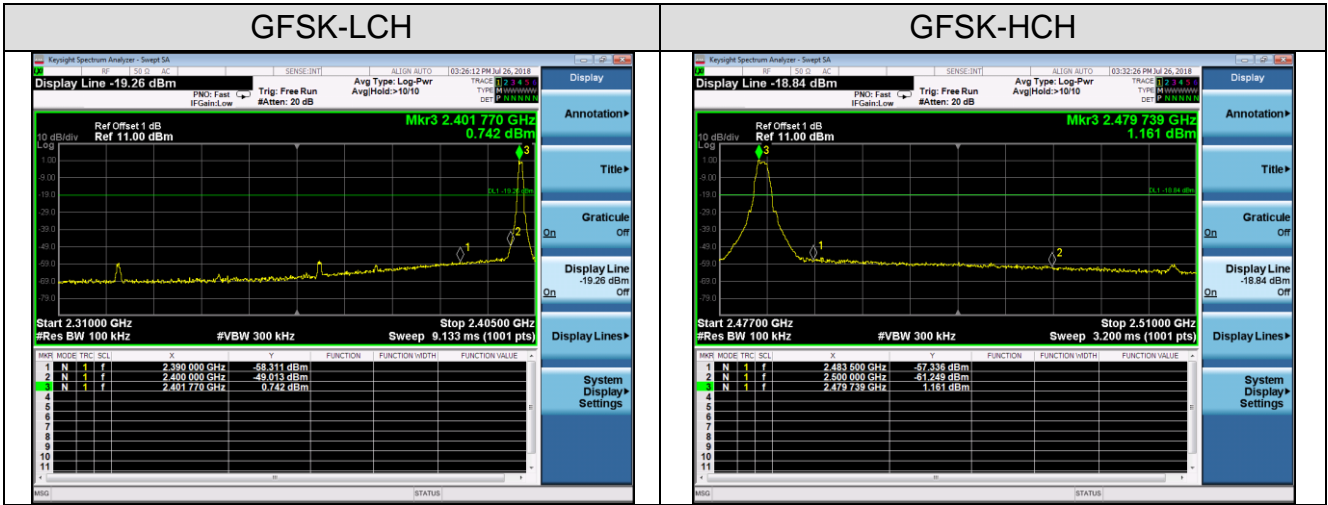



## 9. 6DB BANDWIDTH

### 9.1. TEST PROCEDURE

1. Connect EUT RF output port to the Spectrum Analyzer through an RF attenuator
2. Set the EUT Work on the top, the middle and the bottom operation frequency individually.
3. Set SPA Centre Frequency = Operation Frequency, RBW= 100 KHz, VBW=RBW.
4. Set SPA Trace 1 Max hold, then View.

### 9.2. SUMMARY OF TEST RESULTS/PLOTS

| Mode | Channel | 6dB Bandwidth [KHz] | Verdict |
|------|---------|---------------------|---------|
| BLE  | LCH     | 707.0               | PASS    |
| BLE  | MCH     | 704.0               | PASS    |
| BLE  | HCH     | 706.8               | PASS    |

### Test Graph

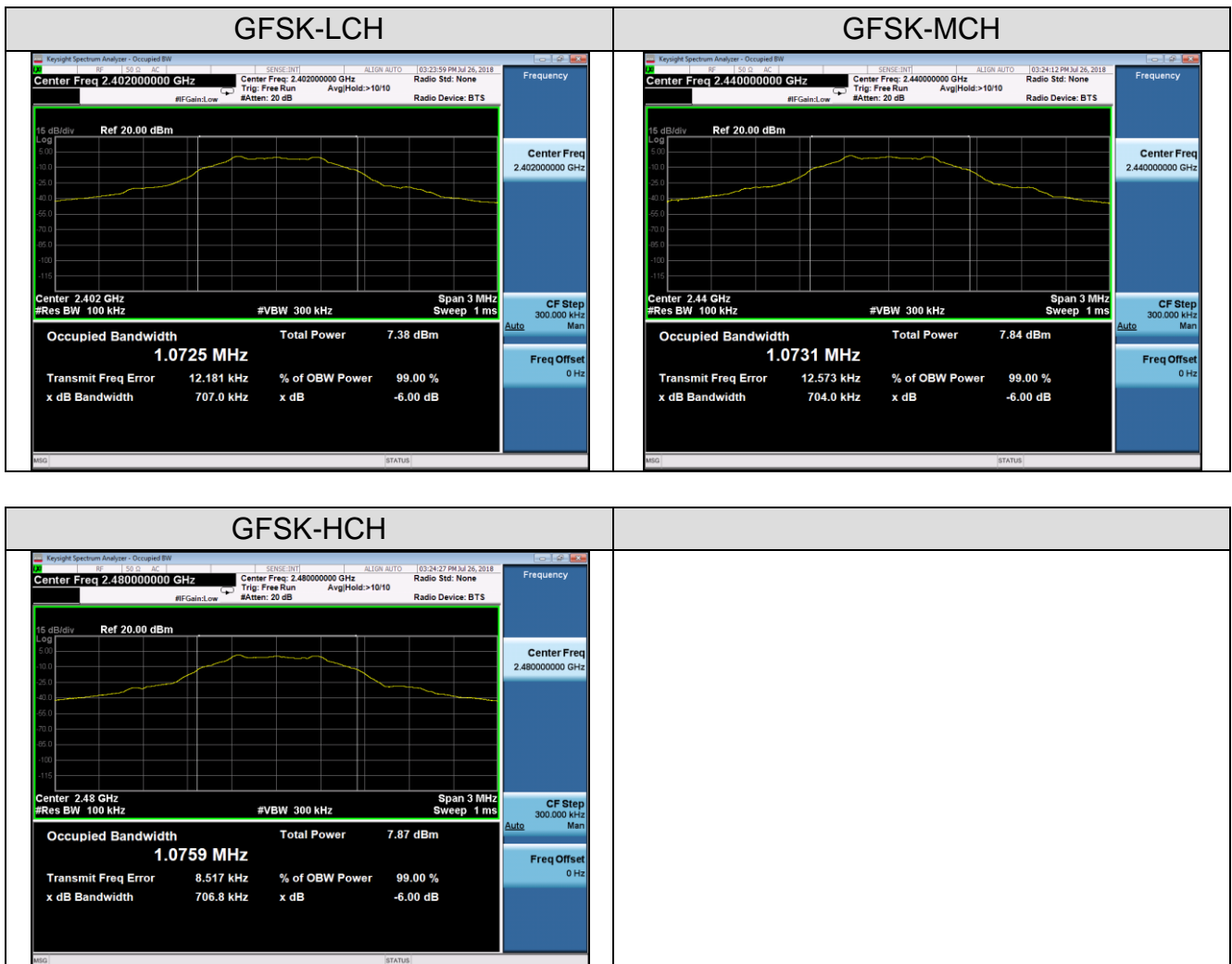



## 10. CONDUCTED OUTPUT POWER

### 10.1. MEASUREMENT PROCEDURE

1. Connect EUT RF output port to the Spectrum Analyzer through an RF attenuator
2. Set the EUT Work on the top, middle and the bottom operation frequency individually.
3. Use the following spectrum analyzer settings:
  - Set the RBW  $\geq$  DTS bandwidth
  - Set the VBW  $\geq 3 \times$  RBW
  - Set the span  $\geq 3 \times$  RBW
  - Detector = peak
  - Sweep time = auto couple
  - Trace mode = max hold
4. Allow the trace to stabilize. Use peak marker function to determine the peak amplitude level
5. Record the result form the Spectrum Analyzer.

**Note:** The EUT was tested according to KDB 558074 for compliance to FCC 47CFR 15.247 requirements.

### 10.2. TEST SET-UP (BLOCK DIAGRAM OF CONFIGURATION)

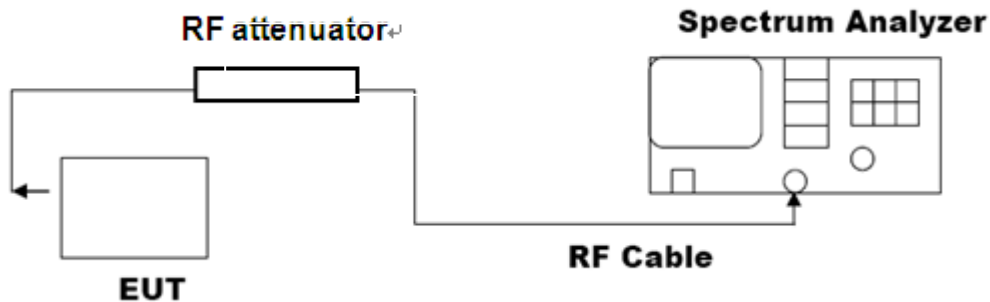



### 10.3. LIMITS AND MEASUREMENT RESULT

| Channel        | Peak Power (dBm) | Applicable Limits (dBm) | Pass/Fail |
|----------------|------------------|-------------------------|-----------|
| Low Channel    | 1.661            | 30                      | Pass      |
| Middle Channel | 2.210            | 30                      | Pass      |
| High Channel   | 2.276            | 30                      | Pass      |

### Test Graph

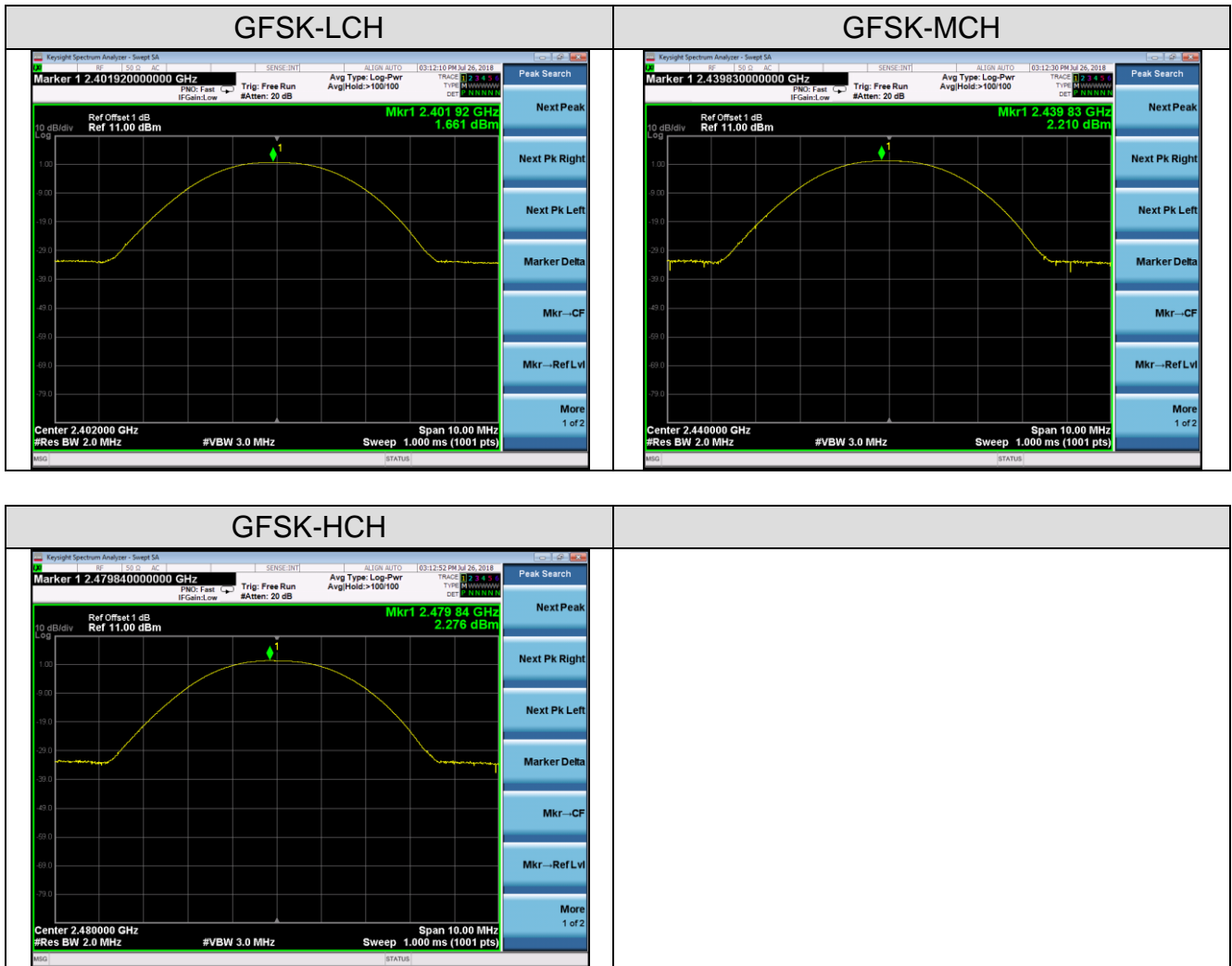





## 11. MAXIMUM CONDUCTED OUTPUT POWER SPECTRAL DENSITY

### 11.1. MEASUREMENT PROCEDURE

(1). Connect EUT RF output port to the Spectrum Analyzer through an RF attenuator  
(2). Set the EUT Work on the top, the middle and the bottom operation frequency individually.

(3). Set SPA Trace 1 Max hold, then View.

**Note:** The EUT was tested according to KDB 558074 for compliance to FCC 47CFR 15.247 requirements.

### 11.2. TEST SET-UP (BLOCK DIAGRAM OF CONFIGURATION)

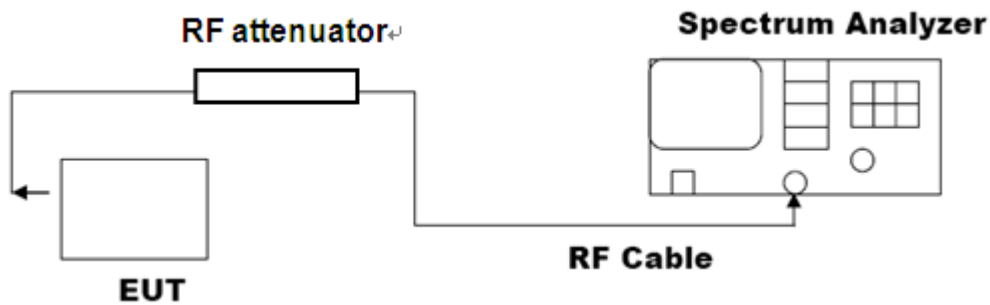



### 11.3. LIMITS AND MEASUREMENT RESULT

| Mode | Channel | PSD [dBm/3kHz] | Limit[dBm/3kHz] | Verdict |
|------|---------|----------------|-----------------|---------|
| BLE  | LCH     | -14.885        | 8               | PASS    |
| BLE  | MCH     | -13.584        | 8               | PASS    |
| BLE  | HCH     | -14.614        | 8               | PASS    |

### Test Graph

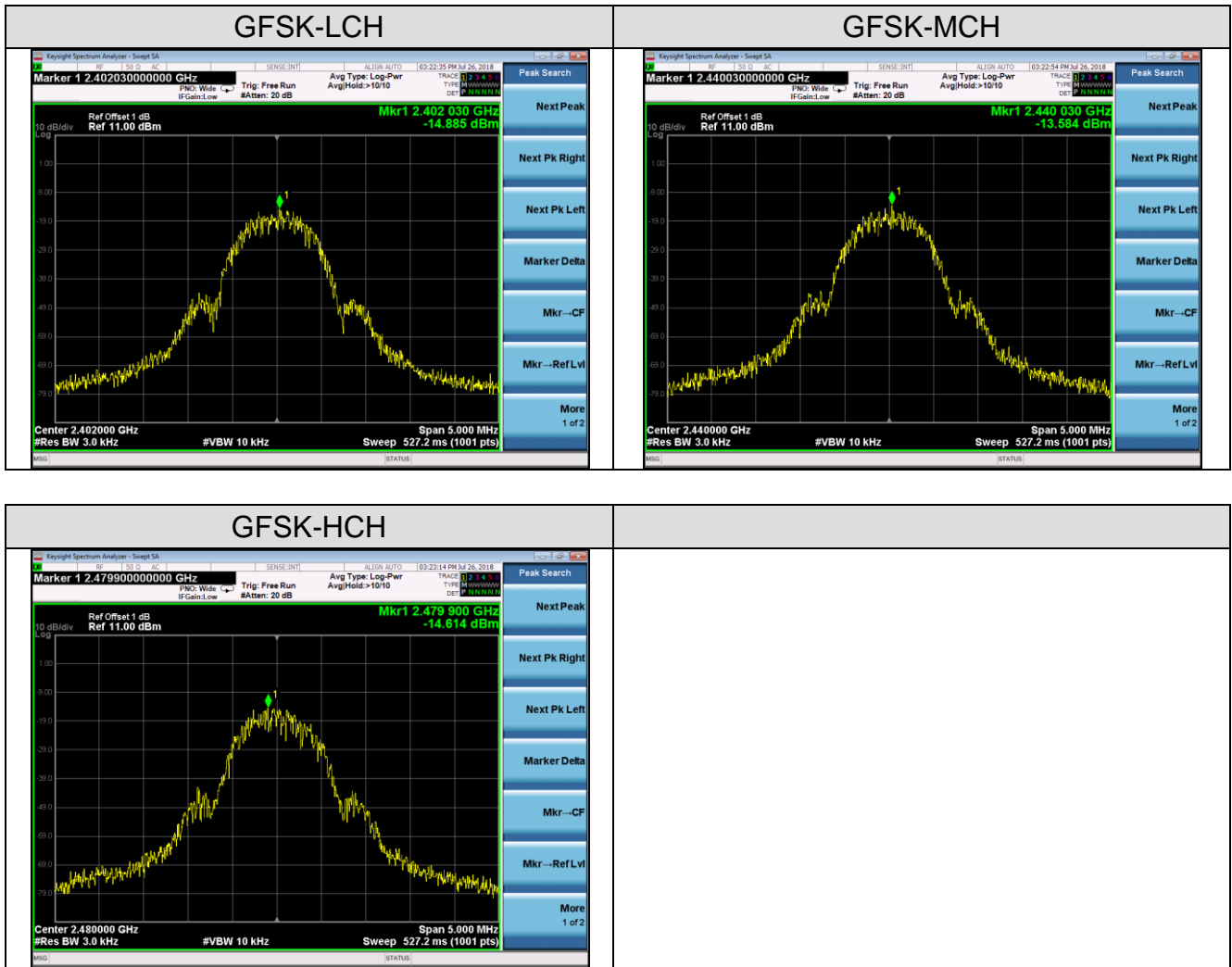



## 12. CONDUCTED SPURIOUS EMISSION

### 12.1. MEASUREMENT PROCEDURE

1. Connect EUT RF output port to the Spectrum Analyzer through an RF attenuator
2. Set the EUT Work on the top, the Middle and the bottom operation frequency individually.
3. Set the Span = wide enough to capture the peak level of the in-band emission and all spurious emissions from the lowest frequency generated in the EUT up through the 10th harmonic.  
RBW = 100 kHz; VBW  $\geq$  RBW; Sweep = auto; Detector function = peak.
4. Set SPA Trace 1 Max hold, then View.

**Note:** The EUT was tested according to DA000705 for compliance to FCC 47CFR 15.247 requirements. Owing to satisfy the requirements of the number of measurement points, we set the RBW=1MHz, VBW  $>$  RBW, scan up through 10th harmonic, and consider the tested results as the worst case, if the tested results conform to the requirement, we can deem that the real tested results(set the RBW=100KHz, VBW  $>$  RBW) are conform to the requirement.



**12.2. TEST SET-UP (BLOCK DIAGRAM OF CONFIGURATION)**

The same as described in section 8.2

**12.3. MEASUREMENT EQUIPMENT USED**

The same as described in section 6

**12.4. LIMITS AND MEASUREMENT RESULT**

| <b>LIMITS AND MEASUREMENT RESULT</b>   |  |                 |
|--|--|-----------------|
| <b>Applicable Limits</b>   | <b>Measurement Result</b>                                      |                 |
|  | <b>Test Data</b>   | <b>Criteria</b> |
| In any 100 KHz Bandwidth Outside the frequency band in which the spread spectrum intentional radiator is operating, the radio frequency power that is produce by the intentional radiator shall be at least 20 dB below that in 100KHz bandwidth within the band that contains the highest level of the desired power.<br>In addition, radiation emissions which fall in the restricted bands, as defined in §15.205(a), must also comply with the radiated emission limits specified in§15.209(a) | At least -20dBc than the limit Specified on the BOTTOM Channel | PASS            |
|  | At least -20dBc than the limit Specified on the TOP Channel    | PASS            |



### Test Graph

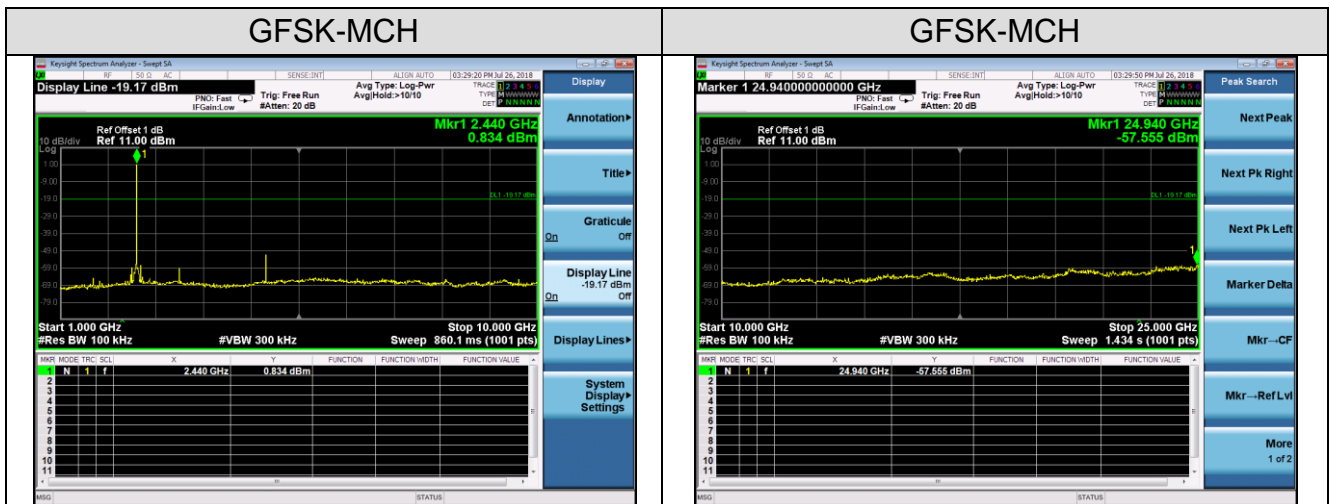
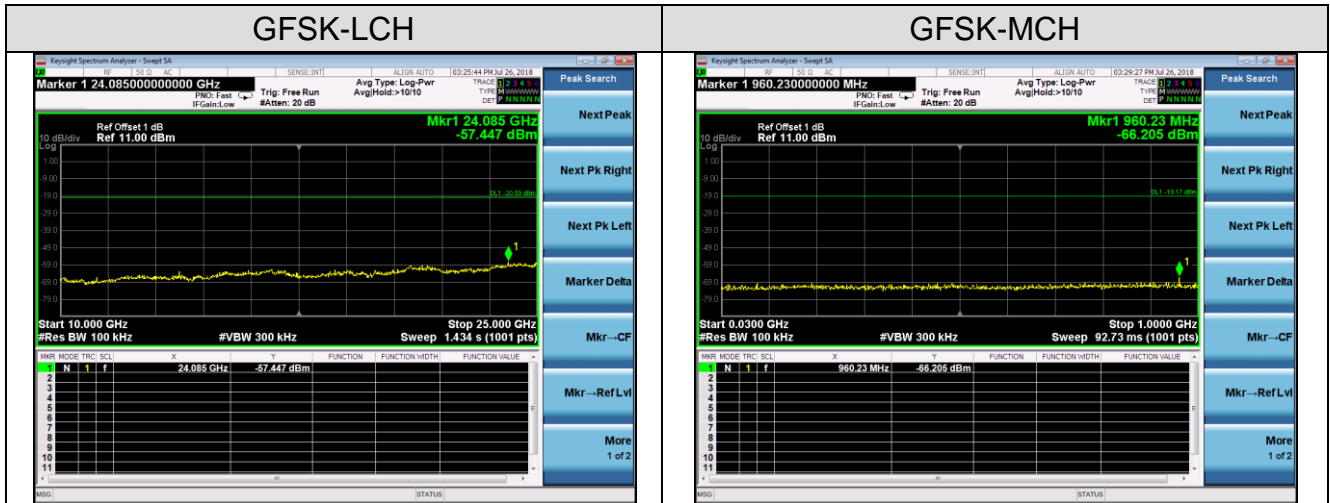
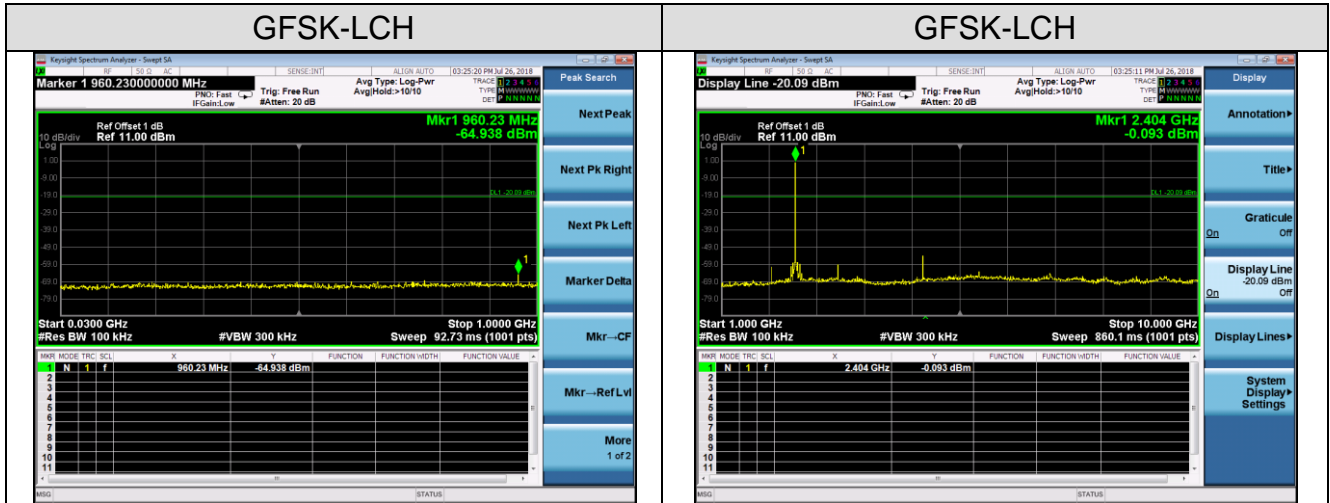

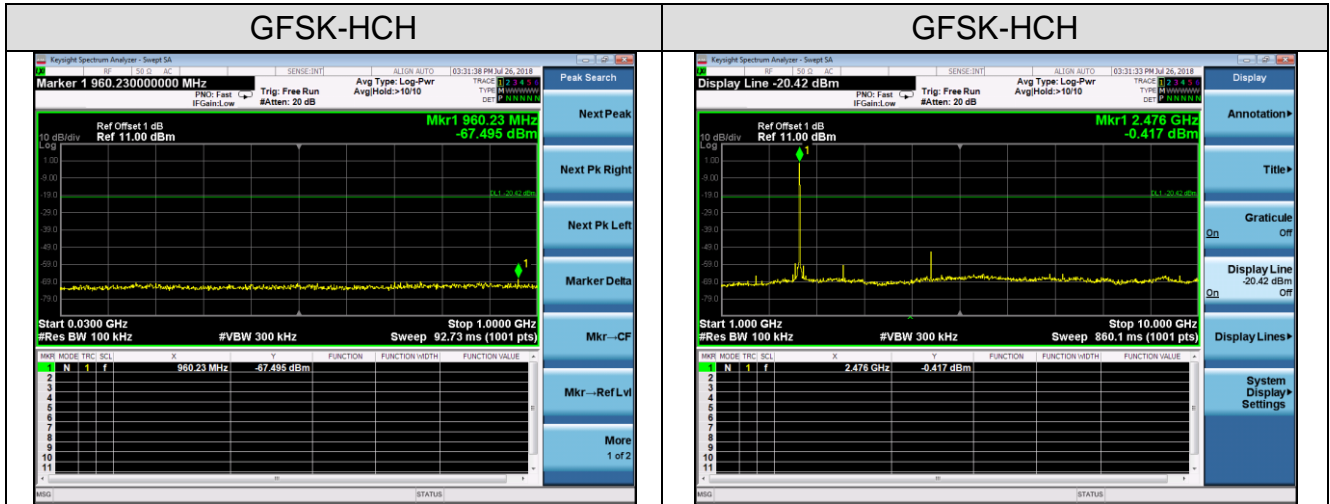

### 13. APPENDIX A: PHOTOGRAPHS OF TEST SETUP RADIATED EMISSION TEST SETUP

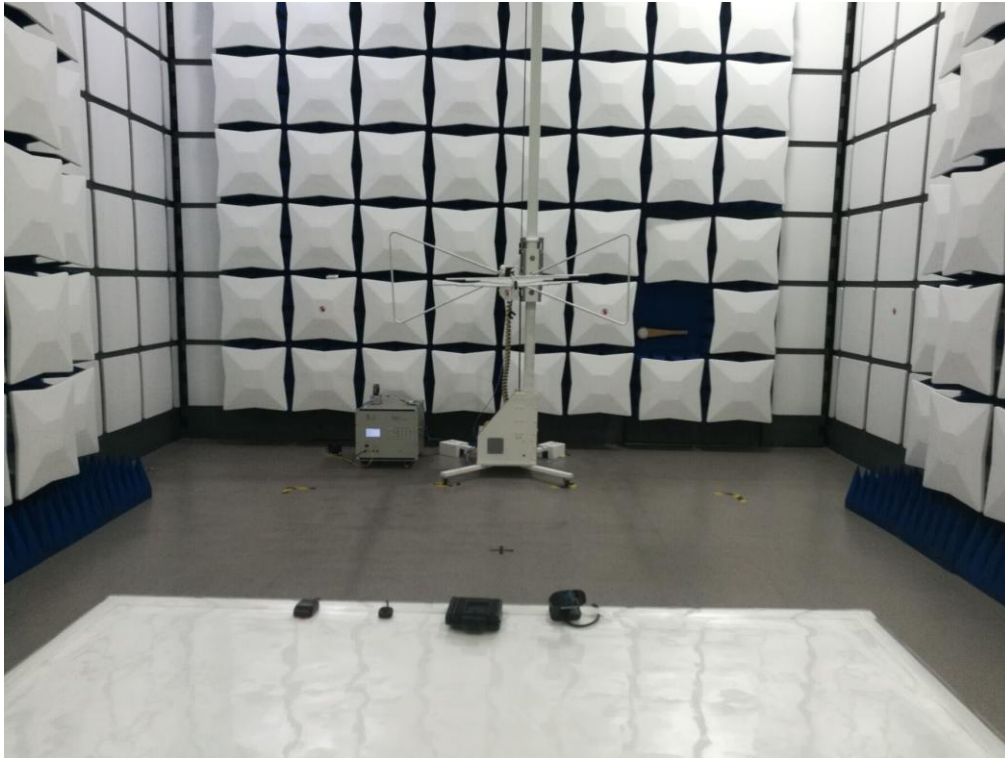

RADIATED EMISSION ABOVE 1G TEST SETUP



----END OF REPORT----