

RHA

Drawing title: RHA TrueControl Product Artwork - MP

Job title: RHA TrueControl Earbuds Artwork

Product: RHA TrueControl

Scale: 1:1

Revision: 10

Date: 26.10.2020

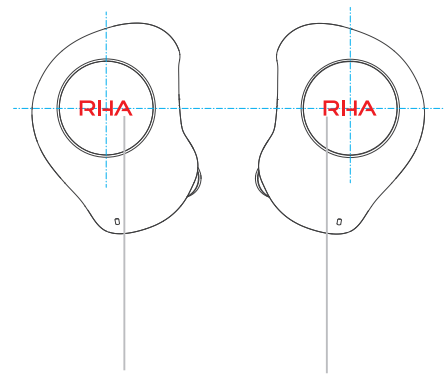

RHA Logo
Dimensions 2.0mm x 7.0mm
Colour Black
Finish High Gloss

* Appears on both R & L earbuds

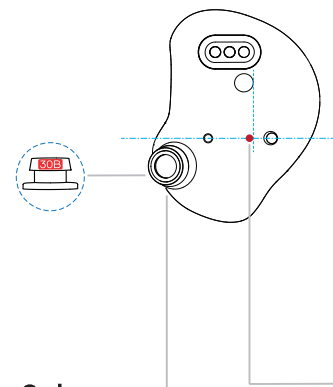

Production Code
Location Underside of nozzle
Process UV Etched/Laser Etched

* Appears on both R & L earbuds

Right Earbud Indicator
Dimensions 1.0mm diameter
Colour Pantone PQ-2035 C
Finish Matte

* Only appears on Right Earbud

RHA

Drawing title: RHA TrueControl Product Artwork - MP

Job title: RHA TrueControl Case Artwork

Product: RHA TrueControl

Scale: 1:1

Revision: 10

Date: 26.10.2020

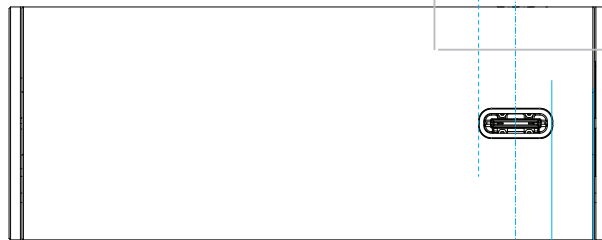
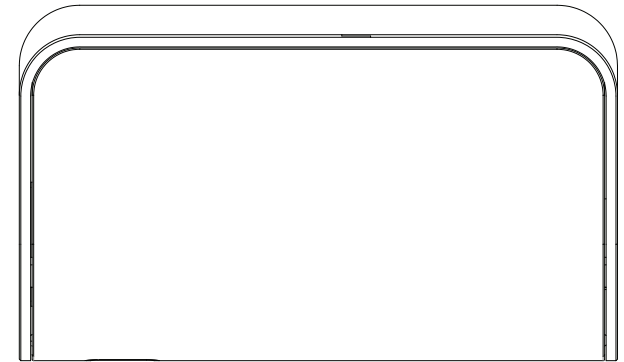
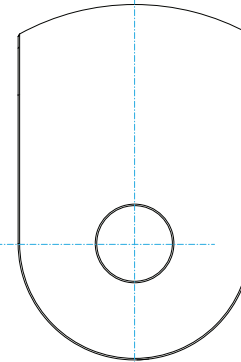
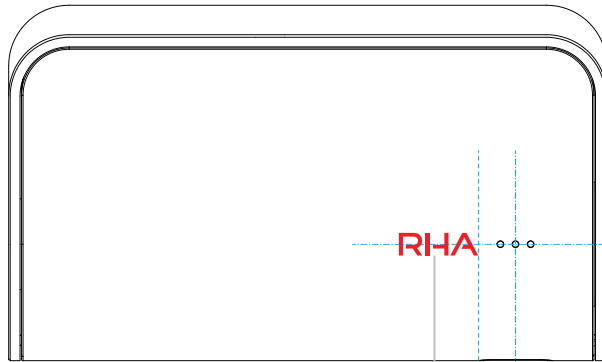
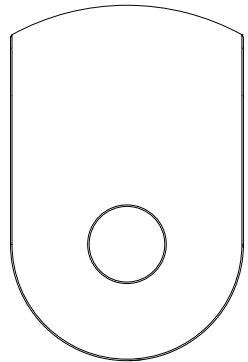
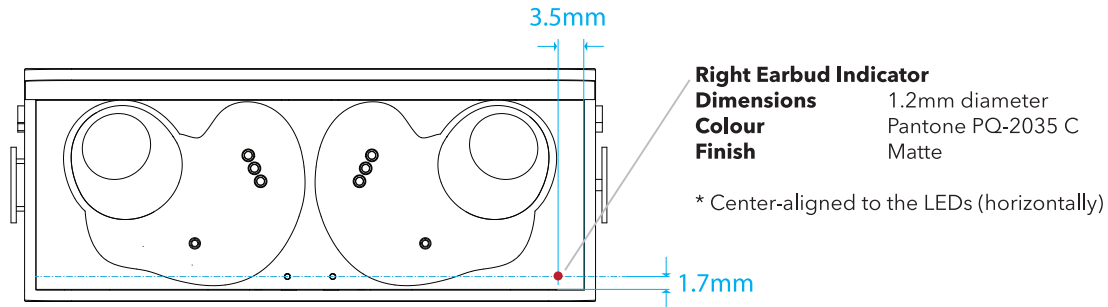

RHA Logo
Dimensions 3.0mm x 10.5mm
Colour Black
Finish High Gloss

* Right-aligned to the edge of USB ring

LEDs center-aligned to USB center

RHA

Drawing title: RHA TrueControl Product Artwork - MP

Job title: RHA TrueControl Lid Artwork

Product: RHA TrueControl

Scale: 1:1

Revision: 10

Date: 26.10.2020

