

## FCC Test Report (BT LE)

**Report No.:** RF200608D03-2

**FCC ID:** 2AM5A-TCTRLR

**Test Model:** TrueControl

**Received Date:** Jun. 8, 2020

**Test Date:** Jul. 27 to Nov. 3, 2020

**Issued Date:** Nov. 3, 2020

**Applicant:** RHA Technologies Limited

**Address:** 69 Haugh Road, Glasgow, G38TX, United Kingdom

**Issued By:** Bureau Veritas Consumer Products Services (H.K.) Ltd., Taoyuan Branch  
Lin Kou Laboratories

**Lab Address:** No. 47-2, 14th Ling, Chia Pau Vil., Lin Kou Dist., New Taipei City, Taiwan

**FCC Registration /  
Designation Number:** 198487 / TW2021



This report is for your exclusive use. Any copying or replication of this report to or for any other person or entity, or use of our name or trademark, is permitted only with our prior written permission. This report sets forth our findings solely with respect to the test samples identified herein. The results set forth in this report are not indicative or representative of the quality or characteristics of the lot from which a test sample was taken or any similar or identical product unless specifically and expressly noted. Our report includes all of the tests requested by you and the results thereof based upon the information that you provided to us. You have 60 days from date of issuance of this report to notify us of any material error or omission caused by our negligence, provided, however, that such notice shall be in writing and shall specifically address the issue you wish to raise. A failure to raise such issue within the prescribed time shall constitute your unqualified acceptance of the completeness of this report, the tests conducted and the correctness of the report contents. Unless specific mention, the uncertainty of measurement has been explicitly taken into account to declare the compliance or non-compliance to the specification.

## Table of Contents

<b>Release Control Record</b> .....	<b>4</b>
<b>1 Certificate of Conformity</b> .....	<b>5</b>
<b>2 Summary of Test Results</b> .....	<b>6</b>
2.1 Measurement Uncertainty.....	6
2.2 Modification Record.....	6
<b>3 General Information</b> .....	<b>7</b>
3.1 General Description of EUT.....	7
3.2 Description of Test Modes.....	8
3.2.1 Test Mode Applicability and Tested Channel Detail.....	9
3.3 Description of Support Units.....	11
3.3.1 Configuration of System under Test.....	11
3.4 Duty Cycle of Test Signal.....	12
3.5 General Description of Applied Standards and references.....	12
<b>4 Test Types and Results</b> .....	<b>13</b>
4.1 Radiated Emission and Bandedge Measurement.....	13
4.1.1 Limits of Radiated Emission and Bandedge Measurement.....	13
4.1.2 Test Instruments.....	14
4.1.3 Test Procedures.....	15
4.1.4 Deviation from Test Standard.....	15
4.1.5 Test Setup.....	16
4.1.6 EUT Operating Conditions.....	17
4.1.7 Test Results.....	18
4.2 Conducted Emission Measurement.....	26
4.2.1 Limits of Conducted Emission Measurement.....	26
4.2.2 Test Instruments.....	26
4.2.3 Test Procedures.....	27
4.2.4 Deviation from Test Standard.....	27
4.2.5 Test Setup.....	27
4.2.6 EUT Operating Conditions.....	27
4.2.7 Test Results.....	28
4.3 6dB Bandwidth Measurement.....	32
4.3.1 Limits of 6dB Bandwidth Measurement.....	32
4.3.2 Test Setup.....	32
4.3.3 Test Instruments.....	32
4.3.4 Test Procedure.....	32
4.3.5 Deviation from Test Standard.....	32
4.3.6 EUT Operating Conditions.....	32
4.3.7 Test Result.....	33
4.4 Conducted Output Power Measurement.....	34
4.4.1 Limits OF Conducted Output Power Measurement.....	34
4.4.2 Test Setup.....	34
4.4.3 Test Instruments.....	34
4.4.4 Test Procedures.....	34
4.4.5 Deviation from Test Standard.....	34
4.4.6 EUT Operating Conditions.....	34
4.4.7 Test Results.....	35
4.5 Power Spectral Density Measurement.....	36
4.5.1 Limits of Power Spectral Density Measurement.....	36
4.5.2 Test Setup.....	36
4.5.3 Test Instruments.....	36
4.5.4 Test Procedure.....	36
4.5.5 Deviation from Test Standard.....	36

4.5.6 EUT Operating Condition .....	36
4.5.7 Test Results .....	37
4.6 Conducted Out of Band Emission Measurement.....	38
4.6.1 Limits of Conducted Out of Band Emission Measurement .....	38
4.6.2 Test Setup.....	38
4.6.3 Test Instruments .....	38
4.6.4 Test Procedure .....	38
4.6.5 Deviation from Test Standard .....	38
4.6.6 EUT Operating Condition .....	38
4.6.7 Test Results .....	39
<b>Annex A- Band Edge Measurement.....</b>	<b>41</b>
<b>5 Pictures of Test Arrangements.....</b>	<b>43</b>
<b>Appendix – Information of the Testing Laboratories .....</b>	<b>44</b>

### Release Control Record

Issue No.	Description	Date Issued
RF200608D03-2	Original release.	Nov. 3, 2020

## 1 Certificate of Conformity

**Product:** Bluetooth Headset

**Brand:** RHA

**Test Model:** TrueControl

**Sample Status:** Engineering sample

**Applicant:** RHA Technologies Limited

**Test Date:** Jul. 27 to Nov. 3, 2020

**Standards:** 47 CFR FCC Part 15, Subpart C (Section 15.247)  
ANSI C63.10: 2013

The above equipment has been tested by **Bureau Veritas Consumer Products Services (H.K.) Ltd., Taoyuan Branch**, and found compliance with the requirement of the above standards. The test record, data evaluation & Equipment Under Test (EUT) configurations represented herein are true and accurate accounts of the measurements of the sample's RF characteristics under the conditions specified in this report.

**Prepared by :**

*Annie Chang*

**Date:**

Nov. 3, 2020

Annie Chang / Senior Specialist

**Approved by :**

*Rex Lai*

**Date:**

Nov. 3, 2020

Rex Lai / Associate Technical Manager

## 2 Summary of Test Results

47 CFR FCC Part 15, Subpart C (SECTION 15.247)			
FCC Clause	Test Item	Result	Remarks
15.207	AC Power Conducted Emission	PASS	Meet the requirement of limit. Minimum passing margin is -15.64dB at 0.16172MHz.
15.205 & 209 & 15.247(d)	Radiated Emissions & Band Edge Measurement	PASS	Meet the requirement of limit. Minimum passing margin is -7.90dB at 37.08MHz.
15.247(d)	Antenna Port Emission	PASS	Meet the requirement of limit.
15.247(a)(2)	6dB bandwidth	PASS	Meet the requirement of limit.
15.247(b)	Conducted power	PASS	Meet the requirement of limit.
15.247(e)	Power Spectral Density	PASS	Meet the requirement of limit.
15.203	Antenna Requirement	PASS	No antenna connector is used.

**Note:**

1. For 2.4GHz band compliance with rule 15.247(d) of the band-edge items, the test plots were recorded in Annex A.
2. Determining compliance based on the results of the compliance measurement, not taking into account measurement instrumentation uncertainty.

### 2.1 Measurement Uncertainty

Where relevant, the following measurement uncertainty levels have been estimated for tests performed on the EUT as specified in CISPR 16-4-2:

Measurement	Frequency	Expanded Uncertainty (k=2) ( $\pm$ )
Conducted Emissions at mains ports	150kHz ~ 30MHz	3.00 dB
Conducted Emissions	9kHz ~ 40GHz	2.63 dB
Radiated Emissions up to 1 GHz	9kHz ~ 30MHz	2.61 dB
	30MHz ~ 1GHz	5.43 dB
Radiated Emissions above 1 GHz	Above 1GHz	5.42 dB

### 2.2 Modification Record

There were no modifications required for compliance.

### 3 General Information

#### 3.1 General Description of EUT

Product	Bluetooth Headset
Brand	RHA
Test Model	TrueControl
Status of EUT	Engineering sample
Power Supply Rating	3.7Vdc from Battery or 5Vdc from USB port via Charging Case
Modulation Type	GFSK
Transfer Rate	Up to 2Mbps
Operating Frequency	2402MHz ~ 2480MHz
Number of Channel	40
Output Power	1.786mW
Antenna Type	PIFA antenna with -7.27dBi gain
Antenna Connector	N/A
Accessory Device	Charging Case
Data Cable Supplied	Shielded USB Type C cable (0.6m)

Note:

1. The above Antenna information is declared by manufacturer and for more detailed features description, please refer to the manufacturer's specifications, the laboratory shall not be held responsible.
2. The EUT was pre-tested with the following modes:
  - ✧ Operating Mode (EUT only)
  - ✧ Operating + Charging Mode (EUT + Charging Case + Adapter)
  - ✧ Operating + Charging Mode (EUT + Charging Case + Notebook)

The worst emission level was found when the EUT tested under **Operating + Charging Mode (EUT + Charging Case + Notebook)** therefore, only its test data was recorded in this report.
3. The above EUT information is declared by manufacturer and for more detailed features description, please refers to the manufacturer's specifications or user's manual.

### 3.2 Description of Test Modes

40 channels are provided to this EUT:

CHANNEL	FREQ. (MHz)	CHANNEL	FREQ. (MHz)	CHANNEL	FREQ. (MHz)	CHANNEL	FREQ. (MHz)
0	2402	10	2422	20	2442	30	2462
1	2404	11	2424	21	2444	31	2464
2	2406	12	2426	22	2446	32	2466
3	2408	13	2428	23	2448	33	2468
4	2410	14	2430	24	2450	34	2470
5	2412	15	2432	25	2452	35	2472
6	2414	16	2434	26	2454	36	2474
7	2416	17	2436	27	2456	37	2476
8	2418	18	2438	28	2458	38	2478
9	2420	19	2440	29	2460	39	2480



### 3.2.1 Test Mode Applicability and Tested Channel Detail

EUT Configure Mode	Applicable To				Description
	RE $\geq$ 1G	RE<1G	PLC	APCM	
A	√	-	-	√	Operating Mode (EUT only)
B	-	√	√	-	Operating + Charging Mode (EUT + Charging Case + Notebook)
C	-	-	√	-	Operating + Charging Mode (EUT + Charging Case + Adapter)

Where **RE $\geq$ 1G**: Radiated Emission above 1GHz      **RE<1G**: Radiated Emission below 1GHz  
**PLC**: Power Line Conducted Emission      **APCM**: Antenna Port Conducted Measurement

**NOTE:** The EUT had been pre-tested on the positioned of each 3 axis. The worst case was found when positioned on **X-plane**.

#### **Radiated Emission Test (Above 1GHz):**

- Pre-Scan has been conducted to determine the worst-case mode from all possible combinations between available modulations, data rates and antenna ports (if EUT with antenna diversity architecture).
- Following channel(s) was (were) selected for the final test as listed below.

EUT Configure Mode	Available Channel	Tested Channel	Modulation Type	Data Rate (Mbps)
A	0 to 39	0, 19, 39	GFSK	1
A	0 to 39	0, 19, 39	GFSK	2

#### **Radiated Emission Test (Below 1GHz):**

- Pre-Scan has been conducted to determine the worst-case mode from all possible combinations between available modulations, data rates and antenna ports (if EUT with antenna diversity architecture).
- Following channel(s) was (were) selected for the final test as listed below.

EUT Configure Mode	Available Channel	Tested Channel	Modulation Type	Data Rate (Mbps)
B	0 to 39	0	GFSK	1

#### **Power Line Conducted Emission Test:**

- Pre-Scan has been conducted to determine the worst-case mode from all possible combinations between available modulations, data rates and antenna ports (if EUT with antenna diversity architecture).
- Following channel(s) was (were) selected for the final test as listed below.

EUT Configure Mode	Available Channel	Tested Channel	Modulation Type	Data Rate (Mbps)
B~C	0 to 39	0	GFSK	1

**Antenna Port Conducted Measurement:**

- This item includes all test value of each mode, but only includes spectrum plot of worst value of each mode.
- Pre-Scan has been conducted to determine the worst-case mode from all possible combinations between available modulations, data rates and antenna ports (if EUT with antenna diversity architecture).
- Following channel(s) was (were) selected for the final test as listed below.

EUT Configure Mode	Available Channel	Tested Channel	Modulation Type	Data Rate (Mbps)
A	0 to 39	0, 19, 39	GFSK	1
A	0 to 39	0, 19, 39	GFSK	2

**Test Condition:**

Applicable To	EUT Configure Mode	Environmental Conditions	Input Power	Tested By
RE $\geq$ 1G	A	24deg. C, 64%RH	3.7Vdc	Dalen Dai
RE<1G	B	21deg. C, 74%RH	120Vac, 60Hz (System)	Dalen Dai
PLC	B	25deg. C, 75%RH	120Vac, 60Hz (System)	StarItaly Wu
	C	25deg. C, 75%RH	120Vac, 60Hz (Adapter)	StarItaly Wu
APCM	A	25deg. C, 76%RH	3.7Vdc	Pirar Hsieh

### 3.3 Description of Support Units

The EUT has been tested as an independent unit together with other necessary accessories or support units. The following support units or accessories were used to form a representative test configuration during the tests.

ID	Product	Brand	Model No.	Serial No.	FCC ID	Remarks
A.	AC Adapter	Apple	A1385	N/A	N/A	Provided by Lab
B.	Notebook PC	Lenovo	81A4	YD02TWDP	N/A	Provided by Lab

Note: All power cords of the above support units are non-shielded (1.8m).

ID	Descriptions	Qty.	Length (m)	Shielding (Yes/No)	Cores (Qty.)	Remarks
1.	USB Type C cable	1	0.6	Y	0	Supplied by client

Note: The core(s) is(are) originally attached to the cable(s).

#### 3.3.1 Configuration of System under Test

##### Mode A

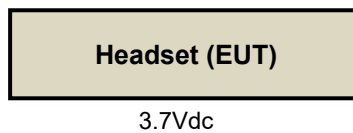

##### Mode B

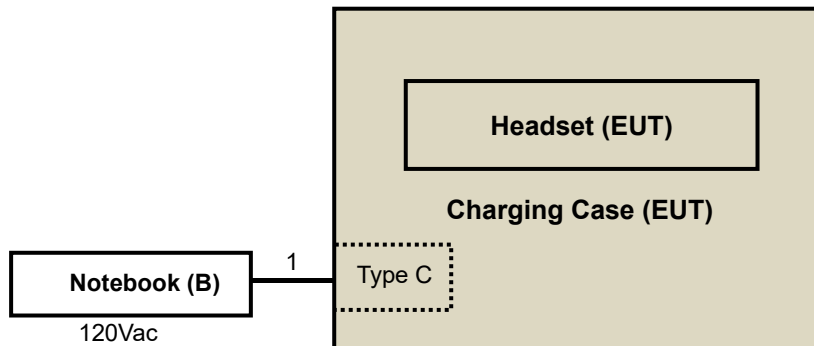

##### Mode C

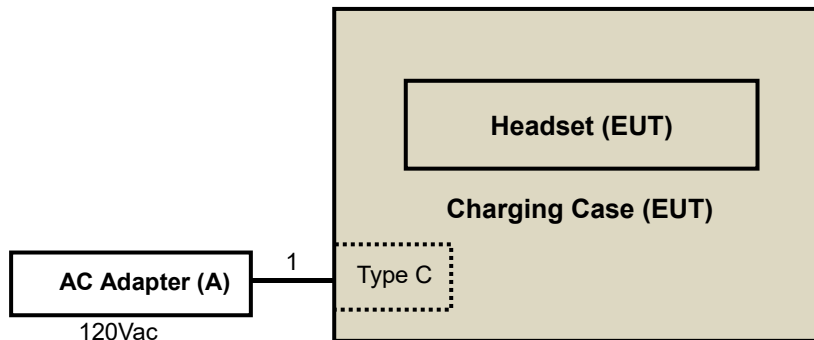

### 3.4 Duty Cycle of Test Signal

Duty cycle of test signal is < 98 %, duty factor shall be considered.

**GFSK (1Mbps):** Duty cycle = 0.415ms/0.630ms = 0.659, Duty factor =  $10 * \log(1/0.659) = 1.81$

**GFSK (2Mbps):** Duty cycle = 1.11ms/1.85ms = 0.6, Duty factor =  $10 * \log(1/0.6) = 2.22$

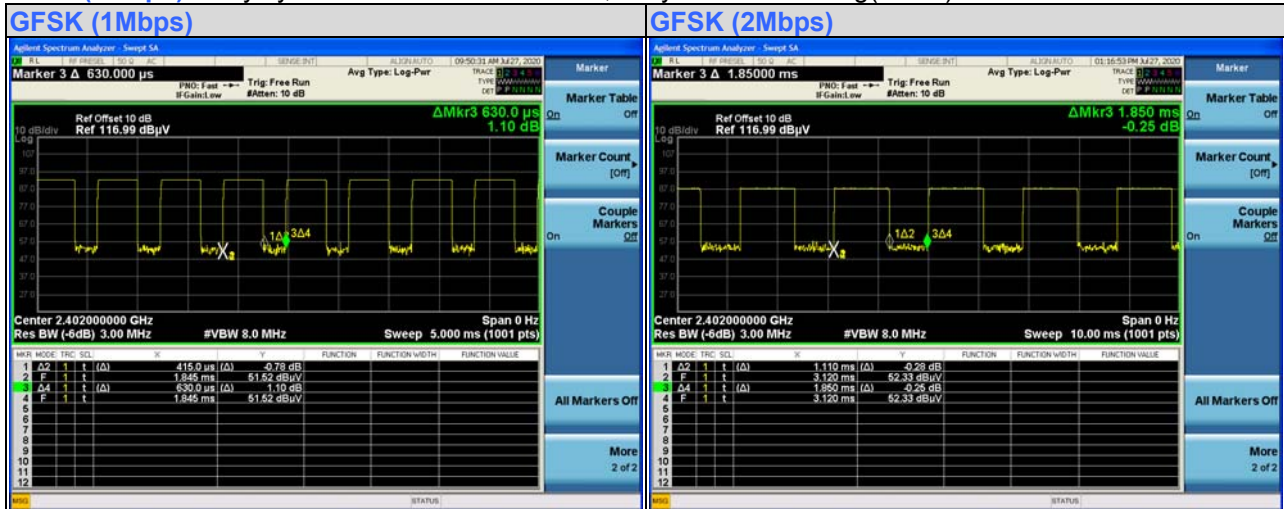

### 3.5 General Description of Applied Standards and references

The EUT is a RF Product. According to the specifications of the manufacturer, it must comply with the requirements of the following standards and references:

**Test standard:**

**FCC Part 15, Subpart C (15.247)**

**ANSI C63.10-2013**

All test items have been performed and recorded as per the above standards.

**References Test Guidance:**

**KDB 558074 D01 15.247 Meas Guidance v05r02**

All test items have been performed as a reference to the above KDB test guidance.

## 4 Test Types and Results

### 4.1 Radiated Emission and Bandedge Measurement

#### 4.1.1 Limits of Radiated Emission and Bandedge Measurement

Radiated emissions which fall in the restricted bands must comply with the radiated emission limits specified as below table. Other emissions shall be at least 20dB below the highest level of the desired power:

Frequencies (MHz)	Field Strength (microvolts/meter)	Measurement Distance (meters)
0.009 ~ 0.490	2400/F(kHz)	300
0.490 ~ 1.705	24000/F(kHz)	30
1.705 ~ 30.0	30	30
30 ~ 88	100	3
88 ~ 216	150	3
216 ~ 960	200	3
Above 960	500	3

**NOTE:**

1. The lower limit shall apply at the transition frequencies.
2. Emission level (dBuV/m) = 20 log Emission level (uV/m).
3. For frequencies above 1000MHz, the field strength limits are based on average detector, however, the peak field strength of any emission shall not exceed the maximum permitted average limits, specified above by more than 20dB under any condition of modulation.

#### 4.1.2 Test Instruments

DESCRIPTION & MANUFACTURER	MODEL NO.	SERIAL NO.	CALIBRATED DATE	CALIBRATED UNTIL
HP Preamplifier	8447D	2432A03504	Feb. 19, 2020	Feb. 18, 2021
HP Preamplifier	8449B	3008A01201	Feb. 20, 2020	Feb. 19, 2021
MITEQ Preamplifier	AMF-6F-260400-33-8P	892164	Feb. 19, 2020	Feb. 18, 2021
Agilent TEST RECEIVER	N9038A	MY51210129	Mar. 18, 2020	Mar. 17, 2021
Schwarzbeck Antenna	VULB 9168	139	Nov. 7, 2019	Nov. 6, 2020
Schwarzbeck Antenna	VHBA 9123	480	Jun. 3, 2019	Jun. 2, 2021
Schwarzbeck Horn Antenna	BBHA-9170	212	Nov. 24, 2019	Nov. 23, 2020
Schwarzbeck Horn Antenna	BBHA 9120-D1	D130	Nov. 24, 2019	Nov. 23, 2020
ADT. Turn Table	TT100	0306	NA	NA
ADT. Tower	AT100	0306	NA	NA
Software	Radiated_V7.6.15.9.5	NA	NA	NA
SUHNER RF cable With 4dB PAD	SF102	Cable-CH6-01	Jul. 9, 2020	Jul. 8, 2021
SUHNER RF cable With 3/4dB PAD	SF102	Cable-CH8-3.6m	Jul. 9, 2020	Jul. 8, 2021
KEYSIGHT MIMO Powermeasurement Test set	U2021XA	U2021XA-001	Jun. 16, 2020	Jun. 15, 2021
KEYSIGHT Spectrum Analyzer	N9030A	MY54490260	Jul. 22, 2020	Jul. 21, 2021
Loop Antenna EMCI	LPA600	270	Aug. 23, 2019	Aug. 22, 2021
EMCO Horn Antenna	3115	00028257	Nov. 24, 2019	Nov. 23, 2020
Highpass filter Wainwright Instruments	WHK 3.1/18G-10SS	SN 8	NA	NA

- NOTE:**
1. The calibration interval of the above test instruments is 12/24 months. And the calibrations are traceable to NML/ROC and NIST/USA.
  2. The horn antenna and HP preamplifier (model: 8449B) are used only for the measurement of emission frequency above 1GHz if tested.
  3. The test was performed in Chamber No. 6.
  4. Tested Date: Jul. 27 to Aug. 25, 2020 (Mode A) & Oct. 23, 2020 (Mode B)

#### 4.1.3 Test Procedures

##### **For Radiated emission below 30MHz**

- a. The EUT was placed on the top of a rotating table 0.8 meters above the ground at a 3 meter chamber room. The table was rotated 360 degrees to determine the position of the highest radiation.
- b. The EUT was set 3 meters away from the interference-receiving antenna, which was mounted on the top of a variable-height antenna tower.
- c. Parallel, perpendicular, and ground-parallel orientations of the antenna are set to make the measurement.
- d. For each suspected emission, the EUT was arranged to its worst case and the rotatable table was turned from 0 degrees to 360 degrees to find the maximum reading.
- e. The test-receiver system was set to Quasi-Peak Detect Function and Specified Bandwidth with Maximum Hold Mode.

##### **NOTE:**

1. The resolution bandwidth and video bandwidth of test receiver/spectrum analyzer is 9kHz at frequency below 30MHz.

##### **For Radiated emission above 30MHz**

- a. The EUT was placed on the top of a rotating table 0.8 meters (for 30MHz ~ 1GHz) / 1.5 meters (for above 1GHz) above the ground at 3 meter chamber room for test. The table was rotated 360 degrees to determine the position of the highest radiation.
- b. The EUT was set 3 meters away from the interference-receiving antenna, which was mounted on the top of a variable-height antenna tower.
- c. The height of antenna is varied from one meter to four meters above the ground to determine the maximum value of the field strength. Both horizontal and vertical polarizations of the antenna are set to make the measurement.
- d. For each suspected emission, the EUT was arranged to its worst case and then the antenna was tuned to heights from 1 meter to 4 meters and the rotatable table was turned from 0 degrees to 360 degrees to find the maximum reading.
- e. The test-receiver system was set to quasi-peak detect function and specified bandwidth with maximum hold mode when the test frequency is below 1 GHz.
- f. The test-receiver system was set to peak and average detect function and specified bandwidth with maximum hold mode when the test frequency is above 1 GHz. If the peak reading value also meets average limit, measurement with the average detector is unnecessary.

##### **Note:**

1. The resolution bandwidth and video bandwidth of test receiver/spectrum analyzer is 120kHz for Quasi-peak detection (QP) at frequency below 1GHz.
2. The resolution bandwidth of test receiver/spectrum analyzer is 1 MHz and the video bandwidth is 3 MHz for Peak detection (PK) at frequency above 1GHz.
3. The resolution bandwidth of test receiver/spectrum analyzer is 1MHz and the video bandwidth is  $\geq 1/T$  (Duty cycle < 98%) or 10Hz (Duty cycle  $\geq 98\%$ ) for Average detection (AV) at frequency above 1GHz.  
(**GFSK (1Mbps)**): RBW = 1MHz, VBW = 2.7kHz ; (**GFSK (2Mbps)**): RBW = 1MHz, VBW = 1kHz)
4. All modes of operation were investigated and the worst-case emissions are reported.

#### 4.1.4 Deviation from Test Standard

No deviation.

#### 4.1.5 Test Setup

##### For Radiated emission below 30MHz

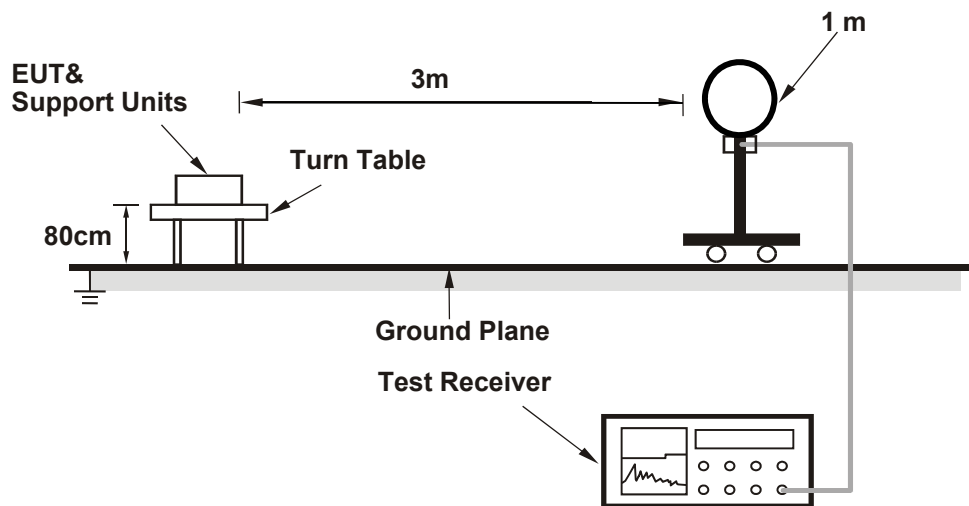

##### For Radiated emission 30MHz to 1GHz

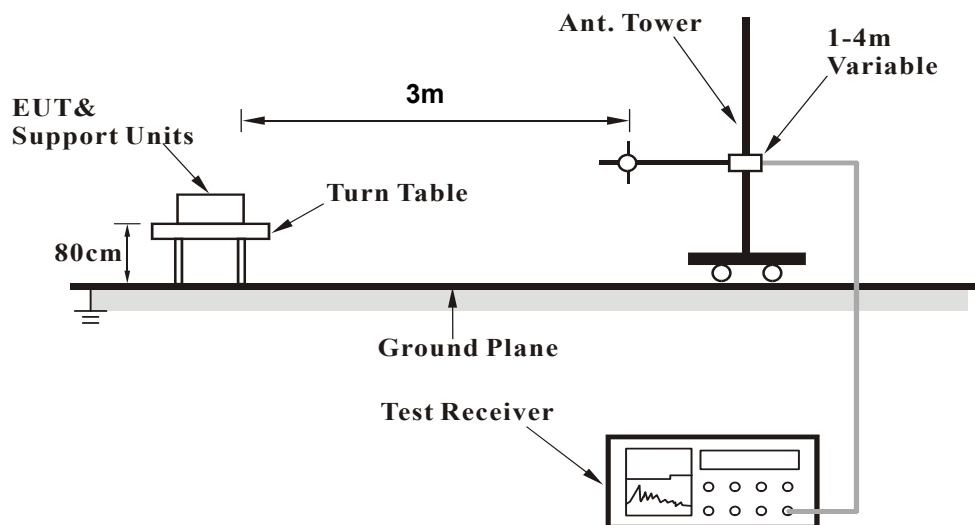



**For Radiated emission above 1GHz**

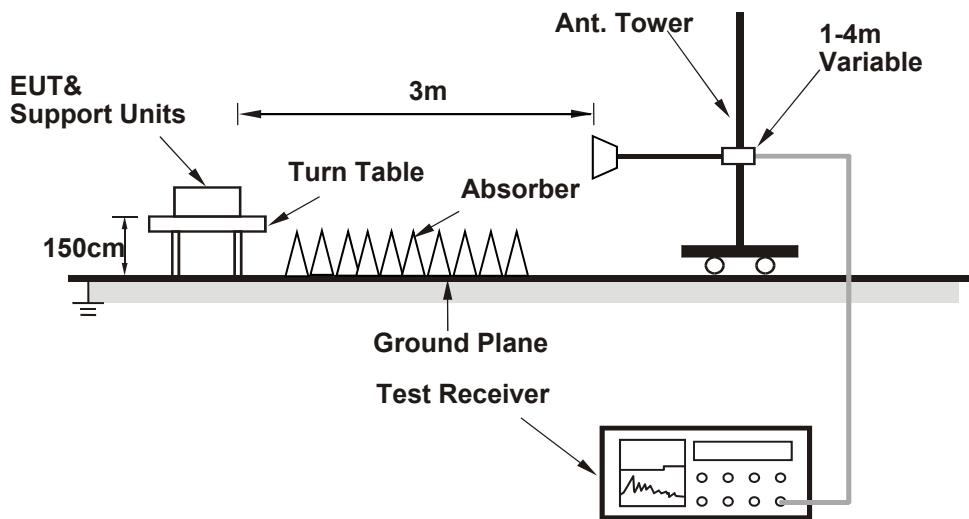

For the actual test configuration, please refer to the attached file (Test Setup Photo).

**4.1.6 EUT Operating Conditions**

**Mode A:**

Set the EUT under transmission condition continuously at specific channel frequency continuously.

**Mode B:**

Connected the EUT to Adapter or Notebook.

Set the EUT under operating and charging condition.

#### 4.1.7 Test Results

##### Mode A

##### Above 1GHz Data

##### GFSK (1Mbps)

<b>Channel</b>	TX Channel 0	<b>Detector Function</b>	Peak (PK)
<b>Frequency Range</b>	1GHz ~ 25GHz		Average (AV)

##### Antenna Polarity & Test Distance : Horizontal at 3 m

No	Frequency (MHz)	Emission Level (dBuV/m)	Limit (dBuV/m)	Margin (dB)	Antenna Height (m)	Table Angle (Degree)	Raw Value (dBuV)	Correction Factor (dB/m)
1	2390.00	55.25 PK	74.00	-18.75	2.31 H	285	54.86	0.39
2	2390.00	42.03 AV	54.00	-11.97	2.31 H	285	41.64	0.39
3	*2402.00	96.01 PK			2.31 H	285	95.57	0.44
4	*2402.00	95.45 AV			2.31 H	285	95.01	0.44
5	4804.00	50.58 PK	74.00	-23.42	1.93 H	233	42.77	7.81
6	4804.00	38.94 AV	54.00	-15.06	1.93 H	233	31.13	7.81

##### Antenna Polarity & Test Distance : Vertical at 3 m

No	Frequency (MHz)	Emission Level (dBuV/m)	Limit (dBuV/m)	Margin (dB)	Antenna Height (m)	Table Angle (Degree)	Raw Value (dBuV)	Correction Factor (dB/m)
1	2390.00	54.56 PK	74.00	-19.44	1.12 V	337	54.17	0.39
2	2390.00	41.58 AV	54.00	-12.42	1.12 V	337	41.19	0.39
3	*2402.00	94.56 PK			1.12 V	337	94.12	0.44
4	*2402.00	93.96 AV			1.12 V	337	93.52	0.44
5	4804.00	50.04 PK	74.00	-23.96	2.63 V	356	42.23	7.81
6	4804.00	38.68 AV	54.00	-15.32	2.63 V	356	30.87	7.81

##### Remarks:

1. Emission Level(dBuV/m) = Raw Value(dBuV) + Correction Factor(dB/m)
2. Correction Factor(dB/m) = Antenna Factor(dB/m) + Cable Factor(dB) – Pre-Amplifier Factor(dB)
3. Margin value = Emission Level – Limit value
4. The other emission levels were very low against the limit.
5. " \* ": Fundamental frequency.

<b>Channel</b>	TX Channel 19	<b>Detector Function</b>	Peak (PK)
<b>Frequency Range</b>	1GHz ~ 25GHz		Average (AV)

**Antenna Polarity & Test Distance : Horizontal at 3 m**

No	Frequency (MHz)	Emission Level (dBuV/m)	Limit (dBuV/m)	Margin (dB)	Antenna Height (m)	Table Angle (Degree)	Raw Value (dBuV)	Correction Factor (dB/m)
1	*2440.00	95.11 PK			2.27 H	289	94.61	0.50
2	*2440.00	94.63 AV			2.27 H	289	94.13	0.50
3	4880.00	50.76 PK	74.00	-23.24	1.97 H	235	43.03	7.73
4	4880.00	39.10 AV	54.00	-14.90	1.97 H	235	31.37	7.73

**Antenna Polarity & Test Distance : Vertical at 3 m**

No	Frequency (MHz)	Emission Level (dBuV/m)	Limit (dBuV/m)	Margin (dB)	Antenna Height (m)	Table Angle (Degree)	Raw Value (dBuV)	Correction Factor (dB/m)
1	*2440.00	94.61 PK			1.12 V	165	94.11	0.50
2	*2440.00	94.05 AV			1.12 V	165	93.55	0.50
3	4880.00	50.13 PK	74.00	-23.87	2.66 V	351	42.40	7.73
4	4880.00	38.79 AV	54.00	-15.21	2.66 V	351	31.06	7.73

**Remarks:**

1. Emission Level(dBuV/m) = Raw Value(dBuV) + Correction Factor(dB/m)
2. Correction Factor(dB/m) = Antenna Factor(dB/m) + Cable Factor(dB) – Pre-Amplifier Factor(dB)
3. Margin value = Emission Level – Limit value
4. The other emission levels were very low against the limit.
5. " \* ": Fundamental frequency.

<b>Channel</b>	TX Channel 39	<b>Detector Function</b>	Peak (PK)
<b>Frequency Range</b>	1GHz ~ 25GHz		Average (AV)

**Antenna Polarity & Test Distance : Horizontal at 3 m**

No	Frequency (MHz)	Emission Level (dBuV/m)	Limit (dBuV/m)	Margin (dB)	Antenna Height (m)	Table Angle (Degree)	Raw Value (dBuV)	Correction Factor (dB/m)
1	*2480.00	94.72 PK			3.01 H	84	94.06	0.66
2	*2480.00	94.18 AV			3.01 H	84	93.52	0.66
3	2483.50	55.42 PK	74.00	-18.58	3.01 H	84	54.73	0.69
4	2483.50	42.42 AV	54.00	-11.58	3.01 H	84	41.73	0.69
5	4960.00	50.31 PK	74.00	-23.69	1.96 H	238	42.57	7.74
6	4960.00	38.66 AV	54.00	-15.34	1.96 H	238	30.92	7.74

**Antenna Polarity & Test Distance : Vertical at 3 m**

No	Frequency (MHz)	Emission Level (dBuV/m)	Limit (dBuV/m)	Margin (dB)	Antenna Height (m)	Table Angle (Degree)	Raw Value (dBuV)	Correction Factor (dB/m)
1	*2480.00	93.98 PK			1.14 V	159	93.32	0.66
2	*2480.00	93.27 AV			1.14 V	159	92.61	0.66
3	2483.50	54.85 PK	74.00	-19.15	1.14 V	159	54.16	0.69
4	2483.50	41.89 AV	54.00	-12.11	1.14 V	159	41.20	0.69
5	4960.00	49.78 PK	74.00	-24.22	2.64 V	355	42.04	7.74
6	4960.00	38.34 AV	54.00	-15.66	2.64 V	355	30.60	7.74

**Remarks:**

1. Emission Level(dBuV/m) = Raw Value(dBuV) + Correction Factor(dB/m)
2. Correction Factor(dB/m) = Antenna Factor(dB/m) + Cable Factor(dB) – Pre-Amplifier Factor(dB)
3. Margin value = Emission Level – Limit value
4. The other emission levels were very low against the limit.
5. " \* " : Fundamental frequency.

**GFSK (2Mbps)**

<b>Channel</b>	TX Channel 0	<b>Detector Function</b>	Peak (PK)
<b>Frequency Range</b>	1GHz ~ 25GHz		Average (AV)

**Antenna Polarity & Test Distance : Horizontal at 3 m**

No	Frequency (MHz)	Emission Level (dBuV/m)	Limit (dBuV/m)	Margin (dB)	Antenna Height (m)	Table Angle (Degree)	Raw Value (dBuV)	Correction Factor (dB/m)
1	2390.00	54.85 PK	74.00	-19.15	2.32 H	287	54.46	0.39
2	2390.00	41.55 AV	54.00	-12.45	2.32 H	287	41.16	0.39
3	*2402.00	95.77 PK			2.32 H	287	95.33	0.44
4	*2402.00	95.08 AV			2.32 H	287	94.64	0.44
5	4804.00	50.36 PK	74.00	-23.64	1.96 H	230	42.55	7.81
6	4804.00	38.73 AV	54.00	-15.27	1.96 H	230	30.92	7.81

**Antenna Polarity & Test Distance : Vertical at 3 m**

No	Frequency (MHz)	Emission Level (dBuV/m)	Limit (dBuV/m)	Margin (dB)	Antenna Height (m)	Table Angle (Degree)	Raw Value (dBuV)	Correction Factor (dB/m)
1	2390.00	54.32 PK	74.00	-19.68	4.00 V	162	53.93	0.39
2	2390.00	41.13 AV	54.00	-12.87	4.00 V	162	40.74	0.39
3	*2402.00	95.19 PK			4.00 V	162	94.75	0.44
4	*2402.00	94.42 AV			4.00 V	162	93.98	0.44
5	4804.00	50.07 PK	74.00	-23.93	2.77 V	354	42.26	7.81
6	4804.00	38.38 AV	54.00	-15.62	2.77 V	354	30.57	7.81

**Remarks:**

1. Emission Level(dBuV/m) = Raw Value(dBuV) + Correction Factor(dB/m)
2. Correction Factor(dB/m) = Antenna Factor(dB/m) + Cable Factor(dB) – Pre-Amplifier Factor(dB)
3. Margin value = Emission Level – Limit value
4. The other emission levels were very low against the limit.
5. " \* ": Fundamental frequency.

<b>Channel</b>	TX Channel 19	<b>Detector Function</b>	Peak (PK)
<b>Frequency Range</b>	1GHz ~ 25GHz		Average (AV)

**Antenna Polarity & Test Distance : Horizontal at 3 m**

No	Frequency (MHz)	Emission Level (dBuV/m)	Limit (dBuV/m)	Margin (dB)	Antenna Height (m)	Table Angle (Degree)	Raw Value (dBuV)	Correction Factor (dB/m)
1	*2440.00	95.34 PK			2.35 H	289	94.84	0.50
2	*2440.00	94.67 AV			2.35 H	289	94.17	0.50
3	4880.00	50.19 PK	74.00	-23.81	1.93 H	234	42.46	7.73
4	4880.00	38.54 AV	54.00	-15.46	1.93 H	234	30.81	7.73

**Antenna Polarity & Test Distance : Vertical at 3 m**

No	Frequency (MHz)	Emission Level (dBuV/m)	Limit (dBuV/m)	Margin (dB)	Antenna Height (m)	Table Angle (Degree)	Raw Value (dBuV)	Correction Factor (dB/m)
1	*2440.00	94.71 PK			3.98 V	163	94.21	0.50
2	*2440.00	93.98 AV			3.98 V	163	93.48	0.50
3	4880.00	49.88 PK	74.00	-24.12	2.72 V	357	42.15	7.73
4	4880.00	38.16 AV	54.00	-15.84	2.72 V	357	30.43	7.73

**Remarks:**

1. Emission Level(dBuV/m) = Raw Value(dBuV) + Correction Factor(dB/m)
2. Correction Factor(dB/m) = Antenna Factor(dB/m) + Cable Factor(dB) – Pre-Amplifier Factor(dB)
3. Margin value = Emission Level – Limit value
4. The other emission levels were very low against the limit.
5. " \* ": Fundamental frequency.

<b>Channel</b>	TX Channel 39	<b>Detector Function</b>	Peak (PK)
<b>Frequency Range</b>	1GHz ~ 25GHz		Average (AV)

**Antenna Polarity & Test Distance : Horizontal at 3 m**

No	Frequency (MHz)	Emission Level (dBuV/m)	Limit (dBuV/m)	Margin (dB)	Antenna Height (m)	Table Angle (Degree)	Raw Value (dBuV)	Correction Factor (dB/m)
1	*2480.00	94.69 PK			2.94 H	296	94.03	0.66
2	*2480.00	94.01 AV			2.94 H	296	93.35	0.66
3	2483.50	55.71 PK	74.00	-18.29	2.94 H	296	55.02	0.69
4	2483.50	43.38 AV	54.00	-10.62	2.94 H	296	42.69	0.69
5	4960.00	49.93 PK	74.00	-24.07	1.91 H	227	42.19	7.74
6	4960.00	38.41 AV	54.00	-15.59	1.91 H	227	30.67	7.74

**Antenna Polarity & Test Distance : Vertical at 3 m**

No	Frequency (MHz)	Emission Level (dBuV/m)	Limit (dBuV/m)	Margin (dB)	Antenna Height (m)	Table Angle (Degree)	Raw Value (dBuV)	Correction Factor (dB/m)
1	*2480.00	93.98 PK			4.00 V	166	93.32	0.66
2	*2480.00	93.22 AV			4.00 V	166	92.56	0.66
3	2483.50	54.92 PK	74.00	-19.08	4.00 V	166	54.23	0.69
4	2483.50	42.85 AV	54.00	-11.15	4.00 V	166	42.16	0.69
5	4960.00	49.65 PK	74.00	-24.35	2.76 V	351	41.91	7.74
6	4960.00	38.04 AV	54.00	-15.96	2.76 V	351	30.30	7.74

**Remarks:**

1. Emission Level(dBuV/m) = Raw Value(dBuV) + Correction Factor(dB/m)
2. Correction Factor(dB/m) = Antenna Factor(dB/m) + Cable Factor(dB) – Pre-Amplifier Factor(dB)
3. Margin value = Emission Level – Limit value
4. The other emission levels were very low against the limit.
5. " \* ": Fundamental frequency.

**Mode B**

**Below 1GHz Data:**

**GFSK (1Mbps)**

<b>Channel</b>	TX Channel 0	<b>Detector Function</b>	Quasi-Peak (QP)
<b>Frequency Range</b>	9kHz ~ 1GHz		

Antenna Polarity & Test Distance : Horizontal at 3 m								
No	Frequency (MHz)	Emission Level (dBuV/m)	Limit (dBuV/m)	Margin (dB)	Antenna Height (m)	Table Angle (Degree)	Raw Value (dBuV)	Correction Factor (dB/m)
1	37.08	21.58 QP	40.00	-18.42	1.71 H	106	29.60	-8.02
2	101.73	22.64 QP	43.50	-20.86	1.35 H	151	33.66	-11.02
3	400.01	31.22 QP	46.00	-14.78	1.21 H	250	33.45	-2.23
4	517.91	27.92 QP	46.00	-18.08	1.86 H	358	27.63	0.29
5	594.25	30.20 QP	46.00	-15.80	2.13 H	253	27.94	2.26
6	833.64	34.07 QP	46.00	-11.93	1.40 H	243	27.56	6.51

**Remarks:**

1. Emission Level(dBuV/m) = Raw Value(dBuV) + Correction Factor(dB/m)
2. Correction Factor(dB/m) = Antenna Factor(dB/m) + Cable Factor(dB) – Pre-Amplifier Factor(dB)
3. Margin value = Emission Level – Limit value
4. The other emission levels were very low against the limit of frequency range 30MHz~1000MHz.
5. The emission levels were very low against the limit of frequency range 9kHz~30MHz: the amplitude of spurious emissions attenuated more than 20 dB below the permissible value to be report.

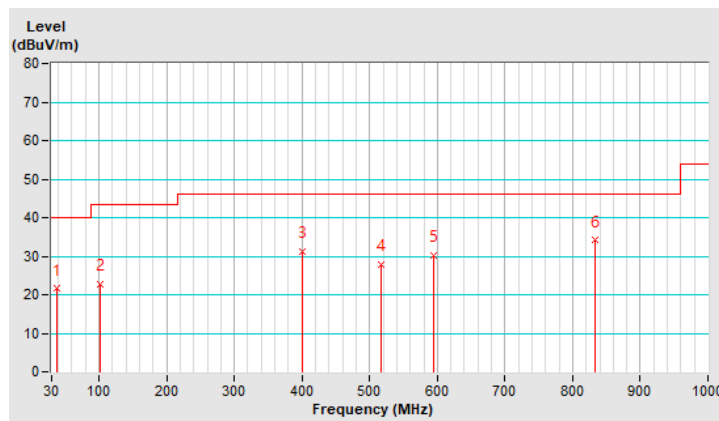



<b>Channel</b>	TX Channel 0	<b>Detector Function</b>	Quasi-Peak (QP)
<b>Frequency Range</b>	9kHz ~ 1GHz		

Antenna Polarity & Test Distance : Vertical at 3 m								
No	Frequency (MHz)	Emission Level (dBuV/m)	Limit (dBuV/m)	Margin (dB)	Antenna Height (m)	Table Angle (Degree)	Raw Value (dBuV)	Correction Factor (dB/m)
1	37.08	32.10 QP	40.00	-7.90	1.62 V	52	40.12	-8.02
2	104.40	23.87 QP	43.50	-19.63	1.37 V	247	34.43	-10.56
3	144.17	26.50 QP	43.50	-17.00	1.09 V	132	33.24	-6.74
4	170.36	20.97 QP	43.50	-22.53	1.00 V	0	27.58	-6.61
5	400.01	27.80 QP	46.00	-18.20	1.84 V	360	30.03	-2.23
6	600.02	33.09 QP	46.00	-12.91	2.07 V	137	30.76	2.33
7	926.86	35.93 QP	46.00	-10.07	1.58 V	336	27.81	8.12

**Remarks:**

1. Emission Level(dBuV/m) = Raw Value(dBuV) + Correction Factor(dB/m)
2. Correction Factor(dB/m) = Antenna Factor(dB/m) + Cable Factor(dB) – Pre-Amplifier Factor(dB)
3. Margin value = Emission Level – Limit value
4. The other emission levels were very low against the limit of frequency range 30MHz~1000MHz.
5. The emission levels were very low against the limit of frequency range 9kHz~30MHz: the amplitude of spurious emissions attenuated more than 20 dB below the permissible value to be report.

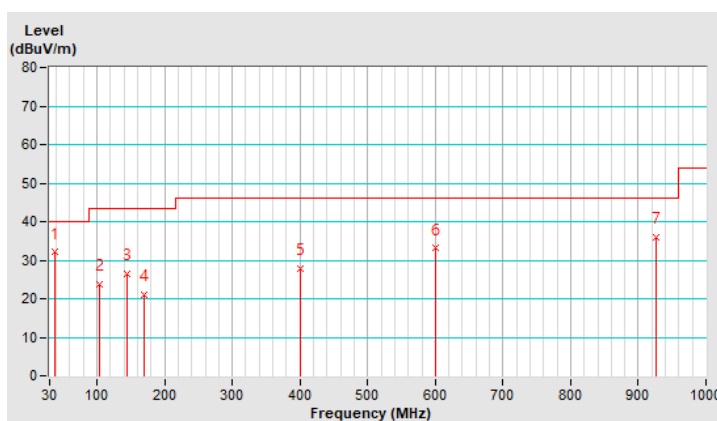

## 4.2 Conducted Emission Measurement

### 4.2.1 Limits of Conducted Emission Measurement

Frequency (MHz)	Conducted Limit (dBuV)	
	Quasi-peak	Average
0.15 - 0.5	66 - 56	56 - 46
0.50 - 5.0	56	46
5.0 - 30.0	60	50

Note: 1. The lower limit shall apply at the transition frequencies.

2. The limit decreases in line with the logarithm of the frequency in the range of 0.15 to 0.50MHz.

### 4.2.2 Test Instruments

Description & Manufacturer	Model No.	Serial No.	Cal. Date	Cal. Due
ROHDE & SCHWARZ TEST RECEIVER	ESCS30	100276	Apr. 16, 2020	Apr. 15, 2021
SCHWARZBECK Artificial Mains Network (for EUT)	NSLK 8128	8128-244	Nov. 11, 2019	Nov. 10, 2020
LISN With Adapter (for EUT)	AD10	C05Ada-001	Nov. 11, 2019	Nov. 10, 2020
ROHDE & SCHWARZ Artificial Mains Network (for peripheral)	ESH3-Z5	100220	Nov. 18, 2019	Nov. 17, 2020
Software	Cond_V7.3.7.4	NA	NA	NA
RF cable (JYEBAO) With 10dB PAD	5D-FB	Cable-C05.01	Jan. 30, 2020	Jan. 29, 2021
LYNICS Terminator (For R&S LISN)	0900510	E1-01-305	Feb. 17, 2020	Feb. 16, 2021

Note: 1. The calibration interval of the above test instruments is 12 months and the calibrations are traceable to NML/ROC and NIST/USA.

2. The test was performed in Shielded Room No. 5. (Conduction 5)

3. The VCCI Site Registration No. C-11093.

4. Tested Date: Oct. 23, 2020

#### 4.2.3 Test Procedures

- The EUT was placed 0.4 meters from the conducting wall of the shielded room with EUT being connected to the power mains through a line impedance stabilization network (LISN). Other support units were connected to the power mains through another LISN. The two LISNs provide 50 ohm/ 50uH of coupling impedance for the measuring instrument.
- Both lines of the power mains connected to the EUT were checked for maximum conducted interference.
- The frequency range from 150kHz to 30MHz was searched. Emission levels under (Limit - 20dB) was not recorded.

**NOTE:** The resolution bandwidth and video bandwidth of test receiver is 9kHz for quasi-peak detection (QP) and average detection (AV) at frequency 0.15MHz-30MHz.

#### 4.2.4 Deviation from Test Standard

No deviation.

#### 4.2.5 Test Setup

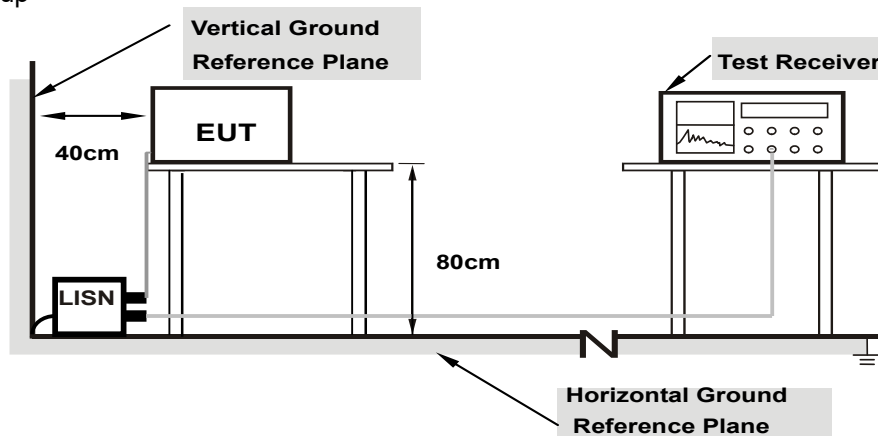

**Note: 1.Support units were connected to second LISN.**

For the actual test configuration, please refer to the attached file (Test Setup Photo).

#### 4.2.6 EUT Operating Conditions

Connected the EUT to Adapter or Notebook.  
Set the EUT under operating and charging condition.

#### 4.2.7 Test Results

##### Mode B

Frequency Range	150kHz ~ 30MHz	Detector Function	Quasi-Peak (QP) / Average (AV)
-----------------	----------------	-------------------	--------------------------------

Phase Of Power : Line (L)										
No	Frequency (MHz)	Correction Factor (dB)	Reading Value (dBuV)		Emission Level (dBuV)		Limit (dBuV)		Margin (dB)	
			Q.P.	AV.	Q.P.	AV.	Q.P.	AV.	Q.P.	AV.
1	0.16172	9.91	39.83	22.94	49.74	32.85	65.38	55.38	-15.64	-22.53
2	0.30234	9.92	23.92	8.58	33.84	18.50	60.18	50.18	-26.34	-31.68
3	0.50938	9.94	16.26	1.26	26.20	11.20	56.00	46.00	-29.80	-34.80
4	0.86094	9.97	19.96	9.86	29.93	19.83	56.00	46.00	-26.07	-26.17
5	3.70703	10.14	20.03	10.07	30.17	20.21	56.00	46.00	-25.83	-25.79
6	7.63672	10.37	16.19	6.51	26.56	16.88	60.00	50.00	-33.44	-33.12

##### Remarks:

1. Q.P. and AV. are abbreviations of quasi-peak and average individually.
2. The emission levels of other frequencies were very low against the limit.
3. Margin value = Emission level – Limit value
4. Correction factor = Insertion loss + Cable loss
5. Emission Level = Correction Factor + Reading Value

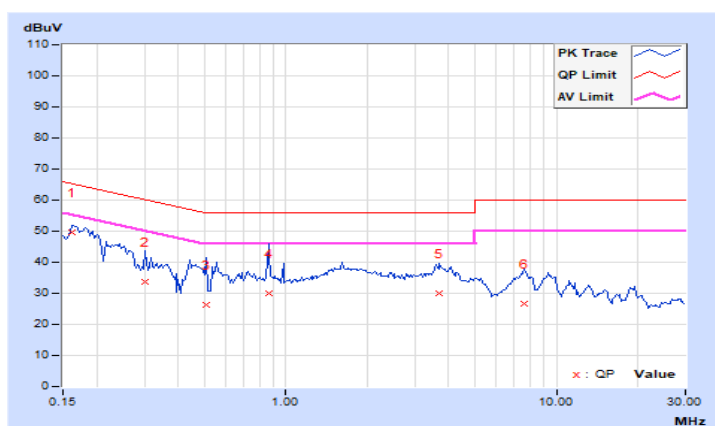

Frequency Range	150kHz ~ 30MHz	Detector Function	Quasi-Peak (QP) / Average (AV)
-----------------	----------------	-------------------	--------------------------------

Phase Of Power : Neutral (N)										
No	Frequency (MHz)	Correction Factor (dB)	Reading Value (dBuV)		Emission Level (dBuV)		Limit (dBuV)		Margin (dB)	
			Q.P.	AV.	Q.P.	AV.	Q.P.	AV.	Q.P.	AV.
1	0.18125	9.93	38.15	20.67	48.08	30.60	64.43	54.43	-16.35	-23.83
2	0.24766	9.94	32.23	13.89	42.17	23.83	61.84	51.84	-19.67	-28.01
3	0.47422	9.96	25.40	9.30	35.36	19.26	56.44	46.44	-21.08	-27.18
4	2.12500	10.06	25.63	13.64	35.69	23.70	56.00	46.00	-20.31	-22.30
5	3.72266	10.15	24.37	11.14	34.52	21.29	56.00	46.00	-21.48	-24.71
6	19.10547	11.10	26.43	20.44	37.53	31.54	60.00	50.00	-22.47	-18.46

**Remarks:**

1. Q.P. and AV. are abbreviations of quasi-peak and average individually.
2. The emission levels of other frequencies were very low against the limit.
3. Margin value = Emission level – Limit value
4. Correction factor = Insertion loss + Cable loss
5. Emission Level = Correction Factor + Reading Value

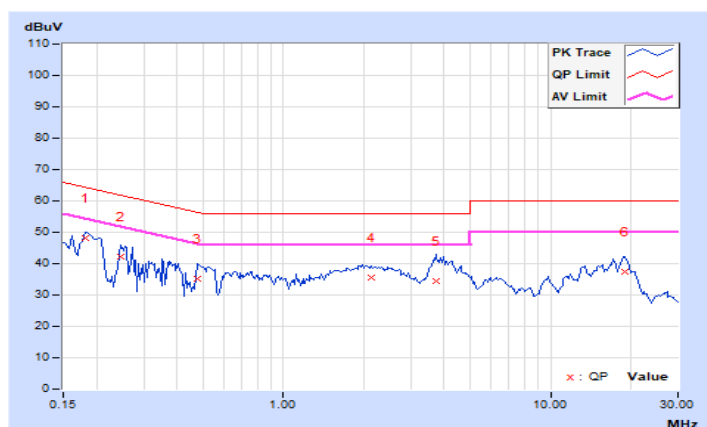

### Mode C

Frequency Range	150kHz ~ 30MHz	Detector Function	Quasi-Peak (QP) / Average (AV)
-----------------	----------------	-------------------	--------------------------------

Phase Of Power : Line (L)										
No	Frequency (MHz)	Correction Factor (dB)	Reading Value (dBuV)		Emission Level (dBuV)		Limit (dBuV)		Margin (dB)	
			Q.P.	AV.	Q.P.	AV.	Q.P.	AV.	Q.P.	AV.
1	0.16562	9.91	35.93	21.40	45.84	31.31	65.18	55.18	-19.34	-23.87
2	0.48203	9.94	29.01	13.25	38.95	23.19	56.30	46.30	-17.35	-23.11
3	0.67344	9.95	27.40	11.19	37.35	21.14	56.00	46.00	-18.65	-24.86
4	3.11328	10.10	18.00	9.16	28.10	19.26	56.00	46.00	-27.90	-26.74
5	5.10547	10.22	19.53	10.74	29.75	20.96	60.00	50.00	-30.25	-29.04
6	12.72266	10.67	16.61	9.13	27.28	19.80	60.00	50.00	-32.72	-30.20

#### Remarks:

1. Q.P. and AV. are abbreviations of quasi-peak and average individually.
2. The emission levels of other frequencies were very low against the limit.
3. Margin value = Emission level – Limit value
4. Correction factor = Insertion loss + Cable loss
5. Emission Level = Correction Factor + Reading Value

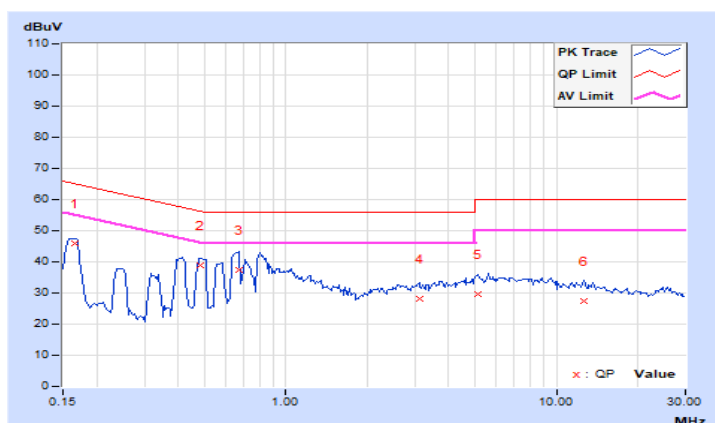

Frequency Range	150kHz ~ 30MHz	Detector Function	Quasi-Peak (QP) / Average (AV)
-----------------	----------------	-------------------	--------------------------------

Phase Of Power : Neutral (N)										
No	Frequency (MHz)	Correction Factor (dB)	Reading Value (dBuV)		Emission Level (dBuV)		Limit (dBuV)		Margin (dB)	
			Q.P.	AV.	Q.P.	AV.	Q.P.	AV.	Q.P.	AV.
1	0.16562	9.93	35.03	21.97	44.96	31.90	65.18	55.18	-20.22	-23.28
2	0.40000	9.96	27.76	12.13	37.72	22.09	57.85	47.85	-20.13	-25.76
3	0.70859	9.98	26.28	12.52	36.26	22.50	56.00	46.00	-19.74	-23.50
4	2.60156	10.09	19.23	10.12	29.32	20.21	56.00	46.00	-26.68	-25.79
5	6.34766	10.30	19.71	11.85	30.01	22.15	60.00	50.00	-29.99	-27.85
6	15.01172	10.86	16.01	8.72	26.87	19.58	60.00	50.00	-33.13	-30.42

**Remarks:**

1. Q.P. and AV. are abbreviations of quasi-peak and average individually.
2. The emission levels of other frequencies were very low against the limit.
3. Margin value = Emission level – Limit value
4. Correction factor = Insertion loss + Cable loss
5. Emission Level = Correction Factor + Reading Value

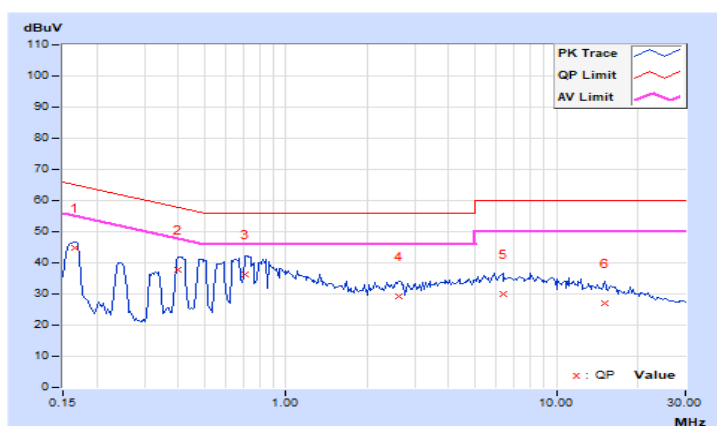

### 4.3 6dB Bandwidth Measurement

#### 4.3.1 Limits of 6dB Bandwidth Measurement

The minimum of 6dB Bandwidth Measurement is 0.5 MHz.

#### 4.3.2 Test Setup

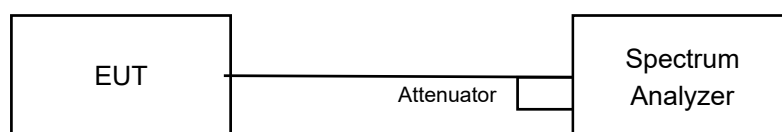

#### 4.3.3 Test Instruments

DESCRIPTION & MANUFACTURER	MODEL NO.	SERIAL NO.	CALIBRATED DATE	CALIBRATED UNTIL
ROHDE & SCHWARZ Spectrum Analyzer	FSV40	101042	Sep. 8, 2020	Sep. 7, 2021

**NOTE:** 1. The calibration interval of the above test instruments is 12 months. And the calibrations are traceable to NML/ROC and NIST/USA.  
2. Tested Date: Nov. 3, 2020

#### 4.3.4 Test Procedure

- a. Set resolution bandwidth (RBW) = 100kHz
- b. Set the video bandwidth (VBW)  $\geq 3 \times$  RBW, Detector = Peak.
- c. Trace mode = max hold.
- d. Sweep = auto couple.
- e. Measure the maximum width of the emission that is constrained by the frequencies associated with the two amplitude points (upper and lower) that are attenuated by 6 dB relative to the maximum level measured in the fundamental emission

#### 4.3.5 Deviation from Test Standard

No deviation.

#### 4.3.6 EUT Operating Conditions

The software provided by client to enable the EUT under transmission condition continuously at lowest, middle and highest channel frequencies individually.



### 4.3.7 Test Result

#### Mode A

Channel	Frequency (MHz)	6dB Bandwidth (MHz)		Minimum Limit (MHz)	Pass / Fail
		GFSK (1Mbps)	GFSK (2Mbps)		
0	2402	0.71	0.67	0.5	Pass
19	2440	0.69	0.53	0.5	Pass
39	2480	0.70	0.68	0.5	Pass

#### Spectrum Plot of Worst Value

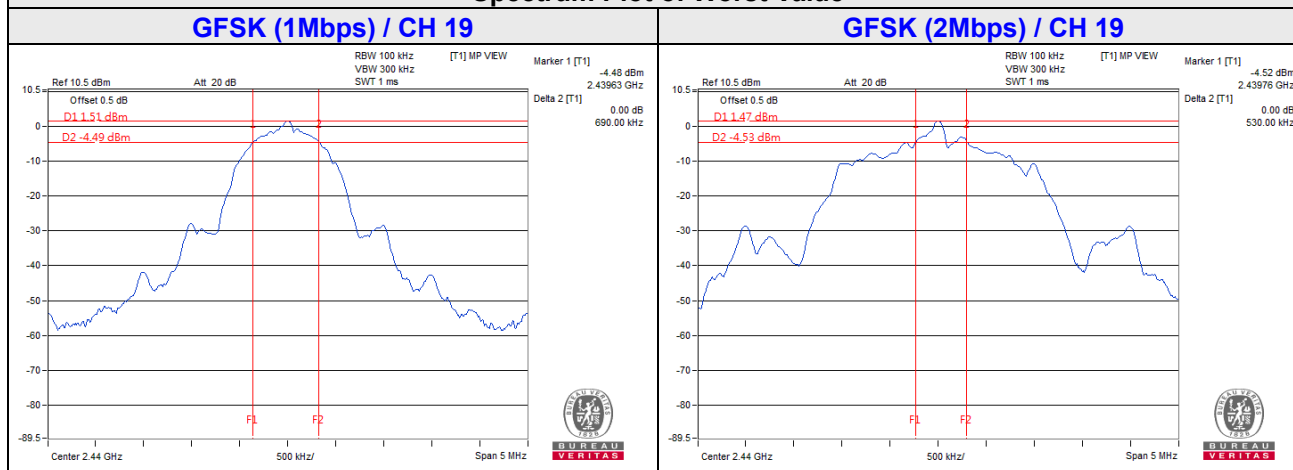

#### 4.4 Conducted Output Power Measurement

##### 4.4.1 Limits OF Conducted Output Power Measurement

For systems using digital modulation in the 2400–2483.5 MHz bands: 1 Watt (30dBm)

##### 4.4.2 Test Setup

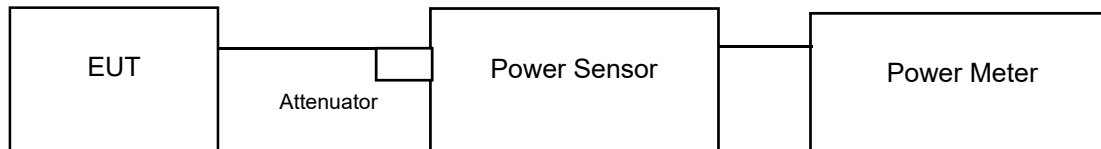

##### 4.4.3 Test Instruments

DESCRIPTION & MANUFACTURER	MODEL NO.	SERIAL NO.	CALIBRATED DATE	CALIBRATED UNTIL
Anritsu Power Sensor	MA2411B	0738404	Apr. 13, 2020	Apr. 12, 2021
Anritsu Power Meter	ML2495A	0842014	Apr. 13, 2020	Apr. 12, 2021

**NOTE:** 1. The calibration interval of the above test instruments is 12 months. And the calibrations are traceable to NML/ROC and NIST/USA.  
 2. Tested Date: Nov. 3, 2020

##### 4.4.4 Test Procedures

A peak power sensor was used on the output port of the EUT. A power meter was used to read the response of the peak power sensor. Record the power level.

Average power sensor was used to perform output power measurement, trigger and gating function of wide band power meter is enabled to measure max output power of TX on burst. Duty factor is not added to measured value.

##### 4.4.5 Deviation from Test Standard

No deviation.

##### 4.4.6 EUT Operating Conditions

Same as Item 4.3.6.

#### 4.4.7 Test Results

##### Mode A

##### FOR PEAK POWER

Channel	Frequency (MHz)	Peak Power (mW)		Peak Power (dBm)		Limit (dBm)	Pass / Fail
		GFSK (1Mbps)	GFSK (2Mbps)	GFSK (1Mbps)	GFSK (2Mbps)		
0	2402	1.754	1.762	2.44	2.46	30	Pass
19	2440	<b>1.786</b>	<b>1.786</b>	2.52	2.52	30	Pass
39	2480	1.552	1.560	1.91	1.93	30	Pass

##### FOR AVERAGE POWER

Channel	Frequency (MHz)	Average Power (mW)		Average Power (dBm)	
		GFSK (1Mbps)	GFSK (2Mbps)	GFSK (1Mbps)	GFSK (2Mbps)
0	2402	1.718	1.714	2.35	2.34
19	2440	1.754	1.758	2.44	2.45
39	2480	1.514	1.510	1.80	1.79

#### 4.5 Power Spectral Density Measurement

##### 4.5.1 Limits of Power Spectral Density Measurement

The Maximum of Power Spectral Density Measurement is 8dBm per 3 kHz.

##### 4.5.2 Test Setup

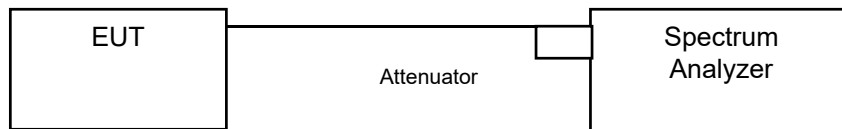

##### 4.5.3 Test Instruments

DESCRIPTION & MANUFACTURER	MODEL NO.	SERIAL NO.	CALIBRATED DATE	CALIBRATED UNTIL
ROHDE & SCHWARZ Spectrum Analyzer	FSV40	101042	Sep. 8, 2020	Sep. 7, 2021

- NOTE:** 1. The calibration interval of the above test instruments is 12 months. And the calibrations are traceable to NML/ROC and NIST/USA.  
 2. Tested Date: Nov. 3, 2020

##### 4.5.4 Test Procedure

- Set analyzer center frequency to DTS channel center frequency.
- Set the span to 1.5 times the DTS bandwidth.
- Set the RBW to:  $3 \text{ kHz} \leq \text{RBW} \leq 100 \text{ kHz}$ .
- Set the VBW  $\geq 3 \times \text{RBW}$ .
- Detector = peak.
- Sweep time = auto couple.
- Trace mode = max hold.
- Allow trace to fully stabilize.
- Use the peak marker function to determine the maximum amplitude level within the RBW.

##### 4.5.5 Deviation from Test Standard

No deviation.

##### 4.5.6 EUT Operating Condition

Same as Item 4.3.6

## 4.5.7 Test Results

### Mode A

Channel	Freq. (MHz)	PSD (dBm/3kHz)		Limit (dBm/3kHz)	Pass /Fail
		GFSK (1Mbps)	GFSK (2Mbps)		
0	2402	0.05	-3.38	8	Pass
19	2440	0.18	-3.26	8	Pass
39	2480	-0.38	-3.78	8	Pass

Spectrum Plot of Worst Value

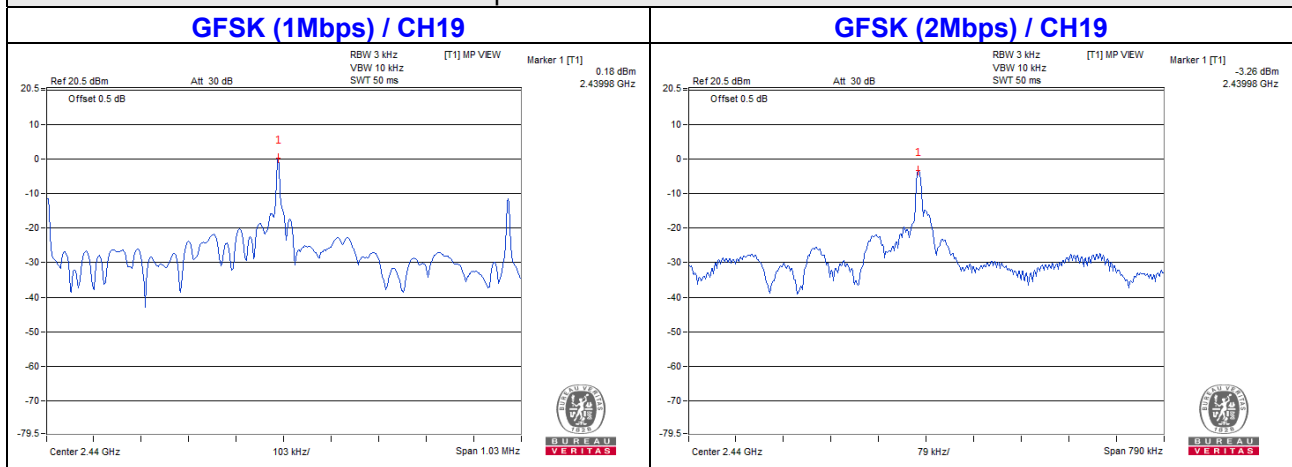

#### 4.6 Conducted Out of Band Emission Measurement

##### 4.6.1 Limits of Conducted Out of Band Emission Measurement

Below  $-20\text{dB}$  of the highest emission level of operating band (in 100kHz Resolution Bandwidth).

##### 4.6.2 Test Setup

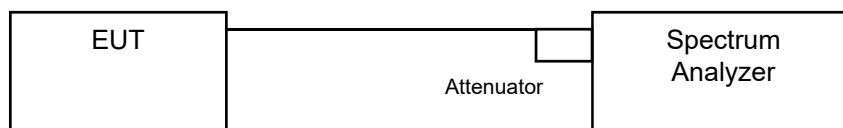

##### 4.6.3 Test Instruments

DESCRIPTION & MANUFACTURER	MODEL NO.	SERIAL NO.	CALIBRATED DATE	CALIBRATED UNTIL
ROHDE & SCHWARZ Spectrum Analyzer	FSV40	101042	Sep. 8, 2020	Sep. 7, 2021

- NOTE:** 1. The calibration interval of the above test instruments is 12 months. And the calibrations are traceable to NML/ROC and NIST/USA.  
 2. Tested Date: Nov. 3, 2020

##### 4.6.4 Test Procedure

###### MEASUREMENT PROCEDURE REF

1. Set the RBW = 100 kHz.
2. Set the VBW  $\geq$  300 kHz.
3. Detector = peak.
4. Sweep time = auto couple.
5. Trace mode = max hold.
6. Allow trace to fully stabilize.
7. Use the peak marker function to determine the maximum power level in any 100 kHz band segment within the fundamental EBW.

###### MEASUREMENT PROCEDURE OOB

1. Set RBW = 100 kHz.
2. Set VBW  $\geq$  300 kHz.
3. Detector = peak.
4. Sweep = auto couple.
5. Trace Mode = max hold.
6. Allow trace to fully stabilize.
7. Use the peak marker function to determine the maximum amplitude level.

##### 4.6.5 Deviation from Test Standard

No deviation.

##### 4.6.6 EUT Operating Condition

Same as Item 4.3.6

### 4.6.7 Test Results

#### Mode A GFSK (1Mbps)

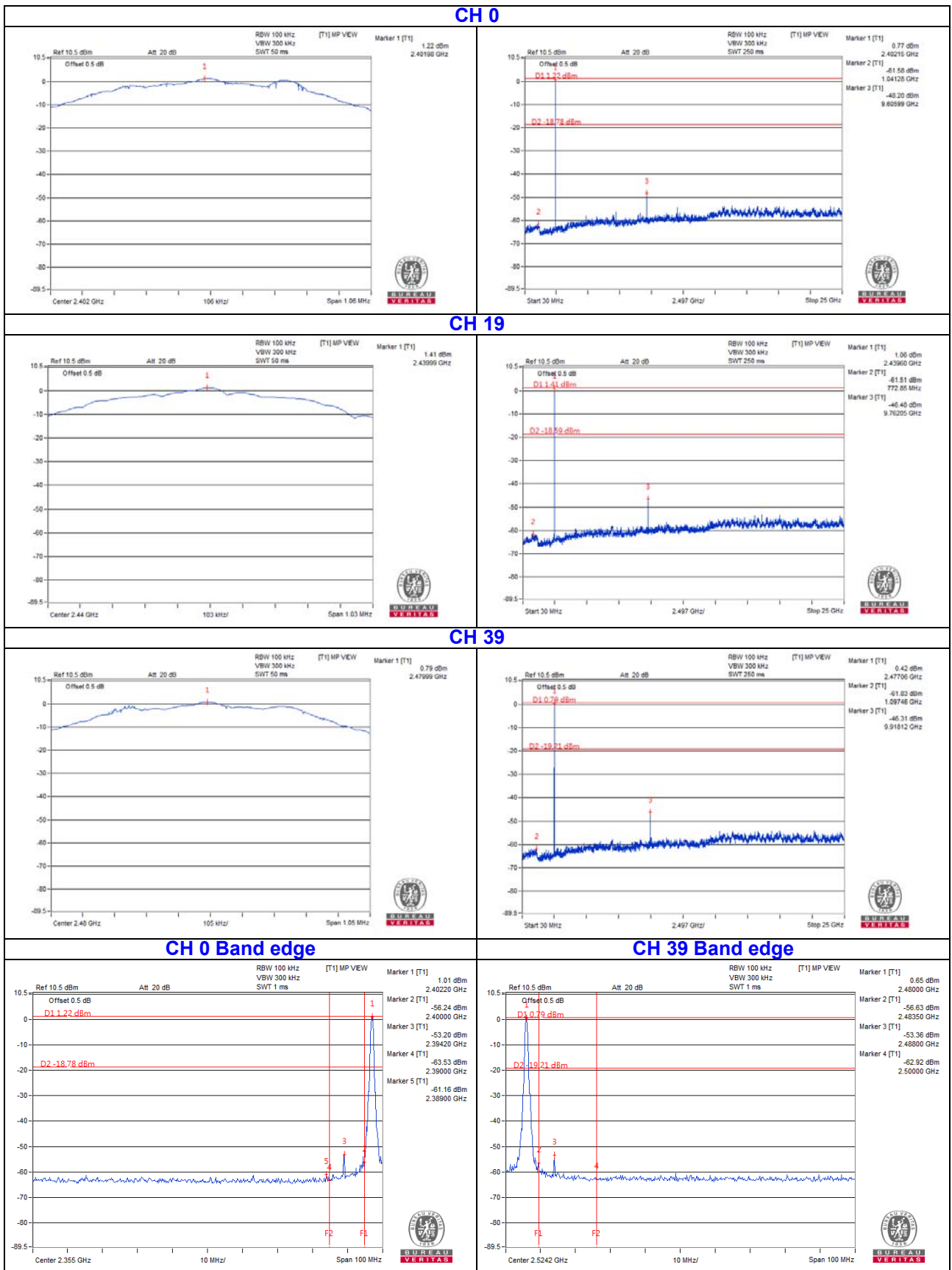

# GFSK (2Mbps)

## CH 0

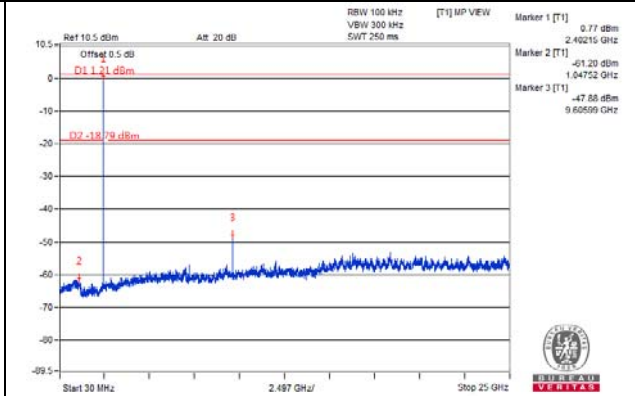
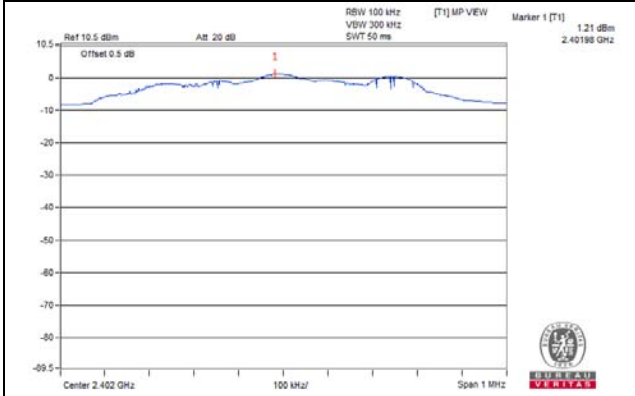

## CH 19

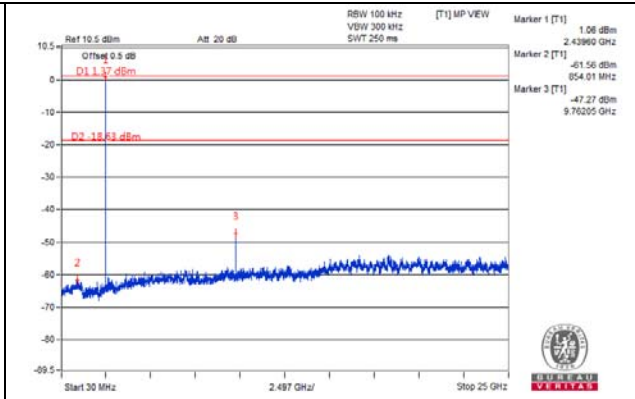
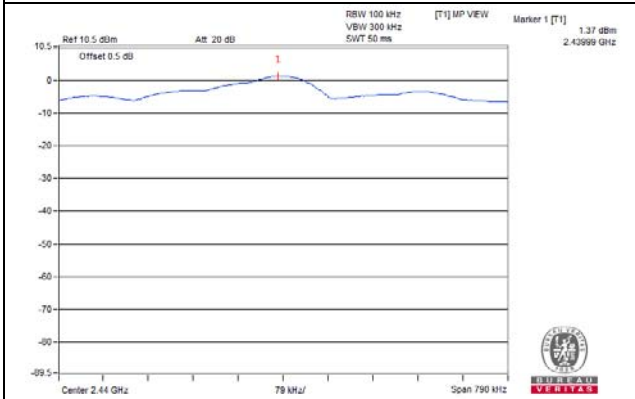

## CH 39

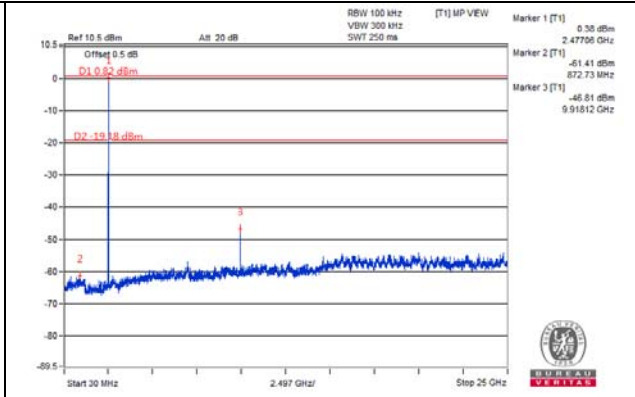
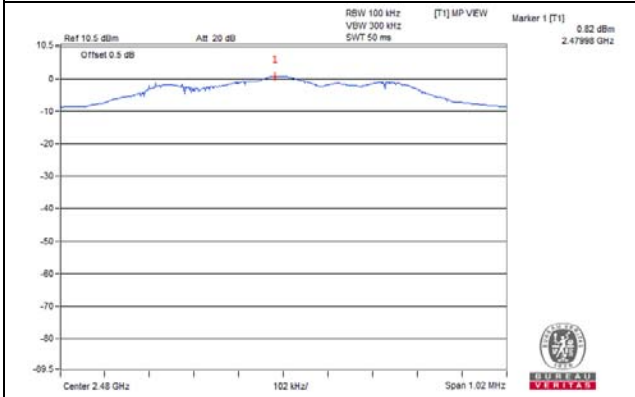

## CH 0 Band edge

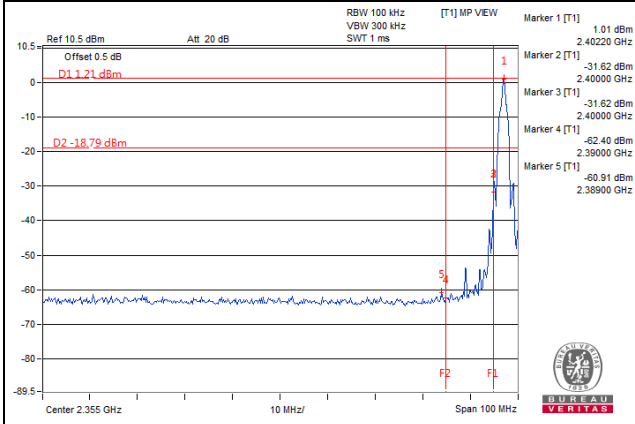

## CH 39 Band edge

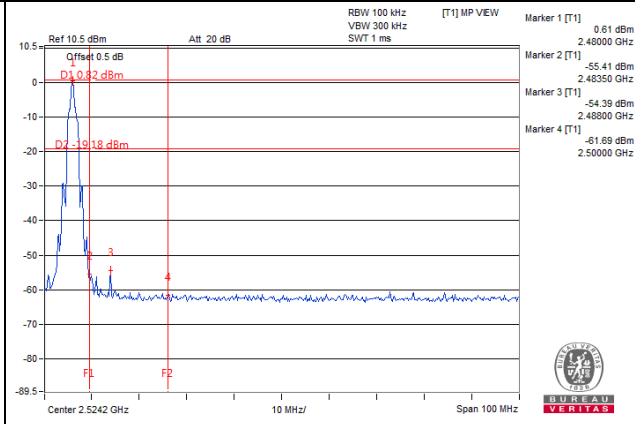



**Annex A- Band Edge Measurement**  
**Mode A**  
**GFSK (1Mbps)**

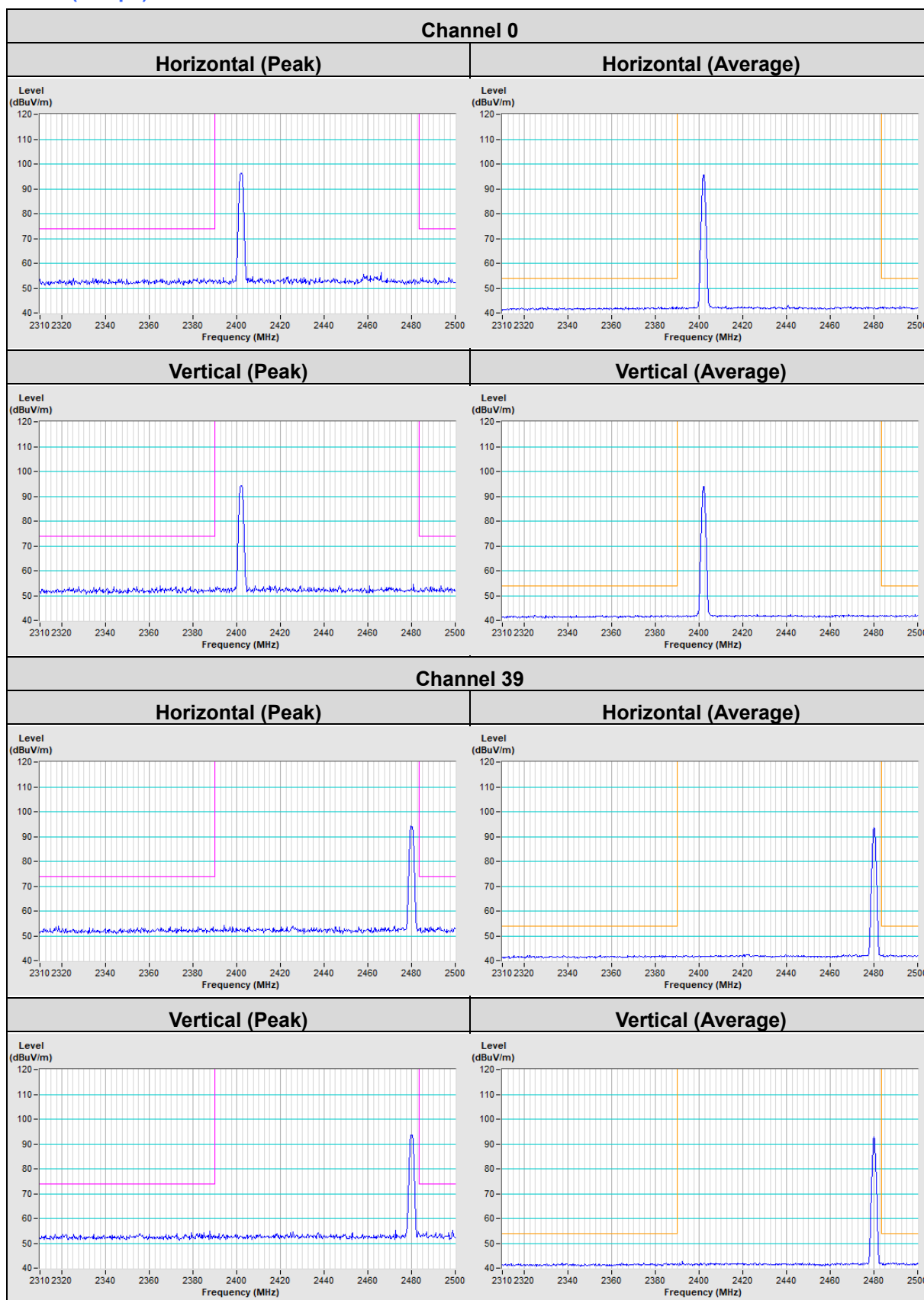

### GFSK (2Mbps)

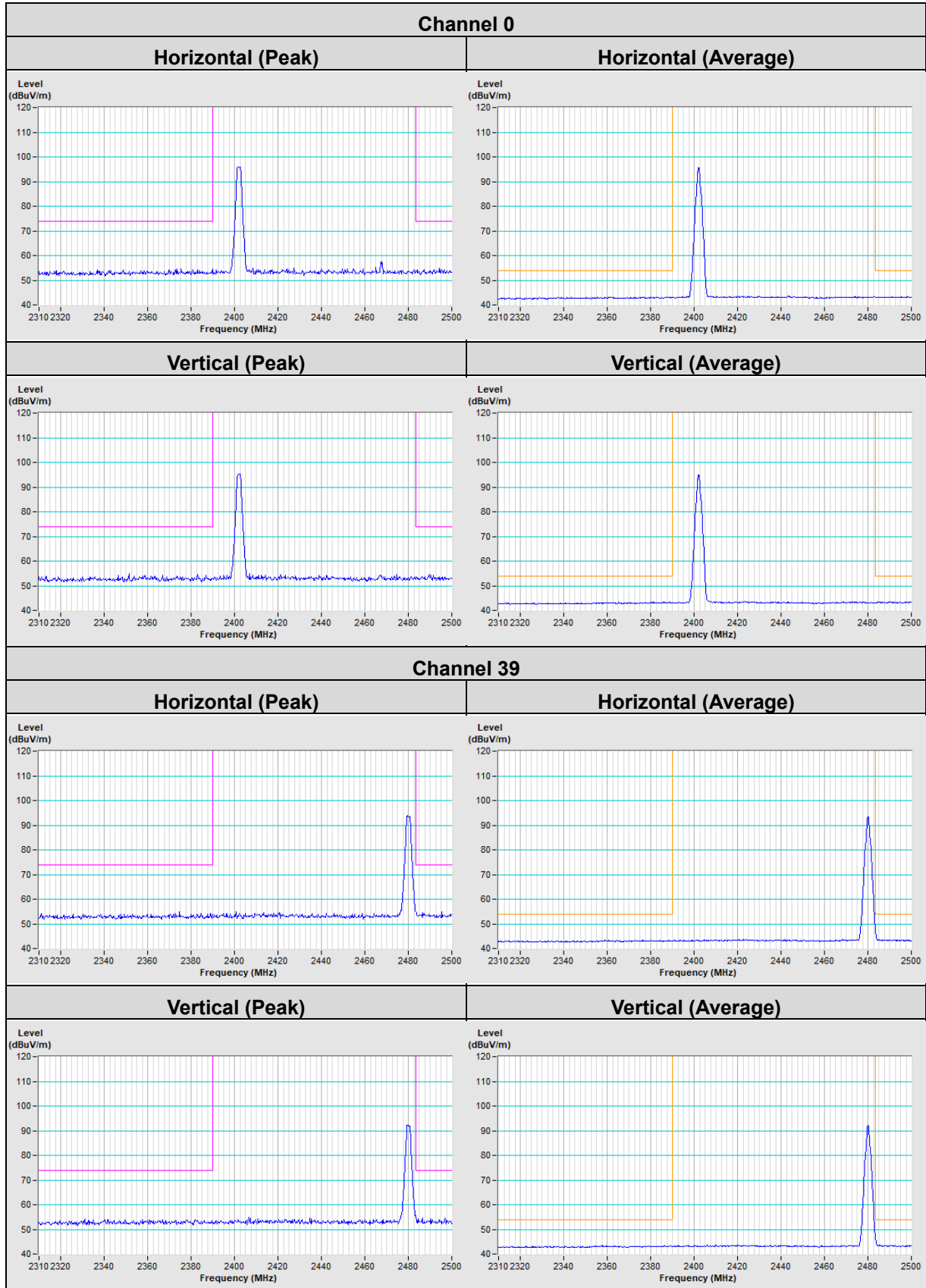

## 5 Pictures of Test Arrangements

Please refer to the attached file (Test Setup Photo).

## Appendix – Information of the Testing Laboratories

We, Bureau Veritas Consumer Products Services (H.K.) Ltd., Taoyuan Branch, were founded in 1988 to provide our best service in EMC, Radio, Telecom and Safety consultation. Our laboratories are FCC recognized accredited test firms and accredited according to ISO/IEC 17025.

If you have any comments, please feel free to contact us at the following:

**Lin Kou EMC/RF Lab**

Tel: 886-2-26052180

Fax: 886-2-26051924

**Hsin Chu EMC/RF/Telecom Lab**

Tel: 886-3-6668565

Fax: 886-3-6668323

**Hwa Ya EMC/RF/Safety Lab**

Tel: 886-3-3183232

Fax: 886-3-3270892

**Email:** [service.adt@tw.bureauveritas.com](mailto:service.adt@tw.bureauveritas.com)

**Web Site:** [www.bureauveritas-adt.com](http://www.bureauveritas-adt.com)

The address and road map of all our labs can be found in our web site also.

--- END ---