



RADIO TEST REPORT

Report No: STS1710209W02

Issued for

GuangZhou SunFieldAimo Electronic Technology Co., Ltd

801-L room, 143 Bailing Business Building, Liurong Road,
Guangzhou City, China

Product Name:	Cinegears Wireless Trigger Transmitter
Brand Name:	CINEGEARS
Test Model Name:	CG-1430
Series Model:	N/A
FCC ID:	2AM4ZCG-1430
Test Standard:	FCC Part 15.231

Any reproduction of this document must be done in full. No single part of this document may be reproduced without permission from STS, All Test Data Presented in this report is only applicable to presented Test sample.





TEST REPORT CERTIFICATION

Applicant's name: GuangZhou SunFieldAimo Electronic Technology Co., Ltd

Address: 801-L room, 143 Bailing Business Building, Liurong Road, Guangzhou City, China

Manufacture's Name.....: GuangZhou SunFieldAimo Electronic Technology Co., Ltd

Address: 801-L room, 143 Bailing Business Building, Liurong Road, Guangzhou City, China

Product description

Product name: Cinegears Wireless Trigger Transmitter

Trade mark: CINEGEARS

Test model name: CG-1430

Series model.....: N/A

Standards.....: FCC Part 15.231

Test procedure.....: ANSI C63.10-2013

This device described above has been tested by STS, the test results show that the equipment under test (EUT) is in compliance with the FCC requirements. And it is applicable only to the tested sample identified in the report.

This report shall not be reproduced except in full, without the written approval of STS, this document may be altered or revised by STS, personal only, and shall be noted in the revision of the document.

Date of Test

Date of performance of tests..... 27 Oct. 2017 ~ 01 Nov. 2017

Date of Issue 03 Nov. 2017

Test Result..... Pass

Testing Engineer :

Sean She

(Sean she)

Technical Manager :

Hakim.hou

(Hakim.hou)

Authorized Signatory :

Vita Li

(Vita Li)





TABLE OF CONTENTS	Page
1. SUMMARY OF TEST RESULTS	6
1.1 TEST FACTORY	6
1.2 MEASUREMENT UNCERTAINTY	6
2. GENERAL INFORMATION	7
2.1 GENERAL DESCRIPTION OF EUT	7
2.2 DESCRIPTION OF TEST MODES	8
2.3 BLOCK DIGRAM SHOWING THE CONFIGURATION OF SYSTEM TESTED	8
2.4 DESCRIPTION OF SUPPORT UNITS	9
2.5 EQUIPMENTS LIST FOR ALL TEST ITEMS	10
3. EMC EMISSION TEST	11
3.1 CONDUCTED EMISSION MEASUREMENT	11
3.2 TEST PROCEDURE	12
3.3 TEST SETUP	12
3.4 EUT OPERATING CONDITIONS	12
3.5 TEST RESULTS	13
4. RADIATED EMISSION MEASUREMENT	15
4.1 RADIATED EMISSION LIMITS	15
4.2 TEST PROCEDURE	16
4.3 DEVIATION FROM TEST STANDARD	16
4.4 TEST SETUP	17
4.5 EUT OPERATING CONDITIONS	17
4.6 TEST RESULTS	18
4.7 FIELD STRENGTH CALCULATION	19
4.8 TEST RESULTS	19
5. BANDWIDTH TEST	23
5.1 APPLIED PROCEDURES / LIMIT	23
5.2 TEST REQUIREMENTS	23
5.3 TEST PROCEDURE	23
5.4 TEST SETUP	23
5.5 EUT OPERATION CONDITIONS	23
5.6 TEST RESULTS	24
6. DUTY CYCLE	25
6.1 TEST PROCEDURE	25
6.2 TEST SETUP	25
6.3 EUT OPERATION CONDITIONS	25



TABLE OF CONTENTS	Page
6.4 TEST RESULTS	26
7. AUTOMATICALLY DEACTIVATE	27
7.1 STANDARD REQUIREMENT	27
7.2 TEST PROCEDURE	27
8. ANTENNA REQUIREMENT	29
8.1 STANDARD REQUIREMENT	29
8.2 EUT ANTENNA	29
APPENDIX 1- PHOTOS OF TEST SETUP	30





Revision History

Rev.	Issue Date	Report NO.	Effect Page	Contents
00	03 Nov. 2017	STS1710209W02	ALL	Initial Issue





1. SUMMARY OF TEST RESULTS

Test procedures according to the technical standards:

FCC Part 15.231, Subpart C			
Standard Section	Test Item	Judgment	Remark
15.207	Conducted Emission	N/A	--
15.205(a)/15.209/ 15.231.(b)	Radiated Spurious Emission	PASS	--
15.231(a)(1)/ 15.231(b)(2)	Transmission requirement	PASS	--
15.231(C)	20 dB Bandwidth	PASS	--
15.203	Antenna Requirement	PASS	--

NOTE: (1)"N/A" denotes test is not applicable in this Test Report

(2) All tests are according to ANSI C63.10-2013

1.1 TEST FACTORY

Shenzhen STS Test Services Co., Ltd.
1/F., Building B, Zhuoke Science Park, No.190, Chongqing Road,
Fuyong Street, Bao'an District, Shenzhen, Guangdong, China
CNAS Registration No.: L7649; FCC Registration No.: 625569

IC Registration No.: 12108A; A2LA Certificate No.: 4338.01;

1.2 MEASUREMENT UNCERTAINTY

The reported uncertainty of measurement $y \pm U$, where expanded uncertainty U is based on a standard uncertainty multiplied by a coverage factor of $k=2$, providing a level of confidence of approximately 95%.

No.	Item	Uncertainty
1	Conducted Emission (9KHz-150KHz)	± 2.88 dB
2	Conducted Emission (150KHz-30MHz)	± 2.67 dB
3	RF power,conducted	± 0.71 dB
4	Spurious emissions,conducted	± 0.63 dB
5	All emissions,radiated (9KHz-30MHz)	± 3.02 dB
6	All emissions,radiated (30MHz-200MHz)	± 3.80 dB
7	All emissions,radiated (200MHz-1000MHz)	± 3.97 dB



2. GENERAL INFORMATION

2.1 GENERAL DESCRIPTION OF EUT

Equipment	Cinegears Wireless Trigger Transmitter
Trade Name	CINEGEARS
Model Name	CG-1430
Series Model	N/A
Model Difference	N/A
Frequency band	917MHz
Power Rating	DC 3.7 V from battery
Hardware version number	201705
Software version number	201705

Note:

1. For a more detailed features description, please refer to the manufacturer's specifications or the User's Manual.

2. Table for filed Antenna

Ant.	Brand	Model Name	Antenna Type	Connector	Gain (dBi)	NOTE
1	CINEGEARS	CG-1430	Omnidirectional Ant.	N/A	0	Antenna

The EUT antenna is PCB Antenna. No antenna other than that furnished by the responsible party shall be used with the device.



2.2 DESCRIPTION OF TEST MODES

To investigate the maximum EMI emission characteristics generated from EUT, the test system was pre-scanning tested based on the consideration of following EUT operation mode or test configuration mode which possibly have effect on EMI emission level. Each of these EUT operation mode(s) or test configuration mode(s) mentioned above was evaluated respectively.

Pretest Mode	Description
Mode 1	TX Mode

	For Radiated Emission
Final Test Mode	Description
Mode 1	TX Mode

2.3 BLOCK DIAGRAM SHOWING THE CONFIGURATION OF SYSTEM TESTED

During test, Keep EUT is in continuous transmission mode, Both open button and closed button have been tested, The two keys were tested to assess and only record the worst case in the report(Open button).



E-1
EUT



2.4 DESCRIPTION OF SUPPORT UNITS

The EUT has been tested as an independent unit together with other necessary accessories or support units. The following support units or accessories were used to form a representative test configuration during the tests.

Item	Equipment	Mfr/Brand	Model/Type No.	Serial No.	Note
N/A	N/A	N/A	N/A	N/A	N/A

Item	Shielded Type	Ferrite Core	Length	Note
N/A	N/A	N/A	N/A	N/A

Note:

(1)The support equipment was authorized by Declaration of Confirmation.

(2)For detachable type I/O cable should be specified the length in cm in 『Length』 column.



2.5 EQUIPMENTS LIST FOR ALL TEST ITEMS

Radiation Test equipment

Kind of Equipment	Manufacturer	Type No.	Serial No.	Last calibration	Calibrated until
EMI Test Receiver	R&S	ESW	101535	2017.06.01	2018.05.31
Bilog Antenna	TESEQ	CBL6111D	34678	2017.03.24	2018.03.23
Horn Antenna	Schwarzbeck	BBHA 9120D (1201)	9120D-1343	2017.03.06	2018.03.05
PreAmplifier (1G-26.5GHz)	Agilent	8449B	60538	2017.10.15	2018.10.14
Operational Manual Passive Loop (9K--30MHz)	ETS	6512	00165355	2017.03.06	2018.03.05
Low frequency cable	EM	R01	N/A	2017.03.12	2018.03.11
Low frequency cable	EM	R06	N/A	2017.03.12	2018.03.11
High frequency cable	SCHWARZBECK	R04	N/A	2017.03.12	2018.03.11
High frequency cable	SCHWARZBECK	R02	N/A	2017.03.12	2018.03.11
Pre-mpifier (0.1M-3GHz)	EM	EM330	60538	2017.03.12	2018.03.11
Semi-anechoic chamber	Changling	966	N/A	2017.10.15	2018.10.14

Conduction Test equipment

Kind of Equipment	Manufacturer	Type No.	Serial No.	Last calibration	Calibrated until
Test Receiver	R&S	ESCI	101427	2017.10.15	2018.10.14
LISN	R&S	ENV216	101242	2017.10.15	2018.10.14
conduction Cable	EM	C01	N/A	2017.03.12	2018.03.11
Temperature & Humidity	Mieo	HH660	N/A	2017.10.15	2018.10.14

Note: The temporary antenna connector is soldered on the PCB board in order to perform conducted tests and this temporary antenna connector is listed in the equipment list.



3. EMC EMISSION TEST

3.1 CONDUCTED EMISSION MEASUREMENT

3.1.1 POWER LINE CONDUCTED EMISSION LIMITS

operating frequency band. In case the emission fall within the restricted band specified on Part 15. 207(a) limit in the table below has to be followed.

FREQUENCY (MHz)	Class B (dBuV)		Standard
	Quasi-peak	Average	
0.15 -0.5	66 - 56 *	56 - 46 *	CISPR
0.50 -5.0	56.00	46.00	CISPR
5.0 -30.0	60.00	50.00	CISPR

0.15 -0.5	66 - 56 *	56 - 46 *	FCC
0.50 -5.0	56.00	46.00	FCC
5.0 -30.0	60.00	50.00	FCC

Note:

- (1) The tighter limit applies at the band edges.
- (2) The limit of " * " marked band means the limitation decreases linearly with the logarithm of the frequency in the range.

The following table is the setting of the receiver

Receiver Parameters	Setting
Attenuation	10 dB
Start Frequency	0.15 MHz
Stop Frequency	30 MHz
IF Bandwidth	9 kHz

3.2 TEST PROCEDURE

- a. The EUT was placed 0.8 meters from the horizontal ground plane with EUT being connected to the power mains through a line impedance stabilization network (LISN). All other support equipments powered from additional LISN(s). The LISN provide 50 Ohm/ 50uH of coupling impedance for the measuring instrument.
- b. Interconnecting cables that hang closer than 40 cm to the ground plane shall be folded back and forth in the center forming a bundle 30 to 40 cm long.
- c. I/O cables that are not connected to a peripheral shall be bundled in the center. The end of the cable may be terminated, if required, using the correct terminating impedance. The overall length shall not exceed 1 m.
- d. LISN at least 80 cm from nearest part of EUT chassis.
- e. For the actual test configuration, please refer to the related Item –EUT Test Photos.

3.3 TEST SETUP

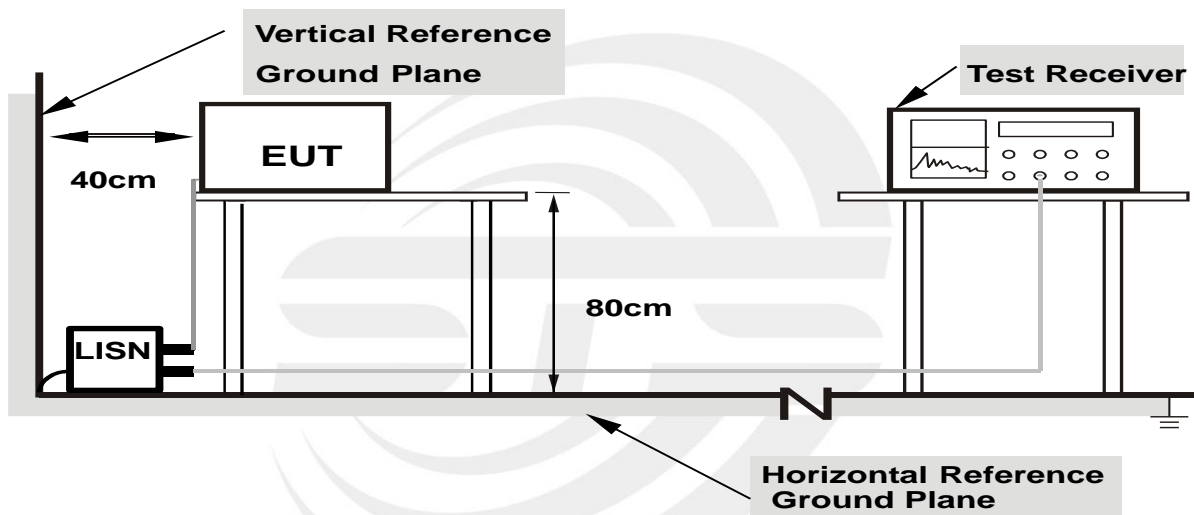

- Note: 1. Support units were connected to second LISN.**
2. Both of LISNs (AMN) are 80 cm from EUT and at least 80 cm from other units and other metal planes

3.4 EUT OPERATING CONDITIONS

The EUT was configured for testing in a typical fashion (as a customer would normally use it). The EUT has been programmed to continuously transmit during test. This operating condition was tested and used to collect the included data.



3.5 TEST RESULTS

Temperature:	26 °C	Relative Humidity:	63%
Pressure:	1010hPa	Phase:	L
Test Voltage:	AC 120V/60Hz	Test Mode:	TX

Frequency (MHz)	Reading (dBuV)	Correct Factor(dB)	Result (dBuV)	Limit (dBuV)	Margin (dB)	Remark
0.1740	51.66	9.79	61.45	64.77	-3.32	QP
0.1740	36.26	9.79	46.05	54.77	-8.72	AVG
0.2380	43.77	9.95	53.72	62.17	-8.45	QP
0.2380	18.60	9.95	28.55	52.17	-23.62	AVG
0.4820	29.17	10.03	39.20	56.30	-17.10	QP
0.4820	5.00	10.03	15.03	46.30	-31.27	AVG
0.9020	24.34	9.82	34.16	56.00	-21.84	QP
0.9020	7.61	9.82	17.43	46.00	-28.57	AVG
3.1220	33.10	9.81	42.91	56.00	-13.09	QP
3.1220	12.14	9.81	21.95	46.00	-24.05	AVG
9.2260	38.35	10.13	48.48	60.00	-11.52	QP
9.2260	26.00	10.13	36.13	50.00	-13.87	AVG

Remark:

1. All readings are Quasi-Peak and Average values.
2. Margin = Result (Result = Reading + Factor) - Limit

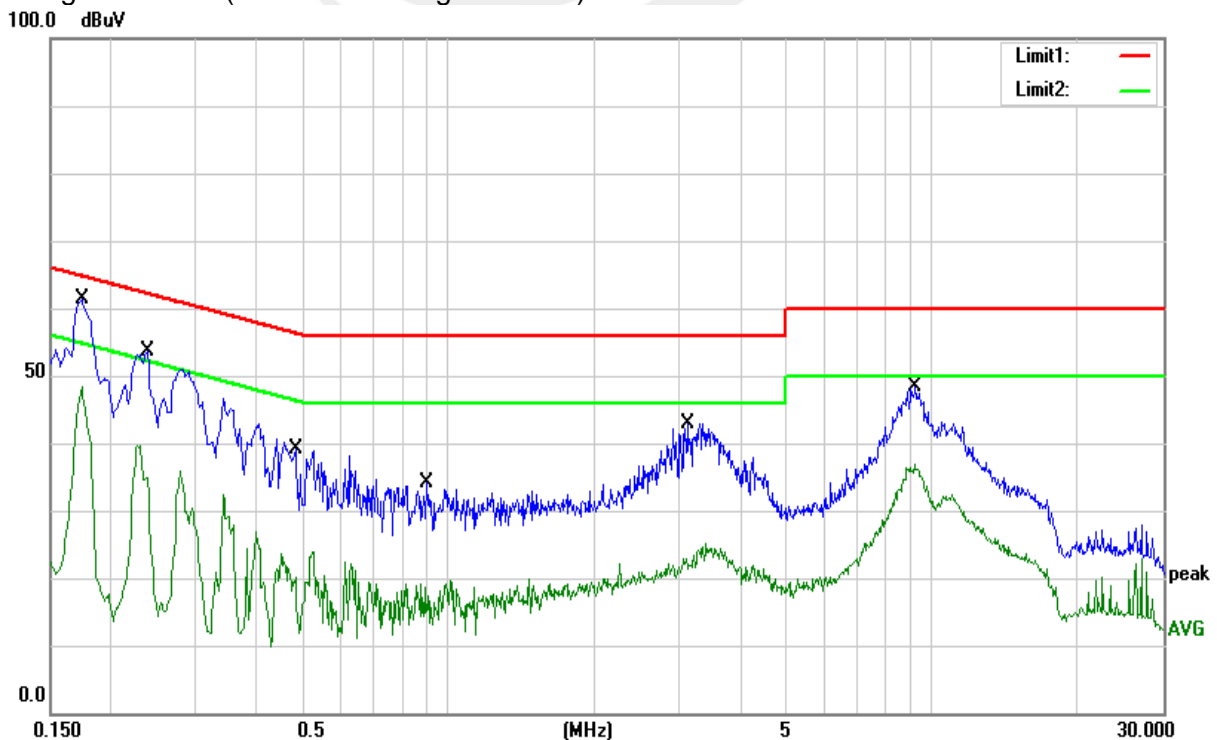



Temperature:	26 °C	Relative Humidity:	63%
Pressure:	1010hPa	Phase:	N
Test Voltage:	AC 120V/60Hz	Test Mode:	TX

Frequency (MHz)	Reading (dBuV)	Correct Factor(dB)	Result (dBuV)	Limit (dBuV)	Margin (dB)	Remark
0.1660	50.42	9.79	60.21	65.16	-4.95	QP
0.1660	31.04	9.79	40.83	55.16	-14.33	AVG
0.2341	42.76	10.01	52.77	62.30	-9.53	QP
0.2341	26.37	10.01	36.38	52.30	-15.92	AVG
0.4460	32.53	10.02	42.55	56.95	-14.40	QP
0.4460	11.33	10.02	21.35	46.95	-25.60	AVG
0.9740	21.92	9.81	31.73	56.00	-24.27	QP
0.9740	4.35	9.81	14.16	46.00	-31.84	AVG
3.5740	31.27	9.93	41.20	56.00	-14.80	QP
3.5740	13.05	9.93	22.98	46.00	-23.02	AVG
9.2820	38.73	9.92	48.65	60.00	-11.35	QP
9.2820	25.67	9.92	35.59	50.00	-14.41	AVG

Remark:

1. All readings are Quasi-Peak and Average values.
2. Margin = Result (Result = Reading + Factor) - Limit

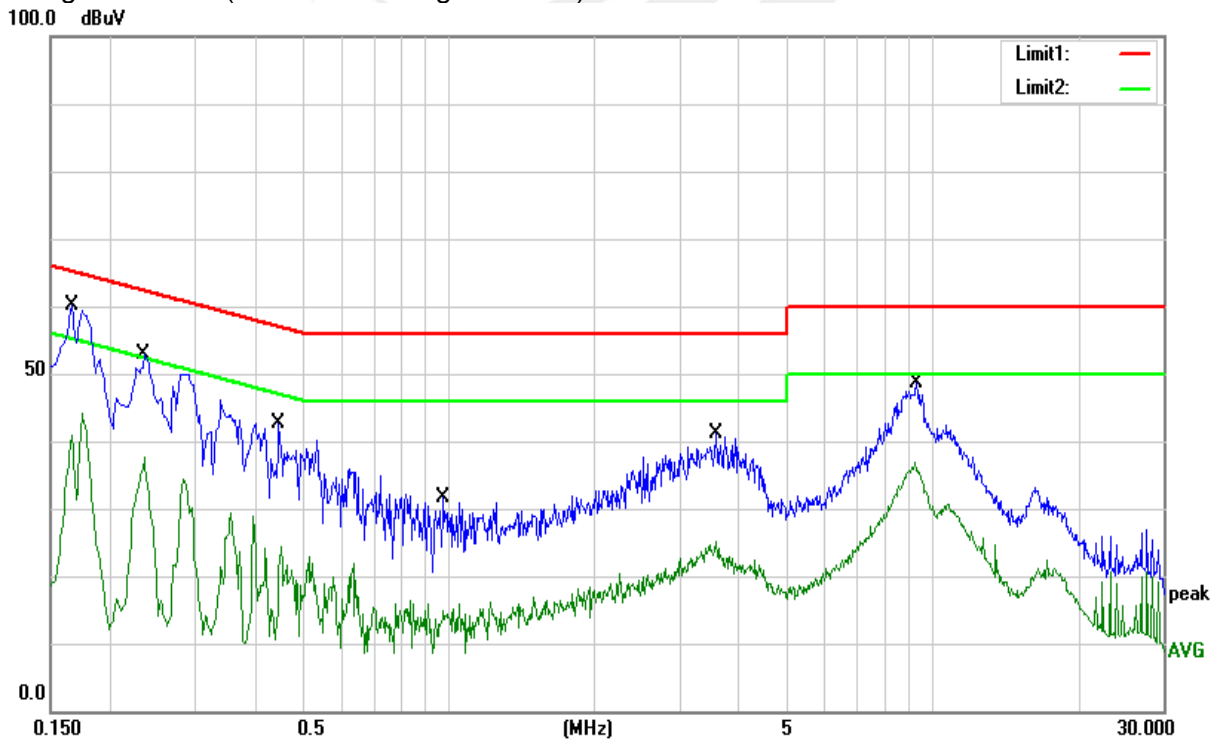



4. RADIATED EMISSION MEASUREMENT

4.1 RADIATED EMISSION LIMITS

In case the emission fall within the restricted band specified on Part 15.205(a), then the Part 15.209(a) and Part 15.231(b) limit in the table below has to be followed.

LIMITS OF RADIATED EMISSION MEASUREMENT (0.009MHz - 1000MHz)

Frequencies (MHz)	Field Strength (microvolts/meter)	Measurement Distance (meters)
0.009~0.490	2400/F(KHz)	300
0.490~1.705	24000/F(KHz)	30
1.705~30.0	30	30
30~40.66	100	3
40.70~70	100	3

Fundamental Frequency (MHz)	Field Strength of fundamental (microvolts/meter)	Field Strength of Unwanted Emissions (microvolts/meter)
40.66~40.70	2,250	225
70~130	1,250	125
130~174	1,250 to 3,750**	125 to 375**
174~260	3750	375
260~470	3,750 to 12,500**	375 to 1,250**
Above 470	12,500	1,250

LIMITS OF RADIATED EMISSION MEASUREMENT (Above 1000MHz)

FREQUENCY (MHz)	Class B (dBuV/m) (at 3M)	
	PEAK	AVERAGE
Above 1000	74	54

NOTE:

- (1) The limit for radiated test was performed according to FCC PART 15C.
- (2) Emission level (dBuV/m) = 20log Emission level (uV/m).



Spectrum Parameter	Setting
Detector	Peak
Attenuation	Auto
Start Frequency	1000 MHz
Stop Frequency	10th carrier harmonic
RB / VB (emission in restricted band)	1 MHz / 3 MHz

Receiver Parameter	Setting
Attenuation	Auto
Start ~ Stop Frequency	9kHz~90kHz / RB 200Hz for PK & AV
Start ~ Stop Frequency	90kHz~110kHz / RB 200Hz for QP
Start ~ Stop Frequency	110kHz~490kHz / RB 200Hz for PK & AV
Start ~ Stop Frequency	490kHz~30MHz / RB 9kHz for QP
Start ~ Stop Frequency	30MHz~1000MHz / RB 120kHz for QP

4.2 TEST PROCEDURE

- a. The test is performed in a 3m Semi-Anechoic Chamber; the antenna factor, cable loss and so on of the site (factors) is calculated to correct the reading. The EUT is placed on a 0.8m high insulating Turn Table, and keeps 3m away from the Test Antenna, which is mounted on a variable-height antenna master tower.
During test, The table was rotated 360 degrees to determine the position of the highest radiation.
- b. In the frequency range of 9KHz to 30MHz, magnetic field is measured with Loop Test Antenna. The Test Antenna is positioned with its plane vertical at 1m distance from the EUT. The center of the Loop Test Antenna is 1m above the ground. During the measurement the Loop Test Antenna rotates about its vertical axis for maximum response at each azimuth about the EUT.
- c. In the frequency range 30MHz-1GHz, Bi-Log Test Antenna used. Test Antenna is 3m away from the EUT. Test Antenna height is varied from 1m to 4m above the ground to determine the maximum value of the field strength. The emission levels at both horizontal and vertical polarizations should be tested.
- d. In the frequency above 1GHz, Place the measurement antenna 3m away from the EUT for each area of the EUT determined to be a source of emissions at the specified measurement distance, while keeping the measurement antenna aimed at the source of emissions at each frequency of significant emissions, with polarization oriented for maximum response. The measurement antenna elevation for maximum emissions shall be restricted to a range of heights of from 1 m to 4 m above the ground or reference ground plane.
- f. The initial step in collecting conducted emission data is a spectrum analyzer peak detector mode pre-scanning the measurement frequency range. Significant peaks are then marked and then Quasi Peak detector mode re-measured.
- g. If the Peak Mode measured value compliance with and lower than Quasi Peak Mode Limit, the EUT shall be deemed to meet QP Limits and then no additional QP Mode measurement performed.
- h. For the actual test configuration, please refer to the related Item –EUT Test Photos.

Both horizontal and vertical antenna polarities and performed pretest to three orthogonal axis were tested. The worst case emissions were reported

4.3 DEVIATION FROM TEST STANDARD

No deviation

4.4 TEST SETUP

(A) Radiated Emission Test-Up Frequency Below 30MHz

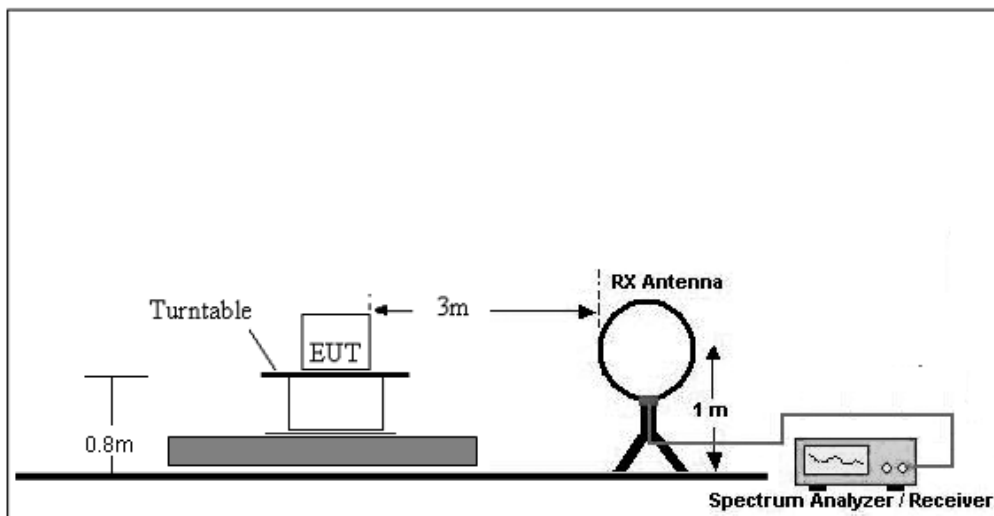

(B) Radiated Emission Test-Up Frequency 30MHz~1GHz

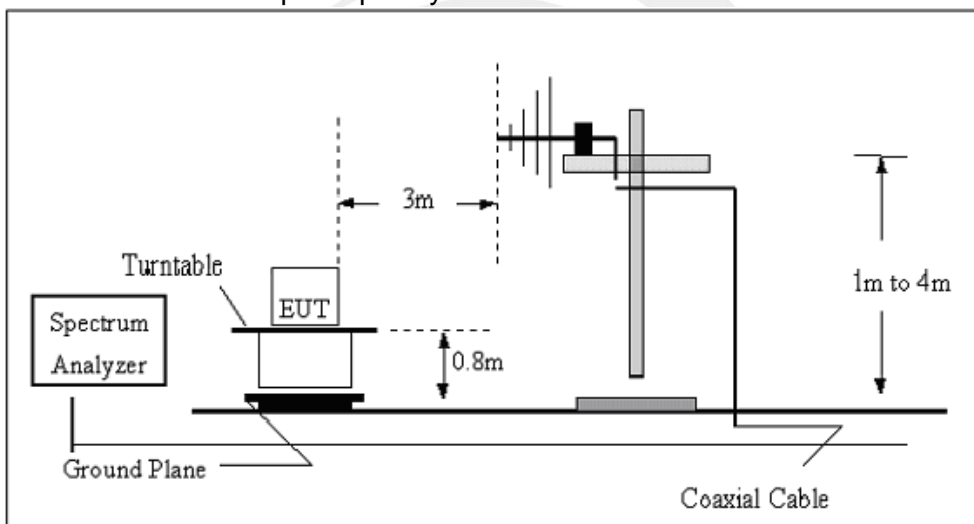

(C) Radiated Emission Test-Up Frequency Above 1GHz

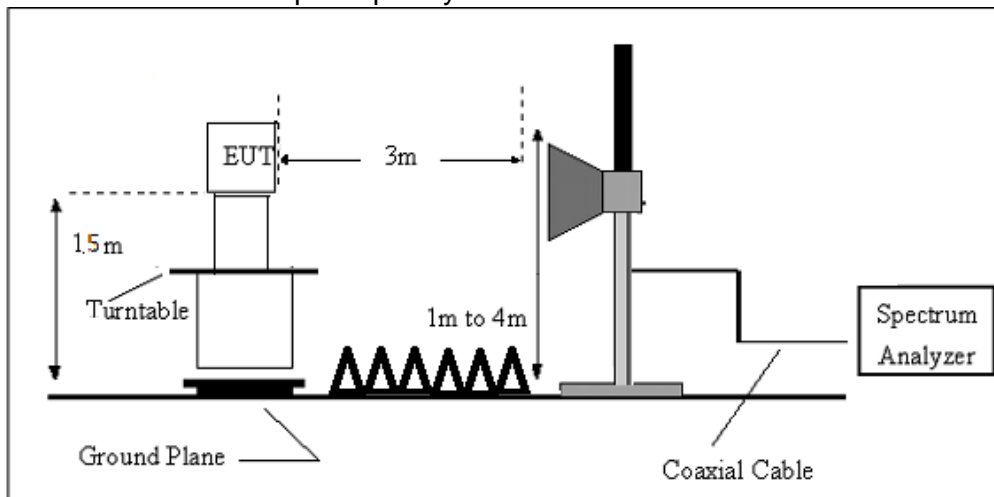

4.5 EUT OPERATING CONDITIONS

The EUT tested system was configured as the statements of 2.4 Unless otherwise a special operating condition is specified in the follows during the testing.

4.6 TEST RESULTS

INTRODUCTION TO PDCF

reference: (§15.35 Measurement detector functions and bandwidths.)

- a. Part 15 of the FCC Rules provides for the operation of low power communication devices without an individual license (e.g., intrusion detectors, pulsed water tank level gauges, etc.), subject to certain requirements. Some of these devices use extremely narrow pulses to generate wideband emissions, which are measured to determine compliance with the rules. These measurements are typically performed with a receiver or spectrum analyzer. Depending on a number of factors (e.g., resolution bandwidth, pulsewidth, etc.), the spectrum analyzer may not always display the true peak value of the measured emission. This effect, called “pulse desensitization,” relates to the capabilities of the measuring instrument. For the measurement and reporting of the true peak of pulsed emissions, it may be necessary to apply a “pulse desensitization correction factor” (PDCF) to the measured value, pursuant to 47 CFR 15.35(a).

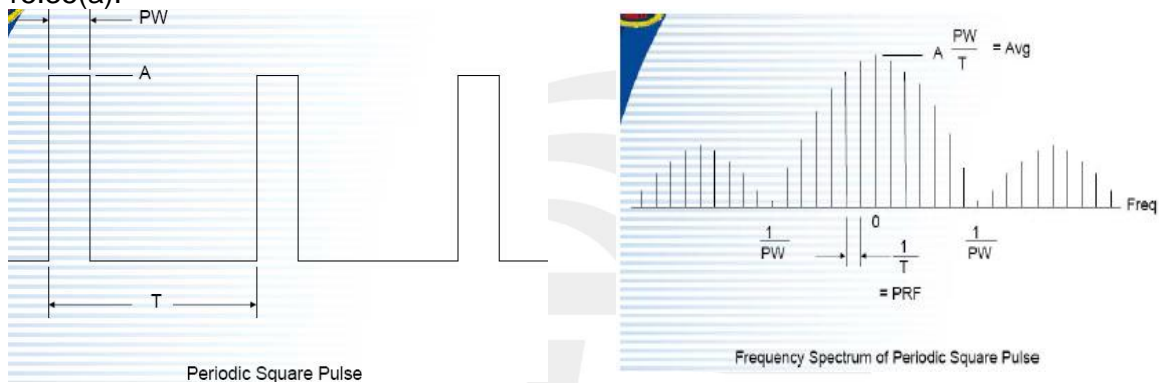

If using spectrum analyzer to measure pulse signal , it have to make sure the RBW use is at least $2/PW$.

•When RBW is less than $2/PW$, you are able to measure the true peak level of the pulse signal. If this is the case , PDCF is required to compensate to determine true peak value.

Pulse desensitization:

PW =4300usec,Period=15100usec, Level=A
 $RBW > 2/PW = 0.465K$, $1/T = 0.066K$

NOTE: $2 / PW < RBW$, first don't need

- b. For the actual test, please refer to the ANSI C63.10,Annex C refer to section 6 for more detail



4.7 FIELD STRENGTH CALCULATION

The field strength is calculated by adding the Antenna Factor and Cable Factor and subtracting the Amplifier Gain and Duty Cycle Correction Factor (if any) from the measured reading. The basic equation with a sample calculation is as follows:

$$FS = RA + AF + CL - AG$$

Where

FS = Field Strength

CL = Cable Attenuation Factor (Cable Loss)

RA = Reading Amplitude

AG = Amplifier Gain

AF = Antenna Factor

For example

Frequency (MHz)	FS (dB μ V/m)	RA (dB μ V/m)	AF (dB)	CL (dB)	AG (dB)	Factor (dB)
300	40	58.1	12.2	1.6	31.9	-18.1

$$\text{Factor} = \text{AF} + \text{CL} - \text{AG}$$

4.8 TEST RESULTS

(Radiated Emission < 30MHz (9KHz-30MHz, H-field))

Freq. (MHz)	Reading (dBuV/m)	Limit (dBuV/m)	Margin (dB)	State P/F
--	--	--	--	PASS
--	--	--	--	PASS

Note: The amplitude of spurious emissions which are attenuated by more than 20dB below the permissible value has no need to be reported.

Distance extrapolation factor = $40 \log (\text{specific distance}/\text{test distance})$ (dB);

Limit line = specific limits(dBuv) + distance extrapolation factor.



Between 30MHz – 5000 MHz

Temperature:	26 °C	Relative Humidity:	54%
Pressure:	1010hPa	Phase:	Horizontal
Test Voltage:	DC 3.7 V from battery	Test Mode:	Mode 1

No.	Frequency (MHz)	Reading (dBuV)	Factor (dB)	Results (dBuV/m)	Limit (dBuV/m)	Margin (dB)	Detector
1	51.6616	46.77	-21.95	24.82	40.00	-15.18	QP
2	76.7808	53.69	-23.15	30.54	40.00	-9.46	QP
3	116.5401	44.84	-17.91	26.93	43.50	-16.57	QP
4	257.4222	36.86	-15.38	21.48	46.00	-24.52	QP
5	627.2738	31.90	-6.42	25.48	46.00	-20.52	QP
6	917.0000	83.12	-1.61	81.51	102.00	-20.49	peak

AV

No.	Frequency (MHz)	Reading (dBuV)	Factor (dB)	Results (dBuV/m)	Limit (dBuV/m)	Margin (dB)	Detector
7	917.0000	81.51	-10.91	70.60	82.00	-11.40	AV

Remark:

1. All readings are Quasi-Peak and Average values.
2. Margin = Result (Result = Reading + Factor) – Limit

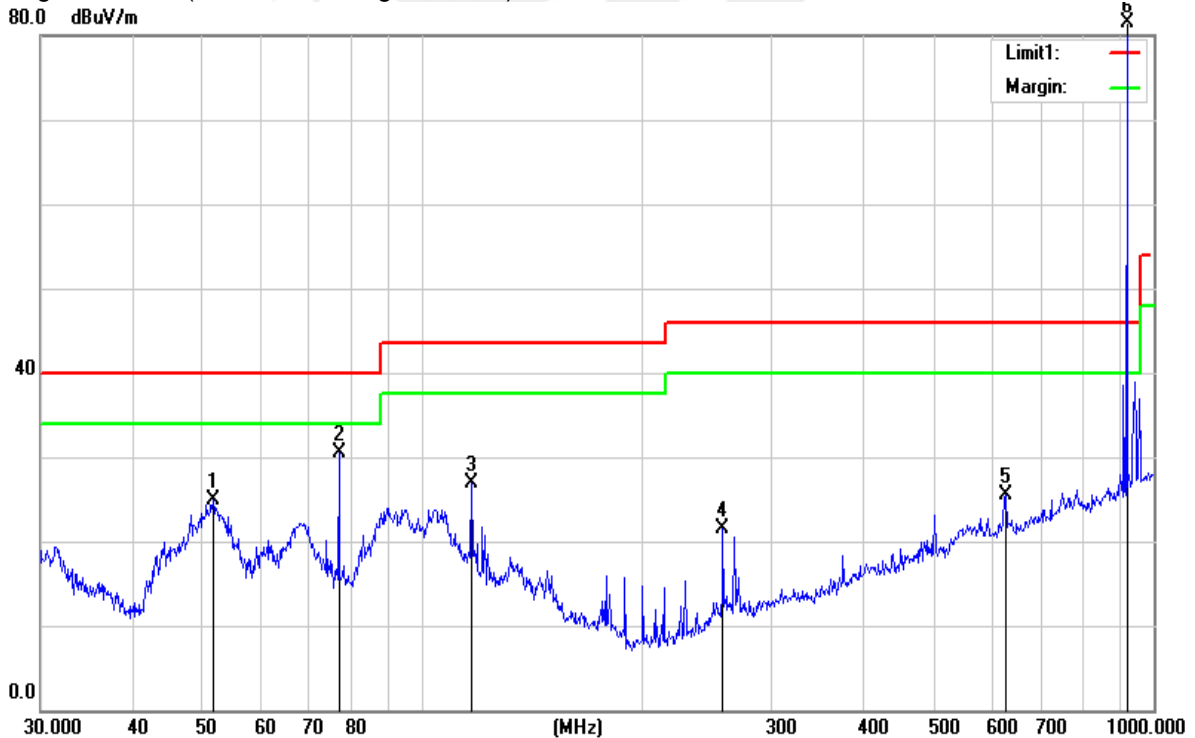



Temperature:	26 °C	Relative Humidity:	54%
Pressure:	1010hPa	Phase:	Vertical
Test Voltage:	DC 3.7 V from battery	Test Mode:	Mode 1

No.	Frequency (MHz)	Reading (dBuV)	Factor (dB)	Results (dBuV/m)	Limit (dBuV/m)	Margin (dB)	Detector
1	49.1865	49.94	-21.06	28.88	40.00	-11.12	QP
2	92.7871	43.10	-19.92	23.18	43.50	-20.32	QP
3	102.7192	41.47	-18.96	22.51	43.50	-20.99	QP
4	150.0108	40.07	-17.97	22.10	43.50	-21.40	QP
5	501.1790	33.22	-8.90	24.32	46.00	-21.68	QP
6	917.0000	77.19	-1.61	75.58	102.00	-26.42	peak

AV

No.	Frequency (MHz)	Reading (dBuV)	Factor (dB)	Results (dBuV/m)	Limit (dBuV/m)	Margin (dB)	Detector
7	917.0000	75.58	-10.91	64.67	82.00	-17.33	AV

Remark:

1. All readings are Quasi-Peak and Average values.
2. Margin = Result (Result = Reading + Factor) - Limit

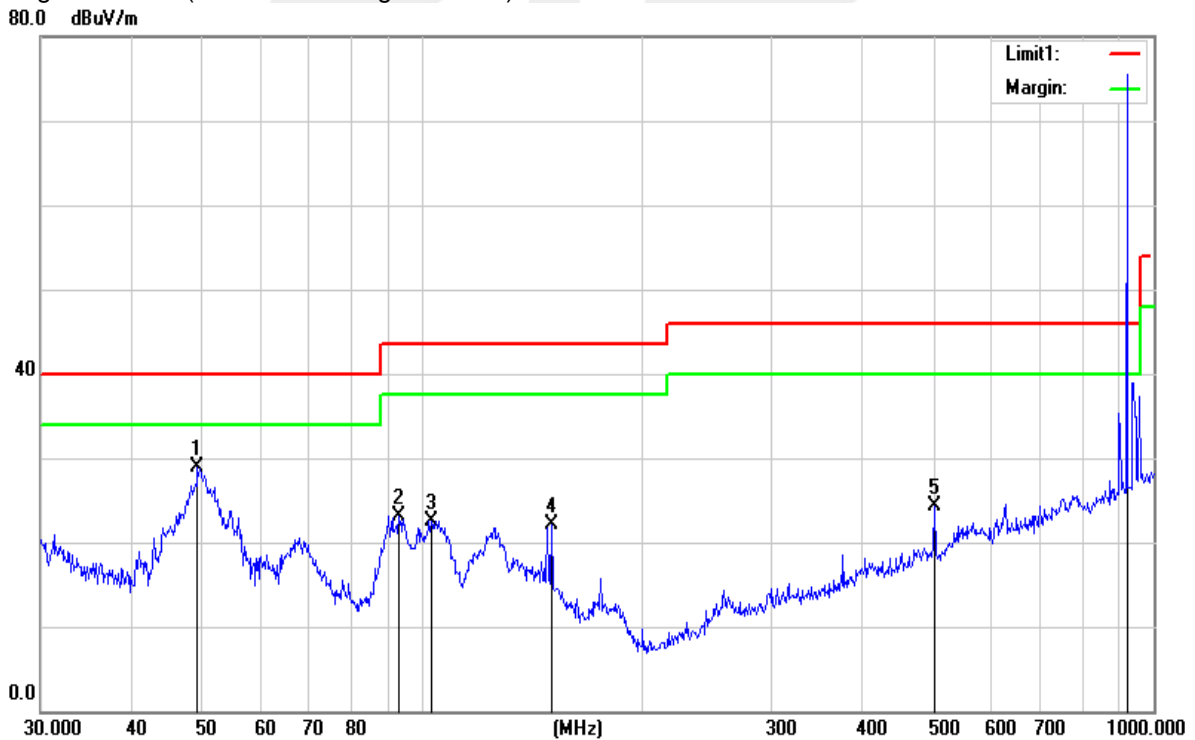



PEAK TEST RESULTS:

Frequency	Reading	Detector	Amplifier	Loss	Antenna Factor	Corrected Factor	Corrected Amplitude	FCC Part 15.231/15.209/205		RX Antenna
								Limit	Margin	Polar
(MHz)	(dBμV/m)	(PK/QP/AV)	(dB)	(dB)	(dB/m)	(dB)	(dBμV/m)	(dBμV/m)	(dB)	(H/V)
1834.17	62.36	PK	45.1	4.0	25.1	-16.00	46.36	82	-35.64	H
1834.17	62.53	PK	45.1	4.0	25.1	-16.00	46.53	82	-35.47	V
2751.35	60.81	PK	44.1	5.3	25	-13.80	47.01	74	-26.99	H
2751.35	60.51	PK	44.1	5.3	25	-13.80	46.71	74	-27.29	V
3668.51	58.15	PK	43.8	5.4	25.9	-12.47	45.68	74	-28.32	H
3668.51	58.48	PK	43.8	5.4	25.9	-12.47	46.01	74	-27.99	V
4585.27	54.25	PK	44.4	6.0	27.6	-10.77	43.48	74	-30.52	H
4585.27	54.39	PK	44.4	6.0	27.6	-10.77	43.62	74	-30.38	V

Note: Above 2.6 GHz The amplitude of spurious emissions which are attenuated by more than 20dB below the permissible value has no need to be reported.

AVG TEST RESULTS:

AV = Peak +20Log10(duty cycle) =PK+(-10.91) [refer to section 6 for more detail]

Frequency	PK Reading	Duty cycle Factor	Corrected Amplitude	FCC Part 15.231/15.209/205		RX Antenna
				Limit	Margin	Polar
(MHz)	(dBμV/m)	(dB)	(dBμV/m)	(dBμV/m)	(dB)	(H/V)
1834.17	46.36	-10.91	35.45	62	-26.55	H
1834.17	46.53	-10.91	35.62	62	-26.38	V
2751.35	47.01	-10.91	36.10	54	-17.90	H
2751.35	46.71	-10.91	35.80	54	-18.20	V
3668.51	45.68	-10.91	34.77	54	-19.23	H
3668.51	46.01	-10.91	35.10	54	-18.90	V
4585.27	43.48	-10.91	32.57	54	-21.43	H
4585.27	43.62	-10.91	32.71	54	-21.29	V



5. BANDWIDTH TEST

5.1 APPLIED PROCEDURES / LIMIT

FCC Part 15.231, Subpart C				
Section	Test Item	Limit	Frequency Range (MHz)	Result
15.231(C)	20 Bandwidth	The 20dB bandwidth of the emissions shall not exceed 0.25% of the center frequency	917	PASS

Spectrum Parameter	Setting
Attenuation	Auto
Span Frequency	> Measurement Bandwidth
RB	10 kHz (20dB Bandwidth)
VB	30 kHz (20dB Bandwidth)
Detector	Peak
Trace	Max Hold
Sweep Time	Auto

5.2 TEST REQUIREMENTS

The bandwidth of the emission shall be no wider than 0.25% of the center frequency for devices operating above 70 MHz and below 900 MHz. For devices operating above 900 MHz, the emission shall be no wider than 0.5% of the center frequency. Bandwidth is determined at the points 20 dB down from the modulated carrier.

5.3 TEST PROCEDURE

- The EUT was directly connected to the spectrum analyzer and antenna output port as show in the block diagram below.
- Spectrum Setting : RBW= 10KHz, VBW=30KHz, Sweep time = Auto.

5.4 TEST SETUP



5.5 EUT OPERATION CONDITIONS

TX mode.



5.6 TEST RESULTS

Centre Frequency	Measurement		
	20dB Bandwidth (KHz)	Limit(kHz)	Frequency Range (MHz)
917 MHz	113.5	4585	PASS

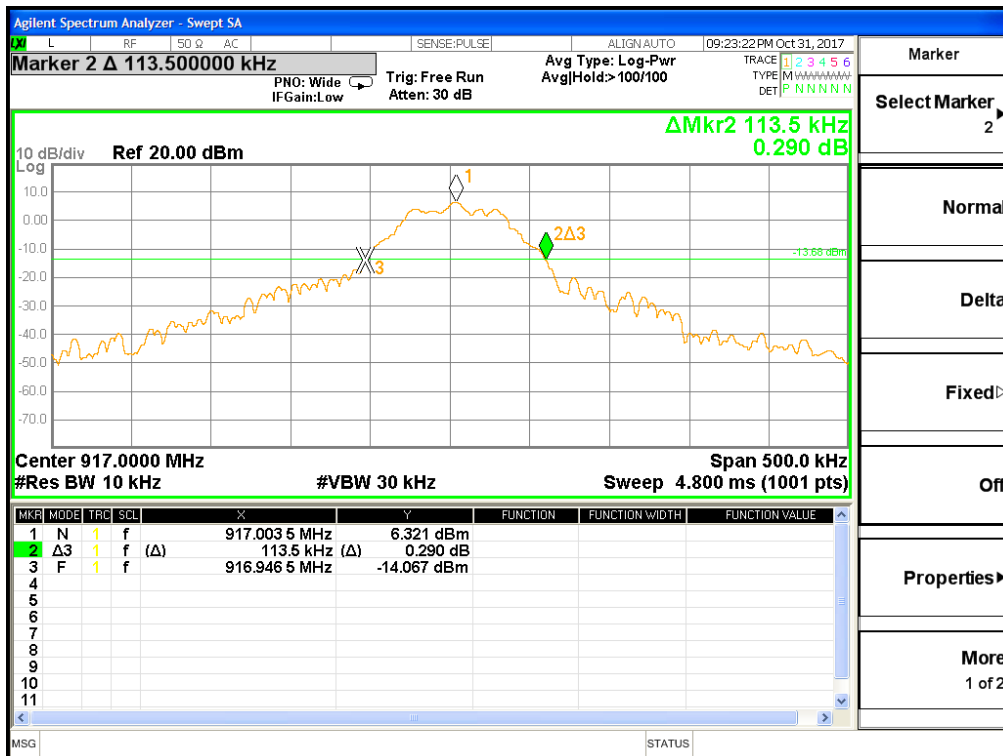



6. DUTY CYCLE

6.1 TEST PROCEDURE

The EUT was directly connected to the spectrum analyzer and antenna output port as show in the block diagram below.

The Duty Cycle Was Determined By The Following Equation: To Calculate The Actual Field Intensity,The Duty Cycle Correction Factor In Decibel Is Needed For Later Use And Can Be Obtained From Following Conversion

Duty Cycle(%)=Total On Interval In A Complete Pulse Train/ Length Of A Complete Pulse Train * %

Duty Cycle Correction Factor(Db)=20 * Log10(Duty Cycle(%))

6.2 TEST SETUP



6.3 EUT OPERATION CONDITIONS

TX mode.





6.4 TEST RESULTS

FCC Part 15.231(a)	
Total On interval in a complete pulse train(ms)	4.3
Length of a complete pulse train(ms)	15.1
Duty Cycle(%)	28.48%
Duty Cycle Correction Factor(dB)	-10.91

Refer to the duty cycle plot (as below), This device meets the FCC requirement. Length of a complete pulse train

Remark: FCC part 15.35(c) required that a complete pulse train is more than 0.1 seconds, the measured field strength shall be determined from the average absolute voltage during a 0.1 second interval during which the field strength is at its maximum value.

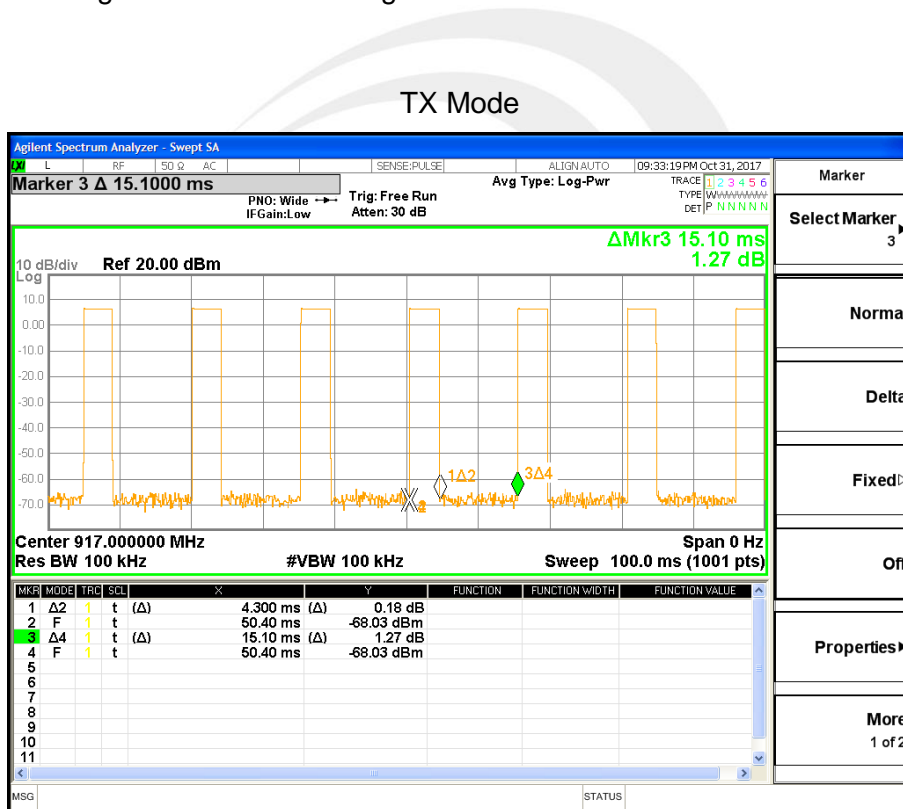



7. AUTOMATICALLY DEACTIVATE

7.1 STANDARD REQUIREMENT

A manually operated transmitter shall employ a switch that will automatically deactivate the transmitter within not more than 5 seconds of being released.

7.2 TEST PROCEDURE

The EUT was directly connected to the spectrum analyzer and antenna output port as show in the block diagram below.

Spectrum Setting : RBW= 100KHz, VBW=300KHz, Sweep time = Auto.

Note: Only press launch about 0.15 s

Note:

(1)Refer to the plot (As Below),We find a manually operated transmitter shall employ a switch that will automatically deactivate the transmitteri immediately, within not more than 5 seconds of being released.

(2)The EUT is comply with FCC PART 15 clause 15.231(a)(1).manually working mode are pre-tested.and only the worst result is reported.

7.3 TEST SETUP



7.4 TEST RESULTS

Activation time	Limit(Sec)	Result
0.190 s	5 s	Pass

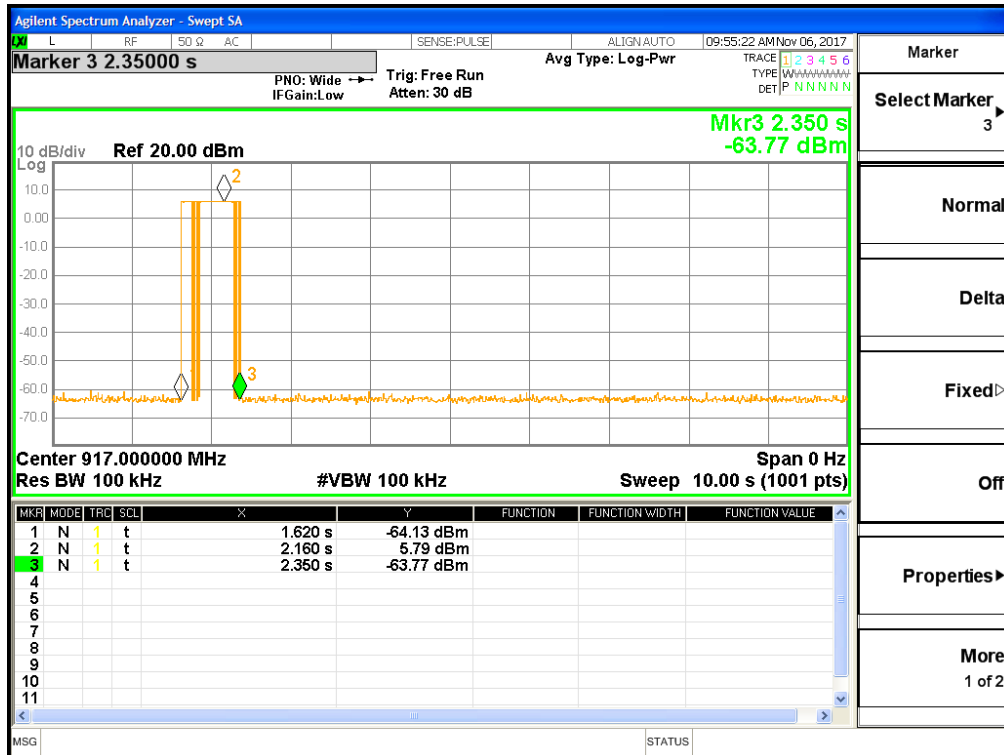

Mark 1: Hold down the Key(Start transmitting)

Mark 2: Loose the Key

Mark 3: Stop transmitting

Activation time= Mark 3- Mark 2=2.350-2.160=0.190 s



8. ANTENNA REQUIREMENT

8.1 STANDARD REQUIREMENT

According to the FCC Part 15 Paragraph 15.203, an intentional radiator shall be designed to ensure that no antenna other than that furnished by the responsible party shall be used with the device. The use of a permanently attached antenna to the intentional radiator shall be considered sufficient to comply with the provisions of this section.

8.2 EUT ANTENNA

The EUT antenna is Omnidirectional Antenna. It conforms to the standard requirements.



APPENDIX 1- PHOTOS OF TEST SETUP

Radiated Measurement Photos

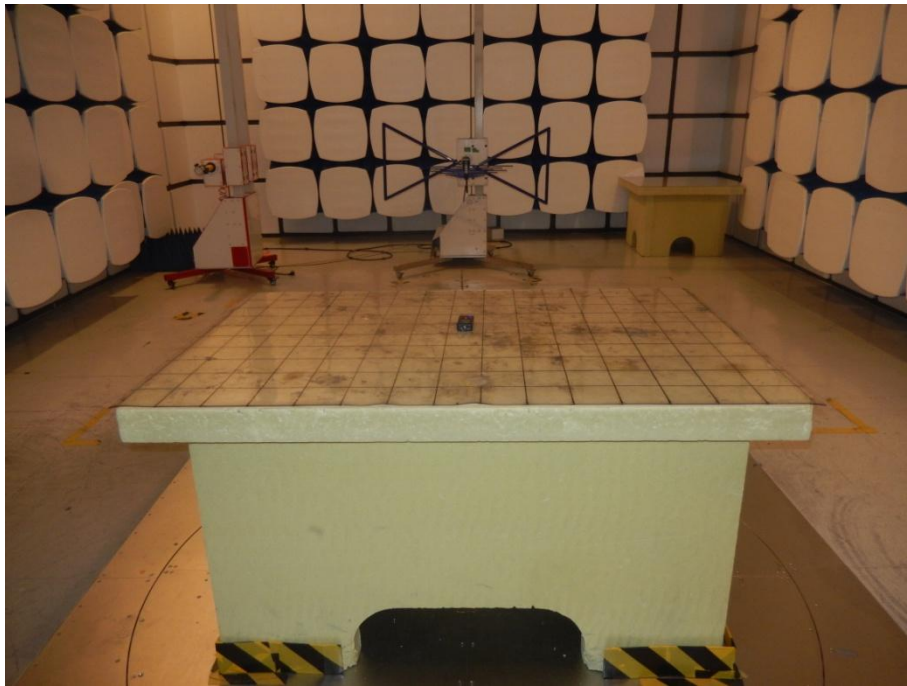

*****END OF THE REPORT*****