

S

T

S

L

A

B



## RADIO TEST REPORT

Report No: STS1710078W02

Issued for

GuangZhou SunFieldAimo Electronic Technology Co., Ltd

801-L room, 143 Bailing Business Building, Liurong Road,  
Guangzhou City, China

<b>Product Name:</b>	Single Axis Wireless Mini Controller
<b>Brand Name:</b>	CINEGEARS
<b>Test Model Name:</b>	CG-1301
<b>Series Model:</b>	CG-2107
<b>FCC ID:</b>	2AM4ZCG-1301
<b>Test Standard:</b>	FCC Part 15.231

Any reproduction of this document must be done in full. No single part of this document may be reproduced without permission from STS, All Test Data Presented in this report is only applicable to presented Test sample.





**TEST REPORT CERTIFICATION**

**Applicant's name :** GuangZhou SunFieldAimo Electronic Technology Co., Ltd  
 Address : 801-L room, 143 Bailing Business Building, Liurong Road, Guangzhou City, China

**Manufacture's Name :** GuangZhou SunFieldAimo Electronic Technology Co., Ltd  
 Address : 801-L room, 143 Bailing Business Building, Liurong Road, Guangzhou City, China

**Product description**

Product name.....: Single Axis Wireless Mini Controller  
 Trade mark .....: CINEGEARS  
 Test model name.....: CG-1301  
 Series model .....: CG-2107

**Standards :** FCC Part 15.231  
**Test procedure :** ANSI C63.10-2013

This device described above has been tested by STS, the test results show that the equipment under test (EUT) is in compliance with the FCC requirements. And it is applicable only to the tested sample identified in the report.

This report shall not be reproduced except in full, without the written approval of STS, this document may be altered or revised by STS, personal only, and shall be noted in the revision of

Date of Test :  
 Date of performance of tests : 17 Oct. 2017 ~ 30 Oct. 2017  
 Date of Issue : 31 Oct. 2017  
 Test Result : **Pass**

Testing Engineer : *Sean She*  
 \_\_\_\_\_  
 (Sean she)

Technical Manager : *Hakim.hou*  
 \_\_\_\_\_  
 (Hakim.hou)

Authorized Signatory : *Vita Li*  
 \_\_\_\_\_  
 (Vita Li)

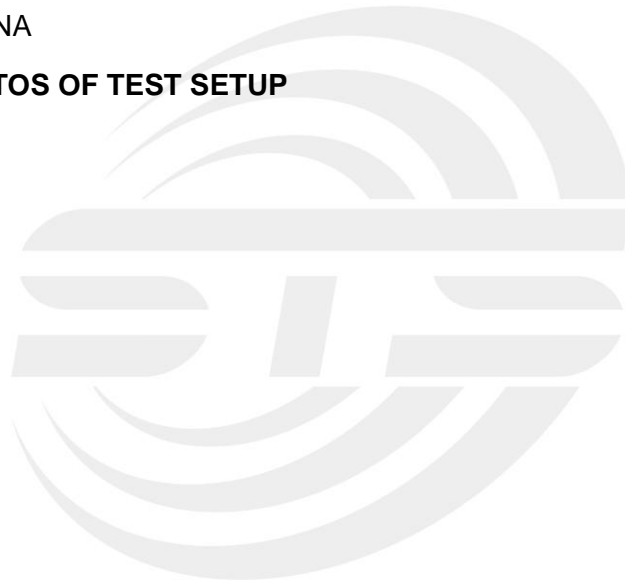



TABLE OF CONTENTS	Page
<b>1. SUMMARY OF TEST RESULTS</b>	<b>6</b>
1.1 TEST FACTORY	6
1.2 MEASUREMENT UNCERTAINTY	6
<b>2. GENERAL INFORMATION</b>	<b>7</b>
2.1 GENERAL DESCRIPTION OF EUT	7
2.2 DESCRIPTION OF TEST MODES	8
2.3 BLOCK DIGRAM SHOWING THE CONFIGURATION OF SYSTEM TESTED	8
2.4 DESCRIPTION OF SUPPORT UNITS	9
2.5 EQUIPMENTS LIST FOR ALL TEST ITEMS	10
<b>3. EMC EMISSION TEST</b>	<b>11</b>
3.1 CONDUCTED EMISSION MEASUREMENT	11
3.2 TEST PROCEDURE	12
3.3 TEST SETUP	12
3.4 EUT OPERATING CONDITIONS	12
3.5 TEST RESULTS	13
<b>4. RADIATED EMISSION MEASUREMENT</b>	<b>14</b>
4.1 RADIATED EMISSION LIMITS	14
4.2 TEST PROCEDURE	15
4.3 DEVIATION FROM TEST STANDARD	16
4.4 TEST SETUP	16
4.5 EUT OPERATING CONDITIONS	17
4.6 TEST RESULTS	17
4.7 FIELD STRENGTH CALCULATION	18
4.8 TEST RESULTS (EMISSION)	18
<b>5. BANDWIDTH TEST</b>	<b>22</b>
5.1 APPLIED PROCEDURES / LIMIT	22
5.2 TEST REQUIREMENTS	22
5.3 TEST PROCEDURE	22
5.4 TEST SETUP	22
5.5 EUT OPERATION CONDITIONS	22
5.6 TEST RESULTS	23
<b>6. TRANSMITTER TIMEOUT</b>	<b>24</b>
6.1 LIMIT	24
6.2 TEST PROCEDURE	24



TABLE OF CONTENTS	Page
6.3 TEST SETUP	24
6.4 TEST RESULTS	25
<b>7. PERIODIC OPERATION</b>	<b>26</b>
7.1 TEST PROCEDURE	26
7.2 TEST SETUP	26
7.3 EUT OPERATION CONDITIONS	26
7.4 TEST RESULTS	27
<b>8. ANTENNA REQUIREMENT</b>	<b>28</b>
8.1 STANDARD REQUIREMENT	28
8.2 EUT ANTENNA	28
<b>APPENDIX 1- PHOTOS OF TEST SETUP</b>	<b>29</b>





**Revision History**

Rev.	Issue Date	Report NO.	Effect Page	Contents
00	31 Oct. 2017	STS1710078W02	ALL	Initial Issue





## 1. SUMMARY OF TEST RESULTS

Test procedures according to the technical standards:

FCC Part 15.231, Subpart C			
Standard Section	Test Item	Judgment	Remark
15.207	Conducted Emission	N/A	--
15.205(a)/15.209/ 15.231.(e)	Radiated Spurious Emission	PASS	--
15.231	Transmission requirement	PASS	--
15.231(C)	20 dB Bandwidth	PASS	--
15.203	Antenna Requirement	PASS	--

NOTE: (1)"N/A" denotes test is not applicable in this Test Report

(2) All tests are according to ANSI C63.4-2014 and ANSI C63.10-2013

### 1.1 TEST FACTORY

Shenzhen STS Test Services Co., Ltd.  
1/F., Building B, Zhuoke Science Park, No.190, Chongqing Road,  
Fuyong Street, Bao'an District, Shenzhen, Guangdong, China  
CNAS Registration No.: L7649; FCC Registration No.: 625569

IC Registration No.: 12108A; A2LA Certificate No.: 4338.01;

### 1.2 MEASUREMENT UNCERTAINTY

The reported uncertainty of measurement  $y \pm U$ , where expanded uncertainty  $U$  is based on a standard uncertainty multiplied by a coverage factor of  $k=2$ , providing a level of confidence of approximately 95 %.

No.	Item	Uncertainty
1	Conducted Emission (9KHz-150KHz)	$\pm 2.88$ dB
2	Conducted Emission (150KHz-30MHz)	$\pm 2.67$ dB
3	RF power,conducted	$\pm 0.71$ dB
4	Spurious emissions,conducted	$\pm 0.63$ dB
5	All emissions,radiated (9KHz-30MHz)	$\pm 3.02$ dB
6	All emissions,radiated (30MHz-200MHz)	$\pm 3.80$ dB
7	All emissions,radiated (200MHz-1000MHz)	$\pm 3.97$ dB



## 2. GENERAL INFORMATION

### 2.1 GENERAL DESCRIPTION OF EUT

Equipment	Single Axis Wireless Mini Controller										
Trade Name	CINEGEARS										
Model Name	CG-1301										
Series Model	CG-2107										
Model Difference	Single Axis Wireless Mini Rocker Switch Controller V2										
Product Description	<p>The EUT is a Single Axis Wireless Mini Controller</p> <table border="1"><tr><td>Operation Frequency:</td><td>434MHz</td></tr><tr><td>Modulation Type:</td><td>FM</td></tr><tr><td>Number Of Channel</td><td>1CH.</td></tr><tr><td>Antenna Designation:</td><td>Omnidirectional antenna</td></tr><tr><td>Antenna Gain(Peak)</td><td>0 dBi</td></tr></table> <p>More details of EUT technical specification, please refer to the User's Manual.</p>	Operation Frequency:	434MHz	Modulation Type:	FM	Number Of Channel	1CH.	Antenna Designation:	Omnidirectional antenna	Antenna Gain(Peak)	0 dBi
Operation Frequency:	434MHz										
Modulation Type:	FM										
Number Of Channel	1CH.										
Antenna Designation:	Omnidirectional antenna										
Antenna Gain(Peak)	0 dBi										
Hardware version number	DC10										
Software version number	DC10										
Connecting I/O Port(s)	Please refer to the User's Manual										

Note:

1. For a more detailed features description, please refer to the manufacturer's specifications or the User's Manual.

2. Table for filed Antenna

Ant.	Brand	Model Name	Antenna Type	Connector	Gain (dBi)	NOTE
1	CINEGEARS	CG-1301	Omnidirectional Ant.	N/A	0	Antenna

The EUT antenna is dipole antenna. No antenna other than that furnished by the responsible party shall be used with the device.



## 2.2 DESCRIPTION OF TEST MODES

To investigate the maximum EMI emission characteristics generates from EUT, the test system was pre-scanning tested base on the consideration of following EUT operation mode or test configuration mode which possible have effect on EMI emission level. Each of these EUT operation mode(s) or test configuration mode(s) mentioned above was evaluated respectively.

Pretest Mode	Description
Mode 1	TX Mode

	For Radiated Emission
Final Test Mode	Description
Mode 1	TX Mode

Note:

- (1) The measurements are performed at the highest, middle, lowest available channels.
- (2) The measurements are performed at all Bit Rate of Transmitter, the worst data was reported

## 2.3 BLOCK DIGRAM SHOWING THE CONFIGURATION OF SYSTEM TESTED

During testing channel & power controlling software provided by the customer was used to control the operating channel as well as the output power level. The RF output power selection is for the setting of RF output power expected by the customer and is going to be fixed on the firmware of the final end product power parameters

E-1  
EUT





### 2.4 DESCRIPTION OF SUPPORT UNITS

The EUT has been tested as an independent unit together with other necessary accessories or support units. The following support units or accessories were used to form a representative test configuration during the tests.

Item	Equipment	Mfr/Brand	Model/Type No.	Series No.	Note

Item	Shielded Type	Ferrite Core	Length	Note
N/A	N/A	N/A	N/A	N/A

Note:

- (1)The support equipment was authorized by Declaration of Confirmation.
- (2)For detachable type I/O cable should be specified the length in cm in 『Length』 column.



## 2.5 EQUIPMENTS LIST FOR ALL TEST ITEMS

## Radiation Test equipment

Kind of Equipment	Manufacturer	Type No.	Serial No.	Last calibration	Calibrated until
EMI Test Receiver	R&S	ESW	101535	2017.06.01	2018.05.31
Bilog Antenna	TESEQ	CBL6111D	34678	2017.03.24	2018.03.23
Horn Antenna	Schwarzbeck	BBHA 9120D (1201)	9120D-1343	2017.03.06	2018.03.05
PreAmplifier (1G-26.5GHz)	Agilent	8449B	60538	2017.10.15	2018.10.14
Operational Manual Passive Loop (9K--30MHz)	ETS	6512	00165355	2017.03.06	2018.03.05
USB RF power sensor	DARE	RPR3006W	15I00041SNOO 3	2017.10.15	2018.10.14
Semi-anechoic chamber	Changling	966	N/A	2017.10.15	2018.10.14

## Conduction Test equipment

Kind of Equipment	Manufacturer	Type No.	Serial No.	Last calibration	Calibrated until
Test Receiver	R&S	ESCI	101427	2017.10.15	2018.10.14
LISN	R&S	ENV216	101242	2017.10.15	2018.10.14
conduction Cable	EM	C01	N/A	2017.03.12	2018.03.11
Shielding Room	Changling	854	N/A	2017.10.15	2018.10.14

### 3. EMC EMISSION TEST

#### 3.1 CONDUCTED EMISSION MEASUREMENT

##### 3.1.1 POWER LINE CONDUCTED EMISSION LIMITS

operating frequency band. In case the emission fall within the restricted band specified on Part 15. 207(a) limit in the table below has to be followed.

FREQUENCY (MHz)	Class B (dBuV)		Standard
	Quasi-peak	Average	
0.15 -0.5	66 - 56 *	56 - 46 *	CISPR
0.50 -5.0	56.00	46.00	CISPR
5.0 -30.0	60.00	50.00	CISPR

0.15 -0.5	66 - 56 *	56 - 46 *	FCC
0.50 -5.0	56.00	46.00	FCC
5.0 -30.0	60.00	50.00	FCC

Note:

- (1) The tighter limit applies at the band edges.
- (2) The limit of " \* " marked band means the limitation decreases linearly with the logarithm of the frequency in the range.

The following table is the setting of the receiver

Receiver Parameters	Setting
Attenuation	10 dB
Start Frequency	0.15 MHz
Stop Frequency	30 MHz
IF Bandwidth	9 kHz

### 3.2 TEST PROCEDURE

- a. The EUT was placed 0.4 meters from the horizontal ground plane with EUT being connected to the power mains through a line impedance stabilization network (LISN). All other support equipments powered from additional LISN(s). The LISN provide 50 Ohm/ 50uH of coupling impedance for the measuring instrument.
- b. Interconnecting cables that hang closer than 40 cm to the ground plane shall be folded back and forth in the center forming a bundle 30 to 40 cm long.
- c. I/O cables that are not connected to a peripheral shall be bundled in the center. The end of the cable may be terminated, if required, using the correct terminating impedance. The overall length shall not exceed 1 m.
- d. LISN at least 80 cm from nearest part of EUT chassis.
- e. For the actual test configuration, please refer to the related Item –EUT Test Photos.

### 3.3 TEST SETUP

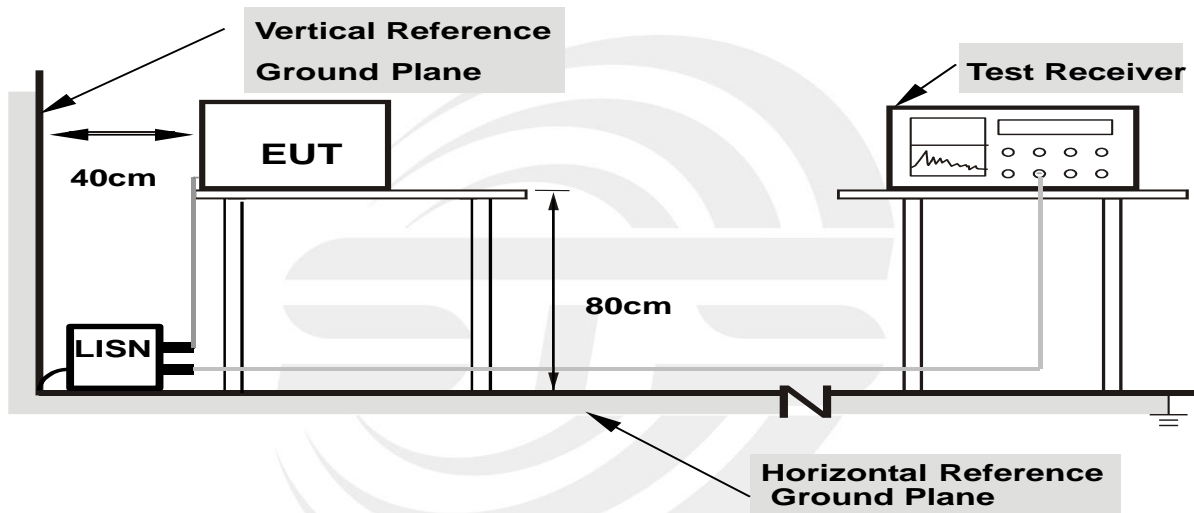

- Note: 1. Support units were connected to second LISN.**  
**2. Both of LISNs (AMN) are 80 cm from EUT and at least 80 from other units and other metal planes**

### 3.4 EUT OPERATING CONDITIONS

The EUT was configured for testing in a typical fashion (as a customer would normally use it). The EUT has been programmed to continuously transmit during test. This operating condition was tested and used to collect the included data.



### 3.5 TEST RESULTS

Temperature:	26 °C	Relative Humidity:	54%
Pressure:	1010hPa	Phase:	L/N
Test Mode:	N/A		

Note: denotes test is not applicable in this test report.





## 4. RADIATED EMISSION MEASUREMENT

### 4.1 RADIATED EMISSION LIMITS

In case the emission fall within the restricted band specified on Part 15.205(a), then the Part 15.209(a) and Part 15.231(e) limit in the table below has to be followed.

#### LIMITS OF RADIATED EMISSION MEASUREMENT (0.009MHz - 1000MHz)

Frequencies (MHz)	Field Strength (micorvolts/meter)	Measurement Distance (meters)
0.009~0.490	2400/F(KHz)	300
0.490~1.705	24000/F(KHz)	30
1.705~30.0	30	30
30~40.66	100	3

#### LIMITS OF RADIATED EMISSION MEASUREMENT ( FCC 15.231.e)

Fundamental Frequency (MHz)	Field Strength of fundamental (microvolts/meter)	Field Strength of Unwanted Emissions (microvolts/meter)
40.66 - 40.70	1,000	100
70 - 130	500	50
130 - 174	500 to 1,500 **	50 to 1,50 **
174 - 260	1,500	1,50
260 - 470	1,500 to 5,000 **	1,50 to 5,00 **
Above 470	5,000	5,00

#### LIMITS OF RADIATED EMISSION MEASUREMENT (Above 1000MHz)

FREQUENCY (MHz)	Class B (dBuV/m) (at 3M)	
	PEAK	AVERAGE
Above 1000	74	54

NOTE:\*\* linear interpolations

[Where F is the frequency in MHz, the formulas for calculating the maximum permitted fundamental

field strengths are as follows: for the band 130-174 MHz,  $\mu\text{V/m}$  at 3 meters =  $22.72727(F) - 2454.545$ ;

for the band 260-470 MHz,  $\mu\text{V/m}$  at 3 meters =  $16.6667(F) - 2833.3333$ . The maximum permitted unwanted emission level is 20 dB below the maximum permitted fundamental level.]

The limits on the field strength of the spurious emissions in the above table are based on the fundamental frequency of the intentional radiator. Spurious emissions shall be attenuated to the average (or, alternatively, CISPR quasi-peak) limits shown in this table or to the general limits shown in 93 Section 15.209, whichever limit permits a higher field strength.



Spectrum Parameter	Setting
Detector	Peak
Attenuation	Auto
Start Frequency	1000 MHz
Stop Frequency	10th carrier harmonic
RB / VB (emission in restricted band)	1 MHz / 3 MHz

Receiver Parameter	Setting
Attenuation	Auto
Start ~ Stop Frequency	9kHz~90kHz / RB 200Hz for PK & AV
Start ~ Stop Frequency	90kHz~110kHz / RB 200Hz for QP
Start ~ Stop Frequency	110kHz~490kHz / RB 200Hz for PK & AV
Start ~ Stop Frequency	490kHz~30MHz / RB 9kHz for QP
Start ~ Stop Frequency	30MHz~1000MHz / RB 120kHz for QP

#### 4.2 TEST PROCEDURE

- a. The measuring distance of 3m shall be used for measurements. The EUT was placed on the top of a rotating table 0.8 meter above the ground at a 3 meter semi-anechoic chamber. The table was rotated 360 degrees to determine the position of the highest radiation (Below 1GHz)
- b. The measuring distance of 3m shall be used for measurements. The EUT was placed on the top of a rotating table 1.5 meter above the ground at a 3 meter semi-anechoic chamber. The table was rotated 360 degrees to determine the position of the highest radiation (Above 1GHz)
- c. The height of the test antenna shall vary between 1m to 4m. Both horizontal and vertical polarization of the antenna are set to make the measurement.
- d. The initial step in collecting radiated emission data is a receive peak detector mode. Pre-scanning the measurement frequency range. Significant peaks are then marked and then Quasi Peak detector mode re-measured.
- e. All readings are peak unless otherwise stated QP in column of Note. Peak denoted that the Peak reading compliance with the QP limits and then QP Mode measurement didn't perform (Below 1GHz)
- f. All readings are Peak mode value unless otherwise stated AVG in column of Note. If the Peak mode measured value compliance with the Peak limits and lower than AVG Limits, the EUT shall be deemed to meet Peak & AVG limits and then only Peak mode was measured, but AVG mode didn't perform. (Above 1GHz)
- g. For the actual test configuration, please refer to the related Item –EUT Test Photos.

Note: Both horizontal and vertical antenna polarities were tested

and performed pretest to three orthogonal axis. The worst case emissions were reported

### 4.3 DEVIATION FROM TEST STANDARD

No deviation

### 4.4 TEST SETUP

(A) Radiated Emission Test-Up Frequency Below 30MHz

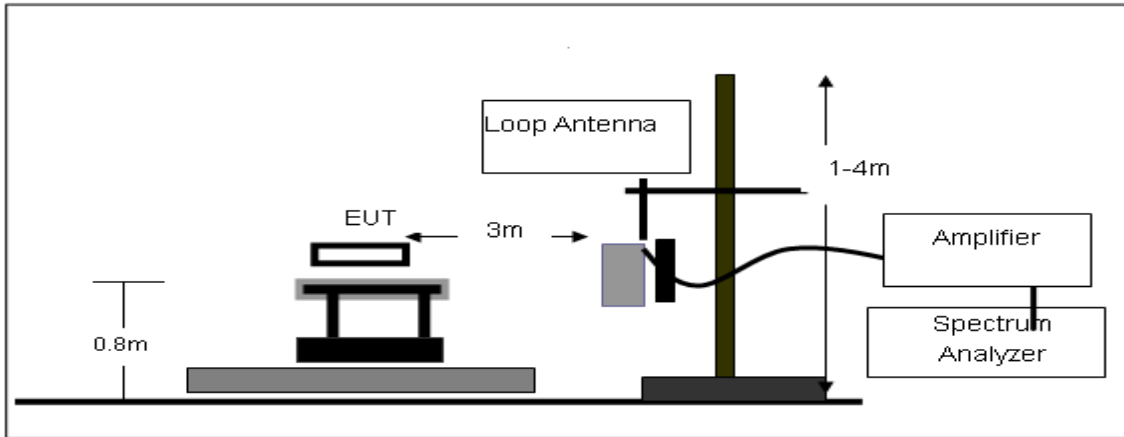

(B) Radiated Emission Test-Up Frequency 30MHz~1GHz

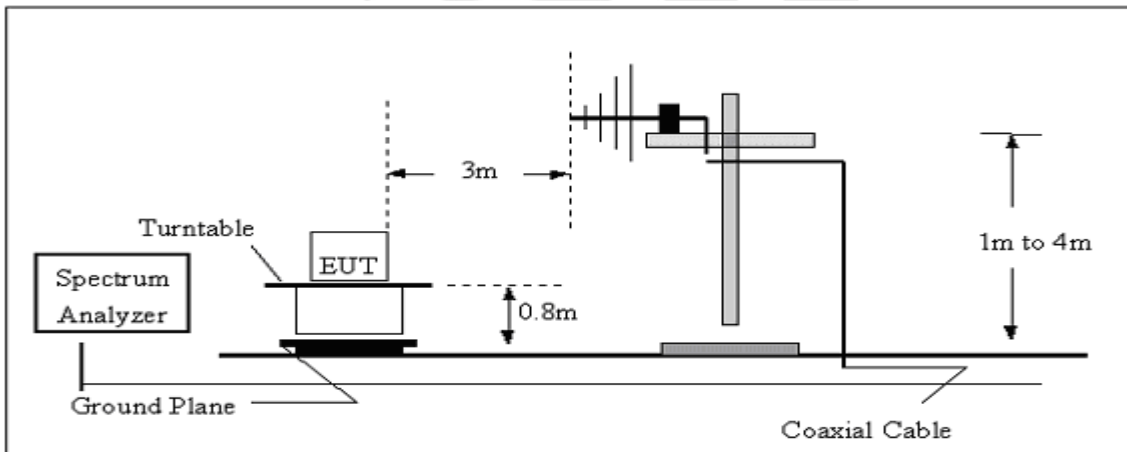

(C) Radiated Emission Test-Up Frequency Above 1GHz

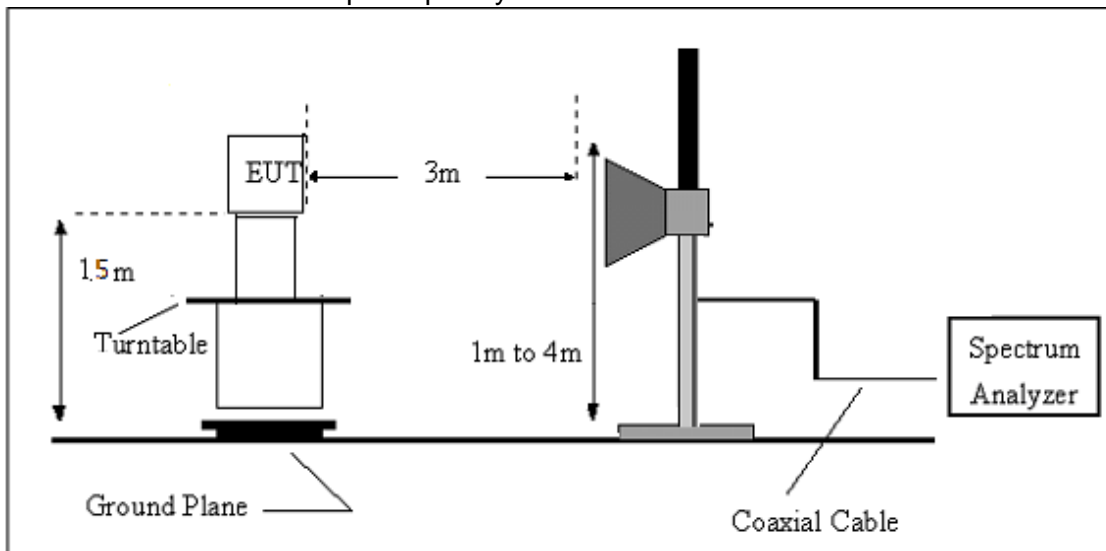



#### 4.5 EUT OPERATING CONDITIONS

The EUT tested system was configured as the statements of 2.4 Unless otherwise a special operating condition is specified in the follows during the testing.

#### 4.6 TEST RESULTS

##### INTRODUCTION TO PDCF

reference: (§15.35 Measurement detector functions and bandwidths.)

- a. Part 15 of the FCC Rules provides for the operation of low power communication devices without an individual license (e.g., intrusion detectors, pulsed water tank level gauges, etc.), subject to certain requirements. Some of these devices use extremely narrow pulses to generate wideband emissions, which are measured to determine compliance with the rules. These measurements are typically performed with a receiver or spectrum analyzer. Depending on a number of factors (e.g., resolution bandwidth, pulsewidth, etc.), the spectrum analyzer may not always display the true peak value of the measured emission. This effect, called “pulse desensitization,” relates to the capabilities of the measuring instrument. For the measurement and reporting of the true peak of pulsed emissions, it may be necessary to apply a “pulse desensitization correction factor” (PDCF) to the measured value, pursuant to 47 CFR 15.35(a).

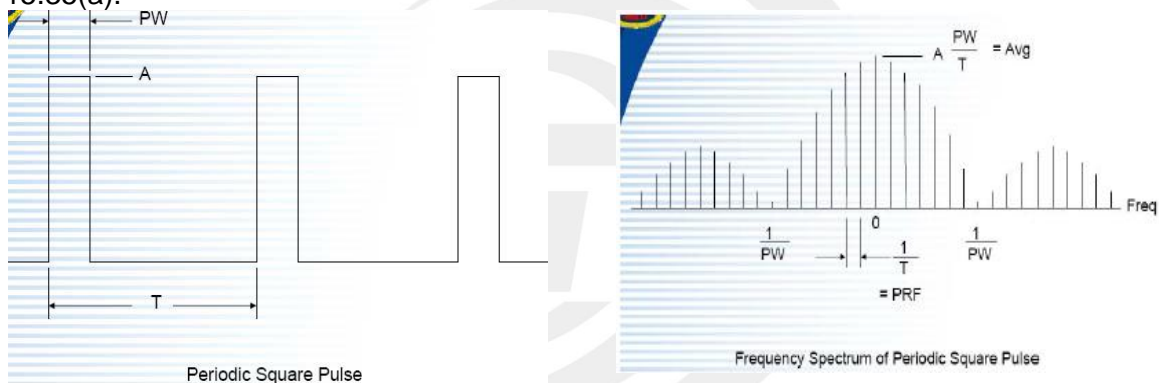

If using spectrum analyzer to measure pulse signal , it have to make sure the RBW use is at least  $2/PW$ .

•When RBW is less than  $2/PW$  , you are able to measure the true peak level of the pulse signal. If this is the case , PDCF is required to compensate to determine true peak value.

Pulse desensitization:

$PW = 16400\text{usec}$ ,  $\text{Period} = 100000\text{usec}$ ,  $\text{Level} = A$

$RBW > 2/PW = 0.122K$  ,  $PRF = 1/T = 0.01K$  ,

NOTE:  $2 / PW < RBW$ , first don't need

- b. For the actual test, please refer to the ANSI C63.10, Annex C refer to section 7 for more detail



#### 4.7 FIELD STRENGTH CALCULATION

The field strength is calculated by adding the Antenna Factor and Cable Factor and subtracting the Amplifier Gain and Duty Cycle Correction Factor (if any) from the measured reading. The basic equation with a sample calculation is as follows:

$$FS = RA + AF + CL - AG$$

Where

FS = Field Strength

CL = Cable Attenuation Factor (Cable Loss)

RA = Reading Amplitude

AG = Amplifier Gain

AF = Antenna Factor

For example

Frequency (MHz)	FS (dB $\mu$ V/m)	RA (dB $\mu$ V/m)	AF (dB)	CL (dB)	AG (dB)	Factor (dB)
300	40	58.1	12.2	1.6	31.9	-18.1

$$\text{Factor} = \text{AF} + \text{CL} - \text{AG}$$

#### 4.8 TEST RESULTS (EMISSION)

(Radiated Emission < 30MHz (9KHz-30MHz, H-field))

Temperature:	24.5 °C	Relative Humidity:	58%
Pressure:	1010 hPa	Polarization:	--
Test Mode:	Mode 1		

Not: Vertical level have a test this is the worst.

Freq. (MHz)	Reading (dBuV/m)	Limit (dBuV/m)	Margin (dB)	State P/F
--	--	--	--	PASS
--	--	--	--	PASS

Note: The amplitude of spurious emissions which are attenuated by more than 20dB below the permissible value has no need to be reported.

Distance extrapolation factor =  $40 \log(\text{specific distance}/\text{test distance})$ (dB);

Limit line = specific limits(dBuv) + distance extrapolation factor.



Between 30MHz – 5000 MHz

Temperature:	24.5 °C	Relative Humidity:	58%
Pressure:	1010hPa	Phase:	Horizontal
Test Mode:	Mode 1		

No.	Frequency (MHz)	Reading (dBuV)	Factor (dB)	Results (dBuV/m)	Limit (dBuV/m)	Margin (dB)	Detector
1	50.7637	33.49	-21.70	11.79	40.00	-28.21	QP
2	68.1512	37.47	-24.15	13.32	40.00	-26.68	QP
3	113.3162	32.36	-18.13	14.23	43.50	-29.27	QP
4	135.5062	33.12	-17.52	15.60	43.50	-27.90	QP
5	434.0000	85.36	-10.90	74.46	100.83	-26.37	peak
6	868.0000	33.84	-2.63	31.21	80.83	-49.62	QP

AV

No.	Frequency (MHz)	Reading (dBuV)	Factor (dB)	Results (dBuV/m)	Limit (dBuV/m)	Margin (dB)	Detector
7	434.0000	74.46	-15.70	58.76	80.83	-22.07	AV

Remark:

1. All readings are Quasi-Peak and Average values.
2. Margin = Result (Result = Reading + Factor) – Limit

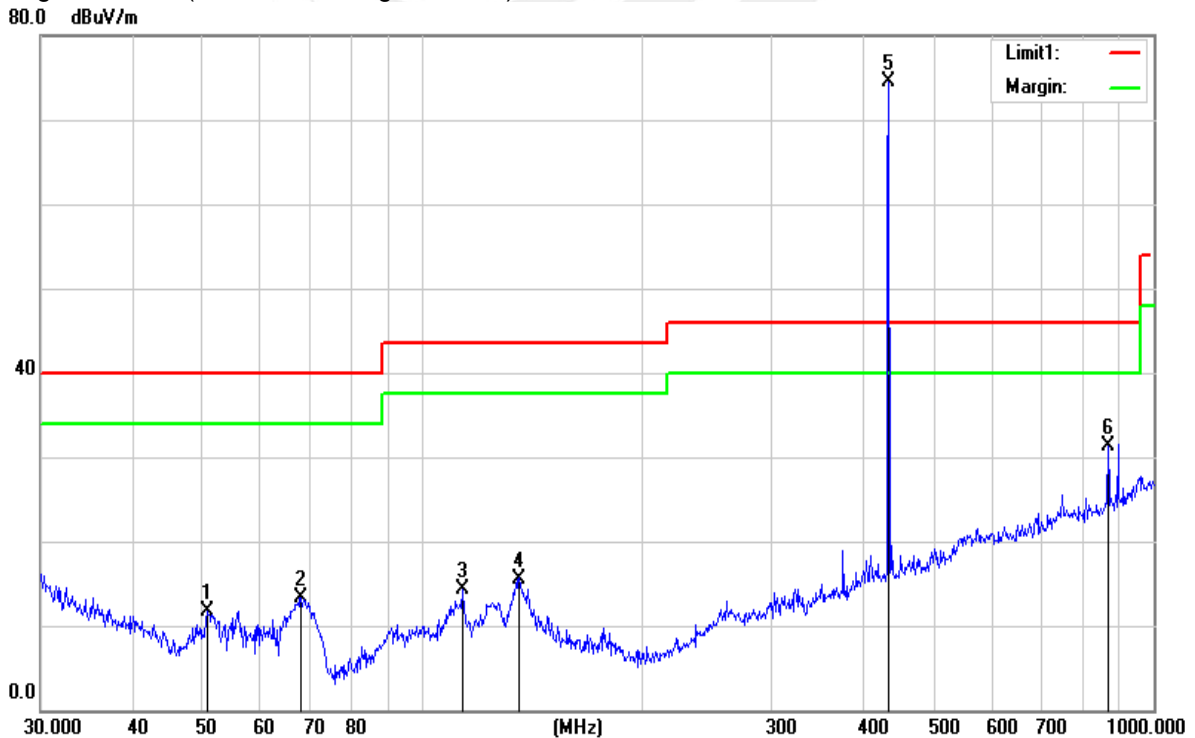



Temperature:	24.5 °C	Relative Humidity:	58%
Pressure:	1010hPa	Phase:	Vertical
Test Mode:	Mode 1		

No.	Frequency (MHz)	Reading (dBuV)	Factor (dB)	Results (dBuV/m)	Limit (dBuV/m)	Margin (dB)	Detector
1	49.0145	35.83	-20.97	14.86	40.00	-25.14	QP
2	80.0806	38.92	-22.67	16.25	40.00	-23.75	QP
3	133.6188	33.59	-17.54	16.05	43.50	-27.45	QP
4	150.0108	36.20	-17.97	18.23	43.50	-25.27	QP
5	434.0000	85.08	-10.90	74.18	100.83	-26.65	peak
6	893.8567	39.83	-2.34	37.49	46.00	-8.51	QP

AV

No.	Frequency (MHz)	Reading (dBuV)	Factor (dB)	Results (dBuV/m)	Limit (dBuV/m)	Margin (dB)	Detector
7	434.0000	74.18	-15.7	58.48	80.83	-22.35	AV

Remark:

1. All readings are Quasi-Peak and Average values.
2. Margin = Result (Result = Reading + Factor) - Limit

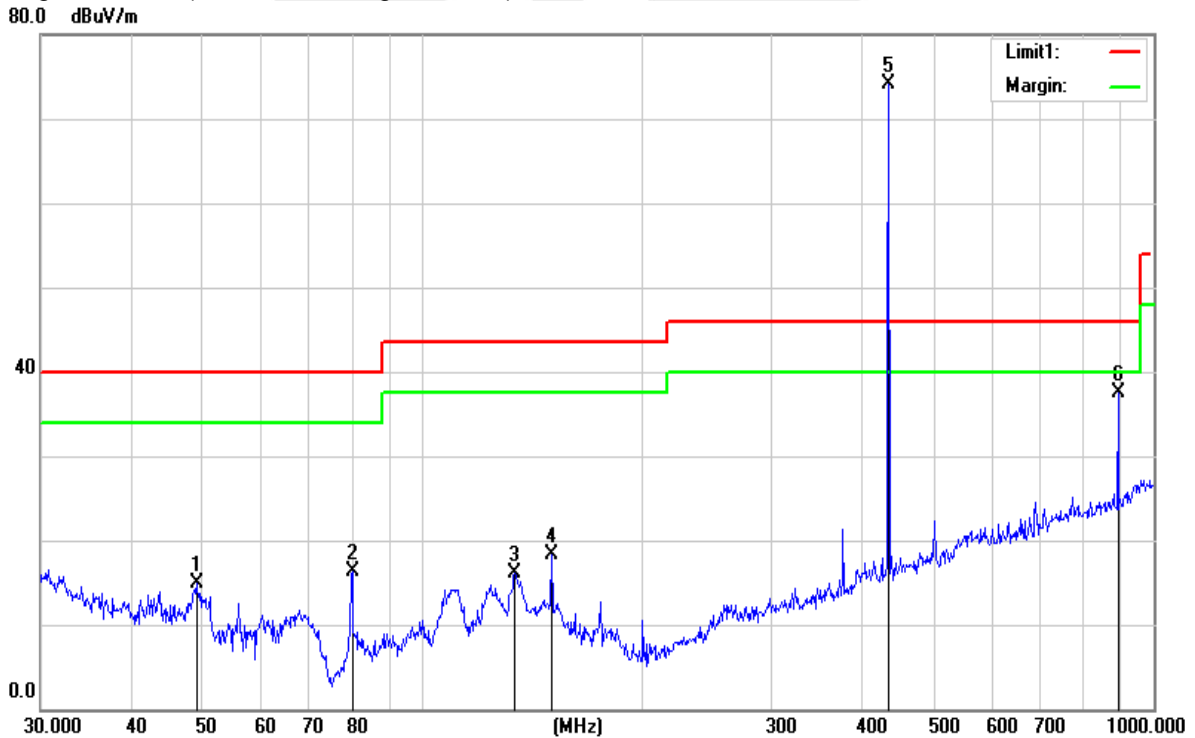



PEAK TEST RESULTS:

Frequency	Reading	Detector	Amplifier	Loss	Antenna Factor	Corrected Factor	Corrected Amplitude	FCC Part 15.231/15.209/205		RX Antenna
								Limit	Margin	Polar
(MHz)	(dBμV/m)	(PK/QP/AV)	(dB)	(dB)	(dB/m)	(dB)	(dBμV/m)	(dBμV/m)	(dB)	(H/V)
1302.13	64.32	PK	45.1	4.0	25.1	16.00	48.32	74	-25.68	H
1302.13	64.91	PK	45.1	4.0	25.1	16.00	48.91	74	-25.09	V
1736.27	62.18	PK	44.1	5.3	25	13.80	48.38	74	-25.62	H
1736.27	63.56	PK	44.1	5.3	25	13.80	49.76	74	-24.24	V
2170.65	60.75	PK	43.8	5.4	25.9	12.47	48.28	74	-25.72	H
2170.65	61.36	PK	43.8	5.4	25.9	12.47	48.89	74	-25.11	V
2604.38	56.92	PK	44.4	6.0	27.6	10.77	46.15	74	-27.85	H
2604.38	56.63	PK	44.4	6.0	27.6	10.77	45.86	74	-28.14	V

Note: Above 1.5GHz The amplitude of spurious emissions which are attenuated by more than 20dB below the permissible value has no need to be reported.

AVG TEST RESULTS:

AV = Peak +20Log10(duty cycle) =PK+(-15.7) [refer to section 7 for more detail]

Frequency	PK Reading	Duty cycle	Corrected Amplitude	FCC Part 15.231/15.209/205		RX Antenna
				Limit	Margin	Polar
(MHz)	(dBμV/m)	(dB)	(dBμV/m)	(dBμV/m)	(dB)	(H/V)
1302.13	48.32	-15.7	32.62	54	-21.38	H
1302.13	48.91	-15.7	33.21	54	-20.79	V
1736.27	48.38	-15.7	32.68	54	-21.32	H
1736.27	49.76	-15.7	34.06	54	-19.94	V
2170.65	48.28	-15.7	32.58	54	-21.42	H
2170.65	48.89	-15.7	33.19	54	-20.81	V
2604.38	46.15	-15.7	30.45	54	-23.55	H
2604.38	45.86	-15.7	30.16	54	-23.84	V

## 5. BANDWIDTH TEST

### 5.1 APPLIED PROCEDURES / LIMIT

FCC Part 15.231, Subpart C				
Section	Test Item	Limit	Frequency Range (MHz)	Result
15.231(C)	20 Bandwidth	The 20dB bandwidth of the emissions shall not exceed 0.25% of the center frequency	434	PASS

Spectrum Parameter	Setting
Attenuation	Auto
Span Frequency	> Measurement Bandwidth
RB	10 kHz (20dB Bandwidth)
VB	30 kHz (20dB Bandwidth)
Detector	Peak
Trace	Max Hold
Sweep Time	Auto

### 5.2 TEST REQUIREMENTS

The bandwidth of the emission shall be no wider than 0.25% of the center frequency for devices operating above 70 MHz and below 900 MHz. For devices operating above 900 MHz, the emission shall be no wider than 0.5% of the center frequency. Bandwidth is determined at the points 20 dB down from the modulated carrier.

### 5.3 TEST PROCEDURE

- The EUT was directly connected to the spectrum analyzer and antenna output port as show in the block diagram below.
- Spectrum Setting : RBW= 10KHz, VBW=30KHz, Sweep time = Auto.

### 5.4 TEST SETUP



### 5.5 EUT OPERATION CONDITIONS

TX mode.



5.6 TEST RESULTS

Temperature:	24.5 °C	Relative Humidity:	58%
Pressure:	1012 hPa	Test Mode:	TX Mode

Centre Frequency	Measurement		
	20dB Bandwidth (KHz)	Limit(kHz)	Frequency Range (MHz)
434MHz	113.3	1085	PASS

20dB Bandwidth

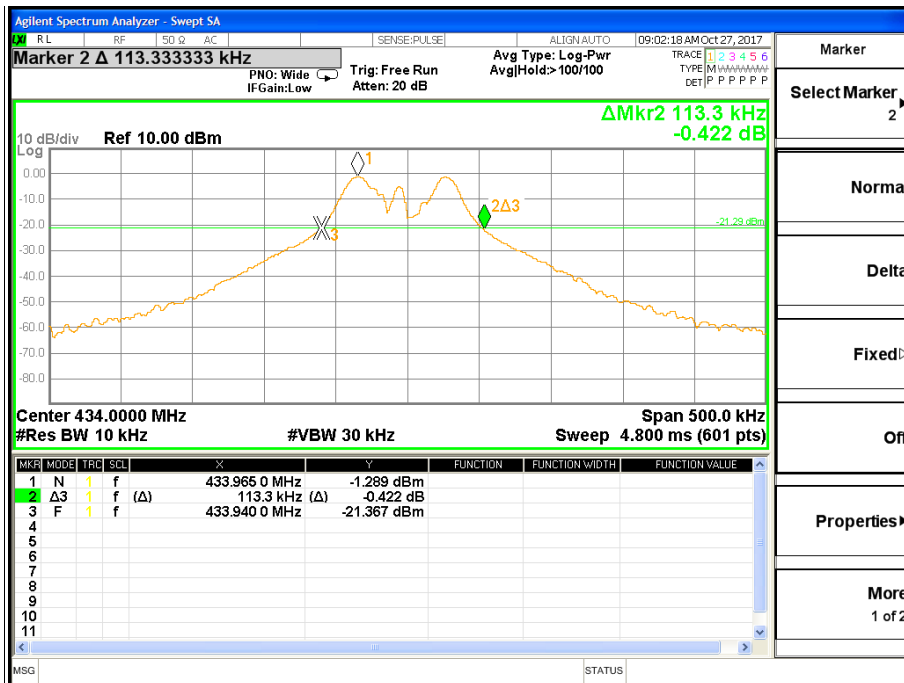

## 6. TRANSMITTER TIMEOUT

### 6.1 LIMIT

In addition, devices operated under the provisions of this paragraph shall be provided with a means For automatically limiting operation so that the duration of each transmission shall not be greater than one second and the silent period between transmissions shall be at least 30 times the duration of the but in no case less than 10 seconds.

### 6.2 TEST PROCEDURE

- (1) Put the EUT on the support in its standard position with associated equipment and switched on.
- (2) Set center frequency of spectrum analyzer = operating frequency.
- (3) Set the spectrum analyzer as RBW=100kHz, VBW=100kHz, Span=0Hz, Adjust Sweep=120s.
- (4) record the duration time

### 6.3 TEST SETUP

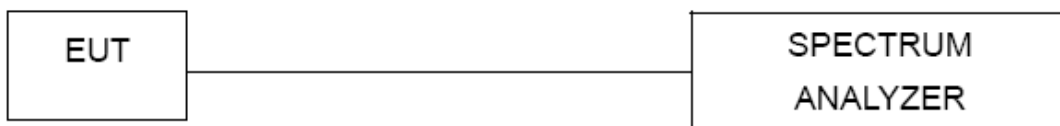





6.4 TEST RESULTS

EUT:	TPMS Sensor	Model Name:	CG-1301
Temperature:	25 °C	Relative Humidity:	53%
Pressure:	1020 hPa	Test Mode:	TX

Frequency(MHz)	Each transmission time(s)	silent period between transmissions(s)
434	0.24	11.82
Limit	<1s	>10s and > 30*(duration of transmission)
Result	Pass	

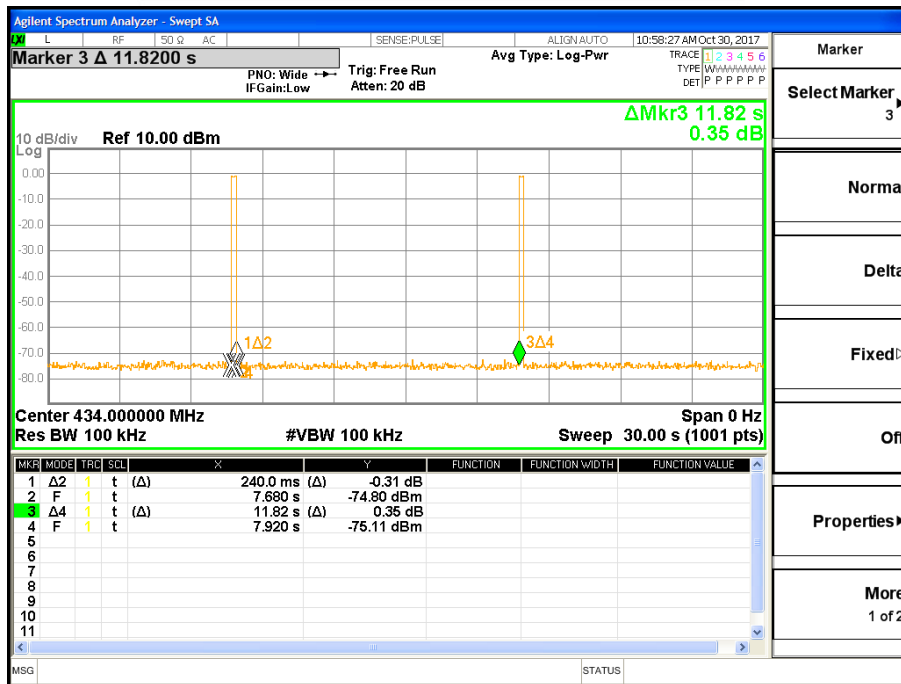



## 7. PERIODIC OPERATION

### 7.1 TEST PROCEDURE

The EUT was directly connected to the spectrum analyzer and antenna output port as show in the block diagram below.

The Duty Cycle Was Determined By The Following Equation: To Calculate The Actual Field Intensity,The Duty Cycle Correction Factor In Decibel Is Needed For Later Use And Can Be Obtained From Following Conversion

Duty Cycle(%)=Total On Interval In A Complete Pulse Train/ Length Of A Complete Pulse Train \* %

Duty Cycle Correction Factor(Db)=20 \* Log10(Duty Cycle(%))

### 7.2 TEST SETUP

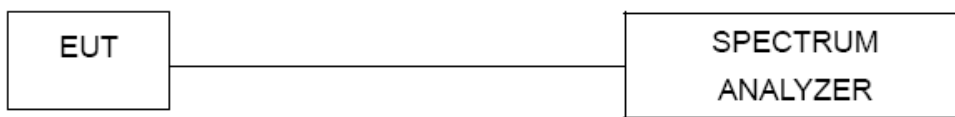

### 7.3 EUT OPERATION CONDITIONS

TX mode.





7.4 TEST RESULTS

FCC Part15.231(e)	
Total On interval in a complete pulse train(ms)	16.4
Length of a complete pulse train(ms)	100
Duty Cycle(%)	16.40%
Duty Cycle Correction Factor(dB)	-15.70

Refer to the duty cycle plot (as below), This device meets the FCC requirement. Length of a complete pulse train

Remark: FCC part15.35(c) required that a complete pulse train is more than 0.1 seconds, the measured field strength shall be determined from the average absolute voltage during a 0.1 second interval during which the field strength is at its maximum value.

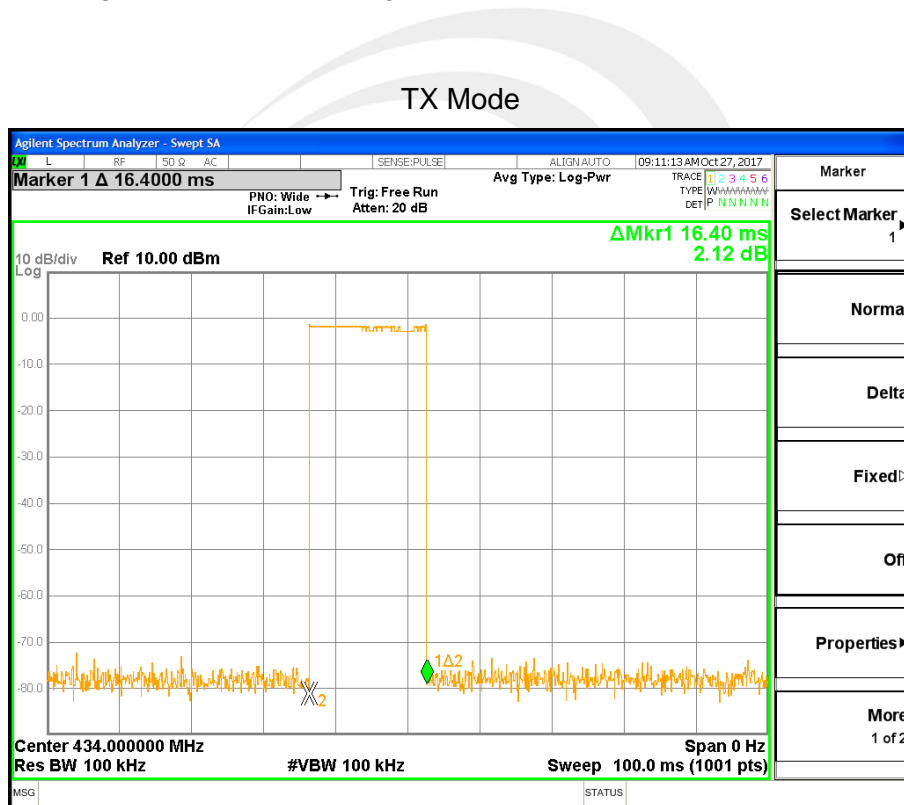



## 8. ANTENNA REQUIREMENT

### 8.1 STANDARD REQUIREMENT

According to the FCC Part 15 Paragraph 15.203, an intentional radiator shall be designed to ensure that no antenna other than that furnished by the responsible party shall be used with the device. The use of a permanently attached antenna to the intentional radiator shall be considered sufficient to comply with the provisions of this section. This product use a permanent ceramic printed antenna, fulfill the requirement of this section

### 8.2 EUT ANTENNA

The EUT antenna is Omnidirectional antenna.It conforms to the standard requirements.



## APPENDIX 1- PHOTOS OF TEST SETUP

### Radiated Measurement Photos

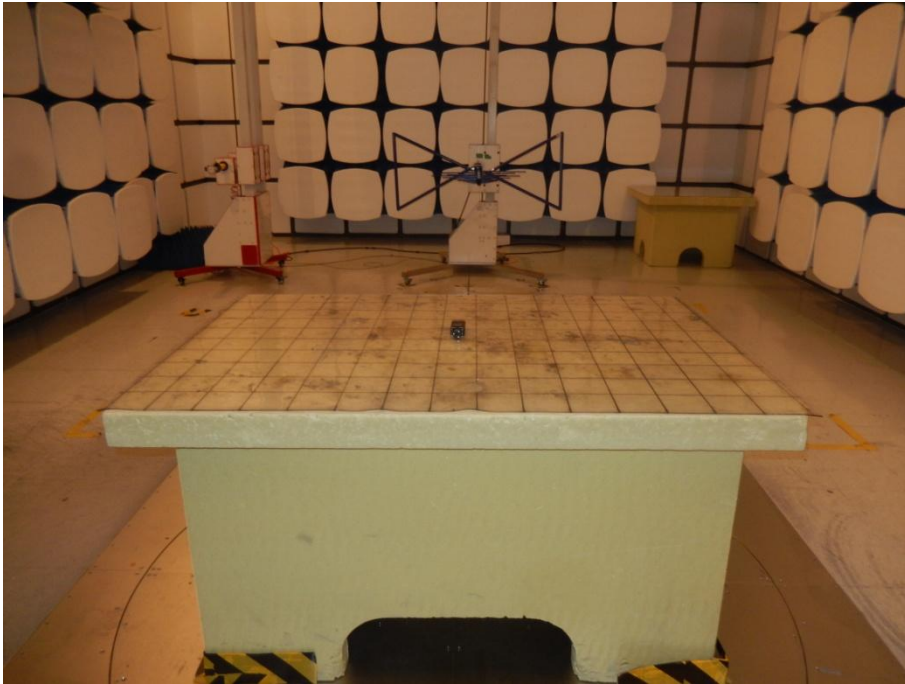

\*\*\*\*\*END OF THE REPORT\*\*\*\*\*