



# TEST REPORT

## FOR FCC PART 15 SUBPART C 15.249

Report Reference No. ....: **CTL1706238022-WF**

Compiled by:  
( position+printed name+signature)

Allen Wang  
(File administrators)

*Allen Wang*

Tested by:  
( position+printed name+signature)

Nice Nong  
(Test Engineer)

*Nice Nong*

Approved by:  
( position+printed name+signature)

Ivan Xie  
(Manager)

*Ivan Xie*

Product Name.....: 8-Button transmitter

Model/Type reference .....: MH-240

List Model(s).....: N/A

Trade Mark .....: N/A

FCC ID .....: **2AM2X-MH-240**

Applicant's name .....: **MhomeElectronic Technology Co., LTD**

Address of applicant .....: Building B, Tangwei Industrial Zone, Dongyuan Road, Shipai Town, Dongguan City, Guangdong China

Test Firm .....: **Shenzhen CTL Testing Technology Co., Ltd.**

Address of Test Firm .....: Floor 1-A, Baisha Technology Park, No.3011, Shahexi Road, Nanshan District, Shenzhen, China 518055

Test specification .....

Standard.....: **FCC Part 15.249:**Operation within the bands 920-928 MHz, 2400-2483.5 MHz, 5725-5850 MHz and 24.0 - 24.25 GHz.

TRF Originator .....: Shenzhen CTL Testing Technology Co., Ltd.

Master TRF .....: Dated 2011-01

Date of Receipt.....: Jul. 01, 2017

Date of Test Date.....: Jul. 02, 2017 –Jul. 12, 2017

Data of Issue.....: Jul. 13, 2017

Result.....: Pass

**Shenzhen CTL Testing Technology Co., Ltd. All rights reserved.**

This publication may be reproduced in whole or in part for non-commercial purposes as long as the Shenzhen CTL Testing Technology Co., Ltd. is acknowledged as copyright owner and source of the material. Shenzhen CTL Testing Technology Co., Ltd. takes no responsibility for and will not assume liability for damages resulting from the reader's interpretation of the reproduced material due to its placement and context.

# TEST REPORT

<b>Test Report No.:</b>	<b>CTL1706238022-WF</b>	Jul. 13, 2017
		Date of issue

Equipment under Test : 8-Button transmitter

Model /Type : MH-240

Listed Models : N/A

**Applicant** : **MhomeElectronic Technology Co., LTD**

Address : Building B, Tangwei Industrial Zone, Dongyuan Road, Shipai Town, Dongguan City, Guangdong China

**Manufacturer** : **MhomeElectronic Technology Co., LTD**

Address : Building B, Tangwei Industrial Zone, Dongyuan Road, Shipai Town, Dongguan City, Guangdong China

<b>Test result</b>	<b>Pass *</b>
--------------------	---------------

\* In the configuration tested, the EUT complied with the standards specified page 5.

The test report merely corresponds to the test sample.

It is not permitted to copy extracts of these test result without the written permission of the test laboratory.

**\*\* Modified History \*\***

Revision	Description	Issued Data	Report No.	Remark
Version 1.0	Initial Test Report Release	2017-07-13	CTL1706238022-WF	Tracy Qi



## Table of Contents

Page

<b>1. SUMMARY.....</b>	<b>5</b>
1.1. TEST STANDARDS.....	5
1.2. TEST DESCRIPTION.....	5
1.3. TEST FACILITY.....	6
1.4. STATEMENT OF THE MEASUREMENT UNCERTAINTY.....	6
<b>2. GENERAL INFORMATION.....</b>	<b>7</b>
2.1. ENVIRONMENTAL CONDITIONS.....	7
2.2. GENERAL DESCRIPTION OF EUT.....	7
2.3. DESCRIPTION OF TEST MODES AND TEST FREQUENCY.....	7
2.4. EQUIPMENTS USED DURING THE TEST.....	8
2.5. RELATED SUBMITTAL(S) / GRANT(S).....	8
2.6. MODIFICATIONS.....	8
<b>3. TEST CONDITIONS AND RESULTS.....</b>	<b>9</b>
3.1. CONDUCTED EMISSIONS TEST.....	9
3.2. RADIATED EMISSIONS AND BAND EDGE.....	10
3.3. OCCUPIED BANDWIDTH MEASUREMENT.....	15
3.4. ANTENNA REQUIREMENT.....	16
<b>4. TEST SETUP PHOTOS OF THE EUT.....</b>	<b>17</b>
<b>5. EXTERNAL AND INTERNAL PHOTOS OF THE EUT.....</b>	<b>18</b>

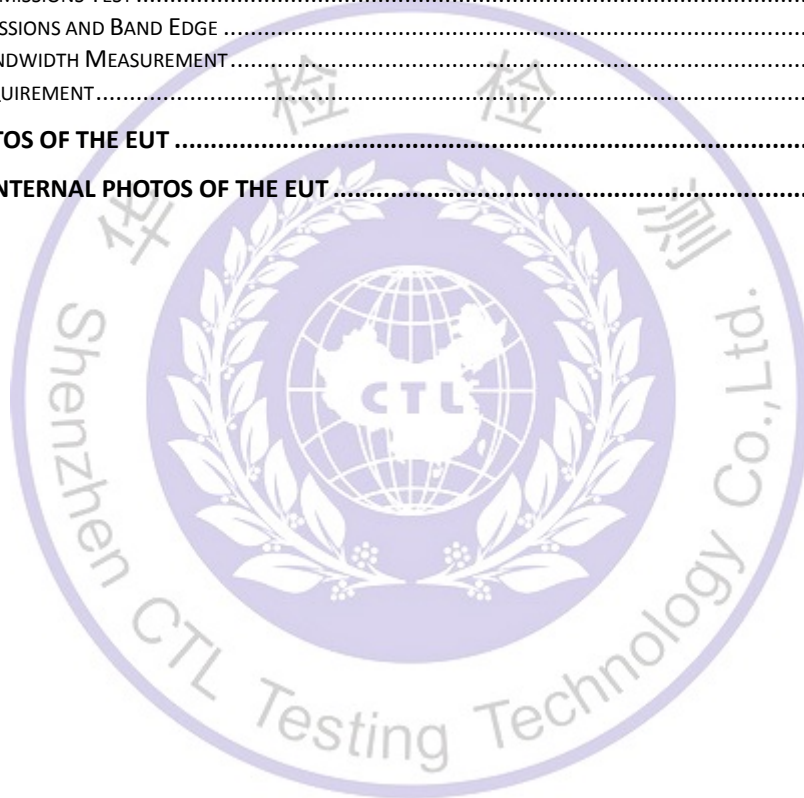

# 1. SUMMARY

## 1.1. TEST STANDARDS

The tests were performed according to following standards:

**FCC Rules Part 15.249:** Operation within the bands 902 - 928 MHz, 2400 - 2483.5 MHz, 5725 - 5875 MHz, and 24.0 - 24.25 GHz.

**ANSI C63.10:2013 :** American National Standard for Testing Unlicensed Wireless Devices

**ANSI C63.4: 2014:** –American National Standard for Methods of Measurement of Radio-Noise Emissions from Low-Voltage Electrical and Electronic Equipment in the Range of 9 kHz to 40GHz  
Range of 9 kHz to 40GHz

## 1.2. Test Description

<b>FCC PART 15.249</b>		
FCC Part 15.249(a)	Field Strength of Fundamental	PASS
FCC Part 15.209	Spurious Emission	PASS
FCC Part 15.209	Band edge	PASS
FCC Part 15.215(c)	20dB bandwidth	PASS
FCC Part 15.207	Conducted Emission	N/A
FCC Part 15.203	Antenna Requirement	PASS

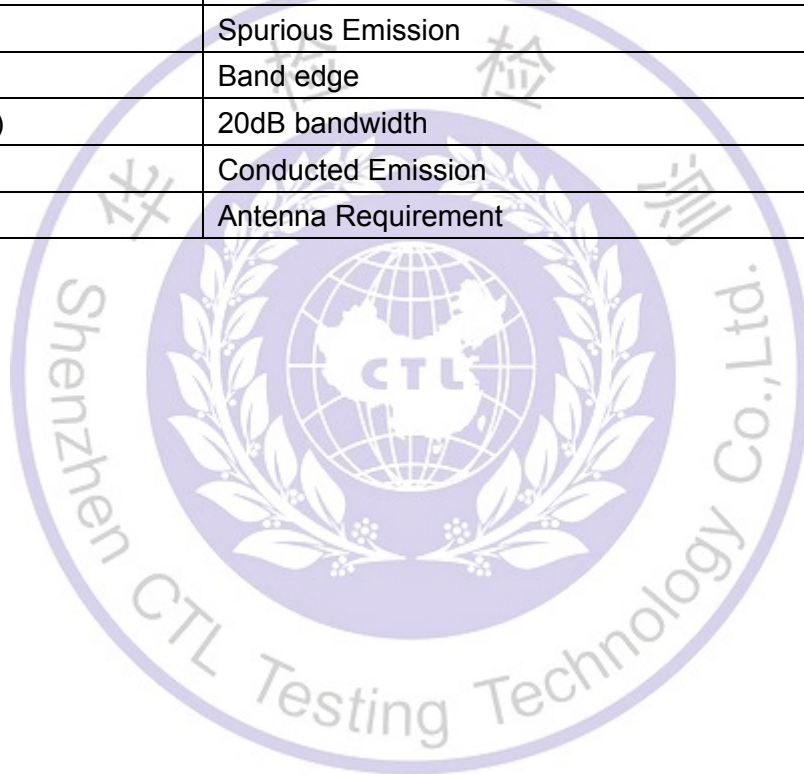

## 1.3. Test Facility

### 1.3.1 Address of the test laboratory

Shenzhen CTL Testing Technology Co., Ltd.

Floor 1-A, Baisha Technology Park, No. 3011, Shahexi Road, Nanshan, Shenzhen 518055 China

There is one 3m semi-anechoic chamber and two line conducted labs for final test. The Test Sites meet the requirements in documents ANSI C63.4 and CISPR 32/EN 55032 requirements.

### 1.3.2 Laboratory accreditation

The test facility is recognized, certified, or accredited by the following organizations:

#### IC Registration No.: 9618B

The 3m alternate test site of Shenzhen CTL Testing Technology Co., Ltd. EMC Laboratory has been registered by Certification and Engineer Bureau of Industry Canada for the performance of with Registration No.: 9618B on November 13, 2013.

#### FCC-Registration No.: 970318

Shenzhen CTL Testing Technology Co., Ltd. EMC Laboratory has been registered and fully described in a report filed with the (FCC) Federal Communications Commission. The acceptance letter from the FCC is maintained in our files. Registration 970318, December 19, 2013.

## 1.4. Statement of the measurement uncertainty

The data and results referenced in this document are true and accurate. The reader is cautioned that there may be errors within the calibration limits of the equipment and facilities. The measurement uncertainty was calculated for all measurements listed in this test report acc. to CISPR 16 - 4 „Specification for radio disturbance and immunity measuring apparatus and methods – Part 4: Uncertainty in EMC Measurements“ and is documented in the Shenzhen CTL Testing Technology Co., Ltd. quality system acc. to DIN EN ISO/IEC 17025. Furthermore, component and process variability of devices similar to that tested may result in additional deviation. The manufacturer has the sole responsibility of continued compliance of the device.

Hereafter the best measurement capability for CTL laboratory is reported:

Test	Range	Measurement Uncertainty	Notes
Radiated Emission	30~1000MHz	4.10dB	(1)
Radiated Emission	Above 1GHz	4.32dB	(1)
Conducted Disturbance	0.15~30MHz	3.20dB	(1)

(1) This uncertainty represents an expanded uncertainty expressed at approximately the 95% confidence level using a coverage factor of k=2.

## 2. GENERAL INFORMATION

### 2.1. Environmental conditions

During the measurement the environmental conditions were within the listed ranges:

Normal Temperature:	25°C
Relative Humidity:	55 %
Air Pressure:	101 kPa

### 2.2. General Description of EUT

Product Name:	8-Button transmitter
Model/Type reference:	MH-240
Power supply:	DC 3.0V from battery
<b>2.4GHz wireless</b>	
Operation frequency:	2410MHz
Modulation:	GFSK
Channel number:	1
Antenna type:	Integral Antenna
Antenna gain:	0dBi

Note: For more details, please refer to the user's manual of the EUT.

### 2.3. Description of Test Modes and Test Frequency

The Applicant provides communication tools software to control the EUT for staying in continuous transmitting (Duty Cycle more than 98%) and receiving mode for testing.

#### Operation Frequency :

Channel	Frequency (MHz)
<b>01</b>	<b>2410</b>

NOTE: NEW BATTERY IS USED DURING ALL TEST

## 2.4. Equipments Used during the Test

Test Equipment	Manufacturer	Model No.	Serial No.	Calibration Date	Calibration Due Date
LISN	R&S	ENV216	3560.6550.1 2	2017/06/02	2018/06/01
LISN	R&S	ESH2-Z5	860014/010	2017/06/02	2018/06/01
Bilog Antenna	Sunol Sciences Corp.	JB1	A061713	2017/06/02	2018/06/01
EMI Test Receiver	R&S	ESCI	103710	2017/06/02	2018/06/01
Spectrum Analyzer	Agilent	E4407B	MY41440676	2017/05/21	2018/05/20
Spectrum Analyzer	Agilent	N9020	US46220290	2017/01/16	2018/01/15
Controller	EM Electronics	Controller EM 1000	N/A	2017/05/21	2018/05/20
Horn Antenna	Sunol Sciences Corp.	DRH-118	A062013	2017/05/19	2018/05/18
Active Loop Antenna	SCHWARZBECK	FMZB1519	1519-037	2017/05/19	2018/05/18
Amplifier	Agilent	8349B	3008A02306	2017/05/19	2018/05/18
Amplifier	Agilent	8447D	2944A10176	2017/05/19	2018/05/18
Temperature/Humidity Meter	Gangxing	CTH-608	02	2017/05/20	2018/05/19
High-Pass Filter	K&L	9SH10-2700/X1 2750-O/O	N/A	2017/05/20	2018/05/19
High-Pass Filter	K&L	41H10-1375/U1 2750-O/O	N/A	2017/05/20	2018/05/19
Coaxial Cables	HUBER+SUHNER	SUCOFLEX 104PEA-10M	10m	2017/06/02	2018/06/01
Coaxial Cables	HUBER+SUHNER	SUCOFLEX 104PEA-3M	3m	2017/06/02	2018/06/01
Coaxial Cables	HUBER+SUHNER	SUCOFLEX 104PEA-3M	3m	2017/06/02	2018/06/01
RF Cable	Megalon	RF-A303	N/A	2017/06/02	2018/06/01

The calibration interval was one year

## 2.5. Related Submittal(s) / Grant(s)

This submittal(s) (test report) is intended to comply with Section 15.249 of the FCC Part 15, Subpart C Rules.

## 2.6. Modifications

No modifications were implemented to meet testing criteria.



### 3. TEST CONDITIONS AND RESULTS

#### 3.1. Conducted Emissions Test

##### LIMIT

FCC CFR Title 47 Part 15 Subpart C Section 15.207

Frequency range (MHz)	Limit (dBuV)	
	Quasi-peak	Average
0.15-0.5	66 to 56*	56 to 46*
0.5-5	56	46
5-30	60	50

\* Decreases with the logarithm of the frequency.

##### TEST CONFIGURATION

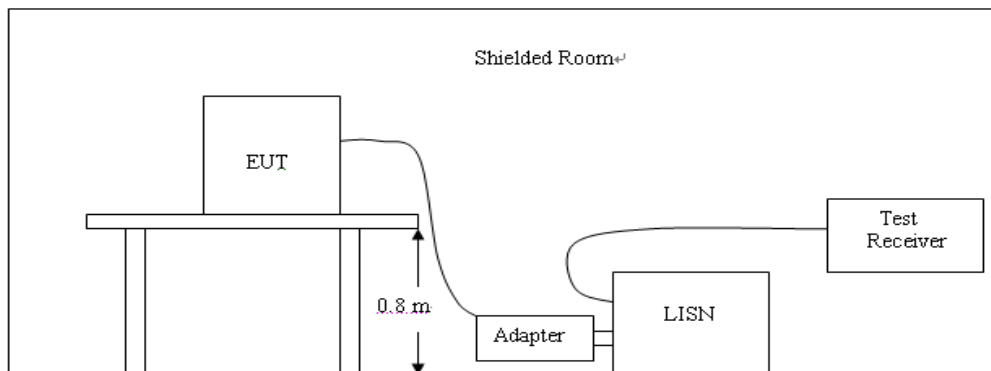

##### TEST PROCEDURE

1. The equipment was set up as per the test configuration to simulate typical actual usage per the user's manual. The EUT is a tabletop system; a wooden table with a height of 0.8 meters is used and is placed on the ground plane as per ANSI C63.10:2013.
2. Support equipment, if needed, was placed as per ANSI C63.10:2013.
3. All I/O cables were positioned to simulate typical actual usage as per ANSI C63.10:2013.
4. If a EUT received DC power from the USB Port of Notebook PC, the PC's adapter received AC120V/60Hz power through a Line Impedance Stabilization Network (LISN) which supplied power source and was grounded to the ground plane.
5. All support equipments received AC power from a second LISN, if any.
6. The EUT test program was started. Emissions were measured on each current carrying line of the EUT using a spectrum Analyzer / Receiver connected to the LISN powering the EUT. The LISN has two monitoring points: Line 1 (Hot Side) and Line 2 (Neutral Side). Two scans were taken: one with Line 1 connected to Analyzer / Receiver and Line 2 connected to a 50 ohm load; the second scan had Line 1 connected to a 50 ohm load and Line 2 connected to the Analyzer / Receiver.
7. Analyzer / Receiver scanned from 150 KHz to 30MHz for emissions in each of the test modes.
8. During the above scans, the emissions were maximized by cable manipulation.

##### TEST RESULTS

Not applicable to this device, which is powered by battery.

## 3.2. Radiated Emissions and Band Edge

### Limit

According 15.249, the field strength of emissions from intentional radiators operated within 2400MHz-2483.5 MHz shall not exceed 94dB $\mu$ V/m (50mV/m):

FCC PART 15.249(d) Emissions radiated outside of the specified frequency bands, except for harmonics, shall be attenuated by at least 50 dB below the level of the fundamental or to the general radiated emission limits in §15.209, whichever is the lesser attenuation.

In addition, radiated emissions which fall in the restricted bands, as defined in §15.205(a), must also comply with the radiated emission limits specified in §15.209(a)

Radiated emission limits

Frequency (MHz)	Distance (Meters)	Radiated (dB $\mu$ V/m)	Radiated ( $\mu$ V/m)
0.009-0.49	3	$20\log(2400/F(\text{KHz}))+40\log(300/3)$	$2400/F(\text{KHz})$
0.49-1.705	3	$20\log(24000/F(\text{KHz}))+40\log(30/3)$	$24000/F(\text{KHz})$
1.705-30	3	$20\log(30)+40\log(30/3)$	30
30-88	3	40.0	100
88-216	3	43.5	150
216-960	3	46.0	200
Above 960	3	54.0	500

### TEST CONFIGURATION

(A) Radiated Emission Test Set-Up, Frequency Below 30MHz

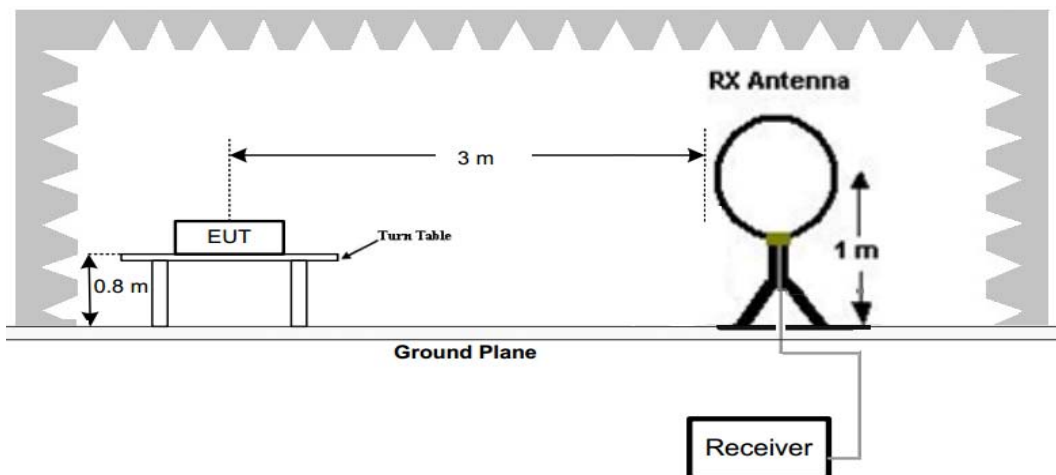

(B) Radiated Emission Test Set-Up, Frequency below 1000MHz

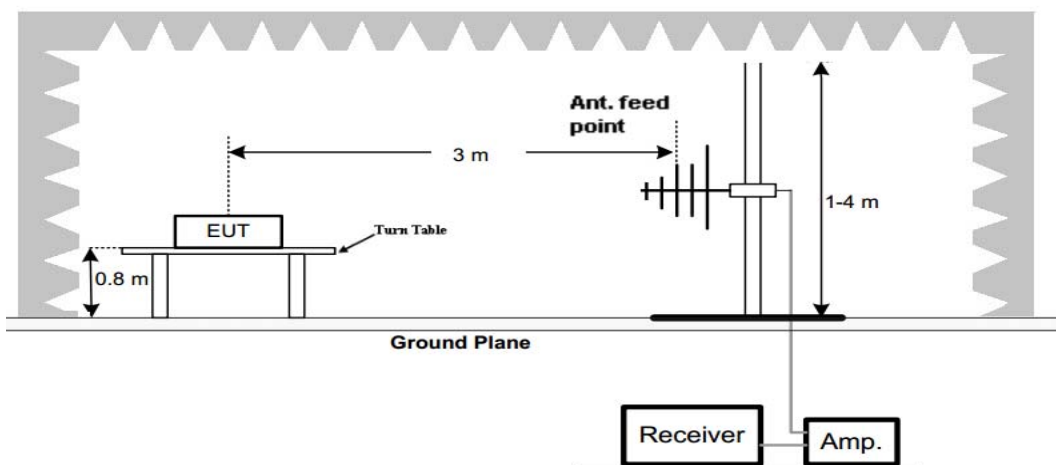

## (C) Radiated Emission Test Set-Up, Frequency above 1000MHz

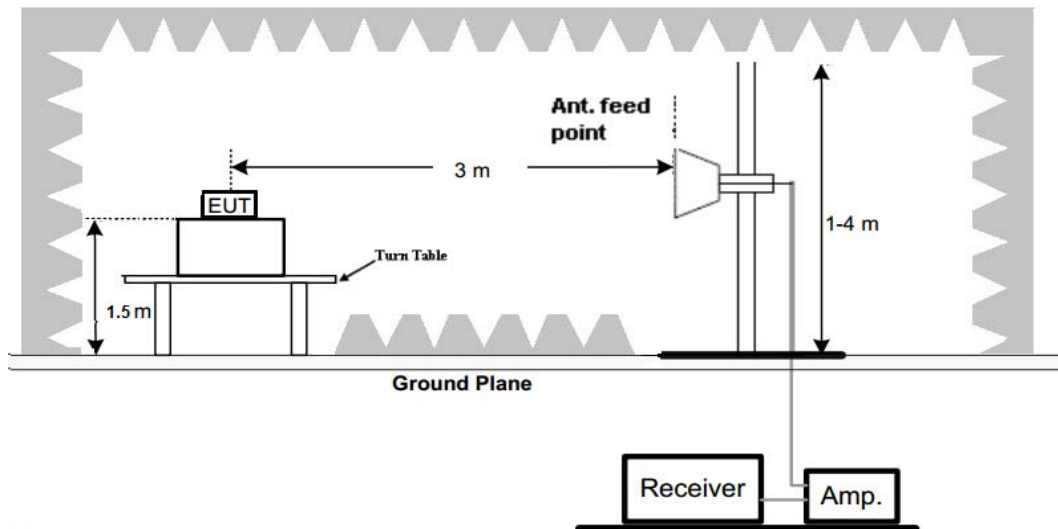
**Test Procedure**

1. Below 1GHz measurement the EUT is placed on a turntable which is 0.8m above ground plane, and above 1GHz measurement EUT was placed on a low permittivity and low loss tangent turn table which is 1.5m above ground plane.
2. Maximum procedure was performed by raising the receiving antenna from 1m to 4m and rotating the turn table from 0° to 360° to acquire the highest emissions from EUT
3. And also, each emission was to be maximized by changing the polarization of receiving antenna both horizontal and vertical.
4. Repeat above procedures until all frequency measurements have been completed.

**TEST RESULTS**

1. Radiated emission test from 9 KHz to 10th harmonic of fundamental was verified, and no emission found except system noise floor in 9 KHz to 30MHz and not recorded in this report.

For 30MHz-1GHz

Horizontal

**SWEEP TABLE: "test (30M-1G)"**

Short Description:		Field Strength				Transducer
Start	Stop	Detector	Meas. Time	IF Bandw.		
Frequency 30.0 MHz	Frequency 1.0 GHz	MaxPeak	300.0 ms	120 kHz	JB1	

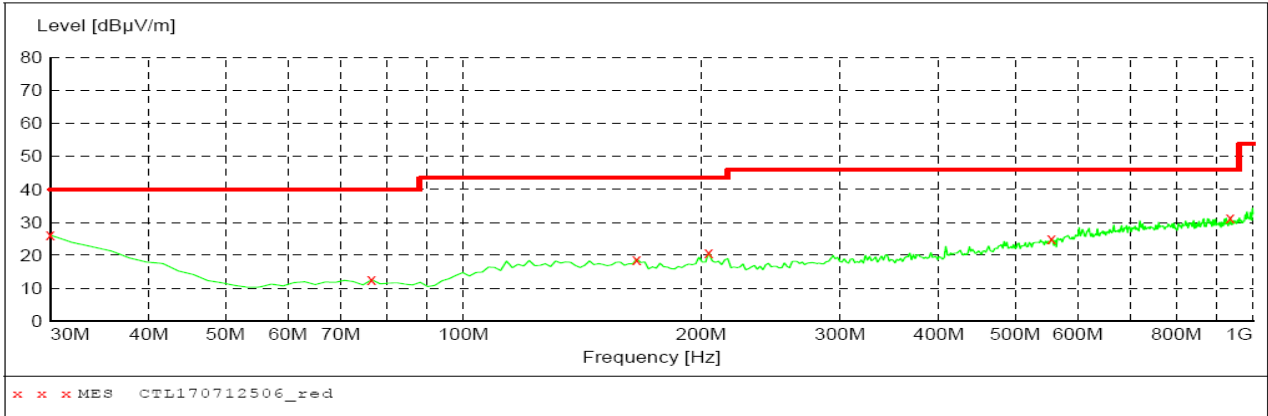

**MEASUREMENT RESULT: "CTL170712506\_red"**

7/12/2017 11:53AM

Frequency MHz	Level dBµV/m	Transd dB	Limit dBµV/m	Margin dB	Det.	Height cm	Azimuth deg	Polarization
30.000000	26.10	22.1	40.0	13.9	---	0.0	0.00	HORIZONTAL
76.560000	12.60	9.0	40.0	27.4	---	0.0	0.00	HORIZONTAL
165.800000	18.80	14.5	43.5	24.7	---	0.0	0.00	HORIZONTAL
204.600000	20.80	14.6	43.5	22.7	---	0.0	0.00	HORIZONTAL
555.740000	24.90	22.0	46.0	21.1	---	0.0	0.00	HORIZONTAL
935.980000	31.50	27.0	46.0	14.5	---	0.0	0.00	HORIZONTAL

Vertical

**SWEEP TABLE: "test (30M-1G)"**

Short Description:		Field Strength				Transducer
Start	Stop	Detector	Meas. Time	IF Bandw.		
Frequency 30.0 MHz	Frequency 1.0 GHz	MaxPeak	300.0 ms	120 kHz	JB1	

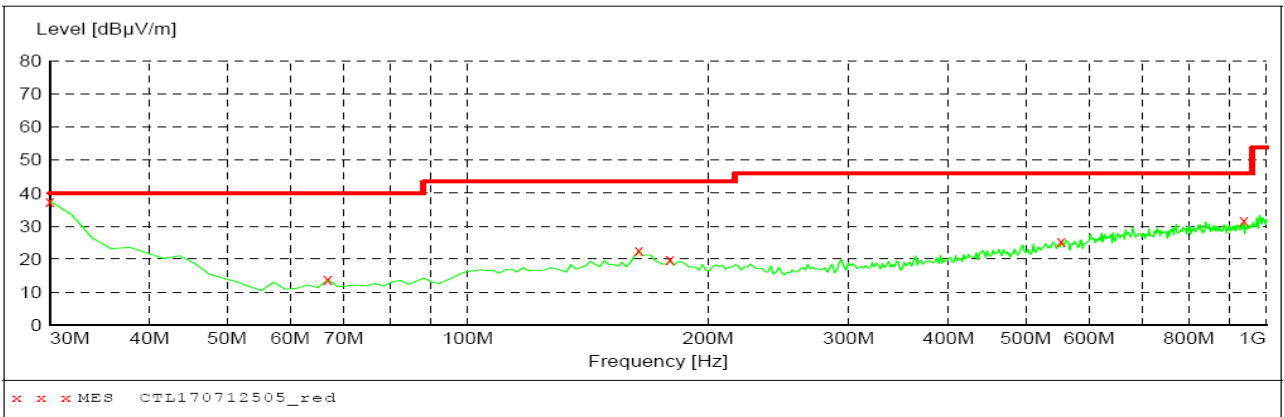

**MEASUREMENT RESULT: "CTL170712505\_red"**

7/12/2017 11:53AM

Frequency MHz	Level dBµV/m	Transd dB	Limit dBµV/m	Margin dB	Det.	Height cm	Azimuth deg	Polarization
30.000000	37.50	22.1	40.0	2.5	---	0.0	0.00	VERTICAL
66.860000	13.80	8.6	40.0	26.2	---	0.0	0.00	VERTICAL
163.860000	22.50	14.5	43.5	21.0	---	0.0	0.00	VERTICAL
179.380000	19.80	14.6	43.5	23.7	---	0.0	0.00	VERTICAL
553.800000	25.20	21.9	46.0	20.8	---	0.0	0.00	VERTICAL
937.920000	31.60	27.0	46.0	14.4	---	0.0	0.00	VERTICAL

**For 1GHz to 25GHz****GFSK (above 1GHz)**

Frequency(MHz):			2410		Polarity:			HORIZONTAL	
Frequency (MHz)	Emission Level (dBUV/m)		Limit (dBUV/m)	Margin (dB)	Raw Value (dBUV)	Antenna Factor (dB/m)	Cable Factor (dB)	Pre-amplifier (dB)	Correction Factor (dB/m)
4820.00	56.25	PK	74	17.75	51.71	33.51	6.92	35.89	4.54
4820.00	47.52	AV	54	6.48	42.98	33.51	6.92	35.89	4.54
5144.50	44.15	PK	74	29.85	36.90	34.42	7.11	34.28	7.25
5144.50	--	AV	54	--	--	--	--	--	--
7230.00	50.18	PK	74	23.82	38.94	37.07	9.19	35.02	11.24
7230.00	--	AV	54	--	--	--	--	--	--

Frequency(MHz):			2410		Polarity:			VERTICAL	
Frequency (MHz)	Emission Level (dBUV/m)		Limit (dBUV/m)	Margin (dB)	Raw Value (dBUV)	Antenna Factor (dB/m)	Cable Factor (dB)	Pre-amplifier (dB)	Correction Factor (dB/m)
4820.00	56.89	PK	74	17.11	52.35	33.51	6.92	35.89	4.54
4820.00	47.78	AV	54	6.22	43.24	33.51	6.92	35.89	4.54
5144.50	44.66	PK	74	29.34	37.41	34.42	7.11	34.28	7.25
5144.50	--	AV	54	--	--	--	--	--	--
7230.00	50.73	PK	74	23.27	39.49	37.07	9.19	35.02	11.24
7230.00	--	AV	54	--	--	--	--	--	--

**REMARKS:**

1. Emission level (dBUV/m) =Raw Value (dBUV)+Correction Factor (dB/m)
2. Correction Factor (dB/m) = Antenna Factor (dB/m)+Cable Factor (dB)-Pre-amplifier Factor
3. Margin value = Limit value- Emission level.
4. -- Mean the PK detector measured value is below average limit.
5. The other emission levels were very low against the limit.
6. RBW1MHz VBW3MHz Peak detector is for PK value; RBW 1MHz VBW10Hz Peak detector is for AV value.

**Results of Band Edges Test (Radiated)**

Frequency(MHz):			2410		Polarity:			HORIZONTAL	
Frequency (MHz)	Emission Level (dBuV/m)		Limit (dBuV/m)	Margin (dB)	Raw Value (dBuV)	Antenna Factor (dB/m)	Cable Factor (dB)	Pre-amplifier (dB)	Correction Factor (dB/m)
2410.00	93.11	PK	114	20.89	94.98	28.84	4.65	35.37	-1.87
2410.00	85.12	AV	94	8.88	86.99	28.84	4.65	35.37	-1.87
2375.75	44.26	PK	74	29.74	46.40	28.63	4.58	35.35	-2.14
2375.75	--	AV	54	--	--	--	--	--	--
2390.00	43.65	PK	74	30.35	45.69	28.72	4.60	35.36	-2.04
2390.00	--	AV	54	--	--	--	--	--	--
2400.00	43.78	PK	74	30.22	45.75	28.78	4.61	35.36	-1.97
2400.00	--	AV	54	--	--	--	--	--	--
2483.50	44.69	PK	74	29.31	46.43	28.93	4.70	35.38	-1.74
2483.50	--	AV	54	--	--	--	--	--	--
2500.00	43.50	PK	74	30.50	45.20	28.96	4.72	35.38	-1.70
2500.00	--	AV	54	--	--	--	--	--	--

Frequency(MHz):			2410		Polarity:			VERTICAL	
Frequency (MHz)	Emission Level (dBuV/m)		Limit (dBuV/m)	Margin (dB)	Raw Value (dBuV)	Antenna Factor (dB/m)	Cable Factor (dB)	Pre-amplifier (dB)	Correction Factor (dB/m)
2410.00	93.53	PK	114	20.47	95.40	28.84	4.65	35.37	-1.87
2410.00	85.41	AV	94	8.59	87.28	28.84	4.65	35.37	-1.87
2375.75	44.50	PK	74	29.50	46.64	28.63	4.58	35.35	-2.14
2375.75	--	AV	54	--	--	--	--	--	--
2390.00	43.44	PK	74	30.56	45.48	28.72	4.60	35.36	-2.04
2390.00	--	AV	54	--	--	--	--	--	--
2400.00	43.98	PK	74	30.02	45.95	28.78	4.61	35.36	-1.97
2400.00	--	AV	54	--	--	--	--	--	--
2483.50	44.55	PK	74	29.45	46.29	28.93	4.70	35.38	-1.74
2483.50	-	AV	54	--	--	--	--	--	--
2500.00	43.67	PK	74	30.33	45.37	28.96	4.72	35.38	-1.70
2500.00	--	AV	54	--	--	--	--	--	--

**REMARKS:**

1. Emission level (dBuV/m) =Raw Value (dBuV)+Correction Factor (dB/m)
2. Correction Factor (dB/m) = Antenna Factor (dB/m)+Cable Factor (dB)-Pre-amplifier Factor
3. Margin value = Limit value- Emission level.
4. -- Mean the PK detector measured value is below average limit.
5. The other emission levels were very low against the limit.
6. RBW1MHz VBW3MHz Peak detector is for PK value; RBW 1MHz VBW10Hz Peak detector is for AV value.
7. For fundamental frequency, RBW 3MHz VBW 3MHz Peak detector is for PK Value; RMS detector is for AV value.

Note: 20dB BW=6.13MHz is more than 3MHz , so correct factor =  $10\log 6.13/3=3.1$

SO FINAL VALUE OF Horizontal FOR 2410MHz

PK =  $93.11+3.1=96.21\text{dBuV/m}<114\text{dBuV/m}$  ; AV= $85.12+3.1=88.22\text{dBuV/m}<94\text{dBuV/m}$

SO FINAL VALUE OF Vertical FOR 2410MHz

PK =  $93.53+3.1=96.63\text{dBuV/m}<114\text{dBuV/m}$  ; AV= $85.41+3.1=88.51\text{dBuV/m}<94\text{dBuV/m}$

### 3.3. Occupied Bandwidth Measurement

**Limit**

N/A

**Test Configuration**

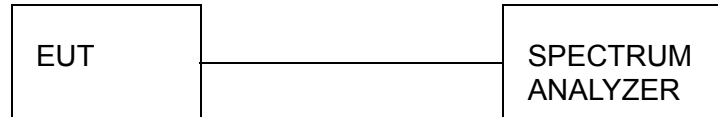

**Test Procedure**

The transmitter output was connected to the spectrum analyzer through an attenuator. The bandwidth of the fundamental frequency was measured by spectrum analyzer with 30 KHz RBW and 100 KHz VBW.

The 20dB bandwidth is defined as the total spectrum the power of which is higher than peak power minus 20dB.

**Test Results**

Modulation	Channel	99% OBW (MHz)	20dB bandwidth (MHz)	Result
GFSK	CH01	6.2137	6.126	Pass

Test plot as follows:

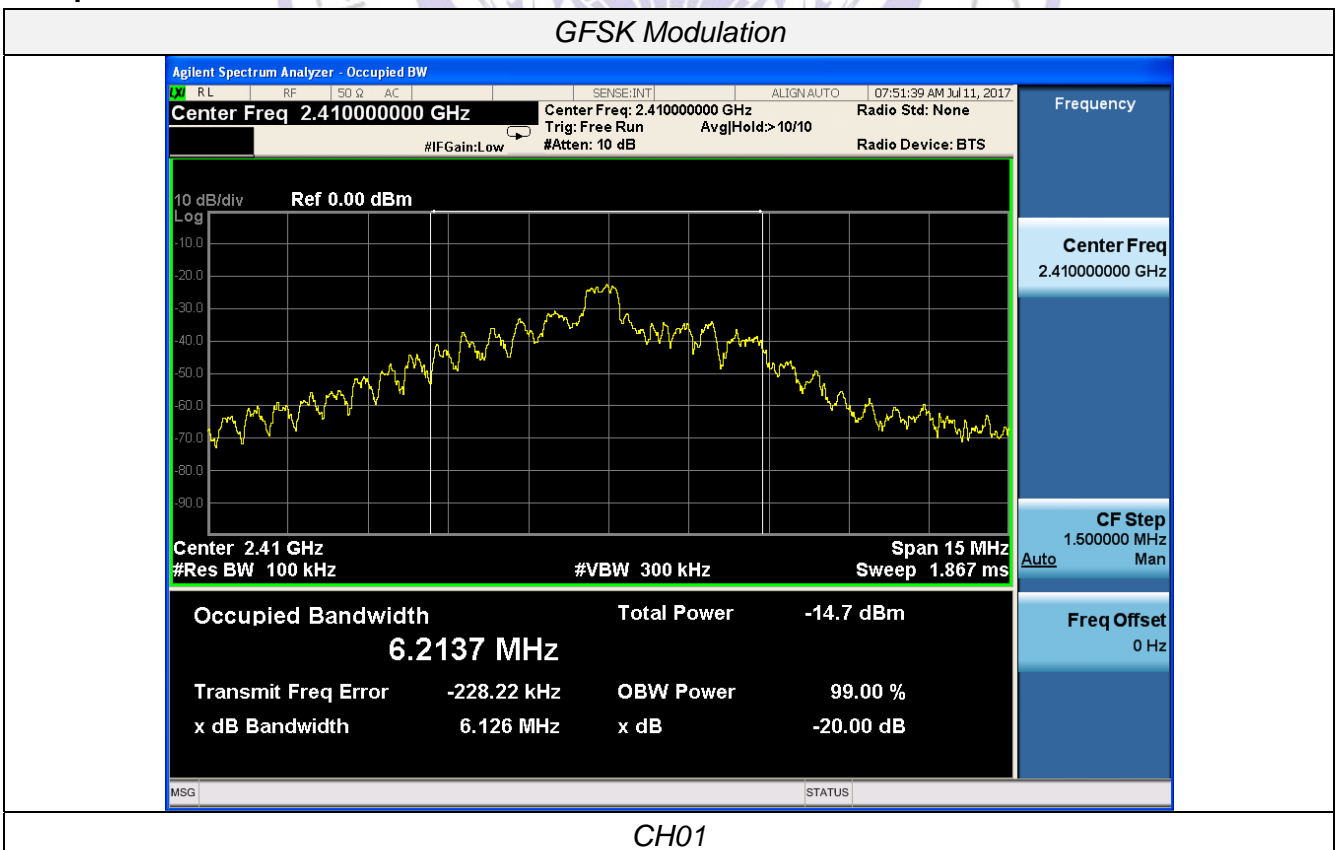

### 3.4. Antenna Requirement

#### Standard Applicable

For intentional device, according to FCC 47 CFR Section 15.203, an intentional radiator shall be designed to ensure that no antenna other than that furnished by the responsible party shall be used with the device.

#### **Refer to statement below for compliance.**

The manufacturer may design the unit so that the user can replace a broken antenna, but the use of a standard antenna jack or electrical connector is prohibited. Further, this requirement does not apply to intentional radiators that must be professionally installed.

#### Antenna Connected Construction

The antenna used in this product is an internal Antenna, The directional gains of antenna used for transmitting is 0dBi.

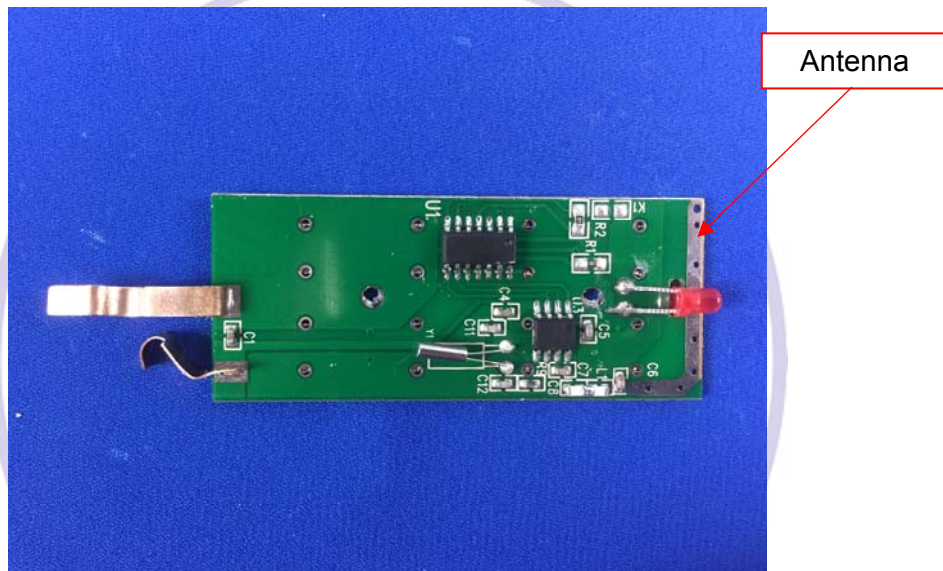



### 4. Test Setup Photos of the EUT

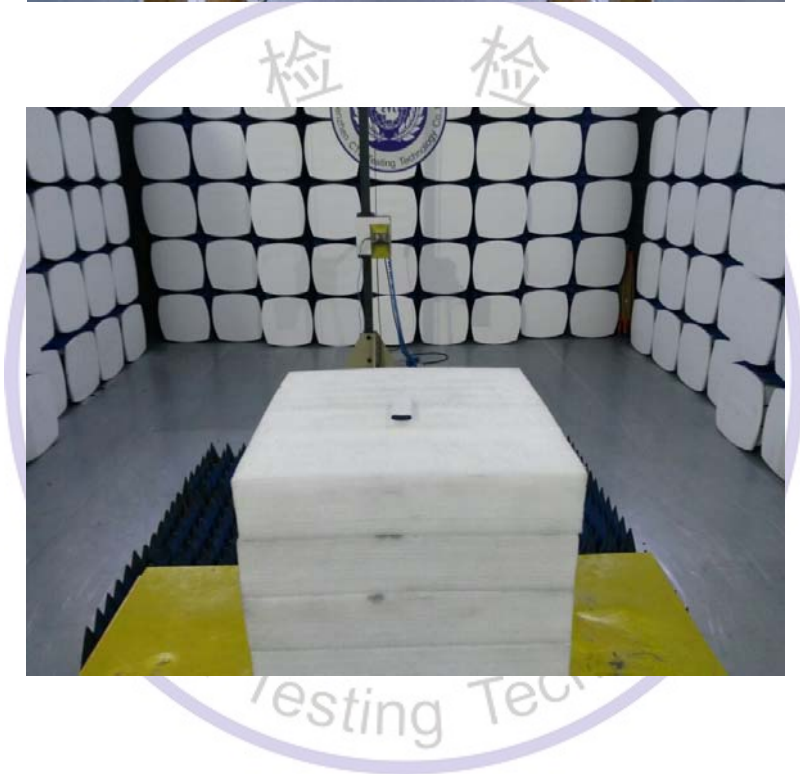
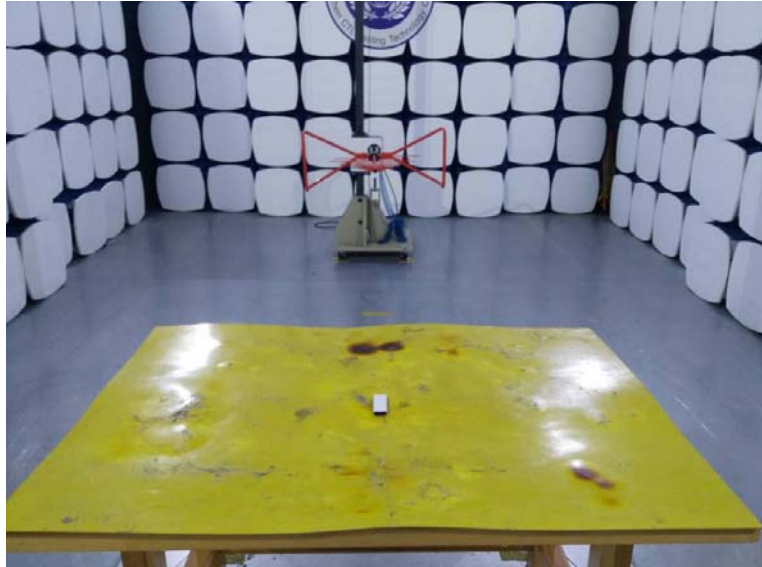

## 5. External and Internal Photos of the EUT

### External Photos of EUT

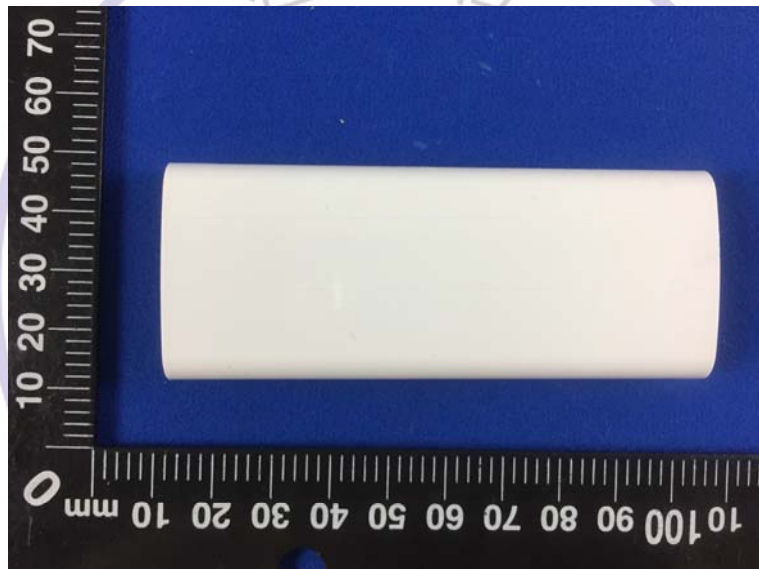
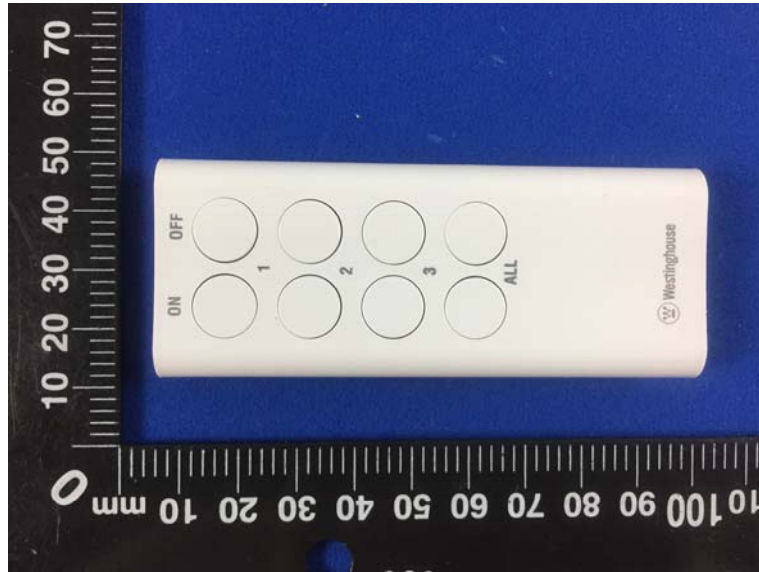



Internal Photos of EUT

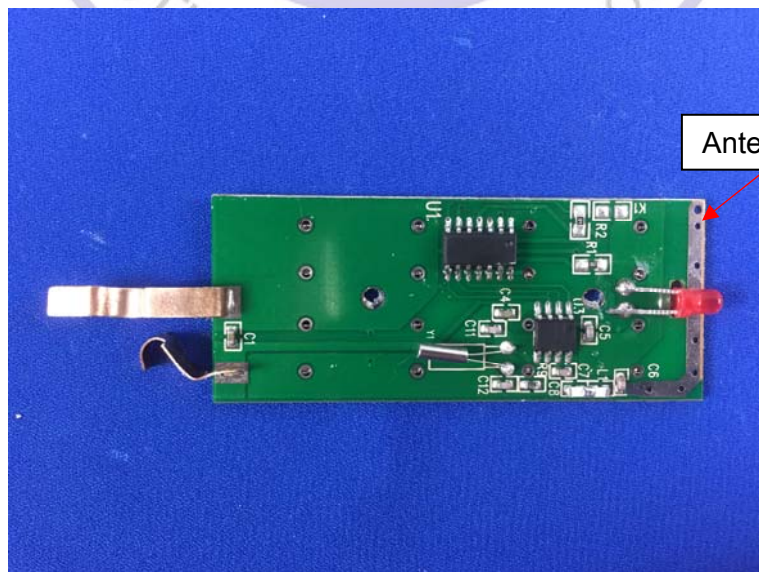
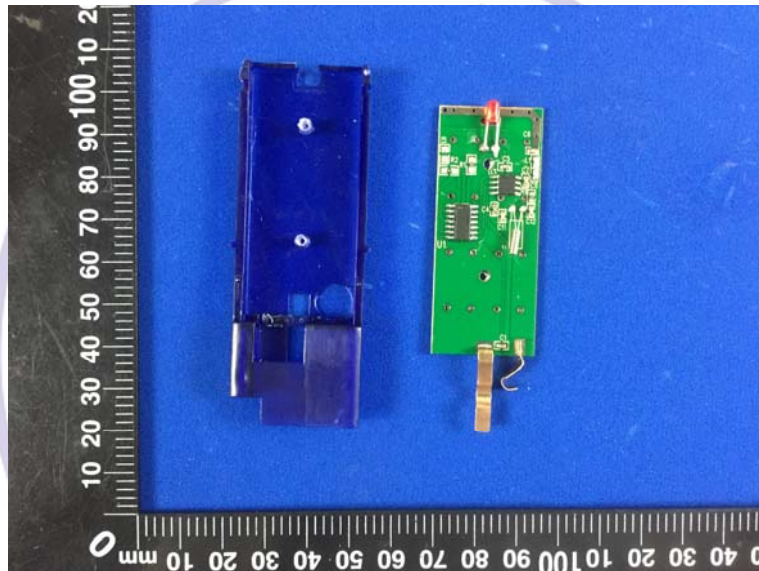
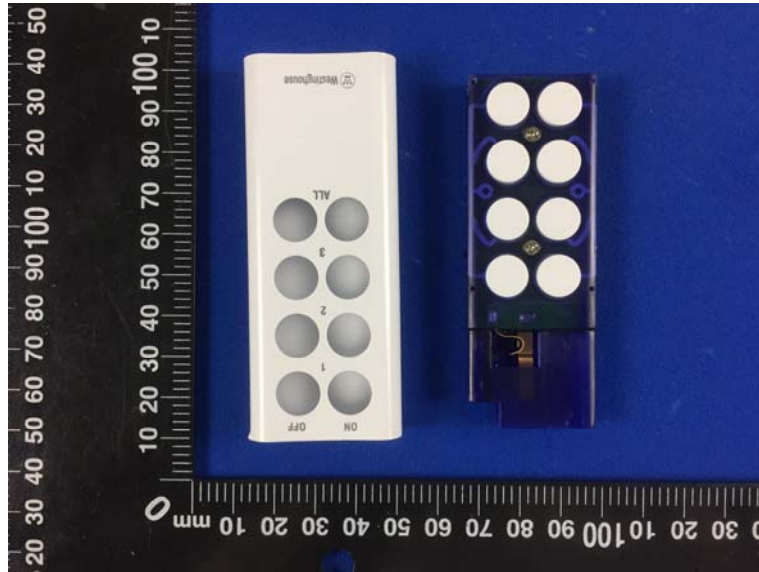

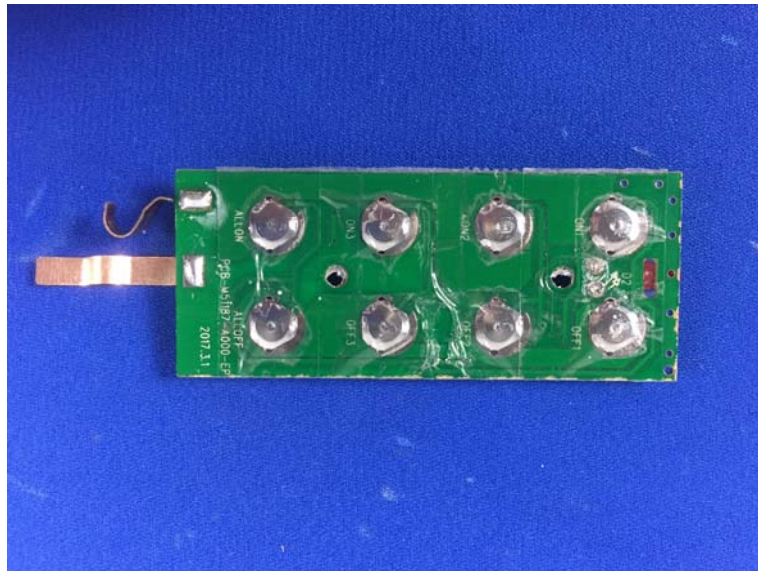

\*\*\*\*\* End of Report \*\*\*\*\*

