



FCC HAC (T-Coil) Test Report

Applicant No.: ZR/2021/50040
Applicant: Great Talent Technology Limited
Manufacturer: Great Talent Technology Limited
Product Name: smart phone
Model No.(EUT): U696CL
Trade Mark: UMX
FCC ID: 2ALZM-U696CL
Standards: ANSI C63.19-2011
CFR 47 FCC Part 20
Date of Receipt: 2021-07-02
Date of Test: 2021-07-26 to 2021-08-02
Date of Issue: 2021-08-10
Test conclusion: **PASS ***

* In the configuration tested, the EUT detailed in this report complied with the standards specified above.

Authorized Signature:

Derek Yang

Wireless Laboratory Manager

The manufacturer should ensure that all products in series production are in conformity with the product sample detailed in this report.

If the product in this report is used in any configuration other than that detailed in the report, the manufacturer must ensure the new system complies with all relevant standards. Any mention of SGS International Electrical Approvals or testing done by SGS International Electrical Approvals in connection with, distribution or use of the product described in this report must be approved by SGS International Electrical Approvals in writing.



Unless otherwise agreed in writing, this document is issued by the Company subject to its General Conditions of Service printed overleaf, available on request or accessible at <http://www.sgs.com/en/Terms-and-Conditions.aspx> and, for electronic format documents, subject to Terms and Conditions for Electronic Documents at <http://www.sgs.com/en/Terms-and-Conditions/Terms-e-Documents.aspx>. Attention is drawn to the limitation of liability, indemnification and jurisdiction issues defined therein. Any holder of this document is advised that information contained hereon reflects the Company's findings at the time of its intervention only and within the limits of Client's instructions, if any. The Company's sole responsibility is to its Client and this document does not exonerate parties to a transaction from exercising all their rights and obligations under the transaction documents. This document cannot be reproduced except in full, without prior written approval of the Company. Any unauthorized alteration, forgery or falsification of the content or appearance of this document is unlawful and offenders may be prosecuted to the fullest extent of the law. Unless otherwise stated the results shown in this test report refer only to the sample(s) tested and such sample(s) are retained for 30 days only.
Attention: To check the authenticity of testing /inspection report & certificate, please contact us at telephone: (86-755) 8307 1443, or email: CN.Doccheck@sgs.com

REVISION HISTORY

Revision Record				
Version	Chapter	Date	Modifier	Remark
01		2021-08-10		Original



Unless otherwise agreed in writing, this document is issued by the Company subject to its General Conditions of Service printed overleaf, available on request or accessible at <http://www.sgs.com/en/Terms-and-Conditions.aspx> and, for electronic format documents, subject to Terms and Conditions for Electronic Documents at <http://www.sgs.com/en/Terms-and-Conditions/Terms-e-Documents.aspx>. Attention is drawn to the limitation of liability, indemnification and jurisdiction issues defined therein. Any holder of this document is advised that information contained hereon reflects the Company's findings at the time of its intervention only and within the limits of Client's instructions, if any. The Company's sole responsibility is to its Client and this document does not exonerate parties to a transaction from exercising all their rights and obligations under the transaction documents. This document cannot be reproduced except in full, without prior written approval of the Company. Any unauthorized alteration, forgery or falsification of the content or appearance of this document is unlawful and offenders may be prosecuted to the fullest extent of the law. Unless otherwise stated the results shown in this test report refer only to the sample(s) tested and such sample(s) are retained for 30 days only.

Attention: To check the authenticity of testing /inspection report & certificate, please contact us at telephone: (86-755) 8307 1443, or email: CN.Doccheck@sgs.com

No.1 Workshop, M-10, Middle Section, Science & Technology Park, Shenzhen, China 518057 t (86-755) 26012053 f (86-755) 26710594 www.sgs.com.cn
 中国·深圳·科技园中区M-10栋一号厂房 邮编: 518057 t (86-755) 26012053 f (86-755) 26710594 sgs.china@sgs.com

TEST SUMMARY

Frequency Band	T-rating
GSM850	T3
GSM1900	T4
WCDMA Band II	T3
WCDMA Band IV	T3
WCDMA Band V	T3
LTE Band 2	T3
LTE Band 4	T3
LTE Band 5	T3
LTE Band 12	T3
LTE Band 25	T3
LTE Band 26	T3
LTE Band 41	T3
LTE Band 66	T3
LTE Band 71	T3
WiFi 2.4G	T3
HAC Rate Category:	T3

Reviewed by

Jackson Li

Jackson Li

Prepared by

Roman Pan

Roman Pan



Unless otherwise agreed in writing, this document is issued by the Company subject to its General Conditions of Service printed overleaf, available on request or accessible at <http://www.sgs.com/en/Terms-and-Conditions.aspx> and, for electronic format documents, subject to Terms and Conditions for Electronic Documents at <http://www.sgs.com/en/Terms-and-Conditions/Terms-e-Documents.aspx>. Attention is drawn to the limitation of liability, indemnification and jurisdiction issues defined therein. Any holder of this document is advised that information contained hereon reflects the Company's findings at the time of its intervention only and within the limits of Client's instructions, if any. The Company's sole responsibility is to its Client and this document does not exonerate parties to a transaction from exercising all their rights and obligations under the transaction documents. This document cannot be reproduced except in full, without prior written approval of the Company. Any unauthorized alteration, forgery or falsification of the content or appearance of this document is unlawful and offenders may be prosecuted to the fullest extent of the law. Unless otherwise stated the results shown in this test report refer only to the sample(s) tested and such sample(s) are retained for 30 days only.

Attention: To check the authenticity of testing /inspection report & certificate, please contact us at telephone: (86-755) 8307 1443, or email: CN.Doccheck@sgs.com

CONTENTS

1	GENERAL INFORMATION	5
1.1	INTRODUCTION	5
1.2	DETAILS OF CLIENT	5
1.3	TEST LOCATION	6
1.4	TEST FACILITY	6
1.5	GENERAL DESCRIPTION OF EUT.....	7
1.5.1	DUT Antenna Locations (Back view).....	8
1.5.2	List of air interfaces/frequency bands	9
1.6	TEST SPECIFICATION	10
2	CALIBRATION CERTIFICATE	10
3	HAC (T COIL) MEASUREMENT SYSTEM	11
3.1	MEASUREMENT SYSTEM DIAGRAM FOR SPEAG ROBOTIC.....	11
3.2	T-COIL MEASUREMENT SET-UP	12
3.3	SYSTEM CALIBRATION	13
3.4	AUDIO MAGNETIC PROBE AM1DV3	14
3.5	TEST ARCH.....	14
3.6	PHONE HOLDER	14
3.7	AMCC- AUDIO MAGNETIC CALIBRATION COIL	15
3.8	AMMI - AUDIO MAGNETIC MEASUREMENT INSTRUMENT.....	15
4	MEASUREMENT UNCERTAINTY EVALUATION	16
5	HAC (T COIL) MEASUREMENT	18
5.1	T-COIL PERFORMANCE REQUIREMENTS.....	18
5.2	T-COIL MEASUREMENT POINTS AND REFERENCE PLANE.....	20
5.3	T-COIL MEASUREMENT PROCEDURE	21
6	T-COIL TESTING FOR CMRS VOICE	23
6.1	GENERAL DESCRIPTION.....	23
6.2	GSM TESTS RESULTS	23
6.3	UMTS TESTS RESULTS	24
7	T-COIL TESTING FOR CMRS IP VOICE	25
7.1	VoLTE TESTS RESULTS.....	25
7.2	T-COIL TESTING FOR OTT VOIP APPLICATION	28
8	EQUIPMENT LIST	31
9	CALIBRATION CERTIFICATE	31
10	PHOTOGRAPHS	31
	APPENDIX A: DETAILED TEST RESULTS	31
	APPENDIX B: CALIBRATION CERTIFICATE	31
	APPENDIX C: PHOTOGRAPHS	31



Unless otherwise agreed in writing, this document is issued by the Company subject to its General Conditions of Service printed overleaf, available on request or accessible at <http://www.sgs.com/en/Terms-and-Conditions.aspx> and, for electronic format documents, subject to Terms and Conditions for Electronic Documents at <http://www.sgs.com/en/Terms-and-Conditions/Terms-e-Documents.aspx>. Attention is drawn to the limitation of liability, indemnification and jurisdiction issues defined therein. Any holder of this document is advised that information contained hereon reflects the Company's findings at the time of its intervention only and within the limits of Client's instructions, if any. The Company's sole responsibility is to its Client and this document does not exonerate parties to a transaction from exercising all their rights and obligations under the transaction documents. This document cannot be reproduced except in full, without prior written approval of the Company. Any unauthorized alteration, forgery or falsification of the content or appearance of this document is unlawful and offenders may be prosecuted to the fullest extent of the law. Unless otherwise stated the results shown in this test report refer only to the sample(s) tested and such sample(s) are retained for 30 days only.

Attention: To check the authenticity of testing /inspection report & certificate, please contact us at telephone: (86-755) 8307 1443, or email: CN.Doccheck@sgs.com
No.1 Workshop, M-10, Middle Section, Science & Technology Park, Shenzhen, China 518057 t (86-755) 26012053 f (86-755) 26710594 www.sgs.com.cn
中国·深圳·科技园中区M-10栋一号厂房 邮编: 518057 t (86-755) 26012053 f (86-755) 26710594 sgs.china@sgs.com

1 General Information

1.1 Introduction

The purpose of this standard is to establish categories for hearing aids and for WD (wireless communications devices) that can indicate to health care practitioners and hearing aid users which hearing aids are compatible with which WD, and to provide tests that can be used to assess the electromagnetic characteristics of hearing aids and WD and assign them to these categories. The various parameters required, in order to demonstrate compatibility and accessibility are measured. The design of the standard is such that when a hearing aid and WD achieve one of the categories specified, as measured by the methodology of this standard, the indicated performance is realized.

In order to provide for the usability of a hearing aid with a WD, several factors must be coordinated:

- a) Radio frequency (RF) measurements of the near-field electric and magnetic fields emitted by a WD to categorize these emissions for correlation with the RF immunity of a hearing aid.
- b) Magnetic field measurements of a WD emitted via the audio transducer associated with the T-coil mode of the hearing aid, for assessment of hearing aid performance.
- c) Measurements with the hearing aid and a simulation of the categorized WD T-coil emissions to assess the hearing aid RF immunity in the T-coil mode.

The WD radio frequency (RF) and audio band emissions are measured.

Hence, the following are measurements made for the WD:

- a) RF E-Field emissions
- b) T-coil mode, magnetic signal strength in the audio band
- c) T-coil mode, magnetic signal and noise articulation index
- d) T-coil mode, magnetic signal frequency response through the audio band

Corresponding to the WD measurements, the hearing aid is measured for:

- a) RF immunity in microphone mode
- b) RF immunity in T-coil mode

1.2 Details of Client

Applicant:	Great Talent Technology Limited
Address:	35F, HBC HuiLong Center Building-II Minzhi Street, Longhua, Shenzhen, P.R. China
Manufacturer:	Great Talent Technology Limited
Address:	35F, HBC HuiLong Center Building-II Minzhi Street, Longhua, Shenzhen, P.R. China



Unless otherwise agreed in writing, this document is issued by the Company subject to its General Conditions of Service printed overleaf, available on request or accessible at <http://www.sgs.com/en/Terms-and-Conditions.aspx> and, for electronic format documents, subject to Terms and Conditions for Electronic Documents at <http://www.sgs.com/en/Terms-and-Conditions/Terms-e-Documents.aspx>. Attention is drawn to the limitation of liability, indemnification and jurisdiction issues defined therein. Any holder of this document is advised that information contained hereon reflects the Company's findings at the time of its intervention only and within the limits of Client's instructions, if any. The Company's sole responsibility is to its Client and this document does not exonerate parties to a transaction from exercising all their rights and obligations under the transaction documents. This document cannot be reproduced except in full, without prior written approval of the Company. Any unauthorized alteration, forgery or falsification of the content or appearance of this document is unlawful and offenders may be prosecuted to the fullest extent of the law. Unless otherwise stated the results shown in this test report refer only to the sample(s) tested and such sample(s) are retained for 30 days only.

Attention: To check the authenticity of testing /inspection report & certificate, please contact us at telephone: (86-755) 8307 1443, or email: CN.Doccheck@sgs.com

1.3 Test Location

Company:	SGS-CSTC Standards Technical Services Co., Ltd. Shenzhen Branch
Address:	No. 1 Workshop, M-10, Middle section, Science & Technology Park, Shenzhen, Guangdong, China
Post code:	518057
Telephone:	+86 (0) 755 2601 2053
Fax:	+86 (0) 755 2671 0594

1.4 Test Facility

The test facility is recognized, certified, or accredited by the following organizations:

• **CNAS (No. CNAS L2929)**

CNAS has accredited SGS-CSTC Standards Technical Services Co., Ltd. Shenzhen Branch EMC Lab to ISO/IEC 17025:2017 General Requirements for the Competence of Testing and Calibration Laboratories (CNAS-CL01 Accreditation Criteria for the Competence of Testing and Calibration Laboratories) for the competence in the field of testing.

• **A2LA (Certificate No. 3816.01)**

SGS-CSTC Standards Technical Services Co., Ltd., Shenzhen EMC Laboratory is accredited by the American Association for Laboratory Accreditation(A2LA). Certificate No. 3816.01.

• **VCCI**

The 10m Semi-anechoic chamber and Shielded Room of SGS-CSTC Standards Technical Services Co., Ltd. have been registered in accordance with the Regulations for Voluntary Control Measures with Registration No.: G-823, R-4188, T-1153 and C-2383 respectively.

• **FCC –Designation Number: CN1178**

SGS-CSTC Standards Technical Services Co., Ltd., Shenzhen EMC Laboratory has been recognized as an accredited testing laboratory.

Designation Number: CN1178. Test Firm Registration Number: 406779.

• **Industry Canada (IC)**

SGS-CSTC Standards Technical Services Co., Ltd., Shenzhen EMC Laboratory has been recognized by ISED as an accredited testing laboratory.

CAB identifier: CN0006

IC#: 4620C.



Unless otherwise agreed in writing, this document is issued by the Company subject to its General Conditions of Service printed overleaf, available on request or accessible at <http://www.sgs.com/en/Terms-and-Conditions.aspx> and, for electronic format documents, subject to Terms and Conditions for Electronic Documents at <http://www.sgs.com/en/Terms-and-Conditions/Terms-e-Documents.aspx>. Attention is drawn to the limitation of liability, indemnification and jurisdiction issues defined therein. Any holder of this document is advised that information contained hereon reflects the Company's findings at the time of its intervention only and within the limits of Client's instructions, if any. The Company's sole responsibility is to its Client and this document does not exonerate parties to a transaction from exercising all their rights and obligations under the transaction documents. This document cannot be reproduced except in full, without prior written approval of the Company. Any unauthorized alteration, forgery or falsification of the content or appearance of this document is unlawful and offenders may be prosecuted to the fullest extent of the law. Unless otherwise stated the results shown in this test report refer only to the sample(s) tested and such sample(s) are retained for 30 days only.



1.5 General Description of EUT

Device Type :	portable device		
Exposure Category:	uncontrolled environment / general population		
Product Name:	Smart phone		
Model No.(EUT):	U696CL		
Trade Mark:	UMX		
Product Phase:	production unit		
FCC ID:	2ALZM-U696CL		
SN:	a2f1d331		
Hardware Version:	U696CL_V1.0		
Software Version:	UMX_U696CL_V11.01.01.01.061711		
Antenna Type:	Internal Antenna		
Device Operating Configurations :			
Modulation Mode:	GSM: GMSK, 8PSK; WCDMA: QPSK; LTE: QPSK,16QAM WIFI: DSSS, OFDM; BT: GFSK, π/4DQPSK,8DPSK;		
Device Class:	B		
GPRS Multi-slots Class:	33	EGPRS Multi-slots Class:	33
HSDPA UE Category:	14	HSUPA UE Category:	6
Power Class	4, tested with power level 5(GSM850)		
	1, tested with power level 0(GSM1900)		
	3, tested with power control "all 1"(All UMTS Bands)		
	3, tested with power control Max Power(All LTE Bands)		
Frequency Bands:	Band	Tx (MHz)	Rx (MHz)
	GSM850	824~849	869~894
	GSM1900	1850~1910	1930~1990
	WCDMA Band II	1850~1910	1930~1990
	WCDMA Band IV	1710~1755	2110~2155
	WCDMA Band V	824~849	869~894
	LTE Band 2	1850 ~1910	1930 ~1990
	LTE Band 4	1710~1755	2110~2155
	LTE Band 5	824~849	869-894
	LTE Band 12	699~716	729~746
	LTE Band 25	1850~1915	1930~1995
	LTE Band 26	814~849	859~894
	LTE Band 41	2496~2690	2496~2690
	LTE Band 66	1710~1780	2110~2200
	LTE Band 71	663~698	617~652
	WIFI 2.4G	2412~2462	2412~2462
	BT	2400~2483.5	2400~2483.5
Battery Information:	Model:	UBT2300	
	Normal Voltage:	+3.85V	
	Rated capacity:	2300mAh	
	Manufacturer:	Phenix New Energy(Hui Zhou)Co.,Ltd.	



Unless otherwise agreed in writing, this document is issued by the Company subject to its General Conditions of Service printed overleaf, available on request or accessible at <http://www.sgs.com/en/Terms-and-Conditions.aspx> and, for electronic format documents, subject to Terms and Conditions for Electronic Documents at <http://www.sgs.com/en/Terms-and-Conditions/Terms-e-Documents.aspx>. Attention is drawn to the limitation of liability, indemnification and jurisdiction issues defined therein. Any holder of this document is advised that information contained hereon reflects the Company's findings at the time of its intervention only and within the limits of Client's instructions, if any. The Company's sole responsibility is to its Client and this document does not exonerate parties to a transaction from exercising all their rights and obligations under the transaction documents. This document cannot be reproduced except in full, without prior written approval of the Company. Any unauthorized alteration, forgery or falsification of the content or appearance of this document is unlawful and offenders may be prosecuted to the fullest extent of the law. Unless otherwise stated the results shown in this test report refer only to the sample(s) tested and such sample(s) are retained for 30 days only.

1.5.1 DUT Antenna Locations (Back view)

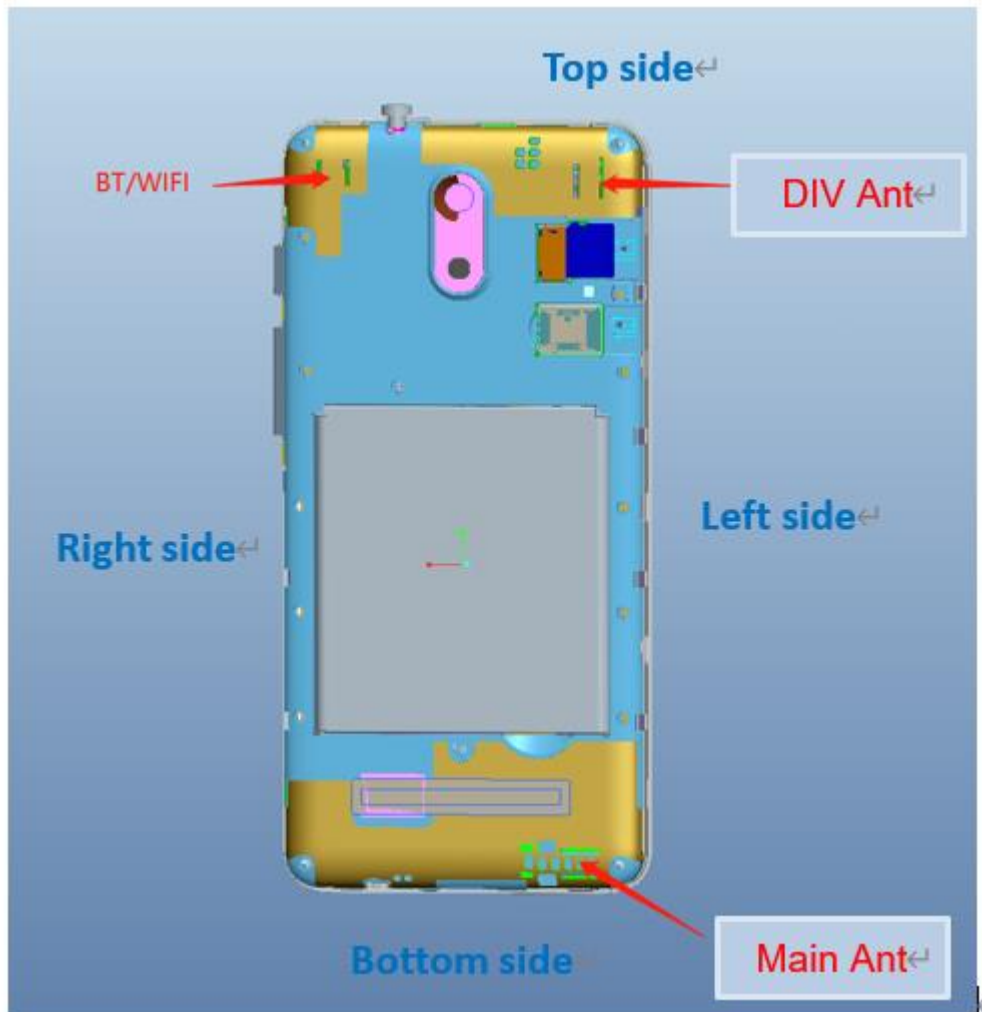

Unless otherwise agreed in writing, this document is issued by the Company subject to its General Conditions of Service printed overleaf, available on request or accessible at <http://www.sgs.com/en/Terms-and-Conditions.aspx> and, for electronic format documents, subject to Terms and Conditions for Electronic Documents at <http://www.sgs.com/en/Terms-and-Conditions/Terms-e-Documents.aspx>. Attention is drawn to the limitation of liability, indemnification and jurisdiction issues defined therein. Any holder of this document is advised that information contained hereon reflects the Company's findings at the time of its intervention only and within the limits of Client's instructions, if any. The Company's sole responsibility is to its Client and this document does not exonerate parties to a transaction from exercising all their rights and obligations under the transaction documents. This document cannot be reproduced except in full, without prior written approval of the Company. Any unauthorized alteration, forgery or falsification of the content or appearance of this document is unlawful and offenders may be prosecuted to the fullest extent of the law. Unless otherwise stated the results shown in this test report refer only to the sample(s) tested and such sample(s) are retained for 30 days only.

Attention: To check the authenticity of testing /inspection report & certificate, please contact us at telephone: (86-755) 8307 1443, or email: CN.Doccheck@sgs.com
 No.1 Workshop, M-10, Middle Section, Science & Technology Park, Shenzhen, China 518057 t (86-755) 26012053 f (86-755) 26710594 www.sgs.com.cn
 中国·深圳·科技园中区M-10栋一号厂房 邮编: 518057 t (86-755) 26012053 f (86-755) 26710594 sgs.china@sgs.com

1.5.2 List of air interfaces/frequency bands

Air Interface	Band (MHz)	Type	ANSI C63.19 Tested	Simultaneous Transmitter	Name of Voice Service	Power Reduction
GSM	850	VO	Yes	BT, Wi-Fi	CMRS Voice	NA
	1900				Google Duo*	
	EDGE	VD	Yes			
WCDMA	Band II	VO	Yes	BT, Wi-Fi	CMRS Voice	NA
	Band IV					
	Band V	VD	Yes		Google Duo*	
	HSPA					
LTE (FDD)	Band 2	VD	Yes	BT, Wi-Fi	VoLTE Google Duo*	NA
	Band 4					
	Band 5					
	Band 12					
	Band 25					
	Band 26					
	Band 66					
	Band 71					
LTE (TDD)	Band 41	VD	Yes	BT, Wi-Fi	VoLTE Google Duo*	NA
Wi-Fi	2450	VD	Yes	WWAN	Google Duo*	NA
BT	2450	DT	NA	WWAN	NA	NA

VO: Legacy Cellular Voice Service from Table 7.1 in 7.4.2.1 of ANSI C63.19-2011
 DT: Digital Transport (no voice)
 VD: IP Voice Service over Digital Transport
 * For protocols not listed in Table 7.1 of ANSI C63.19-2011 or the ANSI C63.19-2011 VoLTE interpretation, the average speech level of -20 dBm0 should be used.
 Note: The device has similar frequency in some LTE bands: LTE 2/25, 4/66, B5/26, since the supported frequency spans for the smaller LTE bands are completely cover by the larger LTE bands, therefore, only larger LTE bands were required to be tested for hearing-aid compliance.
 The device does not support VoWiFi



Unless otherwise agreed in writing, this document is issued by the Company subject to its General Conditions of Service printed overleaf, available on request or accessible at <http://www.sgs.com/en/Terms-and-Conditions.aspx> and, for electronic format documents, subject to Terms and Conditions for Electronic Documents at <http://www.sgs.com/en/Terms-and-Conditions/Terms-e-Documents.aspx>. Attention is drawn to the limitation of liability, indemnification and jurisdiction issues defined therein. Any holder of this document is advised that information contained hereon reflects the Company's findings at the time of its intervention only and within the limits of Client's instructions, if any. The Company's sole responsibility is to its Client and this document does not exonerate parties to a transaction from exercising all their rights and obligations under the transaction documents. This document cannot be reproduced except in full, without prior written approval of the Company. Any unauthorized alteration, forgery or falsification of the content or appearance of this document is unlawful and offenders may be prosecuted to the fullest extent of the law. Unless otherwise stated the results shown in this test report refer only to the sample(s) tested and such sample(s) are retained for 30 days only.
 Attention: To check the authenticity of testing /inspection report & certificate, please contact us at telephone: (86-755) 8307 1443, or email: CN.Doccheck@sgs.com

1.6 Test Specification

Identity	Document Title
CFR 47 FCC Part 20	§20.19 Hearing aid-compatible mobile handsets.
ANSI C63.19-2011	American National Standard for Methods of Measurement of Compatibility between Wireless Communication Devices
KDB 285076 D01	HAC Guidance v05
KDB 285076 D02	T-Coil testing v03
KDB 285076 D03	HAC FAQ v01

2 Calibration certificate

Temperature	Min. = 18°C, Max. = 25 °C
Relative humidity	Min. = 30%, Max. = 70%

Table 1: The Ambient Conditions



Unless otherwise agreed in writing, this document is issued by the Company subject to its General Conditions of Service printed overleaf, available on request or accessible at <http://www.sgs.com/en/Terms-and-Conditions.aspx> and, for electronic format documents, subject to Terms and Conditions for Electronic Documents at <http://www.sgs.com/en/Terms-and-Conditions/Terms-e-Documents.aspx>. Attention is drawn to the limitation of liability, indemnification and jurisdiction issues defined therein. Any holder of this document is advised that information contained hereon reflects the Company's findings at the time of its intervention only and within the limits of Client's instructions, if any. The Company's sole responsibility is to its Client and this document does not exonerate parties to a transaction from exercising all their rights and obligations under the transaction documents. This document cannot be reproduced except in full, without prior written approval of the Company. Any unauthorized alteration, forgery or falsification of the content or appearance of this document is unlawful and offenders may be prosecuted to the fullest extent of the law. Unless otherwise stated the results shown in this test report refer only to the sample(s) tested and such sample(s) are retained for 30 days only.

Attention: To check the authenticity of testing /inspection report & certificate, please contact us at telephone: (86-755) 8307 1443, or email: CN.Doccheck@sgs.com

3 HAC (T Coil) Measurement System

3.1 Measurement System Diagram for SPEAG Robotic

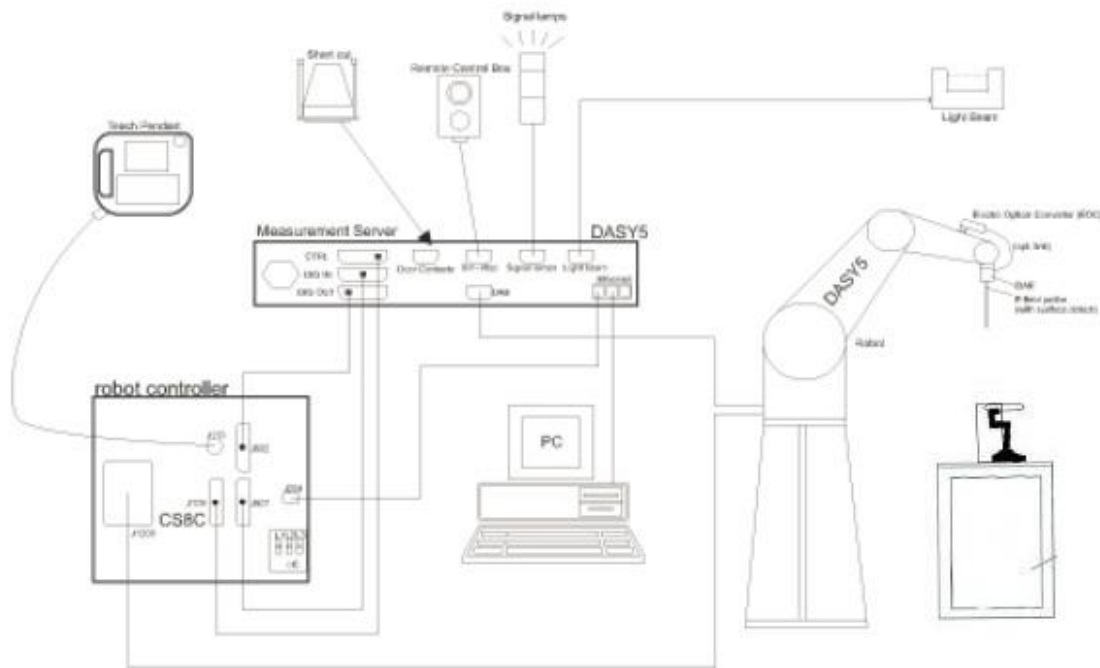

Fig. 1. The SPEAG Robotic Diagram

The DASY5 system for performing compliance tests consists of the following items:

- A standard high precision 6-axis robot (Stabile RX family) with controller, teach pendant and software. An arm extension is for accommodating the data acquisition electronics (DAE).
- An Audio Magnetic probe.
- A data acquisition electronics (DAE) which performs the signal amplification, signal multiplexing, AD-conversion, offset measurements, mechanical surface detection, collision detection, etc. The unit is battery powered with standard or rechargeable batteries. The signal is optically transmitted to the EOC.
- The Electro-optical converter (EOC) performs the conversion between optical and electrical of the signals for the digital communication to the DAE and for the analog signal from the optical surface detection. The EOC is connected to the measurement server.
- The function of the measurement server is to perform the time critical tasks such as signal filtering, control of the robot operation and fast movement interrupts.
- A probe alignment unit which improves the (absolute) accuracy of the probe positioning.
- A computer operating Windows 7.
- DASY5 software.
- Remote control with teach pendant and additional circuitry for robot safety such as warning lamps, etc.
- The Test Arch SAM phantom
- The device holder for handheld mobile phones.
- Validation dipole kits allowing to validate the proper functioning of the system.



Unless otherwise agreed in writing, this document is issued by the Company subject to its General Conditions of Service printed overleaf, available on request or accessible at <http://www.sgs.com/en/Terms-and-Conditions.aspx> and, for electronic format documents, subject to Terms and Conditions for Electronic Documents at <http://www.sgs.com/en/Terms-and-Conditions/Terms-e-Documents.aspx>. Attention is drawn to the limitation of liability, indemnification and jurisdiction issues defined therein. Any holder of this document is advised that information contained hereon reflects the Company's findings at the time of its intervention only and within the limits of Client's instructions, if any. The Company's sole responsibility is to its Client and this document does not exonerate parties to a transaction from exercising all their rights and obligations under the transaction documents. This document cannot be reproduced except in full, without prior written approval of the Company. Any unauthorized alteration, forgery or falsification of the content or appearance of this document is unlawful and offenders may be prosecuted to the fullest extent of the law. Unless otherwise stated the results shown in this test report refer only to the sample(s) tested and such sample(s) are retained for 30 days only.

Attention: To check the authenticity of testing /inspection report & certificate, please contact us at telephone: (86-755) 8307 1443, or email: CN.Doccheck@sgs.com
 No.1 Workshop, M-10, Middle Section, Science & Technology Park, Shenzhen, China 518057 t (86-755) 26012053 f (86-755) 26710594 www.sgs.com.cn
 中国·深圳·科技园中区M-10栋一号厂房 邮编: 518057 t (86-755) 26012053 f (86-755) 26710594 sgs.china@sgs.com

3.2 T-Coil Measurement Set-up

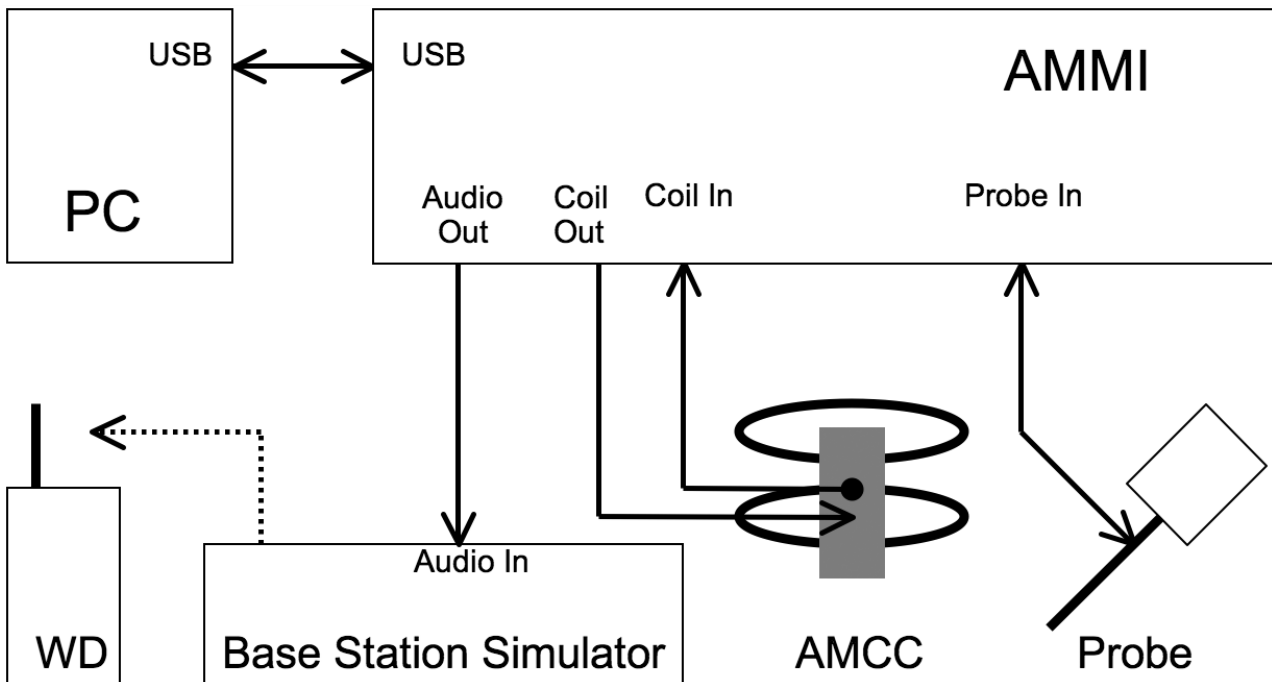

Fig. 2. T-coil signal measurement test setup

The sequence of the measurement is T-Coil testing procedure over a wireless communication device:

1. Confirm Geometry & signal check. Probe phantom alignment and check of accuracy.
2. Background noise measurement in the area of the WD.
3. Perform 50x50mm area scan with narrow band signal to determine ABM1, ABM2 and SNR for axial and radial orientation positions.
4. For Axial position, perform optimal SNR point measurement with a broadband signal – determine Frequency Response
5. Define the all applicable input audio level according to ANSI C63.19-2011 and KDB 285076 D02v03.

Note.

- #. The EUT do not use the special HAC SW.
- #. Setting the maximum volume for EUT during the measurement.
- #. For the measurement, it don't use the “post-test measurement processing of results”.
- #. Per KDB 285076 D01v05, handsets that that have the ability to support concurrent connections using simultaneous transmissions shall be independently tested for each air interface/band given in ANSI C63.19-2011. At the present time ANSI C63.19 does not provide simultaneous transmission test procedures.



Unless otherwise agreed in writing, this document is issued by the Company subject to its General Conditions of Service printed overleaf, available on request or accessible at <http://www.sgs.com/en/Terms-and-Conditions.aspx> and, for electronic format documents, subject to Terms and Conditions for Electronic Documents at <http://www.sgs.com/en/Terms-and-Conditions/Terms-e-Documents.aspx>. Attention is drawn to the limitation of liability, indemnification and jurisdiction issues defined therein. Any holder of this document is advised that information contained hereon reflects the Company's findings at the time of its intervention only and within the limits of Client's instructions, if any. The Company's sole responsibility is to its Client and this document does not exonerate parties to a transaction from exercising all their rights and obligations under the transaction documents. This document cannot be reproduced except in full, without prior written approval of the Company. Any unauthorized alteration, forgery or falsification of the content or appearance of this document is unlawful and offenders may be prosecuted to the fullest extent of the law. Unless otherwise stated the results shown in this test report refer only to the sample(s) tested and such sample(s) are retained for 30 days only.

3.3 System Calibration

For correct and calibrated measurement of the voltages and ABM field, DASY will perform a calibration job as below.

In phase 1, the audio output is switched off, and a 200 mVpp symmetric rectangular signal of 1 kHz is generated and internally connected directly to both channels of the sampling unit (Coil in, Probe in).

In phase 2, the audio output is off, and a 20 mVpp symmetric 100 Hz signal is internally connected. The signals during phases 1 and 2 are available at the output on the rear panel of the AMMI. However, the output must not be loaded, in order to avoid influencing the calibration. An RMS voltmeter would indicate 100 mVRMS during the first phase and 10 mVRMS during the second phase. After the first two phases, the two input channels are both calibrated for absolute measurements of voltages. The resulting factors are displayed above the multi-meter window.

After phases 1 and 2, the input channels are calibrated to measure exact voltages. This is required to use the inputs for measuring voltages with their peak and RMS value.

In phase 3, a multi-sine signal covering each third-octave band from 50 Hz to 10 kHz is generated and applied to both audio outputs. The probe should be positioned in the center of the AMCC and aligned in the z-direction, the field orientation of the AMCC. The "Coil In" channel is measuring the voltage over the AMCC internal shunt, which is proportional to the magnetic field in the AMCC. At the same time, the "Probe In" channel samples the amplified signal picked up by the probe coil and provides it to a numerical integrator. The ratio of the two voltages in each third-octave filter leads to the spectral representation over the frequency band of interest. The Coil signal is scaled in dBV, and the Probe signal is first integrated and normalized to show dB A/m. The ratio probe-to-coil at the frequency of 1 kHz is the sensitivity which will be used in the consecutive T-Coil jobs.



Unless otherwise agreed in writing, this document is issued by the Company subject to its General Conditions of Service printed overleaf, available on request or accessible at <http://www.sgs.com/en/Terms-and-Conditions.aspx> and, for electronic format documents, subject to Terms and Conditions for Electronic Documents at <http://www.sgs.com/en/Terms-and-Conditions/Terms-e-Documents.aspx>. Attention is drawn to the limitation of liability, indemnification and jurisdiction issues defined therein. Any holder of this document is advised that information contained hereon reflects the Company's findings at the time of its intervention only and within the limits of Client's instructions, if any. The Company's sole responsibility is to its Client and this document does not exonerate parties to a transaction from exercising all their rights and obligations under the transaction documents. This document cannot be reproduced except in full, without prior written approval of the Company. Any unauthorized alteration, forgery or falsification of the content or appearance of this document is unlawful and offenders may be prosecuted to the fullest extent of the law. Unless otherwise stated the results shown in this test report refer only to the sample(s) tested and such sample(s) are retained for 30 days only.

Attention: To check the authenticity of testing /inspection report & certificate, please contact us at telephone: (86-755) 8307 1443, or email: CN.Doccheck@sgs.com
No.1 Workshop, M-10, Middle Section, Science & Technology Park, Shenzhen, China 518057 t (86-755) 26012053 f (86-755) 26710594 www.sgs.com.cn
中国·深圳·科技园中区M-10栋一号厂房 邮编: 518057 t (86-755) 26012053 f (86-755) 26710594 sgs.china@sgs.com

3.4 Audio Magnetic Probe AM1DV3

Description	Active single sensor probe for both axial and radial measurement scans- Fully RF shielded, compatible with DAE, with adapted probe cup	 <p style="text-align: center;">AM1DV3 Audio Probe</p>
Dynamic Range	0.1 KHz to 20 KHz	
Sensitivity	<-50dB A/m @ 1KHz	
Internal Amp	20dB	
Dimensions	300X18mm	

3.5 Test Arch

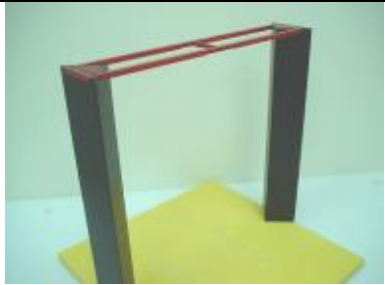
Description	Enables easy and well defined positioning of the phone and validation dipoles as well as simple teaching of the robot.	 <p style="text-align: center;">Test Arch</p>
Dimensions	length: 370 mm width: 370 mm height: 370 mm	

3.6 Phone Holder

Description	Supports accurate and reliable positioning of any phone Effect on near field <+/- 0.5 dB	 <p style="text-align: center;">Phone Holder</p>
-------------	--	---



Unless otherwise agreed in writing, this document is issued by the Company subject to its General Conditions of Service printed overleaf, available on request or accessible at <http://www.sgs.com/en/Terms-and-Conditions.aspx> and, for electronic format documents, subject to Terms and Conditions for Electronic Documents at <http://www.sgs.com/en/Terms-and-Conditions/Terms-e-Documents.aspx>. Attention is drawn to the limitation of liability, indemnification and jurisdiction issues defined therein. Any holder of this document is advised that information contained hereon reflects the Company's findings at the time of its intervention only and within the limits of Client's instructions, if any. The Company's sole responsibility is to its Client and this document does not exonerate parties to a transaction from exercising all their rights and obligations under the transaction documents. This document cannot be reproduced except in full, without prior written approval of the Company. Any unauthorized alteration, forgery or falsification of the content or appearance of this document is unlawful and offenders may be prosecuted to the fullest extent of the law. Unless otherwise stated the results shown in this test report refer only to the sample(s) tested and such sample(s) are retained for 30 days only.

3.7 AMCC- Audio Magnetic Calibration Coil

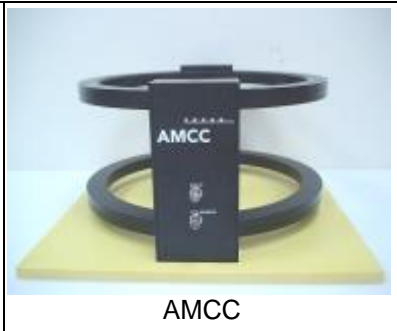
Description	Allows calibration of the complete measurement setup, the two horizontal coils create a homogeneous magnetic field in the z direction. Refer to Appendix 5 for more detail on AMCC coil	 <p style="text-align: center;">AMCC</p>
-------------	---	---

3.8 AMMI - Audio Magnetic Measurement Instrument

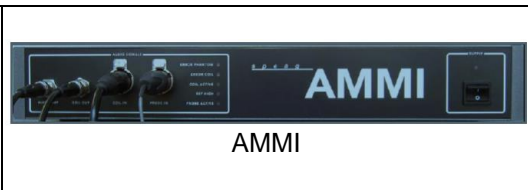
Description	-USB interface to PC - Probe signal digitization and power supply- Test signal generation for wireless device (via base station simulator)- Auto-calibration and interfaces to AMCC for complete setup-calibration	 <p style="text-align: center;">AMMI</p>
Data Rate	48 KHz / 24bit	
Dynamic Range	85 dB	
Dimensions:	19" X 65 X 270mm	



Unless otherwise agreed in writing, this document is issued by the Company subject to its General Conditions of Service printed overleaf, available on request or accessible at <http://www.sgs.com/en/Terms-and-Conditions.aspx> and, for electronic format documents, subject to Terms and Conditions for Electronic Documents at <http://www.sgs.com/en/Terms-and-Conditions/Terms-e-Documents.aspx>. Attention is drawn to the limitation of liability, indemnification and jurisdiction issues defined therein. Any holder of this document is advised that information contained hereon reflects the Company's findings at the time of its intervention only and within the limits of Client's instructions, if any. The Company's sole responsibility is to its Client and this document does not exonerate parties to a transaction from exercising all their rights and obligations under the transaction documents. This document cannot be reproduced except in full, without prior written approval of the Company. Any unauthorized alteration, forgery or falsification of the content or appearance of this document is unlawful and offenders may be prosecuted to the fullest extent of the law. Unless otherwise stated the results shown in this test report refer only to the sample(s) tested and such sample(s) are retained for 30 days only.

Attention: To check the authenticity of testing /inspection report & certificate, please contact us at telephone: (86-755) 8307 1443, or email: CN.Doccheck@sgs.com

No.1 Workshop, M-10, Middle Section, Science & Technology Park, Shenzhen, China 518057 t (86-755) 26012053 f (86-755) 26710594 www.sgs.com.cn
 中国·深圳·科技园中区M-10栋一号厂房 邮编: 518057 t (86-755) 26012053 f (86-755) 26710594 sgs.china@sgs.com

4 Measurement uncertainty evaluation

Error Description	Uncertainty Value (%)	Probability Dist.	Divisor	ci ABM1	ci ABM2	Standard Uncertainty ABM1 (%)	Standard Uncertainty ABM2 (%)
Related to probe sensitivity							
Reference level	±3.0	R	$\sqrt{3}$	1	1	±3.0	±3.0
AMCC geometry	±0.4	R	$\sqrt{3}$	1	1	±0.2	±0.2
AMCC current	±0.6	R	$\sqrt{3}$	1	1	±0.4	±0.4
Probe positioning during calibration	±0.2	R	$\sqrt{3}$	1	1	±0.1	±0.1
Noise distribution	±0.7	R	$\sqrt{3}$	0.0143	1	±0.0	±0.4
Frequency slope	±5.9	R	$\sqrt{3}$	0.1	1	±0.3	±3.5
Related to probe system							
Repeatability / drift	±1.0	R	$\sqrt{3}$	1	1	±0.6	±0.6
Linearity / dynamic range	±0.6	N	1	1	1	±0.4	±0.4
Audio noise	±1.0	R	$\sqrt{3}$	0.1	1	±0.1	±0.6
Probe angle	±2.3	R	$\sqrt{3}$	1	1	±1.4	±1.4
Spectral Processing	±0.9	R	$\sqrt{3}$	1	1	±0.5	±0.5
Integration time	±0.6	N	1	1	5	±0.6	±3.0
Field distribution	±0.2	R	$\sqrt{3}$	1	1	±0.1	±0.1
Test signal							
Reference signal spectrum response	±0.6	R	$\sqrt{3}$	0	1	±0.0	±0.4
Positioning							
Probe positioning	±1.9	R	$\sqrt{3}$	1	1	±1.1	±1.1
Phantom Thickness	±0.9	R	$\sqrt{3}$	1	1	±0.5	±0.5
DUT positioning	±1.9	R	$\sqrt{3}$	1	1	±1.1	±1.1
External Contributions							
RF interference	±0.0	R	$\sqrt{3}$	1	0.3	±0.0	±0.0
Test Signal Variation	±2.0	R	$\sqrt{3}$	1	1	±1.2	±1.2
Combined Std. Uncertainty (ABM Field)	$u'_c = \sqrt{\sum_{i=1}^{20} c_i^2 u_i^2}$					±4.1	±6.2
Expanded Std. Uncertainty (K=2)						±8.2	±12.4



Unless otherwise agreed in writing, this document is issued by the Company subject to its General Conditions of Service printed overleaf, available on request or accessible at <http://www.sgs.com/en/Terms-and-Conditions.aspx> and, for electronic format documents, subject to Terms and Conditions for Electronic Documents at <http://www.sgs.com/en/Terms-and-Conditions/Terms-e-Documents.aspx>. Attention is drawn to the limitation of liability, indemnification and jurisdiction issues defined therein. Any holder of this document is advised that information contained hereon reflects the Company's findings at the time of its intervention only and within the limits of Client's instructions, if any. The Company's sole responsibility is to its Client and this document does not exonerate parties to a transaction from exercising all their rights and obligations under the transaction documents. This document cannot be reproduced except in full, without prior written approval of the Company. Any unauthorized alteration, forgery or falsification of the content or appearance of this document is unlawful and offenders may be prosecuted to the fullest extent of the law. Unless otherwise stated the results shown in this test report refer only to the sample(s) tested and such sample(s) are retained for 30 days only.



Table 2: Measurement uncertainties for T-Coil



Unless otherwise agreed in writing, this document is issued by the Company subject to its General Conditions of Service printed overleaf, available on request or accessible at <http://www.sgs.com/en/Terms-and-Conditions.aspx> and, for electronic format documents, subject to Terms and Conditions for Electronic Documents at <http://www.sgs.com/en/Terms-and-Conditions/Terms-e-Documents.aspx>. Attention is drawn to the limitation of liability, indemnification and jurisdiction issues defined therein. Any holder of this document is advised that information contained hereon reflects the Company's findings at the time of its intervention only and within the limits of Client's instructions, if any. The Company's sole responsibility is to its Client and this document does not exonerate parties to a transaction from exercising all their rights and obligations under the transaction documents. This document cannot be reproduced except in full, without prior written approval of the Company. Any unauthorized alteration, forgery or falsification of the content or appearance of this document is unlawful and offenders may be prosecuted to the fullest extent of the law. Unless otherwise stated the results shown in this test report refer only to the sample(s) tested and such sample(s) are retained for 30 days only.

Attention: To check the authenticity of testing /inspection report & certificate, please contact us at telephone: (86-755) 8307 1443, or email: CN.Doccheck@sgs.com
No.1 Workshop, M-10, Middle Section, Science & Technology Park, Shenzhen, China 518057 t (86-755) 26012053 f (86-755) 26710594 www.sgs.com.cn
中国·深圳·科技园中区M-10栋一号厂房 邮编: 518057 t (86-755) 26012053 f (86-755) 26710594 sgs.china@sgs.com

5 HAC (T Coil) Measurement

5.1 T-Coil Performance Requirements

In order to be rated for T-Coil use, a WD shall meet the requirements for signal level and signal quality contained in this part.

1) T-Coil coupling field intensity

When measured as specified in ANSI C63.19, the T-Coil signal shall be ≥ -18 dB (A/m) at 1 kHz, in a 1/3 octave band filter for all orientations.

2) Frequency response

The frequency response of the axial component of the magnetic field, measured in 1/3 octave bands, shall follow the response curve specified in this sub-clause, over the frequency range 300 Hz to 3000 Hz. Figure 1 and Figure 2 provide the boundaries for the specified frequency.

These response curves are for true field strength measurements of the T-Coil signal. Thus the 6 dB/octave probe response has been corrected from the raw readings.

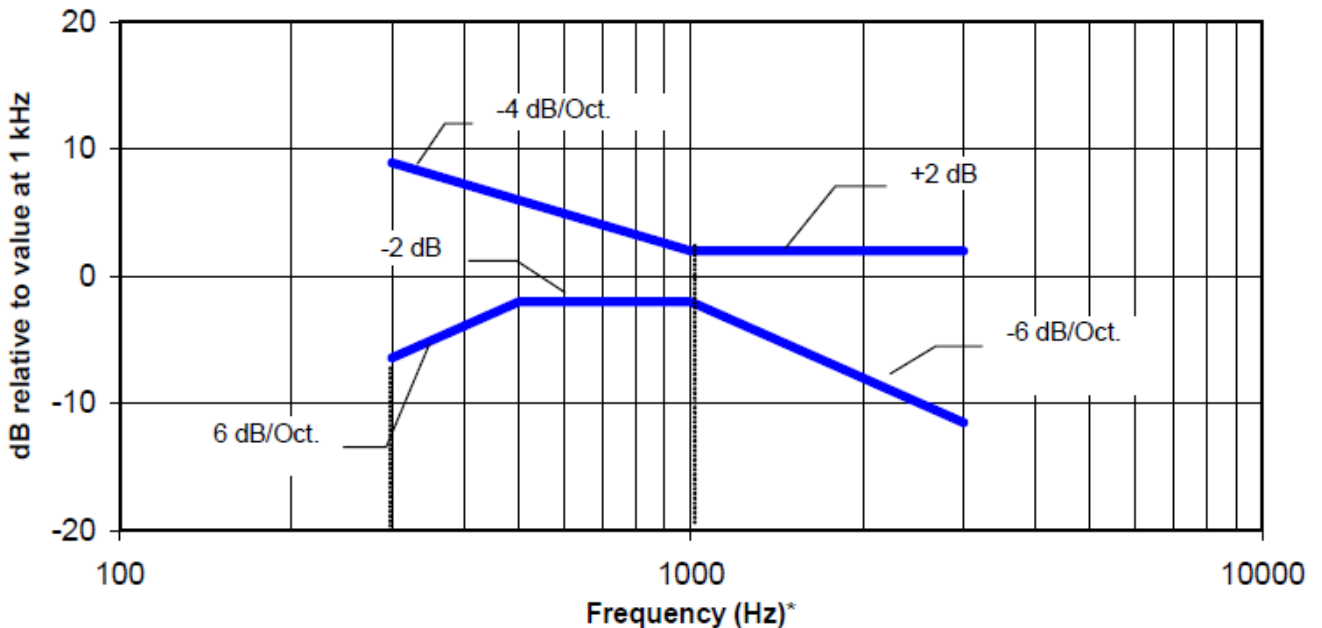

Figure 1—Magnetic field frequency response for WDs with a field ≤ -15 dB (A/m) at 1 kHz



Unless otherwise agreed in writing, this document is issued by the Company subject to its General Conditions of Service printed overleaf, available on request or accessible at <http://www.sgs.com/en/Terms-and-Conditions.aspx> and, for electronic format documents, subject to Terms and Conditions for Electronic Documents at <http://www.sgs.com/en/Terms-and-Conditions/Terms-e-Documents.aspx>. Attention is drawn to the limitation of liability, indemnification and jurisdiction issues defined therein. Any holder of this document is advised that information contained hereon reflects the Company's findings at the time of its intervention only and within the limits of Client's instructions, if any. The Company's sole responsibility is to its Client and this document does not exonerate parties to a transaction from exercising all their rights and obligations under the transaction documents. This document cannot be reproduced except in full, without prior written approval of the Company. Any unauthorized alteration, forgery or falsification of the content or appearance of this document is unlawful and offenders may be prosecuted to the fullest extent of the law. Unless otherwise stated the results shown in this test report refer only to the sample(s) tested and such sample(s) are retained for 30 days only.

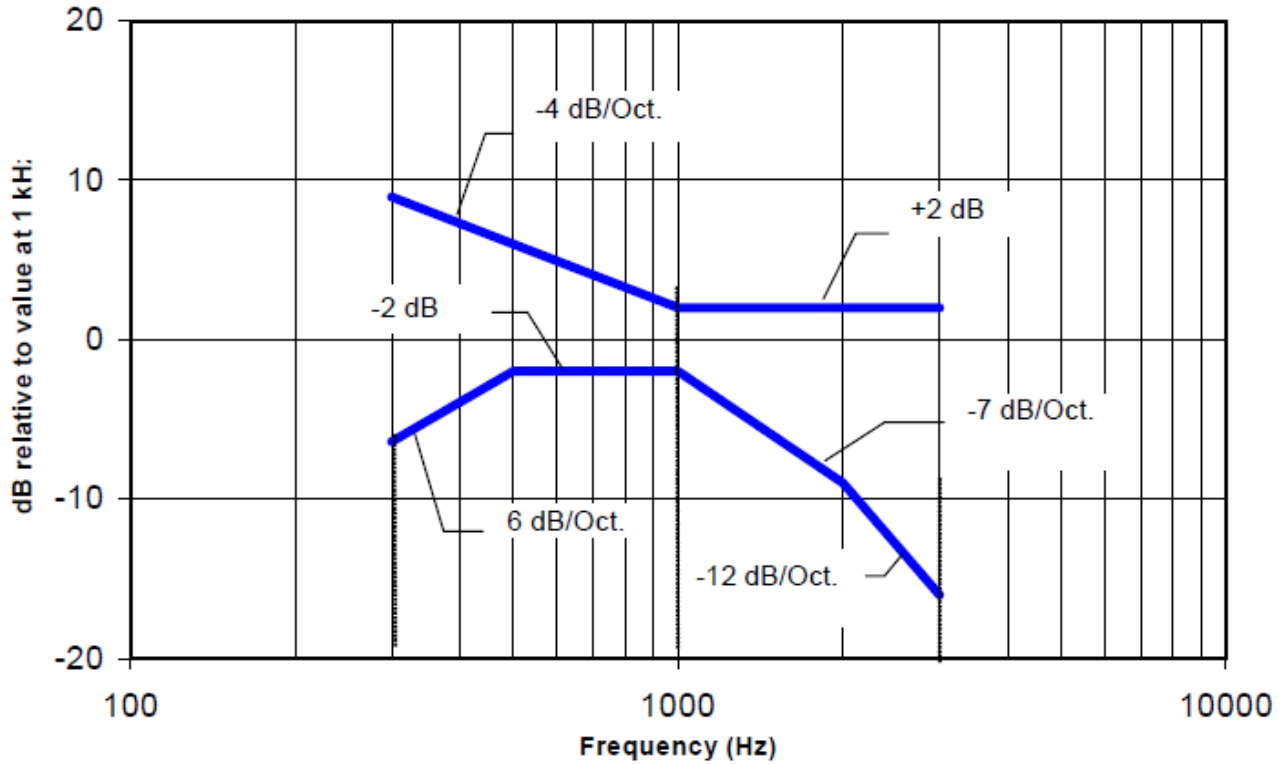

Figure 2 —Magnetic field frequency response for WDs with a field that exceeds -15dB(A/m) at 1 kHz

3) Signal quality

This part provides the signal quality requirement for the intended T-Coil signal from a WD. Only the RF immunity of the hearing aid is measured in T-Coil mode. It is assumed that a hearing aid can have no immunity to an interference signal in the audio band, which is the intended reception band for this mode. So, the only criteria that can be measured is the RF immunity in T-Coil mode. This is measured using the same procedure as for the audio coupling mode and at the same levels.

The worst signal quality of the three T-Coil signal measurements shall be used to determine the T-Coil mode category per Table 3

Category	Telephone parameters WD signal quality [(signal + noise) – to – noise ratio in decibels]
Category T1	0 dB to 10 dB
Category T2	10 dB to 20 dB
Category T3	20 dB to 30 dB
Category T4	> 30 dB

Table 3: T-Coil signal quality categories



Unless otherwise agreed in writing, this document is issued by the Company subject to its General Conditions of Service printed overleaf, available on request or accessible at <http://www.sgs.com/en/Terms-and-Conditions.aspx> and, for electronic format documents, subject to Terms and Conditions for Electronic Documents at <http://www.sgs.com/en/Terms-and-Conditions/Terms-e-Documents.aspx>. Attention is drawn to the limitation of liability, indemnification and jurisdiction issues defined therein. Any holder of this document is advised that information contained hereon reflects the Company's findings at the time of its intervention only and within the limits of Client's instructions, if any. The Company's sole responsibility is to its Client and this document does not exonerate parties to a transaction from exercising all their rights and obligations under the transaction documents. This document cannot be reproduced except in full, without prior written approval of the Company. Any unauthorized alteration, forgery or falsification of the content or appearance of this document is unlawful and offenders may be prosecuted to the fullest extent of the law. Unless otherwise stated the results shown in this test report refer only to the sample(s) tested and such sample(s) are retained for 30 days only.

5.2 T-Coil measurement points and reference plane

Figure 3 illustrate the references and reference plane that shall be used in a typical EUT emissions measurement. The principle of this section is applied to EUT with similar geometry. Please refer to Appendix C for the setup photographs.

- ◆ The area is 5 cm by 5 cm.
- ◆ The area is centered on the audio frequency output transducer of the EUT.
- ◆ The area is in a reference plane, which is defined as the planar area that contains the highest point in the area of the phone that normally rests against the user's ear. It is parallel to the centerline of the receiver area of the phone and is defined by the points of the receiver-end of the EUT handset, which, in normal handset use, rest against the ear.
- ◆ The measurement plane is parallel to, and 10 mm in front of, the reference plane.

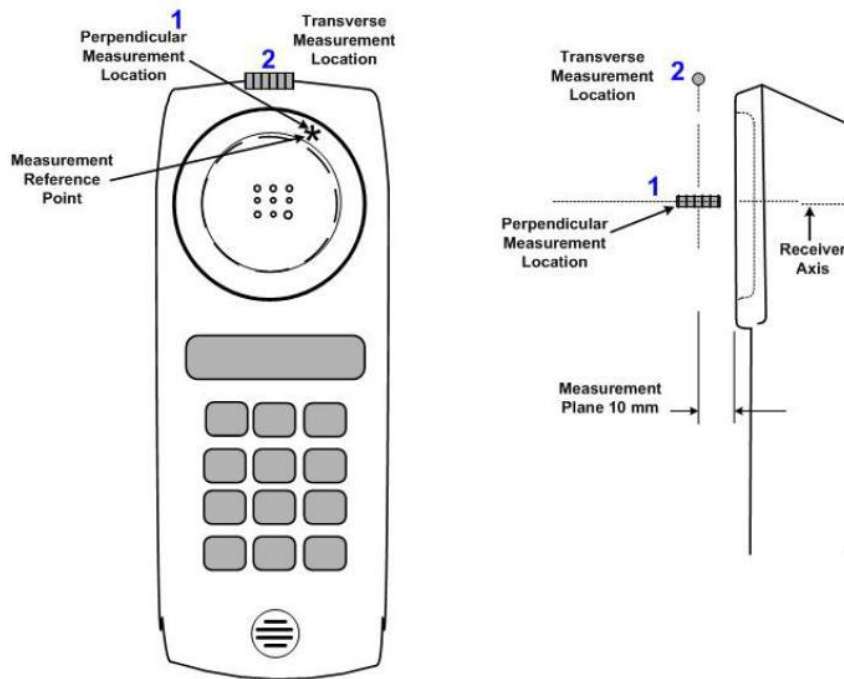

Figure 3 Axis and planes for WD audio frequency magnetic field measurements



Unless otherwise agreed in writing, this document is issued by the Company subject to its General Conditions of Service printed overleaf, available on request or accessible at <http://www.sgs.com/en/Terms-and-Conditions.aspx> and, for electronic format documents, subject to Terms and Conditions for Electronic Documents at <http://www.sgs.com/en/Terms-and-Conditions/Terms-e-Documents.aspx>. Attention is drawn to the limitation of liability, indemnification and jurisdiction issues defined therein. Any holder of this document is advised that information contained hereon reflects the Company's findings at the time of its intervention only and within the limits of Client's instructions, if any. The Company's sole responsibility is to its Client and this document does not exonerate parties to a transaction from exercising all their rights and obligations under the transaction documents. This document cannot be reproduced except in full, without prior written approval of the Company. Any unauthorized alteration, forgery or falsification of the content or appearance of this document is unlawful and offenders may be prosecuted to the fullest extent of the law. Unless otherwise stated the results shown in this test report refer only to the sample(s) tested and such sample(s) are retained for 30 days only.

5.3 T-Coil Measurement Procedure

According to ANSI C63.19-2011, section 7.4:

This section describes the procedures used to measure the ABM (T-Coil) performance of the WD. In addition to measuring the absolute signal levels, the A-weighted magnitude of the unintended signal shall also be determined. To assure that the required signal quality is measured, the measurement of the intended signal and the measurement of the unintended signal must be made at the same location for each measurement position. In addition, the RF field strength at each measurement location must be at or below that required for the assigned category.

Measurements shall not include undesired properties from the WD's RF field; therefore, use of a coaxial connection to a base station simulator or nonradiating load might be necessary. However, even with a coaxial connection to a base station simulator or nonradiating load, there might still be RF leakage from the WD, which can interfere with the desired measurement. Premeasurement checks should be made to avoid this possibility. All measurements shall be performed with the WD operating on battery power with an appropriate normal speech audio signal input level given in ANSI C63.19-2011 Table 7.1. If the device display can be turned off during a phone call, then that may be done during the measurement as well.

Measurements shall be performed at two locations specified in ANSI C63.19-2011 A.3, with the correct probe orientation for a particular location, in a multistage sequence by first measuring the field intensity of the desired T-Coil signal (ABM1) that is useful to a hearing aid T-Coil. The undesired magnetic components (ABM2) shall be examined for each probe orientation to determine the possible effects from the WD display and battery current paths that might disrupt the desired T-Coil signal. The undesired magnetic signal (ABM2) must be measured at the same location as the desired ABM or T-Coil signal (ABM1), and the ratio of desired to undesired ABM signals must be calculated. For the perpendicular field location, only the ABM1 frequency response shall be determined in a third measurement stage.

The following steps summarize the basic test flow for determining ABM1 and ABM2. These steps assume that a sine-wave or narrowband 1/3 octave signal can be used for the measurement of ABM1.

- a) A validation of the test setup and instrumentation may be performed using a TMFS or Helmholtz coil. Measure the emissions and confirm that they are within the specified tolerance.
- b) Position the WD in the test setup and connect the WD RF connector to a base station simulator or a nonradiating load as shown in ANSI C63.19-2011 Figure 7.1 or Figure 7.2. Confirm that the equipment that requires calibration has been calibrated and that the noise level meets the requirements of ANSI C63.19-2011 clause 7.3.1.
- c) The drive level to the WD is set such that the reference input level specified in ANSI C63.19-2011 Table 7.1 is input to the base station simulator (or manufacturer's test mode equivalent) in the 1 kHz, 1/3 octave band. This drive level shall be used for the T-Coil signal test (ABM1) at $f = 1$ kHz. Either a sine wave at 1025 Hz or a voice-like signal, band-limited to the 1 kHz 1/3 octave, as defined in C63.19-2011 clause 7.4.2, shall be used for the reference audio signal. If interference is found at 1025 Hz, an alternative nearby reference audio signal frequency may be used. The same drive level shall be used for the ABM1 frequency response measurements at each 1/3 octave band center frequency. The WD volume control may be set at any level up to maximum, provided that a signal at any frequency at maximum modulation would not result in clipping or signal overload.
- d) Determine the magnetic measurement locations for the WD device (A.3), if not already specified by the manufacturer, as described in C63.19-2011 clause 7.4.4.1.1 and 7.4.4.2.
- e) At each measurement location, measure and record the desired T-Coil magnetic signals (ABM1 at f_i) as specified in C63.19-2011 clause 7.4.4.2 in each ISO 266-1975 R10 standard 1/3 octave band. The desired audio band input frequency (f_i) shall be centered in each 1/3 octave band maintaining the same drive level as determined in item c) and the reading taken for that band.
- f) Equivalent methods of determining the frequency response may also be employed, such as fast Fourier transform (FFT) analysis using noise excitation or input-output comparison using simulated speech. The full-band integrated or half-band integrated probe output, as specified in D.9, may be used, as long as the appropriate calibration curve is applied to the measured result, so as to yield an accurate measurement of the field magnitude. (The resulting measurement shall be an accurate measurement in dB A/m.)
- g) All measurements of the desired signal shall be shown to be of the desired signal and not of an undesired signal. This may be shown by turning the desired signal ON and OFF with the probe measuring the same location.



Unless otherwise agreed in writing, this document is issued by the Company subject to its General Conditions of Service printed overleaf, available on request or accessible at <http://www.sgs.com/en/Terms-and-Conditions.aspx> and, for electronic format documents, subject to Terms and Conditions for Electronic Documents at <http://www.sgs.com/en/Terms-and-Conditions/Terms-e-Documents.aspx>. Attention is drawn to the limitation of liability, indemnification and jurisdiction issues defined therein. Any holder of this document is advised that information contained hereon reflects the Company's findings at the time of its intervention only and within the limits of Client's instructions, if any. The Company's sole responsibility is to its Client and this document does not exonerate parties to a transaction from exercising all their rights and obligations under the transaction documents. This document cannot be reproduced except in full, without prior written approval of the Company. Any unauthorized alteration, forgery or falsification of the content or appearance of this document is unlawful and offenders may be prosecuted to the fullest extent of the law. Unless otherwise stated the results shown in this test report refer only to the sample(s) tested and such sample(s) are retained for 30 days only.

Attention: To check the authenticity of testing/inspection report & certificate, please contact us at telephone: (86-755) 8307 1443, or email: CN.Doccheck@sgs.com
No.1 Workshop, M-10, Middle Section, Science & Technology Park, Shenzhen, China 518057 t (86-755) 26012053 f (86-755) 26710594 www.sgsgroup.com.cn
中国·深圳·科技园中区M-10栋一号厂房 邮编: 518057 t (86-755) 26012053 f (86-755) 26710594 sgs.china@sgs.com

If the scanning method is used, the scans shall show that all measurement points selected for the ABM1 measurement meet the ambient and test system noise criteria in C63.19-2011 clause 7.3.1.

h) At the measurement location for each orientation, measure and record the undesired broadband audio magnetic signal (ABM2) as specified in C63.19-2011 clause 7.4.4.4 with no audio signal applied (or digital zero applied, if appropriate) using A-weighting⁴⁹ and the half-band integrator. Calculate the ratio of the desired to undesired signal strength (i.e., signal quality).

g) Determine the category that properly classifies the signal quality, based on C63.19-2011 Table 8.5.



Unless otherwise agreed in writing, this document is issued by the Company subject to its General Conditions of Service printed overleaf, available on request or accessible at <http://www.sgs.com/en/Terms-and-Conditions.aspx> and, for electronic format documents, subject to Terms and Conditions for Electronic Documents at <http://www.sgs.com/en/Terms-and-Conditions/Terms-e-Documents.aspx>. Attention is drawn to the limitation of liability, indemnification and jurisdiction issues defined therein. Any holder of this document is advised that information contained hereon reflects the Company's findings at the time of its intervention only and within the limits of Client's instructions, if any. The Company's sole responsibility is to its Client and this document does not exonerate parties to a transaction from exercising all their rights and obligations under the transaction documents. This document cannot be reproduced except in full, without prior written approval of the Company. Any unauthorized alteration, forgery or falsification of the content or appearance of this document is unlawful and offenders may be prosecuted to the fullest extent of the law. Unless otherwise stated the results shown in this test report refer only to the sample(s) tested and such sample(s) are retained for 30 days only.

Attention: To check the authenticity of testing /inspection report & certificate, please contact us at telephone: (86-755) 8307 1443, or email: CN.Doccheck@sgs.com

6 T-Coil testing for CMRS Voice

6.1 General Description

1. Codec Investigation:

For a voice service/air interface, investigate the variations of codec configurations (WB, NB bit rate) and document the parameters (ABM1, ABM2, S+N/N, frequency response) for that voice service. It is only necessary to document this for one channel/band, the following worst investigation codec would be remarked to be used for the testing for the handset.

2. Air Interface Investigation:

a. Use the worst-case codec test and document a limited set of bands/channel/bandwidths. Observe the effect of changing the band and bandwidth to ensure that there are no unexpected variations. Using the knowledge of the observed variations, it is necessary to report only a set band/channel/bandwidth for each orientation for a voice service/air interface.

b. According to the ANSI C63.19 2011 section 7.3.2, test middle channel of each frequency band for HAC testing for each orientation to determine worst HAC T-Coil rating.

6.2 GSM Tests Results

Codec Investigation:

Band	Test Mode	Test Ch./Freq.	Probe Position	ABM1 (dBA/m)	ABM2 (dBA/m)	Signal Quality (dB)	T Rating	Freq. Response Variation (dB)	Frequency Response	Codec Setting
GSM850	GSM Voice	190/836.6	Axial (Z)	5.43	-27.60	33.03	T4	1.73	Pass	FR V1
	GSM Voice	190/836.6	Axial (Z)	5.76	-29.52	35.28	T4	1.31	Pass	HR V1

Remark: According to codec investigation, the worst codec is **FR_V1**

Air Interface Investigation:

Band	Test Mode	Test Ch./Freq.	Probe Position	ABM1 (dBA/m)	ABM2 (dBA/m)	Signal Quality (dB)	T Rating	Freq. Response Variation (dB)	Frequency Response
GSM850	GSM Voice	190/836.6	Axial (Z)	5.43	-27.60	33.03	T4	1.73	Pass
			Transversal (Y)	-3.90	-33.77	29.87	T3	N/A	/
GSM1900	GSM Voice	661/1880	Axial (Z)	5.33	-30.05	35.38	T4	1.85	Pass
			Transversal (Y)	-5.07	-36.34	31.27	T4	N/A	/

Remark:

1. Phone Condition: Mute on; Backlight off; Max Volume
2. The detail frequency response results please refer to appendix A.



Unless otherwise agreed in writing, this document is issued by the Company subject to its General Conditions of Service printed overleaf, available on request or accessible at <http://www.sgs.com/en/Terms-and-Conditions.aspx> and, for electronic format documents, subject to Terms and Conditions for Electronic Documents at <http://www.sgs.com/en/Terms-and-Conditions/Terms-e-Documents.aspx>. Attention is drawn to the limitation of liability, indemnification and jurisdiction issues defined therein. Any holder of this document is advised that information contained hereon reflects the Company's findings at the time of its intervention only and within the limits of Client's instructions, if any. The Company's sole responsibility is to its Client and this document does not exonerate parties to a transaction from exercising all their rights and obligations under the transaction documents. This document cannot be reproduced except in full, without prior written approval of the Company. Any unauthorized alteration, forgery or falsification of the content or appearance of this document is unlawful and offenders may be prosecuted to the fullest extent of the law. Unless otherwise stated the results shown in this test report refer only to the sample(s) tested and such sample(s) are retained for 30 days only.

Attention: To check the authenticity of testing /inspection report & certificate, please contact us at telephone: (86-755) 8307 1443, or email: CN.Doccheck@sgs.com
No.1 Workshop, M-10, Middle Section, Science & Technology Park, Shenzhen, China 518057 t (86-755) 26012053 f (86-755) 26710594 www.sgs.com.cn
中国·深圳·科技园中区M-10栋一号厂房 邮编: 518057 f (86-755) 26012053 f (86-755) 26710594 sgs.china@sgs.com

6.3 UMTS Tests Results

Codec Investigation:

Band	Test Mode	Test Ch./Freq.	Probe Position	ABM1 (dBA/m)	ABM2 (dBA/m)	Signal Quality (dB)	T Rating	Freq. Response Variation (dB)	Frequency Response	Codec Setting
WCDMA Band V	AMR Voice	4182/836.4	Axial (Z)	1.61	-30.62	32.23	T4	0.80	Pass	4.75kbps
	AMR Voice	4182/836.4	Axial (Z)	3.14	-30.97	34.11	T4	0.83	Pass	7.95kbps
	AMR Voice	4182/836.4	Axial (Z)	3.49	-31.73	35.22	T4	0.50	Pass	12.2kbps

Remark: According to codec investigation, the worst codec is **AMR 4.75Kbps**

Air Interface Investigation:

Band	Test Mode	Test Ch./Freq.	Probe Position	ABM1 (dBA/m)	ABM2 (dBA/m)	Signal Quality (dB)	T Rating	Freq. Response Variation (dB)	Frequency Response
WCDMA Band II	AMR Voice	9400/1900	Axial (Z)	2.48	-32.95	35.43	T4	1.25	Pass
			Transversal (Y)	-7.74	-41.37	33.63	T4	N/A	/
WCDMA Band IV	AMR Voice	1412/1732.4	Axial (Z)	2.20	-33.88	36.08	T4	0.44	Pass
			Transversal (Y)	-7.81	-43.10	35.29	T4	N/A	/
WCDMA Band V	AMR Voice	4182/836.4	Axial (Z)	1.61	-30.62	32.23	T4	2.00	Pass
			Transversal (Y)	-8.45	-40.46	32.01	T4	N/A	/

Remark:

1. Phone Condition: Mute on; Backlight off; Max Volume
2. The detail frequency response results please refer to appendix A.



Unless otherwise agreed in writing, this document is issued by the Company subject to its General Conditions of Service printed overleaf, available on request or accessible at <http://www.sgs.com/en/Terms-and-Conditions.aspx> and, for electronic format documents, subject to Terms and Conditions for Electronic Documents at <http://www.sgs.com/en/Terms-and-Conditions/Terms-e-Documents.aspx>. Attention is drawn to the limitation of liability, indemnification and jurisdiction issues defined therein. Any holder of this document is advised that information contained hereon reflects the Company's findings at the time of its intervention only and within the limits of Client's instructions, if any. The Company's sole responsibility is to its Client and this document does not exonerate parties to a transaction from exercising all their rights and obligations under the transaction documents. This document cannot be reproduced except in full, without prior written approval of the Company. Any unauthorized alteration, forgery or falsification of the content or appearance of this document is unlawful and offenders may be prosecuted to the fullest extent of the law. Unless otherwise stated the results shown in this test report refer only to the sample(s) tested and such sample(s) are retained for 30 days only.

Attention: To check the authenticity of testing /inspection report & certificate, please contact us at telephone: (86-755) 8307 1443, or email: CN.Doccheck@sgs.com
No.1 Workshop, M-10, Middle Section, Science & Technology Park, Shenzhen, China 518057 t (86-755) 26012053 f (86-755) 26710594 www.sgs.com.cn
中国·深圳·科技园中区M-10栋一号厂房 邮编: 518057 t (86-755) 26012053 f (86-755) 26710594 sgs.china@sgs.com

7 T-Coil testing for CMRS IP Voice

7.1 VoLTE Tests Results

1. Codec Investigation:

For a voice service/air interface, investigate the variations of codec configurations (WB, NB bit rate) and document the parameters (ABM1, ABM2, S+N/N, frequency response) for that voice service. It is only necessary to document this for one channel / band, the following worst investigation codec would be remarked to be used for the testing for the handset.

2. Air Interface Investigation:

- Use the worst-case codec test and document a limited set of bands / channel / bandwidths. Observe the effect of changing the band and bandwidth to ensure that there are no unexpected variations. Using the knowledge of the observed variations, it is necessary to report only a set band/channel/bandwidth for each orientation for a voice service/air interface and the following worst configure would be remarked to be used for the testing for the handset.
- Select LTE FDD / TDD one frequency band to do measurement at the worst SNR position was additionally performed with varying the BWs/Modulations/RB size to verify the variation to find out worst configuration, the observed variation is very little to be within 1.5 dB which is much less than the margin from the rating threshold.
- According to the ANSI C63.19 2011 section 7.3.2, test middle channel of each frequency band for HAC testing for each orientation to determine worst HAC T-Coil rating.

Codec Investigation:

LTE FDD

Band	Test Mode	Test Ch./Freq.	Probe Position	ABM1 (dBA/m)	ABM2 (dBA/m)	Signal Quality (dB)	T Rating	Freq. Response Variation (dB)	Frequency Response	Codec Setting
LTE Band 2	20M QPSK 1RB_0	18900/1880	Axial (Z)	4.21	-30.82	35.03	T4	2.00	Pass	WB AMR 6.60kbps
	20M QPSK 1RB_0	18900/1880	Axial (Z)	4.90	-33.09	37.99	T4	2.00	Pass	WB AMR 23.85kbps
	20M QPSK 1RB_0	18900/1880	Axial (Z)	5.57	-32.29	37.86	T4	0.18	Pass	NB AMR 4.75kbps
	20M QPSK 1RB_0	18900/1880	Axial (Z)	5.50	-31.32	36.82	T4	1.06	Pass	NB AMR 12.2kbps

Remark: According to codec investigation, the worst codec is **WB AMR 6.60kbps**

LTE TDD

Band	Test Mode	Test Ch./Freq.	UL-DL configuration	Probe Position	ABM1 (dBA/m)	ABM2 (dBA/m)	Signal Quality (dB)	T Rating	Freq. Response Variation (dB)	Frequency Response	Codec Setting
LTE Band 41 PC3	20M QPSK 1RB_0	40620/2593	0	Axial (Z)	2.67	-30.82	33.49	T4	1.82	Pass	WB AMR 6.60kbps
	20M QPSK 1RB_0	40620/2593	0	Axial (Z)	2.71	-31.40	34.11	T4	2.00	Pass	WB AMR 23.85kbps
	20M QPSK 1RB_0	40620/2593	0	Axial (Z)	3.71	-31.25	34.96	T4	0.43	Pass	NB AMR 4.75kbps
	20M QPSK 1RB_0	40620/2593	0	Axial (Z)	4.10	-30.61	34.71	T4	1.06	Pass	NB AMR 12.2kbps

Remark: According to codec investigation, the worst codec is **WB AMR 6.60kbps**



Unless otherwise agreed in writing, this document is issued by the Company subject to its General Conditions of Service printed overleaf, available on request or accessible at <http://www.sgs.com/en/Terms-and-Conditions.aspx> and, for electronic format documents, subject to Terms and Conditions for Electronic Documents at <http://www.sgs.com/en/Terms-and-Conditions/Terms-e-Documents.aspx>. Attention is drawn to the limitation of liability, indemnification and jurisdiction issues defined therein. Any holder of this document is advised that information contained hereon reflects the Company's findings at the time of its intervention only and within the limits of Client's instructions, if any. The Company's sole responsibility is to its Client and this document does not exonerate parties to a transaction from exercising all their rights and obligations under the transaction documents. This document cannot be reproduced except in full, without prior written approval of the Company. Any unauthorized alteration, forgery or falsification of the content or appearance of this document is unlawful and offenders may be prosecuted to the fullest extent of the law. Unless otherwise stated the results shown in this test report refer only to the sample(s) tested and such sample(s) are retained for 30 days only.

Air Interface Investigation:
LTE FDD

Band	Test Mode	Test Ch./Freq.	Probe Position	ABM1 (dBA/m)	ABM2 (dBA/m)	Signal Quality (dB)	T Rating	Freq. Response Variation (dB)	Frequency Response
LTE Band 2	20M QPSK 1RB_0	18900/1880	Axial (Z)	4.21	-30.82	35.03	T4	2.00	Pass
	20M QPSK 1RB_50	18900/1880	Axial (Z)	4.42	-33.30	37.72	T4	2.00	Pass
	20M QPSK 1RB_99	18900/1880	Axial (Z)	3.60	-33.17	36.77	T4	1.70	Pass
	20M QPSK 50RB_0	18900/1880	Axial (Z)	4.26	-33.54	37.80	T4	2.00	Pass
	20M QPSK 50RB_25	18900/1880	Axial (Z)	4.38	-32.50	36.88	T4	2.00	Pass
	20M QPSK 50RB_50	18900/1880	Axial (Z)	4.53	-31.99	36.52	T4	2.00	Pass
	20M QPSK 100RB_0	18900/1880	Axial (Z)	4.47	-32.51	36.98	T4	2.00	Pass
	20M 16QAM 1RB_0	18900/1880	Axial (Z)	4.36	-31.30	35.66	T4	1.39	Pass
	15M QPSK 1RB_0	18900/1880	Axial (Z)	4.38	-32.77	37.15	T4	2.00	Pass
	10M QPSK 1RB_0	18900/1880	Axial (Z)	4.59	-32.90	37.49	T4	2.00	Pass
	5M QPSK 1RB_0	18900/1880	Axial (Z)	4.54	-34.11	38.65	T4	1.58	Pass
3M QPSK 1RB_0	18900/1880	Axial (Z)	4.43	-33.93	38.36	T4	2.00	Pass	
1.4M QPSK 1RB_0	18900/1880	Axial (Z)	4.79	-33.80	38.59	T4	2.00	Pass	

LTE TDD

Band	Test Mode	Test Ch./Freq.	UL-DL Configuration	Probe Position	ABM1 (dBA/m)	ABM2 (dBA/m)	Signal Quality (dB)	T Rating	Freq. Response Variation (dB)	Frequency Response
LTE Band 41 PC3	20M QPSK 1RB_0	40620/2593	0	Axial (Z)	2.67	-30.82	33.49	T4	1.82	Pass
	20M QPSK 1RB_50	40620/2593	0	Axial (Z)	3.78	-29.13	32.91	T4	2.00	Pass
	20M QPSK 1RB_99	40620/2593	0	Axial (Z)	3.81	-28.79	32.60	T4	1.89	Pass
	20M QPSK 50RB_0	40620/2593	0	Axial (Z)	4.10	-28.49	32.59	T4	1.73	Pass
	20M QPSK 50RB_25	40620/2593	0	Axial (Z)	3.97	-29.32	33.29	T4	2.00	Pass
	20M QPSK 50RB_50	40620/2593	0	Axial (Z)	3.76	-28.60	32.36	T4	2.00	Pass
	20M QPSK 100RB_0	40620/2593	0	Axial (Z)	3.81	-29.06	32.87	T4	2.00	Pass
	20M 16QAM 50RB_50	40620/2593	0	Axial (Z)	3.76	-28.82	32.58	T4	1.94	Pass
	15M QPSK 36RB_39	40620/2593	0	Axial (Z)	3.80	-28.70	32.50	T4	1.22	Pass
	10M QPSK 25RB_25	40620/2593	0	Axial (Z)	3.25	-29.17	32.42	T4	2.00	Pass
	5M QPSK 12RB_13	40620/2593	0	Axial (Z)	3.46	-29.48	32.94	T4	2.00	Pass
	20M QPSK 50RB_50	40620/2593	1	Axial (Z)	2.45	-31.77	34.22	T4	2.00	Pass
	20M QPSK 50RB_50	40620/2593	2	Axial (Z)	3.15	-31.60	34.75	T4	2.00	Pass
	20M QPSK 50RB_50	40620/2593	3	Axial (Z)	2.99	-32.25	35.24	T4	2.00	Pass
	20M QPSK 50RB_50	40620/2593	4	Axial (Z)	2.79	-32.06	34.85	T4	1.75	Pass
	20M QPSK 50RB_50	40620/2593	5	Axial (Z)	3.55	-31.57	35.12	T4	1.87	Pass
	20M QPSK 50RB_50	40620/2593	6	Axial (Z)	3.73	-30.55	34.28	T4	2.00	Pass
LTE Band 41 PC2	20M QPSK 50RB_50	40620/2593	1	Axial (Z)	3.42	-31.35	34.77	T4	1.88	Pass
	20M QPSK 50RB_50	40620/2593	2	Axial (Z)	3.55	-31.03	34.58	T4	2.00	Pass
	20M QPSK 50RB_50	40620/2593	3	Axial (Z)	3.48	-31.42	34.90	T4	2.00	Pass
	20M QPSK 50RB_50	40620/2593	4	Axial (Z)	3.65	-31.56	35.21	T4	1.89	Pass
	20M QPSK 50RB_50	40620/2593	5	Axial (Z)	3.73	-31.84	35.57	T4	2.00	Pass



Unless otherwise agreed in writing, this document is issued by the Company subject to its General Conditions of Service printed overleaf, available on request or accessible at <http://www.sgs.com/en/Terms-and-Conditions.aspx> and, for electronic format documents, subject to Terms and Conditions for Electronic Documents at <http://www.sgs.com/en/Terms-and-Conditions/Terms-e-Documents.aspx>. Attention is drawn to the limitation of liability, indemnification and jurisdiction issues defined therein. Any holder of this document is advised that information contained hereon reflects the Company's findings at the time of its intervention only and within the limits of Client's instructions, if any. The Company's sole responsibility is to its Client and this document does not exonerate parties to a transaction from exercising all their rights and obligations under the transaction documents. This document cannot be reproduced except in full, without prior written approval of the Company. Any unauthorized alteration, forgery or falsification of the content or appearance of this document is unlawful and offenders may be prosecuted to the fullest extent of the law. Unless otherwise stated the results shown in this test report refer only to the sample(s) tested and such sample(s) are retained for 30 days only.

Air interface:
LTE FDD

Band	Test Mode	Test Ch./Freq.	Probe Position	ABM1 (dBA/m)	ABM2 (dBA/m)	Signal Quality (dB)	T Rating	Freq. Response Variation (dB)	Frequency Response
LTE Band 2	20M QPSK 1RB_0	18900/1880	Axial (Z)	4.21	-30.82	35.03	T4	2.00	Pass
			Transversal (Y)	-4.66	-42.69	38.03	T4	N/A	/
LTE Band 4	20M QPSK 1RB_0	20175/1732.5	Axial (Z)	4.69	-31.30	35.99	T4	2.00	Pass
			Transversal (Y)	-5.50	-38.72	33.22	T4	N/A	/
LTE Band 5	10M QPSK 1RB_0	20525/836.5	Axial (Z)	4.31	-30.22	34.53	T4	2.00	Pass
			Transversal (Y)	-5.69	-41.20	35.51	T4	N/A	/
LTE Band 12	10M QPSK 1RB_0	23095/707.5	Axial (Z)	2.11	-32.07	34.18	T4	1.84	Pass
			Transversal (Y)	-5.05	-38.35	33.30	T4	N/A	/
LTE Band 25	20M QPSK 1RB_0	26365/1882.5	Axial (Z)	4.53	-31.14	35.67	T4	1.88	Pass
			Transversal (Y)	-5.33	-39.96	34.63	T4	N/A	/
LTE Band 26	15M QPSK 1RB_0	26865/831.5	Axial (Z)	4.40	-33.95	38.35	T4	2.00	Pass
			Transversal (Y)	-6.42	-41.59	35.17	T4	N/A	/
LTE Band 66	20M QPSK 1RB_0	132322/1745	Axial (Z)	4.43	-32.37	36.80	T4	2.00	Pass
			Transversal (Y)	-5.68	-38.27	32.59	T4	N/A	/
LTE Band 71	20M QPSK 100RB_0	133297/680.5	Axial (Z)	4.27	-32.19	36.46	T4	2.00	Pass
			Transversal (Y)	-5.59	-40.72	35.13	T4	N/A	/

LTE TDD

Band	Test Mode	Test Ch./Freq.	UL-DL Configuration	Probe Position	ABM1 (dBA/m)	ABM2 (dBA/m)	Signal Quality (dB)	T Rating	Freq. Response Variation (dB)	Frequency Response
LTE Band 41 PC3	20M QPSK 50RB_50	40620/2593	0	Axial (Z)	3.76	-28.60	32.36	T4	2.00	Pass
				Transversal (Y)	-6.88	-37.87	30.99	T4	N/A	/

Remark:

1. Phone Condition: Mute on; Backlight off; Max Volume
2. The detail frequency response results please refer to appendix A.



Unless otherwise agreed in writing, this document is issued by the Company subject to its General Conditions of Service printed overleaf, available on request or accessible at <http://www.sgs.com/en/Terms-and-Conditions.aspx> and, for electronic format documents, subject to Terms and Conditions for Electronic Documents at <http://www.sgs.com/en/Terms-and-Conditions/Terms-e-Documents.aspx>. Attention is drawn to the limitation of liability, indemnification and jurisdiction issues defined therein. Any holder of this document is advised that information contained hereon reflects the Company's findings at the time of its intervention only and within the limits of Client's instructions, if any. The Company's sole responsibility is to its Client and this document does not exonerate parties to a transaction from exercising all their rights and obligations under the transaction documents. This document cannot be reproduced except in full, without prior written approval of the Company. Any unauthorized alteration, forgery or falsification of the content or appearance of this document is unlawful and offenders may be prosecuted to the fullest extent of the law. Unless otherwise stated the results shown in this test report refer only to the sample(s) tested and such sample(s) are retained for 30 days only.

Attention: To check the authenticity of testing /inspection report & certificate, please contact us at telephone: (86-755) 8307 1443, or email: CN.Doccheck@sgs.com
No.1 Workshop, M-10, Middle Section, Science & Technology Park, Shenzhen, China 518057 t (86-755) 26012053 f (86-755) 26710594 www.sgs.com.cn
中国·深圳·科技园中区M-10栋一号厂房 邮编: 518057 t (86-755) 26012053 f (86-755) 26710594 sgs.china@sgs.com

7.2 T-Coil testing for OTT VoIP Application

1. According to the ANSI C63.19 2011 section 7.3.2, test middle channel of each frequency band for HAC testing for each orientation to determine worst HAC T-Coil rating.
2. The google Duo VoIP application are pre-installed on this device. According to KDB 285076 D02, all air interfaces via a data connection with VoIP application need to be considered HAC testing.
3. The Google Duo only support OPUS audio codec and support 6Kbps to 75Kbps bitrate.
4. The test setup used for OTT VoIP call is the DUT connect to the CMW500 and via the data application unit on CMW500 connection to the Internet, the Auxiliary EUT is connected to the WiFi access point, the channel/Modulation/Frequency bands/data rate is configured on the CMW500 for the DUT unit. For the Auxiliary VoIP unit which is used to configure the audio codec rate and determine the audio input level of -20dBm0 based on the KDB 285076 D02v03 requirement.
5. Codec Investigation: For a voice service/air interface, investigate the variations of codec configurations (WB, NB bit rate) and document the parameters (ABM1, ABM2, S+N/N, frequency response) for that voice service. It is only necessary to document this for one channel/band, the following tests results which the worst case codec would be remarked to be used for the testing for the handset.
6. Air Interface Investigation:
 - a. Use the worst-case codec test and document a limited set of bands/channel/bandwidths. Observe the effect of changing the band and bandwidth to ensure that there are no unexpected variations. Using the knowledge of the observed variations, it is necessary to report only a set band/channel/bandwidth for each orientation for a voice service/air interface.
 - b. Due to OTT service and CMRS IP service are all be established over the internet protocol for the voice service, and on both services use the identical RF air interface for the WIFI and LTE, therefore according to VoLTE and VoWiFi test results of air interface investigation, the worst configuration and frequency band of air interface was used for OTT T-Coil testing.

Codec Investigation: EDGE:

Band	Test Mode	Test Ch./ Freq.	Probe Position	ABM1 (dBA/m)	ABM2 (dBA/m)	Signal Quality (dB)	T Rating	Freq. Response Variation (dB)	Frequency Response	Codec Setting
GSM850	EGPRS 2TS	190/836.6	Axial (Z)	-1.48	-32.36	30.88	T4	1.32	Pass	FR V1,OPUS 6kbps
	EGPRS 2TS	190/836.6	Axial (Z)	-1.12	-33.00	31.88	T4	1.25	Pass	FR V1,OPUS 40kbps
	EGPRS 2TS	190/836.6	Axial (Z)	-1.41	-33.08	31.67	T4	1.28	Pass	FR V1,OPUS 75kbps

Remark: According to codec investigation, the worst codec bitrate is **FR V1,OPUS 6kbps**.

Codec Investigation: HSPA:

Band	Test Mode	Test Ch./Freq.	Probe Position	ABM1 (dBA/m)	ABM2 (dBA/m)	Signal Quality (dB)	T Rating	Freq. Response Variation (dB)	Frequency Response	Codec Setting
WCDMA Band V	HSPA	4182/836.4	Axial (Z)	-5.31	-31.22	25.91	T3	1.39	Pass	OPUS 6kbps
	HSPA	4182/836.4	Axial (Z)	-1.24	-32.64	31.40	T4	1.23	Pass	OPUS 40kbps
	HSPA	4182/836.4	Axial (Z)	-1.19	-31.46	30.27	T4	1.33	Pass	OPUS 75kbps

Remark: According to codec investigation, the worst codec bitrate is **OPUS 6Kbps**.



Unless otherwise agreed in writing, this document is issued by the Company subject to its General Conditions of Service printed overleaf, available on request or accessible at <http://www.sgs.com/en/Terms-and-Conditions.aspx> and, for electronic format documents, subject to Terms and Conditions for Electronic Documents at <http://www.sgs.com/en/Terms-and-Conditions/Terms-e-Documents.aspx>. Attention is drawn to the limitation of liability, indemnification and jurisdiction issues defined therein. Any holder of this document is advised that information contained hereon reflects the Company's findings at the time of its intervention only and within the limits of Client's instructions, if any. The Company's sole responsibility is to its Client and this document does not exonerate parties to a transaction from exercising all their rights and obligations under the transaction documents. This document cannot be reproduced except in full, without prior written approval of the Company. Any unauthorized alteration, forgery or falsification of the content or appearance of this document is unlawful and offenders may be prosecuted to the fullest extent of the law. Unless otherwise stated the results shown in this test report refer only to the sample(s) tested and such sample(s) are retained for 30 days only.

Codec Investigation:
LTE FDD:

Band	Test Mode	Test Ch./Freq.	Probe Position	ABM1 (dBA/m)	ABM2 (dBA/m)	Signal Quality (dB)	T Rating	Freq. Response Variation (dB)	Frequency Response	Codec Setting
LTE Band 66	20M QPSK 1RB_0	132322/1745	Axial (Z)	-1.78	-32.35	30.57	T4	0.48	Pass	OPUS 6kbps
	20M QPSK 1RB_0	132322/1745	Axial (Z)	-2.28	-32.88	30.60	T4	0.62	Pass	OPUS 40kbps
	20M QPSK 1RB_0	132322/1745	Axial (Z)	-2.39	-32.30	29.91	T3	0.35	Pass	OPUS 75kbps

Remark: According to codec investigation, the worst codec bitrate is **OPUS 75Kbps**.

Codec Investigation:
LTE TDD:

Band	Test Mode	Test Ch./Freq.	UL-DL configuration	Probe Position	ABM1 (dBA/m)	ABM2 (dBA/m)	Signal Quality (dB)	T Rating	Freq. Response Variation (dB)	Frequency Response	Codec Setting
LTE Band 41 PC3	20M QPSK 50RB_50	40620/2593	0	Axial (Z)	-2.30	-30.15	27.85	T3	1.43	Pass	OPUS 6kbps
	20M QPSK 50RB_50	40620/2593	0	Axial (Z)	-2.45	-30.57	28.12	T3	1.11	Pass	OPUS 40kbps
	20M QPSK 50RB_50	40620/2593	0	Axial (Z)	-2.12	-30.45	28.33	T3	1.22	Pass	OPUS 75kbps

Remark: According to codec investigation, the worst codec bitrate is **OPUS 6Kbps**.

Codec Investigation:
WiFi:

Band	Test Mode	Test Ch./Freq.	Probe Position	ABM1 (dBA/m)	ABM2 (dBA/m)	Signal Quality (dB)	T Rating	Freq. Response Variation (dB)	Frequency Response	Codec Setting
WiFi 2.4G	802.11b	6/2437	Axial (Z)	-3.70	-31.54	27.84	T3	0.77	PASS	1Mbps, OPUS 6kbps
		6/2437	Axial (Z)	-4.41	-31.90	27.49	T3	1.07	PASS	1Mbps, OPUS 40kbps
		6/2437	Axial (Z)	-4.03	-32.64	28.61	T3	1.04	PASS	1Mbps, OPUS 75kbps
WiFi 2.4G	802.11b	6/2437	Axial (Z)	-4.41	-31.90	27.49	T3	1.07	PASS	1Mbps, OPUS 40kbps
WiFi 2.4G	802.11b	6/2437	Axial (Z)	-3.81	-32.63	28.82	T3	0.92	PASS	11Mbps, OPUS 40kbps
WiFi 2.4G	802.11g	6/2437	Axial (Z)	-1.56	-32.15	30.59	T4	1.10	PASS	6Mbps, OPUS 40kbps
WiFi 2.4G	802.11g	6/2437	Axial (Z)	-1.42	-30.97	29.55	T3	0.79	PASS	54Mbps, OPUS 40kbps
WiFi 2.4G	802.11n-HT20	6/2437	Axial (Z)	-3.80	-33.34	29.54	T3	1.10	PASS	MCS0, OPUS 40kbps
WiFi 2.4G	802.11n-HT20	6/2437	Axial (Z)	-3.15	-32.99	29.84	T3	0.88	PASS	MCS7, OPUS 40kbps
WiFi 2.4G	802.11n-HT40	6/2437	Axial (Z)	-3.75	-34.82	31.07	T4	1.12	PASS	MCS0, OPUS 40kbps
WiFi 2.4G	802.11n-HT40	6/2437	Axial (Z)	-3.22	-33.33	30.11	T4	0.85	PASS	MCS7, OPUS 40kbps

Remark: According to codec investigation, WiFi 2.4G the worst codec is **1Mbps, OPUS 40kbps**.



Unless otherwise agreed in writing, this document is issued by the Company subject to its General Conditions of Service printed overleaf, available on request or accessible at <http://www.sgs.com/en/Terms-and-Conditions.aspx> and, for electronic format documents, subject to Terms and Conditions for Electronic Documents at <http://www.sgs.com/en/Terms-and-Conditions/Terms-e-Documents.aspx>. Attention is drawn to the limitation of liability, indemnification and jurisdiction issues defined therein. Any holder of this document is advised that information contained hereon reflects the Company's findings at the time of its intervention only and within the limits of Client's instructions, if any. The Company's sole responsibility is to its Client and this document does not exonerate parties to a transaction from exercising all their rights and obligations under the transaction documents. This document cannot be reproduced except in full, without prior written approval of the Company. Any unauthorized alteration, forgery or falsification of the content or appearance of this document is unlawful and offenders may be prosecuted to the fullest extent of the law. Unless otherwise stated the results shown in this test report refer only to the sample(s) tested and such sample(s) are retained for 30 days only.

Air interface:

Band	Test Mode	Test Ch./Freq.	Probe Position	ABM1 (dBA/m)	ABM2 (dBA/m)	Signal Quality (dB)	T Rating	Freq. Response Variation (dB)	Frequency Response
GSM850	EGPRS 2TS	190/836.6	Axial (Z)	-1.48	-32.36	30.88	T4	1.32	Pass
			Transversal (Y)	-8.94	-39.25	30.31	T4	N/A	/
WCDMA Band V	HSPA	4182/836.4	Axial (Z)	-5.31	-31.22	25.91	T3	1.39	Pass
			Transversal (Y)	-9.52	-39.78	30.26	T4	N/A	/
LTE Band 66	20M QPSK 1RB_0	132322/1745	Axial (Z)	-2.39	-32.30	29.91	T3	0.35	Pass
			Transversal (Y)	-11.24	-40.05	28.81	T3	N/A	/
LTE Band 41 PC3	20M QPSK 50RB_50	40620/2593	Axial (Z)	-2.30	-30.15	27.85	T3	1.43	Pass
			Transversal (Y)	-12.33	-36.88	24.55	T3	N/A	/
WiFi 2.4G	802.11b	6/2437	Axial (Z)	-4.41	-31.90	27.49	T3	1.07	PASS
			Transversal (Y)	-11.97	-39.24	27.27	T3	N/A	/

Remark:

1. Phone Condition: Mute on; Backlight off; Max Volume
2. The detail frequency response results please refer to appendix A.

Test Engineer: Vito Wang, Claire Shen



Unless otherwise agreed in writing, this document is issued by the Company subject to its General Conditions of Service printed overleaf, available on request or accessible at <http://www.sgs.com/en/Terms-and-Conditions.aspx> and, for electronic format documents, subject to Terms and Conditions for Electronic Documents at <http://www.sgs.com/en/Terms-and-Conditions/Terms-e-Documents.aspx>. Attention is drawn to the limitation of liability, indemnification and jurisdiction issues defined therein. Any holder of this document is advised that information contained hereon reflects the Company's findings at the time of its intervention only and within the limits of Client's instructions, if any. The Company's sole responsibility is to its Client and this document does not exonerate parties to a transaction from exercising all their rights and obligations under the transaction documents. This document cannot be reproduced except in full, without prior written approval of the Company. Any unauthorized alteration, forgery or falsification of the content or appearance of this document is unlawful and offenders may be prosecuted to the fullest extent of the law. Unless otherwise stated the results shown in this test report refer only to the sample(s) tested and such sample(s) are retained for 30 days only.

Attention: To check the authenticity of testing /inspection report & certificate, please contact us at telephone: (86-755) 8307 1443, or email: CN.Doccheck@sgs.com
No.1 Workshop, M-10, Middle Section, Science & Technology Park, Shenzhen, China 518057 t (86-755) 26012053 f (86-755) 26710594 www.sgs.com.cn
中国·深圳·科技园中区M-10栋一号厂房 邮编: 518057 t (86-755) 26012053 f (86-755) 26710594 sgs.china@sgs.com

8 Equipment list

Equipment	Manufacturer	Model	Serial Number	Calibration Date	Due date of calibration
<input checked="" type="checkbox"/> Software	SPEAG	DASY52 52.10.4	NA	NCR	NCR
<input checked="" type="checkbox"/> DAE	SPEAG	DAE4	1445	2020-10-08	2021-10-07
<input checked="" type="checkbox"/> Audio Magnetic 1D Field Probe	SPEAG	AM1DV3	3115	2021-06-01	2022-05-31
<input checked="" type="checkbox"/> Test Arch SD HAC	SPEAG	NA	NA	NCR	NCR
<input checked="" type="checkbox"/> Audio Magnetic Measuring Instrument	SPEAG	AMMI	1028	NCR	NCR
<input checked="" type="checkbox"/> Audio Magnetic	SPEAG	AMCC	1143	N/A	N/A
<input checked="" type="checkbox"/> Universal Radio Communication Tester	R&S	CMW500	111637	2021-04-14	2022-04-13
<input checked="" type="checkbox"/> Humidity and Temperature Indicator	KIMTOKA	KIMTOKA	NA	2021-04-15	2022-04-14

Note:

1. All the equipments are within the valid period when the tests are performed.
2. NCR: "No-Calibration Required".

9 Calibration certificate

Please see the Appendix B

10 Photographs

Please see the Appendix C

Appendix A: Detailed Test Results

Appendix B: Calibration certificate

Appendix C: Photographs

---END---



Unless otherwise agreed in writing, this document is issued by the Company subject to its General Conditions of Service printed overleaf, available on request or accessible at <http://www.sgs.com/en/Terms-and-Conditions.aspx> and, for electronic format documents, subject to Terms and Conditions for Electronic Documents at <http://www.sgs.com/en/Terms-and-Conditions/Terms-e-Documents.aspx>. Attention is drawn to the limitation of liability, indemnification and jurisdiction issues defined therein. Any holder of this document is advised that information contained hereon reflects the Company's findings at the time of its intervention only and within the limits of Client's instructions, if any. The Company's sole responsibility is to its Client and this document does not exonerate parties to a transaction from exercising all their rights and obligations under the transaction documents. This document cannot be reproduced except in full, without prior written approval of the Company. Any unauthorized alteration, forgery or falsification of the content or appearance of this document is unlawful and offenders may be prosecuted to the fullest extent of the law. Unless otherwise stated the results shown in this test report refer only to the sample(s) tested and such sample(s) are retained for 30 days only.